

# Troubled Times

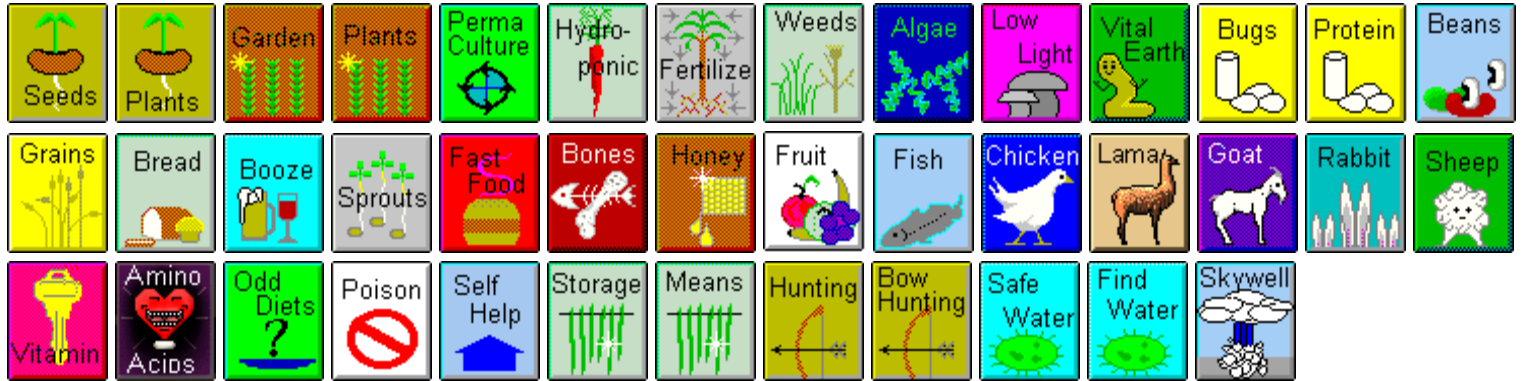

## Food



Click on the icons above to go to your area of interest.



# Troubled Times

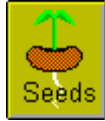

## TOPIC: Seeds

---

[Preserve](#) the germinating capacity of seed. Humidity and temperature are [Factors](#), as [Pocket](#) advice shows. Pollination can be by [Self Pollination](#) or [Cross Pollination](#), and [Unwanted Crossing](#) can be prevented by [Isolation](#), [Alternate Planting](#), [Caging](#), or [Hand Pollinating](#) the [Flowers](#). Culling, or [Roguing](#) eliminates poor genetics. Seeds often need a [Resting](#) period before they will germinate, and some biennial root plants such as the [Potatoe](#) can also be propagated by [Cuttings](#). [Harvesting](#) is best done when the seed is [Ripe](#) or [Dry](#), and some need more [Time on the Vine](#). [Tips](#) on saving seed, reducing [Diseases](#), and a [Starting Mix](#) are available. [Hybrid](#) seed is not likely to produce viable seed and is [Genetically Altered](#) to prevent reproduction by [Mega Merger](#) companies seeking high profits, a trend temporarily [Halted](#). Seed for sustainable gardens needs to be from the old, reproducible strains, with the [Parent Plant](#) selected from the best. The [Arc Institute](#) offers survival seeds and Geri explains how to [Save Seed](#), and how the [Terminator Gene](#) in hybrid seeds is a threat. [Nitro Pak](#), [Seeds Blum](#), [J.L. Hudson](#), [I Can Garden](#), [Ready Reserve](#), [Denali Seed](#), and [Seeds of Change](#) offer non-hybrid seeds, as do many other [Sources](#). A Troubled Time [TEAM](#) has been formed to grow and pass along non-hybrid seed. For beginners, there is advice on [Saving Seed](#), [Pollinating](#), [Types of Seed](#), [Harvesting Seeds](#), [Storing Seed](#), [Testing Seeds](#).

# Troubled Times



## TOPIC: Plants

---

[Biennial](#) plants, such as [Asparagus](#) and most of the [Cabbage](#) family, need to winter over. [Potatoes](#) can be grown from tubers or from seed, unlike other [Root Vegetables](#) such as [Radishes](#), [Beets](#), [Carrots](#), and [Onions](#). [Tomato](#) seed should be fermented. [Beans](#), [Eggplant](#), [Lettuce](#), [Okra](#), [Melons](#), and [Peppers](#), self pollinate and are easy to grow. [Corn](#), [Peas](#), [Sunflowers](#), [Spinach](#), and the [Cucurbits](#) family cross pollinate and need to be watched. [Wheat](#) is sown and then [Threshed](#). Many fruit trees such as [Guava](#) can be grown from the fruit pit.

# Troubled Times



## TOPIC: Gardening

---

Plant varieties that are [Native Varieties](#) or [Optimal](#) will bring the most success. [Organic Gardening](#) or [Organic Farming](#). [Square Foot](#) gardening, [Do-Nothing](#) gardening, [Irrigation](#), [Composting](#), [Continuous](#) gardening, attention to [Soil pH](#) and [Temperature](#) and use of [Color](#) can maximize yields. Gardening the [Indian Way](#) prevents erosion. [Raised Beds](#) take up [Less Space](#) and give [Increased Yields](#), and [Mini-Farms](#) offers [Classes](#). [Plowing](#) supports [Mass Production](#), but without horsepower may need to be human powered as a [Bike Plow](#), a [Spool Plow](#), or an [Axle Plow](#). [No Plowing](#) is an option, with [Mulched Seeding](#) or [Mud Seeding](#). Ultimately, [1 Feeds 6](#), and required [Acreage](#) can be calculated. Successful gardens can be grown even in [Temperate Climates](#) such as [Colorado](#) and there are [Cold-Tolerant](#) fruit trees and shrubs available, or from a family [Grain Plot](#) or a [City Plot](#). There are many [Pros & Cons](#) to indoor or [Sheltered](#) gardening, perhaps under a [Dome](#), or in a [Bermed](#) greenhouse. [Mulching](#) creates a sustainable garden, and [Poor Soil](#) can be improved. Where bees cannot be relied upon, [Pollination](#) can be given an assist. Hand powered [Seeders](#) are available. [Garden Covers](#) can shelter or create a [Hot House](#) effect, and [Cover Crops](#) hold the soil. [Solar Cones](#) maximize sunlight. Mail order [Catalogs](#) for gardening supplies are handy. Pests such as [Slugs](#) can be controlled. Natural pest controls exist, such as [Pyrethrin Daisies](#). Tubers to be planted the following year are stored in a [Root Cellar](#). A Troubled Times [TEAM](#) is experimenting with these techniques.

# Troubled Times

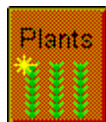

## TOPIC: Garden Plants

---

[Amaranth](#) has high nutritional value, and the leaves as well as grain can be eaten. Staples such as [Oil and Sugar](#) from [Sugar Beets](#), [Potatoes](#), or [Peanuts](#) can be grown. [Stevia](#) is a sweetener, and [Beets](#) have many uses. [Cassava](#) is widely and readily grown but has [Cyanide](#) cautions. Consider non-traditional plants such as [Sun Root Tubers](#), or the [Quandong](#) from Australia, or [Pine](#). Perennials such as [Asparagus](#) produce for decades. [Wild Rice](#) flourishes in wetlands. [Garlic](#) and [Pineapple](#) and other plants can be grown from [Off-the-Shelf](#) food. [Fig Trees](#) can be grown in temperate climates. Certain plants [Complement](#) each other, such as [Corn/Beans](#), and others have an [Adverse Effect](#).

# Troubled Times



## TOPIC: Permaculture

---

Agriculture is most efficient when the byproducts of one culture are [Recycled](#) into another culture, an [Ecological](#) process called [Permaculture](#). The permaculture [Concept](#) makes for sustainable living in enclosed biospheres, and is a process with many [Resources](#) and a fan club providing a [Message Board](#), and in [Britain](#). An excellent book, called *Permaculture, A Designer's Manual*, by Bill Mollinson is highly recommended by Troubled Times. Another member who is a Certified Permaculture [Design Consultant](#) explains the process for [Home Design](#), [Heat & Light](#), and recycling [Water](#) and [Organic Matter](#). The [Growworld Module Project](#) explains how permaculture techniques developed in Russia can support indoor gardening.

# Troubled Times



## TOPIC: Hydroponics

---

Produce grown while suspended in recycled, [Nutrient](#) rich water in an indoor agriculture method that supplies [Large Quantities](#) of fresh, insect free [Produce](#) such as [Lettuce](#) year round. Some crops are [Continuous](#), but in all cases [Yields](#) are higher than soil based gardens. Where [Grass](#) for animals can be grown, this is not an [Efficient](#) production of food. [Hydroponic](#) agriculture is not difficult, [Simple Systems](#) such as an [Ebb & Flow](#) can be constructed, and growing [Your Own](#) can be done in the home or [Quonset Hut](#). A [Home-Made](#) nutrient solution can be produced from composting worm beds, and the pH balanced with [Wood Ash](#). [Volcanic Ash](#) will provide nutrients. [Indoor Pollination](#) and [Stressing](#) the plants may need an assist to increase the yield and/or produce seed. Hydroponics or [Aeroponics](#) is the garden of choice for the planned [Space Station](#). A Troubled Times [TEAM](#) is developing skills in hydroponics. Maintaining the right [pH Balance](#) of the water is important, and a [Growing Guide](#) can help. Complete assistance in [Setting Up](#) a hydroponic system, including education, training, [Supplies](#), and reference materials can be secured from several sources:

- [Cropping](#) and [E-Zine](#)
- [Global Hydroponics](#)
- [Simply Hydro](#)

# Troubled Times



## TOPIC: Fertilizer

---

Many farmlands are [Depleted](#), are without [Trace Minerals](#), so gather soil for a survival site that is [Not Farmland](#) soil. [Woods Soil](#) or river bank soil is best, and perform a [Soil Test](#). There are some [Essential](#) ingredients, and plant [Deficiencies](#) are identifiable. [Volcanic Dust](#) fallout may deplete soils further, as [Acid Rain](#) does. When commercial [Fertilizer](#) such as [Azomite](#) is no longer available, soil can be replenished from many sources such as [Blood and Bone](#) meal, [Ashes](#), [Sawdust](#), [Ground Rock](#), [Compost](#), [Kelp or Seaweed](#) for those near coastlines, or such practices as [Crop Rotation](#) or [Recycling](#) waste. There are many [Organic Sources](#) of fertilizer. A [Home Made](#) rock crusher can be constructed. [Manure](#), a [Composting Toilet](#) using [Human Manure](#), [Urine](#), and using [Gray Water](#) fertilize. There are [Concerns](#) and [Parasite](#) considerations, and [Reassurances](#).



# Troubled Times



## TOPIC: Weeds

---

Since many people will not be able to grow hydroponic plants due to either lack of equipment or know how after the pole shift, the best alternative solution is [Foraging](#) or to set up some form of [Weed Farm](#). The entire [Dandelion Plant](#) is edible, with [Recipes](#) and [Cooking Tips](#). [Bamboo](#) is edible and there are [Harvesting](#) and [Growing](#) tips. [Cattails](#), many [Lichen](#), [Seaweed](#), [Chicory](#), [Sorrel](#), Burdock, Mulberry, weeds for [Salads](#) and [Many Others](#) are edible. [Grasses](#) should grow well in the Aftertime climate. Weeds such as [Lemon Grass](#) are a great addition to the herb garden. Canadian native [Sweetgrass](#) is a survivor. The [Prickly Pear](#) cactus has [Many Benefits](#) beyond being an excellent food source. Traditional [Flowers](#) also are often edible. When selecting unfamiliar weeds from the wild, an [Edibility Test](#) should be done to ensure they are not [Poisonous Plants](#), but the [Poke Plant](#) can be eaten. Weeds are also a rich source of vitamins such as Vitamin C from [Dandelion](#) or [Scurvy Grass](#), which is a common grass in Scotland. A Belgium friend is growing edible shrubs and has a [Database](#) listing them, and many information [Sources](#) exist. [Kudzu](#) is [Edible](#), but there are serious [Cautions](#) in its use, though some Troubled Times members feel they could [Control and Use](#) Kudzu.

# Troubled Times



## TOPIC: Algae

---

A primitive plant that should be considered a [Primary Source](#) of food, algae is an excellent [Food Source](#), can be [Fully Utilized](#), is an efficient [Nutrient Producer](#) and can be grown in the [Aftertime](#). As the [Spirulina](#) company explains, the [Spirulina Algae](#) gives an [Immunity Boost](#) and [Reduces Allergies](#). Many [Articles & Books](#) have been written, in many languages, about how to grow and eat spirulina. Additional fresh water algae are [Chlorella](#) and the [Super Blue Green](#) variety grown at [Cel Tech](#) and the [Klamath Lake](#) variety grown commercially in oregon. Salt water algae are called [Sea Vegetables](#). Algae in Haiwaii is called Limu, and there are many [Edible Limu](#) prepared and eaten in Haiwaii. Algae grows happily in water polluted with the runoff from plant nutrients or sewage effluent, but [Contamination](#) of the harvest should be guarded against. [Dried Algae](#) may not contain [Live Algae](#) to seed your own [Indoor Pond](#), which must address [Lighting](#) and [pH Balance](#) concerns for those who want to [Grow My Own](#). A recent addition of algae that can grow [Without Sunlight](#) holds hope.

# Troubled Times



## TOPIC: **Low Light**

---

Many plants such as [Sugarroot](#) and many [Weeds](#) and some animals grow well in [Dim Light](#), and for those without hydroponic facilities under [Artificial](#) lights these might prove to be the only [Source of Food](#) during the years following the pole shift when the air is so filled with volcanic dust that there is little sunlight. [Moles](#) feed on worms and insects which grow without light. Low light [Crops](#) such as [Mushrooms](#) and fish that live in caves might be worth pursuing as a food source. There are [Fungi Cautions](#) but poisonous varieties can be [Distinguished](#). Mushrooms can be grown in [Dead Wood](#) and [Propagation](#) is easy. Information on mushrooms can be secured from many [Books](#) and other sources, and a Troubled Times [TEAM](#) has been formed to share information on [Growing](#) them.

- [Fungi](#)
- [The Farm](#)
- [Fungi Perfecti](#)

# Troubled Times



## TOPIC: Vital Earth

---

Earthworms are an excellent source of protein, reportedly 82% protein. As noted in a recent [Comic Strip](#) by Judd Winick, for many this might require an attitude adjustment. Worms have always been only one step away in the human [Food Chain](#) via birds and fish and in the case of Australian Aborigines, New Zealand Maoris, and some areas of China they are a direct food source. The essential oil of Earthworms is Omega 3. Earthworms can be given a [Water Purge](#), but [Cleaning](#) and [Rinsing](#) are necessary. Earthworm [Powder](#) can be a handy food additive, and many [Recipes](#) exist for the cleansed meat. Earthworms are [Easy to Grow](#), per [Mother Earth](#) articles, and don't suffer from fungus, bacterial, or viral infections. They [Multiply Rapidly](#), are [Efficient](#), but production is assisted by proper [Feeding](#), and [Harvesting](#) techniques, and [Tips](#). Growing earthworms and [Composting](#) for soil are synergistic, but avoid the [High Heat](#) that a compost pile can generate. Earthworms can be called up by a process known as [Grunting](#). [Vital Earth](#) provides and delivers a complete system that includes

- a growing system
- a safe long-distance delivery system
- an end use application system for organic fertilizer production

# Troubled Times



## TOPIC: **Bugs**

---

Often a staple and frequently a delicacy, high protein worms or insects and their larva are part of the [Human Diet](#). [Testimonials](#) from Troubled Times members and [Third World](#) countries exist. [The Facts](#) about raising or [Catching](#) and using [Bugs as Food](#) and a [Newsletter](#) are available for those wanting to be enlightened. [Frugal's](#) home page and the Paleolithic diet insect recipes all attest to the edibility of insects. [Mealworms](#), [Grasshoppers](#), [Crickets](#), [Termites](#), [Ants](#), [Maggots](#), and [Grubs](#) can be eaten. [Cooking](#) advice and recipes are available from [Iowa State](#) - do cook to avoid [Parasites](#), and take [Precautions](#) when cleaning. [Techniques](#) for [Raising Insects](#) exist, and advice on how to raise earthworms is available, from [Vital Earth](#). Earthworms are high in protein and can be eaten after a simple [Water Purge](#).

# Troubled Times



## TOPIC: Protein

---

Reptiles such as [Snakes](#) and [Frog Legs](#) are considered a food source, and all joking aside taste a bit like chicken. [Frog Info](#) and sources exist. [Rats](#) and [Snails](#) are also tasty. A dead [Carcass](#) may or may not be edible. A vegetable protein source without peer is the venerable [Soybean](#), as the [SoyFoods Org](#) will attest, but the adaptable [Amaranth](#) plant seed and [Buckwheat](#) grain are high in protein too.

# Troubled Times



## TOPIC: Beans and Legumes

---

A staple throughout the world and high in protein, beans and legumes come in many varieties including [Black Beans](#), [Black-eyed Peas](#), [Chickpea](#), [Kidney Beans](#), [Lentils](#), [Lima Beans](#), [Peanuts](#), and [Pinto Beans](#).

# Troubled Times

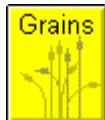

## TOPIC: Grains

---

Familiar grains such as [Oats](#), [Barley](#), [Wheat](#), [Buckwheat](#), [Rye](#), and [Corn](#) differ in their growing seasons, climate and moisture requirements, resistance to [Fungus](#), ease in [Milling](#), [Gluten](#) content for making bread, and nutrient content. [Buckwheat](#) has high protein, is [Easy to Grow](#), and [Suppresses Weeds](#). Less familiar grains are [Millet](#), [Sorghum](#), [Triticale](#), [Kamut](#), and [Spelt](#). Also considered grains are [Amaranth](#) which provides greens as well as grain and is a relative of the Cockscomb, [Quinoa](#), a relative of the common weed called Lambsquarter, and [Flax](#), also a source of linen cloth. [Rice](#), which requires wet conditions, is a food staple throughout the world. The average [Per Capita](#) rate of flour consumption and [Harvest/Acre](#) should be taken into consideration. A Troubled Times [TEAM](#) has been formed to gain experience in growing grains.



# Troubled Times



## TOPIC: Breads

---

The ingredient which causes breads to rise is [Yeast](#), a living organism mixed into the dough prior to baking. Yeast is the same organism that produces [Alcohol](#) from various mashes. But as leavening agents abound naturally, bread can be made [Without Yeast](#), such as with [Essene Bread](#) or by a [Raisin Starter](#). Flour is made by [Grinding Grain](#). Bread can be made from non-grain sources too, such as [Potato Bread](#).

# Troubled Times



## TOPIC: Booze

---

A cup of cheer, such as a glass of home made [Beer](#) or [Dandelion Wine](#), will be very much needed in the Aftertime and can be easily [Brewed](#). To make alcohol to create [Herbal Tinctures](#) or fuel requires a [Mash](#), a [Still](#), a [Water Source](#), and with all these in hand, [Distilling](#) comes next. [Variations](#) on this process exist. There are home brew [Dangers](#) if this distilled alcohol is consumed, but this high proof alcohol can be used as high octane [Fuel](#).

# Troubled Times

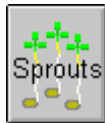

## TOPIC: Sprouts

---

Sprouts spring up quickly from [Many Types](#) of seed, and are packed with vitamins. During the first few weeks and months of the Aftertime, they can be a welcome [Addition](#) to the canned and dried foods that many survivors will be relying upon. Supplies and information on how to grow sprouts is available from many [Sprout Sources](#). Large volumes of seeds can be [Purchased](#) and [Easily Stored](#), and *no* light is required to sprout the seeds. All that is needed to [Sprout Seeds](#) is moisture and warmth and an environment free of diseases such as mold or [E. coli](#) or [Salmonella](#).

# Troubled Times



## TOPIC: Fast Food

---

Meals [Ready to Eat](#), a military staple sometimes in [Short Supply](#), will help during those first few days of the Aftertime when all is in chaos. [My Own Meals](#) is a similar item, stored at room temperature. Other sources are [Pre-Assembled](#) food supplies and [Dried Food](#). A [Hot Pot](#) to keep hot water handy will help too, and cans can be opened without a [Can Opener](#). For those truly on the run, [Food Tabs](#) or [Ensure](#) can provide temporary nutrition.

# Troubled Times



## TOPIC: **Bones**

---

Bones are an excellent calcium source, and the nutritious marrow can be extracted when bones are boiled in soups. Bones are [Softened by Heat](#), so that they become edible. After slaughter, [Leftover Parts](#) can be utilized, and the [Marrow](#) beneficial.

# Troubled Times



## TOPIC: **Honey and Bee Keeping**

---

Honey is produced by bees as they go about their business, and fruits and vegetables require pollination for an optimum harvest. Honey contains a surprising number of [Nutrients](#) and [Healing Properties](#). [Bee Keeping](#) is an established industry, and [Indoor](#) beekeeping is possible. Helping your bees [Survive the Shift](#) and [Transporting](#) them is likewise possible. [Honey](#) can be purchased or [Stored](#) in many different forms, but there are [Honey Cautions](#) as raw honey should never be fed to infants.

# Troubled Times



## TOPIC: **Fruit**

---

Many [Tropical](#) fruits are hardy, and the [Mango](#) readily grown. [Grape Mildew](#) can be controlled by worm castings, and grapes can be [Stored Fresh](#) for many months. The [Tannic Acid](#) in blueberries and cranberries reduces urinary infections. [Dried Fruits](#) have a long shelf life, and there are drying [Tips](#), and [Manual Juicers](#) are available.

# Troubled Times

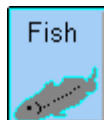

## TOPIC: Fish Farms

---

[Aquaculture](#) produces prodigious amounts of high protein food. Many [Information](#) sources exist on [CD-ROM](#), via [BBS](#) or [ftp/Gopher](#), or on [List Serves](#). For the [Beginner](#), and [Practical Advice](#) exists, and [Aquariums](#) are good practice. Salmon, [Perch](#), [Catfish](#), [Carp](#), [Tilapia](#), shrimp and [Crayfish](#) are successfully being farmed today in established aquafarms. Hydro/Technologies explains the various [Methods](#) of aquaculture, the [Symbiotic](#) interaction between plants and fish, and the [Equipment](#) needed. [Acquaponics](#) is the synergy of aquaculture and [Hydroponics](#), but there are [Issues](#). [Barrel-Ponics](#) is a small space solution. Fish ponds should be [Temperature](#) controlled, but catfish can [Winter Over](#) and a [Paddle Wheel](#) can help. Swimming [Pools](#) can be used as ponds. In calculating the [Yield](#), one must consider the [Food Chain](#). Fish may need to be protected from [Shock](#) during the pole shift. A natural food source for fish in ponds or tanks is algae grown from sewage effluent. [Marsh Areas](#) areas to cleanse sewage effluent are odor free and serve as wildlife refuges and recreation areas. [Water Lillys](#) are effective in this regard. Fish do not accumulate [Lead](#) from polluted water.



# Troubled Times



## TOPIC: Chickens

---

Chickens raised for meat and [Eggs](#) can be used in a [Synergistic](#) fashion with indoor gardens. Their waste is an excellent fertilizer, but chickens have [Multiple Uses](#). There are few health [Cautions](#). The presence of [Roosters](#) in the flock results in [Fertile Eggs](#), not fewer eggs. [Guinea Hens](#) eat insects in the garden, and [Arucanas](#) produce eggs quickly. [Free Range](#) chickens find their own feed. [Egg Shells](#) can be fed back to chickens for the calcium. [Housing](#) chickens is also easy, and they have a productive [Long Life](#).

# Troubled Times



## TOPIC: **Lamas**

---

A source of wool, meat, and dairy products, and a hardy animal that deals with deprivation well, [Lamas](#) and their cousins the Alpaca provide [Many Benefits](#). They are kept as [Domesticated](#) herd animals by many, and *not* just in their native lands in South America. Growers who are [Sources](#) of Lamas or Alpacas can be located in the US and Europe. Many [Web Resources](#) exists on lamas.

# Troubled Times



## TOPIC: Goats

---

Goat herds are kept for the milk and cheese they produce in many lands. [Goats](#) are hardy and eat almost anything, and bond to their herdmens so that they stay close to home and follow their shepherd when [On the Move](#). They [Fertilize](#) gardens too, as organic gardeners have discovered. Many [Web Resources](#) exist on the subject.

# Troubled Times



## TOPIC: Rabbits

---

Prolific rabbits are famous for their reproduction rate, so as a source of meat for rabbit stew, a rabbit herd can provide this [Protein](#) supplement often. [Rabbits](#) munch on vegetation left over from gardens, eating the fibrous parts and recycling this bulky trash quickly into droppings for the humus pile. [Wild Rabbits](#) can be lean and scrawny, however, providing little nutrition, and can be infected with [Liverfluke](#) or other [Diseases](#).

# Troubled Times



## TOPIC: Sheep

---

[Sheep](#) provide meat and wool, graze of sparse grasslands, and are hardy during cold weather, as [Oklahoma State](#) attests.

# Troubled Times



## TOPIC: **Vitamins**

---

The first few years following a Pole Shift find the [Sunlight Dim](#) and vegetation struggling to grow. Drinking orange juice for the Vitamin C and fortified milk for the [Vitamin D](#) and [Calcium](#) will no longer be the answer, and [Manufacturing](#) vitamins is difficult, so we will need to [Be Practical](#). Many [Wild Edibles](#) contain vitamins such as A and C. Sources for [Vitamin C](#) are [Pine](#), [Rose Hips](#), [Blood](#), [Sorrel](#), [Water Cress](#), and various [Veggies](#). Vitamin [Deficiencies](#) may develop if the right [Balance](#) of foods is not consumed. Fortunately, all the [Food Sources](#) needed for vital health can be grown or harvested. By learning to [Eat Smart](#), in the right combinations, the nutrition potential from foods can be maximized. Milk is [Not Necessary](#) for strong bones and teeth, and can even [Cause Problems](#). Information on [Vitamins](#) and [Minerals](#) such as [Zinc](#) or [Potassium](#) is widely available, and [Trace Minerals](#) are important too, and [MSM](#) can give a boost. As vitamins have a long [Shelf Life](#), they should be stocked.

# Troubled Times

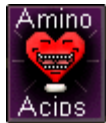

## TOPIC: Amino Acids

---

Amino Acids are essential to life, and without them we cannot [Maintain Life](#). The known amino acids are categorized into those [Essential](#) for life, required as [Extra for Children](#) during their growth, [Non-Essential](#), and [Non-Protein](#) amino acids that are not involved in protein synthesis.

# Troubled Times



## TOPIC: Odd Diets

---

From the dairy diet of the [Mongols](#) to the sparse diets in the [Himalayan](#) valleys, humans can live and live well on some odd diets indeed! [Glacial Milk](#) combined with lean meals gives some mountain cultures great longevity. Separating food types, for [Meat Only](#) meals, improves digestion. Eating [Raw Food](#) gives an [Enzyme Boost](#), and the [Eskimo](#) lives well. [Pine Bark](#) is edible. Eating [Earthworms](#) requires mental adjustment only. Fasting to cleanse the body or using [Detox Diets](#).



# Troubled Times



## TOPIC: Poisons

---

Many foods are known to have a toxic element to them, including rhubarb, [Raw Beans](#) or [Phytohaemagglutinin](#) poisoning, and [Green Potatoes](#). [Toad Skins](#) can be poisonous, and [Honey](#) produced from *Rhododendrons*. Wheat can be affected by Karnal Bunt or [Aflatoxins](#) poisoning. Refined [Canola Oil](#) is reputed to cause problems. [Histamine](#) poisoning can occur from food. Poisonous [Mushrooms](#) are a well known threat. A list of [Toxic](#) and [Non-Toxic](#) plants can be a guide. Poisonous sea algae causing [Red Tide](#) are a form of [Ciguatera](#) algae. [Mussels](#) or other [Shellfish](#) or [Pufferfish](#) can be fatal.

# Troubled Times



## TOPIC: Self Help

---

Empowering others to help themselves is the best help of all. Some successful projects are teaching [Inner City](#) youngsters how to feed themselves.

# Troubled Times

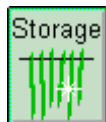

## TOPIC: Storage

---

The [Basics](#) of [Food Storage](#) apply when freezing or canning food are not an option due to lack of equipment or power, but there are [Pros and Cons](#) to these techniques. Time honored [Smoking](#) or [Drying Techniques](#) such as the [Foxfire Tips](#) or [Backwoods](#) tips can keep crops from spoiling, and [Jerky](#), or [Biltong](#) as it's sometimes called, lasts for years. A [Make Shift](#) dehydrator, such as one placed above a [Light Bulb](#), can be devised. Grains need to be [Winnowed Clean](#) prior to storage. Various cooking staples such as [Vinegar](#), [Herbs and Spices](#), [Salt](#), [Fats and Oils](#), [Sugars](#), [Liquid Sugars](#), and [Leavening Agents](#) have storage considerations, as do [Milk Products](#). Powdered [Infant Formula](#) lasts longer than canned formula. [Molds in Food](#) can develop but we can [Minimize Molds](#) or [Prevent Molds](#), and there are techniques for dealing with [Molds in Canned Goods](#) and [Mold in Grains](#) and legumes. [Botulism](#) and [Bacterial Spoilage](#) can also develop. [Dehydrated](#) foods can be purchased, but when [Buying Bulk](#) shop carefully. [Hard Tack](#) and such atypical foods as [Dog Food](#) or [Pigeon Food](#) are options.

# Troubled Times

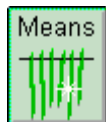

## TOPIC: Means

---

[Vacuum Sealing](#), packing in [Nitrogen](#), or [Dehydrating](#) foods are options. Using [Diatomaceous Earth](#) such as [Perma Guard](#) helps avoid insects, but there are [Aluminum](#) and [Fluoride](#) concerns. [Infestations](#) are not necessarily spoilage. Foods that [Store Well](#) and can be stocked ahead of time in [Buckets](#) or [Cans](#), but avoid [Plastic Containers](#) and [Plastic Jugs](#). [Reserves](#) will be needed. Stashing in [Concrete Culverts](#) should avoid [Liquefaction](#) problems. A dedicated Troubled Times member explains [How To](#) store grain and beans. Before the advent of refrigerators, food was chilled in ice boxes replenished from [Ice Houses](#) stocked during the winter months. Why a [Foil Coil](#) can preserves food is explained by a [Theory](#) proposed by [Lakhovsky](#), which [Books & Articles](#) detail. [Canned](#) foods have [Date Codes](#) such as [Best By](#), which don't necessarily reflect the life of the product.

# Troubled Times



## TOPIC: **Hunting**

---

Hunting skills, particularly during a long cold [Winter](#), may be necessary and improve with [Practice](#). Fishing can be done with a [Fish Net](#), a [Fish Trap](#), a [Boat](#), [Hook & Line](#), and [Bait](#). [Fish Hooks](#) can be made from bone. Even [Carp](#) can be made edible. [Crayfish](#) can be caught by [Trawling](#). Hunting can be done with [Guns](#) such as a [Pellet Rifle](#), bow and arrow, or by one's hands and wit. [Replacement](#) and repair should be considered. [Birds](#) are good to eat, and [Doping Birds](#) with alcohol is one such technique. Hunting or trapping wild [Rabbit](#) or [Turkey](#) is possible. The likely [Prey](#) can be calculated, with decreasing [Deer](#) and increasing [Bears](#). The right [Mindset](#) also helps. The sling can be used even by children, and Usenet Archives describe [Throwing](#) techniques, [Ammo](#), [Construction](#) techniques, the [Results](#), merits of [Sling vs Bow](#), variants such as the [Staff Sling](#), and information [Resources](#). Diseases in wildlife, such as [Wasting Disease](#) in deer and elk, should be avoided.

# Troubled Times



## TOPIC: Bow Hunting

---

[Traditional](#) bows have been used in hunting around the world and throughout history. A glossary of [Terms](#) helps. [Bow](#) construction requires [Materials](#), where [Wood Grain](#) and [Wood Type](#) as [Bow Back](#) considerations matter, as do [Dimensions](#). The [Flatbow](#) and [Longbow](#) or English [Longbow](#) both use [Tillering](#), a [Tiller Stick](#), [Nocks](#), [Straightening](#), and [Recurving](#). A [Quickie Bow](#) can also be used in a pinch. The [Crossbow](#) requires [Assembling](#) and a [Release](#) mechanism. The [Amtguard](#) crossbow is inexpensive, and durable [Non-Wood](#) types exist. The [Compound Bow](#) can be made from [Wood](#) or [Composite](#) materials, with a [Steel Arm](#) or using a [Steel Pipe](#). [Bowstrings](#) can be [Spun](#) or be made from [Rawhide](#) or [Cord](#) with [Many Ply](#) for [Strength](#), or can use a [Felmish Twist](#) with [2 or 3 Ply](#), or an [Endless String](#) with [Serving](#) wrap technique. A [Heat Shrink](#) extends the life of strings. [Arrows](#) have [Components](#) such as [Arrowheads](#) and their [Construction](#) involves [Blade Design](#) and securing the [Broadhead](#).

# Troubled Times



## TOPIC: Safe Water

Surface water should be [Treated](#) by boiling it to rid it of germs and parasites and some [Pollutants](#). [Waterborne Diseases](#) can be deadly, and [Emergencies](#) can occur suddenly. A [Filter](#) such as [Katadyn](#), [AquaPure](#), [PUR Plus](#), [Brittas](#), [Amway](#), or [PentaPure](#), or a [Pre-Filter](#) or [Lead Trap](#) can help, along with a [Systematic](#) approach to the problem. Reportedly, a [Home-Made](#) filter can be constructed. [Ultraviolet](#) as in [Sunlight](#), [Ozone](#), [Oxygen](#), and [Electricity](#) also kills germs. An battery operated UV light such as [SteriPEN](#) can be constructed. [Chlorine](#) has its pros and [Cons](#), but [Standing](#) removes it. [Wine Treated](#) water from [Wooden Barrels](#) kills bacteria. [Containers](#) for [Storing Water](#), perhaps in [Bulk](#), can leach. [Hard Plastic](#) and metal are best, though [Soft Plastic](#) reportedly works, but [Copper](#) can cause problems. [Reverse Osmosis](#) purifies water. Drinking [Salt Water](#) such as seawater can be extremely dangerous, as are other [Bad Options](#), but [Urine](#) is potable. A [Water Cone](#) uses the heat from the Sun to distill water. Water polluted with [Volcanic Ash](#) or [Forest Fire](#) ash or [DOE Dump Sites](#) can be dangerous, so [Distilling](#) drinking water is advised. Distillation also removes [Arsenic](#) and [Lead](#) from ground water. A [Distillation Process](#) is a [Simple Process](#) involving [Making Steam](#). Methods include an [Open Teapot](#) and [Close Teapot](#) and [Coil Exchange](#) and [Full Exchange](#) to reduce [HydroCarbon](#). Another method is a [Pressure Cooker](#) with [Parts List](#) and [Bucket Collection](#), with [Steam Cautions](#). Non-steam methods like an [Umbrella Tent](#) or [Cotton Cloth](#) are also effective. Best method is the [Stacked Pot](#) with [Two Pots](#) and a [Pie Pan](#) with optional [Small Parts](#) and [Simple Assembly](#). This method can be purchased from [Sustainable Village](#), already assembled. [Water Quality](#) can also be tested. All [Myths](#) debunked, distillation can have a [Vacuum Assist](#) and use multiple [Heat Sources](#). A [Solar Distiller](#) uses heat from sunlight. One can allow low [Boiling Point](#) pollutants such as [Hydrocarbons](#) to escape. Commercial [Distillers](#) are available, including [Separators](#). Even the [Ancients](#) had distillers, and [Seawater](#) can be distilled using only the heat of the day. Energy efficient methods for purifying [Brackish Water](#) are available, with detailed instruction on a [PDF File](#). A misc.survivalism [ftp](#) covers the issues but presumes a short term crisis.

# Troubled Times



## TOPIC: Find Water

---

Drinking water needs are often [Underestimated](#). Ground water, such as [Springs](#), or [Wells](#) such as [DeepRock](#) wells, may be cleaner than surface water, and [Dowsing](#), even with [Coat Hangers](#), can help locate sources. Information on dowsing and groundwater sources are available on the Internet. There are deep well [Limitations](#). [Windmill Wells](#) help assure a steady supply. Water can be [Recycled](#), and conserved when water is [Precious](#). [Where and How](#) to locate water can be found from observing the lay of the land. Places where clean water can be collected easily are called [Water Collectors](#). A [Hill Catch](#) can collect runoff from rains, into various [Rainwater Tanks](#) or a [Homemade Catch](#), and the [Rainwater](#) harvest estimated. A [Fog Harvest](#) collected in [Cloth](#) can be done even in a desert, an [Air Well](#) can be constructed to collect [Dew](#), and a [Tent](#) constructed over a vent. Dirty water can be [Filtered](#), and there are [Old Fashioned](#) methods that work. Some plants, such as [Cactus](#), store water. The new worldwide [Water Atlas](#) can assist in assessments.



# Troubled Times



## TOPIC: Skywell

---

A water distillation method currently under development and in the [Prototype](#) stages, [Skywell](#) Water Systems has a target goal of providing large amounts of 100% pure water at rates as low as 1/2 cents per 1,000 gallons. Methods include condensation and [Synthesis](#).

# Troubled Times

## The Hub

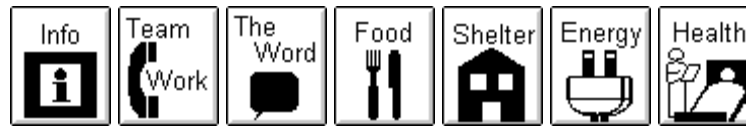

- [Troubled Times](#)
- [Hub](#)
- [Frames](#)
- [Table of Contents](#)
- [Surviving the Shift](#)
- [Homeless](#)
- [Settlement](#)
- [High Tech](#)
- [Science Data](#)
- [Nonprofit](#)

[Troubled Times](#) is icon driven. To explore the contents, just click on the icon above representing your area of interest. Troubled Times content can also be viewed from a [Frames](#) version, or a simple [Table of Contents](#) version.

Troubled Times content is also organized into several views. Surviving the pole shift and Aftertime lifestyles are cumulative views, so that [Surviving the Shift](#) would apply to all, [Homeless](#) would apply to all some time, and [High Tech](#) solutions assume that [Settlement](#) solutions are already in place. [Science Data](#) is a view into those parts of Troubled Times that detail the millennium in scientific terms.

A [Nonprofit](#) arm supports educating the public and developing solution sets and has developed a handy [Booklet](#) toward this end.



# Troubled Times

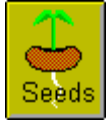

## Preserve

I've read that if seeds are vacuum sealed they can last ten years or longer. I currently have some corn seed not vacuum sealed that are over five years old and they have a high degree of germination. Don't forget to use non-hybrid seeds for planting. Humidity is the biggest enemy in saving seeds, so be sure to seal them well.

Offered by [Mike G.](#)

*Mother Earth News*, Sep/Oct 78

### Storage

After harvesting cleaning and drying your seeds store them in air tight containers such as canning jars or coffee cans with plastic lids. Label each container clearly indicating the variety of vegetable and the date of harvest. Then place your jars or cans of seed in a cool dry place. A good rule of thumb for determining if storage conditions are appropriate is that the sum of temperature (in degrees Fahrenheit) and relative humidity (expressed as a percentage) should not exceed 100. For example seed stored at 45°F should not be exposed to a relative humidity that is greater than 55.

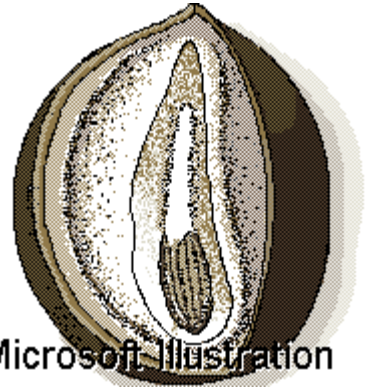

*Mother Earth News*, Vol: 53 Sep/Oct 78

### Testing for Viability

If seeds are properly stored they will remain viable (will grow) for anywhere from one to five years ... depending on the type of vegetable. If you have doubts about whether or not some of your seeds will still sprout check em out before you plant them In the garden. Just roll up a few of each of the batches of seeds that you're unsure of between layers of damp cloth or paper towels. Then stand this simple sprouter on end in a jar with a little water in the bottom. In a few days, examine the seeds to determine what percentage have germinated. If - for example - only 50% have sent out shoots, no problem: Just sow twice as many per row as you would had they all been viable. (If the percentage of germination is too small, of course, you will have to discard the seeds and buy yourself a fresh start in that particular plant.)

*Mother Earth News*, Sep/Oct 1987

### Care and Handling

By Nancy Bubel

My own seed-keeping methods are simple. At season's end, I bundle up all my labeled envelopes and small jars of seed, pack them into an old lard can with a tight-fitting lid and stash them in the cold barn over winter. Then at spring planting time, I follow that final but crucial law of the seed keeper: Always save a portion of your seed, no matter how old it is. Then in case of a crop failure, you can replant. A single plant or two from that reserved seed supply can restart your seed collection. That way you can keep alive the personal strain you've bred to suit your own back-yard garden.



# Troubled Times

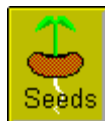

## Factors

---

Seeds need to breathe. Cold storage slows down their metabolism, but they would not survive if unable to breathe. An air tight container in a cool dark basement with plenty of silica gel is perhaps the best solution. Avoid drying out the seeds, but we also need to avoid too much moisture that might cause the seeds to rot or to try to germinate prematurely. Basements or root cellars will cover the requirement of a cool, dark environment, but they are generally high in humidity (usually in the 60 to 75 % range - too high for seed storage). One could use a cabinet to organize the seeds in containers and spread silica gel over the bottom of the drawers to reduce the humidity in the cabinet. Eventually it will be necessary to exchange the silica gel, but it can be dried and reused so this is not a problem. I purchased a 5 pound can at Walmart for under \$10. There is enough silica gel in this can to cover two drawers (roughly 1/4 inch of silica gel). They also sell larger cans.

Offered by [Roger](#).



# Troubled Times

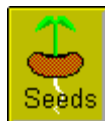

## Pocket

---

Right now I'm reading a book called *Heirloom Vegetable Gardening* by William Weaver (1997), and it offers a tip regarding seed germination. The tip comes from *The Farmer's Own Book* (by H.L. Barnum) from way back in 1836:

*Seed should be carried in the pocket for a week or two before planting.*

The way I see it, body moisture and heat will help catalyze the germination process. For similar reasons, many people suggest soaking seeds in water overnight before planting. Similarly, in a great book I read last week (*Square Foot Gardening* by Mel Bartholomew), the author warns readers to *never* put seed packets in their pocket, at the risk of unwanted germination. So in his own way, Bartholomew backed up what was said back in 1836.

Offered by [Mike](#).



# Troubled Times

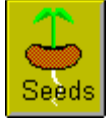

## Self Pollination

---

*Mother Earth News*, Sep/Oct 1987

### **Bring new pleasures and superior plants to your garden**

By Nancy Bubel

Some common self-pollinators are tomatoes, lettuce, peas, snap beans, soybeans, lima beans, endive and escarole. Barley, wheat, oats and cowpeas also self pollinate. Peppers do, too, but they will cross when insects bring in pollen from other kinds of peppers. (If you want to get technical, all self-pollinators can cross with other varieties of the same vegetable in from 0.1% to as much as 5% of the plant populations, but for ordinary back-yard seed saving you don't need to isolate them. I've saved tomato and lettuce seeds for 15 years, and the plants have always come true.)

*Mother Earth News*, Sep/Oct 78

### **Cross Pollination**

The easiest way for the beginning seed grower to avoid [cross pollination problems] is to concentrate on self-pollinating vegetables - such as lettuce, okra, beans, peas, and tomatoes - which have flowers designed in ways that discourage or prohibit fertilization by other plants. (Peas, for example, have already pollinated themselves by the time the flowers open!) Still, to restrict your efforts to these plants is to miss out on much of the fun, challenge and satisfaction of growing your own seeds.



# Troubled Times

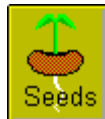

## Cross Pollination

*Mother Earth News*, Sep/Oct 1987

**Bring new pleasures and superior plants to your garden**

By Nancy Bubel

Most other vegetable plants are cross pollinated: They need to receive pollen from others of their kind. Some, like beets, spinach, Swiss chard, corn and rye, are wind pollinated. They have tiny flowers that produce a great many grains of fine pollen to up the probability of successful encounters. A large group of cross-pollinated plants depend on insects to transfer the pollen.. These include asparagus, cole crops (broccoli, Brussels sprouts, cabbage, collards, kale and kohlrabi), carrots, celery, cucumbers, eggplant, melons, onions, parsley, parsnips, pumpkins, radishes, rutabagas, squash and turnips.



# Troubled Times

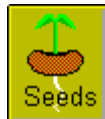

## Unwanted Pollination

---

Different varieties need to be separated as they will cross-pollinate. For example

1. salad cucumbers and pickling cucumbers
2. carrot varieties with wild carrots within 500 ft (so make sure there is no Queen Anne's Lace nearby if you are saving carrot seed)

Offered by [Toni](#).

*Mother Earth News*, Sep/Oct 78

### **Cross Pollination**

The chief problem you - the home seed grower - will face in your propagation activities is maintaining the purity and vigor of your favorite varieties of fruits and vegetables from one generation to the next ... and that largely boils down to preventing cross-pollination among closely related plants. For example, the various cole crops - cabbage, kale, collards, broccoli, and the like - all derive from a common ancestor and therefore cross readily. So do beets and Swiss chard ... turnips, rutabagas, and radishes ... and different strains of cucumbers or squash or melons. Some vegetables even accept pollen from certain wild cousins. Carrots, for example, will cross with Queen Annes lace (the common wild carrot imported into this country from Europe).

The offspring of crosses usually exhibit some - but not all - of the characteristics of each parent, depending on the roll of the genetic dice. But, as a general rule, they are decidedly inferior with respect to one or more traits that we value in garden vegetables (but which nature doesn't give a hoot about). Further uncontrolled crosses may eventually dilute the family virtues to such an extent that the strain becomes useless for cultivation. Then - as my neighbors would say - "Yer seed has run out!" So it s back to the catalogs and garden centers for a new supply.

*Organic Gardneing*, Sept/Oct 1992

### **Save Some Seeds For Next Season**

by Suzanne Ashworth

Remember, only seeds from open-pollinated (not hybrid) plants will produce the same crop next year. And except for tomatoes, you need to be fairly certain that the plants in question have not been cross-pollinated by insects (which would happen if several varieties of the same type of plants grew in the same area) either. Such saved seeds might grow into something similar to the parents, or something tough and tasteless. Tomatoes are self-pollinating. So if you avoid hybrid varieties you'll be able to grow the same tomato from seed saved from each plant next year, even if different varieties were grown close together. Pepper and eggplant flowers can be cross-pollinated by insects, so different varieties of these would have had to be separated by 500 feet this season for seed purity.

Cucurbits - crops such as squash, cucumbers, gourds and melons - need even more personal space. All of these garden favorites must be pollinated by insects, so unless close relatives (of the same species) have been separated by a half-mile or more, you'll get some kind of squash surprise if you grow the seeds. For example, if you are growing a zucchini squash ( *Cucurbita pepo*) and a butternut squash (*Cucurbita moschata*) in the same garden, you can save the seeds from each and expect to have your plants come up



true to type when you plant them next year. But a zucchini and an acorn squash (which is also *Cucurbita pepo*) in the same garden will cross, thanks to pollinating insects, and the seeds probably won't produce a replica of either parent plant. What you grow will look different and it could taste awful. (If saving seed from a variety of squash, melons and cucumbers is a major goal of your life, you can plant different kinds together and still save their seeds next year if you take over the insects' role and hand-pollinate the flowers.

*Mother Earth News*, Sep/Oct 1987

### **Bring new pleasures and superior plants to your garden**

By Nancy Bubel

To prevent unwanted cross-pollination of those crops that do cross readily, you can either keep blossoming plants at recommended safe distances from each other (isolation in space) or plan your plantings so the different crops don't bloom concurrently (isolation in time). You could, for example, keep seed from both an early and a late corn, because the two plantings would tassel at different times. A third way to control pollination is to cage blossoming flowers in fine wire or netting to keep out unwanted influences. (You'd need to do the pollinating yourself or put a piece of maggot-infested meat inside to produce flies for pollinating.) An often easier alternative is to bag and hand-pollinate individual flowers.



# Troubled Times

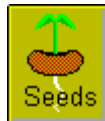

## Isolation

---

*Mother Earth News*, Sep/Oct 78

### **Isolation**

Commercial growers maintain the genetic purity of their strains of seeds in several ways. One of the most common is to plant mutually fertile crops well apart from one another. The precise distance depends mainly on whether the plants are pollinated primarily by insects or the wind. Insect-pollinated vegetables require a minimum separation of 1/4 mile. Wind-pollinated types should be at least 1 to 1-1/2 miles apart.

Few backyard gardeners and small farmers can isolate their crops in this fashion of course ... so they must resort to other professional techniques. The most practical of those "other" methods for use on a small scale are:

1. alternate planting
2. hand pollinating
3. caging
4. roguing



# Troubled Times

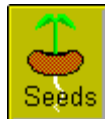

## Alternate Planting

---

*Mother Earth News*, Sep/Oct 78

### **Alternate Planting**

You can isolate closely related vegetables in time rather than space! In other words, grow only one variety of radishes (or whatever) for seed in a single season, another variety during the next growing season, etc. By alternating crops in this way, you can propagate several of your favorite strains of any individual crop with little danger of unwanted crosses originating in your garden.

Unfortunately, though, there's nothing to stop the folks down the street from growing a variety of, say, cabbage or pumpkin that is different from yours (and which insects or the wind will cross-pollinate with your strain) ... so alternate planting can be risky in cities and suburbs. Even so, it should work most of the time because people usually harvest vegetables for the table long before their plants go to seed.

*Organic Gardening*, Sept/Oct 1992

### **Squash Species**

by Suzanne Ashworth

You can grow one type from each species below and still save seeds, but if you want to grow two or more varieties from a single species and successfully save the seed, you'll need to pollinate the plants by hand.

- *Citrullus lantanus* - Watermelon, citron
- *Cucumis Melon* - Muskmelon, cantaloupe, honeydew, casaba, Armenian cucumber and Asian pickling melon
- *Cucumis sativus* - Cucumber
- *Cucurbita maxima* - Banana, buttercup, Hubbard and turban squash
- *Cucurbita mixta* - Pumpkin, green-striped cushaw and white cushaw squash
- *Cucurbita moschata* - Butternut, cheese and golden cushaw squash
- *Cucurbita pepo* - Acorn, crook neck, scallop, spaghetti and zucchini squash; small striped and warted gourds



# Troubled Times

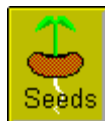

## Caging

---

I have been talking with my farmer friend and we talked about seeds and pollination in general. Cross pollination is a threat with corn planted in and around where cattle corn and other hybridized corns are planted. To safeguard against this use paper bags over the corn cobs once they start to send out their silk, then once the silks are full out, untie the bottom of the bag, and take the bag to another corn plant and cover the cob on that plant. Give the bag a good shake to stir up the pollen and you have just artificially pollinated your corn cob with the correct pollen for its breed.

Offered by [Gus](#).

*Mother Earth News*, Sep/Oct 78

### Caging

The flowers of most garden vegetables are just too small and/or they produce too few seeds to make hand-pollination practical. In such cases caging - which is just what the name implies - offers a sure-fire way to achieve the isolation and control you're after. (Just be sure to include at least five plants of the same type in each cage to encourage vigorous cross-fertilization.) As shown in the illustration which accompanies this article you can easily construct cages from materials found around the house ... but different types of screening must be used depending on whether the enclosed plants are pollinated by the wind or insects.

Cages for wind-pollinated plants should be covered with muslin or cheesecloth to exclude the extremely fine pollens characteristic of these types. (Spinach pollen is so microscopic however that you might as well forget caging altogether and just take your chances that no one nearby is growing another variety-for seed.) In order to make sure the pollen is well distributed within your cages give the enclosures and/or the plants inside a few shakes every two or three days.

When caging vegetables that are pollinated by insects your mesh need only be fine enough to keep the critters out. Window screen is excellent for this purpose. Remember though - in order to ensure pollination it will be necessary to place insects inside the enclosures. Honeybees are ideal for this purpose of course but for obvious reasons they're hard to handle. And if kept away from their hive they soon die. Flies however offer a good alternative and you can breed your own by setting out a pan of raw meat or innards. The flies will lay their eggs in the rotting flesh ... and when maggots appear you can just place the container of infested material inside your cages. The maggots will soon metamorphose into adult insects which will then pollinate the fruits or vegetables.



# Troubled Times

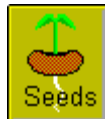

## Hand Pollinating

---

Some plants may need hand-pollination, especially if there are no bees, such as the cucurbits, (cucumbers), melons, and squashes.

Offered by [Toni](#).

*Mother Earth News*, Sep/Oct 78

### **Hand Pollination**

This foolproof method of obtaining pure, true-to-type seed is ideal for cucumbers, muskmelons, watermelons, squash, pumpkins, peppers, eggplant, and corn ... all of which have large, easy-to-handle flowers and produce numerous seeds per blossom. (You can also hand-pollinate tomatoes, but since they're almost entirely self-fertilizing, this precaution is seldom necessary.) The cucurbits (cucumbers, melons, squash, and pumpkins) are insect-pollinated annuals. They have separate male (pollen-producing) and female (ovule-producing) blossoms. You can easily distinguish the two because the female flower includes a swollen ovary just below the petals. The male lacks this organ ... which will eventually develop into the fruit. To hand-pollinate, just follow these easy steps:

1. On the day before a female flower is due to open, fasten it shut with a metal clip or rubber band (or whatever works). This precaution will keep unwanted pollen from fertilizing the blossom.
2. On the following day pick a male flower from a different plant ... and expose the pollen-producing anthers by removing the petals.
3. Then open the female flower and gently rub the anthers across the stigma (the enlarged pollen receptacle at the tip of the style or central stalk within the blossom).
4. Finally clip the female flower shut again to prevent further pollination. Be sure to mark the blossom in some fashion so that you can later distinguish the fruit it produces from that borne by blossoms pollinated by insects.

You can hand-pollinate peppers and eggplant in much the same way ... except that their flowers are perfect ... that is they contain both male and female parts. So you just have to pick any flower from one plant and rub it against any other from a different plant. The receptive blossom of course should be clipped both before and after this operation. (Actually peppers and eggplant - like their cousin the tomato - are largely self-pollinating but bees visit these fruits so much that a good deal of crossing occurs anyway.)

Like the cucurbits corn plants have separate male flowers (tassels) and female flowers (the ears). Pollen formed on the tassels is carried by the wind to the silk (stigmas) produced by the ears. To hand-pollinate place white paper bags over selected ears before the silk appears. Secure the bottom of each sack with a rubber band or length of twine. When pollen shakes away from the tassels easily cut one off and rub it against the silk of ears growing on different plants. Then replace the bags until the ears mature.

*Organic Gardening*, Sept/Oct 1992

### **The Fine Art of Hand Pollination**

by Suzanne Ashworth

All members of the Cucurbitaceae family (squash, gourds, melons, cucumbers, etc.) produce both male and female flowers on the same plant. In their search for food, insects pick up pollen from male flowers and

deposit it on female flowers, randomly moving pollen from flower to flower. Cucurbits can be pollinated by almost any variety within their same species and the plants that pop up from seed produced by such crosses are often unusual and frequently bear little resemblance to the parent plants. To prevent this random pollination, you must keep insects away from the flowers that you want to ripen into the fruits you'll select for seed. You can start to do this as soon as the first flowers appear, but remember that summer squash are like cucumbers: If you don't keep the plant picked the fruit production slows, so you may want to let the plant produce for a while before you start to hand-pollinate. (With melons, gourds and other squash, you can start pollinating any time without interrupting production.)

Ready? First, you must learn the difference between male and female flowers. Female blossoms are attached to tiny, immature fruit which reveals itself as a bulge in the stem right behind the flower. Male blossoms have straight stems. This is most easily seen in squash. Melons and chayote have very small flowers that make their gender a bit more difficult to identify. In the evening, select blossoms that look like they're ready to open the next morning. These will be beginning to show color and the petals will be beginning to flare outward. Choose a male flower from one plant to pollinate a female flower on a different plant of the same variety - this "sibling" will result in a greater degree of genetic diversity, which insures a healthier seed stock. (In case you were wondering, applying the pollen of a male flower to a female flower of the same plant is known as "selfing.")

Use masking tape to gently hold the blossom closed. Early the next day, remove the tape from the male flower, pick it and carefully tear off the petals, exposing the pollen-covered anthers. At this point, you may want to hold the stem of the male flower between your teeth in order to free both hands (who says garden sex isn't wild?) Now, gently remove the tape from the female flower. The flower should slowly open. Take the male flower and gently rub its pollen onto the stigma sections in the center of the female flower. Pollination will be more successful if several male flowers are used to pollinate one female flower. When you're done, retape the female flower's petals closed and mark the stem. You can mark that stem with string, yarn or any brightly colored durable material. The key word here is durable. Your markers will be exposed to water, heat, light and birds looking for nesting materials. Poultry bands work exceptionally well; they expand, stay put and are reusable (you can buy them at animal feed and supply stores). Be sure you mark the actual fruit when you harvest it, too, so you'll know it's the one from which you want to save the seeds.



# Troubled Times

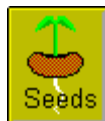

## Flowers

*Mother Earth News*, Sep/Oct 1987

**Bring new pleasures and superior plants to your garden**

By Nancy Bubel

Flowers exist to produce seed. The flower's pollen bearing, fertilizing (male) organ is the stamen, which consists of the stalk (or filament) and anthers, the pollen bearing sacs on the tip of each stalk. The seed-nurturing, receptive (female) parts of the flower, called carpels, are composed of the ovary, the egg bearing capsule, the style, the tube leading up from the ovary and the stigma, the pollen-receptive tip. When a grain of pollen lands on a receptive stigma, the grain extends a living thread through the style to the ovary. This unites with a ripe ovule, forming a single living cell - which then begins the multiple divisions that start it on the journey to becoming a tiny but marvelously intricate seed embryo.

Not all flowers contain both male and female parts. Those that do are called perfect flowers. Plants with separate male and female flowers may be either monoecious (the separate blooms occur on the same plant) or dioecious (each plant bears either male or female blooms). Some perfect blossoms are self pollinating. They accept their own pollen without any help from wind or insects. (Some self-pollinate before their flowers even open). These are the easiest kinds of plants from which to save seed, because you don't have to isolate them to prevent them from accepting pollen from other, different, varieties.



Microsoft Illustration



Copyright Microsoft



# Troubled Times

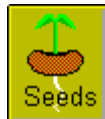

## Roguing

---

*Mother Earth News*, Sep/Oct 78

### **Roguing**

During the growing season you should regularly examine your seed crops and cull any plants that seem sickly deformed or not true to type. This process - known as roguing - strengthens the strains you're raising by eliminating undesirable traits from the pool of genes that you're working with. You should rogue biennial root vegetables again a second time just prior to winter storage.

*Mother Earth News*, Sep/Oct 1987

### **Bring new pleasures and superior plants to your garden**

By Nancy Bubel

Another breeder's technique you can adopt is roguing, culling weaker plants before they can affect the seed you want to save. You need to rogue plots of cross-breeding plants before they flower, to prevent them from possibly pollinating the ones whose seed you want to keep.





# Troubled Times

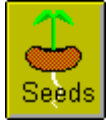

## Resting

---

I'm not an authority in this area, but if memory serves me, seeds need a resting and drying period before they are ready to germinate. It pretty much follows Nature's usual course: The fruit falls to the ground; it rots; the seed gets covered with leaves or mulch; it dries out over Winter and (if covered with humus in some way) is ready to germinate the next Spring. Most seeds benefit from freezing, i.e., overwintering. Some (like beans) don't require this as they will germinate in the pod if it is too damp!

The best policy would be to store seed for as long as you can and plant your oldest seed first (FIFO). If your storage methods are inadequate your germination rates will decline, but the ones that do germinate will pass on that survivability. Most of the veggies we will be cultivating will undergo genetic alteration during the Aftertime as we will be unintentionally (out of necessity) be selecting for low light survival and high production. Collect and save as much seed as you can and label each gathering of seed by year. Use the oldest seed first and attempt to maintain enough seed stock to hold newly harvested seed for at least a year.

When planting year-round in a climate-controlled environment, you will not need to plant quite as much as you will have year-round production and the need to preserve some (most?) of the harvest (by canning or freezing) for the winter will be eliminated.

Offered by [Roger](#).



# Troubled Times

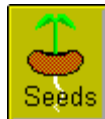

## Potatoe

---

I know that potatoes are planted using seed potatoes but potatoes may not do well for some time, and seed potatoes not planted will rot in storage the same year, does anyone know where to get potato seeds? I know potato plants will go to seed like anything else. The down side I understand is that potato seeds planted one year will not produce potatoes until the second year, but that's better than never having a good staple like this again and the dried seeds could presumably be stored for appropriate planting conditions, a few years post shift. I have not been able to source seeds locally and not knowing our planning scenario, the seed suppliers can't understand why someone would even ask for such a thing.

Offered by [Kraige](#).

Potatoes from seed are a rarity, indeed. The seed team has experimented a bit with them and there seem to be only three varieties available commercially, and these are considered hybrid (won't reliably reproduce themselves). I have grown all three and can tell you that you do get potatoes the first year (potato plants are annuals), but they are very small. When stored and replanted, you get larger potatoes, but they do not seem to bloom and produce seed. They did not survive storage a second time and I have not tried them since. Harvesting seed from the varieties I do have that produce seed is an almost insurmountable challenge. The seed is very small and the seed pods (small, hard green tomato-like things) often drop and are lost before you think they are ready to pick. I have a small sample of the seed I did successfully harvest, but I've not tried to grow it out. If you want to try potatoes from seed, I would suggest that you buy some from either Gurney's or Henry Fields and if you are successful, buy in bulk before the shift!

Offered by [Roger](#).



# Troubled Times

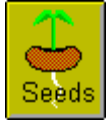

## Cuttings

---

Here's a useful tip on Carrots from my *Introduction to Permaculture* book:

*You can cut the tops off your carrots, then cut these tops into quarters, place on damp cotton wool and they will sprout within a week. Once the sprouts grow a few centimetres they can be replanted into the garden to grow more carrots.*

That's four new carrots from each carrot you eat! Works too, I've got a whole saucer of cotton wool with sprouting carrot tops, they'll be going into the garden next weekend. Parsnips can be propagated the same way. That's 4 new carrots and 4 new parsnips from each one you eat. Well, to be truthful, I haven't harvested any carrots or parsnips yet, but I have planted quite a few cuttings now and they all seem to be growing well.

Offered by [Gino](#).



# Troubled Times

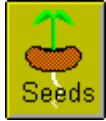

## Harvesting

*Mother Earth News*, Sep/Oct 78

### Harvesting

As in just about every other aspect of seed production harvesting procedures vary from one vegetable to the next. Certain generalizations however do apply to five basic groups:

#### **Beans, Peas, and other Legumes:**

Let the finest pods on the most vigorous plants remain on the vine until they're completely dry. At that time they should be brown or yellow - depending on the variety - and the seeds should rattle. Then just pick and shell. Or you may thresh the pods by beating them with a stiff leather belt or other device. Be careful not to hit them too hard however or you may shatter the seeds inside. The easiest way to separate shelled beans and peas from unwanted debris is to use a lawn rake. Or you can screen the vegetation: Just make sure the holes in the mesh are small enough to hold pods and stems but large enough to allow the seeds to pass through to a ground cloth or receptacle that you have waiting below. You can make a simple screen by attaching wire mesh to a barrel hoop or similar device.

#### **Pulpy Fruits and Vegetables** (tomatoes squash cucumbers melons peppers eggplant and okra):

Pick fruit when it is dead ripe. Scoop out the seed-bearing pulp and place it in a container with enough water to cover. Next allow the mixture to sit - and ferment - at room temperature for 5-7 days. By then, the seeds should have separated from the pulp and fallen to the bottom of the container. After rinsing the seeds until they're clean spread them out in a cool place to dry.

#### **Mustard-Family Crops** (cabbage, kale, collards, cauliflower, kohlrabi, broccoli, brussels sprouts, mustard, radishes, rutabagas and turnips):

Cut the seed stalks before their pods have completely dried out. Then hang them indoors for 2-3 weeks to finish curing. When the stalks are as dry as they will get thresh the pods as you would beans and peas. Then rake or screen to remove plant debris. Finally winnow the seeds to remove any chaff that is still mixed in with them. This is best done on a slightly breezy day. Just drop the seeds from a height of five or six feet onto a ground cloth or into a large-bottomed container. The wind will carry away the light chaff but not the heavier seeds.

#### **Small-Seeded Crops** (lettuce, endive, celery, carrots, onions, spinach, and salsify):

Pick the seed stalks when they have matured place the stalks - one or a few at a time - inside a paper bag shake off the seeds and then winnow them as described above.

#### **Corn** (sweet corn, field corn, popcorn):

The ears should remain on the stalks until the kernels are hard and dry ... about 3-5 weeks after the eating stage. Then bring them inside before the onset of frost or wet weather in the fall. Shell the ears only when the kernels have completely dried.





# Troubled Times

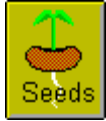

## Ripe

---

*Organic Gardening*, Sept/Oct 1992  
**Save Some Seeds For Next Season**  
by Suzanne Ashworth

Seeds of tomatoes, peppers, melons and winter squash are ready for saving when the fruits are ripe and ready to eat. Peppers are the easiest. The seeds are mature after the peppers have changed color to their final stage of ripeness. Cut the peppers open, scrape the seeds onto a plate, eat the pepper and let the seeds dry in a non-humid, shaded place, testing them occasionally until they break rather than bend. What could be simpler? (Note: Dry all your "wet" seeds on a glass or ceramic plate. Spread the seeds evenly over the surface of the plate and stir twice daily to ensure even drying and to keep them from clumping together. Do not dry seeds on paper plates or paper towels - they'll stick like glue. And do not dry them in a warm oven or any place the temperature exceeds 95° F. A food dehydrator with an accurate thermometer set at 85° F works well.)

Muskmelons, watermelons and winter squash? Super easy to handle at seed-saving time. Cut muskmelons open, scoop the seeds into a strainer, rinse and set out to dry. Watermelons are almost as easy. After finishing off the tasty flesh, put the seeds (spitting contests optional) in a strainer and add a drop of dish washing liquid to remove any sugar and saliva left on the seeds. Mix, rinse and dry. Winter squashes need to be carefully cut to expose the seed cavity. Do not cut straight through the center of the squash - you'll cut through some seeds, too. Just stick the knife in as far as necessary to cut through the flesh and move it around the circumference. (Be careful - some squashes will fight back!) Pull the seeds from the fibers, rinse and dry. And don't cut a squash before you're ready to eat it - seeds can be saved from most winter squashes many months after harvest (although a few long-storage varieties may have sprouted seeds inside after six months or so).



# Troubled Times

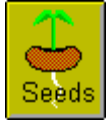

## Dry

---

*Mother Earth News*, Sep/Oct 1987

### Care and Handling

By Nancy Bubel

No matter what kind of seed you're collecting, be sure to pick it when it's dry, not green. Green seeds may contain incompletely developed embryos or may lack sufficient endosperm (stored nourishment) to survive until planting time. Green seed is also more likely to spoil in storage. (If you bag heads of plants that ripen their seed gradually, cut a few slits in the bag for better air circulation.) If at all possible, gather seeds on a dry, sunny day - and preferably before the weather gets too cold. Frost itself won't hurt most seeds, but the condensation of moisture caused by alternate freezing and thawing might shorten their useful life span.

Even seeds that look and feel dry when you pick them should be spread on newspaper to air-dry for up to a week before packaging. Large seeds like beans and corn benefit from several weeks of air-drying before storage. Never dry seeds in an oven. Prolonged temperatures over 95°F can damage or kill them. And be sure to label your seeds as soon as you can after collecting them, so you don't mix them up during the drying process.

Beans and many grain seeds must be threshed to knock off the pods. You can eliminate much of the chaff - pieces of broken pods, leaves and stems—that remains by winnowing. To accomplish this pleasant harvest ritual, pour the seed several times from one container to another in a stiff breeze or in front of a fan. The light, dry stuff will blow away as the heavier seed falls straight down.

The general rule is, if the seed is green, wait. I had peas that looked completely dead but the pods were still green and soft for two weeks. My beans are the same way now. You can pull the whole plant and hang them up to dry (if the plant stem is completely dry and dead, not processing fluids), but if you aren't needing the space for anything else right away, just wait until the seeds dry out naturally. The absolute best way to dry seeds is the way nature intended, in the sun! In the absence of sunlight, try to emulate it. It's not the UV light that does the trick, it's the percolation (evaporation). You could place them under a lamp (regular incandescent or fluorescent light) or even an infrared heat lamp.

If you don't have any of these available, a food dehydrator would work, but be careful about the temperature. I have a dehydrator I purchased from Wal-mart for \$40 a couple of years ago and it works fine though it runs at a relatively low temperature (takes longer to dry food than other products out there). It's not thermostatically controlled, but it's fairly easy for me to judge the temperature and I never allow it to run more than an hour or so at a time with seeds. I would not advise using an oven, the temperature control is rather tricky at the low end and it is easy to forget you have them in there and they get too dry!

It is possible to dry out the seeds too much. This can be monitored by not allowing the seeds to get too hot in the dehydrator. How hot is too hot? That's hard to say, if your dehydrator is thermostatically controlled, just use a temperature of no more than 100 degrees (F). If your dehydrator is not thermostatically controlled, don't allow the seeds to sit in there for more than an hour at a time. Turn off the dehydrator and let them cool to room temperature, then check them by picking up a seed and carefully squeezing it to see if it is hard yet. Be sure to check several this way. If the majority are still somewhat soft, dry them for another hour and so on. Above all, be careful.

Offered by [Roger](#).





# Troubled Times

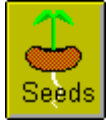

## Time on the Vine

---

*Organic Gardening*, Sept/Oct 1992

### **These Seeds Need Some Extra Time on the Vine**

by Suzanne Ashworth

Eggplants, cucumbers and summer squash must ripen beyond the normal, ready-to-eat stage to allow viable seeds to develop inside. To save the seeds of eggplants, you'll need to wait until the fruits are far past the stage when you'd pick them for kitchen purposes. Seeds saved from table-ready eggplants will be immature. Left on the plant, purple eggplant varieties will ripen to a dull brownish color, green varieties will turn yellowish green, and white becomes golden. Eggplants ready for seed saving will be dull, off-colored and hard.

Cut the ripe eggplants in half and pull the flesh away from the seeded areas. If you want to save more than a few seeds, a food processor or blender comes in handy to mash the flesh and expose the seeds. Process (without peeling), and put the pulp in a bowl. Add water, let the good seeds settle, then pour off the water and debris. Repeat until only clean seeds remain. Add a bit more water and pour the mix through a strainer with a mesh fine enough to retain these tiny seeds. Dry the bottom of the strainer with a towel to absorb excess moisture and dump the seeds out onto a plate to dry.

After cucumbers ripen, they change color and start to become mushy. (Remember, if you stop picking cucumbers, their vines will stop producing new fruit, so you may want to pick your seed-savers toward the end of the season.) Cut the ripe cucumber in half and scrape the seeds into a bowl. To remove their slimy coating, rub them gently around the inside of a sieve while washing them or soak them in water for two days. Rinse and dry. You'll need to let summer squash ripen past the tender stage, too. When you can't dent the squash with a fingernail, it's ready to have its seed saved. Pick it, cut it open, scrape the seeds into a bowl, wash, drain and dry.



# Troubled Times

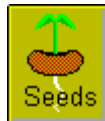

## Tips

*Countryside*, March/April '91

### **Some tips on saving seeds**

Be sure the seeds are perfectly dry so they don't mold. Store them in tightly capped small bottles, in a cool place.

Most seeds need a "rest period" of one to several months before they will germinate. After that, germination can be tested by soaking 10 seeds, draining them, and spreading them between layers of moist cloth. Keep the cloth moist. Germination varies between two days and two weeks depending on the type of seed and temperature.

The percentage of germination decreases with age. Seeds of corn and onions can be stored for two years; peas and beans for three years; tomatoes, four years; cabbage and spinach, five years; and beets and squash, six years.

Save the best seeds, from parents with the qualities you desire. The earliest pea pods can be marked by tying a scrap of colored yarn or similar material on the vine, a sign that says these pods should not be picked. When the pods are completely ripe and dry, pull the vines and hang them in a garage or shed. When the pods are brittle shell and store the peas.

Mark chosen tomatoes and leave them on the vine until they are overripe, but pick them before they spoil. Cut the tomato and remove the seeds. Some pulp will inevitably come along. Soak the seeds and pulp in water for about two days or until they start to ferment, but not long enough to sprout. Separate the seeds from the pulp by rubbing, and dry them quickly (but not in direct sun) by spreading them thinly on newspaper.

Carrots, radishes, and other biennials will not produce seed until the second year of growth. These can be left in the garden over winter under a heavy mulch, or they can be dug and stored in damp sand in the root cellar for spring replanting. If they will be in the way of future tilling or succession planting, consider a separate area for seed production. When the seed head is almost ripe, tie a paper bag over it to collect those seeds that will otherwise fall to the ground.

Onions are also biannual, but producing bulbs or sets requires yet another year. Sow seed thickly - about a quarter of an ounce in four square feet - so they will not get too big. When the tops fall over pull them and store them in net bags for planting the following year.



# Troubled Times

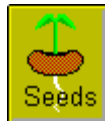

## Diseases

---

*Mother Earth News*, Sep/Oct 1987

### **Care and Handling**

By Nancy Bubel

Some diseases like bacterial spot are seed-borne. If you've had trouble with such blights in your garden, you might want to heat-treat your seeds to kill the bacteria. A 20 to 30 minute soak in water maintained at 122°F is effective. Use a double boiler (a pot set in a water-filled electric frying pan works well), and keep stirring the seeds throughout the treatment period. Then drain and dry them well. I wouldn't recommend heat treatments, though, unless you've had a recurring problem with disease. Seeds are alive - every one contains a living embryonic plant - and exposure to moisture and heat will shorten their life span.



# Troubled Times

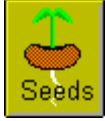

## Starting Mix

---

I did a little research on the best way to plant and grow seedlings and plants (starting with tomatoes and peppers) in my home state (Alaska). I started my seeds in doors in one of those plastic green house things. The problem with these things is that the little bit of dirt dries out fast. If a seedling dries out during germination, it is dead. I was thinking of a way to keep the dirt moist to reduce the chances of me forgetting to water them. We use the type of kitty litter that is made from old news paper and made into little pellets. I soaked a few cups in a pan of water for about 1/2 hour until it turned to mush. I mixed that in another bucket with my potting soil. This is what I used to start my seedlings in.

Offered by [Clipper](#).

For hydroponic and indoor gardening they suggest vermiculite and perlite (available at most garden centers). They both suck up and save moisture. I have a big rubbermaid tub for potatoes right now, and a drain near the bottom. If I water more than once a week, the water just drains right out the bottom, because the vermiculite and perlite really hold the water in. I'm sure kitty litter does the same.

Offered by [John](#).

A better substitute for kitty liter is a product that absorbs a 100 times its weight in water called soil moist (it is like silica jell) a dehydrator but better. Reusable thousands of times It is also found in Depends and other diapers as a dry crystalline jell. I am growing radishes in it and potting soil. It only takes a couple of table spoons for a 3 gallon pot.

Offered by [Robert](#).



# Troubled Times

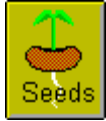

## Hybrid Seed

---

I would like to try to clear up some confusion over definitions here. The basic division in plant types is 'hybrid' and 'open pollinated'. Open pollinated plants reproduce 'true to type' without special pollination procedures. Open pollinated varieties are best for saving seeds because the characteristics of the offspring are predictably similar to the parent plants. Hybrid varieties are crosses of two or more specific open pollinated varieties, accomplished by hand-pollinating plants with pollen from the appropriate parents. This is done to breed in desirable qualities of the parent strains. Seed saved from hybrids are often sterile (like a mule), and in any case the performance is unpredictable. Vegetative propagation of plants, such as potato eyes, root divisions, rooted cuttings, etc. will produce clones of the parent plant, and so can be reliably used with hybrid varieties.

Offered by [George](#).

*Mother Earth News*, Sep/Oct 1987

### **Bring new pleasures and superior plants to your garden**

By Nancy Bubel

What kinds of seeds should you collect? Eliminate hybrid plants right off the bat. Hybrids are created from two different parents in a special selective (and often intricately mechanical) process unlikely to be duplicated in natural random fertilization. Plants grown from the seeds they produce will not duplicate the good qualities of the original specimens and may, in fact, be greatly inferior. Except for some frankly experimental ventures, seed savers work with open pollinated (also called standard) varieties. These can be bred true to form by naturally occurring pollination.

I've been looking for some information on collecting and managing seed in the garden and found an excellent [Article](#) that describes the issues associated with Hybrid species and Cross Pollination and the importance of heirloom, non-hybrid plant varieties for your vegetable garden. There are also some text references at the end of the article, a review of one yielded this critical piece of information:

*We have seen the rise of hybrid crops in the years since World War II. They are good for the seed business because the grower can't just let a few plants grow to seed, save the seed, then plant that seed next season. Hybridized plants don't yield seed that's true to the character of the plant, so the grower has to return to the seed rack year after year. Buying seed on a commercial level is a big deal, as is growing enough of it to meet the market. A lot of tillable land in South America isn't growing food for hungry South Americans, but growing corn seed for American farmers, and the biggest use of corn in this country is animal feed. Not many hungry South Americans get to eat corn-fed American beef and pork. In one sense, he who controls seed controls food. Or, he who owns seed owns food, and the highest bidder takes all.*

Which kind of makes clear the importance of heirloom seed cultivation and management if you intend to complement your post-photoshift diet with vegetables. I had thought that it was possible to collect seed from commercial plant varieties. Just one more illusion shattered.

Offered by [Gino](#).



# Troubled Times

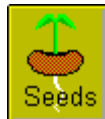

## Genetically Altered

---

From the *PNB News Team*, as posted on the Disaster List

### US Patent on New Genetic Technology Will Prevent Farmers from Saving Seed

On March 3 Delta and Pine Land Co. (Mississippi, USA) and the U.S. Department of Agriculture (USDA) announced that they received US Patent No. 5,723,765 on a new genetic technology designed to prevent unauthorized seed saving by farmers. The patented technology, "Control of plant gene expression" would allow seed companies to control the viability of progeny seed without harming the crop. In other words, the new technology genetically alters the seed so that it will not germinate if re-planted a second time.

The patent is broad, applying to plants and seeds of all species, including both transgenic (genetically engineered) and conventionally-bred seeds. If commercially viable, the patented technology could have far-reaching implications for farmers and the commercial seed industry. If the technology is widely licensed, it could be a boon to the seed industry - especially for companies marketing self-pollinating seeds such as wheat, rice, cotton, soybeans, oats and sorghum. Historically there has been little commercial interest in non-hybridized seeds such as wheat and rice because there is no way for seed companies to control reproduction. If commercially viable, the new technology could mean huge profits in entirely new sectors of the seed industry. For farmers, the patented technology will undoubtedly mean greater dependence on the commercial seed market, and a fundamental loss of control over germplasm. If widely utilized, farmers will lose the age-old right to save seed from their harvest.

### Seed Germination or Termination

*New Scientist*, 28 March 1998

They call it "terminator technology", a "breakthrough" in genetic engineering. It is the seed that doesn't germinate. If adopted, it means that the tradition of saving seeds from one crop for the next season's planting will disappear. In early March 1998, the U.S. Department of Agriculture (USDA) and a Mississippi seed company, the Delta and Pine Land Company, were granted a patent for a technique that can sterilize the seeds produced by most agriculture crops.

They expect the technology to be adopted by all the major seed companies which for many years have been looking for ways to prevent farmers from recycling seeds from their crops. Willard Phelps, a spokesman for the USDA, predicts the new technique will soon be so widely adopted that **farmers will only be able to buy seeds that cannot be regerminated.**



# Troubled Times

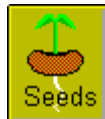

## Mega Merger

---

### **Seed Terminator and Mega-Merger Threaten Food and Freedom**

Copyright © 1998, by Geri Guidetti

Four days ago, the scope of the potential impact of the Terminator Technology on global agriculture broadened explosively with the announcement that American Home Products Corporation (AHP) had agreed to buy Monsanto Co. for \$33.9 billion in stock. "AHP," according to its press release, "is one of the world's largest research-based pharmaceutical and health care products companies. It is also a global leader in vaccines, biotechnology, agricultural products and animal health care." Reuters reports that the acquisition will create "a powerful pharmaceutical company with a massive presence in the growing market for genetically engineered agricultural products."

Actually, AHP is a family of companies including American Cyanamid, Cyamid Agricultural Products Group, Wyeth Ayerst, and others. It is the third largest in the US in herbicides, insecticides and fungicides but, with its acquisition of Monsanto, it is now estimated that the combined companies will become the largest agrochemical/life industries company in the world, beating Swiss global giant, Novartis. It does not take a giant mental leap to see the massive potential for the application and marketing of Monsanto's Roundup Ready seed and licensing agreements and the Terminator Technology to an increasing number of companies and food crops. If the Terminator technology is not globally banned, its eventual incorporation into all genetically engineered and open-pollinated, non-hybrid food crops is predictable.





# Troubled Times

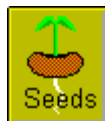

## Halted

---

The American biotechnology company Monsanto says it has decided not to develop what is known as "terminator gene" technology for its genetically-modified crops, per the [BBC](#) (October 4, 1999). Terminator genes prevent crops from producing fertile seeds - which means that farmers growing them would have to buy new seeds each year, rather than saving part of the harvest to plant next year's crop.

Offered by [John](#).



# Troubled Times

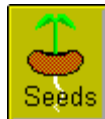

## Parent Plants

---

*Mother Earth News*, Sep/Oct 78

### **How to Choose Parent Plants**

Once your vegetables are established - in late spring or early summer - select only the finest specimens for seed production ... the ones that are most robust, have the shiniest leaves, are least bothered by insects, and seem truest to type. And don't judge merely by a single criterion - giant fruit, for example - but consider each plant's overall vitality. Remember, sickly plants yield fewer viable seeds ... and tend to produce sickly offspring to boot!

Next, after you've chosen your "parent" stock, clearly mark each plant in some fashion (with ribbons or stakes or what have you) to set them apart from your "ordinary" eatin' vegetables. If you're anything like me, you'll thoroughly enjoy selecting plants for such desirable traits as earliness, sweetness, hardness, shape, color, productivity, and resistance to drought or pests. In effect, you will be developing your own strains ... and chances are they'll be better adapted to the environmental conditions in your own particular garden than any commercial variety you can buy.

*Mother Earth News*, Sep/Oct 1987

### **Bring new pleasures and superior plants to your garden**

By Nancy Bubel

Be sure to mark your parent plants with stakes, bright labels or wild-colored cloth strips. This is especially important if more than one family member is likely to be picking vegetables. It's no fun to find that your earliest-ever pea pods just disappeared into the soup pot. ... Be sure to choose your parent plants carefully, selecting seed only from superior examples. What should you look for? Whatever's important to you. If you'd like early tomatoes, save seed from the first fruit that ripened. If it's size you're after, save seed from the plant that produced the most large fruit. And consider the plant as a whole in addition to individual qualities.

With most cross-pollinated crops, you should save some seed from five or more individual plants (even if you only need a small amount of seed). If you repeatedly keep the offspring of only one plant, over time the inbred seed will most likely run down, i.e., lose vigor and become more susceptible to disease or other problems. Self-pollinators don't lose vigor from their natural inbreeding, so you can safely save only one plant's (or a single fruit's) seed from them if you wish.





# THE ARK INSTITUTE

Sowing the Seeds  
of Sustainability and Self-reliance

[HOME](#) | [STORE](#) | [PRODUCTS](#) | [F.A.Q.](#) | [PHOTOS](#) | [TESTIMONIALS](#) | [NEWS & NOTES](#)

## Friends

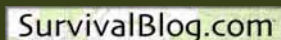

## Seed Partnership



## Welcome to The Ark Institute

Your #1 source for 100% Non-GMO, Non-Hybrid seeds, and all of your gardening, sustainability and self-reliance needs.

We at The Ark Institute believe that true, global sustainability begins with local, personal sustainability and self-reliance. We have spent our last 15+ years dedicated to that one principle, and we continue today with the same passion as when we first uncovered the patents for the "Terminator Gene" and the "Traitor Gene" in the mid 1990's.

If true sustainability and self-reliance is what you seek, The Ark Institute is here to help. We offer only the cleanest 100% non-hybrid, non-GMO, chemical free produce seed, to allow you to plant your own gardens, feed your families and friends, and then harvest your seed to save for use the following planting season. By growing your own food at home or at a community co-op garden, you can further ensure your produce is chemical free, and as organic as you want it to be, *all for a fraction of the cost of store-bought produce.*

We also offer FREE SHIPPING to *most* addresses on just about everything in our Store, excluding some oversized objects like raised planting beds or water purification. \*\*\*Items shipped overseas may require special shipping as well - please contact us if you think that may apply to you.

Whether you are growing an acre at your homestead or in some pots on your patio, we can help you become fully self-reliant for all of your produce needs. Not only do our seed packages contain more seed than most of "the other guys" (*in some cases more than 20 times more seed*), but it is also of the highest quality, ensuring you the highest yield in your own gardens and more successful seed per dollar than the rest. We test everything we sell in our own test gardens (see [photos](#) page) for traces of genetic modification, so you can rest assured that anything we sell in our store is 100% "Ark Approved" for quality, viability, genetic purity, and sustainability. We have signed the Safe Seed Pledge and promise to never knowingly sell anything that we consider at risk of contamination.

We also now offer individual seed varieties in addition to our popular seed collections, so you can order just what you need to get started as well as the larger collections for when you're ready (or for frozen storage for later!)

If you have been growing for years or are just getting started, we also include a wealth of knowledge in our Bookstore, where you can find books on container gardening, homestead farming, seed-to-table how-to manuals, seed and harvest preservation manuals, and much more. What's more, if you want to ask us anything in particular, we have our founder, a world-class and world-renowned biologist, on hand to answer your questions and help you turn that brown thumb green!



Gerri Guidetti  
Founder, The Ark Institute

Gerri has been growing non-hybrid, non-GMO vegetable gardens for over 40 years. Her gardens are an outdoor extension of her laboratory, a hands-on commitment to the preservation of precious, disappearing seed varieties and their ability to provide food self-sufficiency to all who grow and save them. Her research and writing have been published in many languages, and she has served as a consultant to European and Middle Eastern agricultural ministries. Included in her 40+ years in research, Gerri has devoted the past 15+ years of her life to growing and storing endangered food seeds, and developing The Ark Institute as a resource for these disappearing varieties.



## Featured Items:

### Freezer-Ready Seed Packaging



If you are not planting immediately, our seeds can be frozen for long-term storage and later use - even 40+ years later! This option can be added to any seed purchase, so start storing now!

### 52-Variety Family Seed Package



Provide for your family for years to come with this collection of delicious produce. 52 varieties of delicious favorites, and approximately 1 acre's worth of seed. Only \$97

### Build Your Own Seed Package



In addition to our carefully assembled seed collections, you can now also build your own packages by purchasing individual seed varieties, one packet at a time. Perfect for those with limited space or limited tastes. Prices Vary \$2.75 - \$7.25

### Ark's Healthy Baby Package™

Grow and produce your own organic baby food! We include the seed for endless healthy

Our Store also includes other helpful items, such as our own line of Garden Arkitecture™ Garden and Landscape Elements, British Berkefeld Water Purification Systems, Potassium Iodate tablets, and much, much more.

You can contact us at (800) 255-1912 or by [email](mailto:support@arkinstitute.com) at support@arkinstitute.com. We can also be followed on [Twitter](#) at @Ark\_Institute, or on [Facebook](#) too.



produce and also a Baby Bullet™ in one package, saving you hundreds of dollars off retail!  
SALE! Now only \$149

© 1996-2011 Ark Institute | all rights reserved | void where prohibited  
The Ark Institute | PO BOX 3430, Easton PA 18043-3430 | (800) 255-1912 | [support@arkinstitute.com](mailto:support@arkinstitute.com)

[archived Ark site](#)

# Troubled Times

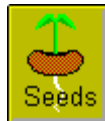

## Save Seed

---

From *Build Your Arc*, by Geri Welzel Guidetti

### **Saving Your Own Seeds**

One of the main reasons for growing open-pollinated or non-hybrid fruit and vegetable plant varieties is to enable you to save your own seed from year to year. This eliminates the need to buy seed commercially, thus decreasing your dependence on others for your food and increasing your self-sufficiency. This is increasingly important because open-pollinated varieties are rapidly disappearing from commercial seed catalogs, ensuring for seed companies that you and I will come back to them, year in and year out, to buy their proprietary hybrid and protected plant varieties. This may seem defensible in good times when there are no significant crop failures, droughts, floods, fuel or fertilizer shortages, economic crises, etc., and when you have the money to buy all of the seed you need to grow your food. It might well become a problem if any of the above were to occur.

Saving seed from open-pollinated plants can be a fairly easy undertaking or it can be more challenging, depending on the types of plants you choose to grow and how close to your property similar plants are being grown by someone else. Some plants cross easily with others and will yield seed which carries traits of both. The plants you get from those crossed seed will not be identical to either parent. In some plants, like tomatoes, such crosses are infrequent and, when they occur, still tend to produce usable tomatoes. In others, like squashes belonging to the same species groups, crosses occur readily and result in seeds that rarely produce squashes of quality equal to that of either parent.

There are ways to minimize or prevent the crossing of varieties by wind, bees or other insects. One is to grow only one type of squash of each species, one kind of onion, eggplant and so on. But if your neighbors within a mile of your property are growing other varieties of these plants, bees will certainly cross-pollinate a few or more of them anyway. Another technique is to cage plants you want to collect seed from. Cages must be screened with material that won't allow pollinating insects to enter. Another, more labor intensive but more reliable technique is to hand pollinate plants from which you plan to save seed. These techniques are fairly easy to learn and can be very interesting and rewarding.



# Troubled Times

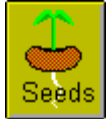

## Terminator Gene

---

From: Geri Guidetti  
To: arkinst@concentric.net  
Sent: Tuesday, January 15, 2002 8:09 PM  
Subject: Food Supply Update

Food Supply Update: January 2002  
Sowing the Seeds of Insecurity: Last Year Provides Clues to the Future of Food  
Copyright 2002, by Geri Guidetti

The Ark Institute, P.O. Box 142, Oxford, Ohio 45056  
Web site: [www.arkinstitute.com](http://www.arkinstitute.com)  
email: [arkinst@concentric.net](mailto:arkinst@concentric.net)

Note: This and all Food Supply Updates may be reprinted or distributed electronically, only in their entirety, including attributes and contact information. They must be offered free of charge. Edited versions must receive prior consent of author. Food Supply Updates are archived at The Ark Institute's web site at [www.arkinstitute.com](http://www.arkinstitute.com)

An ill-wind blew across Percy Schmeiser's land in 1996. Today in his 70s, the third-generation Saskatchewan, Canada, farmer has been growing and improving his own canola (oil seed) crops for 40 years. Each year, he would save some of his harvested seed for planting the following year. Though some farmers in the surrounding area were growing Monsanto's patented, genetically modified (GM) Roundup Ready canola, Schmeiser was not. He was growing his own, but the wind blew and bees flew, both apparently carrying grains of GM pollen from neighboring fields into Schmeiser's crop. Or maybe it was GM seed transported from surrounding farms that often blew off trucks traveling the roads adjacent to Schmeiser's land. No matter. Without his knowledge or consent, errant, patented Monsanto genes had apparently been incorporated into some of the Schmeiser family's 1997-harvested canola seed.

In 1998, the farmer planted over a thousand acres of his land with the seed he had saved from the previous year's crop. A hired Monsanto investigator analyzed samples of canola plants taken from Percy Schmeiser's land, and the company found evidence of its patented genes in the plant tissue. When Schmeiser refused to pay Monsanto fees for use of its patented herbicide resistance technology, technology he neither bought nor wanted, Monsanto sued him. According to a report on the trial ([www.percyschmeiser.com](http://www.percyschmeiser.com)), Monsanto sought damages for patent infringement totaling \$400,000. This included about \$250,000 in legal fees, \$13,500 for technology fees, \$25,000 in punitive damages and \$105,000 in the profits Schmeiser realized from sale of his contaminated 1998 crop.

Monsanto vs. Percy Schmeiser was heard in a Canadian court June 5 - 20, 2000. According to reports, Monsanto never directly tried to explain how their genes got into Schmeiser's field. In fact, the Western Producer, a Canadian agriculture magazine, quoted Monsanto attorney, Roger Hughes, as saying, "Whether Mr. Schmeiser knew of the matter or not matters not at all." In other words, Schmeiser's fields were contaminated by Monsanto's GM technology, and it didn't matter if Schmeiser was aware of the contamination or not. They were going to make him pay for it! Percy Schmeiser said, "It was a very frightening thing because they said it does not matter how it gets into a farmer's field; it's their property... if I would go to St. Louis (Monsanto headquarters) and contaminate their plots--destroy what they have worked on for 40 years--I think I would be put in jail and the key thrown away."

On March 29, 2001, nearly three years since the contaminated canola was discovered in Schmeiser's field, Canadian Judge W. Andrew MacKay agreed with Monsanto that it did not matter how its genes got onto Percy Schmeiser's fields; the farmer was still guilty of having them without having paid for the privilege. (You can read the entire decision at <http://www.fct-cf.gc.ca>). Sadly, as part of the damages, the farmer also lost 40 years of work improving his own canola seed line, as his crop was confiscated.

As you might imagine, the decision has had a chilling effect on farmers here and

around the world. The Washington Post reported that a National Farmers Union spokesman said the organization has been following the Monsanto vs. Schmeiser case "...with apprehension. We're extremely concerned by what liabilities may unfold for the farmer, particularly with cross-pollination of genetically modified plants." The National Farmers Union represents 300,000 U.S. farmers and ranchers. Monsanto has filed hundreds of similar patent infringement lawsuits against farmers in the U.S. and Canada. Some of those farmers in North Dakota and Illinois are counter-suing the company for deliberately causing genetic pollution and then suing its victims. Win or lose, many face financial ruin from the court battles alone.

The Percy Schmeiser case, and others ongoing and to come, do not bode well for farmers, or even backyard gardeners, here or abroad. The idea that individuals can be held legally and financially responsible for the fate of patented pollen and seed blown by the wind or carried by insects in open field conditions is simply absurd. In fact, Monsanto knows it and maintained that all a farmer has to do if he or she discovers Monsanto's patented plants growing on their land is to call the company and they will come out and take care of the problem.

For starters, how would a farmer even know his field had been contaminated with Roundup Ready GM canola? The plants are often visually indistinguishable. The only way he'd know is by spraying his crop with Monsanto's Roundup herbicide to see if it had resistance. Obviously, he wouldn't do that because the herbicide would kill his own non-resistant, non-GM crop! Percy Schmeiser and other farmers regularly spray Roundup around telephone poles surrounding their fields to keep them clear of crops and weeds.. When Schmeiser had sprayed around his telephone poles in 1997, he was surprised to see that some of the canola plants did not die. He suspected contamination.

If a farmer does identify GM plants in his field, according to Ann Clark of Plant Agriculture, University of Guelph, Guelph, Ontario, Monsanto would likely come out and spray the offending plants with the herbicide of choice, 2,4-D. But, as a farmer, would you call the company if their offending plants were interspersed with your own crop, the latter likely to be killed or damaged by the toxic herbicide? Such treatment would be especially catastrophic for an organic farmer whose field could no longer be certifiable as organic for years to come.

In fact, a group of Saskatchewan organic farmers is now suing Monsanto and Aventis because their fields are literally being invaded by GM canola plants making it impossible for them to sell their crops as non-genetically modified. The European Union strictly prohibits GM canola. Arnold Taylor, president of the Saskatchewan Organic Directorate, told CBC News Online, "Since (the companies) started five, six years ago, it has been virtually impossible to find any seed stock that's uncontaminated." For some perspective on the potential scope of the GM gene pollution problem, in the year 2000, Monsanto's GM seed was planted on 103 million acres worldwide, accounting for 94% of the global area sown to genetically modified seed (RAFI). The potential for the GM contamination of millions of more acres of land and for thousands more victim farmers is simply mind-boggling. In fact, in June, 2001, Canadian CBC radio reported that genetically engineered canola plants had spread across the Canadian prairies.. University of Manitoba plant scientist, Martin Entz said that GM canola had spread much more rapidly than originally thought and that it was "absolutely impossible to control."

Impossible to control also describes another 2001 GM debacle--the contamination of U.S. food supplies with StarLink corn, a GM corn intended by French parent company, Aventis, for animal consumption only. StarLink contains an insecticidal toxin, Cry9C protein, 50-100 times more than that in GM corn intended for humans. The protein had the potential to trigger severe allergic reactions. Aventis had assured EPA officials that StarLink would only be sold to farmers growing it for livestock. Dealers selling the corn would see to it that each farmer signed an agreement to provide a 660-foot buffer strip around his or her StarLink fields to prevent contamination of nearby cornfields with StarLink pollen. Grain elevators were also to be told at the time of sale that the corn was not for human consumption. Sadly, virtually every level of the program to protect humans failed miserably.

During the year 1998, 10,000 acres in the U.S. were planted to StarLink. In 1999, it had grown to 250,000 acres. By 2000, StarLink corn was planted on 350,000 acres in the U.S. and co-mingled with other corns by 2200 farmers in 12 states, according to Seed Savers Exchange. During 2000, 98 of Iowa's 99 counties grew StarLink! About 10% of all corn stored in the U.S. is now contaminated with StarLink corn.

In 2001, the USDA earmarked up to \$20 million of taxpayers' money, money originally intended for natural disaster relief for farmers, to help buy back 300,000 to 400,000 bags of contaminated seed. Containment, not control, was the only possible solution, as the damage to the U.S. seed stocks is permanent. The genes are "out there", replicating themselves in the chromosomes of other corn varieties meant for human consumption, and likely finding their way into any food containing corn products such as corn syrup and corn starch--nearly every sweetened, thickened product in the "modern" diet. If there is any reassuring news in this new reality, it is that the concentration of Cry9C is likely to be so low in current and future foods contaminated with the original StarLink genes that allergic reactions to this particular protein are highly improbable. That is, however, very small comfort given the scope and biological significance of this single genetic event.

August, 2001, was a particular low point in the battle for a ban on the Terminator gene technology. Terminator technologies use genetic engineering techniques to program a plant's DNA to kill its own embryos (suicide seed) thus forming sterile seed. The plant-to-seed-to-plant-to-seed, etc, cycle of life is broken, preventing a farmer from saving harvested seed to grow next season. It will ensure that farmers must return to the seed company year after year to purchase expensive seed, often with heavy GM seed technology licensing fees added. The first Terminator was created and announced by our own U.S. Department of Agriculture in partnership with a U.S.-based cotton seed company, Delta & Pine Land Company. They were granted a U.S. patent on the technology in 1998. (See June, 1998 Food Supply Update at [www.arkinstitute.com](http://www.arkinstitute.com)). In August, the USDA announced that it had agreed to license the technology to its corporate partner, the first step toward commercialization. Delta & Pine Land Co. has said it has e"USDA's decision to license Terminator flies in the face of international public opinion and betrays the public trust," said RAFI research-director, Hope Shand. "Terminator technology has been universally condemned by civil society; banned by international agricultural research institutes; censured by United Nations bodies...and yet the U.S. Government has officially sanctioned commercialization of the technology by licensing it to one of the world's largest seed companies."

Silvia Ribeiro, also of RAFI, added, "USDA's role in developing Terminator seeds is a disgraceful example of corporate welfare, involving a technology that is bad for farmers, dangerous for the environment, and disastrous for world food security."

The USDA and Delta & Pine Land Company, at last count, own three Terminator patents. This is an egregious use of U.S. taxpayers' dollars to support corporate profits instead of public good, to advance the portfolios of restrictive corporate patents on life instead of improving the lives and livelihoods of U.S. farmers and the consumers they serve. Terminator technologies will not be a boon to U.S. farmers or struggling Third World farmers who are considered prime targets for Terminator seeds. It will make them ever more dependent on the corporate seed and chemical companies.

Remember, once the genetic genie is out of the bottle, you can't put it back. If Terminator genes pollute surrounding fields and wild plants, the consequences will be far greater than the corn debacle. Neighboring farmer's crops may produce sterile seed.. What if that farmer is a seed grower, growing seed stocks for the country's next crops? Multiply that scenario by tens of thousands of farmers. Can Terminator eventually terminate all seeding plants? No one, not a single corporation or government official, can assure you it will not. Remember Percy Schmeiser! Remember StarLink!

Here is a rundown of Terminator patent holdings current to 2001: Syngenta (Novartis) has two Terminator patents. Syngenta (Zeneca) has four. Delta & Pine Land/USDA have three. BASF (ExSeed Genetics, LLC/Iowa State University) have one. DuPont (Pioneer Hi-Bred) has one. Pharmacia (Monsanto) have one. Cornell Research Foundation has one. Purdue Research Foundation (with support from USDA) has one.

It is important to take stock of where we have been in the big food picture in recent years because it speaks volumes about where we might be going this year and beyond. In light of the September attacks on the U.S., it is critical that we pay attention to every aspect of our food supply system with unprecedented vigilance. The truth about security with respect to food and terrorism is simple, really: there is none. The Schmeiser decision, StarLink tragedy and Terminators all point to a future in which individuals will have little or no control over the content of the food they eat, and little control over production. If individuals are discouraged by court decisions from feeding themselves--if they abdicate all rights to control the ways and means of livelihood and food production, turning control over, like serfs, to their corporate lords, then we are lost.

For years these Food Supply Updates have discussed the insanities of a food production system growing ever more concentrated, technology, oil and chemical dependent, biologically and chemically contaminated, remote from its nearly 300 million completely dependent consumers, and controlled, from seed to mouth, by a relative handful of very powerful people. The long list of cumulative observations and warnings voiced in this newsletter over the years (read earlier Food Supply Updates archived at [www.arkinstitute.com](http://www.arkinstitute.com)) could just as easily be viewed as an ongoing tutorial for those determined to ferret out our vulnerabilities. Our vulnerabilities can easily become someone else's opportunities.

We must keep one watchful eye on our current food supply security system, a "blanket" riddled with holes, and the other on the ongoing, ominous shift in the control of food from the farmer and consumer, to governments and a few very powerful, multinational corporations. How might our new agricultural technologies be used against us? Is Terminator gene technology a potential terrorist weapon? What is the relationship between "X" government with "Y" corporation? What is their global agenda? See what I mean? It is a daunting task, but more than ever, our lives may depend on it. Stay tuned... Geri Guidetti, The Ark Institute.







[Home](#) / Survival Garden Seeds

[My Account](#) | [Log In](#)

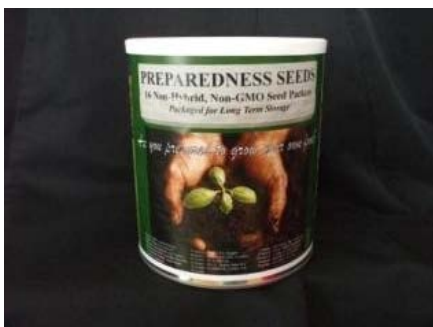
TESTED 28-FEB



Double click on above image to view full picture



MORE VIEWS

[Description](#)  
[Specifications](#)  
[Reviews](#)  
[Why Buy from Nitro-Pak?](#)

#### The Garden Can

The Preparedness Seeds Garden Vegetable Can provides a Missing link in your food storage plan. Each #10 can contains 16 popular varieties that will plant nearly 3/4 acre of garden!

These Seeds are Non-Hybrid, Non-GMO and are not chemically treated. Because they are non-hybrid, seeds may be harvested at the end of the growing season and then used for the next year's planting.

- 16 large seed packets sealed in a #10 can.
- Plants nearly 3/4 acre of Garden.
- Packaged for long term storage. Will keep up to 4 years if stored at 66 to 70 degrees and much longer if kept colder
- All Non-hybrid, open pollinated varieties
- Equivalent of more than 100 average size seed packets.
- Harvested seeds can be planted year after year.
- Packets are re-sealable for lasting protection.
- Complete planting instructions included.

\*Varieties Included:

SWEET CORN, Golden Bantam 5oz  
 ONION, Utah Sweet Spanish 10g  
 SPINACH, Bloomsdale Long Standing 10g  
 WINTER SQUASH, Waltham Butternut 10g  
 SQUASH ZUCCHINI, Black Beauty 10g  
 RADISH, Champion 10g  
 TOMATO, Rutgers 5g  
 SWISS CHARD, Lucullus 10g  
 PEA, Lincoln 10oz

## Survival Garden Seeds

Item #5600

[Email to a Friend](#)  
[Be the first to review this product](#)

Availability: In stock.

Suggested Retail: ~~\$56.99~~

Our Price: \$39.95

 Qty:  OR [Add to Wishlist](#)  
[Add to Compare](#)

#### Quick Overview

Each #10 size (5/6 of a gallon) contains a total of 16 - NON-HYBRID varieties of seed varieties

Share



Have a question?



You have no items in your shopping cart.

Sign up for our newsletter to receive upcoming sales and offers

Processing Time:  
 Most orders will ship in approximately:  
 1-3 business days

[Click Here for UPS Transit Time](#)

BEET, Detroit Dark Red 10g  
 CABBAGE, Golden Acre 10g  
 LETTUCE, Paris Island Cos 5g  
 CUCUMBER, Marketmore 76 10g  
 CARROT, Scarlet Nantes 10g  
 PEPPER, Yolo Wonder 5g  
 BUSH BEAN, Spike 5oz  
 \*Important – Because of the shortage of Non-Hybrid seed, substitutions may occur!

#### Shelf Life

There are some non-hybrid seed companies that make claims that the seeds will store for 20-100 years but this is only under optimal conditions with a decreased fertility rate over time. Preparedness Seeds claim that their seeds will keep AT LEAST 4-5 years on a shelf at 70 degrees and much longer if kept refrigerated or frozen.

Item Number: 5600  
 Ship Weight: 2.18 lbs.

## Write Your Own Review

You're reviewing: Survival Garden Seeds

How do you rate this product?\*

	1 star	2 stars	3 stars	4 stars	5 stars
Quality					

Nickname\*

Summary of Your Review\*

Review\*

## Why Buy From NITRO-PAK?

At Nitro-Pak, your order is PRIORITY #1. Upon ordering, you'll get an immediate "Order Confirmation", then an "Order Processing" update, and finally an "Order Shipping Confirmation" with shipping tracking#. See for yourself why THOUSANDS of customers each year rate us #1 in the industry. We want your business! Let us PROVE it!

### [Six Great Reasons to Buy From Nitro-Pak@:](#)

1. Lowest Prices...Guaranteed!
2. Every Product is Backed by Our UNMATCHED 120-Day 'No-Risk' Guarantee!
3. At Nitro-Pak, You're Always the Final Judge!
4. We STOCK 98.9% of Every Item We Sell (You'll get it faster)!
5. CARING Customer Service both BEFORE & AFTER the Sale!
6. Offering Only Tried and Proven Products You Can Depend On Since 1985.

[Read More Here](#)



We're ready to take your order!

*Simply add to the Shopping Cart Above*



## Product Tags

Add Your Tags:



Use spaces to separate tags. Use single quotes (') for phrases.



[About Us](#) | [Customer Service](#) | [Affiliates](#) | [Site Map](#) | [Search Terms](#) | [Advanced Search](#) | [Contact Us](#)

Help Us to Keep Magento Healthy - [Report All Bugs](#) (ver. 1.5.1.0) © 2009 Nitro-Pak.com. All Rights Reserved.



# Troubled Times

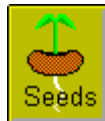

## Seeds Blum

---

### Seeds Blum

HC Idaho City Stage

Boise, ID 83706.

They have a terrific selection. Half the fun is just reading their catalog.



# Troubled Times

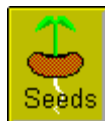

**J.L. Hudson**

---

A good source of non hybrid seeds can be bought cheaply from:

**J.L. Hudson**

Route 2, Box 337

La Honda, CA 94020

The catalogue is like an encyclopedia of plants and is one dollar. Hudson only sells open pollinated seeds so when you save seed at the end of the season you will be sure you can grow the same variety next season. Hybrid seed is useless for this.

Offered by [Valerie](#).





MEMBER LOGIN

[Forgot my Password?](#)

SEARCH

MEMBERS AREA    EVENTS    PIX    GARDENS    CLUBS    KIDS CORNER    ARTICLES    BOOKS    SUPPLIERS    LINKS    HELP

FEBRUARY 19, 2012 - [GARDEN POLL](#)



**DONNA DAWSON**  
MASTER GARDENER

[twitter](#)    [Linked in](#)

CHECK OUT  
DONNA'S BLOGS AT  
[ACCUWEATHER.COM](#)

**CONTESTS CONTESTS**

Watch for our next  
new Contest

[SIGN UP HERE](#)

AdChoices

[Gardening Vegetables](#)  
Grow a Garden  
That is Good to  
Eat & Tastier to  
Enjoy at  
Miracle-Gro®.  
[www.Scotts.com](http://www.Scotts.com)



THIS WEEK'S ARTICLES

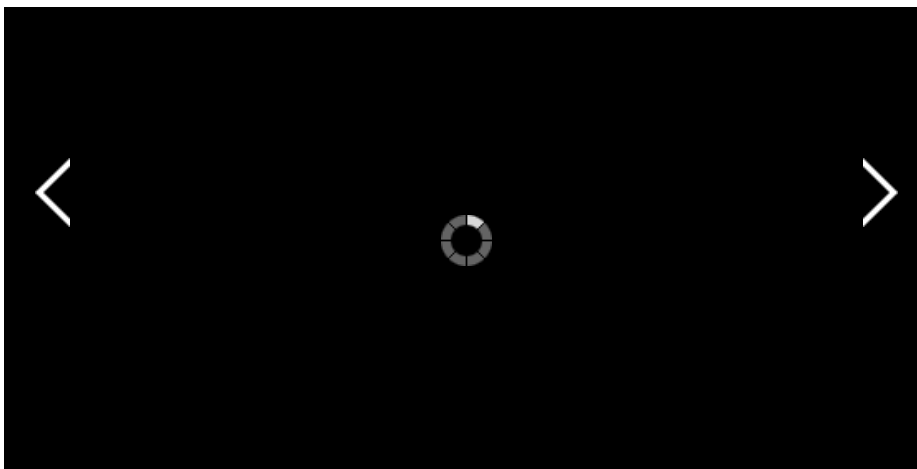

"To Plant a Garden is to Believe in Tomorrow"

Garden Destinations - where you can not only read about public and private gardens all over the world, but you can enter your own favourites for us all to know about and enjoy. Click on the Gardens button in the black bar to go to the area and start entering your favourites! The big banners all take you to various areas as well so check those out too.

Are you a novice gardener who needs the wisdom of experience or are you a seasoned gardener who would like to keep up with the latest in gardening trends. No matter where you fit you will feel welcomed here and grow. Since 1996 we have showcased many wonderful writers who have a wealth of information to share. Each Sunday I put up a batch of new articles but there are thousands more here to enjoy and learn from. Start by clicking on our Articles button in the Black Bar to be taken to over 8,100 articles from gardeners all over the world AND if you have written an article that you would like to share with us, please send along to my email address.

**Today's Newsbite**

Spent a wonderful evening last night with friends. Geri made shrimp in lobster sauce and chicken with black bean sauce...as delicious as you can imagine. It actually rained yesterday! This is our dry season so rain is very welcome, especially for the plants. You would think in a tropical country that all is green all the time, but here in Panama it depends on where you live. On the Caribbean side it does rain during the dry season but here on the Pacific side where we live we can go months without rain. Grass goes brown just like it does in Victoria during the summer. Tom is in Victoria right now enjoying days of rain and not liking it one bit because it is a cold rain.

We head off on a holiday soon. What does a tour operator do for a holiday? she takes a cruise and we are both looking forward to that because the day after we get home, I head to India on my tour. So looking forward to seeing the Taj Mahal again. Be sure to check the tours site as it has just been updated with new and exciting information and the 2013 tours are up as well! I ALSO have one lady wanting to share a room on my South Africa Tour and one lady wanting to share on the Floriade Tour! Our Garden Tours Site is where you will find our very latest tour offerings. China 2013, Ecuador 2013, Argentina 2013 and Paris/Chelsea 2013 are all up. I am just doing short versions of the tours right now but there is enough there for you to see and the registration form is there as well for each tour. Since 1998 I have welcomed both new and repeat guests. There is much more there so please visit [www.gardeningtours.com](http://www.gardeningtours.com)

If you signed up for the newsletter and you did not receive it we might have your email wrong - take a moment to check your membership information. [Click here to check your email](#) and other contact information - if you can't remember your password, don't worry, [click here and put in your email address](#) and we will send you your password. If all else fails, [email us](#) and we will find your login information for you.

My latest AccuWeather.com articles are put up each week on their site so make sure you click on the banner underneath my picture here to take you to them. WorldReviewer.com has lots of reviews I have done - check out <http://www.worldreviewer.com/member/donnadawson/>



If you have gardening questions, please send them along to Art Drysdale, his email is listed with all his articles and look for weekly articles answering those questions plus much more. There are many other excellent ways to get your answers. [Search the thousands of articles](#) written on gardening subjects, or use the forum [Gardeners Forum](#)

NEW GARDEN POLL Right next to the date you will see Garden Poll ... click on that and tell us how you feel. It is very seasonal so make sure you tell us soon.

**We have two other sites that might also be of interest to you.** Here is the website link to our [tours only gardening website!](#)

Our Panama site is at [WhyPanama.net](#) Moving to a tropical country from Zone 3a in Alberta was sure some kind of adjustment, but one that we are so thankful we did. It has opened up a whole new world of plant material and article opportunities for me.

**Alberta Gardener, Manitoba Gardener, Ontario Gardener**  
They're about gardening where you live!  
[Click here to subscribe](#)

*"We are visitors on this planet. We are here for ninety or one hundred years at the very most. During this period, we must try to do something good, something useful, with our lives. If you contribute to other people's happiness, you will find the true goal, the true meaning of life."*  
H.H. The 14th Dalai Lama

**If you'd like to receive my monthly ICanGarden newsletter please fill in your information [in the members area](#)**

[MAKE ICANGARDEN YOUR HOME PAGE](#)

LATEST DISCUSSION

[Harlequin Marigold \(2\)](#)

[Looking for Brant grape cuttings \(3\)](#)

[White Strawberry \(1\)](#)

[Wheat seeds \(1\)](#)

[Gargoyle Garden Statues \(1\)](#)

[MORE](#)

AdChoices

**Swan Landscaping**  
We Design with the Future in Mind. Sign up for your free estimate.  
[www.swanlandscapin...](#)

[ABOUT US](#)   [MEMBER LOGIN](#)   [PRIVACY POLICY](#)

COPYRIGHT 2012





## Ready Reserve Foods

### Long Shelf Life

### Garden Seeds

This is an assortment of seventeen varieties of garden seeds packaged in a #2-1/2 double enameled can and nitrogen flushed for a long shelf life. One can plants a garden approximately 65' x 124'. All seeds are non-hybrid except the corn.

It includes:

- Green Beans - Kentucky Wonder
- Beets - Detroit Dark Red
- Broccoli - Waltham 29
- Cabbage - Copenhagen Market
- Cantaloupe - Hales Best
- Carrot - Chantenay Red Core
- Corn - Jubilee Sweet (only hybrid variety)
- Cucumber - Burpless
- Lettuce - Bibb
- Onion - Walla Walla
- Peas - Wando
- Bell Pepper - Jupiter
- Spinach - Bloomsdale
- Winter Squash - Table Queen
- Summer Squash - Zucchini Black Beauty
- Tomato - Rutgers
- Watermelon - Sugar Baby

Q: How long are the Ready Reserve seeds good for?

A: Like the food systems, the seeds should be kept relatively cool and dry. If so maintained, they should have at least a 90% sprout rate after 8 to 10 years, dropping to about a 50% sprout rate after 15 years.

**Stock #RR-GS1 .....** [Click here for prices or to order.](#) \*

The units in our stock were packaged in 1998

---

#### Related Information:

Ready Reserve [Sprouting Kit](#)

[Ready Reserve Foods](#)- long shelf life food

[AlpineAire](#) - shelf stable food

[MRE Information](#) Page

[Survival Tabs](#) Emergency Food Rations

Newsletter article: [An Emergency/Survival Food Primer](#)

---

[[B&A Page](#)] [[Catalog](#)] [[Preparedness](#)] [[New Products](#)] [[\\* Order Info](#)]  
[[BA-Industrial.com](#)] [[FirstResponderSupplies.com](#)] [[BA-Electronics.com](#)]

Use the **BACK button** on your browser to return.





Original date: September 5, 1997.

Last updated: Sept 14, 2002

© [Copyright](#) 1997-2002



## MENU ▾

### [Home](#)

(Denali Seed)

### [Introduction](#)

- [Arctic and Subarctic Growing Conditions](#)
- [Specialized Seed Varieties](#)
- [O-S Cross Cabbage](#)

### [Seed Offered](#)

- [Packet Annual Flowers](#)
- [Packet Perennial Flowers](#)
- [Packet Herbs](#)
- [Packet Vegetables](#)

### [Seed List](#)

### [Order Seed](#)

- [ONLINE](#)

### [Gardening Articles](#)

- [Advantages of Growing from Seed](#)
- [Growing Tips for the Far North](#)
- [Spice up Your Life](#)
- [Maintaining a Beautiful Lawn in Alaska](#)
- [Preparing a Garden on Permafrost](#)
- [Planting depths in Cold Climates](#)
- [Controlling Root Maggots](#)
- [Starting Cole Crops Indoors](#)
- [Fireplace Wood Ashes have a Place in the Garden](#)



## MENU ▾

### [Home](#)

(Denali Seed)

### [Introduction](#)

- [Arctic and Subarctic Growing Conditions](#)
- [Specialized Seed Varieties](#)
- [O-S Cross Cabbage](#)

### [Seed Offered](#)

- [Packet Annual Flowers](#)
- [Packet Perennial Flowers](#)
- [Packet Herbs](#)
- [Packet Vegetables](#)

### [Seed List](#)

### [Order Seed](#)

- [ONLINE](#)

### [Gardening Articles](#)

- [Advantages of Growing from Seed](#)
- [Growing Tips for the Far North](#)
- [Spice up Your Life](#)
- [Maintaining a Beautiful Lawn in Alaska](#)
- [Preparing a Garden on Permafrost](#)
- [Planting depths in Cold Climates](#)
- [Controlling](#)

# Welcome to Alaska!

"Denali Seed Company, an Alaskan company, has been in Anchorage since 1977 supplying far north gardeners with farm fresh, quality garden seed. Denali seed varieties have been field tested in Alaska and are proven performers in arctic and sub-arctic growing conditions."



Anchorage, in "*the land of the midnight sun*," is the home of **Denali Seed Company**, the only seed company in North America that specializes in seed for heirloom, open-pollinated and hybrid varieties proven to excel in [arctic and sub-arctic growing conditions](#). Our [seed list](#) is made up of [annual](#), [biennial](#) and [perennial](#) flowers, [herb](#) and [vegetable varieties](#) field tested in Alaska to assure they will perform exceptionally well in cool, short-season areas. Denali garden seed is available at our [ONLINE](#) store [www.bestcoolseeds.com](http://www.bestcoolseeds.com). EVERY seed purchase is eligible for [FREE packets of Denali Seed](#) that are chosen by the customer.

## Denali Seed Company Sells Seed for:

- [Annual Flowers that Excel in Cool climates](#)
- [Alaska Hardy Perennial Flowers](#)
- [Window Box Herbs](#)

[You Forgot the Greens](#)

[Alaska Gardners](#)

## Resort Info

[Whispering Surf Camping Resort](#)

[Root Maggots](#)

[Starting Cole Crops Indoors](#)

[Fireplace Wood](#)

[Ashes have a](#)

[Place in the](#)

[Garden](#)

[You Forgot the Greens](#)

[Alaska Gardners](#)

## Resort Info

[Whispering Surf Camping Resort](#)

### ▪ [Short season, Cold Tolerant, Vegetable Varieties](#)

Denali Seed sells seed for the world famous giant [O-S Cross Cabbage](#), a show-stopper that often exceeds 70 pounds when grown during Alaska's long summer days.

To assure gardeners will be happy with our seed, we offer a [SATISFACTION GUARANTEE!](#)

Denali Seed Company sells seed for open-pollinated, heirloom, and hybrid seed varieties that are grown either by organic or traditional methods. All certified [organic seed](#) sold is identified as such in our seed list and is grown by organic methods. Denali Seed Company does not sell seed for genetically engineered organisms often referred to as GMO's.

Our seed list includes open-pollinated, heirloom and hybrid varieties. What does this mean? **Open-Pollinated** varieties are varieties where both the male and female parents are the same variety and usually the male and female parts of the blossom are on the same plant which in turn cross pollinate to produce seed naturally. **Heirloom** varieties are favorite open-pollinated varieties that have been grown by gardeners for a very long time, usually for over a hundred years. Seed collected from heirloom and other open-pollinated varieties produce plants nearly identical to the parent plants. **Hybrid** varieties, unlike open-pollinated varieties, are produced from a cross between two different parent varieties. One variety is the male plant and the other variety the female plant which cross pollinate by natural means to produce seed. Plants from the seed produced from this cross exhibit the best characteristics of both parent varieties. The hybrid variety is more vigorous than either parent variety and has traits that make it superior to the parent varieties. The seed produced on a hybrid plant will not grow plants identical to the hybrid plant, therefore the seed is not usually saved.

We hope this information will help you select the seed varieties best suited to your needs.

Take a tour of our website to learn more about what we offer northern gardeners, view our home city of [Anchorage](#),

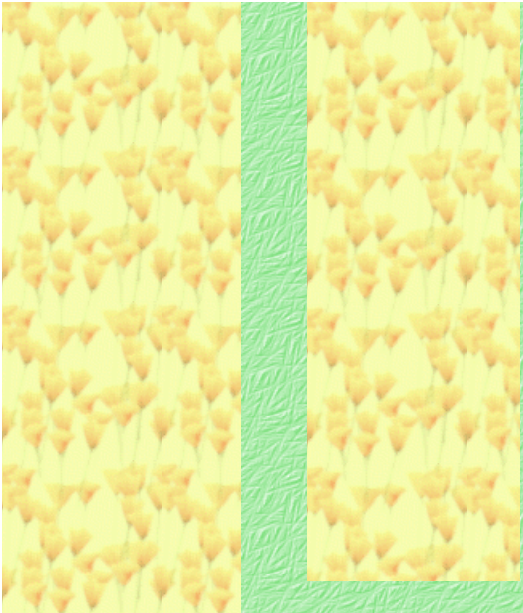

and benefit from our 30 plus years experience in providing [northern gardeners](#) with the finest garden seed available. Our veteran arctic horticulturist wrote "[growing tips](#)" to help gardeners excel when growing in cool areas, in cold soils and during long summer days.

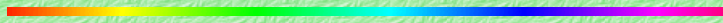

For more information feel free to email us at [seeds@denaliseed.com](mailto:seeds@denaliseed.com)



Phone: (907) 344-0347  
Office: 12101 Division Street, Anchorage, AK 99515

**SEEDS of CHANGE.**



100% CERTIFIED ORGANIC

*goodness from the ground up®*

SEEDS & SUPPLIES

Seeds

Live Plants

Tools & Supplies

INFORMATION

Urban Gardening

Four Season Growing

Gardening How-To

About Us

SERVICES

Donation Program

Resources

Seeds of Change Food

1 2 3

20% OFF  
TOMATO SEEDS

Choose between Beefsteak, Cherry, San Marzano & many more varieties.

Regular \$3.49 now \$2.79 thru 3/31/12

BUY NOW ▶



SEARCH

Entire Site

SEARCH ▶

HOW TO ORDER

[Order Seeds Online](#)  
[Catalog Quick Order](#)  
[Contact Us](#)

STORE LOCATOR

Enter Your Zip Code

Select a Range

10 miles

SUBMIT ▶

FOLLOW US ON



Always certified organic



Why Organic?

The fresh-picked flavor and nutrition as nature intended

LEARN MORE ▶



Seed to Plate

Recipes to enjoy the fruits of your labor

LEARN MORE ▶



Growing Communities

Meet some of our gardening partners

LEARN MORE ▶

Supporting Sustainable Organic Agriculture Since 1989

In 1989, Seeds of Change began with a simple mission: to preserve biodiversity and promote sustainable, organic agriculture. By cultivating and sharing an extensive range of organically grown vegetable, flower, herb and cover crop seeds, we have honored that mission for almost 25 years.

PRODUCTS

Vegetable Seed  
Flower Seed  
Herb Seed  
Cover Crops  
Trees  
Seedlings  
Tools & Supplies

GROWING TIPS

Gardening Information  
Glossary of Terms  
Succession Planting  
Cover Cropping  
Seed Saving  
Zone Chart  
Planting Guide  
Resources  
Biodiversity  
Sustainability

CUSTOMER SERVICE

FAQs  
Customer Service  
Contact Us  
Download a Catalog  
Guarantee  
Save Seed Pledge  
Organic Certification



# Troubled Times

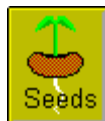

## Sources

---

There is a seed saving network where you can get heirloom (non-hybrid) seeds around the U.S. I don't have the address handy, but if you search for seed saving on the net you should pick it up.

Offered by [Mike G.](#)

No discussion of saving seed would be complete without mention of Kent Whealy's Seed Savers Exchange, a wonderful grassroots network of gardeners who keep and trade seeds of homegrown vegetable varieties. Kent started the exchange soon after his wife's grandfather died. The old man had recently given the young couple seeds for tomatoes, beans and morning-glories that his forebears had saved since emigrating from Bavaria four generations before. Realizing how close his family had come to losing this unique legacy, Whealy wondered how many more heirloom varieties were in an equally precarious position.

The Seed Savers Exchange Kent organized to help preserve such heirlooms works on two levels. "Non listed members" can buy the two annual publications for \$12, then order seed from members for \$1 per sample. "Listed members" (those who offer vegetable seed for trade) can get seed free from other members by sending postage with their requests.

### **Seed Savers Exchange**

R.R. 3, Box 239,  
Decorah, IA 52101

For non-hybrid seeds, check:

- **The Cook's Garden** (800) 457-9703 in Vermont has many heirloom varieties
- **Burpee** (800) 888-1447
- **Ferry-Morse** (800) 283-6400
- **Harris** (800) 514-4441
- **Johnny's** (207) 437-4301
- **Nichols** (541) 928-9280
- **Park Seed**, in South Carolina (864) 223-7333
- **Shepherd** (860) 482-3638
- **Wayside Gardens** (800) 845-1124 has plants, perennials, shrubs, etc.
- **Yung Seed Co.** (800) 247-5864



# Troubled Times



## TEAM: Seed

---

The Seed TEAM is looking for [Growers](#) to grow seeds in their [Seed List](#) of non-hybrid seeds for distribution among the growing membership of Troubled Times. [Shortages](#) of non-hybrid seeds are occurring. Planting, growing, and seed gathering tips have been gathered for [Asparagus](#), [Beans](#), [Beets](#), [Broccoli](#), [Cabbage](#), [Carrots](#), [Corn](#), [Cucumbers](#), [Eggplant](#), [Herbs](#), [Lettuce](#), [Melons](#), [Okra](#), [Onions](#), [Peanuts](#), [Peas](#), [Peppers](#), [Potatoes](#), [Pumpkin](#), [Radish](#), [Spinach](#), [Squash](#), [Tomato](#), and [Wheat](#). Here are tips for preparing seeds for [Storage](#) and separating [Seed/Pulp](#), storing biennials in a [Root Cellar](#) and getting an [Early Start](#) with [Grow Lights](#). [The Arc Institute's](#) selection of non-hybrid seed has formed the base for the Seed TEAM, which was expanded during 1999 due to the Troubled Times, Inc. nonprofit by a contributor designating funds for the Seed TEAM, and during 2000 with dedicated seed gardens.

- [During 1998](#), 18 growers grew seed from the [Original List](#).
- [During 1999](#), 28 growers grew seed from an expanded [1999 List](#).
- [During 2000](#), dedicated gardens began with an expanded [2000 List](#).
- By the end of 2001, the [2001 List](#) had grown.

For those wanting to participate, contact [Roger](#).



# Troubled Times

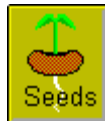

## Saving Seeds

---

A bit more on saving seed from [You Grow Girl](#) site.

### Harvesting and Saving Your Seeds

There are a variety of reasons for harvesting your own seeds; some personal, some environmental. Perhaps you have a variety that you like and you are concerned that seed companies may discontinue stocking it. You saw some wildflowers while on an outdoor hike that you'd like to grow in your own garden. You have a heritage variety and you want to continue growing it in future years. You want to trade some of your seeds with some of a friend's seeds, you want to grow organic seeds, or maybe you just want to save money and avoid buying new annuals next year. Whatever the reason, you don't need to be a botanist or a farmer to do it. If you can grow plants, you can produce your own seeds. There are however, a few things you may want to know before you get started.



# Troubled Times

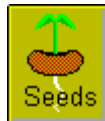

## Pollinating

---

A bit more on saving seed from [You Grow Girl](#) site.

### **Self-pollination and Cross-pollination**

Plants either have all the parts to pollinate themselves, (called self-pollinators) or they are aided in accomplishing this by insects, the wind, or human intervention (cross-pollinators). Self-pollinators are commonly referred to as 'perfect flowers' as they contain all the parts to successfully pollinate themselves. The comparatively imperfect cross-pollinators produce all the parts to pollinate, but not all in one place. Parts are divided between blooms or are 'self-incompatible', identifying their own pollen as foreign material. Pollen must find its way from one plant to the next. This method is preferable for the survival of the species because it ensures that the plants produce genetically diverse seeds - seeds that contain different genetic information or traits than the original plant. This enables the plant to better adapt itself to the environment it is in, or acquire traits that will help it become more disease resistant. Self-pollinators on the other hand, essentially produce clones, which makes them more susceptible to any problems that may arise.

Be aware that if you want cross-pollination to occur in your garden, you need to make your garden favorable to pollinating insects or be prepared to do all the pollinating yourself. Grow plants nearby that attract pollinators - butterfly bush, Queen Anne's lace, bee balm, salvia, and cleome are a few, and avoid using chemical sprays that will kill all insects both harmful and beneficial. In some cases you might want to keep cross-pollination from taking place. Plants that are closely related, for example different varieties of melons, will cross-pollinate producing seeds that are a mix of the two varieties. If you want to keep your varieties true, plant similar species of plants on opposite ends of your garden.



# Troubled Times

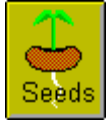

## Types of Seed

---

A bit more on saving seed from [You Grow Girl](#) site.

### **Open-pollinated, Heirloom and Hybrid**

Before you decide to save the seeds from a particular plant you will need to know whether they are Open-pollinated, Heirloom or Hybrid. Open-pollinated plants are those pollinated--naturally or through human intervention--by the same species of plant. Heirlooms are older plant varieties that have maintained relatively unchanged in a particular region for several generations, and all are open-pollinated. Hybrids are plants that have been cross-pollinated using two different species of the same genus of plant. They are bred professionally under controlled conditions, to produce certain desirable traits. Grocery store produce is usually hybridized and often bred for mass production or large-scale farming. Many of the characteristics that are bred into these plants, such as thick skins for transport, or high water content for size, are not desirable for small-scale gardening. This is one reason why you may not want to save seeds from store bought produce. Seed packaged for the home gardener by seed companies may also be hybridized. These plants are bred to contain traits that are desirable to the small scale gardener such as colour and taste. However, seeds produced by these hybrids doesn't guarantee that those desirable traits will be carried over to the next generation. In most cases the such traits may actually disappear entirely after a few generations. Or the seeds may be sterile and won't produce fruit anyway. Either way, growing seeds from hybrids is a gamble. Checking the seed packet or catalogue of the grower is one way to find out whether seed are hybrids. Packets will often say F1 to indicate hybrids or OP to indicate open-pollinated.



# Troubled Times

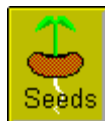

## Harvesting Seeds

---

A bit more on saving seed from [You Grow Girl](#) site.

### Harvesting Seeds

If this will be your first time saving seeds, start out with some easy plants that flawlessly produce seeds without any intervention. Annuals such as cosmos, marigolds, pansies, corn flowers and many others are some of the easiest. Collect seeds from the highest quality and healthiest plants. A good specimen is disease and pest free, has bright foliage and flowers, and grows vigorously. Under usual circumstances snipping flower heads off after they are spent (deadheading) is crucial to encouraging a plant to continue producing new flowers. To save seed, leave the flowers on the stem after the flower dies off instead. That way, the plant will start putting its resources into producing seed instead of new flowers.

Before long a seedpod will replace the spent flower. Don't remove the seed head right away: leave it on the stems as long as possible, letting it ripen within the pod. Seeds are generally ready when the pod turns brown, dries out or cracks open. If you notice that the seed pod is prone to cracking open on it's own (snapdragons, violas, pansies), attach a lunch-sized paper bag around it using an elastic or string, catching the seeds as they fall. When the seeds are fully ripe, cut the stem at the base of the plant and shake the seed head inside the bag to dislodge the seeds from the casing. If some seeds are lost to the soil they will come up on their own next year. This is called self-seeding, and many annuals reproduce themselves this way.

If the seed heads are not fully dry and ripe when you cut them off, either hang the stems (with the seed cases) or lay them flat to dry on a newspaper or paper towel pad away from direct light. Make sure that all seeds are completely dry before removing them from the pods: if you package them before they are fully dry they will go moldy in storage. This is the simplest way; it's easier to dry the whole seed head than a bunch of loose seeds. When the pod is dry, extract the seeds by carefully crushing or breaking open the seedpods. Separate crushed debris from the seeds by sifting everything through a fine mesh screen. The debris will fall through and the seeds will remain on top of the screen. Some seeds such as those from marigolds or black-eyed susans can simply be pulled from the seed head.

Seeds from fruits and vegetables should be collected when plants are at their peak, before they are over-ripe and decay has set in. Some vegetables such as beans are the exception and should be harvested when the pods are dry. Seeds from most fruits and vegetables are incased inside a wet environment (the part usually eaten). In the case of very wet pulp such as tomatoes, the seeds can be washed from the pulp and then laid out to dry on newspaper or a screen. The same can be done with pumpkins, squash and other soft pulp vegetables. In the case of harder pulp fruits and vegetables they are simply opened up and the seeds removed manually.



# Troubled Times

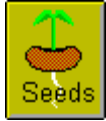

## Storing Seeds

---

A bit more on saving seed from [You Grow Girl](#) site.

### Storing Seeds

The best way to store seeds is to package them in paper envelopes or bags since they allow for good air circulation and don't sweat. However, any container will do, keeping in mind that humidity and lack of air circulation will cause mold, disease and prompt seeds to germinate prematurely. Film canisters for one aren't recommended as the plastic promotes humidity and stagnant air. The temperature should be cool to make longer storage possible-refrigerator storage will work if you can't find a naturally cool place. Be sure to write the date, name of plant and any growing instructions you are aware of on the envelope or package. This will come in handy when using the seeds a year or more later, and will be appreciated if you give the seeds to someone else. It's worth it (but not necessary) to put a bit of extra effort into the packaging if the seeds are to be given away. Use specialty papers for the envelopes or create fancy labels to mark them. Some envelope and label templates are provided here for you to print out on any paper (or sticker paper for labels that is compatible with your printer type).

Store seeds carefully by placing envelopes inside large glass jars with a bag of silica or powdered milk. These products absorb excess moisture. Reuse the tiny bags of silica gel that come inside new shoes--dry them for a few minutes at a very low temperature in your oven. Alternatively, make a tiny package of powdered milk by pouring a pile into the center of a piece of breathable fabric or tissue paper. Pull the corners together and close it up with a piece of string or elastic to create a sachet. The best jars for storage are wide mouth mason jars used for canning. They have the proper airtight seal that is essential for long term storage. If you store the jars in a cool, dark place the seeds should last from a year to a few years, depending on the type.



# Troubled Times

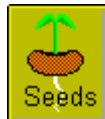

## Testing Seeds

---

A bit more on saving seed from [You Grow Girl](#) site.

### Testing Your Seeds

If you are saving your seeds for extended periods of time, test the seeds before you use them to see if they will still germinate. This is easily done by placing 20 or so seeds (depending on size) onto a half-piece of damp paper towel. Fold it over so that the seeds are covered. Then place it in a plastic baggy with a few pinholes punched into it and set it aside in a dark, warm place. Bear in mind that some seeds need light to germinate and some have other specific requirements-some may need to be soaked first, or may require a certain temperature for germination. Knowing your seeds will help you in this process: however most seeds will do fine with the standard procedure. After a week check to see how many seeds have germinated. Again some seeds will have a longer germination period than others, so if they haven't germinated by week's end, wait another week to be certain. If a fair number of seeds have germinated then the seeds are good and can be used with little trouble. If few seeds germinate, increase the number of seeds sown per inch or don't bother using them at all.



# Troubled Times

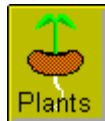

## Biennial

---

Carrots are bi-annual, so collect the roots this year, keep them in sand over the winter and then replant them in the spring. Then they will go to seed.

Offered by [Gus](#).

*Mother Earth News*, Sep/Oct 78

### **Annuals or Biennials?**

The first thing you must know about each vegetable you wish to grow for seed is whether it is an annual biennial or perennial ... because each type requires slightly different treatment. (Since perennial vegetables - such as asparagus artichokes and rhubarb - are long-lived produce seed for many years running and - in any case - are best propagated from cuttings ... they will not be discussed any further in this article.)

Annuals include such popular garden vegetables as peas, beans, tomatoes, lettuce, melons, squash, corn and spinach. They are the easiest types of plants to grow for seed because they mature in a single year. You just sow one generation of seeds in the spring ... and harvest the next in the fall.

Biennial vegetables - such as carrots, onions, celery, cabbage, turnips, and beets - are a little tougher. They take two years to produce seed and therefore (in many parts of North America) must somehow be "stored over" during the winter. Root cellars, cool basements and pantries, and even covered pits dug deep in the ground will all do this job nicely for most crops. Then after the danger of heavy spring frosts has passed you can replant the vegetables in your garden. If you live in a section of the country where winters are mild (coastal California for example) you can just leave them in the soil to begin with ... protected perhaps during occasional cold spells by heavy mulches and/or makeshift shelters. Most biennials will produce seed in the summer of their second year.



# Troubled Times



## Asparagus

### The Arc Institute

Asparagus beds will be productive for 20 years or more. They cannot be harvested until the second year. The male plants produce asparagus spears, but both male and female plants are needed to produce seed. Plant 18" apart, in rows 4-5' apart.

Asparagus needs a dormant period (overwintering) to complete their cycle. They need constant and cold temperatures. The usual method is to allow the seedlings to go dormant and then place them in a one foot deep hole with only a few inches of soil covering their crowns. More soil is added once they sprout up in the Spring.

Asparagus doesn't mind a hard soil freeze. If you want to be sure they will be OK, you can mulch them ahead of the freeze once they have died back completely.

Another point about asparagus: they tend to give out after 20 years and then require replanting. If you are growing both male and female plants, you will never have to worry about replanting, instead you will have asparagus everywhere! Most gardeners grow only males. Asparagus can be propagated by division and this division can help to overcome their 20 year limit. Just dig up the crowns once they die back in the fall and carefully break them into a few divisions (like flower bulbs, etc.) and replant. Propagation in this way eliminates the two year wait for good viable eating stalks. Also the males tend to have thicker stalks and one can harvest stalks from males longer than the females. After awhile the stalks get thinner and fewer and you have to stop picking them lest you kill off the plant!.

Offered by [Roger](#).





# Troubled Times

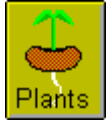

## Cabbage

*Mother Earth News*, Sep/Oct 1987

### **The Easiest Seed-Saving Crops**

By Nancy Bubel



Cabbage, cauliflower, Brussels sprouts, broccoli, collards, kohlrabi and kale cross with each other and with turnips, rutabagas, radishes and horseradish. (Chinese cabbage and mustard greens won't cross with their leaf- and heading-cabbage kin but in cross with each other and the root-crop crucifers.) You need to keep flowering seed crops 200 feet apart or, if space is limited, intersperse rows of sunflowers or other tall plants with the crucifer seed rows to deter pollinating insects. Remember, too, that most crucifer seeds stay viable for as long as five years under good storage conditions, so you can save seed of one or two varieties each year and keep rotating them.

Excepting broccoli (an annual), all crucifers are biennials - they have to make it through one winter before they'll produce seed. Kale and Brussels sprouts are the easiest biennial family members for seed saving, because these hardy plants can over winter in the garden even in cold areas. They'll then send up their seed stalks the following spring. Most of the other biennials need to be dug up - roots and all - stored in a root cellar and planted out again the following spring. (In some regions, you may be able to over winter them under mulch or in covered trenches.) Many growers make an inch-deep vertical cut in replanted cabbage heads to help free the plant's growing point. The tall seed stalks that emerge sometimes need to be staked to prevent breaking.

Probably the trickiest member of this family to save seed from is cauliflower, because it doesn't keep well either in the ground or in root cellars. Often the best way to treat it is to start plants in early fall and over winter them in a cold frame.

### **The Arc Institute**

Two crops [of Broccoli] per year can be planted, early spring and mid-summer. Plant 1/4" deep, 18" apart, in rows 2 1/2' apart. Harvesting for food, pick the heads before the tiny buds open into yellow flowers. Cabbage worms and root maggots can be a problem.

Cabbage can take cold weather, and two crops can be harvested per year. The later crop can be stored in a cool cellar and will last through the winter. Plant 1/2" deep, rows 2 1/2' apart, and depending upon type, place plants in rows 12" to 2 1/2' apart. Seedlings can be started early and then transplanted. Do not over water when heads are firm or they may split open.



# Troubled Times

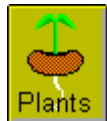

## Potatoes

---

When the plants flower and go to seed, those berries are actually potato seeds and you can plant them to grow more potato plants.

Offered by [Gus](#).



G.I. Bernard

# Troubled Times

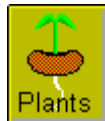

## Root Vegetables

---

*Mother Earth News*, Sep/Oct 1987

### **The Easiest Seed-Saving Crops**

By Nancy Bubel

Like the cabbage clan, all root crops (except annual radishes) send up seed stalks in their second spring. Unless you live in a mild-winter area where root vegetables will not freeze if left in the ground under mulch, you'll have to winter your beets, carrots, winter radishes and onions in a cool, damp root cellar and replant the best ones the next spring. (On the other hand, if you live in a very warm climate, you may need to chill your root crops for a couple of weeks in a refrigerator to convince them to go to seed.)

As the exception to this rule, parsnips are the easiest root vegetable for seed saving. They're so hardy, you don't need to dig them up. Here in south-central Pennsylvania, I leave parsnips in the ground under mulch all winter, dig some for spring eating till around the end of April and then give in to their seed-forming intentions. The tall, coarse-lace flowers are cross-pollinated by insects, and dry seed is ready around the end of July. Two plants will produce all the seed you need unless you plan a parsnip plantation.



# Troubled Times



## Radishes

---

*Mother Earth News*, Sep/Oct 1987

### **The Easiest Seed-Saving Crops**

By Nancy Bubel

Most radishes are another exception because spring sown plants will produce seed pods by summer. Let the pods dry on the plant, but pick them before they split and scatter the seed. Such biennial radishes as Japanese daikon and China rose should be over wintered in a root cellar and replanted 12 inches apart in spring. They'll produce seed by early summer.

### **The Arc Institute**

Mature quickly and can be planted between rows of carrots or parsley to keep the soil moist. Not high in nutrients. Plant seeds 1" apart in rows 18" apart, in soil that is cool and moist rather than hot and dry.



# Troubled Times

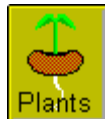

## Beets

*Mother Earth News*, Sep/Oct 1987

### **The Easiest Seed-Saving Crops**

By Nancy Bubel

The dusty-fine pollen of beets (like that of spinach) can be carried a mile away by the wind. Garden beets will also cross with sugar beets and with Swiss chard, so keep your seed beets isolated from other blooming relations (or grow Swiss chard and beets in alternate years). Plant your firmest, shapeliest cellar-saved roots about 18 inches apart in spring. Six to eight of these will produce plenty of seed for a family garden by summer.



### **The Arc Institute**

Beets like alkaline soil, not acid. Each seed is really a seed pod containing several, so 3-5 plants emerge and should be thinned to the single strongest plant. Two crops per year can be planted, early spring and mid-summer. Plant 1/2" deep, 3" apart, rows 2' apart.

Seed from Sugar beets would be the same as from regular beets. They are biennial so you won't see any the first season. Keep several of small to moderate size over winter and replant (bury) the following Spring. They should quickly go to seed. They will grow a tall, branched stalk loaded with tiny flowers. When they are matured, cut them to ground and hang upside down to dry. You can strip the seed from the stalks by hand and winnow out the chaff.

Offered by [Roger](#).



# Troubled Times

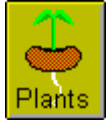

## Carrots

*Mother Earth News*, Sep/Oct 1987

### **The Easiest Seed-Saving Crops**

By Nancy Bubel

Insects pollinate carrot flowers, so make sure blossoming carrot varieties are planted at least 200 feet apart. (Serious savers will separate flowering carrots by 1,000 feet to assure seed purity.) Queen Anne's lace (wild carrot) crosses freely with cultivated carrots, with disastrous results. If you want to save carrot seed in an area where this lacy wildflower is common, fasten net bags over the carrot blooms to keep insects out, and pollinate the blossoms yourself by picking several from one plant and rubbing them over the surface of flowers on your seed plants. Carrot seeds shatter about two months after flowering. You can tie a small paper bag over drying seed heads to catch more of the seeds.



### **The Arc Institute**

The deeper and lighter the soil, the larger and better shaped the roots. Plant 1/2" deep 2" apart in rows 1-2' apart. Cover soil with grass clippings to keep a dry crust from forming and preventing seedlings from breaking through. Two crops a year can be planted. Roots can be stored in a cool cellar to last through the winter.



# Troubled Times



## Onions

*Mother Earth News*, Sep/Oct 1987

### **The Easiest Seed-Saving Crops**

By Nancy Bubel

Some onions do go to seed the first year, but those aren't the ones you want to reproduce. Instead, choose bulbs that have kept well in cool, dry winter storage. Replant them a few inches apart in early spring. Separate different varieties of this insect-pollinated crop by at least 100 feet. Onion seed also shatters readily, so watch closely for the black seeds to form, then collect the seed heads promptly.



### **The Arc Institute**

Prepare the bulbs for harvest when 50% of the onion tops have fallen over. Knock the rest of the tops over too, and the bulbs will form protective skins while the tops dry up. Do not water at this point. Bulbs can be pulled then and dried on the ground unless it is wet. Store in a hanging net in a cool cellar. Plant 1/4-1/2" deep, 2-3" apart, in rows 18" apart.

Onions multiply by either sexual or asexual means. Sexual is in the same manner as other plants: they bloom and produce seed. Asexual is by division. The cells in the bulb divide and form another bulb. Asexual is not often seen in most varieties of onion since we normally harvest the bulb in the first year for our consumption. However some varieties, especially small bunching onions and shallots, multiply primarily by division and a few are always left by the grower to allow for this division. Large bulb varieties rarely divide. You could probably force them to if you kept them from going to seed and rotting away. Basically, they need lots of space to grow into, and time.

My father has a couple of varieties of shallots that he leaves in place year-round. Each year they approximately double in bulb quantity. When they get crowded they go to seed so he clips off the seed heads and thins them out (by selective harvesting) thereby leaving more space for them to continue to divide. (Division is a *\*slow\** process and takes more than just one year.) When thinning, one should pay particular attention to poor looking bulbs that may be genetically challenged or diseased. These should definitely be thinned. Then thin whatever you want to eat!

Offered by [Roger](#).



# Troubled Times



## Tomato

**Saving Seeds** by Jim Randel, Thayer, Missouri

We have been saving tomato seeds for the past 20 years with great success. The simplest way is to just spread the seeds on a thick pad of newspaper to dry. After 3-4 weeks of drying, the seeds can be stored in tightly closed jars. We leave them attached to the newspaper until we are ready to plant them. However, you can scrape them off before storing, or you can dry them on waxed paper, as one of our neighbors does. A longer tomato seed saving method involves squashing the tomato into a container with 1/3 to 1/2 cup of water. We use recycled plastic containers. Let this mixture stand where it can be checked each day. Fermenting will take place in several days, and the good seeds will separate from the pulp and sink to the bottom of the container. After a day of fermentation (but not more than five) pour the goop off the top of the jar, strain out the seeds, and rinse them. Air dry for several weeks and store in tightly closed containers. Make sure your storage place is cool and dry.



We store our tomato seeds in large glass jars with a homemade rubber gasket in the lid, inside our freezer. To use, we let the jar come to room temperature, remove the desired number of seeds, reseal and refreeze. Some of our tomato seeds have remained viable for eight years using this method of storage. Either of these methods can be used with seeds from tomatoes that have been processed in a machine such as the Victorio Strainer.

*Organic Gardneing*, Sept/Oct 1992

### **Step by Step Tomatoe Seed Saving**

by Suzanne Ashworth

Harvest nicely ripe tomatoes from several different vines of the same variety, cut each across the middle and gently squeeze the juice and seeds into a bowl. You will note that each tomato seed is encased in a gelatinous coating. (This prevents the seed from sprouting inside the tomato.) Remove this coating by fermenting it. This mimics the natural rotting of the fruit and has the added bonus of killing seed borne tomato diseases. To foment your ferment, add about half as much water as there are tomato seeds and juice in the bowl and stir this mixture twice a day for about three days. Keep an eye on the mixture - especially if it's in a warm area - fermentation happens more quickly at high temperatures. As the mixture ferments, it will be come covered with white or gray mold. (Do not keep the bowl in the kitchen, anywhere it can be tipped over by animals or children or any where you can smell it - it will get pretty rank.)

When bubbles begin to rise to the top of the mass, or when a thick coat of mold has formed, stop the fermentation by adding enough water to double the mixture, and stir vigorously. The clean, good seeds will settle to the bottom of the bowl. Gently pour off the mold, debris and any seeds that float (they're hollow). Add more water and repeat the process until only clean seeds remain. Capture the seeds to be saved by pouring the liquid through a strainer, wipe the strainer bottom with a towel to remove as much moisture as possible, then dump the seeds out on that glass or ceramic plate to dry. Stir twice a day to ensure even drying and to prevent clumping. Warning: Tomato seeds will begin to germinate if they are not dried quickly, but you should still not dry them in direct sunlight or in the oven. A fan will help speed



the drying process safely.

*Mother Earth News*, Sep/Oct 1987

## **The Easiest Seed-Saving Crops**

By Nancy Bubel

Because tomatoes are the most popular garden vegetable and are available in many wonderful open-pollinated varieties, you'll probably want to save some. I simply scoop out the seeds from several top quality, overripe fruits, removing as little pulp as possible, and spread them on several thicknesses of newspapers to dry. I even store them right on the paper (labeling the sheets with the variety name) and, the following spring, scrape them off as I need them. Tomatoes are less likely than their pepper and eggplant cousins to be cross-pollinated by insects, but such random crossing does happen in about 2 to 5% of close multi variety plantings. Flowers of older tomato varieties also have a long style which is more likely to be touched by bees than the shorter-styled recent cultivars. So if you want to keep seed of a valuable heirloom tomato truly pure, plant it 25 feet away from other varieties. (Separate modern short-style cultivars by 10 feet.)

Some gardeners ferment their tomato pulp before straining out the seeds. There are two reasons for this: 1) the seeds will then separate more easily from the flesh, and 2) the treatment kills the seed-borne bacteria that cause some tomato diseases. To ferment tomato pulp, press the flesh into a jar, add 1/4 Cup of water, and keep the mixture at room temperature for several days. Seventy to 80°F is best; fermentation proceeds too quickly at higher temperatures. Stir the brew each day. By the second or third day, you'll be able to pour off the rotten pulp and "clinker" seeds that float on top, and retain, rinse and dry the good seeds that have sunk to the bottom.

### **The Arc Institute**

Long growing season so often are started indoors and transplanted when the soil is warm. Place 18" or more between plants in rows 3' apart or more if no trellis is provided. Crop can be wiped out by blight, so some seed should always be retained to plant in another year.



# Troubled Times



## Beans

*Mother Earth News*, Sep/Oct 1987

### **The Easiest Seed-Saving Crops**

By Nancy Bubel

Beans. Snap bean blossoms self-pollinate before they open, so there's very little chance they'll cross-pollinate. (If you have a rare old heirloom strain that you want to be sure of keeping pure, plant it 100 feet away from any other blossoming beans.) Bean seed matures about six weeks after the pods are good for eating - when it's ripe, you can scarcely dent it with your teeth. Leave the pods alone until the plants are dry, often leafless, stalks rattling in the wind. Then pull the stalks and stack them in a protected, airy place to dry for another week or two. You can shell small amounts of beans by hand. Thresh larger collections by spreading the pods on a clean sheet and whacking them with a rubber hose, broom or flail. By the way, if your seeds ripen slowly and unevenly, your soil may be short on zinc. Lima beans, dry beans and soybeans should be treated like snaps. Bumblebees like lima flowers, so the plants are likely to cross-pollinate with other limas. But they won't cross with snaps, peas, soybeans or other related legumes.



### **The Arc Institute**

Plant in the spring after frosts are over and the soil is warm. Plant 1" deep and a few inch apart, in rows 2-3' apart. Pole beans require poles or something to climb on. Rhizobia bacteria on the bean roots put nitrogen back into the soil. When harvesting for seed, let the pods dry on the plant, and leave the pods until they are dry and leathery unless there is a long web spell at harvest time when the pods should be picked and laid out to dry. Shell the pods when they are brittle dry. Put in airtight containers and freeze overnight to kill bugs, then store in a cool dry location.



# Troubled Times

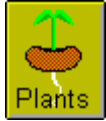

## Eggplant

*Mother Earth News*, Sep/Oct 1987

### **The Easiest Seed-Saving Crops**

By Nancy Bubel

This crop self-pollinates but it may also be cross-pollinated by row-hopping insects. If you intend to save seed from more than one variety, grow them at opposite ends of the garden. Leave the fruit on the plant until it has lost its glossy sheen and firmness - well past the point when you'd want to eat it. Eggplant seeds can be scraped and rinsed free of pulp without much difficulty.

### **The Arc Institute**

Eggplants love heat, the hotter the better. The seeds need soil at 85 degrees in order to germinate. Eggplants not harvested when fully grown will go to seed, the tiny brown seeds inside ripening and the surrounding fruit bitter. Plant 3/8" deep, 18" apart in rows 3' wide.



# Troubled Times

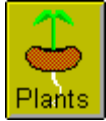

## Lettuce

*Mother Earth News*, Sep/Oct 1987

### The Easiest Seed-Saving Crops

By Nancy Bubel

#### Escargot and Edive:

Spring plantings of these biennials may perform like annuals and go to seed in summer heat. However, the leaf quality is best in fall crops. Keep autumn starts alive till spring by covering them with a deep mulch (applied when crowns are dry) or a portable cold frame. Each small seed fleck has a wispy parachute which you can rub off if you wish when you package the dry seeds.



Microsoft Illustration

#### Lettuce:

This self-pollinator goes to seed once the weather turns warm. First the heads elongate. Leaves turn coarse, dull and bitter, as though to protect the reproducing plant from being eaten. Then a seed stalk emerges from the leaf crown and soon bears clusters of small yellow flowers. After two or three weeks, when the blossoms change to tufts of fluff, pull off the down with its attached seeds. One stalk on a large lettuce plant can produce up to 30,000 seeds. (One of the most useful traits for which you can select is late bolting, so always save seed from the last lettuce to go to seed.)

#### The Arc Institute

Lettuce prefers cool temperatures, so plan to have little lettuce during the heat of summer. Plant 1/4" deep, spacing according to variety, in rows about 2' apart. Slugs can be controlled by luring them to drown in a plate of beer set at ground level. Water lettuce at ground level to avoid fungus in the leaves, and water thoroughly and frequently. Lettuce likes Nitrogen. Lettuce bolts to seed in hot weather.



# Troubled Times

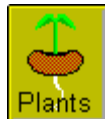

## Okra

*Mother Earth News*, Sep/Oct 1987

### **The Easiest Seed-Saving Crops**

By Nancy Bubel

This usually self-pollinates but will sometimes cross. Let okra pods dry on the plant, but catch them before they shatter (dry and fall), then shell the rounded seeds and let them air-dry for another week or two before packaging. Select for early and heavy-bearing plants.



Derek Fell



# Troubled Times

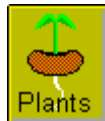

## Melons

### The Arc Institute

Melons are ready to harvest when the stem slips from the end of the melon with little pressure. Plant 1/2" deep at a distance of 2' from each other in rows 6 feet apart. Plant transplants when weather and soil are warm and frosts are over.



# Troubled Times

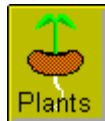

## Peppers

---

*Mother Earth News*, Sep/Oct 1987

### **The Easiest Seed-Saving Crops**

By Nancy Bubel

Even though peppers normally self-pollinate, it's not at all unusual for insects to carry pollen from hot pepper blossoms to those of sweet ones. So keep your pepper varieties 50 feet apart. Aside from the cross pollination possibility, peppers are a snap to save. I just shake or scrape out the seeds from several shapely fruits that have turned red-ripe, and then dry them on newspapers for a week before packaging.

### **The Arc Institute**

Peppers like warm weather and will not germinate until it arrives. They also have a slow germination period of 3-4 weeks, and can be started indoors. Plant 1/4" deep, 18" apart, in rows 2-3' apart. Peppers can be harvested any time but are thicker, sweeter, and jucier when mature. Can be dried for storage.



# Troubled Times

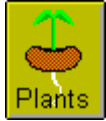

## Corn

*Mother Earth News*, Sep/Oct 1987

### **The Easiest Seed-Saving Crops**

By Nancy Bubel



Pollen from the tassels of this wind-pollinated crop land on the silks that line the ears. Popcorn, field corn and sweet corn will all cross with each other. To keep strains pure, then, plant seed varieties that tassel at the same time at least 1,000 feet apart. (Technically speaking, 1/4 mile is ideal.) Or you can avoid crossing by bagging ears you want to save. Before the silk emerges, cover each seed ear with a paper bag closed with a rubber band. When the tassels shed pollen easily, cut a tassel from one plant, rub it over the ear from another plant, and replace the bag. Leave the bag in place until the silks brown, replacing it whenever it gets too wet. Leave seed ears on the plants until they're quite dry - about a month after they're good for eating. Then pick, peel back the husks, and hang them up - leaving air space between each ear - to dry for several more weeks.

Corn is prone to run out if repeatedly inbred, so save ears from at least 25 plants if possible, and mix seed from those ears before planting. Some of the easiest corn traits to change by back-yard selection are earliness, lateness and ear height. Flavor, yield, nutritional quality and insect resistance are more difficult to improve.

### **The Arc Institute**

Plant in clumps for effective pollination. Corn is wind pollinated, and a single or double row will not pollinate properly, resulting in ears with missing rows or kernels. Corn that is ripe will ooze or squirt white juice that looks like milk when pinched. Corn is a heavy feeder and can deplete soil of nutrients, so alternating with beans or peas will rebuild the nitrogen. Plant 1/2" deep, a foot apart, in rows 2 1/2' apart. Dry corn for meal can be dried in the field in the husks unless it gets damp.





# Troubled Times

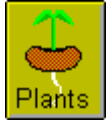

## Peas

*Mother Earth News*, Sep/Oct 1987

### **The Easiest Seed-Saving Crops**

By Nancy Bubel

In the tangle of the viny pea row it's hard, if not impossible, to distinguish between separate plants. For this reason, most seed keepers designate a stretch of row for seed production and let all the pods in that section mature. You can expect about one pound of seed from each 15 feet of row. Pods should dry thoroughly before harvest, and even then it's a good idea to pile the pulled vines loosely in a dry, well-ventilated spot to air-dry further before threshing. Regular peas will only rarely cross with sugar peas, and this isn't common enough to concern the home gardener.

### **The Arc Institute**

Plant early and mulch pea roots to keep them cool during hot weather. Short growing season of about 2 months. Plant 1/2 to 1" deep, a double row 3" apart with the plants 1 1/2" apart in each row, with a walking lane 18" between each set of double planting rows. Climbing peas need a trellis or fence. Hold back enough seed to replant in extended wet cold weather results in damping off. However, early planting is fine, as peas love cool soil. Rhizobium bacteria on roots put Nitrogen back to the soil. Shelling peas are high in protein, and should be picked for food when the pods are rounded and filled with swollen peas. Snow peas are harvested for food when the pods are thin, flat, and the peas barely visible. When collecting seed, leave on the vine until the pods are dry.



# Troubled Times



## Sunflowers

*Mother Earth News*, Sep/Oct 1987

### **The Easiest Seed-Saving Crops**

By Nancy Bubel

Sunflowers. These cooperative seed producers are a good choice for your first season of seed keeping. You might want to tie netting over the ripening heads to keep birds off. On our farm, goldfinches can strip the heads in no time. Shell the heads by rubbing them over a coarse hardware-cloth screen. Then dry the seeds, and seal them securely to keep out mice. Sunflowers that cross repeatedly with nearby wild sunflowers will produce less-desirable plants with each generation. It's usually easy, though, to find and chop down any nearby small-seeded wild plants that might interfere.



Microsoft Illustration



# Troubled Times

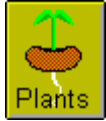

## Spinach

*Mother Earth News*, Sep/Oct 1987

### **The Easiest Seed-Saving Crops**

By Nancy Bubel

This hardy annual has tiny, scarcely noticeable wind-pollinated flowers which can cross with other blooming spinach plants as much as one mile away. If you can avoid crossing problems, though, spinach is an easy plant to grow to seed. You might try selecting for later bolting by roguing out small, early seeders - and, of course, by getting your seed from plants that produce the latest seed stalks. Harvest yellowed or browned plants when the seed has matured. Rub off the tiny seeds while holding the stalks in a grocery bag.



### **The Arc Institute**

Matures quickly and best planted for food in the early spring, as will go to seed when the weather turns warm. Plant seeds 1/2" deep and thin the plants to 2-3" apart in rows 18" apart. High in nutrients - vitamins and minerals.



# Troubled Times

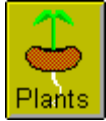

## Cucurbits

*Mother Earth News*, Sep/Oct 1987

### The Easiest Seed-Saving Crops

By Nancy Bubel



This large group embraces fruits as diverse as cucumbers, gourds, melons, pumpkins and zucchini. In all cases, blossoms are pollinated by insects, male and female flowers are separate, and crossing between varieties that accept each other's pollen occurs at distances up to at least 100 feet. (Indeed, commercial seed breeders keep related cucurbit crops 1/4 mile apart.) Since plants can cross only within a species, and cucumbers, watermelons, cantaloupes and pumpkins all belong to separate species, they can't cross with each other. Zucchini and gourds are members of the same species, so they can produce some crazy crosses. Buttercup and banana squash will cross as well.

How can you keep it all straight? Follow this rule. In any one year, you can save seed - without bothering to separate the varieties - of cucumbers, cantaloupes, watermelon and any one member of each of the following:

#### **Cucurbita pepo:**

Members of this group have deeply grooved, ridged and prickly five-sided stems and include striped and warted gourds, Lady Godiva, Small Sugar and Connecticut Field pumpkins, and acorn, cocozelle, crookneck (summer), scallop, spaghetti and zucchini squash.

#### **Cucurbita maxima:**

Stems are round, hairy and somewhat soft. Members include Hubbard, turban, delicious, banana, marblehead and buttercup squash.

#### **Cucurbita moschata:**

The smoother five-sided stem widens at the base. Moschata members include golden cushaw and butternut, cheese and melon squash.

#### **Cucurbita mixta:**

The vines resemble those of *C. moschata*. Members include cushaws (except for golden cushaw), Tennessee sweet potato, Japanese pie and mixta gold. All seed cucurbits should be allowed to remain on the vine until the skin hardens, so the seeds can mature. Most seeds will be more viable if allowed to after-ripen in the fruit for 20 days past maturity. Rinse off the pulp and dry the seed on screens before storing.

If your garden is close to others where cucurbits grow, if you want to keep seed of several related varieties in the same year, or if other people will be depending on the purity of your seeds (for instance, if you're part of a seed savers' exchange), you should hand-pollinate your cucurbits. First, examine the flowers of a healthy, productive plant. A male flower has a slender stem, while the base of a female flower has a small swelling of undeveloped fruit. Work only with blossoms that have not yet opened. (Once the blossom has opened, you should assume that it's already been pollinated.)

Tape several perky but still closed male and female flowers shut, or fasten small bags over them. Then

when the flowers have opened (probably the following morning), uncover one male flower and several female flowers from different plants. Pick off the male's petals, then gently but firmly touch its pollen-laden anthers to the stigmas of the females. Next, recover the pollinated females with envelopes or small bags, and carefully wire them shut. Leave the protecting covers on for several days. Then remove them so the fruits won't rot or develop abnormally. Don't forget to label the pollinated flowers!

### **The Arc Institute**

Cucumbers like lots of water. Planting in hills with a depression in the center makes it easier to water them effectively. Plant 1/2" deep, 2 or 3 plants per hill, 5 feet apart. For seed production, allow the cucumber to go yellow and orange. Cucumbers are not highly nutritious, but provide Vitamin A. Cucumbers are very cold sensitive, and need warm weather and soil.

Summer squash matures quickly and is prolific. Picking summer squash regularly will encourage more production of squash. Leave any squash grown for seed to become large and fully mature. Winter squash matures later and should be left on the vine to mature and harden. Winter squash is a heavy feeder, and does well when planted in the compost pile. Pick winter squash before the first frosts and store in a cool cellar. Plant 1/2" deep, 1' or more apart in rows 4-5' apart. Plant when the soil is 75 degrees or warmer.



# Troubled Times



## Wheat

### The Arc Institute

Can be stores long-term if very dry. Placing into air-tight containers and freezing for a week or so to kill any insects will help avoid infestations. Broadcast seed on soil at a rate of 4 lb./1,000 square feet. Mulch with straw to retain moisture and discourage weeds. Plant winter wheat in the fall, so grass-like clumps of wheat are killed back by the first frosts but re-emerge in the spring. Harvest mid-summer for winter wheat, late for spring wheat. Wheat is ready to harvest when stems yellow and kernels can be dented with a fingernail. Cut and bundle the wheat into shocks left standing in the field to dry. Threshing is beating the wheat tops on a flat floor with a stick or flail as the wheat pops out of the heads. During this process, the wheat kernels fall to the floor, the straw removed from the top.



# Troubled Times

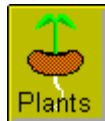

## Threshed

---

This how I harvest the wheat.

1. Get a sickle like the one in the old communist Russia flag. and when the wheat is ready to harvest cut it down at the base and when you have enough bundle the wheat up into bundles to take to your thrashing floor.
2. At the floor spread the wheat out and then take a set of numchuki or flail and beat the wheat to separate the wheat and chaff from the stalks.
3. Collect the stalks and keep as hay if you want.
4. Sweep up the wheat and chaff together and put in a pail.
5. Go outside and scoop up the wheat in a scoop and pour from a reasonable height into another bucket, letting the wind blow through the stream of wheat and chaff and you will see the chaff blow away and the wheat will fall into the bucket. when the wheat is clean of chaff, pour out of this working bucket into your final bucket.
6. Do not fill the working bucket up too much or else it will take a lot of work to separate the chaff out of the wheat. just a couple of scoops of wheat/.chaff, clean it and then pour the clean wheat out to final bucket.

With that you will be participating in an activity that changes humanity from a hunter/gather society to a agrarian society. I do this with my wheat that I grow.

Offered by [Gus](#).



# Troubled Times

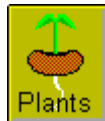

## Guava

---

Try germinating some seed that has simply been dried straight from the fruit (after a resting period). Also, try fermenting some of the seed and after a resting period, try germinating it as well. The seeds that germinate better would represent the better method.

Offered by [Roger](#).

The [California Rare Fruit Growers](#) association has fruit specialist volunteers that can answer many specific questions from people needing answers about non traditional fruit.

Offered by [Steve](#).





# Troubled Times



## Native Varieties

---

This gardening topic concerns growing vegetables that are native to you specific micro-environment. Gardeners all around the world *begin* this process accidentally, as some vegetables they do not pick, mature in the garden, grow old and decompose, leaving seeds behind. In the Spring of the following year, those seeds come up like crazy, and most gardeners chop them out as they are considered no different than weeds. Those plants are known as "volunteers," as you did not plant them on purpose, but are the freely given offspring from last year's plants. Here is a technique I've employed successfully, to make the most of those volunteers:

Plant your garden normally, making sure that most of your garden is sown in open pollinated (non-hybrid) seeds. Let the plants grow up becoming adults. Before harvesting any open pollinated crop, be a detective and locate the best-looking, most robust, disease-and pest free individuals of each the variety of vegetable. You can pinch off a bit of them to make sure the taste is at the top of your standards. So, what you are looking for are plants that you would like to see next year in the garden. Don't harvest those specific individual, robust plants that you've selected, but let them grow up for several more months so they produce flowers. When fully bloomed, you may want to help in pollination so as to ensure good seed production. In another couple months you can harvest the seed for next year if you like, but certainly some seeds will of fallen back into the garden beforehand. Also, your plants are probably full of thousands of seeds, so collect the amount you need for next year and then pull up the plant, and shake the rest of the seeds throughout the garden. These seeds will sprout up and grow in the Spring.

Now, when you see these new spouts coming next year, and you know they came from parent varieties you selected, do not weed them out, but let those individuals grow up too, and disperse their seeds once again.

The healthy varieties, adapted to your specific micro-environment, will survive from year to year. Always weed out any individual plants that show signs of weakness or disease, as you do not want them to produce seeds and pass on those traits into the gene pool you are developing. And most important, be a good weeder and chop down any undesirable plants before they go to seed, as you do not want weeds to take over your garden. In fact, a rule of nature, is that she will do her best to cover up any exposed, open, fertile soil with plants. We are trying to use this rule to our advantage here. If we can keep the weed seeds out of the garden, and keep the vegetable seeds (that we have personally selected) in and throughout the garden, then over the years the garden will grow a lot of vegetables, as if they were weeds.

I've done this technique for many years, and now have many types of lettuce, basil, squash, beans, sunflowers, Swiss chard, broccoli, tomatoes, etc., come up where the weeds use to be. But these vegetables, are just not any old, bad-tasting things, but specific varieties that I have selected and helped along. Again: you have to be vigilant in checking out the individuals you save. Make sure they are robust in growth, taste great, look good, and have no problems with disease or pests.

This is an obvious good survival technique for after the pole shift as you can image having vegetables come up where and when weeds naturally grow. You will find, just as I have, that this technique will put food on the table, many days of the year, without you having to work at it.



# Troubled Times



## Optimal

---

Among the many types of vegetable varieties we can consider growing post-shift, I believe we need to shorten the list to plants that:

- Mature in the shortest time and are generally prolific.
- Offer the highest nutritional value.
- Can withstand the least amount of lighting.
- Offer higher yields with less space.
- Display higher-than-average disease resistance.
- Are the hardiest amid adverse conditions.
- Store well.
- Offer superior seed longevity.

With this in mind, I've included some key information from a fine book called *The Vegetable Gardener's Bible*, by Edward Smith. I recommend this book to anyone interested in superior growing techniques, and I posted some info from this book a few days ago. But today (Saturday), I've just added some specific, shift-oriented information for 30 different plants ranging from asparagus to turnips.

Offered by [Mike](#).



# Troubled Times



## Organic Gardening

---

Excerpts from the **NHNE** newsletter, article titled *Organic Farming Finishes First*  
(Source: *Organic Farming* via *Spectrum*, May-June/97)

One of the commonly-heard arguments in defense of chemical farming is that it is more productive than organic agriculture, thereby justifying the use of toxic pesticides and synthetic fertilizers, but one study indicates that this may not be the case. The longest-running experiment in the U.S. comparing chemical and organic farming is the Rodale Institute's Farming Systems Trial. For over 15 years, it has compared three farming systems side by side at the **Rodale Institute Experimental Farm** in Pennsylvania. One field uses chemical fertilizers and herbicides; the other two fields use mechanical weed controls -- one using legumes for fertilizer, the other manure. In normal years, the organic fields produce the same amount as the chemical field. However, in years with low rainfall, the soil of organic fields, being of higher quality, holds more water and air, thus enabling the organic fields to out-produce the chemical one. In the relatively dry year of 1995, for example, the organic legume-based system produced 148 bushels of corn per acre, compared to 115 bushels with the chemical system.

Some of the information presented at this site on **Organic Vegetable Gardening** could be adapted to our indoor food production.

Offered by [Mike](#).

This method has been used by the French for over 400 years and should help as a basis for large scale gardening. The biggest foreseeable difficulty I perceive in large-scale organic farming is the need for additional manpower to monitor the crops. Insects and soil vitality can quickly get out of balance if not monitored almost daily. There is a local farmer that grows vegetables on a large scale and he employs a crew of 12 or more farm-hands to harvest and patrol the fields daily. This farmer uses some of the organic basics, though he is not completely organic in his methodology.

Offered by [Roger](#).



Buy Cherimoya and White Sapote Direct from organic farmer click on picture

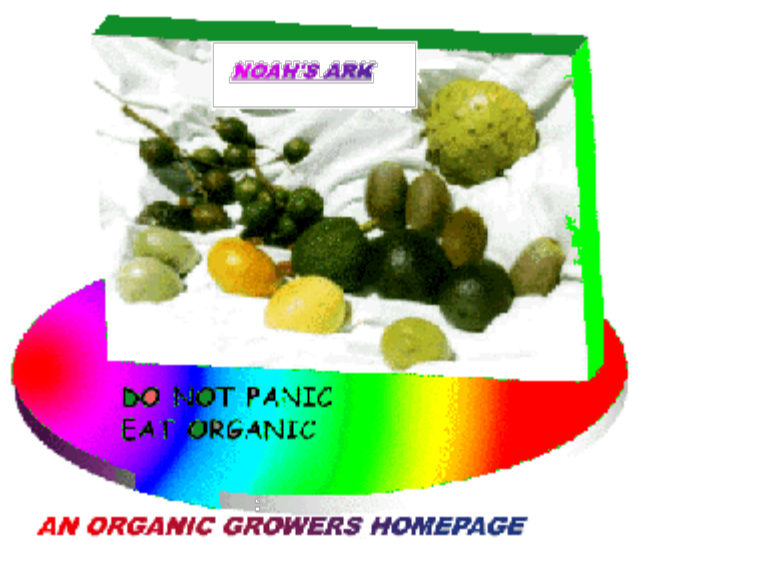

Buy Cherimoya and White Sapote Direct online from organic farmer click on picture

Organic Cherimoya = don't eat the seeds or skin=

The way I eat them: Ready when as soft as the palm of your hand with just a little give, I just cut in half and spoon out like a melon spitting out the seeds and discarding the skin. Some time I cool them in the fridge . how could some thing so sweet be so easy to eat.



*The Don't Panic Eat Organic Home page was Last Updated* Feb. 4 ,2012

**White Sapote season started December 11, 2011 Cherimoya season started Feb.4 2012 click picture above to order**

Welcome to Noah's Ark!

Noah's Ark is an organic grower of Cherimoya and White Sapote.Want to

learn about our most exciting crop , get recipes and info. ? : ) just press [Organic Cherimoya.](#)



We have been in business since 1979.

**An organic growers home page! It is growing like everything else around here!**

*These are some of the places i have been on the net.. make up your own mind .*

[How Subchronic and Chronic Health Effects can be Neglected for GMOs, Pesticides or Chemicals](#)

## [ADHD in kids tied to organophosphate pesticides](#)

### [The future is organic: But it's more than organic!](#)

by Dr. E. Ann Clark

## [Argentina's Roundup Human Tragedy](#)

**A must see movie. [The Future Of Food](#) Hulu will only stream to IP addresses inside the U.S.**

## [Olivier De Schutter | United Nations Special Rapporteur on the Right to Food](#)

Week of 3.5.10

## [Food, Inc.](#)

Behind the food we love◆Secrets that giant food companies don't want you to know.

[eOrganic](#)

**eOrganic Webinar**

[Using weed suppressing, winter killed cover crops](#)

[\*\*GM Crops Facing Meltdown in the USA\*\*](#)

From the Editors Science in Action - [GM-Spin Meltdown in China](#)

['Balanced' Ecosystems Seen In Organic Ag Better At Controlling Pests](#)

**The USDA's [Agricultural Marketing Service](#) (AMS) has expanded to include organic commodities. [Fruit and Vegetable Market News Portal](#), with real-time reports for all available organic market data. [Organic farms have better soil](#)**

[Prince Charles warns GM crops risk causing the biggest-ever environmental disaster](#)

[Pennsylvania changes course and allows farmers to alert consumers that they do—or don't—ply their dairy cows with hormones](#)

[Organic Price Report](#) **Rodale Institute**

[Monsanto's Frankencrops Spread Herbicide-Resistant Pigweed Across the Southern States](#)

or as seen on tv "[I've never seen anything that had this major an impact on our agriculture in a short period of time.](#)"

[Beware manure affected by herbicide](#)

[Parallel universes: A rice farmer's point of view on U.S.-European GMO attitudes](#)

[MetroFarm... The Online Magazine of Metropolitan Agriculture](#)

[The Whole Earth Catalog](#)

[\*\*Glyphosate Resistance in Weeds\*\*](#)

[\*\*The Transgenic Treadmill\*\*](#)

[You Bet Your Garden](#)

[\*\*Home-grown veg ruined by toxic fertiliser\*\*](#) **Gardeners**

**have been warned not to eat home-grown vegetables contaminated by a powerful new herbicide that is destroying gardens and allotments across the UK**

[Scientists create Britain's first hybrid embryos](#) where's the beef?

[Children that Switch from Conventionally Grown to](#)

[USDA Recommends That Food From Clones Stay Off the Market](#) too late you could be eating it . don't panic buy organic

[Organic Farming Beats No-Till?](#)

[Five Easy Ways to Go Organic](#)

[IFOAM The Principles of Organic Agriculture](#)

[There's a long and full talk in six parts by Jeffrey Smith, author of Seeds of Deception,](#) at YouTube .also check out [Genetically Modified Organisms - unnatural selection](#)

[Scientific Status Summary on the Organic Food Industry](#)

[Organic crops perform up to 100 percent better in drought and flood years](#)

[Biotech instills fear and loathing in California rice belt](#)

Long-grain rice had become inadvertently **[contaminated with a genetically engineered variety not approved for human consumption.](#)** Remember starlink Showing the world "folks we cannot control the GMO. Do not panic think Organic "

**[Also see Unapproved Rice Strain Found in Wide Area](#)**

[Europe was right to ban the beef industry from using growth promoters to increase yield](#)

## Cute flash movie Organic vs. Non O.

Organic Federation of Australia Awards -2003

\* The Food Forest - Best Organic Producer

Organic milk 'higher in vitamins'

Organic vegetables may contain higher levels of health-giving chemicals, claim Scottish researchers.

Organic farms 'benefit wildlife'

Organic farming could produce enough food to feed large populations, according to British scientists at the Festival of Science in Sheffield

## Organic food 'better' for heart

## Organic Farmer Jon Tester Elected to United States Senate

**VICTORY!** MENDOCINO COUNTY FIRST COUNTY IN NATION TO BAN THE GROWING OF GENETICALLY ALTERED CROPS AND ANIMALS Right against might!! . Now let the USDA know GMOs are contaminating organic food supply and we can not protect our product.

Groups Challenge EPA's 'Industry friendly' Pesticide Rules -Two recent actions by environmental health watchdogs foreshadow a showdown between corporations and public-interest advocates over the safety of toxins marketed as pesticides

The New Farm } **Guide to US Organic Certifiers**

The entire book "Building Soils for Better Crops"

## **Breathing pesticides 'can trigger MS and Parkinson's disease'**

Scientists aim for lab-grown meat

Roundup® highly lethal to amphibians, finds University of Pittsburgh researcher

What's Bugging You? It Could Be Pesticides



[Seeds of doubt: North American farmers' experiences of GM crops](#)

get your copy Seeds of doubt

[Soil Association response to GM contamination of Soy products](#)

[Welcome to the Saskatchewan Organic Directorate Website](#)

[\*U.N. conference: Large-scale switch to organic agriculture could help fight world hunger\*](#)

[\*Lawsuit Challenges Unscientific FDA Policy on Gene-Altered Foods\*](#)

[SoilWiki-Discussion & Articles](#)

## • [\*\*Organic Price Report\*\*](#)

[AMS](#) provides current, unbiased price and sales information to assist in the orderly marketing and distribution of farm commodities.

[Wholesale \(Terminal\) Market Price Reports](#)

Welcome to the [OPX™](#), a comparison of conventional and organic prices for over 40 products, from grains to vegetables

The 24 scientists on the ISP published their report, The Case for a GM-Free Sustainable World on the ISP website [www.indsp.org](http://www.indsp.org) [.pdf file](#) 15 June 2003

[Rice with human genes: pharming in California](#)

[Babies as Guinea Pigs: Biotech company turns two Peruvian hospitals into laboratories](#)

[\*\*SEND THANKS TO SENATORS! VERMONT PASSES FARMER PROTECTION ACT\*\*](#)

# THEMEATRIX

AN INVITATION TO JOIN

CALIFORNIANS FOR GE-FREE AGRICULTURE

Sustainable Agriculture Radio Show Archive

ORGANIC GARDEN WEED MANAGEMENT WEBSITE

NASDA to support research and marketing assistance for organic agriculture

GLICKMAN ANNOUNCES NATIONAL STANDARDS FOR ORGANIC FOOD

**completely redesigned site. SARE**

Farm Business and Household Survey Data: Customized Data Summaries from ARMS

Why Food Safety Will Continue Driving Growth in Demand for Organic Food {.pdf}-----Clearly, the U.S.D.A. needs to look anew at recent data on pesticide residues in conventional and organic foods and reconsider its message, in the interest of restoring confidence in the Department's scientific abilities and openness to new information.

Symposium Proceedings::

Organic Agriculture: Innovations in Organic Marketing, Technology, and Research

Handy Farm Devices and How to Make Them



One of the most important things going on right now in the organic movement is Compost Tea. You have to know what you are doing and have a good understanding of what compost tea is all about to

understand how great this will be to mankind. I am learning about it at [Yahoo Groups](#) and joining the compost tea group . **and searching the [Sanet-MG Archives](#) and doing a [Search for compost tea](#).**

[Let the soil work for us-E.T. Elliott and D.C. Coleman](#)

[Genetically Modified Morals](#) A Global Food Fight by Kathleen McAfee

[Organic Agriculture Information website](#)

[Organic Farming Research Foundation](#)

[Organophosphorus pesticide exposure](#) of urban and suburban pre-school children with organic and conventional diets. Eating organic food reduces exposure to pesticides. ***Don't panic eat organic*** .

[Organic Kingdom](#), a premier organic food supplier offering bulk foods

[Organic Kitchen](#)

[Plants For A Future](#)

[Health begins in the soil](#) Welcome To The Holistic Agriculture Library

[AMERICA'S FIRST CERTIFIED ORGANIC RESTAURANT](#)

[Atrazine Poisoning Worse Than Suspected](#)

[Pesticide Action Network North America \(PANNA\)](#)

[Tom Clothier's Garden Walk and Talk](#)

Field study finds [deformed frogs](#)  
UC Berkeley prof's research links pesticide to abnormalities

FDA Gives Green Light to  
[Deceptive Labels](#) on Irradiated Food

Many [Conventional Foods Contain Toxic Levels of Pesticides](#)

[Monsanto Bows to Pressure on GE Wheat](#)

[Organic Ecology! See where it's happening in MN](#)

## [Federal Court Bans Frankenfish & Antibiotics](#)

## [Oregon Tilth](#)

[Cyber-Help for Organic Farmers](#) =A website geared to improving accessibility to quality organic content online, and upgrading farmers' capacities to access that information.

[EU Parliament Takes Strong Stand on Frankenfoods](#)

[Greenpeace Report Shows GE Industry in Trouble](#)

[The OFA](#) is the peak industry body for the Australian organic and biodynamic industry.

[USDA FAS GAIN Report NZ pdf](#) format A study by the NZ Ministry for the Environment finds support for the importance of a GE-free

[The North American Fruit Explorers](#) (NAFEX) is a network of individuals throughout the United States and Canada devoted to the discovery, cultivation and appreciation of superior varieties of fruits and nuts

## [Wendell Berry-Death of the American Family Farm](#)

## [BIOLOGICAL CONTROL AND INTEGRATION OF OTHER STRATEGIES](#)

[Read the National Standards on Organic Agricultural Production and Handling USDA](#)

[U.S. Organic Farming Emerges in the 1990s: Adoption of Certified Systems](#) pdf.file

HERBICIDES MAY COMPLICATE PREGNANCIES =[The EnviroLink Network links](#) to news stories from leading publications and media sources around the world.

[Organic Consumers Association](#) =Hazards of Genetically Engineered Foods & Crops

Anthony Rodale, Chairman of the Rodale Institute, spearheads The Institute in its mission to move the U.S., and indeed, the world,

toward sustainable, ["regenerative" agriculture](#) and also check out their [NewFarm.org](#), aimed at farmers ..

[Genetically-modified superweeds "not uncommon](#)

[GM crop DNA found in human gut bugs](#) For the first time, it has been proved that bacteria in the human gut can take up DNA from genetically modified food.

[Today, the National Organic Rule is a bureaucratic product](#) the original vision of organic farming as ecologically sustainable agriculture practiced by small farmers is giving way to big business. Organic's success is sowing the seeds of its own co-optation. Further derailing the organic mission, says Gould, are the increasing costs of certification, which disproportionately harm small growers

[An interview with Dr. Vandana Shiva](#)

"The deeper you can manipulate living structures the more you can control food and medicine."

[Proceedings of the UK Organic Research 2002 Conference](#)

[Organic farming 'a realistic choice'](#) After a 21-year study, Swiss scientists have given a ringing endorsement to organic farming methods.

[Witness Statement](#) for New Zealand Royal Commission on Genetic Engineering It is no longer a moratorium that is needed. GM crops are unsafe and unsustainable as well as immoral.

## [Organic Livestock Feed Suppliers](#)

[IFOAM 2002 Organic World Congress](#) "Cultivating Communities" August 21-28, 2002, Victoria, British Columbia, Canada.

[Terra Viva Organics](#)

[Welcome to organic-research.com](#)

[Organic Agriculture website](#)

[Soil And Health Library](#)-(PC titles:)

The City Forest, Yeomans

The Challenge of Landscape, Yeomans

Friend Earthworm, Oliver

Pay Dirt, JI Rodale

The Clifton Park System of Farming, Elliot

Soil and Sense, Graham

High Road To Hunza, Mons

Health and Survival In the 21st Century, Home

[OrganicTrade Services](#) This Web site serves as a "portal" to the organic industry in the UK.

[Organic Trader](#) is an online trading network dedicated to bringing suppliers the best possible price and consistent competition for their products. Suppliers, buyers and distributors use this site to locate, request and buy/sell organic products.

## [ORGANIC ATTACK!](#)

### [Dietrick Institute for Applied Insect Ecology](#)

[RINCON-VITOVA INSECTARIES](#)

[Welcome to organic-research.com](#)

[Organic Advocates](#) raising awareness and support for organic agriculture

"[Reap New Profits: Marketing Strategies for Farmers & Ranchers](#)," a PowerPoint presentation. This latest informational product from CSREES' Sustainable Agriculture Network (SAN) is intended for ag professionals who want to help small and medium-size farm operations prosper/For more information about SAN books and free bulletins -- [a collection of farmer-ready resources](#) that spell out ways to increase profits while improving the environment and communities

[There are agricultural products, including personal care products, that, by virtue of their organic agricultural product content, may meet the NOP](#)



[Press The Barn Owl](#) and learn more about this flying cat and how he can help the organic farmer.

[Artificial Perches for Raptors](#) Press if you want the plans and instructions to build perches

SIGHTS & SOUNDS FROM THE RAPTOR CENTER where you will find pictures and calls of Raptors [The Raptor Center](#)

[SOIL MICROORGANISMS AND HIGHER PLANTS](#) by N. A. Krasil'nikov from the Academy of Sciences of the USSR Institute of Microbiology while there also check out the other papers at [To The Holistic Agriculture Library](#).

[Organic Food Boom: 10% of European Farms Will Be Organic by 2005](#)

[Edible Flowers](#) This extensive list represents all varieties that are native, wild or are derived from natural selections

[WHAT DOES IT MEAN TO GARDEN ORGANICALLY?](#)

[Organic Foods Are Booming in Great Britain](#)

[Small farm resources Organics](#)

[Controlling weeds and pests Weeds](#)

[MetroFarm.com](#) The Electronic Magazine of Metropolitan Agriculture . *check out the radio archives* -

[Farm Management Planning Guide](#) Projected 2000 Organic Crop Budgets South Central North Dakota

[The Organic Materials Review Institute](#) OMRI is a 501(c)(3) nonprofit organization created to benefit the organic community and the general public.

This is a talk by Jan Dietrick at the Acres U.S.A. Eco-Ag Conference To play this .ra file you will need the [RealAudio Player](#). The Dietrick Institute for Applied Insect Ecology A non-profit public benefit corporation since October 1996 headquartered in Ventura, CA. The Institute offers education and research programs that promote the use of biological pest management strategies based on maintaining, restoring or enhancing the diversity of organisms in soil and above-ground foodwebs. Sorry for the poor sound .

Also the CLIPS FROM THE ECO-FARM CONFERENCE -they will take a while to download but the sound is much improved

1996 ECO-FARM CONFERENCE Beneficial Insects

1. [jan1b.rm](#)
2. [jan2a.rm](#)
3. [jan3a.rm](#)
4. [jan4a.rm](#)
5. [jan5a.rm](#)

Notes from [Farm Field Day #1](#) **Choosing Borders and Interplantings for Natural Control of Pests**  
*Plant them and they will come!*

**This was a great event:** [Soil Ecology Seminar](#) A big thank you to Dr. Elaine Ingham (Oregon State University) told me it was ok to post [Scientific Basis for Biological Farming and Natural Control of Soil Insects and Disease](#)

[SUPPLIERS OF BENEFICIAL ORGANISMS IN NORTH AMERICA](#)

**Mulch and Mulch-Related Information try** [MULCH-BASED AGRICULTURE GROUP](#)

I also found a good link in the California Cherimoya Association Newsletter to [UC Pest Management Guidelines](#) Over 15yr. of IPM knowledge from University of California at Davis, major pests with color photos, biologies, monitoring methods, and ***Some ORGANICALLY ACCEPTABLE METHODS and treatment strategies remember organic growers don't need any stinking herbicides or pesticides.***

[National Biological Control Institute](#)  USDA Animal and Plant Health Inspection Service

[Newsletter](#) International Organization for Biological Control

[Using Weeds as Indicators](#) of Turf Management and Environmental Conditions

[Dr. Bargyla Rateaver](#) a comprehensive archive of information and sources about the Organic Method of growing plants

[You're a what??!! an Organic Gardener??!! Part 1](#)

[Lunar Agriculture or... Moon Planting](#)

[Alternative Agriculture News](#) Back Issues From the Henry A. Wallace Institute for Alternative Agriculture.

[Permaculture Research Institute](#)

[Danish organic](#) English versions from the central Danish Organic web site

[The Prince of Wales web sight](#)

[Organic Gardening and Farming](#) The Environment lots of great links

[PRODUCING TEXAS FRUITS AND NUTS ORGANICALLY](#)

I think you would enjoy checking out Howard Garrett's web page at [www.dirtdoctor.com](http://www.dirtdoctor.com) Mr. Garrett has an Organic Gardening show on WBAP 820 am radio out of Dallas Texas.

[Sustainable Farming Connection](#) Where farmers find and share information

[Small Flock Series: Incubation of Poultry](#) Jesse J. Lyons Department of Animal Sciences--Hatching eggs — watching an egg turn into a baby chick — is a learning experience for students of all ages as well as a practical way for you to start a small poultry flock.

[market for organic food has now reached critical mass](#)

[Community Supported Agriculture \(CSA\) Farms by State](#)

[Organic Consumers Association](#)

["Peaceful Valley Farm Supply - Tools & Supplies for Organic Farmers & Gardeners since 1976".](#)

[Organic Gardens](#)

[USDA Farmer Direct Marketing](#)

[The Organic Materials Review Institute](#)

[Natural Foods Merchandiser](#)

[Natural Life Mag---Organic Agriculture on the Rise Worldwide-](#)

[mycorrhizal information exchange site](#)

[The Mycorrhiza Project](#)

**ATTRA** Lots of organic information at the Appropriate Technology Transfer for Rural Areas - it is here that you will find the national sustainable farming information center located at the University of Arkansas in Fayetteville.

**OFRF Leads the Way** To foster the improvement and widespread adoption of organic farming practices.

[BIODYNAMICS home page](#)

[CNN Organic Food News](#)

**Cherimoya Country** A Red tail Hawks eye view of Cherimoya Country



Mr. L. London has done a great job on this page you might want to try a web, Metalab and Permaculture online searchable database: [PERMACULTURE Discussion Forum -+- your port of entry to an expanding global network of landtech pioneers -+-](#) or a permaculture course etc. keep an eye on this one site

Check out what I was able to glean from Ifoam 96 from press releases and email [ifoam'96 gleanings](#) .Now IFOAM has a web site at [IFOAM](#) The INTERNATIONAL FEDERATION OF ORGANIC AGRICULTURE MOVEMENTS

[Soil Quality](#) First Direct Evidence Ethylene Biosynthesis Triggers Plant Defense Mechanisms

[The Organic Trust Limited](#) a registered and Department of Agriculture and Food approved body for the Inspection and Certification of organic producers and processors in Ireland

[The Garden Spot](#)

[La'akea Permaculture Gardens](#)

[ORGANIC VALLEY / CROPP Cooperative](#)

[Digitalseed](#). General gardening information, planting schedule, a monthly garden guide and other inform

[Companion Planting](#)

[University of California - Small Farm Center](#)

[Sustainable Farming Connection](#) Watch this site it is growing ,lot of good info and links

This is a flyer I got from the folks were I buy my bio-controls Ricon-Vitova I want to thank them for letting me print it in full as it is a good example of : [Beneficials for biological pest control & sustainable avocado production](#)

---

[Bats on the Web](#) "Bats are not blind, they're not rodents, and they won't get tangled in your hair. The truth is that bats are among the most gentle, beneficial, and necessary animals on earth. "Check out BCI

[earthworms](#)

Could you please ***Let me know how you like it here or just say hi also if you have any information that may be of help to an organic farmer or see any good web pages the kind our***



***readers would be interested in*** please send e-mail to [sals@rain.org](mailto:sals@rain.org) ***Mail me*** as this will give me some idea as to if the homepage is being used and can help make it grow. Thank You : >

[Rodale's Organic Gardening Online](#)

[Garden.com](#)

[Welcome to Organic Gardening Tips](#)

[Grow organic](#) Adam Penenberg gives you a how-to guide.

[CAFF Community Alliance with Family Farmers](#)

[Insects and Weeds](#) This is where I store the good insect and weed links I have found on the World Wide Web

## [This is where I store the links to fruit sites on the net.](#)

[The Plant Tracker](#) It is the only database I know of that actually lists, and allows you to search by, the uses for a plant - whether it's edible, medicinal or used for something else you probably never suspected - like cleanser, wax, or baby diapers. also check out the [PLANTS FOR A FUTURE](#) A Resource and Information Centre for Edible and other useful plants

[ECHO](#) Educational Concerns for Hunger Organization- access our resources and services for small farm tropical agriculture from around the globe.

I made a good friend of Vactav Petrik Sr. writer of Soil Processes. We became friends about 15 years ago he was working in practical microbiology and I was an organic farmer. If you would like to see some quotes from his work press [Understanding the Soil](#) I have taken leaf samples and soil samples of my farm and farms around me and have proved to myself that organic farming works. I get my soil Microbes from Mr. Petrik.Sr.and for years have watched my soil get richer and richer.

[Institute of Organic Agriculture](#) Information about the Institute for Organic Agriculture (University Bonn, >Germany) can now be obtained via Internet: This home page at University of Bonn is in German , English Francais and Espanol.t

## [Organic Growers of Michigan](#)

Earth's Best is a line of certified [organic baby food](#) that provides 100% pure and natural nutrition for infants-all grown without pesticides, herbicides or fertilizers.

## [\[The Ohio Ecological Food and Farm Association\]](#)



## [Canberra \(Australia\) Organic Grower's Society](#)

## [SOW ORGANIC SEED COMPANY](#)

[The Seeds Of Change Web Page](#) Seeds Of Change was founded in 1987 to foster plant life . bio-diversity. We do this by offering certified organic. open-pollinated seeds to the public. .

Suppliers of Organic, [Non-GE\\*](#), or Heirloom (O-P\*) [Vegetable Seed](#) Horticulture Resource List

<

---

[Enter here for even More Links](#)      **Links to other sights on the web that may be of interest**

---

If you don't see Noah's Ark organic produce at a store near you or can't get organic fruit where your live, you can call Diamond Organics. They carry my Cherimoyas, White Sapote, Avocados, Macadamia Nuts, and lemons along with other organic farmers fresh organically grown fruits, lettuces, greens, herbs and roots.To get Diamonds Organics Catalog you can Email them at : [Organics@diamondorganics.com](mailto:Organics@diamondorganics.com). or call them toll free at 1-888-ORGANIC (674-2642) or visit their home page at [Diamond Organics](#)

- [Noah's Ark Press Releases](#)
- 
- [What is a Weed?](#)
- 
- [Sustainable Agriculture Systems Newsletter And The Cover Crop Database etc.](#)
- [Plants and Sustainable Agriculture](#) where you will find other great newsletters . The Rodale Institute International Ag-sieve is one of the best things on the net. Check out volume 7 #1 Vermiculture .
- [Environmental Working Group](#)

Environmental Working Group (EWG) is a progressive not-for-profit, computer-powered environmental research organization that gives concerned citizens the information they need to protect their homes, communities and Planet Earth. The Environmental Working Group is a project of the Tides Foundation, a California Public Benefit Corporation based in San Francisco that provides administrative and program support services to nonprofit programs and projects.

Again, thanks for visiting the don't panic eat organic home page . We hope to see you here again soon.

# Troubled Times



## Square Foot Gardening

---

This week has been devoted almost exclusively to the creating of my summer garden. I use a technique some may be familiar with called "Square Foot Gardening". You make a raised bed using 1"X6"X4' boards so that the bed is (6 inches higher than the surrounding soil), making the bed 4 feet on each side (16 sq. ft.) with a 6 ft. trellis along one side (back). You remove most of the soil to a depth of 1 to 1.5 feet, and replace it with approximately equal parts of soil, peat moss, vermiculite, and a bucket or two of sand so that the level of the bed is about an inch from the top of the boards. After the bed is prepared (smooth, level, etc.) you place small nails at one foot intervals along all sides of the top edge of the boards. Next, using a strong string (nylon is what I use) tie one end of a 4 ft length to a nail, then run it directly across the bed and attach it to the nail on the opposite side. When finished, your bed will be divided into 16 squares of 1 foot on each side. From that point on, think and treat each sq. ft. plot as an individual "little garden".

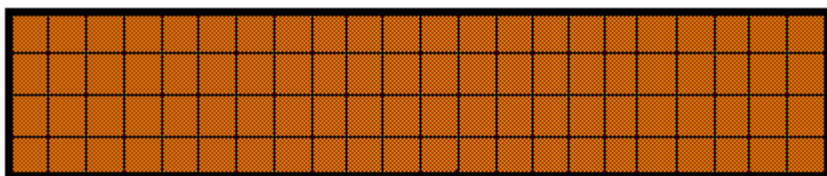

Prior to planting, I will have created a plan (I use project scheduling software - that produces a Gantt chart [schedule]) to determine when, where, and how many seeds to plant for each plot; and when to start and finish harvesting that plot so it can be reused. Using this technique I can have fresh produce the entire growing season in the amounts that can be used at any one time. I use other 16 sq. ft beds to plant single crops that I want to store for the year, i.e. during a 3 year period I was able to average 65 qt. of string beans (using bush beans) per bed. This is very low intensity gardening in that you only need to work individual plots as they need it - depends on how many beds you build as to the actual time required per day. It can also be used for roof or patio gardening by including a bottom for the bed and using one foot wide boards and coating everything in a good water proof or resistant paint. By making the entire bed water tight, it becomes a hydroponic bed. You need to add a place to drain off the fluid so it can be re-used.

The trellis on side is for such things as tomatoes, pole beans, cucumbers, muskmelons, etc. It should be 6 ft high. I use electrical conduit for the structure and twisted nylon string placed appropriately for each climbing plant. You just have to train the plants to twist around the string and they do the rest on their own. I could go on and on about this but would only be re-writing the book. It is quite popular and should be easily found.

### Square Foot Gardening

by Mel Bartholomew  
Dodale Press,  
Emmaus, Pennsylvania

Offered by [Ron](#).



# Troubled Times



## Do-Nothing Gardening

---

Article in *Sedona Red Rock News*, November 29, 1996, by John Cowan

A Japanese farmer, Mansanobu Fukuoka, has developed a new type of natural farming that he calls "do-nothing farming". Despite the name, it took him 50 years of research to perfect his technique, which is based upon doing as little as possible to grow crops. He maintains that Nature is really the best farmer, and given just a little assistance, can provide a great bounty equal to high-tech energy-intensive methods anywhere in the world. Some of his radical techniques include:

- growing rice and clover at the same time - the clover enriches the soil and protects the small rice seedlings;
- encasing seeds in clay pellets - the clay eventually dissolves but in the meantime protects the seeds from birds and rodents;
- never pruning his citrus trees - by growing his trees from seed, he found the trees developed a naturally-efficient central leader branching system.

He also found that he could double crop with the same ground - barley or wheat in winter and rice in summer - while not even plowing the fields and providing only minimal irrigation. To help the process, he developed a variety of low-maintenance rice called Happy Hill. He has also developed a method of intensively fertilizing the land using poultry manure at the rate of about 3,000 pounds per acre. Although his methods have been criticized, the fact that he consistently manages to achieve the best yields in the country is his testimonial. His book, *The Natural Way of Farming: The Theory and Practice of Green Philosophy*, details his techniques and philosophy.



# Troubled Times



## Irrigation

---

There is lots of free tutorial and technical information that could be useful for inside and outside irrigation design - technical data and formulas on flow rates of pipe sizes and head pressures, etc. Jess Stryker's Landscape Sprinkler Irrigation [Design Tutorial](#).

A Department of Rural Engineering and Natural Resource Protection in Germany has a **Virtual Library** with irrigation and hydrology links and information on servers and sites holding information relevant to irrigation and hydrology.

Offered by [Mike](#).

### Solutions Needed to [Conserve Water](#)

*To ensure safe water into the next century, people must first look to agriculture, which uses two-thirds of all water taken from rivers, lakes and aquifers. Most of the world's farmers still irrigate the way their ancestors did 5,000 years ago, flooding their fields, losing most of the water meant to benefit crops. Israel has developed a method called drip irrigation that is 95 percent efficient. Half the country's farmers use it. So do some in Southern California.*



# Troubled Times



## Composting

---

Don't know how much it is, but you can buy a **Compost Tumbler**, basically a steel drum with a nice big opening that sits on some sort of rack by calling 800-880-2345. It doesn't look electric. Hours are 8 to 5 EST on that 800 number.

Offered by [John](#).

I came up with an idea for making an easy composter; take a garbage can with a tight fitting lid, put your composting material in it, put the lid on and lay it on its side, give it a roll every couple of days in a couple of weeks you have compost. Keep it moist, like a damp sponge, and warm. You don't want it to get too hot or it will kill the microorganisms that break down your organic matter. It helps to turn the material to keep oxygen in the material for the microorganisms. My large compost pile that I keep behind the house I just pile it up and let it go, but it takes longer for it to break down, months instead of weeks, but it will get there. I guess that's one reason I started playing with smaller composters to speed up the process. I don't usually add worms to my compost because they usually find their way there; but adding them should help. I guess you could put a hand full in when you put in your organic material.

Offered by [Mike G](#).

Here is a [North Dakota](#) site that might help some folks who would like to know more about composting and healthier gardens and soil. Only 31% of landfill material is composed of plastic containers, the rest is metal, glass, and paper and organic things like eggshells, banana peels, and coffee grounds. If your compost pile smells like ammonia add more brown things like shredded leaves, wood chips, sawdust, or shredded newspaper and aerate. If your compost pile smells like rotten eggs add dry coarse materials such as leaves, cornstalks, or straw to soak up excess moisture. Protect the pile from rain. The recipe for compost is rock pieces, dead things (plants/animals), water, air, and living things (worms/bugs/things you can't see). Mix the rock pieces with other things on the list, leave the mix outside for 1,000 years *or compost!*

Offered by [Kristy](#).

The decay business can be used for our benefit. Right now, the best source I know of are the books on organic gardening and composting. Absolutely *anything* (say for example dead bodies which we will probably be finding without any effort) can be composted, which uses the bacteria already contained within the organism to generate heat and speed along the decay rate. You can collect old newspapers and use them between layers of material to be composted and they, too, will compost nicely. Instead of putrefaction, the end result is basically a flaky brown garden soil additive which aerates (encouraging root growth), has every kind of nutrient, and recycles everything you have left over (like egg shells, last year's dead corn plants, etc.) for minimal waste.

Offered by [Jenny](#).

Well, not everything can be composted. Putting animal material of any kind into the compost heap is not a good idea. Besides the obvious problem of rodents and other vermin invading the heap, you have the danger of microbial infestation. Any diseases or parasitic infestations present will stay present in your food supply. Your waste products of non plant origin need to be purified before use as a fertilizer (especially those end result waste products like urine.).

Also, not all plant material should be composted. Woody plant material (high in cellulose) requires a *huge* amount of nitrogen to break down. This means there would be a need to put a nitrogen source on the heap (like purified urine) to get the corn stalks to break down into the brown flaky material Jenny describes. Of course some woody material is

good (I use a small portion of shredded newspaper in my compost to help retain moisture), but you would do better if you let that stuff dry out and burned it for heat. Then the ashes could be scattered over your soil directly - no composting needed. Also, if you plan to maintain some domestic animals for any reason (food, leather, pets, etc.) and they can eat plant material (like cattle) then you could feed them the straw from your wheat. Alas, if you're growing mushrooms, you might want to incorporate the tough woody waste into your growing box anyway (but not your compost pile unless you want mushrooms in your garden, too).

Offered by [Roger](#).





# Troubled Times



## Continuous

---

Year-round production is a little hard to manage. It depends on the life-cycle of the plant in question and the amount you intend to harvest at any one time. Lets take peas for instance. Normally they have a life cycle of 45 to 60 days. You should decide how many peas you want to harvest for food and how many you want for seed. The ones for seed are going to take longer (perhaps up to 90 days) so place them someplace were they are not going to get in the way. The ones for food should be spaced so that they are not too crowded. This will allow for room to plant the next crop in the same place. Wait until they have bloomed and you are sure that you don't have any diseases in the crop and then plant the following crop (about 30 days). When the first crop is about finished (app. 60 days) the next one should be blooming. Carefully pull the first crop and plant the third crop, and so on.

If you're going to employ rotation (highly recommended) then you can plant them closer together and just plant the following crop in the next area. Of course the rotation is easier to manage with the seed crop. After the onset of seed pods, plant the next seed crop in a new area. When the seeds have been harvested from the first crop, plant the next veggie.

Offered by [Roger](#).



# Troubled Times



## Soil pH

---

I have noticed that green onions or scallions grow wild consistently in acidic soils such as pine needle piles.

Offered by [John](#).



# Troubled Times



## Temperature

---

As I go through some gardening videos and books, I realize the importance of stocking up on a few soil thermometers. These can help us maintain soil temperature around an optimal 70 degrees-F (21 C). We can raise or lower this temperature through various mulching techniques. The video *How to Grow Cool-Weather Vegetables* (1986, Kartes Video Communications) makes a very important point: Soil temperature is much more important than air temperature. So if some of us choose a soil-based growing method in addition to hydroponics, we can start thinking now about protective coverings that will keep soil warm, thus increasing the productivity of our plants. Those coverings will include plastic canopies over the garden beds, as well as plastic mulch directly over the soil. One more important point from this video: By adding four to six weeks of growing time on both ends of the season with proper covering techniques and by effectively applying the succession-planting method, we reduce the need to store as much food.

Offered by [Mike](#).

This is true in most cases that soil temperature is more important than air temperature. But some transplants will not survive not matter how warm the soil is, if the air is too cold. Regarding plastic canopies over garden beds, where are you going to get this plastic? And when all your pre-stocked plastic is torn to shreds, then what? Plastic is not an option. Also, your beds should/would already be covered by the dome to facilitate providing light for the plants. The prediction is *no* sun for 15+ years for most people! Heating the soil by coverings is irrelevant as within the domes we have direct control over the "seasons."

Offered by [Roger](#).



# Troubled Times



## Color

---

Article from the March 24, 1998 *New York Times*

### **Science Watch: A Shade of Difference**

By Karen Freeman

For a plant protein that was dismissed by skeptics in the 1950s, phytochrome has come a long way. Because of it, growers who want the best and biggest tomatoes, strawberries and other crops need to be as fussy as an artist over the color of the plastic mulch they put in their fields. The protein directs plant growth and development in response to different kinds of light. And because of that, growers need to concern themselves with a color they cannot see, the far-red light that is just beyond the horizon of human vision, as well as the normal colors.

Green leaves reflect far-red light, so plants can be fooled into thinking that they have lots of neighbors - and competitors - if they are bordered by mulch that reflects plenty of far-red wavelengths. In response, the deceived plants put more energy into their above-ground growth, and that means bigger tomatoes or strawberries that mature faster. They taste better, too, said Dr. Michael J. Kasperbauer, a plant physiologist with the United States Department of Agriculture in Florence, S.C., who has been manipulating lights to manipulate plants almost since the existence of phytochrome was proved in 1959. A patented red plastic mulch developed by Kasperbauer and Dr. P.G. Hunt and manufactured by Sonoco is being sold to growers and gardeners.

Strips of plastic mulch have long been known to help conserve moisture in some situations, but now scientists' attention is on mulch colors - whites, yellows, blues and greens - to see how they can enhance things like flavor and insect control. Want a better root crop, like turnips? Pick a mulch color, like orange, that reflects much more red light and little far red. The plants, not fretting about competitors, put their resources into growing bigger roots. The possibilities seem endless. "It's kind of like being a little kid on a merry-go-round," Kasperbauer said. "It's too much fun to stop."



# Troubled Times



## Indian Way

---

We plowed the little garden up every year. I gathered leaves every year and put them down the middle of the rows until the plants got high enough. Then I put them around the plants later. I remember one year it rained continually, if it wasn't for the leaves we wouldn't have gathered anything. If it is dry weather the plants will stay moist longer. We didn't plant for several years then but continued to mulch. I told my husband to gather the grass or leaves in the catcher and throw them on that piece of land. I'd throw my peelings and egg shell on the ground also. I told my husband that I was going to plant like the Indians and just poke a hole in the ground. My husband made a pencil shaped edge on an old shovel handle. I would drill a hole with this tool and drop the seed in the hole. It works well, the garden did very well. It is an easy way to plant.

Offered by [Ivy](#).

I believe that some Indians also would deposit a dead fish in the soil with the seeds. I know my Dad showed me this one time when we were planting corn in the backyard.

Offered by [Jon](#).



# Troubled Times



## Raised Beds

---

It's Springtime and many people are preparing their gardens. By now tillers have been brought out of storage or rented and those old plots have been turned over. There are even a few new plots being made, but what about those people that live in apartments, mobile home parks, or on small city lots? There aren't many gardens in those areas, yet I refuse to believe that it is because those residents don't want a garden. Perhaps it is because they don't have enough room to put in a garden. This is because a traditional garden in the US requires (ideally) 50 feet by 20 feet of space. Fortunately there is a method of gardening that has been around longer than the US that can be used by all gardeners to conserve space, especially in small areas such as mobile home parks and apartment complexes. This method goes by several names (such as the square foot method, growing beds, and biodynamic French-intensive method) but is more readily known as raised bed gardening.

The professional gardener should already be aware of this method (because this method is more widely talked about in the published gardening venues than any other method), but may not use it due to personal choice. Unfortunately the amateur gardener (commonly referred to as the hobbyist) may not know of this method (unless he or she has researched gardening for solutions to problems with his or her existing gardening). So why is raised bed gardening not the preferred method? It could be because of the history of gardening in the United States. Nevertheless, raised bed gardening is better than traditional American gardening because it prevents soil compacting and erosion, uses space more efficiently, and produces higher yields.

The plow and the tractor were great aids to the early farmer and planting in long rows was a necessity since it was difficult and time consuming to turn around and plow the other direction. Tillers work best in straight rows and it is still difficult and time consuming to turn them around to return to the other end of the garden. If we look further into history we see that row cropping (traditional method) is pre-dated by raised bed gardening. Raised bed gardening was (and still is) widely used by the rest of the world. Farmers throughout the Orient have used raised beds for over 4,000 years. The Chinese continue to depend heavily upon raised beds. Even the ancient Babylonians used raised bed in their Hanging Gardens and the Greeks wrote about this method over 2000 years ago. In the Americas, the Aztecs used beds exclusively for all of their crops, colonial America used raised beds, and the Oneota used a form of raised bed called ridge-till to grow their crops on a flood plain, Raised beds were used to maximize yields with minimal space or to overcome soil fertility problems.

Offered by [Roger](#).



# Troubled Times



## Less Space

---

The three most important concerns of the gardener are soil compacting/erosion, space limitations, and plant yields. The traditional gardener is forever battling the first and because of the second concern is forever wishing for more space to increase the final concern. When planting in rows, the soil between rows is the pathway and little or no distinction is made between plant row and path. Rain water and irrigation collects everywhere and causes erosion as well as making it difficult to tread in the garden (due to the amount of mud). In order to get higher yields the gardener must increase the size of the garden because there has to be so much space between rows of plants.

The raised bed garden overcomes the concerns of the gardener quite easily. The first concern (soil compacting/erosion) is defeated simply by reserving a piece of land for plants. The top soil is removed and the subsoil is loosened. When the "bed" is loosened to a depth of 18 to 24 inches, the top soil is replaced. The act of loosening the soil will bring the height of the bed to approximately 6 to 8 inches above the surrounding soil. The bed is usually kept within the dimensions of 5 feet by 20 feet since they are not to be disturbed by the gardener's feet. Since the bed is never stepped in, the soil never gets compacted. Each year the soil is worked lightly with a hoe (to mix in fertilizer) and raked into shape again. A tiller is never needed to rework the soil. Because the bed is above the level of the surrounding ground, flooding is never a problem and therefore erosion is minimal. The pathway between beds can be left in grass or covered with mulch (hay or grass clippings) to further reduce flooding and erosion.

As before, the beds are no more than 5 feet by 20 feet. A completed bed has 100 square feet of planting space. This is almost a third of the planting space of the traditional 50 foot by 20 foot garden (32% of 1000 ft. is 320 ft.). The pathways between beds are usually 1 to 2 feet so they take up minimal space. Hence, the mobile home park or apartment complex resident can easily construct one or more beds. Multiple beds do not have to be adjacent and obviously do not have to be 5 feet by 20 feet. (My 5 beds are 2 foot by 10 foot.) The pathway can be left in grass so the beds would easily fit into any amount of available space.

There is also the method of interplanting where more than one variety of plant can share a bed. Interplanting is somewhat complex so the amateur should consult a text such as **Getting the Most from Your Garden** by the editors of *Organic Gardening Magazine* (copyright 1980 by Rodale Press, Inc.). With the ability to interplant and place beds in any available space, the amateur gardener is able to ignore the seed packet directions for row spacing and plant at least twice as many plants simply by following the plant spacing in every direction (carrots are planted 3 inches apart in every direction instead of 3 inches apart in rows 12 inches apart).

Offered by [Roger](#).



# Troubled Times



## Increased Yields

Obviously, with decreased space limitations, yields will increase. Just how much they increase depends upon who is consulted. My father has gardened in raised beds for over 20 years and has records for each year. He will tell you that you can expect at least double the yield of the same amount of space in a traditional type of garden (personal interview). Pete Lane asserts in an **Ohio State University Extension Fact Sheet** that “In a traditional home garden, good management may yield about 0.6 pounds of vegetables per square foot. Records of production over three years in a raised bed at Dawes Arboretum near Newark, Ohio, indicate an average of 1.24 pounds per square foot, more than double the conventional yield”.

Dan Wallace, editor of *Getting the Most from Your Garden*, presents a table on page 7 that compares national average yields using the traditional method with the yields from John Jeavons’ experiments with raised beds at **Ecology Action of the Mid-Peninsula** in Palo Alto, California. That table is partially reproduced below.

Plant	Conventional Garden national average yield (lbs./100 ft.2)	Growing Bed Average (lbs./100 ft.)		
		Beginner	Intermediate	Advanced
Bean, snap	8.2	30	72	108
Broccoli	17.4	39	72	108
Carrot	58.9	100	150	1,080
Corn	15.3	17	34	68
Lettuce, head	48.6	75	150	300
Lettuce, leaf	48.6	135	202	540
Onion	68.6	100	200	540
Pepper	18.8	36	83	131
Tomatoe	30.7	100	194	418

Offered by [Roger](#).





# Troubled Times



## Mini-Farms

### **Mini-Farming: A Sustainable Farming System**

George Kuepper, *Kerr Center/ATTRA*.

During the mid-1970s, an interesting alternative production system was gaining both notice and respect. It was referred to as the French-Intensive/Biodynamic method, because it shared techniques and philosophies from both these European farming systems. In more recent years, the name has evolved to Biointensive Mini-Farming [BIMF]. A mini-farm is small. It looks like a large, diverse garden, with an arrangement of raised beds and paths rather than traditional rows. Equipment, such as rototillers, tractors and plows, is totally absent. [hand tools and hand implements are used: wheel hoes, string trimmers, etc. KH] BIMF is an organic system. Synthetic pesticides and commercial fertilizers are not used. Its organic character means less pollution of the environment and a more stable agroecosystem, where natural, biological control agents proliferate. Beds and the paths between them become permanent. Growers avoid walking on finished beds to reduce compaction. Likewise, no fertilizer, water or extensive tillage is wasted on paths.

Beds are fertilized routinely with large quantities of compost and supplements with other natural fertilizers if needed. The proper production and use of compost is paramount to maintaining soil fertility. BIMF permits the use of manures but depends mainly on vegetation-based compost. Proponents feel heavy reliance on manures creates nutrient imbalances (Jeavons1979).

On the other hand, a great variety of vegetation can be grown on-site. Even in urban situations, an abundance of plant materials, such a leaves, grass clippings and kitchen scraps is usually available. Double-digging and concentrating fertility into beds allows for high population of crops. Companion planting is also used to maximize space and gain added pest control and fertility (Philbrick and Gregg, 1966). Potential of BIMF Since BIMF needs little land or capital, it has been of particular interest to agencies that aid subsistence farmers in developing countries. It has also captured the imagination of many gardeners in industrialized nations. Some believe BIMF may effectively address many of the ills of modern commercial agriculture both in the United States and abroad. Certain characteristics of the system lend credence to these assertions.

BIMF is highly productive and has been found to grow two to four times as much food per unit area as conventional agriculture. Cucumber yields have ranged from 9 to 15 times the national average. Carrots have not exceeded 2.5 times the national average in 17 years of evaluation. Of course, the skill of the grower and the fertility of the beds are relevant factors (Jeavons, 1989). Jeavons (1976) estimated that one mini-farmer working 40-45 hours per week could produce enough food for 24 people on about three-quarters of an acre. These figures came from attempts to provide a complete diet using BIMF in northern California. Researchers at Janus Farms Institute in the Piedmont region of North Carolina have reached comparable results (S Jamir, 1994, personal communication).

BIMF requires fewer off-farm inputs. Many practitioners rely only on compost. Those who employ other fertilizers use half the amount of organic nitrogen typically applied. Compared to conventional American systems, BIMF uses 1/3 to 1/31 the amount of water per pound food produced. After a balanced soil is achieved, BIMF also conserves energy. It consumes 1/100 or less the human and mechanical energy of mechanized farming (Vesechy, 1986). BIMF wastes little. Nutrients are recycled through the composting of all crop waste. Cover crops, plant diversity and limited tilled ground ensures little loss of soil and

nutrients to erosion and leaching. BIMF practices also have the potential to build soils for long-term production. Research has shown that 500 years worth of humified soil carbon, a major indicator of fertility and soil maturation, may be accumulated in as little as eight and a half years. Furthermore, this increase in soil carbon may be accomplished by employing a closed system in which a portion of the crop is grown specifically for making compost (Jeavons, 1989).

Capital requirements are one of the most significant barriers to entry in modern agriculture. BIMF uses small areas, does not need expensive irrigation equipment, avoids the purchase of petroleum-fueled cultivation and harvesting machinery and reduces expenses for annual inputs. As a result, it is an enterprise accessible to those with limited financial and land resources. In order to keep stewards on the land, agriculture must supply them with an adequate standard of living. By one estimate, a grower might be able to net US\$10,000 to US\$20,000 annually (1978 dollars) on a 1/10 acre mini-farm, working a 40 hour week and taking up to four months' vacation (Jeavons, 1979). [Average gross in 1998 is \$8,000 per acre. A family can garden 3-6 acres. KH] Trends that might favor the growth of BIMF include the heightened interest in locally grown and organic foods. The continued rise of farmers' markets, health food outlets and community-supported-agriculture projects represent marketing options for mini-farmers. Increased consumption of fruits, vegetables and whole grains also favors this system.

Jeff Rast, *Countryside*, Nov/Dec 98  
Available in Spanish, Russian and French

Using a closed system is not necessary when other sources of organic materials are available such as : manure, sawdust, food waste, etc. All the above applies to mini-ranching, as well, with beds producing forages for animals. KH BIMA boasts two advantages which no other production system can claim. First, it is easier on the soil than mechanized methods. Second, it is the least expensive method in terms of capital outlay. For very small farms [mini-farms] this method is not only economically viable but superior to the alternatives.



# Troubled Times



## Classes

---

### Gardens/Mini-Farms Network

Texas: Lubbock, Dallas, Hereford, Nazareth, Happy, Amarillo

Mississippi: Oxford

Florida: N Ft Myers

Mexico, Rep Dominicana, Cote d'Ivoire, Nigeria, Honduras

Workshops in organic, biointensive, raised-bed gardening, market gardening, mini-farming, mini-ranching worldwide in English & Spanish

Tel 806-744-8517

Fax 806-747-0500

[minifarms@aol.com](mailto:minifarms@aol.com)

Box 1901

Lubbock TX 79408-1901

I am available to train people in biointensive mini-agriculture. What I teach is not new. Organics with raised beds were used for centuries. While living in Guatemala I saw only a few. The problem is that they have been forgotten due to the use of chemicals. A family can produce all the vegetables needed for a vegetarian diet on 1000 ft<sup>2</sup>. 25% to 50% of the food consumed in any third world city is produced within the city. Urban ag is very important. The improved nutrition is more important than the increased yields because of the improved health and reduced medical needs.

I teach:

- A.** Organic, biointensive, double dug, permanent raised beds using green manure/cover crops/mulching/compost. This can double and even triple the yields while reducing the labor by half compared to traditional gardening.
- B.** Organic, biointensive, permanent raised beds using no-till, green manure/cover crops/mulch/-compost.
- C.** Agroforestry: Trees [fruit, nuts, oils, chemicals, medicinals, spices, crafts, timber, forages, firewood, windbreaks, chicle, industrials, etc] should be a planned crop just like all the other crops. Can use bucket drip irrigation.

1. Forestry: No clear-cutting but manage-harvested for natural crop production using raised beds for specific crops. Yields for 4-5 hectares: pasture=US \$50 annually; clear-cut=\$1000 one time; manage-harvested=\$5,000 annually.

2. Alley Cropping: Raised beds between rows of trees.

Bucket drip irrigation kits should be used to produce food during the dry season and in areas of low rainfall. The kit [US\$15+P&H] irrigates 200 feet of vegetables by filling a five gallon bucket each morning and each evening. Two kits will produce all the vegetables needed by a family of seven [vegetarian diet] during the dry season [Kenya]. Use only family labor with hand tools, scythes, etc. No outside inputs. A three day workshop teaches farmers principles they can use the rest of their lives to feed their families and to help others. Workshop classes are practical and how-to. I take unfamiliar, open pollinated seeds, reference books [English, Spanish, French, Kiswahili, Arabic, Russian,

German], videos [drip & biointensive] and I order free magazines [English, French, Spanish, Portuguese] if there is a library/office. I take sample handtools for a blacksmith to copy [most of which they have never seen] and irrigation kits. I demonstrate irrigation and making a raised bed. Reports are available on Côte d'Ivoire, Nigeria and Honduras. Funds must be provided or raised for each trip.

### **Ken Hargesheimer**



# Troubled Times



## Plowing

---

In the last 20 years there has been one great and effective gardening technique after another, and most *all* work better than the old plow. That is, they work for the family gardener. I only used row gardening the first 3 years until I learned better, and have continued to implement new methods ever since. My last large raised bed garden was 5 ft beds 20 ft long, 8 of them. I used the large rear tine Troy-Built tiller and a land-scape rake to prep and shape the beds. The most difficult part was harvesting the produce. There are hundreds of agricultural schools in the US alone. Today's farmer is very well educated, uses a computer and modeling just as much as his tractor. Today's farmer has a cash flow in the millions each year. They try *anything* that will increase their yields. In California, beds are used to raise vegetables commercially. So where it is the best way to go, that is what becomes the commercial practice. Farmers farm the way that they do because it produces the most bang for the buck. It's just as simple as that.

Offered by [Ron](#).

Plowing is a "faux pas" today. What one should be doing is putting mulch over the soil. The mulch breaks down the soil and provides nutrients. Plowing breaks up the soil and also allows the best soil, the "top" soil, to blow away in the wind. I live near one of the largest farm conglomerates in the country. They have over a 1000 acres. They plant corn and soybeans. They do not plow. They apply seed and mulch. Don't worry about plows, worry about mulch.

Offered by [John](#).

Plowing is done for weed reduction and to eliminate soil compaction. Both of these can be accomplished without plowing. There are several research farms throughout the US that employ raised bed techniques rather than row cropping and report outstanding yields. True, the labor requirements are greater in terms of hand labor, but when you compare the cost of fuel, maintenance of equipment, etc. you will find that raised bed gardening is the way to go after the pole shift!

Offered by [Roger](#).



# Troubled Times



## Mass Production

---

In the 20's and 30's, Victor Schauberger in Germany was asked to study why some farmers, usually the poorer ones on smaller lots, were getting better crop results than their richer neighbors. It seems the poorer farmers usually used a plow made of wood or copper as opposed to the "new" steel plows. Apparently the plow material made a difference, with copper being the best as far as the resulting plant growth. Also the poorer farmers were plowing the rows north/south in direction, and not in a straight line. These two features apparently maximized light exposure. In addition, the poorer farmers plowing contained larger clumps of dirt which prevented wind and water erosion.

Offered by [Steve](#).



# Troubled Times



## Bike Plow

### Bicycle Powered Plowing

A plow mounted on three or four wheels. Could use one or two bicycle mechanisms (one or two riders) without the wheels mounted in the front so the weight of the person helps hold down the whole mechanism. Bicycle parts modified to wind the cable onto a drum. Would take some thought to get the correct gear ratio. The angle of attack of the plow with the ground would be adjustable, so that depth the plow penetrates the ground is adjustable. Allows one to pull the plow up to move the unit to a new row. The wheels are free to turn on the axles and roll forward as the cable pulls it.

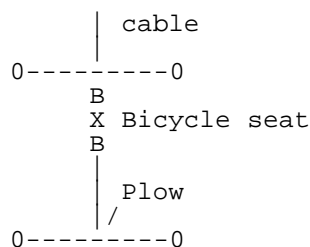

### Battery Powered Winch Plowing

An electric Winch like used on the front of a Jeep could be mounted up front. Batteries located just behind this. One could sit on a seat above the batteries to add mass to the unit or hold it down. Plow adjustable as describe above. A electric motor with adjustable belt tension drive could be mounted on one or two wheels to be used to power the unit to the end of a new row. Drive belts relaxed when cable is pulling the unit. Unless we can come up with a good movable anchor I think one could build two of these units and have them pull toward each other. Move over a row, move to the ends and do it again.

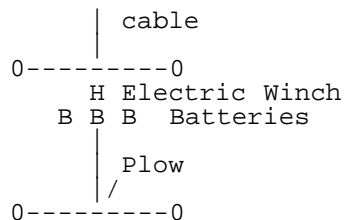

### Modified Tractor

A farm tractor could be stripped down, with an electric motor or modified bicycle mechanism used as power. The engine could be taken off or striped down, the flywheel used, along with the starter gear for the interfacing point for the electric motor or human power. The existing transmission (gear type) would be used in the lowest gear. Beyond this one could use bicycle parts to gear it down more. Batteries could be charged with a portable (or not) windmill over the long nights.

Offered by [Mike](#).



# Troubled Times



## Spool Plow

---

I think we need to keep in mind that we're not having to do the work of an 8 row tractor. We're talking about the work of 1 horse power. I've been checking out the various sizes of power cable. They come in all sizes and I think the smallest is between 1/4th and 3/8th inch. I think a single pulley attached to the plow stringing the cable from the spool through the plow pulley and back to the movable frame and anchored is all that would be needed, especially adding the gearing of the differential. Cable in very long continuous pieces will be available laying on the ground from downed power lines, which are aluminum stranded cable of various diameters.

To pull it along the row, I envision a large wood spool salvaged from a power company, phone company, cable company, etc. about 3 feet in diameter. This would be mounted vertically on a pole (cut from a common power line pole) sunk 5 feet in the ground - deep as a common post hole digger will go, and about 5 feet above ground. It would have 4, 3" diameter by 6' wood pieces attached to the "top" of the spool. These would be used by 4 people who would walk in a circle around the spool pushing the attached "push poles", turning the spool. One person would operate the plow. That makes 4 people-power to pull the plow. If one just adds one pulley, that makes the equivalent of 8-people power. A 2 spool pulley would be 16 people-power, etc.. I think that would certainly do it.

If one mounted the spool in the center of one end of the field and placed a pole permanently at the end of each row, by attaching another single pulley to the pole at the end of the row being plowed, the main "working" spot need not change - just move the "row" pulley to the next pole when starting the next row. With an identical setup at the other end of the field, you would need 8 "walkers" instead of 4; but the total number of people required to work a field would still only be 9. While one group works, the other group of 4 rests. The plow would stay attached to both sets of pulleys, so that when it reaches one end of the field, the other pulley has been "unspooled" and is ready to pull the plow the other direction.

Offered by [Ron](#).

This is an inventive use of commonly available items. I see a slight problem with the design - in that once one encounters the path of the cable, a person would need to duck down and possibly let go of the wood bar that is being pushed around for a short space of the turn. After a while in the low light conditions, this cable might get to be tiresome and hard to see. With each person letting go of the bar at one point along the turn, this loads the bearing the spool rides on which adds more friction, and also tends to loosen the post in the ground due to side thrusts.

You may want to consider some alternatives. If one puts the spool at ground level, then one would need to step over the wire on each turn as one pushes it around. So this is still not optimum. One could build a platform about 3 ft. high to walk on so that the people pushing are above the wire. Another possibility is to have the wire go through a pipe that one steps over. Another possibility is to have the spool above one's head and the push bars on the bottom side of the spool. In this case, one has to carefully consider the forces involved on the center pole in the wet ground. The base would need to be strongly braced in this case. Still might need to duck down but at least you wouldn't need to let go of the push bar and cause extra load to the others pushing.

Offered by [Mike](#).







# Troubled Times



## Axle Plow

---

Another alternative is to use a rear-end-axle combination taken from an abandoned truck after the pole shift. The tire would be removed from one wheel rim. The rim would be mounded on one side for the cable to wind up on. Cable would go through the valve stem hole and be tied off or a wire clamp used. The axle on the other side would be prevented from turning either by locking the mechanical break permanently set or by chaining the rim in such a way as to not allow the shaft to turn. The unit could be put in the ground with the axle housing partly below ground level with the pinion shift sticking straight up. A trench would be dug in the ground so the wheel rim could turn. The top of the axle housing would be just at ground level, arranged such that one will not trip over it as one walks over it. Wooden posts or logs would be dug and set into the ground to hold this unit anchored to the ground to keep it from moving. The cable would end up about 1 to 2 ft off the ground. One would not walk over the cable to turn the pinion shaft.

A piece of the rubber tire would be cut out to fit tightly on the pinion shaft. This would be cut to fit to keep water from running down into and past a possible old pinion gear oil seal. The drive shaft and universal joint would be put back on the pinion shaft so as to stick up in the air perpendicular to the ground. Logs or wood, 4x4 timbers firmly placed in the ground, could be used to hold this in place so that the shaft can still turn. Depending on the length of the shaft, the yoke at the other end would be fitted with wood, bolted through the two large holes that previously had a U-joint. This in turn could be bolted to as many cross members as you have labor to push the bars as has been described. The push bars would not be long enough, causing it to be necessary to walk over the cable. The gear reduction ratio of the rear end would give an advantage and make it easier to push and turn. The wide metal truck tire rim would be stronger and longer lasting than a large wooden spool.

One could use a pulley on a post several feet away from the drum with another pulley-post at the end of each row as you have suggested. This would work at the end of a rectangular field. The post would need to be put in at an angle and braced so as to not be pulled out of the ground with the force involved. All pulleys would need to be extra large diameter if fallen scrounged electrical transmission wire is used. This wire is not as flexible as fine strand steel wire.

Another variation on this. If one had another old car or truck with 4 good wheels then this could be used as a stable platform with this truck axle cable pulley mounted in the center with its axle perpendicular to the axles on the vehicle. The truck or car would be rolled back and forth at the end of the row to be plowed. The cable would come from the center of gravity of the vehicle. The cable could be used to pull the vehicle back and forth using a post at two corners of the rectangular area needing plowing. A pulley would be attached to the vehicle to allow the cable to make a right angle direction change. The cable would pull the unit to the proper row. The cable would then be used to plow the row, then pulled to the next row, and so on. If the car or truck is not heavy enough, then dirt can be used as a ballast.

Offered by [Mike](#).



# Troubled Times



## No Plowing

---

I live near one of the largest farm conglomerates in the country. They have over a 1000 acres. They plant corn and soybeans. They do not plow. They apply seed and mulch. Those rows from your childhood are gone. They handle weeds with weed killers. One of Monsanto's best customers. Seeds are put in the ground with a seed spreader - 24 across. Hard ground is handled with irrigation. Seed is applied, mulch is applied after.

Offered by [John](#).

Aeration of the soil is necessary to alleviate soil compacting. Although some plants do require air at their roots, most find any air uncomfortable and even harmful. Plants left alone in nature do quite well without plowing or tilling. Of course these plants do not suffer from our intervention with the natural process by applying herbicides and fungicides and messing with the natural bacteria and other micro-organisms that naturally decay dead plant and animal material and keep the soil from becoming compacted. Look around you and try to follow the example of Nature. Allow your garden space to become a natural ecosystem and only interfere with human technology when necessary (by pulling weeds and applying organic repellents and/or insecticides when the harmfuls start to overwhelm). You will find that your harvest is the best tasting and most nutritious you've had in years!

Offered by [Roger](#).



# Troubled Times



## Mulched Seeding

---

Don't use straw for mulch. Use grass clippings or alfalfa hay or peat moss. These three mulches do not draw heavily on the nutrients in the soil as they decompose. Prairie hay is also acceptable, except it is usually cut and baled after seeding so you'll be seeding your garden with numerous weeds. Straw is not good because it draws too much nitrogen from the soil as it decomposes.

Offered by [Roger](#).

Peat moss isn't nearly as effective a mulch as are common leaves. The whole reason for adding peat moss to soil is to add organic matter and especially to hold moisture and "lighten" the soil. Where I'm now located, the soil is a rich loam and doesn't really need anything added. In Oklahoma where the soil was dry and hard, peat moss added in large quantities worked wonders. In Mississippi, the soil had a very high clay content, which when dry is almost as hard as concrete. In West Texas, the soil was very sandy and peat moss worked well for holding the moisture. Besides, peat moss just laying on the ground makes a great growing medium for weeds!

Offered by [Ron](#).

Peat moss does do wonders for rock-hard clay (which we also have here in Missouri) and is highly recommended as a soil amendment. But the biggest problem with using peat moss as a mulch on top of the soil is that when dry, peat moss is very light and will blow away with the first strong wind! The best things to use for mulch are either fresh high-nitrogen vegetation such as grass clippings (watch out for pesticides!) or long lasting, slow to decay mulches such as bark nuggets or cocoa hulls. Fall leaves do work as mulch but often contain weed seeds and are prone to anaerobic decomposition when they just sit in soggy layers (i.e., they can stink!). I personally prefer to shred and compost leaves, using the compost in planting holes for transplants.

Offered by [George](#).



# Troubled Times



## Mud Seeding

---

Right after the pole shift, under almost continuous rain, plowing in some areas will become adventurous, akin to playing in the mud. Under these conditions it might be better to simply push the seed into the ground a measured depth. If there are a lot of weeds and roots that needs breaking up and turning over, then plowing may still be required.

Offered by [Mike](#).



# Troubled Times



## 1 Feeds 6

---

The plow was invented to allow farming of larger and larger areas of land back when land was in abundance and there were no concerns about space requirements. The primary feeder of the family used to be the smaller scale garden. It should still be! We are talking survival here, not the few feeding the many! Modern agricultural techniques allow one farmer to feed 100+ people. In the distant past, one horticulturist could feed 6 people. The horticulturist acted alone. The farmer still depends on many people to get his crop delivered. The modern farmer along with all his co-workers in the distribution chain still only provides enough food for 6 people. The ratio hasn't changed, only the methodology.

I have grown up with raised bed gardening. My father had over 4000 square feet of raised beds when I was a kid. He fed a family of 6 quite well, as well as the neighbors, and has been a long time member of Seed Savers Exchange. Each year he would apply composted material on each bed, then he would use a digging fork (potato fork or root fork) to turn the compost into the dirt. My father has since reduced his garden size. Now that he is older and doesn't have us kids around to help, he uses a small cultivator-type tiller to mix the compost into the soil and he heavily mulches the walkways.

My family garden is close to 500 square feet. I cut each bed right out of the sod, leaving the proposed walkways alone, and edged each bed with cedar. Each year I spread compost and mix it in. I have done this with a digging fork, but use a cultivator as well. Raking and maintaining the bed shape is a breeze compared to what I grew up with since I have basically made boxes to contain the soil. Also, I have never had a problem with compaction! I turn the soil to mix in nutrients, not to loosen it up!

Offered by [Roger](#).



# Troubled Times



## Acreage

---

While looking through some notes I had from my father, I discovered a couple of very important things that we have been seeking for a long time. The first is that my father once performed some calculations based on research he had conducted into space requirements for food production. He is the source on this as all I have is a scrawled note on a sheet of lecture notes from when he taught a gardening class many years ago. The results of his calculations were simply that the food (calories and nutrition) needs for a family of six (the size of his family at the time!) would be taken care of with as little as 4000 square feet of growing space. He used (still uses) raised beds that were 100 square feet each, so that amounted to 40 beds. This calculation assumed canning, freezing, etc. as well as modest seed production for future planting. Since the growing season in Kansas is roughly 6 or 7 months long, I think it might be reasonable to halve that requirement when considering year-round production indoors in either hydroponics or containers, etc. So, for a community of 6 persons, one needs to have growing space sufficient to plant 2000 square feet of vegetables. Which vegetables? That is mostly for you to decide.

Offered by [Roger](#).

What you have provided is vital information. This is approximately 333 sq. ft/person. Does this include sq. ft necessary for access walk paths between the 100 sq. foot plots? How wide should these paths be? Also, I forgot the optimum dimensions of the 100 sq. foot plots. Was this 20 ft long by 5 ft wide?

Offered by [Mike](#).

That requirement was planting space only. Walkways, etc. are extra. The 100 sq. foot beds are usually 5 x 20 or 4 x 25 (in feet).

Offered by [Roger](#).



# Troubled Times



## Temperate Climate

---

After the pole shift, vegetables can be grown in greenhouses and/or hydroponically. However, we should not wait until *after* the pole shift to learn about what it takes to make a wide variety of food plants grow. In the next few years, I encourage people to at least grow a small garden so that you can get the basic hands-on experience in this area. After the pole shift you will not be able to walk down to the grocery store for food: You may have to find ways to provide food for your family over an extended gardening period (during times when most gardens are dead from the cold). This technique extends the garden's life and harvest on both ends of the usual gardening season.

This technique is effective in temperate climate, for:

1. in the early Spring -- to start the gardening year extra early (so you can eat vegetables a month or two sooner than usual)
2. and in the Fall to extend your harvest a month or two (you can keep the killing frosts off your plants by providing a transparent shelter for them to continue their life cycle).

Here in a temperate United States climate where I live, the first killer frost arrives in mid-November. A thick frost will blanket the garden for most days in December through February. However, I garden year- round and provide about 80% of the vegetables for my family of four. My garden consists of twelve beds, 4 feet wide by 30 feet long. I bury drip irrigation lines a few inches below the surface of each bed in the Spring, and the entire area is watered according to my programming via a small, inexpensive, battery operated water-timer.

During the winter I have 4 or 5 beds in production. The way I keep the vegetables growing is by covering each bed with a long igloo like structure, covered with plastic. The ribs supporting the plastic are simply

the 3/4" white PVC pipe, 10 feet long or so, available at any hardware store. It is quite flexible -- stick the ends of the pipe a foot into the ground on both sides of the bed. This makes a half circle. Continue this all the way down the entire length of the bed, putting the ribs 4 feet apart. On top of this you can stretch plastic. Tie the plastic to the pipes by using twine or green plastic plant tape. The final product you've made is a small greenhouse that perfectly covers the growing area for your plants. This keeps the killing frosts off your vegetables and provides many more degrees of warmth -- this is necessary as the goal is to keep the plants' metabolism operating smoothly and continuously, throughout the plants life cycle.

Of course, experienced gardeners know of this technique, so I am not talking to them. But, this is especially for all those who are new to gardening or haven't tried winter gardening: the igloo tunnel is excellent for extending food production through mild winters. And in harsh winter areas, try the igloo method to get a jump on Spring. If done correctly you will be harvesting food a month or two earlier than previous years.







- [Home](#)
- [Outreach](#)
- [Contact Us](#)
- [County Offices](#)
- [Directory](#)
- [Employment](#)

- ⇒ [Gardening and Horticulture Home Page](#)
- ⇒ [Swift's Gardening Blog](#)
- ⇒ [facebook](#)
- ⇒ [Follow @CurtisSwift](#)
- ⇒ [The Arboretum](#)
- ⇒ [Climate Information](#)
- ⇒ [Definitions](#)
- ⇒ [Donate to the Ute Learning Garden](#)
- ⇒ [Flowers](#)
- ⇒ [Fruit](#)
- ⇒ [Garden Clubs, Societies and Botanical Gardens](#)
- ⇒ [Hardiness Zone Maps](#)
- ⇒ [Hops Production](#)
- ⇒ [Houseplants](#)
- ⇒ [Landscape Professionals](#)
- ⇒ [Lavender Project](#)
- ⇒ [Master Gardener Program](#)
- ⇒ [Mulch](#)
- ⇒ [Native Plant Master Program](#)
- ⇒ [Pest Management and Pesticides](#)
- ⇒ [Soil](#)
- ⇒ [Trees and Shrubs](#)
- ⇒ [Turf](#)
- ⇒ [Ute Ethnobotany Learning Garden](#)
- ⇒ [Vegetables](#)
- ⇒ [Weeds](#)
- ⇒ [CSU Extension](#)
- ⇒ [Search CSU](#)
- ⇒ [Ask an Expert](#)

## Gardening and Horticulture, Colorado State University Tri River Area Mesa, Delta, Montrose, & Ouray Counties

Last updated:

### Seedling Tree Program

Once again CSU Extension will be offering Seedling Trees in cooperation with the CSU Forest Service. CSU is currently taking orders for the seedling trees; the trees will be ready for pick-up the end of April.

To qualify for the program you must:

- ▶ Own two or more acres of land
- ▶ Use the seedlings for conservation purposes

Bare root trees, small potted and regular potted trees are offered in lots of 25 or 30 at a nominal cost. There is also a very limited supply of extra large potted trees. Over 40 different species are available – from Colorado Blue Spruce to Lilac to Native Plum.

Contact [Ginny Price](#) at CSU Extension at 970-249-3935.

### Master Gardeners for Hire

The individuals on this list are registered as active members of the Tri River Area Colorado Master Gardener program. When hired they are independent contractors and not serving as Colorado State University Master Gardeners. The list provides what tasks they will perform to keep your landscape and gardens in tip top shape.

[Tree Care Providers licensed - City of Grand Junction](#) Be sure to hire a company that has been vetted for its professionalism and abilities.

### The Mission of the Horticulture Section - Tri River Area Extension

The Colorado State University Extension Tri River Area Horticulture Program extends research-based information about plant-related concerns to home gardeners, the Green Industry (nurseries, sod farms, lawn care companies, arborists, etc.), commercial vegetable producers, government entities, and other



⇒ The weather Grand Junction, CO

Weather in  
Grand Junction -  
United States



Rain Showers  
Humidity is 93%  
Wind is NNW 12 mph  
Visibility is 7 mi  
Pressure is 29.64  
inHg

community members and agencies in Mesa, Delta, Montrose, Ouray, San Miguel and Gunnison Counties.

Our activities and capabilities include:

- ▶ Maintenance of this web site
- ▶ Development of news articles
- ▶ [Swift's Gardening Blog](#)
- ▶ [Swift's Facebook Account](#)
- ▶ [Swift's Twitter Account](#)
- ▶ The Tri River Area Master Gardener program
- ▶ The Tri River Area Native Plant Master program
- ▶ Maintenance of the Ute Learning Garden and arboreta at the Mesa Extension office
- ▶ Tours of the Ute Learning Garden for students of all ages.
- ▶ Development of "green industry" related documents
- ▶ Training of "green industry" professionals
- ▶ Identification of plant problems to include disease and insect pests
- ▶ On-site examination of plant and soil-related problems
- ▶ Testing of soil, compost, manure, and water for salts
- ▶ Evaluation of soil test results and report preparation

# Troubled Times



## Cold-Tolerant

---

For those of you who may have land, there is a free catalog available from [Miller Nurseries](#) in the beautiful Finger Lakes area of New York State. These are especially cold-tolerant varieties, many dwarf varieties which will bear fruit quickly, some self-pollinating. Fall shipping begins on Oct 20. Excerpts:

*Cold-hardy Kiwi hardy to 25 below 0, sub-zero sweet cherries, currants, many grape varieties (this is a prime grape growing area), apples, blueberries, cranberries, raspberries, blackberries, strawberries, apricots, persimmons, nectarines, gooseberries, plums, prunes, pears, blueberries 29-40 below zero, peaches to 20 below zero, elderberries, figs which will grow in NH, SD, and northern Wisconsin. Quality stock for cold-tolerant varieties.*

Offered by [Toni](#).



# Troubled Times



## Grain Plot

---

Raising oats, barley or sorghum does not require a large space. A 20 x 55 foot plot will raise all the oats a family of four needs in an entire year. It does require attention but much less than the average sized vegetable garden.

Type	Seed/Acre	Land Needed
Oats	80 lb	10' x 62'
Barley	100 lb	10' x 87'
Rye	84 lb	10' x 145'

Oats are highest protein of all grains. They need cool moist climates and cannot handle drought. Rye tolerates poor soil, cold, damp, and drought. Barley requires a long cool ripening season with moderate moisture.



# Troubled Times



## City Plot

Gardening is one of those things that can really only be learned by doing. While there are many books and resources available to help, growing your own garden gives you the opportunity to see first hand the different problems that can be had in growing a certain type of crop. Growing a garden is also a way of putting yourself back into the cycle of the earth - being a part of things again. The garden in the picture is what I call an experimental garden. I do not expect to grow all my food out of it, but it allows me to grow a variety of different plants and allows me to get experience for the time when I might have to grow a really big garden.

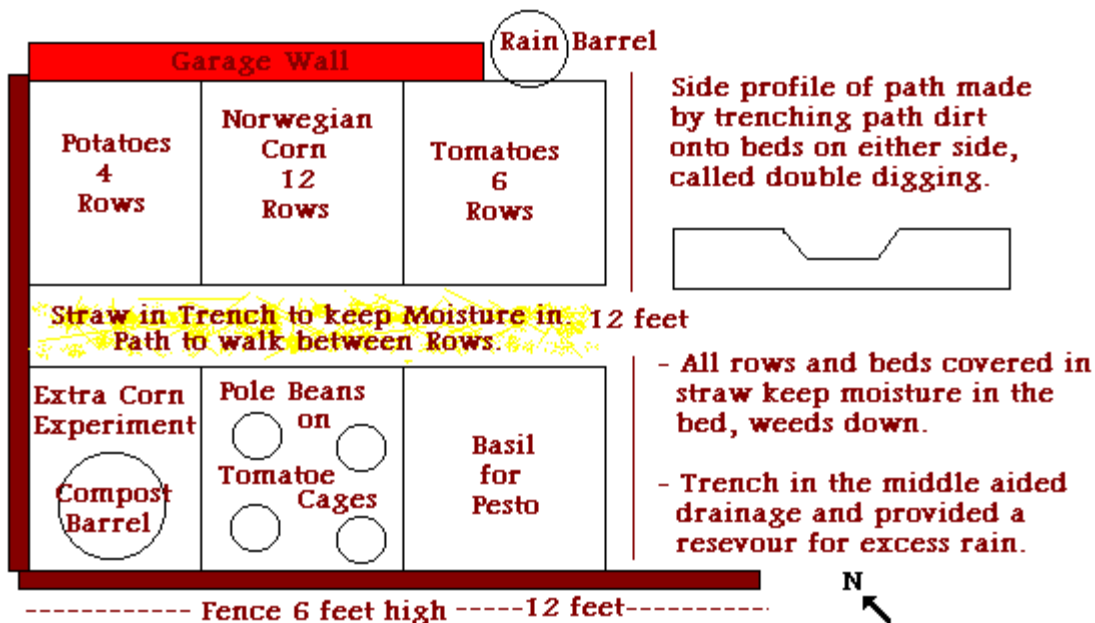

- Maintenance of garden took about 30 minutes a day once planting was done.

- Yields: Potatoes 1 big basket  
 Corn 12 ears  
 Tomatoes too many to count  
 Basil 2 quarts leaves  
 Beans 1 big basket

The size and layout make it possible to maintain the garden completely, once the initial preparation for planting has been done, with about 20 minutes a day. A trench dug down the middle of the plot separates the two beds. The trench is 2 spades wide and the soil is turned up to form the bed. What this does for you is allow you to start planting very early, since the beds can drain into the trench, and the beds get warmer faster in the sun. This spring I dug the bed and the soil was so wet I was not sure I would be planting for several days, but because of the added air circulation, and exposure to the sun, the soil was dry enough in the beds to plant within two days. If I had kept it as a flat single bed, then I would have had to wait till the season was well started before I could plant.

The trench can also save your garden from being flooded out. I have a rain barrel to collect water, but I like to fill it up at the beginning of the season so that when I water I don't have to get the hose since the barrel is usually not always full. I got the hose and began filling up the barrel, then I got distracted and forgot I was filling it and 2 hours later

remembered and ran back to the garden. The trenches were full of water, but the beds were dry. The tops of the beds were about 4 inches above the waterline. My crop would have washed away if the trenches were not there. The trench water ended up sinking into the beds and was not completely lost.

I also used straw to fill the trench so I could walk on it, as well as over the beds once the plants were up, to protect the soil from evaporation, and slow down weed growth. You can buy special cloth to the same thing, but in the fall, I just turn over the soil with the straw intact and it mulches up quite nicely. I have been planting different types of vegetables to get an idea of how they grow and what I can expect from bugs and how much care the different plants need. There has been talk about low light conditions Post PS and after checking around there are some plants that are growable in lower light conditions. These types of plants are the ones that grew and grow up in northern china and some of them are:

**Leeks**  
**Onions**  
**Cabbage**

There are more, but I do not know them. Of course there are mushrooms and they need no light at all but that is a different kind of gardening. I think it is really important to get as much active experience in gardening as you can regardless of how the PS might change the biosphere. The experience can help in assessing the PS conditions and give you a better chance of getting a successful harvest off then if you had to start from scratch post PS. But then again, any experience is better then scratching around after PS.

Offered by [Gus](#).



# Troubled Times



## Pros & Cons

---

It takes a lot of electricity (or other energy) to generate enough light for plants. I used to work in a greenhouses and remember that the bill for electricity and heating was a major part of all expenses. You can take an ordinary light meter and compare the light intensity during the dawn or on a very cloudy day. Next measure an average bulb. You will be surprise how little light in gives comparison to an average sunny day.

Using artificial light would generate a big infra red signature and you would invite people in (even assuming that the light was shielded). You can put a wood stove inside the greenhouse and keep it warm during the night, but here again you've produced an infra red signature.

Hydroponics is a messy business and you would have to deliver nutrients in a liquid form. With greenhouse you could start composting the next day after settling in (assuming that you are not in the desert). I have seen greenhouses set up with vertical conduits or pipes with soil. This allows plants to grow vertically. It looks like a tree. The only problem is watering which has to be done from the top.

Offered by [Chris](#).

Hydroponics are beset due to limited sunlight and space available. 4 times as much in the same space can be grown with hydroponics.

Offered by [Clipper](#).



# Troubled Times



## Sheltered

---

An alternative to growing outdoors for the first few years. Once one has survived the pole shift with a sturdy but small survival quarters. One could build a cheap steel building or green house to cover the growing area. Could be plastic tarp over several domes built out of steel conduit or wood. Could be a commercial steel building built from parts stored and assembled after the pole shift. An example would be Steelmaster, 1-800-527-4044. Current costs are about \$3.21 to \$9.31 per sq. ft. Depending on style and whether it is open or closed at the ends.

The issue remains as to how best protect fertile soil from toxic ash-water until a building can be assembled. Tarp on ground first, then bagged earth in water proof sturdy bags placed on top, then cover with more earth. This constructed or placed so as to have natural wind breaks around it or the whole thing below ground level. Edges of tarp are put as deep in the ground as practical. This could be one possible way to protect the soil below the tarp and in the bags. Not sure how well it would work. It would be lots of work. I think just a tarp with lots of dirt on it would most probably blow away. A corner of the tarp caught in the wind and the whole thing is gone. A reminder: many areas of ground will probably liquefy under the heavy, relatively long earthquake shaking. This will need to be taken into account when choosing a site.

Offered by [Mike](#).





# Troubled Times



## Dome

---

Greenhouses require light and in the gloom following a pole shift it won't be available. Actually, your thoughts make me think about a hybrid approach. Picture an indoor area within a dome with full spectrum lights (halide is most efficient) and plants growing in greenhouses beneath. What greenhouses do is concentrate the light generating heat, instead of letting it out. If you had a place with 25 foot ceilings, greenhouses would help keep the heat in. 10 foot ceilings or less, why bother?!

Offered by [John](#).



# Troubled Times



## Bermed

---

I found a neat book that discusses this concept and how to build a bermed greenhouse - the *\$50 and Up Underground House Book* by Mike Oehler. It was advertised in the magazine *Backwoods Home*. Basically it is a house below ground level with an exposed dome roof, the greenhouse, also below ground level, is butted up against the south side of the house with plexiglass roof panels slanted to the south. Inside the greenhouse against the house wall we've planned tall water filled drums to absorb heat from any possible sunlight. we're also trying to figure a way to run tubing through the drums that can be used to heat the water from house heating system for when the sun is "on hiatus". We are trying to figure out the thickness needed for the roof panels, which direction the sun will be coming from, the best heating system for the house, and a zillion other details. One person I talked to suggested putting the greenhouse between the house and a barn so the animals would benefit too and be easy to get to in case of severe weather. Any one have thoughts on that? I thought about insect infestation and sanitation, but many pioneers had their barns attached to their houses.

Offered by [Teresa](#).

The design of many European farm houses is one in which the animals live underneath the human occupancy level. In this way heat from the animals rises up through the flooring, adding both to the insulation of the animals and the heating of the humans. I think dealing with the smell was basically a bit of manual labour mucking it out every so often. Simple maintenance, perhaps a weekly chore. My father grew up in this environment before and during WWII and said it works quite well, or did until the war over took Italy and they had to run for the hills. The war completely disrupted the rural communities all over Italy and from my father's generation on everyone went seeking cash in the cities. Anyhow, by segmenting the underfloor area, they were able to house different animals during the winter and store all their preserves, dried fruit, smoked meat and sausages. My uncle still keeps a couple of pigs in this environment and makes the best pork sausages I've ever tasted. The farm house in question is high in the mountains and gets snowed in during winter.

I think if you were to incorporate your greenhouse into this arrangement, you could sweep the droppings, hay, etc. directly into the garden as a source of nutrients. Indeed, if you incorporated the composting type earthworms (Red preferably, with a few Tiger worms perhaps) into your garden beds, they would consume the manure and other organic waste, returning it directly to the plants. A one step fertilisation process. This is a project I'm working on at the moment and seems to show a lot of promise, with minimal effort to maintain. Worms seem to look after themselves quite well and do wonderful things to the soil if you feed them organic waste.

Offered by [Gino](#).





## Search

- [Advanced Search](#)
- [Search Tips](#)

## Browse By Subject

- [Research](#)
- [Products & Services](#)
  - [Educational Resources](#)
  - [Outreach Activities](#)
  - [National Agricultural Library](#)
  - [Archives](#)
  - [Publications](#)
  - [Manuscripts \(TEKTRAN\)](#)
  - [Software](#)
  - [Datasets](#)
  - [Freedom of Information Act and Privacy Act Reference Guide](#)
- [People & Places](#)
- [News & Events](#)
- [Partnering](#)
- [Careers](#)

You are here: [Products & Services](#) /

## Products & Services

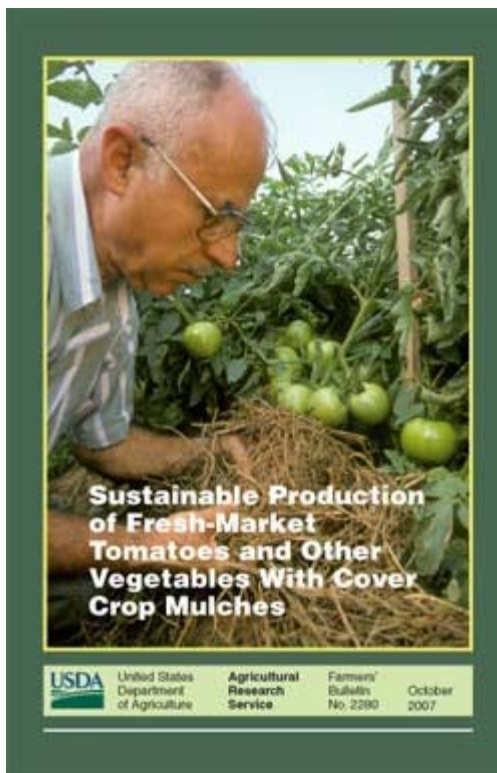

### Sustainable Production of Fresh-Market Tomatoes and Other Vegetables With Cover Crop Mulches

by John Teasdale and Aref Abdul-Baki

The alternative production system described in this bulletin focuses on the winter annual legume hairy vetch (*Vicia villosa* L. Roth), both as a cover crop and as a mulch in a sustainable tomato production system. As a cover, vetch serves to fix nitrogen, recycle nutrients, reduce soil erosion and compaction, and add organic matter to the soil. When converted to a mulch, the residue reduces weed emergence, reduces water loss from the soil, acts as a slow-release fertilizer, and suppresses some pathogens and pests. Though research on this mode of production was originally confined to growing tomatoes in stands of hairy vetch, further study has shown that the underlying concept can be easily modified to suit other crops and regional growing conditions. Some direct-seeded vegetables can be grown effectively, as can winter vegetables in subtropical climates. Other cover crops can be selected and even seeded in beneficial mixtures to suit local growing conditions. Color, 32 pages.

U.S. Department of Agriculture, Agricultural Research Service, Farmers' Bulletin 2280

October 2007

While supplies last, you may order one free copy by mail from John Teasdale, USDA-ARS-SASL, 10300 Baltimore Ave., Bldg. 001, Room 245, Beltsville, MD 20705, or by [e-mail](#).

Specify that you're ordering Sustainable Production of Fresh-Market Tomatoes and Other Vegetables With Cover Crop Mulches and give your complete mailing address, including postal code.

[Click here to view publication online \(pdf file\) using Adobe Acrobat Reader \(1.049 KB\).](#)

[Click here to download the free Adobe Acrobat Reader for viewing pdf files.](#)

[Pubs Staff](#) | [Back to Pubs Index page](#)

Last Modified: 03/19/2010

# Troubled Times



## Poor Soil

---

When suspecting poor soil, perform a soil texture test. This is done by filling a quart jar half-way with water. Add soil until the jar is nearly full. Put on the lid and shake until well combined. Set the jar aside and wait until the soil settles (from a couple of hours to a day). Clay will be on top, silt in the middle and sand on the bottom. Measure the thickness of each level and divide each thickness by the total thickness of all of the layers. This will give you a percentage. If the soil is less than 25% silt or more than 25% clay, you need to add 2 or 3 inches plant matter like compost, humus, or manure. If you have more than 30% sand, you need to add twice as much plant matter.

Next you should purchase a soil test kit. These are available at your local garden center, but unfortunately they only test for NPK and pH levels. Try the agricultural dept. or geology department at your local college or university. If they are not able to do the test for you, then they should be able to provide you with a source for a test kit. Be sure to tell them you want to test for trace elements. Once you know specifically what you are lacking, you will have a better idea of how to go about replenishing it.

Offered by [Roger](#).



# Troubled Times



## Pollination

---

You have to determine which flowers are male, which female, which is usually an easy thing to do, but which is so long and boring to list here as there are 70+ major types of vegetables grown just in the US. The male flower produces the pollen, the female flower usually has a bulbous area (the embryo which will turn into the fruit or vegetable) at the bottom of the flower. There are family groups in the vegetable world, and pollination is basically the same along family lines. Also, plants usually have both types of flowers on them, male and female, though it is still good to pollinate each plant from a different plant so to insure some genetic diversity.

To help in pollination, like in the case of corn, you snap off a pollen rich tassel and shake it over the silk coming out of the ears. In the case of squash you find a freshly bloomed male flower, pick it, go over and find a female flower and rub the two important parts together. Lettuce is easy as the flowers are hermaphrodites, and small, so they just have sex freely and you don't have to get involved too much. With tomatoes, you usually just have to shake the plant, but even this is usually not necessary (they get the job done on their own, like lettuce).

You know how corn has that beautiful silk coming out the top of the ear? If you followed *each* single strand of silk back into the ear, you will find that it is attached to a single kernel of corn. So, all the kernels of corn have their own strand of silk. The silk is there to catch the pollen blowing around in the outside world. Fresh pollen, coming from the tassels, falls on a single strand of silk. The pollen, sitting on the silk, sends down a pollen tube (I think that's what it is called) down the strand of silk to the kernel of corn, and the kernel is fertilized. The kernel (seed embryo) starts to swell and grow - the result is the fresh corn we eat and corn meal. Now, you know how when you open up a fresh ear of corn and some of the kernels are missing? This happens because pollen did not fall on the particular silk that was attached to that kernel, so it did not grow.



# Troubled Times



## Seeder

---

One thing I learned when putting the wheat in is doing this with fingers is rather unproductive. Assuming you don't have power, the only seeder I have found mentioned that is human powered is the **Earthway Precision** garden seeder. **Cumberland General Store** has it, 800-334-4640.

Offered by [John](#).

The seeder I prefer is round with a long spout and a clear plastic cover that rotates to select different window sizes for different sizes of seed. The problems I had with the **Tiny Tim** seeder are that you cannot easily control the number of seeds dispensed. My red colored seeder with the long spout requires more handling but you can control the number of seeds leaving the spout by simply tipping it accordingly.

Offered by [Roger](#).



# Troubled Times



## Garden Covers

---

Came across the **Instant Shelter** site in my search for portable greenhouses. They also do temporary shelters etc. All products are nice and round on two sides.

Offered by [John](#).

The life of a garden can be extended with a clear plastic cover. One Troubled Times member recently received a catalog in his mail from a company that sells almost every bag or covering known to man. For instance, 20' x 100' of 4 millimeter polyethylene plastic sheeting is \$69.60. The company is **National Bag** and the number is 1-800-247-6000.

Another member reports that a seed catalog from **Jung Seed Co.**, (800) 247-5864, markets a floating row cover that needs no support. It is ideal on tomatoes, peppers, melons, cucumbers, squash and strawberries. The floating cover conserves moisture, protects from heavy rains, harsh winds, insects and birds. The cover allows water, fertilizer, and light to penetrate and ventilates heat on excessively sunny days.



# Troubled Times



## Hot House

The ads for **Cover It** tents can be found in many publications and there are many distributors all over the US. The company makes a wide variety of standard or custom made tents that can be used for storage units, garages or portable shelters. The "standard" fabric is said to last for about 10 years, but carries a 2 year warranty. Their vinyl fabric is supposed to be good for 20 years. They are supported by a heavy duty galvanized steel frame which is really quick and easy to put together. They also can be added on to easily for additional units later. You can get either a peaked roof or Quonset styles. The doors are zipper closures and stove pipe inserts can be installed in the roofs for wood stoves.

The greenhouse material can be had in either clear or opaque white, and it is ultra violet treated. The treating is to keep the vinyl from being damaged by the Sun's UV rays. Most plastic tarps fall apart in a short time from the UV exposure. The **Cover It** tents have about a 5 times longer life span. Here's some samples of some of the standard tents available, in either solid colors or greenhouse material with one zipper door. Extra zippered doors can be installed for about \$30-\$40 each in addition to the base prices listed below. They also they have greenhouse kits for \$40. Custom Tents made in any size up to 60' wide and 30' high.

Width	Length	Height	Retail	Wholesale
8'	8'	8'	\$395	\$279
8'	16'	8'	\$650	\$479
8'	20'	8'	\$700	\$489
10'	16'	8'	\$650	\$479
12'	24'	8'	\$850	\$599
14'	24'	8'	\$1,150	\$809
12'	30'	12'	\$1,500	\$1,299
14'	42'	14'	\$2,700	\$2,159
30'	20'	13'	\$2,900	\$2,099

This company offers dealerships all over the US (I don't know about other countries). Here's how to contact them.

### Cover It Company

531 Ella Grasso Glvd.  
New Haven, Ct. 06519

(203) 781-8000 - phone  
(203) 781-8005 - Fax  
1-800-932-9344 - toll free

Offered by [Cat](#).





# Troubled Times



## Cover Crops

---

Planting a really good cover crop over it like red alfalfa would probably keep you dirt on your land while your neighbors dirt is blowing away.

Offered by [Gus](#).

Not only do cover crops hold the top soil, most fix nitrogen in the soil and serve as food source for animals. I plan on having several bags of oats and wheat to use as cover crops. Legumes such as Austrian peas are good also.

Offered by [Mike G](#).



# Troubled Times



## Solar Cones

---

I'm reading a great book called *Solar Gardening* by Leandre and Gretchen Poisson. Here's a photo of a [Solar Cone](#) developed by Leandre Poisson (he's shown in the photo). Separate from the issue of providing enough artificial light, this may be the type of protective device we can use for vegetables post-shift. The materials are simple and highly portable.

Offered by [Mike](#).



# Troubled Times



## Catalogs

---

Received a really good catalog on gardening from [A. M. Leonard](#) 800-543-8955. Lots of testing equipment and supplies I haven't seen other places at reasonable prices.

Offered by [John](#).

Also, I just ordered my catalog from their web page. It is free.

Offered by [Clipper](#).



# Troubled Times



## Slugs

---

Have lost many of my lettuce plants to slugs already. From a seed catalog which came yesterday:"slugs are a primary pest of lettuce and can damage plants at any stage of growth. Quality lettuce cannot be grown in slug infested areas unless they are successfully controlled." I am baiting them with empty beer bottles. Assume this pest will proliferate in the aftertime with wet soils. Salt will also kill them.

Offered by [Toni](#).

Slugs can be controlled with a natural predator called "Decollate snails". They eat the eggs and the young of brown snails and slugs. Once the population is reduced they then eat yellow-brown leaflets. They are much smaller and you almost never see them. They may eat young seedlings so you will need to protect them, but they don't eat larger plants. They will eliminate the population of brown snails and reduce dramatically the population of slugs. My own personal experience is it may take 6 months to a year or so to bring slugs under control. You can buy or order them from any good nursery. Armstrong has them.

Offered by [Mike](#).



# Troubled Times



## Pyrethrin Daisies

---

From *Build Your Own Arc*, by Geri Welzel Guidetti

Because it is a nerve toxin, it can kill some beneficials such as lady beetles, so use only when necessary to control a particularly bad outbreak of aphids, bean beetles, stink bugs, potato beetles, celery leaf tiers, cabbage loopers, mealy bugs, red spider mites, whiteflies, thrips and more.

Here is another, effective, insecticide that you can grow and make at home. The active compounds, called pyrethrins, are contained in daisy-like flowers called pyrethrum daisies. You can get the seeds from Park Seeds, listed in the Seed Company reference in this book. You want the perennials called *Tanacetum coccineum* or *Tanacetum cinerariifolium*. In some catalogs, *Tanacetum* is listed under the older *Chrysanthemum* species name, so would be *C. coccineum* and *C. cinerariifolium*.

Daisy heads are picked, dried and ground up for powder or dust, or fresh flowers can be soaked in 70 percent isopropyl rubbing alcohol overnight to make a liquid extract containing pyrethrins. One gallon of water added to 1/4 cup of alcohol extract made from 2 cups of flowers will give you a good spray solution. One caution: Keep flowers and extract away from children and pets who might eat them. They can be toxic to mammals. And don't use the family blender to grind them. Use a mortar and pestle or even a simple stone as a grinder of dried flowers placed on a larger, flatter stone.



# Troubled Times



## Root Cellar

---

The following is from *Putting Food By* and my father:

A root cellar is the best storage place for potatoes and other root crops - it has relatively constant temperatures and high humidity (80% or better). In the absence of a root cellar, one could use any place that duplicates these conditions (low or no light, constant temps. around 40 degrees F, and 80% relative humidity). Potatoes need to be stored in low temps so they will remain dormant and not sprout prematurely. They also need to be protected from drying out. And we all know what happens when potatoes are exposed to light (they turn green and produce a toxin that is not entirely healthy for consumption, though not deadly). Given that, keep in mind that potatoes do not freeze until the temp drops to 30 degrees F. They tend to sprout after a few weeks of exposure to temps above 50 degrees. So the desirable temp can be considered as a range between 30 and 50 degrees F.

The method I will use this winter will be to turn a 5 gallon bucket on its side and cover it with hay or straw (mulch). This mulch will be built up from behind and beside the bucket until it is twice as high as the bucket alone. I will place a small amount of mulch on the new bottom of the bucket and arrange the potatoes in a single layer and then alternate mulch and potatoes until the bucket is full. Then I will place a piece of 3/4 inch plywood in front of the bucket and cover with mulch. If I get enough snow this winter, I may use snow in front of the plywood instead of mulch.

I will actually use several buckets since it is not a good idea to store different varieties together in the same bucket and I plan to save two varieties of regular potatoes and sweet potatoes. A 5 gallon bucket is not a "magic" container, just what I happen to have on hand. *Putting Food By* suggests using a 55 gallon drum! Also, this method is usually called 'pit storage' though that is a misnomer since no digging is involved (except digging the tubers in the first place).

Offered by [Roger](#).

Here's a new page I've just added to my web site. It concerns [Root Cellars](#), which were once an essential part of the subsistence chain. Whether we'll be able to get to this level after the shift is another question, but the information is valuable nonetheless.

Offered by [Mike](#).



# Troubled Times



## TEAM: **Gardening**

---

Gardening under the conditions that will exist after the coming pole shift is a challenge that several members of Troubled Times have begun exploring and experimenting with. Reports to date are on:

- an [Au Natural](#) garden
- a [City Plot](#)
- [Soil Fertility](#) experiment
- Beginner [Bumblings](#)
- [Container Gardening](#) problems
- [Tomato](#) peculiarities

For information on developing TEAM activities, contact [Roger](#).

# Troubled Times



## Amaranth

---

The nutritional breakdown of Amaranth is very interesting. Too bad it is such a big plant. Would be nice to grow hydroponically; but unlikely because of the size of the plants.

Offered by [Ron](#).





# Troubled Times



## Oil and Sugar

---

I know we need to keep some oils in our food storage, but they don't last forever. What I want to know is if I grow sunflowers how does one press the oil out of the seeds, will an apple cider press work, and how much do I need to plant. I live in the south and can raise sugar cane to make syrup or sugar, but since it's more of a temperate crop anybody got an idea how to produce sugar in a more northerly climate? I thought about either sorghum or sugar beets.

Offered by [Mike G.](#)

I've been looking for decent information on how to make your own vegetable oil to convert to diesel fuel. Obviously, no vegetable oil, no biodiesel. The best I have come up with is *From the Frying Pan to the [Fuel Tank](#)* and an [Oil Seed](#) site, which has a lot of good information and book sources.

Offered by [Steve.](#)

Sugar cane is very efficient at converting light to food energy as higher plants go, from that standpoint alone I think it would be a good addition to the mix of indoor crops grown. I would hate to think we would be getting a very large amount of calories from sugar, but there are many other useful things you can do with it. It would be useful to see if sugar cane, beets or sorghum can be grown hydroponically.

Offered by [Steve](#)

Maple syrup and honey are the sweeteners of choice in the northern climate. Maple runs in the spring, is easily tapped but needs long boiling times (outdoors). Have done it. Honeybees are fragile creatures and have had disease lately, so are difficult to raise, and may be very susceptible to a die-out in Aftertime conditions. Have cultivated sunflowers, but am unfamiliar with oil extraction process. It should be easy to look up. Nuts are also good sources of oil. Peanuts easy to grow. Seems like olive oil would keep awhile in metal containers.

Offered by [Toni.](#)

My husband use to work at a sugarbeet processing plant. He said that they basically cut up the beets, boiled them, then spun them until they solidified and turned into granules.

Offered by [Teresa.](#)

Sugar beets are what most sugar is made out of in the US. The popularity of this plant sprang up from the Cuban embargo which meant a sugar shortage. Sugar beets are the primary crop in the thumb area of Michigan - flat, great soil, lots of water. We should look into growing these things.

Offered by [John.](#)



# Troubled Times



## Sugar Beets

---

**R.H. Shaumway's**, Pioneer American Seedman  
PO Box 1  
Graniteville, SC 29829

### Process to Extract Sugar from the Sugar Beet

Beets should be harvested until October, at which time they will give the maximum amount of sugar. The available sugar content in beets reaches from 14 to 16% sugar, meaning refineries would expect to recover 14 to 16 pounds of marketable sugar per 100 pounds of raw beets. The probable recover of sugar extracted in the home would be about 8 to 10 pounds per 100 pounds of raw beets. The sugar extracted at home will not be as refined as that from a commercial refinery.

The following process is used in extracting sugar from the sugar beet. Remove the tops and part of the crown and the small roots. Scrub thoroughly. Slice the beet through a salad shredder, kraut slicer, or with a knife. If using a knife, cut into slices as you would for French fries. Do not grind! Add 2 quarts of hot (195 degrees) water for each quart of shredded or sliced beets. It is best to use a granite or stainless steel container (a crock will also do). Let the beets soak for one hour and remove from syrup, draining well. Place beets into another container and add one quart of hot water in each quart of beets and let soak for one hour.

Strain the syrup from the first soaking through a fine cloth and place over medium heat to start the evaporation process. For rapid evaporation a shallow pan is best as the evaporation process is fairly slow. This can be evaporating while the beets are soaking in the second syrup. Remove the beets from the second syrup and discard them. Add second syrup to the first in the evaporating pan and continue the evaporation process until this been reduced to 1/4 of its original volume. It should be of medium consistency. If too thin, continue the evaporation process. the liquid will be bitter tasting when it has reached a point of saturation of sugar. Lower the heat so it will not burn the syrup. Stir the liquid frequently until is resembles Corn Syrup.

To extract the syrup in crystals, add a small amount of pulverized sugar (or powdered sugar) to the solution an let cool. The pulverized sugar will induce crystals to form. When crystallization is complete, remove crystals and drain. Let dry on clean sheets of plastic or heavy paper.

I raised sugar beets this year, and tried to make sweetener out of them. I consider it a failure. I ended up with a substance the color and consistency of warm tar. It has an initial sweet flavor, but the earthy and bitter aftertaste is horrible. Sugar companies like U&I sugar in Utah and Idaho, have a super-secret process they protect, to convert sugar beets. It involves adding milk of lime and sending carbonation through the syrup - quite complex. I had hoped it was more like sugar cane, where the refining is to make it white, but the basic syrup could still be used as sweetener. Apparently this is not the case.

Offered by [Wendy](#).

This tar is concentrated sugar. You ever taste unrefined molasses or unrefined sugar cane? Too much is not sweet at all, it overloads the taste buds and seems bitter! Try drying out the paste and then pulverize what's left into 'sugar.' This will taste sweet in small quantities.

Offered by [Roger](#).



# Troubled Times



## Potatoes

---

They were sure a lot of fun to grow. My farmer friend knew a guy who just spread the potatoes out on his lawn, and covered them with straw. Then he just harvested them in the fall. I am going to try this next spring. If it is true, then potatoes are the ultimate solar collector.

Offered by [Gus](#).

Potatoes can be grown on top of the ground if covered by straw. You need to keep an eye for the green tint that the skin might get, that's a sign the potatoes are getting too much sun; this green tint is an alkaloid poison and shouldn't be eaten. If you dig around your potatoes every so often, when the plants have nice size spuds, and pick the nicest tubers the others will get larger. Also potatoes don't like wet soil it will cause them to rot in the ground. Get a copy of Rodale's *Encyclopedia of Organic Gardening* to help you with pests (a great book I can't recommend it enough).

Offered by [Mike G](#).

Another way to increase your yield and ease the harvest is to plant the seed potato in a tire filled with soil. As the plant grows, add another tire and surround the plant with dirt. It will grow taller and form tubers in both the original tire and the new one. You can continue to add tires and dirt until you can't reach the top. Of course watering then becomes a burden, but most people can manage 4 or 5 tires. Harvesting is a cinch as you just knock off a tire and let the dirt fall out with your tubers as you need them. In really cold climates, you would want to go ahead and harvest all of the potatoes before the real freeze sets in, but you could harvest only what you need until that time and it makes good use of old tires! I harvested a quarter of my red potatoes yesterday (three plants) and got 7 pounds (one of them was a pound by itself!).

Potatoes don't like light or heat. Light is what makes them turn green, heat makes them sprout. They also need air to stay alive, so the best thing to do is to put them in flats or short, long boxes of some sort. Don't stack them, just one layer in the box. Next you need to find a cool, dark place to store them. If you have a basement that is dry, doesn't flood, you can put them down there. If you don't have a basement, put them on the floor of the closet in your coldest room in the house. If this is impractical, the refrigerator will work, but be sure they don't get so cold that they freeze, as this will kill them and they will rot quickly in there.

Offered by [Roger](#).

Potatoes contain almost all the amino acids, many minerals, co-enzymes Q10, Folic acid, vitamins B1, B3, B6, C, and K. To grow potatoes in small spaces try growing them in old used tires. you'll need about 4 tires per stack. Stack 2 tires, fill to halfway up 2nd tire with rich composted soil place 2 seed potatoes on top of soil then cover with more soil (about 2-4") then add fertilizer around the edge of the tire and water well. As your plants grow add another tire, add more soil up to the bottom of the leaves. You can use straw or hay at this stage instead of soil (or if you have access to well washed seaweed even better). Keep repeating this process until the foliage starts to yellow, you can now start to (carefully) remove the spuds or leave till the plants wilt completely and cut stems to about 2", leaving the spuds in the ground for another 2 weeks. To harvest, lift off the tires one by one and carefully remove the spuds. Undamaged potatoes keep better so use damaged ones immediately. Wash and *dry* potatoes thoroughly, and store in a *dark* place.

Offered by [Janar](#).

Potatoes are ready to be dug up after the plants die off.

Offered by [Clipper](#).



# Troubled Times



## Peanuts

---

Consider peanuts. Peanuts are high in protein, they are a legume which fixes nitrogen into the soil, and it only takes a pound to make a pint of peanut butter.

Offered by [Roger](#).



# Troubled Times

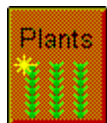

## Stevia

---

You might put in a supply of Stevia for sweetening. Ounce for Ounce the sweetest there is!

Offered by [Amonsoquath](#).

[Stevia](#) is used as sweetener, as was stated. It's extracted from the Stevia plant, Stevia rebaudiana: sweet Honey Leaf. You can grow stevia plants yourself, and buy the seeds.

Offered by [Michel](#).



# Troubled Times



## Beets

---

While I was at one of the nonprofit seed gardens last month, I harvested a couple of the sugar beets, which I assume are from the seed Roger has supplied us with. I also assume that these will store in the root cellar, like any other beet (beta). These plants were large, healthy, and needed to be thinned. There was a huge quantity of them. The leaves I put in salad, and the large sweet white roots I grated into salad. Everyone seemed to enjoy the salad very much. As these will keep without refrigeration, and possibly over winter in the ground, in some areas, I would not discount them as a source of food, for leaves or roots. They could be added to other vegetables, either cooked or raw. They could be chopped or shredded and dehydrated in a low temp oven or dehydrator. The resultant product could even be added to baked goods in small quantities. It would store in sealed containers indefinitely, particularly if O2 absorbers were used.

I was at a nutrition meeting this week where it was stated that today Americans consume close to 200 lbs of sugar per year per person. I remember when the figure was 100 lbs. Apparently it was only 5 lbs per person per year 100 years ago, when we had far less incidence of diabetes, cancer and heart disease. Sugar is very slowly eroding the health of humans, just as the acid reaction it causes in the human body decays the teeth. It encourages the growth of Candida and other harmful microorganisms. It is seductive and also addictive, and a difficult substance to break one's addiction to. If you don't consume it, you don't want it. Just think of all the candies we feed our children for treats and for holidays, such as Halloween, Easter, Valentines Day, etc. Think again when you give children candy. Fruits and vegetables supply all the sugar that we need. I have a small bottle of maple syrup and of honey plus some honeycomb in the refrigerator that we use very little of.

The sugar beet is a valuable food plant for man and animal. Your beets can be stored in moist sand in the root cellar (hopefully your temps will be between 35 and 40 degrees F.) Or, you can keep them in layers of straw mulch in a barrel or 'pit type' cellar outdoors, probably about 3 ft of straw where very cold.

Offered by [Toni](#).





# Troubled Times



## Cassava

---

Has anyone considered Cassava? It is easy to grow them and the tuber taste much better than the bamboo shoot, the bamboo shoot we use only for a side dish like stir fry with dried shrimp, where as the cassava is the poorv man staple food in the old country, the cassava plant will not grow taller than four to six feet, one just need the fresh cassava stem with a few nodes and just stick in the ground or soil and about three to six months one will get a bunch of tubers, just from one plant, one can feed a family of six for one day and the tubers can be kept and stored like potatoes.

Offered by [Tian](#).

I have not heard of a Cassava. How would this plant compare with other options we have like beets? Is it fast growing? Can it also be used for construction? Can you eat the whole plant? What family of plant is this or is there a more common name we would identify?

Offered by [Mike](#).

If you know how to grow potatoes, then [Cassava](#) is much easier to grow, just stick a small piece of the stem back into the soil and a new cassava plant will grow again, that is how simple it is.

Offered by [Tian](#).

Cassava is the most important tropical root crop. It's starchy roots are a major source of dietary energy for more than 500 million people. It is known to be the highest producer of carbohydrates among staple crops. According to United Nations Food and Agriculture Organization (FAO) cassava ranks fourth of food crops in the developing countries after rice, maize and wheat. The leaves are relatively rich on protein and can be consumed. Cassava can be stored in the ground for several seasons, thereby serve as a reserve food when other crops fail. Cassava is also increasingly used for animal feed and in different industrial processes and products Its starchy roots produce more calories per unit of land than any other crop in the world, except perhaps sugar cane. The leaves of the plants provide vitamins and proteins when eaten as a a vegetable - a common practice in Africa. The leaves are often fed to livestock too. Cassava is called "Manioc" in Francophone areas and Tapioca in Latin America. Portuguese name it "Mandioca" and Spanish "Yucca".

Offered by [Mike](#).



# Troubled Times



## Cyanide

---

However, cassava has its problems. It is full of carbohydrate but nothing much else. Since it contains very little protein, people need to eat something in addition to it to ensure they get a balance of protein, vitamins and minerals. On digestion, cyanogenic glucosides present in the root are broken down and cyanide can be released into the body. These have therefore to be removed before cassava can be eaten. This can be done in a variety of ways but is often done by washing the cassava in clean water - if there's any available - or by fermenting it. Another problem with cassava is that it suffers from postharvest physiological deterioration. Although it can remain in the ground for many months, once it is harvested it deteriorated rapidly. Within 48 hours it is unmarketable. What makes cassava different from other carbohydrate/protein combination starches is the presence of the poison hydrocyanide (HCN) bound with glucose sugar. The cyanide is non-toxic until a special enzyme breaks this bond (beta-glucosidase, or beta glucuronidase).

Offered by [Mike](#).

I have never heard anybody got sick nor get food poisoning from eating cassava, I have eaten this cassava since childhood, and after peeling the cassava usually we rinse them because our hand were full of dirt from the cassava skin but we never wash them nor dipped them in water, there is no need for it. In the old country the cassava farmer stick the fresh cassava stem up-side down around the perimeter of the cassava field to protect the rest of the field from wild boar or any other animal, it seems, this up-side down cassava plant is more toxic, and hence the wild boar eat this first row of cassava they will get very sick and will never come back again, and of course this up-side down cassava will be never sold to the market. Fermented cassava is a delicacy for me and cassava cake is just a big treat. Since this cassava plant is a tropical plant, you have to grow them in doors if you live in the colder climate countries, you might be able to grow them out doors during the summer months, the problem is for us here in North America where can we get that fresh stem with a few nodes on it. A colleague at work mentioned they might have it in the Southern US like Louisiana?, I do not know, does anybody know, anybody in Lousiana?

Offered by [Tian](#).



# Troubled Times



## Sun Root Tubers

---

Sun Root tubers, from a perennial member of the sunflower family, taste similar to potatoes and are very prolific. They grow 6 feet tall and can be planted almost anywhere. Sun Root seed can be gotten from:

**Seeds Blum**

HC Idaho City Stage

Boise, ID 83706



# Troubled Times



## Quandong

---

A Troubled Times member living in Australia recommends Quandong, a bush Tucker tree that is very hardy in fact it is a parasite tree, and one of the only edible parasites in the world. Quandong does not kill its host, however, but takes on the genetic character of the host, i.e. if the host has anti insect properties then so does the Quandong. The fruit is like a peach, the nut is like a Macadamia, and the branches can be clipped and used as sandalwood incense.



# Troubled Times



## Pine

---

I know that pine trees stay alive also in semi-shady and low-light and cold conditions, as in the winter in the far north, like Scandinavia, where it's a bit darker. With all the wonderful information about the pine's medicinal value, as well as its nutritional values, I know I will take some pine trees and pine seed trees for the Aftertime. I think that it's possible to cut small branches off the tree with some bark still at the base, and grow them to trees from these cuttings.

Offered by [Michel](#).

One way that I know of to grow pine or other trees from twigs is to air layer them. With this method, you select your twigs a few weeks before actually cutting them. Look for ones long enough to have several nodes. At the bottom two or three nodes, remove needles or cones and with something like a clean pocketknife cut shallow vertical slits in the nodes themselves, just deep enough so that you break into sap.

Using moss (like regular sphagnum moss sold at nurseries) if you have it or fabric if you don't, saturate the material with water and wrap it around the nodes like a bandage. Over the top, use a waterproof material like rubber (cut up raincoat or whatever) and wrap this also to keep the moisture in. Tie the wrappings securely to keep the nodes damp, and come back in about 7 days. The nodes will start producing roots, and since different trees do this at different rates, I can't tell you how long the process will take. Once you have several roots 1 to 2 inches long, you can sever the twig or branch below the rooted nodes and plant it immediately, without the offspring suffering transplant crisis. By this method you get a high clone survival rate, much higher than by sticking twigs in earth without preparation.

Offered by [Jenny](#).



# Troubled Times



## Asparagus

---

From the *Dallas Morning News*, 1998

Jersey Giant and Jersey Knight are the two top varieties. They are all male plants, and because males don't use up energy making berries and seed, they produce a much higher yield than female plants. Of the two cultivars, Jersey Knight is the best suited for growing in clay soil. An asparagus bed can keep producing for 10 or more years. A sunny location and good drainage are essential. In poorly drained soil, plant in raised beds. Because asparagus is a perennial, it is best to grow it in a separate area away from regular garden. Plants grow 4 to 5 foot tall. Allow at least 4 feet between the asparagus bed and any other vegetables or flowers to avoid disturbing the asparagus roots when cultivating the annuals.

An asparagus bed should be about 4 feet wide and as long as your appetite is big. Two dozen plants will supply enough harvest for a family of four and will require 80 square feet. In clay soil, aeration is essential. Add organic matter. 1 pound of 10-20-10 fertilizer for every 100 sq. ft. Asparagus prefers a soil that is slightly acid to neutral (6.5 to 7 ph). The best time for planting is a month prior to the average last frost date. Although asparagus can be grown from seed, it is best to start with 1 or 2 year old crowns. To plant, dig two parallel furrows 3 feet apart and 6 to 8 inches deep in clay or 10 to 12 inches deep in sandy soil. Form small mounds 14 to 16 inches apart in the bottom of each furrow. Set the crowns on the mounds, draping the roots down around the mound. Cover each crown with 2 inches of soil, then firm the soil around the roots and water promptly so the crowns do not dry out. Keep the soil moist but not wet. Saturated soil causes the crowns to rot. Allow the top 1 to 2 inches of soil to dry out before watering again. Plants are fairly drought tolerant.

Do not harvest until year 3 for best results. In year 3, harvesting can continue as long as 8 weeks. Over harvesting limits future production. Harvest the spears when they are 6 to 7 inches tall by carefully cutting them off just below the soil line with a sharp knife. Never leave stubs above ground.

I've had asparagus planted for five years now. It comes up the first year you plant it. You just don't want to harvest it the first year or you may kill it. Also it is very delicious picked and eaten raw right out of the garden. And they are so hardy that they can take on a grasshopper plague like I've had the previous two years. Yes they do propagate themselves naturally by the root, and I believe by seed also. A variety called UC157 is supposed to produce an abundance of crop but is to be grown in the south.

Offered by [Anthony](#).



# Troubled Times



## Wild Rice

---

I have been reading up on the growing conditions for [Wild Rice](#). I live in Canada, where the climate is great for wild rice, but many parts of the northern U.S. would also be suitable. About cultivated white and brown rice, that I don't know. But with all the rain we're expecting, sounds like it might be something to think about.

Offered by [Cass](#).



# Troubled Times



## Garlic

---

I found that one of the toes of one piece of garlic was actually sprouting. I took the sprouting toe from the bunch and put it in a little container with some earth in it. I watered it and this was 5 days ago. Now I already have this 12 cm long sprout from the toe of garlic, growing fast and adding length every day it seems. Can I expect this young garlic plant to grow and bloom this year if I take care of it?

Offered by [Michel](#).

Garlic rarely develops seed. The easiest and most effective way to propagate it is by dividing up the bulb into individual cloves (toes as Michel put it). These cloves can be inserted directly into the soil where you want them to grow. They will divide and multiply quite naturally and when the plant dies back and dries up, you dig up the new bunches and store them like onions. Save a bunch or two for next season and you'll have garlic for as long as you want. Garlic seed is rare and when you order garlic from a seed source, you usually get one or two bunches. It is possible to purchase garlic seed, but the seed is very tender and is less hardy than onion seed!

Offered by [Roger](#).





# Troubled Times



## Pineapple

---

Get a fresh uncut pineapple from your grocery store and look for a nice large green leaf or "crown" at the top of the fruit, the bigger the crown the better, avoid the brown and wilted leaves. Cut the crown at the very bottom, and put it in a suitable plastic container and put a few layers of paper towel with a little bit of water approximate one inch, and put your pineapple crown in it. Put this container on your window or outside when it is warm enough, it needs a lot of sunshine, and approximately two to three weeks the roots will come out and you can transplant this in the garden, or in a wooden barrel with your potting soil.

Offered by [Tian](#).



# Troubled Times



## Off-the-Shelf

---

I think growing plants from food like **garlic** bought in the store can be done on a larger scale. In this way you skip the seed period, which is hard for newbies in gardening anyway. Could this be done with **onions**, too? And how about other plants from the store that are sold as food but can be in fact grown at home for future seed (when it's non hybrid).

Offered by [Michel](#).

Absolutely! Two important plants come immediately to mind - **potatoes** and **ginger**. In addition, most dried beans in the store will grow and produce seeds that will grow. I have personally done this with **black beans**, **kidney beans**, **pinto beans**, and **navy beans** purchased from the grocery store for cooking. They are also a lot less expensive than buying the same amount of seed from a catalogue or especially small seed package.

Offered by [Ron](#).



# Troubled Times



## Fig Trees

---

I recently transplanted some fig trees I actually dug out by hand at a radius and depth that I thought I could get 70 to 80 percent of the root mass. This turned out to be about 3 feet across and 3 feet deep. I kept digging from all sides until the tree started to move in the hole, then I was able to rock it out from that point. I did have to cut roots and such (unfortunate), but the alternative was that the guy was just going to chop them down and dispose of them.

I transported them by balancing them on my sons wagon (a very poor choice in hindsight), then lugged them back to my yard where I had already dug a hole appropriate for the root mass. Each tree took about six hours between diggin the hole in my yard, digging the tree out of the other yard and bringing them back to my yard by hand. Now, the trees lost their leaves due to shock and my inadvertently letting them dry out. I thought the trees to be goners until early this spring when I met a gentleman who went into a very long discourse about how to fertilize the roots of trees. I followed his advice and the trees sprang back to life.

Offered by [Barry](#).

Figs are actually one of our big 'national' fruits as you know - along with the olive, the almond and the pomegranate. Just grows here a lot, that's all They are very hardy trees, requiring little water.

Offered by [Sol](#).



# Troubled Times



## Complement

---

Complementing combinations of plants that should be planted in between each other or in close proximity to each other:

### **Potato:**

- Horse-radish (stimulated production of potatoes)
- Hemp (keeps the Colorado beetle generally at a distance)

### **Strawberry:**

- Borage (lesser rotting of the fruit)
- Pyrethrum (protects against many fungi)
- Ox-Eye daisy (less rotting of the fruit)

### **Beet:**

- Onion (improved growth, generally keeps mice at a distance)
- Swedish Turnip (improved growth)

### **Celery:**

- Leek (makes for taller stems)
- Cauliflower (decreases incidence of diseases)

### **Cauliflower:**

- Celery (against caterpillars of the cabbage-white butterfly)
- Radish (against caterpillars of the cabbage-white butterfly)
- Leek (works against cabbage-fly)

### **Bean and Peas:**

- Celery (decreases incidence of diseases)
- Dill (decreases lice)
- Marrowfat (shelter)

### **Celery:**

- Leek (decreases incidence of diseases)

### **Cucumber:**

- Mais placed at the north side (gives protection/shelter)

### **Cabbage:**

- Sage (decrease caterpillars and cabbage-fly greatly)
- Hyssop (decrease caterpillars and cabbage-fly greatly)
- African Marigold (decrease caterpillars and cabbage-fly greatly)
- Chamomile (decrease caterpillars and cabbage-fly greatly)
- Lavender (decrease caterpillars and cabbage-fly greatly)
- Leek (decrease caterpillars and cabbage-fly greatly)

### **Parsnip/Carrot:**

- Leek (work against rootfly)
- Onion (work against rootfly)
- Salsify (work against rootfly)
- Garlic (work against rootfly)
- Shallot (work against rootfly)

**Leek:**

- Celery (improves the growth process)

**Radish:**

- Chervil (causes stronger taste)
- Cherry (improves taste)

**Lettuce:**

- Chervil (less lice, sturdier crop formation)

**Spinach:**

- Chervil (stimulates growth)

**Tomato:**

- Parsley (improved growth)
- African marigold (works against certain types of nematodes)

**Onion:**

- Beet (improved growth)
- Chamomile (higher production, works against the maggots of the onion-fly)

Offered by [Michel](#).

I'd like to add the benefits of growing **lettuce** with **tomatoes**. Apparently lettuce gives off an exudate that slows the activity of Fusarium wilt in tomato plants. (pg 453, *Hydroponic Food Production*)

Offered by [Steve](#).

Also, if you grow **basil** and or **oregano** in the same area it provides natural bug repellent.

Offered by [Martha](#).

Green **peppers** grow well with **tomatoes** as well.

Offered by [Barb](#).

I read in one of my catalogs that inter-planting **radishes** with **beans** will help repel those notorious bean beetles. They suggest to successively plant the radishes every two weeks in order to maintain your crop, but since most of us will be leaving a fair amount of them to go to seed, that won't be as much of a consideration for us.

Offered by [Roger](#).



# Troubled Times



## Corn/Beans

---

One method that I have used is to grow vine string or butter **beans** along with the **corn**. They wrap around the stalks and seem to help some with the wind problem. You also get two different crops on the same spot of soil. I've also seen this done with row crops of corn.

Offered by [Ron](#).

I haven't done this but I have heard that **beans** and **corn** are "complementary" plants, that help one another. Perhaps one of the ways they do this is with stability.

Offered by [John](#).

On page 50 of the July 1999 issue of *Mother Earth News* magazine is an article on growing grains. Close planting of corn can help to prevent 'lodging' or falling over in wind or rain, but the article also suggests planting **beans** with the **corn** which will also help feed the corn and can be harvested at the same time as the corn (when dry and ready).

Offered by [Roger](#).



# Troubled Times



## Adverse Effect

---

Combinations to be avoided at all costs are plants that adversely affect each other. Instead of being seeded in close proximity of each other, they should be as far apart as possible from each other.

### **Potato:**

- Tomato (increases chances of getting phytophthora)
- Sunflower (suppresses growth)

### **Strawberry:**

- Cabbage (promotes rotting of the fruit)
- Potato (promotes fungal diseases)

### **Beet:**

- Runnerbean (attracts the types of insects that will cause damage)

### **Cauliflower:**

- Spinach (suppresses growth)

### **Beans and Peas:**

- Onion (promotes a great number of fungal diseases)
- Garlic (promotes a great number of fungal diseases)
- Shallot (promotes a great number of fungal diseases)
- Leek (promotes a great number of fungal diseases)
- Fennel (suppresses growth)

### **Garlic:**

- Potato (promotes rotting)

### **Celery:**

- Potato (suppresses growth, increases chances for disease)

### **Cucumber:**

- Onion (causes mildew on the cucumber)
- Garlic (causes mildew on the cucumber)

### **Cabbage:**

- Potato (promotes many disease)
- Strawberry (suppresses growth)
- Tomato (suppresses growth, promotes many diseases)

### **Parsnip/Carrot:**

- Tomato (attracts root-fly/carrot-fly)
- Cabbage (suppresses growth)

### **Leek:**

- Cabbage (suppresses growth)

- Beans (suppresses growth)

**Radish:**

- Tomato (causes flaws during growth, consequentially leaving one with more fragile plants)

**Lettuce:**

- Parsley (attacks lice)
- Dill (attacks lice)
- Fennel (attacks lice)

**Spinach:**

- Onion (will suppress it's growth process)
- Garlic (will suppress it's growth process)
- Leek (will suppress it's growth process)
- Tomato (causes rotting of the leaves)

**Tomato:**

- Swedish turnip (suppresses growth)
- Fennel (causes a many phytophthora)

**Onion:**

- Bean (suppresses growth)
- Cabbage (lowers production)
- Potato (will promote a lot of fungi)

Offered by [Michel](#).





# Troubled Times



## Recycled

---

Permaculture is the use of ecology as the basis for designing integrated systems of food production and housing. It is built upon an ethic of caring for the earth and interacting with the environment in mutually beneficial ways. Everything should be recycled so that nothing becomes trash. Trash is part of the cycle, and eventually becomes food or a usable raw material.

- Any vegetables not eaten should be fed to chickens or rabbits or other small animals raised for food. Chickens make harder shells if fed the calcium in kale and other greens. Animal bones should be cooked in soups to extract the marrow and soften the bones so calcium can be extracted.
- Compost piles are an example of permaculture. Plant scrapes and all manner of garbage are put into a warm, moist pile, which eventually becomes soil. Worms, egg shells, and garbage can go into this soil compost pile. Aerating the compost pile by turning it with a fork aids the decomposition process, as to the addition of earthworms.
- Soil erosion in farming is reduced if one uses plants as ground cover or otherwise avoids turning over the soil in windy places. A fish or other animal waste can be placed at the bottom of a seeded heap of soil, as fertilizer. The American Indians did not till the soil, but simply placed seeds into the ground, to conserve the topsoil
- Crops can be rotated in a manner that in the nutrient process. For instance, Alfalfa returns nitrogen to the soil.
- CO<sub>2</sub> from human or animal breath helps plants grow, so a synergy between humans and animals living indoors near growing plants can be established.
- Heat from animals can also be recycled during cool times, by keeping the animals indoors with the plants or even in adjoining chambers next to human living quarters. In the middle ages, and even somewhat in pioneer times in the US, folks used the heat from their herds to keep themselves warm. The animals were housed in a lean to next to the house.
- Water can be recycled too. For instance, distilled water could be used for drinking and cooking. Rainwater can be used for bathing and washing clothes. Then the water from washing dishes or clothes or bathing could be poured into the gardens as the soap in essence makes a fertilizer and the water also does not go to waste. Then, when one creates urine, that also can be used for the gardens in such a way that it does not burn the plants.
- Adding human and animal waste to the soil recycles the waste as fertilizer. Ammonia should not be put directly onto plants, as it burns them. However, if the ammonia from waste is piped under the soil and raises up through it, it combines with the microbes and carbon in the soil to create nitrogen.
- Effluent from human sewage can be run into a holding tank to grow algae. The algae is then fed to fish, and the fish eaten. The effluent can also be run over oysters and clams, which cleanse the water while extracting nutrients. There are certain plants like bulrushes that cleanse sewage effluent, which creating a pleasant marsh area housing ducks and fish or other edible wildlife.
- If lacking firewood, animal waste, dehydrated, can be used as fuel for fire.
- As human or animal waste can carry disease, food grown in soil fertilized in this way should be well cooked.

Such diseases as tetanus from horse manure, trichinosis from a parasite found in poorly cooked pork, and even the Ebola virus which spreads through poor hygiene can be eliminated through thorough cooking and good hygiene practices.



# Troubled Times



## Ecological Process

---

Article on *Permaculture*, by Richard B. Norgaard

### Agricultural Ecology

Agricultural ecology is the application of ecological principles to agricultural systems. Since ecology has several frameworks of analysis, agricultural ecology can be studied from the perspective of energy flow, nutrient cycling, food webs, the interactions between populations of organisms, and the relations organisms and their physical environment. The objective of agricultural ecology is to understand the conditions leading to sustainable, productive agriculture that has harmonious environmental impacts.

### Natural Ecosystems

From an energy perspective, agriculture may be viewed as the capture and conversion of solar energy in the tissues of crops and livestock. Using the process of photosynthesis, plants trap sunlight and combine its energy with carbon dioxide and water to form carbohydrates--energy chemical compounds that provide the materials required to sustain both plant and animal life. Most of the energy captured by plants is used directly to sustain the plant, but a small fraction is incorporated by the plant as growth - new biomass, or tissue, which is available as food for use by humans or animals.

In natural ecosystems, the energy contained in plant biomass is generally consumed by herbivores - animals that subsist on plant tissues--which are in turn consumed by predators, forming pathways known as food webs. Each organism in the pathway requires about 90 percent of its energy intake for its own maintenance, turning only about 10 percent into biomass. The rate of animal biomass production that can be sustained by an ecosystem is much lower than that of plants; that is, animals require more food in order to grow. Thus the presence of animal species in natural ecosystems reduces the quantity of food available for humans. In addition, some portion of the biomass of most ecosystems exists in forms unsuitable for human use. For these reasons relatively little energy is available for humans in natural ecosystems. It was necessary to develop agriculture, increasing the amount of available biomass, before human societies could increase their populations.

### Ecosystems in Agriculture

The success of the development of agriculture is rooted in the alteration of natural ecosystems to enhance net production and reduce losses through consumption by other species. By increasing the biomass conversion efficiencies of livestock species and the usability of resulting biomass, and by reducing losses to undesired pest species, relatively large quantities of crops and livestock may be raised on small parcels of land. This has been accomplished through the selective breeding of crop and livestock species, augmentation of water and nutrient supplies available to plants through irrigation and fertilization, and the reduction or elimination of undesired plant and animal populations through cultivation and pest control.

In traditional agriculture, net productivity was maintained through the development of farming

systems that had many of the properties of natural ecosystems. Crop species with low susceptibility to pests were developed, animal and crop wastes were returned to the soil, and crops were rotated from year to year to ensure sustained soil fertility. These systems were generally transmitted from generation to generation through cultural beliefs and customs dictating the proper relationship between humans and the natural world.

While natural ecosystems provide relatively low yields to humans, they also provide many of the environmental services required to sustain their own productivity. Where the structure of these systems is disturbed through human intervention, the ability to sustain these services is generally lost, and productivity can be maintained only through the introduction of energy and materials from beyond the farm.

## **Consequences of Modern Agriculture**

Modern agriculture has increasingly replaced the environmental services built into earlier agricultural systems with industrial inputs - machinery and synthetic fertilizers and pesticides. But the ecological costs of agricultural gains have been considerable. Industrial agriculture, for example, is heavily dependent on energy, large amounts of water, and other scarce natural resources. There is increasing evidence and concern that current agricultural practices will not be sustainable as natural resources become more scarce or more expensive.

Over-reliance on chemical pesticides has had negative consequences. Pest populations are typically reduced immediately by the application of an effective pesticide, but the predators of the pest, which naturally regulate pest populations, have often been completely eliminated by pesticide application, while some members of the pest species survive to multiply freely in the absence of natural enemies. The short-term gains are thus frequently offset by greater pest problems later in the growing season. Even when a particular pest is controlled, another insect, perhaps more destructive and difficult to eliminate, may move into the original pest's empty niche. To make matters worse, pest species frequently develop genetic resistance to particular pesticides.

Thus pesticide misuse has often necessitated larger dosages of toxic, expensive chemical compounds. Industrial agriculture has historically relied on intensive tilling and cultivation techniques, which leave the soil's surface unprotected for long periods of time, permitting erosion of topsoil. Although chemical fertilizers replace nutrients that are lost by the soil, they do little to replace the loss of the soil itself. New soil is built through the deposition and decomposition of plant material, a process substantially reduced by industrial agriculture. As a result, the ability of the soil to retain water and nutrients may deteriorate over time, reducing soil fertility.

The chemical inputs of industrial agriculture pollute the air, find their way into streams, and accumulate in groundwater supplies. Finally, over-reliance on irrigation may lead to salinization, where salts contained in irrigation water accumulate in the soil as the water evaporates or is used by plants. Plants can tolerate salt in limited concentrations, but heavy soil deposits have rendered huge areas of land infertile in both the industrialized and developing world.

## **Ecological Solutions**

Existing agricultural practices can be modified through the adoption of an ecological approach emphasizing the maintenance of environmental services within agricultural systems. Energy and resource-intensive inputs would be reduced, and natural ecological processes would be reintegrated into agricultural systems to enhance soil fertility and reduce pest infestations. For example, the use of integrated pest management - the cultivation of pest-resistant plant species, the maintenance of predator populations, reduced reliance on single crop or mono-

culture systems, which are particularly susceptible to pest outbreaks--may be less costly and more ecologically sound in controlling pest populations than the routine use of pesticides.

Soil maintenance and regeneration can be accomplished using techniques such as covering the soil with crop residues, fertilization with animal wastes, and reduced tillage to cut erosion and accelerate new soil formation. Some plant species such as legumes and alfalfa increase soil nutrient concentrations, and successive plantings of these species can maintain soil fertility without extensive use of fertilizers. The use of drip irrigation instead of more conventional techniques improves irrigation efficiency. As a result, the heavy demands placed on water supplies and the energy needed to transport the water to arid and semiarid regions may be reduced substantially. Soil salinization is also less of a threat with lower water use. Organic farming has demonstrated the validity of the ecological approach. Organic farmers may not grow as much corn or soybeans as their industrialized neighbors, but their costs are far lower, their soil generally richer, and their crops healthier.

### Third World Ecologies

Many Third World nations have developed agricultural programs that will not be sustainable over the long run. The Brazilian government, for example, encouraged the establishment of agricultural settlements in the rain forests of the Amazon, on soils unsuitable for agriculture. Farming in most of the Amazon succeeds only through slash-and-burn cultivation, which is sustainable at low population levels but very destructive at higher levels, especially when combined with modern tools, government subsidies, and other devices designed to increase production. Third World agricultural development should be rooted in an understanding of ecology and culture of the country, so that food production works with, not against, nature. Only through properly designed programs that are sensitive to natural conditions can sustainable agricultural development be achieved.

**Bibliography:** Altieri, Miguel, *Agro-Ecology: The Scientific Basis of Alternative Agriculture* (1987); Brown, Lester, "Sustaining World Agriculture," in *State of the World: A Worldwatch Institute Report on Progress toward a Sustainable Society* (1987); Cox, G.W., and Atkins, M.D., *Agricultural Ecology* (1979); Dover, Michael, and Talbot, Lee, *To Feed the Earth: Agro-Ecology for Sustainable Development* (1987); Gever, J. R., *Beyond Oil* (1986); Wolf, Edward, "Raising Agricultural Productivity," in *State of the World* (1987)



## Links

[Permaculture](#)

[Market Farming](#)

[EcoLandTech](#)

[Gardening Hand Tool Sourcelist](#)

[EcoLandTech Blog](#)

[Venaura Farm Blog](#)

## Mailing Lists

[Permaculture](#)

[Permaculture Archives](#)

[Market Farming](#)

[Market Farming Archives](#)



*-- portal to an expanding global network of landtech pioneers --*

[permies.com](#)

[permaculture forums](#)

[permies.com documents](#)

[diatomaceous earth](#)

[rocket mass heater](#)

For discussion of the nuts and bolts of permaculture, the [permaculture forums](#) at permies.com are very active.

permaculture article of the week:

To reduce consumerism of cookware, explore how easy it is to use [cast iron skillet](#) - a little knowledge will make for a better experience.

There are permaculturalists that have eliminated all chicken feed costs. Check this article on [raising chickens](#) for details.

## Useful Networking Resources

[+](#) [Share](#) | [f](#) [my](#) [g](#) [t](#)



Home > Master Publication List > Introduction to Permaculture: Concepts and Resources (Summary)



# Introduction to Permaculture: Concepts and Resources

What Is Sustainable Agriculture?

Master Publication List

Education

Energy Alternatives

Beginning Farmer

Field Crops

Horticultural Crops

Livestock & Pasture

Local Food Systems

Marketing, Business & Risk Management

Organic Farming

Pest Management

Soils & Compost

Water Management

Other Resources

Home Page

## Newsletters

sign up

- Privacy Policy
- Newsletter Archives

## XML Feeds

RSS 2.0: Events, Breaking News, Funding Opportunities

Digital Price: **Unavailable**  
Print Price: **Unavailable**

*No image available.*

By **Steve Diver**  
Published 2002  
Updated 2002  
© NCAT  
CT083  
pages

### Introduction

Permaculture is about designing ecological human habitats and food production systems. This publication discusses permaculture concepts and applications, and offers listings of resource organizations and references on permaculture.

### Table of Contents

- Introduction to Permaculture
- Permaculture Defined
- Characteristics of Permaculture
- The Practical Application of Permaculture
- The Ethics of Permaculture
- The Principles of Permaculture Design
- Permaculture Resources
- United States
- Australia
- Around the world
- Books on Permaculture
- A Few Good Books for the Permaculturist's Bookshelf
- Agroforestry Resources
- E-Mail Discussion Lists, Web Forums, & e-mail Web Archives
- Permaculture Web Links and Resources
- Manuals, Primers, and Syllabi on Permaculture
- On-Line Articles, Fact Sheets & Proceedings
- Permaculture in North America
- Permaculture in Australia
- Permaculture in Europe
- Permaculture Around the World
- Plants for Permaculture
- Permaculture Technologies
- Bioregional & Eco-Village Links

**Atom: Events, Breaking News, Funding Opportunities**

[What is RSS?](#)

[Virtual Libraries on Permaculture & Sustainability](#)  
[Agroforestry Web Sites](#)  
[Holistic Management](#)  
[About this Publication \(formerly The Permaculture FAQ\)](#)

**Note:** Digital downloads are in full color. Printed, mailed copies are only available in black & white.

 [Back to top](#)

This page was last updated on: October 12, 2011

**NCAT** strives to make our information available to everyone who needs it. If you are a limited-access or low-income farmer and find that one of our publications is just not in your budget, please call 800-346-9140.

The National Sustainable Agriculture Information Service - ATTRA - is developed and managed by the National Center for Appropriate Technology (NCAT).

Visit the [NCAT website](#) for more information on our other sustainable agriculture and energy projects.

[Support](#) | [Terms of Service](#) | [Site Map](#) | [Comments](#) | [Privacy Policy](#) |  [Facebook](#) | [Donate](#)

Copyright © NCAT 1997-2012. All Rights Reserved.







# the Permaculture ASSOCIATION

[About](#) | [Media](#) | [Donate](#) | [Join](#) | [Contact](#) | [Login](#)

[Welcome](#)

[Our Work](#)

[Knowledge Base](#)

[Education](#)

[People Projects Places](#)

[International](#)

[Get Involved](#)

[Noticeboard](#)



## Welcome

Permaculture works with nature to make a better world for all. By observing the natural world we can see a set of principles at work. Permaculture design uses these principles to develop integrated systems that provide for our needs of food, shelter, energy and community in ways that are healthy and efficient. We can use permaculture design methods to improve the quality and productivity of our individual lives, our society and our environment.

The Permaculture Association is the national charity that supports people to learn about and use permaculture.

## Our Work

Here you will find out about the work of the Permaculture Association and the latest news on it's many projects - farming, education, what going on in Scotland and Wales and much more.

## Knowledge Base

All about permaculture ethics, principles and design methods. 'Practical solutions' brings together many different approaches and techniques used and 'resources' signposts a wealth of information and support.

## Education

Find out about permaculture courses, the Diploma in Applied Permaculture Design, teaching resources, tips on visiting and volunteering at projects and learning with others.

## People Projects Places

LAND network information and funding sources. The 'people, projects, places' database will appear shortly and connect you to groups and activities across the UK.

## International

The Association has been supporting permaculture internationally since 1983. Find out about the international network and active projects and groups in over 100 countries.

## Get Involved

There are many different ways to get involved in permaculture and make use of the practical skills on offer. This section gives useful pointers to farmers, teachers, activists and networkers.

## Noticeboard

This section will allow you to add jobs and opportunities to help you get volunteers, recruit wonderful permaculture designers and share resources.

## Quick Links

- [Find a course](#)
- [What is permaculture?](#)
- [LAND Demonstration Network](#)
- [Funding for events](#)
- [Get the ebulletin](#)

## Search

Search this site:

[Join us](#)



Become a member of the Permaculture Association - get connected, get involved and support our work!

Choose how to [donate](#) and support permaculture

## Website Update

**Where's the "What's Going On" Button?**

This section has now become "[Our Work](#)"

Here you can find out what...

[Changes Feb 2012](#)

## Designer's Manual by Bill Mollison

**Available now!**

This is still the classic permaculture textbook. It hasn't been available in the UK for years, so we're delighted to be able to make it available.

## Find us on the web

See what's been happening at the Permaculture Association...

See our [Photos on Flickr](#)

Visit our [Facebook Page](#)

[Sitemap](#) [Creative Commons](#) [Disclaimer](#) [Website terms & conditions](#) [Website](#)

The Permaculture Association is a company (05908919) and registered charity (1116699 and SC041695)

# Troubled Times



## Design Consultant

---

I am a Certified Permaculture Design Consultant. Permaculture is (amongst many definitions, depending upon context) the acclimated, holistic design implementation of agriculturally productive, economically viable, and socially stable eco-systems which are as resilient, regenerative, and mature as the earth's eco-systems where ever. I design gardens, and other agriculture, home-systems often in relation to this (permanent agriculture culture), communities, infrastructure (home-systems in masse, collectively), transportation, economic systems, etc. generally on a community level with emphasis on the local area, bio-region, wildlife, as well as people.

I am available for consultation whether through email, snail mail, phone, or by visitation. I am happy to give free tidbits of advice. Complete land assessments, home-system designs, feng shui divination, water dousing, and other services are available based on sliding scale fees appropriate to the income level of the recipient. If you are endeavoring to build a home yourself or if you would like something planned, implemented and built (or from any phase) from start to finish feel free to contact me at the above address. Be safe, and be prepared. For whatever becomes of the pole shift or any other disaster then we need to have stability and sustainable, regenerative means of survival and thriving.

Offered by [Steven](#).



# Troubled Times



## Home Design

---

The home-systems, gardens, etc. I design are sure to attract some attention as they are geared for ultimate survival and thrival (to thrive). They are able to with stand disaster of the magnitude associated with the pole shift and are able to regenerate any losses incurred. My primary work deals with the use of natural materials, recycled products, efficient design (modeling or mimicking nature) and of course Geodesic Domes. I have a particularly apt design for a home-system, a hybrid of sorts, of such an area as much as 6000+ sq. ft. living space, on 3 floors. It has an average insulation R-value of 40 or more all around. It is designed to accommodate as many as 30 people, yet can be managed by 1 or 2. Traditional post and beam techniques use most of the materials, yet the dome component contains the most space. A variety of textures and surfaces use such materials and mixtures as cob, woddle and daub, clay/straw (insulation in forms for walls), concrete and clay (great for floors and stucco), strawbale (for walls in straight forms or sections), concrete/sand/sawdust mixes (for exterior walk ways and secondary foundation insulation) and more. Nothing is wasted, everything is used.

Best estimates for this home-system, depending upon local cost of materials, labor, extras, accommodations, taxes, etc. and the amount of "sweat equity" the new occupants want to provide, are easily under \$100,000.00. Most can be done for about \$60,000 to \$90,000. All this includes the house, the windows, flooring, most fixtures, all plumbing, total electrical system, doors, hardware, etc. not to mention the water, sunlight, soil, etc. Why buy or build a home that requires you to pay for it over and over again just to keep it up (not to mention the loan from the bank if applicable). Heat is free, water is free, much of the gas for fuel is free (just eat and go to the potty!), hot water is free, food is soon to be free, etc. Why build just a house when you can build a complete home-system for the same price as, or less than the cost of a conventional home? (And why live in a square/cubical house when we all live on a round/spherical planet?)

Our homes, thus our culture, are a reflection of the spiritual, economic, infrastructure, social relationship with the earth. Any attempt to do otherwise, modes which are not aligned with natural forces and mathematical patterns of Universe, are sure to be destroyed or ultimately come to ruin both their own structure as well as the folks living (or dying) within (then without) them. Build it right the first time and all that atrophy will not happen, thus we should have less then to worry about and more time to get the rest of the real work done.

Offered by [Steven](#).



# Troubled Times



## Heat & Light

---

Heating is passive solar (primarily) with some backups. The great mass of clay tile floors, area for a swimming pole or hot tub (some 1000 to 2000 gal. of water), many posts and beams, stone (particularly slate, river stone, sand stone and the like) in addition to the surrounding insulated mass of foundation and sub-soil beneath the home provide for plenty of thermal sinks (storage for heat/solar radiation). There is also an optional wood stove or similar, aesthetics and climate depending, available in the design. Hot water is solar heated and solar pumped (thermo-siphoning) up to an insulated storage source (a conventional gas water heater with additional insulation) on the 3rd floor. In the event of the lack of sun light the gas water heater can heat the water, should it cool.

The whole hot water system is a closed loop system where hot water can be reheated to outstanding temperatures or released to water plants in greenhouse or garden. All water hot and cold is gravity fed to the various usage areas on the 1st and 2nd floors. All gray water is then piped and distributed to planted beds, trees, pots and raised in the greenhouse and gardens. An optional system has been designed to deal with access water or all water in times of severity or drought where, through a bio-logical water filter system, all water is made pure (in the space of only 60sq.ft. per 3-4 persons avg. based on conservative usage of water.) The water is then reused and heated/pumped again through the system. New incoming water is collected from the roof primarily. Optional sources include ponds, wells, springs and more. All water is appropriated to be gravity fed, no extra pumps. All water is carbon filtered and if necessary lightly "salted" or mineralized to balance the pH (typically most rain water is acidic).

Electricity relies primarily on 2 to 5 20+sq.ft. photovoltaic panels, generating about 1000watts per hour. Also, depending upon local conditions (or expected changes) the use of wind powered mills, or micro-hydro electric should also be incorporated (never rely on just one source). Other options include the hand generator or the bicycle generator (want to watch a movie on the TV, then get on the bike for an hour or two?). I also have a design for a static electricity generator that relies on the water (and the static friction thus electrical current) that flows down the plumbing from hot water storage to usage areas. Total system includes of course 10 12 volt batteries, to operate on a 120 volt system, AC/DC converter, voltage meter, appropriate AC wiring, boxes, switches, outlets, etc. More on this later.

Offered by [Steven](#).



# Troubled Times



## Water

---

Your kitchen sink should have a grease trap. Simply take a 5 gallon bucket cut 2 holes, one on either side near the top the size of your input and output plumbing (say a standard 2" line). Leave room for the lid. Insert a piece of plastic of a width equal to the diameter of the inside of the bucket and apply a non-toxic waterproof adhesive to seal it, making two halves in the bucket. Leave about 2" to 4" (depending on the depth of the bucket) from plastic piece to the bottom of the bucket. The effect: all grease, oils, fats, etc. as well as any debris or solid material will be kept in the bucket, on the one side where it goes in. Make sure everything fits well especially the pipes, but where the pipes must be able to be removed so perhaps once every month to three or so you can dump the bucket in the compost pile or mix it in the worm bin of large size. Be sure that the bucket contains nothing harmful or toxic.

For your shower you may wish to do the same. But if the shower is located near the planting beds (since you are hopefully not putting vegetable scraps and greasy dishpan water down it) where the plumbing lines are at a steep enough angle you may feed directly to the beds. Whatever the source for the gray water, once the plumbing reaches the planting beds the pipes therein should have plenty of holes top and bottom and be of a diameter at least 4", flexibility helps too! Get the large black flexible pipe with the holes all ready in it. The pipe in the bed should be buried at least 8" down but still have some 6" of soil underneath. (This will thoroughly drench the soil without exposing the pipe. What is neat is you may notice after a shower lots of steam rising from the bed. Plant those plants at the beginning of the pipe that like it hot. Cooler or drier loving plants toward the very end.)

If you should decide to run your gray water outside to a garden or improvised wetland area, keep the similar black pipe only without the holes until you get to the intended area, at least 10 ft. away from the home, downhill. The pipe should leave the house through the foundation if need be at a depth of at least 2' or below the frost line to avoid freezing (this will vary depending on where you live). Basis Guidelines: to move water adequately have a drop of at least 1" per 100". For the shower direct setup make about 1" per 10" drop, but then back a 1 to 100" for slow, even flow. If you are worried about your drain clogging get a bigger pipe and try not to impede any flow. Or have a drain to catch most of the hair and stuff, remove it and throw it in the soil regularly.

Offered by [Steven](#).



# Troubled Times



## Organic Matter

---

All manure, whether animal or (especially) human, is collected in a large anaerobic digestion tank where methane can be generated to power appliances including, refrigerator, stove, and water heater, etc. All appliances relying on gas are fitted w/ appropriated lines and fixtures. They can be also fitted with temporary startup/backups with propane fixtures, valves, etc. (the lines remain the same). All vegetable waste is composted or mulched on plants and soil, whether in greenhouse or garden. A worm bin is provided for coarse materials like paper and wood chips. All plants are companion planted, using heirloom varieties for maximum sustainable yield and seed/food/mulch harvest.

Offered by [Steven](#).



# Troubled Times

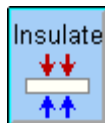

## Groworld Module Project

---

The Gardination of the Groworld Module Project - is a handbook of techniques, materials and reasonings, rationale and expectations, floor plans and elevations, many pictures demonstrating the alternative building techniques and materials and aesthetic and ergonomic results, performance evaluation of dramatic natural convection of heat energy and storage through the ducts buried in the 187 ton insulated thermal anchor, 52 degree food storage, carbon dioxide monitoring aspects, letting insects manage themselves, liquid fertilizers especially urine, and growing mediums and semi-hydroponic methods, soils and wood ash potash, hydraulic hand deep-well water pumping, sunflower pressing for cooking and lighting oil, chickens, crops and companion planting, and most importantly, the seed as physician, as widely practiced in Russia.

Here is a Manual for survival in a houseosphere. It is a double-envelope ultra-insulated residence for ten or more entities demonstrated to survive without fuel, electricity, or technology and grow its own food in a two-story gardination. Crane-erected r=35 Structural Insulated Panels for exterior walls and roofs reduce labor costs and facilitate erection, providing easy 'super insulation' to this low-tech no-tech self-sufficient 'solar' construction, developed over the last 30 years through 40 solar houses and a Buddhist Temple by this alternative designer/builder/artist/author.

This 58 page PDF file color Manual is easily downloadable at <http://www.geometryofplace.com/groworld.pdf>

Offered by [Llan Starkweather](#).





# Troubled Times



## Nutrient Solution

---

For best results the pH should be kept between 5.5 and 6.5. Plant nutrients to be maintained in the hydroponic water are given as parts per million (ppm).

PPM	ELEMENT	
96	N	Nitrogen (as nitrate)
48	P	Phosphorous
264	K	Potassium
132	Ca	Calcium
48	Mg	Magnesium
412	SO	Sulfate
3.0	Fe	Iron
0.5	Mn	Manganese
0.08	Zn	Zinc
0.06	Cu	Copper
0.5	B	Boron
0.1	Mo	Molybdenum



# Troubled Times



## Large Quantities

Two companies in commercial hydroponics differ in their approach. American Hydroculture supposedly uses "new" hydroponics technics that Archer Daniels Midland does not. Take a look at the quoted yields of the two companies. Very disparate. American Hydroculture states:

We can grow vegetables in half the time of conventional farming on 1/200th of the land using 1/400th of the water - and at prices in line with produce from traditional farming. .. Future Farm announced today that it has begun construction on three new state-of-the-art greenhouses on its Palm City property. ... The growing facility will expand from its current 3,600 square feet .. allowing production monthly of 24,000 heads of bibb lettuce, 72,000 pounds of tomatoes and 45,000 pounds of peppers.



Archer Daniels Midland's are much more believable. In addition, Archer Daniels Midland is a \$5 billion dollar company doing this since 1981. Not committing to the latest technology is very unlike this company. In either case, the yields once you know what you're doing are very impressive! You can feed a lot of people!

Offered by [John](#).



# Troubled Times

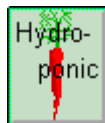

## Produce

---

Plants that are grown hydroponically at a nursery nearby: Arugula, Watercress, Sorrel, Swiss Chard, Spinach, Red Oak Leaf Lettuce, Green Oak Leaf Lettuce, Red lettuce, Bibb lettuce, Basil, Cilantro, Chervil, and Rosemary. The grower did tell me he was having trouble with the spinach bolting to seed too quickly, something to consider.

Offered by [Toni](#).

The spinach bolting to seed indicates either too much light or too much heat. It is very good to hear that the other vegetables and herbs are being successfully grown hydroponically.

Offered by [Ron](#).

His temperature is too high for the spinach. He should separate them if possible and keep them cooler (like at about 65 or 70 degrees).

Offered by [Roger](#).



# Troubled Times



## Lettuce

---

Probably the easiest plant to grow in low light with moderate temperatures is lettuce. It does need a good dose of light to get going, but once 4 leaves are out, it can be moved near a window or at the far lengths of light's reach and grow profusely. Plant in rockwool and cut out a hole in Styrofoam. Place the Styrofoam in water and run one of those long green things that you find in aquariums for a few hours a day. You'll be giving it away you'll have so much.

Offered by [John](#).

Please review the [Nutritional Value](#) of lettuce. It could be used as a modest source of Vitamin C, but an adult would have to eat almost 6 cups to meet the USDA. In addition, lettuce is a natural diuretic which can flush the body of water soluble nutrients, this would be undesirable where potable water is scarce. Granted it could be useful for just helping to fill empty stomachs.

Offered by [Steve](#)



# Troubled Times



## Continuous

---

Strawberry plants continually produce fruit, they never expire as long as they are fed properly and given light. I think they can also go into dormancy if you do not have ample solution on hand but do have some light. Strawberries, I think, would be an excellent treat when most of our sweet foods of the past are gone.

Offered by [Ted](#).



# Troubled Times



## Yields

---

### Comparative Yields Per Acre

In Soil and Soiless

Crop	Soil	Soiless
Soya	600 lb	1,550 lb
Beans	5 tons	21 tons
Peas	1 ton	9 tons
Wheat	600 lb	4,100 lb
Rice	1,000 lb	5,000 lb
Oats	1,000 lb	2,500 lb
Beets	4 tons	12 tons
Potatoes	8 tons	70 tons
Cabbage	13,000 lb	18,000 lb
Lettuce	9,000 lb	21,000 lb
Tomatoes	5-10 tons	60-300 tons
Cucumbers	7,000 lb	28,000 lb

**Source:** *Hydroponic Food Production*, by Howard M. Resh, Ph.D.



# Troubled Times

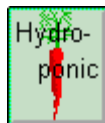

## Grass

---

How many of you are planning on raising grain fed animals for pack animals or for food? What are you going to feed them? Where are you going to grow it? Wheat is more than the wheat berries we consume. Another reason it is grown so widely in the midwest is straw can be made from it for feed!

Offered by [Roger](#).

Wheat can also be grown into wheatgrass easily and also sprouted for use alone as sprouts or baked into bread. It may be inefficient to grow the wheat to maturity because of ratio of edible/non-edible plant mass. Maybe growing wheat might have to wait until consistent sun returns for outdoor harvesting. I suppose this applies to other grains too.

Offered by [Craig](#).



# Troubled Times



## Efficient

---

I have been experimenting for years to find the best plants to produce the most edible mass per square ft. of space above and below soil surface. Anyone with practical experience would understand that any plant grown hydroponically or in soil indoors or greenhouse needs to be a plant that has a bulk yield in fruit, seed, or totally edible vegetative material that far outweighs the mass of the plant to produce the edible parts. Wheat then would never be feasible because of the amount needed to be grown to be of use.

Offered by [Woodie](#).

We need to maximize edible growth per unit growing area for a given minimum growing time period. This might lead us to fast growing plants that are totally edible, roots and all. If they also did not take up much space (land area) as compared to the mass they produce we would have a winner. This is assuming light is a constant during our comparison. Edible weeds become a consideration. No hybrid problem and plenty of availability of seeds.

Offered by [Mike](#).

Just musing here, but it seems that the beet plant is a good candidate. It grows well in all soil types. It is completely edible (leaves as greens, and obviously the root too). It doesn't require a great deal of depth of soil (6 to 8 inches). It will get along okay in shady areas. And so on. But think about the culinary boredom that would arise from a diet of beets alone! Also, I don't think you could get all the nutrients required for life from one plant. Even supplementing a protein source such as earthworms would give rise to loss of appetite due to culinary boredom. We do need to find efficient plants, but we also need to consider growing less efficient plants on occasion for diversity in diet.

Offered by [Roger](#).





# Troubled Times



## Hydroponics Articles

---

The possibility that plants could survive and grow without soil as the nutrient source was first described historically by Woodward in 1699. In the 1840's, a number of German botanists developed the basic nutrient formulas and growing techniques which are in use today. Most of what has been developed since then are refinements of and adaptations to these early discoveries. Hydroponics requires as little as 10% as much land as regular farming, and less than 10% as much water. If the hydroponic water is recirculated, water use is dramatically less. Hydroponic advocates claim that an area the size of a large back yard can supply 100 people with fresh vegetables during the year. Hydroponic produce is less affected by insects so does not carry traces of insecticide, and can be picked ripe just before eating so preservatives are not required. Produce such as broccoli, cabbage, celery, chard, cucumbers, eggplant, flowers, grapes, lettuce, melons, onions, peppers, pole beans, radishes, strawberries, and tomatoes have been grown hydroponically.

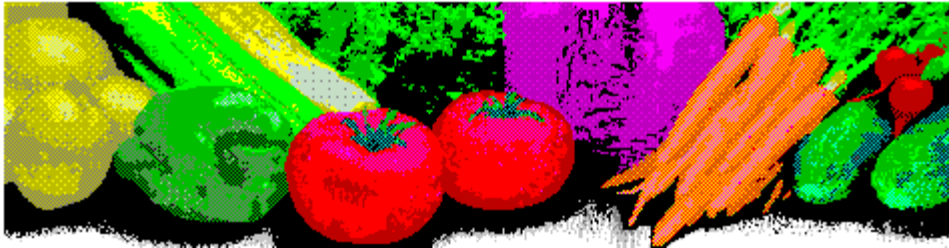

An article called **Feeding Astronauts - And Ourselves** on page 40 of the Jan/Feb '92 issue of *The Futurist* magazine describes the benefits to be derived from hydroponics. Excerpts of the article follow:

[Hydroponics is] an agricultural technique that uses nutrient-enriched water rather than soil as a growth medium. ... Growth chambers allow the producer to control the amount of light and carbon dioxide the plants receive, as well as the humidity and temperature of the air. Because there are no seasons inside a growth chamber, crops could grow year-round in any part of the world, eliminating transportation and storage costs. In addition, herbicides and insecticides are unnecessary because there are no weeds or insects to disturb the plants.

An article called **Hydroponic Produce** on page 8 of the July '91 issue of *Consumer Research* magazine describes hydroponic techniques and the variety of vegetables, fruits, and flowers that are being successfully grown hydroponically. Excerpts of the article follow:

Hydroponically-grown vegetables such as tomatoes, "burpless" cucumbers, and bibb lettuce have become commonplace offerings in the produce sections of many supermarkets. Many consumers favor these vegetables, which, being grown in water, are clean and have no soil clinging to them. Such produce has good flavor, having been allowed to ripen fully before it is picked. Because the roots of bibb lettuce are left intact on the plant within the plastic wrapper, the lettuce actually continues to grow and does not wilt readily. The controlled environment of hydroponics also eliminates the need for pesticides.

Modern hydroponics began in the 1860s. Plants were found to thrive, provided they received all the needed macro and micro nutrients from inorganic salts in solutions. Water economy is an attractive feature for arid areas because, in hydroponic systems, precious water can be recirculated. A large volume of hydroponic food can be grown rapidly in a small area. Reportedly, four heads of lettuce can be raised in the same amount of space required to grow one head of field lettuce. ... The technique has been suggested to raise a weekly crop of grass as cattle feed.

Hydroponic techniques vary. In water culture, the roots of the plants are held in a large waterproof tank. The plants are supported by mesh or string. In gravel cultures - a more costly system to install and maintain - a water-proof bench is filled with inert pea-sized gravel to support the roots. A solution containing all the essential nutrients required by the plant is pumped into the gravel from a holding tank. When the bench is full of the solution, the pump is turned off and the solution drains back to the holding tank. The solution is replenished periodically. A nutrient film technique is another system, which does not require as large a holding tank as that used in gravel culture. The plants grow in narrow, shallow troughs, and the roots of the plants are constantly bathed in a flowing solution of nutrients.

The lamps that are used emit three different wavelengths of light (red, far red, and blue) in a proper ratio to stimulate photosynthesis.



# Troubled Times



## Simple Systems

---

Through my internship at my local farm i've learned quite a bit about hydroponics. I've recently taken that knowledge into my basement where I've designed and setup a few test systems. These are hydro systems which I feel might be more user-friendly.

### Cold Frame

This system can be built by a 6 year-old. It consists of a styrofoam board with plastic pots resting in it. the styrofoam floats on a reservoir of water so that the the roots of the plants dangle in the water. The water never needs to be changed, only nutrients added. (If you want, system can be circulated with a pump.)

Pros - inexpensive, simple construction (can be made during aftertime using wood as substitute for styrofoam), low maintenance, very forgiving, does not require a pump, requires very little water.

Cons - seeds need a medium to grow in (rockwool/oasis cubes/etc. - difficult after the pole shift).

Plants - anything that needs lots of water. lettuce and basil *thrive* in these systems. I'd imagine watercress would do well (high vitamins). I've got a bunch of seeds and I'm going to try everything I have in each system. I'll let you know what does well.

ToDo's - develop medium that will exist during the aftertime as a replacement for rockwool cubes, experiment floating styrofoam/wood on top of fish tanks.

### Ebb & Flow

Plants each have their own pot and are grown in a medium other than soil (usually perlite, vermiculite, and peat 1:1:1). Pots (with holes in the bottom) rest in a reservoir that is flooded 2-3 times/day. The medium retains enough water to keep the plants healthy. Flooding can be done by a pump on a timer, or a flood/drain bucket that's raised and lowered by hand. (Can also be done without pots and all plants in same medium.)

Pros - inexpensive, simple construction, little water, no pump needed.

Cons - if not using a timer skipping a few waterings can damage plants plants - just about anything.

ToDo's - develop medium that will exist during aftertime (possibly sand, however, sand might retain too much water and suffocate the plants, need something to mix with it for proper aeration).

Much work still needs to be done to get these solutions to the point where they can be completely constructed during the aftertime. We're eventually going to run out of rockwool, tubing, pvc pipe, etc.

Offered by [Gabe](#).



# Troubled Times



## Ebb & Flow

---

There are many different kinds of hydroponic systems. Some are more complex (i.e. nutrient film technique), and some require an electric pump. But in my opinion, there are forms of hydroponics that are perfectly suited to an aftertime environment. For example, electricity is not needed if you are using a simple ebb and flow model. In that case, a bucket would be raised and lowered to flood and drain the tanks (respectively). Take a look at the [4th Picture](#) and on the [Simple Systems](#) page to get an idea of what I'm talking about. Hydroponics pro's as compared to soil based: better yields, faster growth, less chance of disease, and more plants in less square feet.

Offered by [Gabe](#).

Personally, I will be using soil based food production. It is suggested, and some of the evidence agrees, that hydroponics can out-produce conventional soil-based crops, however, there is the need of a carefully controlled nutrient solution and more electrical needs in the form of a pump to circulate that solution. The Troubled Times hydroponics lab has proven that alternate forms of nutrient solution can be used, but not everyone will be able to advance purchase their hydroponics equipment and then be able to maintain it after the shift. One can always fill a bucket with dirt and stick a potato in it and put it under some light.

Offered by [Roger](#).

Good points on hydroponics. Often what we think of for hydroponics involves elaborate plumbing, with pumps, pH meters etc. But as you pointed out they can be simple, like an ebb and flow method or even a wick system which simply requires one to keep a reservoir full. One other comment involving my experience is that the greens seem the easiest and fastest growing in hydroponics, fruiting plants (tomatoes, peppers) require a broader range of nutrients, but if you do it right you can have incredible yields.

Offered by [Stan](#).



# Troubled Times



## Your Own Gardens

- Crops are grown in beds which are really shallow tanks or troughs that serve as a container for gravel or coarse sand. If there are several of these beds, they should be set up in a series at the same level and of a similar size.
- These beds should be about 3 feet wide and any convenient length, although 100 feet is common. The sides are about 8 inches high and with a V bottom so the center is 11 or 12 inches deep at the center.
- Beds intended to survive massive earthquake damage should be wooden frames lined with heavy vinyl sheeting. Pipes or other fittings should be plastic for increased flexibility and ease of repair after earthquake damage.

### Hydroponic Beds - 3' Wide and up to 100' Long

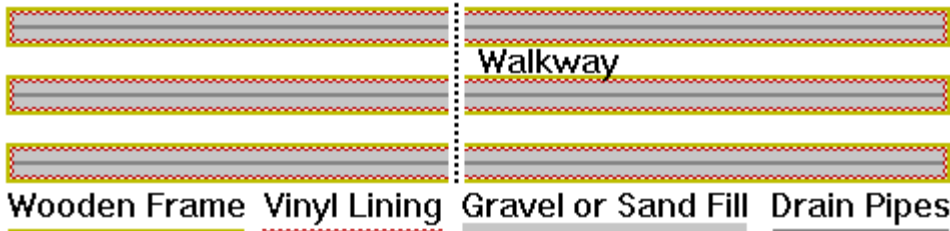

- This permits an arrangement whereby a half-tile or similar device through the center of the bed will feed or drain the solution rapidly from one end of the bed to the other. It is very important that the slope be precise, with no low areas from which solution will not drain.
- Drainage in the beds is not only pointed toward the V bottom of the bed, but also toward one end of the bed, so that the V at the drain end is 2" lower than at the high end of the bed. This is a slight slope in the bottom of the trough.

### Drainage Drop - 2" to bottom at High End, 4" at Low End

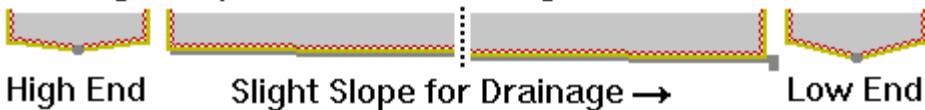

- There must be a pipe connection to the lowest point in the V at the drain end of the trough. The nutrient solution can then be pumped into the trough through that pipe and will drain out again when the pump has been shut off. The quantity of solution in the tank should be just sufficient to bring the water level up to within 1/2 to 1 inch of the top of the gravel or sand in the beds.
- The entire hydroponics system is relatively simple to operate and may be made at least semi- automatic. In cool weather, pumping solution should be done once a day, but in warm, dry, or windy weather, it may be necessary 2 or 3 times a day. Installation of a time clock allows the start and stop of the pump to be automatically.
- A centrifugal pump of sufficient capacity to fill beds in one-half hour is generally best for forcing the solution into the beds. With a centrifugal pump, the solution will flow by gravity through the pump back into the tank.

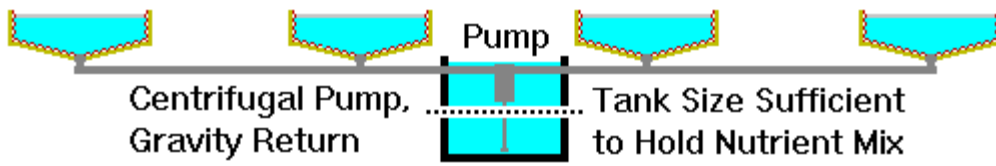

- For those without a pump, a simple pail and flexible hose system to give the hydroponic beds their daily nutrient bath works well.

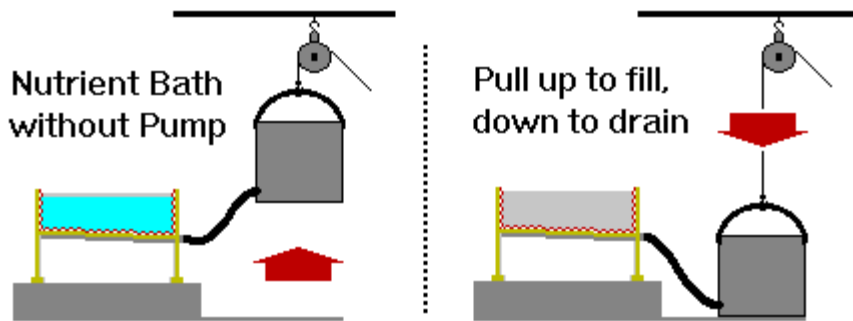

- Gravel for the bed should be fairly uniform in texture, about 1/2 to 1/4 in diameter, and washed. If you use sand, it should be coarse and it also should be washed. Beds should be filled to within 1 inch of the top. The mix should be sterilized with heat or steam to prevent mildew and fungus problems.
- Use the best seed for seedlings, planted in disease-free soil or sand and six inches or more high before transplanting. Loosen the planting media around the roots so that there will be as little injury as possible to the roots during transplanting. Rinse the planting media off the roots with water before planting in the hydroponic beds.
- Supporting structures may be necessary to hold up the plants, as plants loaded with fruit, for example, are heavy. Do not attach supports to the ends of beds because the weight of the plants may warp the structure and cause leaks or draining problems. All supporting wires are suspended from overhead supports that are spaced at intervals alongside the troughs.

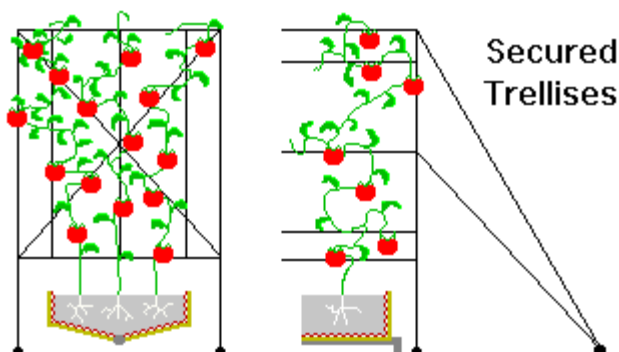

- Cooling of the hydroponic area can be achieved by ventilation, as transpiration of moisture off the leaf cools the plants just as perspiration cools the human body. Slats or windows that allow the air to circulate should be included in the arrangement.
- Plants produce oxygen during the day, under lighted conditions, and carbon dioxide during the night. Hydroponic areas attached to living areas thus can oxygenate and cleanse the air of carbon dioxide, but should be closed off during the night so that oxygen is not depleted from the sleeping areas.
- Pollination can be done either by bees or by hand, by manually shaking or tapping the flowers once a day, going

flower to flower so as to spread the pollen. Pollination helps increase fruit yield, and for some produce makes the difference between a high yield or no yield at all.

Authored by [Nancy](#).





# Troubled Times



## Quonset Hut

---

Had an idea for hydroponics gardening. Submerge pony wall, approx. 3' tall, below grade. On top of same (widen footing at grade level) mount Quonset hut. Probably minimum of 16 foot wide to 20'. Quick construction, good barn raising mechanics for 3 or more to set up in a week. Good wind deflection, no maintenance. Wrap same with straw bales from ground level up and over top. Chicken wire over same wired to bales. Stucco or plaster over bale and chicken wire. This will give you about an R-60 value for summer or winter. Therefore cool in summer and easy to heat in winter, thereby reducing energy cost. I like the windmill idea for supplying water pump and lighting needs.

Offered by [Ron](#).



# Apples to Apples Hydroponics Experiment

This experiment is to establish the relative worth of worm bed drainage and fish water for hydroponics.

**October 11, 2000**

[Environments](#)

[Planting](#)

**December 12, 2000**

[Nutrients](#)

[Growth](#)

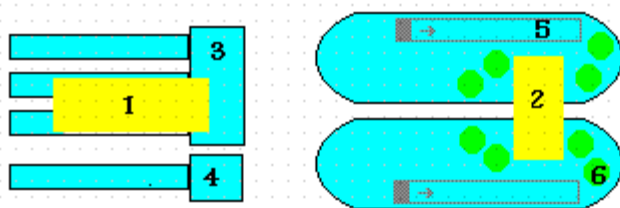

**January 5, 2001**

[Nutrients](#)

**January 15, 2001**

[Snapshots](#)

**February 17, 2001**

[Blooms](#)

## Apples to Apples Comparison

- same plants in all three environments
- large hydroponic unit (3) used as a control
- small hydroponic unit (4) dedicated to worm bed drainage
- large Halide (1) light over hydroponic pots and pumps
- small Halide (2) light over fish tanks
- existing flow return (5) from bio-filter to run down guttering
- existing watercress boats (6) to remain

# Troubled Times



## Wood Ash

---

Since finding Potash was suggested to be from ashes, rich in this nutrient, I was planning to get some ashes from a wood stove nearby and explore this. Just about the time the acid level was diving from 6.5 to 5.5, I arrived with filtered water from water soaked ashes, *very* alkaline. Lesson learned: earthworms, poop, and ashes are common ingredients that the common family can acquire. This balanced the pH beautifully, and I continued to add wood ash water periodically, testing pH to see when a pH of 7.0 or anyway at or above 6.5 was reached. At one point I added too *much* wood ash water, and the solution was highly alkaline, to my horror. So the ashes are a solution to high acid hydroponic water. Other than commercial strips or tabs, how would one determine that the pH was too acid or alkaline? I think the taste test might do it, acid or *not*, like vinegar or *not*, but since the solution is gained from manure in worm beds, one is likely to get the runs from this test.

Offered by [Nancy](#).

Best Management Practices for Wood Ash Used as an Agricultural Soil.

<http://hubcap.clemson.edu/~blpprt/bestwoodash.html>

Offered by [Gabe](#).

pH can be tested using red cabbage soaked paper;

<http://www.chemtutor.com/acid.htm>

We tried this and it works as advertised! Guess we have to put red cabbage on the list of plants to be growing. Next step is to find the degree of acid or alkaline condition (how far from pH 7 something is.)

Offered by [Michael](#).



# Troubled Times



## Volcanic Ash

---

The source of a hydroponics solution will come from an overlooked source. The primary cause leading to the destruction of most vegetative life on Earth, volcanic ash, which will cloud the atmosphere preventing sunlight, will have another purpose. Have you ever noticed that the sides of volcanoes support lush vegetation? The ash is composed of Carbon, Nitrogen, Phosphorus, Hydrogen, Sulfur, Sodium, Iron and other trace elements found in hydroponics solutions on the market today. Rainwater will contain most chemicals needed to provide a nutrient solution, as it washes the air from the volcanic ash. The concentration of the nutrient solution does not have to be high since it can be discarded after one use, though that can be adjusted up by evaporation. The fact that rain will be constantly falling, provide an unlimited source during the first few years. Minerals containing those same elements in compound form can replace elements that may be missing in the rainwater every so often. These minerals can be sized to pea gravel size form and placed as part of the growing medium. Leaching of these chemicals naturally as rainwater pass over should be sufficient to replace shortages.

Offered by [Robert](#).

Atmospheric nitrogen can't be used by plants as a source of nitrogen (except for legumes which have a bacteria which can convert atmospheric nitrogen for the plant's use). Plants need most of their nitrogen in the nitrate form, although they can use some ammonia (too much is toxic). It is good to see someone recognizes volcanic ash as the wonderful fertilizer it is.

Offered by [Jennifer](#).



# Troubled Times



## Indoor Pollination

---

Had a conversation with Nancy last week about tomatoes and she told me how her relatives used an electric toothbrush on their tomato blooms, to pollinate them. I have tried it and within days, 4 new tomatoes where blooms once were on the single plant bringing to five the number on this plant.

Offered by [John](#).

With my Tom Thumb tomatoes in my hydroponic garden. I shake 'em in the morning, shake 'em in the evening and they're proliferating out the wazoo. My lettuce has turned out well but even with plenty of light using a 400 watt sodium conversion bulb, I can't seem to get them to go to seed.

Offered by [Steve](#).

Get a box of Q-tips and prepare to use them. Outside, tomatoes are pollinated by insects or, occasionally, by the breeze. If inside, there are no insects or wind. Outside gardeners also experience this problem if they use sprinklers (which scare the bees away and also wash off pollen). Collect pollen from stamen and transfer carefully to calyces of other blooms via Q-tip, and do it every morning before your lights are scheduled to go on. Another useful thought: do your plants receive a breeze? The usual recommendation is to wall-mount a small electric fan that blows constantly on the tomatoes during the "on" part of the light cycle. It both helps to pollinate and evaporates away the moisture produced by carbon dioxide respiration, so it lowers ambient water moisture and encourages the plant to absorb more water by its roots. It also prevents many diseases that are fostered by high humidity.

Offered by [Jenny](#).

I have 6 tomato plants (Greenhouse variety) growing underneath regular fluorescent lights. I am in the process of dwarfing them to 18 inches and I have buds on all but one of the plants. The first plant to bloom did so about 10 days ago and as soon as the bloom opened up, I diddled the bloom (basically I wiggled it with a finger). I did this daily for about three days, then I noticed that the bloom was no longer opening up in the morning. Today I notice that that bloom is no longer a flower at all, instead it is a very small tomato! This plant also has two more blooms that are no longer opening up so in about 5 to 7 days I will have two more tomatoes on this plant. I just wanted to point out that you really don't need anything fancy to pollinate your tomatoes. A finger will work! Shaking will also work. Give the tomatoes a good shaking. Just grab hold of the cage or trellis or whatever and shake it once or twice. Do this every day.

Offered by [Roger](#).



# Troubled Times



## Stressed

---

Several years ago I had a beautiful garden in Oklahoma. I had about 30 tomato plants that were watered by drip irrigation with fertilizer injected into the irrigation system. The tomato plants were *huge*, incredibly healthy and full of blossoms that wouldn't bare fruit, but eventually fell off. I tried everything. Finally I mentioned it to an old man working at a nursery. He said they were *too* healthy and happy. They didn't need to produce offspring and somehow knew it. He told me to take a stick and give them a good beating. Well, I was so frustrated with them by this time that I took an old fishing rod and proceeded to do just that. Within a week I noticed that the blossoms were no longer falling off until a nice little tomato was starting in their place. I produced almost 200 quarts of tomato sauce from that crop.

Offered by [Ron](#).

I have grown several types of tomatoes, and it seems I always get much better yield per plant when I have several rather than when I just have one.

Offered by [Martha](#).

Plants will literally kill themselves trying to out-produce their neighbors if they are a little crowded. Competition for resources and the need to reproduce. Of course this kind of competition isn't dependent on their neighbors being of the same species. Inter-planting with other varieties of plants produces the same general competition. Primarily, beating moves the plants, but one should take care not to damage the plants. Tomatoes are self-pollinating and like beans or peas, they need movement to dislodge the pollen. If your plants are too healthy (as represented by excessive foliage) you should really trim them up some. This sudden reduction in foliage will cause them to panic and bear fruit for self preservation.

Offered by [Roger](#).



# Troubled Times

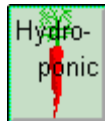

## Aeroponics

---

*[Aeroponics](#) International's patented Genesis Series II Growing Systems Aeroponic Technology provides plants with an enclosed air and water/nutrient ecosystem, that stimulates rapid plant growth, without soil or media.*



# Troubled Times



## Space Station

---

*The New York Times*, May 19, 1998

### **Space Crops for Astronauts**

Hydroponically grown crops will be almost the entire source of ingredients for the foods astronauts will consume on remote space stations in decades to come. The list of crops, which must supply nearly all the astronauts' protein as well as vitamins, minerals, fiber and culinary variety, includes plants well-adapted to growing in nutrient-enriched water and short enough to fit in the troughs that will be available in space.

- Wheat
- Potatoes
- Sweet potatoes
- Soybeans
- Peanuts
- Common beans (kidney, lentils, etc.)
- Rice
- Chard
- Quinoa
- Lettuce
- Tomatoes
- Cucumbers
- Garden peas
- Green beans
- Mushrooms
- Carrots
- Kale
- Broccoli
- Spinach
- Beets
- Bell peppers
- Chili peppers
- Watercress
- Onions
- Scallions
- Garlic
- Strawberries
- Melons
- Green herbs





# Troubled Times



## TEAM: Hydroponics

---

A Troubled Time TEAM has been formed to share practical tips on home hydroponics. Early reports, concerns, and ideas are:

- [Success & Failure](#)
- [PVC Pipe](#)
- [Nutrients](#)
- [pH Balance](#)
- [Alaska Hydrosled](#)
- [Teeter Totter](#)
- [Q&A](#)

For information on developing TEAM activities, contact [Clipper](#), [Roger](#), or [Steve](#).

# Troubled Times

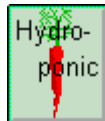

## pH Balance

---

Damark has a **Chlorine and pH Electro-Tester** Item No. B-40070-426137 on sale for \$29.99 was \$39.99, typical price is about \$59.95. Call 1-800-729-9000 to order. Was in the just released Jul 97 catalog. Uses one AA battery. Is a white hand held meter with a two terminal probe for the water. Could be useful with hydroponics and gardening in general for pH measurements. For after PS I suspect it to be cheaper in the long run and to last longer and be more accurate than stockpiling pool test kits and or pH paper. One or more rechargeable AA batteries could be recharged from a 12V DC system with a simple limiting resistor.

I was able to find a simple pH meter with no batteries. Found it at a large Armstrong Garden Centers, Inc. Manufacture is **Rapitest** distributed by Luster Leaf Products, Inc. 2220 Techcourt, Woodstock, Il. 60098. Cost was \$19.99 before tax. Has one probe that is stuck into the wet soil that is made with two different types of metals insulated apart to make two separate electrodes. The acid or base of the soil makes a battery that moves a meter needle away from pH 7 (no flow or zero point) to Alkaline (positive flow) or Acid (negative flow). The pH scale runs from 3.5 to 9.

The instructions for use are a bit complicated and include shining or removing the oxide from the probe before each use. Under tips on testing it says - **Use the Meter Only in Soil. Do Not Place the Probe into Water.** Don't see any good reason for this statement, unless if you let it sit in water for a while, water may seep past the plastic seal between the two electrodes and possibly short to some extent the electrodes from the inside out, decreasing it's sensitivity.

Offered by [Mike](#).



# Troubled Times



## Growing Guide

Plant Type	Temp	Light	NPK Mix	Plants Per Sq. Ft.	pH	Growing Conditions	Vitamins Delivered
Artichoke	19-27 C	not directly under	1:02:02	1	6.5- 7.5	perlite 10 inches or deeper	high food value
Banana	27-29 C	fantastic light	12:01:16	0.5	5.5-6.5	perlite at least 16" deep w/ very high humidity	
Beans	15-18 C	needs good light	2:04:04	5	6	4 inches deep or deeper w/ plenty of moisture	protein, Vitamins A, B, C
Broccoli	13-18 C	needs good light	3:03:01	2	6-6.8	NFT - cut 5" from top and will continue to come	Vitamins A & C
Cabbage	13 C+	needs good light	3:03:01	2	6.5-7	2.5" deep or deeper (NFT works)	Vitamins A & C
Cauliflower	15-20 C	needs good light	3:03:01	1	6.5-7	2.5" deep or deeper (NFT works)	
Carrots	15-30 C	moderate light	1:03:03	2	6.3	30% vermiculite and 70% perlite - good drainage required	iron, Vitamins A, B1, B2, C
Corn	15-20 C	needs great light	10:03:05	3	6	6" deep or deeper w/ great drainage	carbohydrates and protein
Cucumber	24-30 C	good light	10:03:10	2	5.5	4 to 6" deep or deeper	little food value
Garlic	27 then 15 C	good light	15:03:16	3	6	4" deep or deeper - sand w/ high initial temp cooling off	illness prevention
Lettuce	12-20 C	moderate light	9:01:16	6	6-7	grow w/ rockwool sitting on styrofoam in water	little food value / roughage
Onion	15-27 C	good light	15:03:16	3	6-7	4 inches or deeper within aggregate or sand/ perlite/ vermiculite mix	not particularly high in energy or vitamins
Peas	15-18 C	good light	8:01:05	4	6-7	4" deep or deeper in aggregate or rockwool w/ good aeration	
Potatoe	60-70 F	fair light	7:01:09	3	5-6	12" deep or deeper 2/ good drainage - tubers not exposed to light	2.2% protein, .1% fat, 1% potassium
Pumpkin	20-27 C	good light	10:03:10	1	5.5-7.5	rockwool or perlite sow seed direct - need trellis big time	great Vitamin A, fair Vitamin C
Soybeans	15-18 C	good light	2:04:04	5	6	NFT culture	protein, iron, B Vitamins, calcium, zinc
Spinach	15-19 C	cool shaded	10:04:12	3	6-7	4" deep or deeper using rockwool or sane or perlite	excellent Vitamin A, C, Fair B, high fiber
Strawberry	15-18 C	good light	5:10:05	6	6	troughs filled with gravel/perlite or granulated rockwool 6 to 8" deep	Vitamin C
Tomatoe	21-24 C	great light	5:07:01	3	6-6.5	rockwool w/ trellis or something to hold them up	excellent Vitamin A and C
Wheat	60-70 F	good light	10:01:04	8	6	silt and clay loams outside; humus; significant moisture but not flooding	fiber 14%, protein (gluten) 12%, 2% fat, several minerals
Zucchini	24-30 C	good light	10:03:10	0.5	6	aggregate culture w/ constant supply of moisture	

Offered by [John](#).





Helping you grow and bloom

Find your local retailer

Home | About Us | Sign in | Contact us

- Aquaponics
- Kits & Systems
- Growing Media
- Lighting
- Plant Feeds & Boosters
- Air Control
- Pumps
- Disease & Insect Control
- Propagation
- Irrigation Fittings
- Books
- Organic Products
- Environmental

Find it

You are here [Home](#)

**We only wholesale**  
click here to find your nearest retailer

## Welcome to HydroGarden

Hydroponic systems and plant grow lights are the gardening tools for the 21st century. They make gardening a year round hobby and mean you can grow any plant, any time, any where! After you have browsed our site, we hope you will try this safe, fun, educational and productive form of gardening. Please ask your specialist hydroponic retailer for any advice relating to the products contained within this site.

► Find your nearest hydroponics retailer

Use our retailer locator to find your nearest store.

► Become a hydroponics retailer

Would you like to open your own hydroponics store?

► What is hydroponics?

Find out about hydroponic growing systems.

► **Outside the UK?** For wholesale enquiries outside of the United Kingdom, please call Export Sales on +44 (0)24 7660 8072



**FishPlant Aquaponic Systems & Accessories**  
Grow it, eat it, love it. Raise fish and grow plants in the FishPlant enclosed ecosystem to eat or to enjoy, the choice is yours. **All you need to do is add fish food!**

[CLICK HERE TO VISIT THE FISHPLANT WEBSITE](#)

- Company**
- Home
  - About Us
  - Contact Us
  - Feedback
  - What is Hydroponics

- Business**
- Privacy & Security
  - Are you a Commercial Grower?
  - Apply for a HydroGarden Account
  - Testimonials - What our Customers Say

- Help**
- Request a HydroGardening Brochure
  - Where can I buy HydroGarden Products?
  - FAQs



Helping you grow and bloom  
© 2011 HydroGarden Ltd.



SEARCH

**Growing Tools**

- ▶ Feeding Schedule
- ▶ System Instructions
- ▶ FAQs

**SPRING IS COMING!**

**GO LARGE!**

**NOW AVAILABLE IN 15 GALLON SIZES!**

**GENERAL ORGANICS**



**Learning Center**

- ▶ Azamax
- ▶ Grorox
- ▶ Coco Baskets



**Featured Products**

Check out the latest and greatest

- ▶ GH iPhone App
- ▶ RapidStart - Rooting Enhancer
- ▶ CALIMAGic - Ca Mg



**GH Blog**

Discover the GH Blog and enhance your growing experience

- GH Events
- Cutting Edge Research
- New Product Info



Download our Product Catalog

▶ View All Products



**Get Social with Gen Hydro!**

- ▶ Facebook Page
- ▶ Twitter Feed
- ▶ YouTube Channel



**Store Locator**

Find a store that carries GH products near you.





Call Us Toll- Free  
(800)321-5656  
M-F 8-5 EST

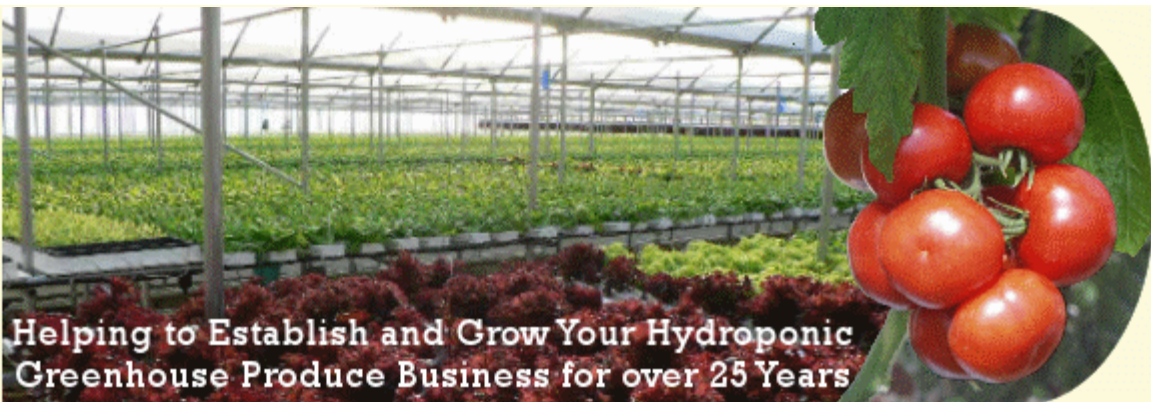

Helping to Establish and Grow Your Hydroponic Greenhouse Produce Business for over 25 Years

Shop Online

Commercial Hydroponic Systems

Greenhouse e Frames

Two Day Workshop

Hobby Systems

Company Information

Additional Information

Catalog

Request Info

Employment Opportunities

Contact Us

Leaf/Water Analysis

Site Map

### Search

Search this site:

Now Available from CropKing



For More Information [Click Here](#)

## Commercial NFT Lettuce and Herb Greenhouse System



### ● Hydroponic [NFT Lettuce and Herb](#)

Greenhouse Systems allow you to grow Bibb, Roi and Leaf lettuce. The NFT system can also be used for herbs like basil. Systems are available from a 30' x 12' greenhouse to multiple gutter connected bays. We can provide retrofit packages to fit an existing greenhouse

### ● [Small Commercial System](#) gives you a great

starter system that allows you to grow 540 small leaf plants. The 10-36 NFT Small Leaf Crop System is 10' x 26' long.

## Hydroponic Vine Crop Greenhouse Systems

### ● Hydroponic Bato [Bucket Vine Crop](#)

Greenhouse Systems allow you to grow Tomatoes in Bato Buckets filled with Perlite. The Bato Bucket System can also be used for Cucumbers, Peppers and Eggplant. The Hydroponic Nutrient Injector System



used to fertilize each Bato Bucket. Systems are available from a 30' x 128' greenhouse to a multiple gutter connected bays. We can also provide retrofit packages to fit an existing greenhouse.

### Forage, MicroGreen & WheatGrass Systems



- [MicroGreen and WheatGrass](#) Growing Systems are for growing high value miniature greens used as garnish and salad toppings.
- GrazeGreen Livestock [Forage Systems](#) are a hydroponic answer to high hay and forage prices. Grow forage for your farm animals 365 days a year with our controlled system.
- CropKing's [Microgreens One Rack](#) is on display with microgreens, wheatgrass, popcorn and sunflower

### Greenhouses, Coldframes and Retrofit Systems



- [Greenhouses](#) and Coldframes manufactured by CropKing.
- Our [online configurator](#) will quote a complete greenhouse system to match your needs for all of our ground to ground greenhouses.
- [Retrofit](#) Hydroponic Systems can be added to your existing greenhouse.

### Growers Workshops and Training

- Our highly regarded [Growers Workshops](#) train growers on the technical side of growing with hands-on experience. Workshops are scheduled all over the US using CropKing's growing techniques.
- CropKing's Introductory [Free Video](#) gives a brief foundation to the different greenhouse structures and systems that CropKing has to offer. This video describes different growing systems and crops that are successfully grown in our hydroponic greenhouses.
- [Business Plan Template](#) can help you create a business plan package to compare various business costs and returns.





and contains the information your banker wants to see in order to find financing for your new business.

### Cropking's Research Greenhouse



- Click to View [Research Greenhouse](#)
- [Sanctuary](#) Hobby Greenhouses

filed in section: [Hydroponic Growing Systems](#)

[Home](#) | [Commercial Store](#) | [Carefree Garden](#) | [Information](#) | [Free video](#) | [NFT Growing System](#)  
[Dutch Bucket Growing System](#) | [Commercial](#) | [Small Scale Growing](#) | [Company Info](#) | [Email us](#)

#### **CropKing Inc.**

#### **Our Facility is located at:**

134 West Drive, Lodi, Ohio 44254 USA phone: (330) 302-4203  
fax: (330) 302-4204

Contact our [webmaster](#)

Copyright © 1995-2011 All Rights Reserved

# Troubled Times

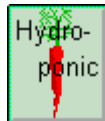

## E-Zine

---

The CropKing newsletter includes information on conferences, books, new products, classes, and more. Just subscribe to **CropKing** [Ezine Account](#).



hydroponics.com

Contact us | News | Nutrient | Gardens | Hardware | Hydroponics Shops | How-to Information

- News Section:
- [Homegrown Hydroponic Expo](#)
- [New Homegrown Location](#)
- [Under New Management Barrie, Ontario](#)
- New Articles:
- [Backyard Hydroponics](#)
- [Odour Removal](#)
- [Orchids: Easy and Rewarding](#)
- News Article:
- [Better World Versus Scott's Miracle-Gro](#)

hydroponics **hy'dro-pon'ics**. *adj.* cultivation of plants in nutrient solution rather than in soil.

hydroponics.com **hy'dro-pon'ics dot com**. An informative, educational website designed to help you learn everything you need to know about hydroponics and direct you to the best products possible to meet your hydroponic growing needs.

**Did you see us in Toronto Botanical Garden's *Trellis* magazine for members?**

[Click here to get your free \\$10.00 gift card.](#)

**New Homegrown Location in Oakville**

**They're Growing to serve you Better!**

**Take a Peek**

Check out our new colour catalogue with great info and great prices. Order on-line, by phone or in-store.

**Catalogue pdf**

[Hydroponic Promotions](#)  
[New Hydroponic Products](#)



Advertisers





## Hydroponic Promotions

Selected lamp types on sale, starting at \$20 up to 75%\* off!

\*Contact our [Toronto Airport](#) location for details.

1-800-INFO GRO

or

[email\\_us](#)



[DNF224](#)  
[Enhance 500ml](#)  
[\\*special price\\*](#)

[LMP639](#)  
[LED Grow Panel 45](#)  
[\\$139.95](#)

[PUB003/PUB005/  
PUB007/PUB009](#)  
[Gardening Indoors](#)  
[Book Series:](#)  
[Gardening Indoors](#)

[LGT101](#)  
[Sun System HPS 150w](#)  
[bulb included](#)  
[\\$125.00](#)

\$29.75  
(All sizes are on special)

with CO2/Cuttings  
/HID/Rockwool  
\$8.99 each

## New Hydroponic Products



HRD037  
Tie Boss 1/4" Pulley  
\$19.95

DNF240  
DNF Hydro Sparkle  
starting at \$19.95

MIS067  
Universal Dry  
Net  
\$59.99

INS038  
Knockdown Spider  
Mite Spray  
\$19.98

[Search this site](#) powered by [FreeFind](#)

[Home](#) | [Contact us](#) | [News](#) | [Nutrient](#) | [Gardens](#) | [Hardware](#) | [Hydroponics Shops](#) | [How-to Information](#)

[Advertise with us](#)/[Questions and feedback](#)/[Grow and Bloom](#)

[Formulas/Black/Clear/Gold/Green/Bio Stimulants/Fortifiers/Organics/Mix Your Own/pH Adjustment/Additives/Carbohydrate Additive/Garden Techniques/Growing Media/Growing Hydroponic Lettuce/Growing Tomatoes/Growing Cucumbers/Growing Peppers/Growing Herbs/Pest Control/Rooftop Patios/Closet Gardens/Hydroponic Lighting/Hydroponic Fans/Hydroponic Testers/Hydroponic Timers/Hydroponic Pumps/Hydroponic Tables and Reservoirs/Hydroponic Reflective Materials/Hydroponic Tubing and Fittings/Hydroponic Odour Control/Hydroponic Water Filtration/Hydroponic Miscellaneous/Buy Hydroponic Equipment Now/Hydroponic USA Locations/Hydroponic Canadian Locations/Hydroponic Books/Hydroponic Articles/Educational Hydroponic Information](#)

# Simply HYDROPONICS and Organics



Home

Hydro University

Online Shopping

View Cart

Articles

FAQs

Destroying the Myths

About Us

Employment

Site Map

Contact Us



Simply Hydroponics and Organics  
on Facebook

twitter  
Follow us on Twitter  
Click Here!

## WELCOME TO SIMPLY HYDROPONICS and ORGANICS

*"We Sell Green Thumbs"*

Since 1992

**New Store Location!**

*Orlando store now open!*

*1019 W. Fairbanks Ave, Winter Park, FL 32789*

### CHECK OUT OUR NEW STATE-OF-THE-ART SHOPPING CART!!!



- ✓ THE BEST SELECTION AND PRICES!!!
- ✓ THE MOST SECURE CHECKOUT FOR YOUR SAFETY AND PRIVACY!!!
- ✓ EASY, EFFICIENT NAVIGATION!!!

With the help of our interactive website and knowledgeable staff, you will find that there is no such thing as a brown thumb. **Anyone** can grow the finest quality produce, herbs, flowers and other ornamentals even if they've never done so before. Whether you garden hydroponically or organically, we will guide you each step of the way to agricultural success through any and all of our learning resources. If your fortunate enough to live close to one of our retail stores, stop by and talk with the most knowledgeable and helpful staff in the industry. If not, utilize our online resources. Take a course at the

[Hydroponic University](#), find plans for designing and creating your own systems and grow chambers, get quick answers in our FAQ section or email a question to Ask the Professor. If you still don't find what you're looking for, feel free to call one of our store locations and allow us to show you why we are famous for outstanding customer service. Beyond information and support, we offer the most extensive inventory of organic, hydroponic and just plain unique gardening items you are likely to find anywhere. Just click our [online catalog](#) and let your shopping adventure begin. We're glad you are here and we will do our best to insure that Simply Hydroponics meets all your product and information needs.



*Proud to be  
selected as West  
Central  
Florida's only  
distributor of  
Canna products!*

### You Asked For It We Listened [Simply Hydroponics and Organics Blog](#)

*Simply Hydroponics and Organics is west coast Florida's oldest, largest and most trusted specialty gardening retailer. Specializing in outstanding customer service and vast information resources, come see for yourself why we are #1 in Florida.*

**BEST PRICES IN THE STATE!!!**

[Rid your produce of E.Coli.](#)

Thanks to all our sponsors who helped make our Winter Park Grand Opening such a great success by contributing collectively to our awesome grow room drawing as well as bringing lots of goodies for give away's. Mostly we appreciate their presence and continued support. Mike from Sunlight Supply, Jeff from Technaflora, John from BWGS, Bill from Phresh Filters, Nathan from Biofloral, Evan from Back to the Roots and CANNA. We also want to say a big thank you to Erik Wigert for his awesome Bonsai demo and most important, all our customers, old and new who showed up and made the day such a success. Our most sincere thanks to all. Pics coming shortly.

**Congratulations to Rick, the winner of our grow room raffle!!! Happy Gardening!**

Spanish Spoken at all Store Locations.

Habla español en todas las ubicaciones de la tienda.

*We have two great ways to serve your gardening needs.*

Online!



*Welcome to Simply Hydroponics and Organics Online!*

#### HOME OF THE HYDROPONIC UNIVERSITY

*Simply Hydroponics and Organics Online* is working hard to supply you with the most complete hydroponic product catalog on the web.

We offer a huge line of top quality [Hydroponic Products](#) from around the world. We offer complete systems as well as a vast assortment of accessories like: Grow Lights, Hydroponic and Organic Nutrients, pH Controls and Testers, Growing Medium, Propagation Supplies, Pest Controls, Atmospheric Controllers and Test equipment.

We are constantly updating our catalog so if you don't see what you want, just ask. We can probably get it for you. [Product Request](#)

And have no fears. Our online ordering is secured with the most up to date security and encryption available.

[Click Here for Product Catalog](#)



Our Stores:

#### Pinellas County

7949 Ulmerton Rd. (SR688)  
Largo, Florida. 33771  
727-531-5355

[GET MAP](#) [MORE INFO & STORE HOURS](#)

#### Pasco County

15036 US 19,  
Hudson, FL 34667  
727-819-2655

[GET MAP](#) [MORE INFO & STORE HOURS](#)

#### Orange County - Coming Oct 1st

1019 W. Fairbanks Ave,  
Winter Park, FL 32789  
321-972-1844

[GET MAP](#) [MORE INFO & STORE HOURS](#)

### Hydroponic University

On these pages, we strive to get you all the gardening information you could ever possibly need. At [Hydro-U](#) you can take a "[Mini-Class](#)" (don't worry there isn't any homework or tests) to learn about various aspects of gardening in general and hydroponics in particular.

[What is Hydroponics](#) gives a basic explanation of hydroponics and diagrams the basic types of hydroponic systems. We have a Hydroponic F.A.Q. section called [Destroying the Myths](#).

We also offer a [Tip Of The Week](#) and a section entitled: [Ask The Professor](#) where you can view questions asked by others or pose your unique question to the Professor. We also offer several [FREE SYSTEM PLANS](#) that you can use to build simple yet effective hydroponic systems out of easy to find inexpensive materials.

"NEW" Simply's Most [Commonly Asked Questions & Answers](#).

"NEW" [Simply Glossary](#) gives definitions to gardening lingo/language.

[CLICK HERE](#) to be added to our mailing list. This FREE service will enable you to get the Professor's Weekly tip sent directly to your in-box.

[Click Here for Hydroponic University](#)

[HOME](#) | [ONLINE SHOPPING](#) | [PRODUCTS](#) | [HYDRO-U](#) | [FAQS](#) | [ABOUT](#) | [CONTACT](#)  
[SITE MAP](#)

Simply Hydro. Copyright 2008. All Rights Reserved.  
[Florida website redesign by Digital Eel, Inc.](#)

# Troubled Times



## Depleted

---

The history books tell of settlers moving on to new ground every 2-5 years because the soil played out and the family was getting sick and weak. It's been this way since 1936, Senate Document No. 264, warned Americans that the soils used to grow fruits and vegetables were seriously deficient in needed minerals. Most of us will not be moving into our survival site until the last year. Trying to find good soil will be a problem. When I buy the best organic soil I can find at about \$7/bag only to find out it has been farmed out of trace minerals with lots of sawdust dumped in. Plant growth in this soil observed to be not healthy. I become concerned. Most of the soil in the US is in this or worse poor condition. In addition any given plot of soil can have pesticides and other toxins in it. The majority of us are all green at this. Then to top it off we need to get maximum yield / square ft with little to no light.

Offered by [Mike](#).

I have heard that something like 90% of the essential nutritional minerals in the soils of our ancestors are not there in our agricultural soil today. I have pondered for years over how best to replenish soil that is short of essential minerals. There is evidence that those peoples who are the most long-lived happen to live and grow their vegetables in high mineral soils. Alluvial soils and soils that were recently glacier beds are good examples. Some companies are even promoting something called "glacial milk," if I recall correctly, which is derived from such soil. I wonder if there is a way of amending soil with appropriate volumes of these essential minerals, in the manner we add compost, etc. Imagine taking a dump truck to a moraine or old riverbed (established as being a good mineral/non pollutant source) and scooping up a load. Any ideas on the best way to do this? What would be the best sites throughout different regions?

Offered by [Granville](#).

I can attest to the success of a garden plot that is over 20 years old that has never displayed any signs of mineral depletion. However I understand that there are areas of the US and other countries where the soil has been farmed out and is very deficient in vital minerals. Vitamin B-12 is an example of a mineral dependent life building block. Without Cobalt and the bacteria that convert it into Vitamin B-12, there is none of this vitamin. If cobalt is present in the subsoil and the underlying strata of rock, then it will become available to the bacteria that convert it into B-12 by natural means. These natural means take time, a lot of time. We may need a quicker fix. But if you follow the methods of your ancestors and consider replenishing that which is missing (get a soil test!) and rotate your crops and return *all* of your waste to the soil, you will not have to worry so much about deficiencies.

Offered by [Roger](#).





# Troubled Times



## Trace Minerals

---

In a raw, elemental form, very little minerals are absorbed into the human intestinal tract (less than 10%). The *chelated* form of minerals delivers about 90%. When minerals are absorbed and embedded within the molecular structure of plants (chelated), they are treated differently by the body than the raw mineral state. In a chelated form, minerals are much more bio-active and therefore more useful to the body. German physician/scientist Hans Neiper worked all this out over 30 years ago.

Offered by [Ed](#)

For the most part it shouldn't take any great quantity. What I visualize is something like grinding up a mineral pill adding it to rest of our nutrients for our plants. That's why it might be worth while to check out the mineral tablets that are put in cattle's and other animals feed. Before or after the pole shift, if one can find some near by old plant deposits - petrified wood, clay of this type, or shell, etc. - if one broke it up and pounded it until it is a fine powder it would make a good supplement for growing plants.

The best trace organic mineral supplements to day are made from old volcanic covered up plant life - ether ground up petrified rock or nearly petrified. The following quote is from a site called **Trace Elements: Missing Links**. Rock dust trace minerals feeds bacteria feeds plants.

*Dr. Earp-Thomas used bacteria from rotting rock to stabilize his trace element solution. In Nature, it's bacteria that dissolve rock to digest minerals into living protoplasm. These evolutionary pioneers create food and habitat for other lifeforms - especially plants. One example: lichen encrusting boulders are a partnership - a symbiosis - of bacteria and algae. Bacteria eat rock to feed algae minerals; algae fix sunlight as six-carbon rings called sugar to feed bacteria.*

So plants depend on bacteria to digest and supply minerals packaged as protoplasm. Dr. Earp-Thomas also pioneered using bacteria to inoculate legumes. Rhizobia bacteria live in pink nodules on legume roots. Rhizobia don't eat rock, but use a trace element - molybdenum - to fix the element nitrogen from air into nitrates, which legumes make into proteins.

Offered by [Mike](#).



# Troubled Times



## Not Farmland

---

While selecting the survival site, make sure it is not farmland. Ranch land would be less likely to have been depleted (unless it is ranch land because it is so depleted that nothing else will grow there). Ranch land around here is used this way because there are too many rocks in the field to farm it. If you are scouting a site, take a shovel and get a sample of the soil in the area. Do this by digging holes about 6 inches wide and 6 to 9 inches deep in several places. Slice a thin wedge of soil from the wall of each hole and carefully remove sod and any small stones or roots. Be sure to wear gloves so you don't affect the chemistry by your bare hands. Mix all your samples together in a plastic bucket or bag. If the soil sample is badly deficient, consider a different site.

Offered by [Roger](#).



# Troubled Times



## Woods Soil

---

Find a stand of old growth trees in or near the survival site. By old growth I mean 50+ years old. Obtain some soil from in and around this grove of trees. Plan to obtain firewood from this grove of trees as well. Acquire some river bottom top soil as well. Now you will not be assured of having all the trace elements needed, but you can be sure that this combination of soil is not from commercial farmland. If the trees are of sufficient age, then you can be fairly certain that they have stored a large supply of the trace elements you seek. If they grow along a creek or river bed, then the land they grow on was not likely farmland at any time in the past.

Cutting a few of these trees for firewood will provide you with wood ashes that are mineral rich to use in your fertilizer. As far as how mineral rich, is there a chemist among us that can provide information about which minerals are likely to combine with oxygen and escape in gaseous form? My recollection is that primarily carbon and sulfur oxidize and escape in a slow (low heat) fire. Metals (like iron, manganese, selenium, etc.) need a 'really' hot fire to combine and escape as a gas. I'm considering that a slow cooking fire (you know, the coals) and a banked heating fire (the ole' pot-bellied stove) have very little smoke and mostly radiate heat while recombining their elements into 'ashes.'

An old stand of trees is likely to have not been farmed and if it is near a creek or river, then it has probably never been farmed! Also, near a creek or river, you have the added component of soil erosion and runoff. Don't fear the likelihood of chemical runoff, as most of this is in the creek or river itself and the top 8 or 10 inches of soil has already leached out the chemicals. The top several (8 to 10) inches of soil near the bank of a river is safe to use as a source of nutrient-rich soil. There is information about soil leaching available, and the **University of Minnesota** has a more in-depth explanation about soil leaching properties (though the tables may be helpful, they are for Minnesota). My personal experience is that soil on a river bank has a high amount of sandy silt. Soil of this nature would be considered medium to high permeability.

Offered by [Roger](#).



# Troubled Times



## Soil Test

---

Perform a soil texture test. This is done by filling a quart jar half-way with water. Add soil until the jar is nearly full. Put on the lid and shake until well combined. Set the jar aside and wait until the soil settles (from a couple of hours to a day). Clay will be on top, silt in the middle and sand on the bottom. Measure the thickness of each level and divide each thickness by the total thickness of the layers. This will give you a percentage. If the soil is less than 25% silt or more than 25% clay, you need to add 2 or 3 inches plant matter like compost, humus, or manure. If you have more than 30% sand, you need to add twice as much plant matter.

Next you should purchase a soil test kit. These are available at your local garden center, but unfortunately they only test for NPK and pH levels. Try the agricultural dept. or geology department at your local college or university. If they are not able to do the test for you, then they should be able to provide you with a source for a test kit. Be sure to tell them you want to test for trace elements.

Offered by [Roger](#).



# Troubled Times



## Essential

---

You need Nitrogen (N), Phosphates (P) and Potassium (K). So how do you get all these things for good soil when the store isn't available?

### **Nitrogen**

manure, plants, animal tissue, soil rotation. Beans replenish Nitrogen and wheat and corn take it away

### **Phosphates**

animal bone remains, plant remains (vegetable mold)

### **Potassium**

potash (this is a lot tougher but absolutely essential). Run water slowly through the ashes of burned wood and boiling down the solution in large kettles. The residue, a white solid is called potash because it was made from ashes in pots. The potash obtained from leaching can be used to prepare soap as well. Potassium is never found by itself, but it can be prepared from the mineral sylvite found principally in New Mexico. Some nitrates containing saltpeter also contain potassium. For those of you who didn't think you needed wood, you do.

Offered by [John](#).



# Troubled Times



## Deficiencies

---

There are definitive ways of determining nutrient element deficiencies. There are 16 known elements necessary for plant growth (13 of those come from the soil). Six are designated 'macro' elements-needed in large concentrations and seven are 'micro' elements needed in small concentrations. Under various conditions, some of the macro elements might be deficient; however, in many soil conditions the micro elements are usually not. You can create some deficiencies in some by overapplications of others so 'tinkering' with applications without knowing what you are doing is not a good idea.

**Charles Marr**

Kansas State University

*Hunger Signs in Crops*, a symposium, prepared by Firman E. Bear et al, published by American Society of Agronomy and National Fertilizer Association, 1949. Describes deficiency diseases in plants and plant nutrition.



# Troubled Times



## Volcanic Dust

---

Way back in elementary school I remember learning about "the great circle of life" where I was taught that tons of organisms, from algae to alligators, are involved in keeping an ecosystem functional. I got to thinking: for years after the shift we are going to need resources that will be replenishing and ever lasting and ample. Power, and I mean a lot of it, will be necessary because of low sunlight and lack of the "grid." Can the soot that will constantly fall from the atmosphere be used? Is sulfur a mineral used in hydroponics?

Offered by [Ted](#).

Soot is ash (read potash). The key is the pH of the soot which would be severely affected by the other minerals and contaminants.

Offered by [John](#).



# Troubled Times



## Acid Rain

---

The following quote is from a site called **Regenerating Appalacian Forests** and it talks about acid rains effects on trace minerals, something we should take into account as the water many will use will come from the rain - if it is more acid with more heavy metals after the pole shift then we may need to take this advice.

*In the 1970s, on remote mountain peaks of the southern Appalachians, many trees began to wither and die. Through the 1980s, this death of trees spread rapidly to become a sylvan holocaust as mountaintops became bald with skeletons of dead and dying trees. By 1988 the "ring of death" on 6684 foot Mt. Mitchell (highest eastern peak) had descended to 5100 feet ...*

*My colleagues who are soil chemists and physicists have looked looked at these soils in our permanent plots, particularly in high elevation forests, and found -- almost without exception - they are very poorly buffered. This means they can't absorb acids very well, and are very susceptible to leaching of trace elements, particularly magnesium and calcium, which react with acids in the soil. And because of high organic matter contents, they're very susceptible to holding heavy metals, such as aluminum, lead, zinc, copper, cadmium, in soil matrices.*

*Our analyses found nitrogen, phosphorus and potassium weren't lacking in these soils. In fact, in many cases they were abundant. On the other hand, when we looked at many trace elements, particularly those susceptible to being bound or leached by acids, we found - as in Europe - quite a depletion. We learned our cue from Europeans regarding application of trace minerals. They're applying dolomite/limestone on their forests. From experimental fields I've seen in the Black Forest and other areas, they've had remarkable recoveries from air pollution effects by application of mineral slurries and/or dusts.*

Offered by [Mike](#).





# Troubled Times



## Fertilizer

---

N is nitrogen, P is Phosphorus and K is potassium.

Offered by [Jeroen](#).

Don't depend on commercially produced fertilizers. Unless you can afford to stock up on 20 years worth of the stuff, you are going to run out, and then what? We need to find other, naturally occurring sources for the vital nutrients we must replenish in our gardens.

Offered by [Roger](#).



# Troubled Times



## Azomite

I found something that might be of interest, [Azomite](#) is sold nationwide. The main proprietor is a company called Peak-Minerals located in Missouri. Here's some info on azomite.

### A Source of Minerals & Trace Elements

Azomite is the name of a special rock in Utah. Early this century geological prospector Rollin Anderson found deposits of montmorillonite clay in a valley south of Salt Lake City. U.S. Bureau of Mines analysis showed the clay is similar to Chilean/Peruvian caliche rocks from which much of the world's nitrate was mined. Anderson ground montmorillonite as fine as possible, then put it in his garden. Results were amazing and nearly immediate. Minerals in Azomite are necessary to optimal metabolism in living things. Ground to dust, minerals are small enough to pass through cell walls of organisms.

Azomite is natural mined rock from a specific volcanic deposit in central Utah marketed as a free-flowing, less than 200 mesh, tan to pink powder with a density of 48 lbs./cubic foot. Shipped in bulk (\$350/ton) or 40 lb. paper sacks (\$19). No additives, synthetics or fillers. Mineralogically, Azomite is rhyolitic tuff breccia. Chemically, it's hydrated sodium calcium aluminosilicate. U.S. Code of Federal Regulations (21 CFR 582.2729) lists it as "anti-caking agent." It's "generally recognized as safe" (GRAS) by FDA for feeds up to 2% by weight. Odorless, insoluble (1%). Azomite has 67 major and trace elements, so its name means "A to Z Of Minerals Including Trace Elements." Typical analysis shows every element that's beneficial to plants and animals, and other elements (micro-nutrients) scientists believe essential. Any contaminants are within American Feed Control Officials guidelines.

Azomite was mined since 1942 as soil amendment and livestock feed additive. Cattlemen report faster weight gain, improved feed efficiency, upgraded meat quality, greater disease resistance, reduced mortality. Dairywomen report increased milk, higher butterfat. Poultry producers report enhanced egg fertility and shell quality. Crop farmers report improved growth, health, size. Potatoes report 19-60% increase in yield; sugar beets are larger, with higher sugar content. Citrus growers report improved recovery from decline, healthier trees. In 1988 Peak Minerals, Inc. acquired the deposit and initiated accredited research in Colorado, Utah, Florida, and Georgia. Studies in broiler chicken, mycotoxin, citrus, and crops indicate benefits and are available by request. Currently approved for organic farming in California, Colorado, Oregon, and Washington. Research recommends 300-600 lbs./acre broadcast, or 2 lbs./10 sq. ft in gardens. Users are testing row and foliar application.

Offered by [Pat](#).

It seems to be an expensive way (a \$19 bag treats 200 sq. feet for one season?) to add elements and their ones we're concerned about occur only in trace amounts. I believe the increase in yields and growth that the site are primarily from the potassium and calcium (mineralogically speaking).

Offered by [Roger](#).



# Troubled Times



## Blood and Bone

---

Blood and bone meal work very well, but they do not supply potash. Add wood ashes to your mix or gypsum pellets. I posted my fertilizer mix previously, but in case anyone missed it here it is again:

- one and a third pounds of Blood meal
- two and a half pounds of Bone meal
- four pounds of wood ashes (or gypsum)

This is to be spread over 100 square feet and mixed into the top one or two inches of dirt. This mix *is* organic and will *not* burn plants so it could conceivably be spread around existing plants without fear of over saturating the soil.

Offered by [Roger](#).

How to get calcium and phosphate from bones. Take bones. Put them in bubbling vats of hydrochloric acid. Let the bone percolate for a week to remove calcium an phosphate minerals which can be used as feed and fertilizer. Soak in a murky lime solution for about 8 weeks, where it liquefies. Put the liquid through water tanks and filters transforming it into a syrupy state before it is cooled like Jello in the refrigerator. Male bones are better than female. Young is better than old. Long is better than short. Dry is better than wet. The above information is courtesy of Kodak of all people. This is an essential component for good film.

Offered by [John](#).



# Troubled Times



## Ashes

---

Trees may not grow well in the Aftertime, but there will still be trees to burn. A slow burning of wood (for heat and cooking) does not completely deplete the minerals in wood. The ashes from those trees will contain some (if not all) of those minerals we seek. That's why I use a fertilizer that is mostly wood ash.

It may not have selenium and other desirable trace elements, but there is a web site for an analysis of various wood ashes. Just select which variety of [Tree Ash](#), [Wheat/Straw Ash](#), or [Corn Stalk Ash](#). This is a fairly extensive analysis of many ashes. Sort of substantiates my claims of the nature of left over nutrients in ashes. The difficulty remains in acquiring a natural substitute for blood and bone meal.

Offered by [Roger](#).

After the pole shift, to burn wood to make ashes to make fertilizer may not be efficient. It oxidizes most of the trace minerals and they go up in the smoke. If one needs a fire and has the wood to burn then this is another story. For most of us I think precomposting the wood back to nutrients should be a more efficient way to retrieve the minerals.

Offered by [Mike](#).



# Troubled Times



## Sawdust

---

Sawdust for fertilizer is not a good idea. It pulls nutrients from the material it is in while it decomposes! Pre-composting is excellent - that's how they make cypress mulch and other wood based mulching materials. The key is to keep the material moist and feed it with nitrogen (by adding ammonia or urine). Nitrogen is the thing that rotting wood depletes the most. What might be a better use for raw wood (and woody plants) is to make alcohol. The byproduct could definitely be used in the compost and the alcohol could be burned in your gasoline powered generator!

Offered by [Roger](#).

I can see how this would be true for a while but in the long term it seems like what the young sawdust takith it will ultimately givith.

Offered by [Mike](#).



# Troubled Times



## Ground Rock

---

### Soil Remineralization: Renew Soil Life with Powdered Rock

Soils are dangerously deficit in minerals - especially trace elements - due to deforestation, acid rain and monocrop agriculture of annual plowing and doses of harsh, soluble chemicals. Fine ground rock was known for centuries to increase soil vitality - including bacteria, algae and earthworms. Nutrients missing in soil won't be in food grown that soil -and animals that feed on the plants. Rock provides not only chemical elements but elementary pattern and order, which are also food for biology.

I was looking around this site and discovered a story about how locally available (and free!) lave rock was used to remineralize completely farmed out land. Notice that the first step mentioned was a complete soil analysis. John J. Ruegg maintains his land with several different types of powdered lava rock. All of this is free to him and he uses a hand grinder to powder it himself.

Here is similar information from the government about remineralization. They give several examples of sources for remineralization. There are many other pages that talk about soil remineralization. Just click on the agenda link at the bottom of any of the above pages. The general idea is that remineralization is needed, but the sources can be easily attained. One such source could be the "local" rock quarry.

Offered by [Roger](#).



# Troubled Times



## Compost

---

I make my own compost from garden and kitchen waste as well as from grass clippings. Grab a handful and knead it and let it fall through my fingers. This can give some information about its consistency. If wet should be sticky and leave your fingers quite 'dirty.' If dry, it should stick together some, but be able to crumble through your fingers. Also pay attention to the nature of the material. If it seems woody or consists of a large amount of plant stems that have not yet decomposed, it is probably nitrogen deficient and will sap the nitrogen from your soil to complete its processing.

In the wild you can pick up some really good humus from the top couple of inches of the forest floor. If the area is well shaded (has a nearly full canopy from the trees), the ground will have been well covered by leaves last fall (or this fall depending on when you go out to collect). The ground will also have been enriched by the animals that live in or among the trees. You can also just plant buckwheat or clover, or even grass as thick as you can and in a month till (or in a container, churn the plants) under. The lush plant growth you get in a month will quickly decompose and add precious humus to your soil. This humus feeds the bacteria and earthworms in your garden and helps break down clay ("softens" the dirt so it won't clump together) and increases moisture retention.

Speaking of earthworms, go buy a dozen or two from the bait store and add 4 or 5 to each container. Also add them to your compost. These guys are the best at quickly breaking down rotting plant material (they eat a lot more than bacteria in a given period of time). Unfortunately they won't survive a cold winter if they can't get out of the compost bin and hibernate below the frost line. They also need moisture so don't let a bare container of dirt get dried out. If you get a good healthy family of worms going in a container, then you have readily available fish bait, just don't use them all! Not only do earthworms eat humus (decaying plant material) and thereby further break it down, they also aerate the soil by riddling it with their tunnels. This provides easy access to nitrogen for nitrogen-fixing bacteria. It also helps to loosen clay-rich soil so that plants can more easily grow their roots.

Offered by [Roger](#).



# Troubled Times



## Kelp

---

If I understand correctly, kelp is a seaweed, and the word is also applied to the ashes of burnt seaweed. In addition, kelp should be available in abundance after the shift, that is of course if we're located near a coastline. According to the Zetas, "the oceans will be lush." According to "The Seed-Starter's Handbook" by Nancy Bubel, kelp can:

- Increase crop yields
- Lengthen storage life of fruits and vegetables
- Improve seed germination
- Add frost-resistance to growing plants
- Improve resistance to insects and fungi

Over the centuries, the author says, kelp has been used to improve the soil in both Europe and Asia.

Offered by [Mike](#).





# Troubled Times



## Crop Rotation

---

Grow buckwheat or clover first, then add some compost and a mix of blood and bone meal along with wood ashes or gypsum. My garden is 5 beds. I shift the plants over to the next bed each year so as to not plant the same thing in a specific bed each year. For the container gardener this would mean the same thing - you planted potatoes in this container this year, plant lettuce or beans next year in this container!

Offered by [Roger](#).

Yes, growing clover after or before you put in your plants, is a very good idea, because inside the clover-roots, lives a bacteria, that can take the nitrogen out of the air and put it into the ground.

Offered by [Jeroen](#).



# Troubled Times



## Recycling

---

I think the best idea so far is to plan to compost all the plant waste and plan for a means to utilize human waste. If we acquire the needed minerals via multi-vitamins then any excess minerals we consume will be present in our waste material. Returning this to the soil will allow for rebuilding of lost minerals in that soil and when the vitamins run out, we won't need them anymore.

All life is dependent on these minerals, etc. and they are used throughout the entire organism. If you only consume a portion of the organism, then put the rest of it back into your soil. The minerals and such that are present in this remaining portion will then be decomposed and available for the next organism you grow from this soil.

Except for those areas where certain minerals and trace elements are not in natural occurrence, minerals and trace elements will naturally replenish themselves. This is done by erosion and breakdown of rock in the subsoil.

Offered by [Roger](#).

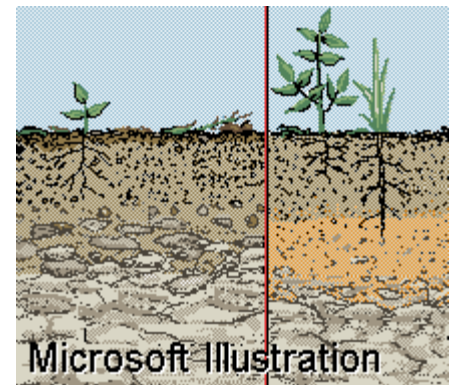

# Troubled Times



## Organic Sources

---

### Appropriate Technology Transfer for Rural Areas ([ATTRA](#))

P.O. Box 3657

Fayetteville, AR 72702

Phone: 1-800-346-9140

Fax: (501) 442-9842

Animal By-products

Bio-Dynamic Preparations

Composts/Manures/Blended Fertilizers

Compost Inoculants & Bioactivators

Cover Crop Seeds

Humates/Humic Acids

Hydrogen Peroxide

Hydroponic Fertilizers

Marine-Based Products

Microbial Inoculants/Enzymes/Biocatalysts/Conditioners

Micronutrients

Plant By-products

Rock Minerals—Phosphates

Rock Minerals&151Non-Phosphates

Worms for VermicompostSources Listed by State or Province



# Troubled Times



## Home Made

---

To build a sturdy rotating drum rock crusher, put some ribs inside the pipe parallel to the direction of the rotating shaft. Weld them on like a small version of a clothes dryer tub ribs. The size of the drum could be bigger if a pipe or cylindrical steel air tank is available. Actually the rotating drum could just as well be square or some other symmetrical shape. Add steel balls that fall and break up the rock. I think any chunk of iron would work. Big nuts and bolts or whatever. The idea is to cause the stuff to fall a distance every so often. Actually a old clothes dryer would work for a while. The drum might get beat up and worn out much more quickly than making your own before hand, however. An electric cement mixer would work better than a clothes dryer if one is available.

This type of rock crusher I believe to be a less efficient use of power than the professionally built ones as described by **Pennsylvania Crusher Co.** However, in a pinch would work. We must not forget the simplest rock crusher of all is the hammer or sledge hammer or the dropped heavy weight (rope over pulley). Screen the results and break up what is still too big to go through the screen.

Offered by [Mike](#).



# Troubled Times



## Manure

---

Farmers and gardeners have long used manure (cattle, chicken, etc.) to replenish depleted humus and fertility in soil. Manure is not a good idea unless you don't mind pulling weeds (and you will exponentially increase your weeds wherever you put the manure). But heavy application of mulch (6 to 8 inches) such as alfalfa hay (which is bailed before it goes to seed) will all but eliminate your weeds from use of readily available manure.

Offered by [Roger](#).

In bigger gardens, you can beat the weeds in an organic way, by laying out black woven plastic mats. This way the weed doesn't get the change of coming up. The mats have to be woven, because if you just lay out plastic, the soil can't breath and will go to rot.

Offered by [Jeroen](#).



# Troubled Times



## Composting Toilet

---

Human excrement and urine can safely be used from a composting toilet. It is a simple process to build your own [Composting Toilet](#). It is important to know that your own urine is *not* a waste product, it is in fact a sterile product that contains only the things you find in food, or nutrients your body processes but doesn't use up at the time. This is an important lesson as it may save your life post pole shift.

Offered by [Janar](#).

I suggest that you keep the manure separate, only hardy plants like tomatoes, jimson weed (motherwort), and mints can even tolerate such rich applications. It is best to compost human manure (human) with a composting toilet and compost pile, perhaps in combination with a worm bin (using moderate quantities of manure). Or better yet, set up an indoor toilet where your toilet seat and stall is set above a large tank (100+ gallons, depending on supply and usage) where the resulting manure can collect and be anaerobically digested (the bacteria in our intestines readily produce methane gas - that is why we fart - especially if you eat a varied diet with plenty of beans and vegetables). Have a standard gas line (1/2 inch copper tubing will do) with pressure gauge and valve/switch running to your gas stove, water heater, generator, gas refrigerator, etc.

Make sure you have some access to the tank, a sealed door on top or hatch, that will allow you to remove the byproduct of your efforts: A rich, dark powder ready to be mixed into soil or water for application. Be sure to vent or burn off the excess gas before you remove the stuff and wear some goggles and a mask, the smell may still be lingering, and have no flames or sparks present. You'll only have to do this sort of thing perhaps twice a year for a single family - if you expect more then have two tanks, one to keep you going while you empty the other. It is best to empty your tanks in late spring on a warm windy day. You may want to let the breeze into the home while emptying the tank. Perhaps you could situate the tank on the south side for maximum heat and anaerobic activity with access to the tank outside the house to avoid the above. Be sure to leave a little bit in the tank for residual bacteria to grow upon.

For a compost toilet, the anaerobic digester, to avoid the smell you must have two trap doors below your seat, both should be sealed and air tight. The order of business is this:

1. have a seat, hit the switch (or have a mechanism which will hit it for you upon sitting) that opens the upper door
2. next of course is do your thing, clean up, zip up, etc.
3. finally hit the switch for the bottom door, but only after the top door is closed.

The space between the two doors should be about 1 ft. where a large metal pipe about 10" diameter should be used. For those of you worrying about microorganisms and bacteria, etc., the bacteria are what make the methane, they are already in your guts. If you would like to accelerate the process find the appropriate bacteria (similar, if not the same, to the stuff you might use for clogs in the conventional septic system - bacteria ready to reproduce and go to work) and add them according to the level of poop you have in the tank. For any other microorganisms you may worry about don't worry about them because they are not fit to survive in the dark, hot, airless environment of the tank - not to mention the methane bacteria will eat them up. Even if you have just a few hundred cubic feet of gas in 250 cu ft. tank the heat will cause a significant pressure build up.

Be sure to drain off the excess gas, when its time to harvest the tank. You'll have a fine dark powder to mix with solid or compost. Make sure it is dry when you get it out. (Maybe you would like to have a window or a floating gauge to check when its nearly full.) Also try to avoid urinating in the tank. A cup of pee may do little harm to a pound of poop or the bacteria, but don't do it all the time or let it add up. Our waste is separate for a reason, use it accordingly.

Offered by [Steven](#).



# Troubled Times



## Human Manure

---

I can highly recommend *The Humanure Handbook* by Joseph Jenkins as a guide to composting human manure. It can be summarised by the bio-regenerative cycle:

Grow Food --> Eat Food --> Excrete --> Compost --> Grow Food --> . . .etc.

The heat of the bioreaction in the compost kills any pathogens and "is the missing link in the human nutrient recycling process", according to Jenkins. So our shite is not something we will be flushing down the toilet to pollute our drinking water in the future and will be fundamental in maintaining the health and productivity of our gardens. To be sure, water will be a commodity that we won't be wanting to waste so easily. Wondering about the sort of composting toilet you'll need? Well the simplest system is a two bucket system. One bucket has sawdust in it, the other contains your "business". After doing the business, pick up the sawdust bucket and cover your excrement with sawdust. Apparently it is a one to one ratio of sawdust to poop. Obviously, when the poop bucket is full, put it on the compost heap.

Offered by [Gino](#).





# Troubled Times



## Urine

---

I read somewhere that human urine is so high in nitrogen that you could easily fertilize a 40 x 40 foot garden with it.

Offered by [Sven](#).

Urine is very high in nitrogen. For use mix 1 cup per gallon of water. It's absorbed quickly so keep in mind of other slower release forms of nitrogen that you may have already in the medium. The plants should kept on a high nitrogen regime until they are put in to the flowering regime. Signs of low nitrogen are excessive yellowing of leaves from bottom up. Too much nitrogen will show burning spots on the leaves.

Offered by [Doug](#).

Any kind of urine can be used as fertilizer as long as you pre-mix it with 3 times the amount of water prior to applying on nitrogen loving plants. So say the people at [Biolet](#) composting toilets.

Offered by [John](#).



# Troubled Times



## Gray Water

---

In the designs of my home systems, you can set up your gray water system to run into planting/raised beds and tables preferably to a greenhouse adjacent to or part of your home. All of your water used for cleaning, bathing, in the kitchen, and your urine (yes, you should pee in the shower) will go into the beds/tables. Set it up for gravity flow, locate your water usage areas above the plants root systems/soil in beds, etc. All of the rich nutrients from urine, hair, skin, vegetable scraps, even natural soaps will greatly improve the health of your plants and soil.

Best to use an aggregate mixture of soil, perhaps sandy loam, with a touch of clay near the edges of the beds to help keep the moisture toward the plants and prevent leakage should your tables/beds be improvised or relatively permeable. Another set up is to have tables above some beds. Grow sun loving plants on the tables and let the excess water drip down to the shade tolerating plants below. Make tables with screens and non-rotting fabric for water soakage. If possible set beds directly into floor with or without waterproofing on bottom/sides, preferably in the subsoil of your home. This whole set up for beds/tables, etc. should be on the south side of your home, perhaps a slight easterly aspect is fine, or better, depending on where you are located.

Offered by [Steven](#).



# Troubled Times



## Concerns

---

I like the idea of capturing the methane for use as a fuel, but how does one add additional material to the tank without releasing methane into the room? You know, you lift the lid to take care of business and release a couple of cubic feet of methane that you have to breathe while taking care of business, then you have to wait a few hours before the pressure builds enough in the tank to start supplying methane to your cook stove again, etc.

So where do we pee, if not in the methane tank? In the sink? Is urine completely free of potentially harmful micro-organisms? Or does it need time to cure? I know it is rich in nitrogen (from the ammonia) but this will outgas quickly if not fed to the soil soon? Also, nitrogen is a vital ingredient in compost bins. The bacteria there need it to live and decompose material high in cellulose so why do the bacteria in the methane tank not want nitrogen/urine?

How can we be sure that our gray water is clean and clear of microbes and/or harmful chemicals? I know the easy answer, just don't put anything in the drain that is bad for the plants, right? But is there a way to pre-filter the gray water before feeding it to the plants? Have you considered this? Is it necessary? Also, will the anaerobic decomposition of human manure destroy parasites and/or microbes? Do we need to plan on further sterilization of the finished product before using it as fertilizer?

Offered by [Roger](#).



# Troubled Times



## Parasites

---

We are taught to not put anything of animal origin in our compost. Why is this? I believe (and my research and experience tells me) that this is because of two main reasons.

1. Animal by-products attract other meat-eating animals. Raccoons, cats, and dogs are the most common invaders of trash cans and would very likely make a mess of your compost if you put trimmings, bones, etc. in it. Besides, bones take so long to break down anyway. (I put eggshells in my compost and they never breakdown; however, they do break into very small pieces when I eventually mix them into the soil. They then erode and leach into the soil and provide a source of calcium for my veggies.)
2. Parasites and other undesirables that live and breed in animal by-products. Is there a way to eliminate these parasites and then be able to compost our animal waste as well?

Offered by [Roger](#).

This is an important question. Human parasites in a feedback loop are deadly. In other words the parasites we eat with our vegetables will be the ones that our body could not kill off and thus end up in our waste which becomes the fertilizer for our food. Unbroken this feed back loop can cause the quantity of highly destructive parasites to build up in a food chain-body cycle. I suspect this unheeded will cause more sickness and death after the pole shift than many other sources. We will need to break the parasite chain wherever we can. Cooking foods, filtering nutrients, possibly aeration or ultraviolet light used with recycled nutrients. Proper multistage bacterial break down treatment of human waste. Proper aging and/or use of algae. Note: urine is normally sterile and should be captured separately from the solids. The solid waste would need a longer process to make it a safe nutrient. Even injecting or growing good parasites to overwhelm the bad ones, is a possibility. Much needs to be known on this subject.

Offered by [Mike](#).



# Troubled Times



## Reassurances

---

I lived in the past on a very rustic farm. We used chamber pots. In the mornings, I would go out and toss my urine on a patch of some sort of greens that were just growing like crazy. This was in winter! There was a very visible difference between where the urine was poured and the land around it. I would suggest the urine can be diluted and still be most effective.

Offered by [Martha](#).

When I was studying natural therapies and herbology we learned that our own urine was a personally designed (free) medicine that you could drink or use topically for innumerable ailments. It is also an excellent nutrient for growing *food*, hydroponically or in your garden, and can be diluted with water to go further or mixed with other nutrients, including thoroughly composted human poop (made into a tea for hydroponics)

Your citrus trees (especially lemons) will love you blokes if you go out and pee on them every night, my husband delights our fig, apples and apricot trees nightly and they reward us with luscious fruit. Urine is clean, is *not* a waste product, it is manufactured from your blood and contains only ingredients that you would normally find in food - vitamins B1, B2, B5, B6, B12 and Inositol and minerals such as Calcium, Copper, Iodine, Iron, Magnesium, Manganese, Molybdenum, Phosphorus, Potassium, Sodium and Zinc. It contains 11 Amino acids, Aldosterone, Peptides, Dopamine and antibodies. and it is 95% water so if out in the dessert without fluids, don't pee in the sand!

Offered by [Janar](#).



# Troubled Times



## Foraging

---

### Wild About Weeds

*San Francisco Chronicle*, March 3, 1999

For Roos-Collins, the Berkeley author of *Flavors of Home: a Guide to Wild Edible Plants of the San Francisco Bay Area*, (Heyday Books, 1990) the chickweed, nettles, wild onions and purslane that pepper untended yards belong on the dinner plate, not in the dumpster. By learning to recognize a few wild edibles - and by steering clear of the toxic ones - Bay Area gardeners, hikers and other outdoor enthusiasts can graze at nature's table, says the author. ... Unlike wild mushrooms, which can require a sharp eye to find, the greens were everywhere.

**Mallow**, a clump of furry, rounded leaves. ... In Turkey ... cooks stuff the large mallow leaves with rice of meat as they might stuff grape leaves. In Tunisia, they steam the leaves, then beat oil and spices to make a dip for bread. The nutrient-rich green is so high in Vitamin A - second only to polar bear liver, Roos-Collins says - that too much can be toxic.

**Scallion**, a shady patch of scallion-like foliage with delicate, nodding white blossoms. Gardeners could exploit wild onions and their faintly oniony blossoms in salads and fish preparations. Jean-Georges Vongerichten, New York celebrity chef, scatters the blossoms over salads.

**Fennel**, a thicket of 8 foot tall wild fennel .. with dark, licorice-scented seeds. In Provence, restaurants stuff whole fish with wild fennel stalks before grilling and toss dried fennel stalks on the coals. In Italy, cooks gather the pollen from fennel flowers and use it to season pork.

**Radish**, clusters of tender greens all over a slope. .. It's easy to recognize, easy to like when cooked and present in abundance. The tiny pastel blossoms which have a slight horseradish taste, are fragrant on a sunny day.

**Curly Dock**, a long narrow leaf that tastes like sorrel.

**Stinging Nettles**, are delicious in soup. At Pomponio Creek Produce, an organic farm near Pescadero, CA, Martin Bournhonesque harvests nettles that turn up on plates at restaurants. Nettles have gone from a pesky weed to a profitable crop.





# Botanical.com

A Modern Herbal  
by Mrs. M. Grieve

## Search

*A Modern Herbal*

web botanical.com

[Title page, printed version](#)

[Bibliographical Note](#)

[Editor's Intro](#)

## REFERENCE

[Steadman Shorter's Medical Dictionary, 1942 Poisons & Antidotes](#)

## CONVERSION TABLE

[Pots/Soil Factors](#)

[Volume & Weight Converter](#)

[Cornell University Poisonous Plants Home Page](#)

[Links Page](#)

The hyper-text version of... *A Modern Herbal*, first published in 1931, by Mrs. M. Grieve, contains Medicinal, Culinary, Cosmetic and Economic Properties, Cultivation and Folk-Lore of Herbs.

- [Plant & Herb Index](#) More than 800 varieties of herbs & plants.
- [Index of Recipes](#) A listing of 29 plants that include recipes.
- [Index of Poisons](#) A listing of 44 plants that are listed as **poisonous**.

**Regarding cultivation** - Keep in mind that this was written in England, with a climate similar to the Pacific Northwest in America.

**For Medicinal Use** - Bear in mind it was written with the conventional wisdom of the early 1900's. This should be taken into account as some of the information may now be considered inaccurate, or not in accordance with modern medicine.

## A Modern Herbal - two volume set

**Author:** Margaret Grieve

**Pages:** 919

**ISBN:** 0486227987 & 0486227995

Both Volume 1 and volume 2

**Retail Price:** \$35.90

**Sale Price \$26.50**

Qty:

[Add to Cart](#)



More Books [\[Click Here\]](#)

**A Modern Herbal, first published in 1931, by Mrs. M. Grieve, contains Medicinal, Culinary, Cosmetic and Economic Properties, Cultivation and Folk-Lore.**

[Botanical.com Home Page](#)

Copyright © 1995-2012

# Troubled Times



## Dandelion Plant

### Greens

Pick when they are tender enough to eat as a salad, cook in a large pot of boiling water for 10 minutes and drain. This takes away some of the bitterness.

### Blossoms

Blossoms are good prepared like squash blossoms or elderberry flowers but are best known for making wine.

### Roots

If dug in early spring when the crowns are harvested they make a good vegetable. They should be peeled, for the outer skin is very bitter. Boil, then drain, then cook and season like carrots.

Offered by [Kristy](#).

From the book, *Honey from a Weed*



**Dandelions**, though never cultivated, were brought to market in England in the 19th century, just as weeds are brought to market round the Mediterranean today. 'When lettuce and endive are scarce, the dandelion might be dug up from the roadside and pasture in winter and forced in pots like succory.' (Loudon, *Encyclopaedia of Gardening*) **Succory** is a portmanteau name which may apply to **Cichorium** intybus and to other plants (*Picris* spp) with a certain bitterness; these were formerly cultivated and 'forced' for salads ('forced' means blanched by earthing up). They are among the many plants with dandelion-like leaves, all sheltering under the radicchiella umbrella, all edible.

Insalata Di Radicchiella \* dandelion salad

*Gather young dandelions by cutting a stub of milky root together with its head of leaves, or take the plant whole when small. Wash under the tap, pare the root, leave in water for one hour, then drain, shake dry, and serve with a vinaigrette dressing, or add to a well dressed beetroot salad.*

*Visitors to Girona in Catalonia should enquire in autumn after a pheasant or duck prepared with dandelions (El faisà o l'ànec amb queixals de vella). In the Pyrenees at high altitudes the variety alpinum is equally edible.*

Radíkiá Me Rízi Tis Kyrías Agápis, dandelion and chicory cooked in Kyría Agápi's way.

*In Kavála, Macedonia, now a megalopolis, culinary traditions carry on: grandmothers and great-aunts go on cooking in the age-old way. Here I should mention that weed-gatherers have never been known to measure or weigh.*

*After thoroughly washing the gathered dandelions and chicory, changing the water several times, Kyría Agápi chops them finely on a board, pours olive oil into a pan, puts in the chopped plants, adds a little water, salt. When they have cooked for a few minutes, she throws*



*in a handful of long-grained rice and some pine kernels, and continues to cook until the rice is tender and the liquid is completely absorbed.*

*If the pine kernels are lacking, this dish can be served with a grated piquant cheese. The Sculptor, in spring, often has this for lunch. Weeds promote energy.*

I found some information on the nutritional value of dandelions. Dandelions seem to rate pretty well:

- all parts are edible
- the leaves contain vitamins A, B1, C, + sodium and potassium
- according to the U.S. Department of Agriculture, they rank among the top four green vegetables in overall nutritional value

Offered by [Mike](#).

Taraxacum officinale, the Dandelion! Two outstanding qualities: it is useful in disorders of the liver and of the gallbladder. Chew fresh stems for relief in chronic infl. of the liver. As long as the plant is in flower, diabetics should slowly chew up to 10 stems daily. Also of value in itchy and scaly rashes and eczema, improves the gastric flow of juices; fresh stems can help remove gallstones painlessly, they stimulate the liver and the gallbladder. Has a diuretic, sudorific as well as stimulating effect. A herbal tea can be made with the fresh or dried leaves but best eaten raw, stems and roots as well!

Offered by [Pierre](#).



# Troubled Times



## Recipes

As another year of gardening and weed pulling is upon us, I believe it has occurred to many of us that the weeds we pull are much hardier than the domestic seeds we plant in their stead. Also, many of these "weeds" are actually very useful for their medicinal value as well as being edible. However, I for one, have been sorely lacking in the knowledge of identification, use and preparation regarding wild plants. I am starting to rectify this situation and I suspect that others on the list might realize that this is very useful knowledge! Others may be well advanced in "wildcrafting" as it is called. I have found the "net" to be an extremely useful tool and have joined several lists for discussions and information on edible-wilds. I have started out slow and easy with dandelions because I am totally sure I can identify them and I have them in abundance. So, for others who are weeding dandies, you might consider turning the job into another useful function with several things I have discovered. The leaves are edible raw although from my test munchings I see that the younger ones are more tender. They taste somewhat like spinach. I snap the roots off as I go along weeding and then wash thoroughly and dry them in a 200 degree oven until they are brittle. These can then be ground even in a coffee grinder and then run through a coffee pot for tea. Or you can boil water, remove from heat and steep the chopped up roots as well. I understand that adding chickory root gives a more "coffee" flavor to the brew.

The original recipe I found for the flowers (buttons as they are referred to) was to just pick them, rinse well and then mix them with beaten egg(s). Then roll them individually in cracker or bread crumbs and fry until browned (which happens very quickly.) This tastes very similar to breaded mushrooms and the results can be dipped into ranch dressing, or whatever you prefer. I am not a fan of fried foods however, so I took the recipe a step further. After mixing in the eggs, I spooned ranch dip on to the buttons, then rolled them in seasoned bread & cracker crumbs and placed them individually on a non-stick cookie sheet. I baked them for about 15 minutes in a hot (450 degree) oven. They were quite tasty. Dandelions are very rich in potassium and lecithin and supposedly good for many ailments including liver problems and high blood pressure. However, I am not versed enough yet to know which parts and how to use them for specific medicinal purposes. I also believe the leaves can be dried but for what again I am still searching. And then finally .. there is dandelion wine! I haven't tried making it .. yet!

Offered by [Sue](#).

I know how to make dandelion greens palatable.. My grandmother, Nana, used to boil the young leaves first, drain them, dip them in beaten egg and then in bread crumbs, and then saute the greens. Serve with a lemon wedge. Has everybody cringed yet from the loss of nutrients? They never even thought about those things back then. She also made wine out of the yellow flowers; maybe the alcohol took everybody's minds off of the nutrient loss. The wine was made by first making a really strong tea from the flowers, adding lots of white sugar - way more than one would normally want in tea, and adding a few teaspoons of champagne yeast (which makes a clearer wine than bread yeast - but bread yeast would work). Exact measurements aren't needed because every vintner has her own special recipe, and anyway, Nana has been dead since 1975 and I have nobody to ask. But I do know that to make wine, all you need is sugar, water and yeast - everything else is flavor. Mead is made by substituting honey for sugar. Adding woodruff (a sweet smelling herb; it is used with white grape juice to make the German "May Wine") also has a mild mentally, drug like effect. I am just passing on this alcohol information for scholarly reference only. I am in no way advocating the drinking of wine - I am a teetotaler myself - oh yes, if you distill the wine you get brandy.

Offered by [Laura](#).



# Troubled Times



## Cooking Tips

---

But they are very *strong* in taste. I have eaten the leaves in salad (lots of dressing) and sautéed the crowns in butter (almost inedible in taste) and tried both leaves and crowns in soup (very bitter and then, subsequently, very salty!). We need a cook to tell us how to make them palatable (other than waiting for the needs of the starving to outweigh the needs of the taste buds).

Offered by [Roger](#).

I was in the "mood" for a salad last night. So, I went out into the yard and made one. I picked about 50% young dandelion leaves and 50% young Plantain leaves. Washed, patted dry and put some ranch salad dressing on them that my daughter had made up. The Plantain taste a whole lot like leaf lettuce but the dandelion was bitter, even with the dressing. They are also "leafy" to chew and not crisp like lettuce. I had to chew a few mouthfuls, it seemed, like forever and thought I would never be able to swallow that taste. But, even though I had only had one meal earlier in the day, I never got hungry until about midnight when my wife got home from work (we had some baked potatoes). My opinion is that it is an acquired taste. One that you will get used to over time. Everyone is looking for a good source of vitamin "C" and here it is growing right in your driveway. If you just want a great salad, try eating just Plantain with dressing. That's great.

Offered by [Clipper](#).

My understanding from the "edible landscape" elist is that you can take the older leaves and you boil them and drain them several times to leach out the bitterness. Acorns are treated the same way as they have tannic acid I believe. To make acorn flour or paste you would boil and drain numerous times.

Offered by [Cynthia](#).

One of our native dishes is a bitter melon, one can get this bitter melon fresh from a Chinese grocery store and the taste is much more bitter than anything else including those dandelion leaves, what we usually do is after the seeds were removed and the melon sliced, we marinated it in salt water for about half an hour before we stir fry them, and somehow the salt water did removed the bitterness, I believe it might work also for the dandelion leaves.

Offered by [Tian](#).



# Troubled Times



## Bamboo

---

There is lots of information on the web about Bamboo and growing it locally in [America](#)

This place sells [Potted Bamboo](#), and this site says the following about bamboo as food:

*Bamboo can be eaten fresh or processed by canning and freezing. Fresh bamboo has a crisp, sweet flavor. It is used in Oriental cooking as an extender because it will take on the flavor of whatever it is cooked with. A bamboo shoot has about the same nutritional value as an onion and is a good source of fiber.*

*Most of the bamboo in the U.S. is canned although some fresh bamboo is beginning to reach the public. Gourmets report that once a person has tasted fresh bamboo it is difficult to switch back to canned even though fresh is much more expensive. Generally the U.S. public has indicated a preference for fresh foods--asparagus--for example, and is willing to pay a good deal more to get fresh vegetables. The price for fresh bamboo on the West Coast is about \$3 per pound. It is considerably more expensive on the East Coast.*

*Each acre of mature bamboo will produce about 10,000 - 20,000 pounds depending on the species, the water, and the fertilization. Even at \$1 per pound to the farmer, bamboo is a real cash crop! The first large food plantation in the U.S. is now being planted near Tampa, FL. WWT will be glad to furnish detailed information and references to farmers in the Southeastern U.S. who may wish to consider planting bamboo.*

Offered by [Leila](#).



# Troubled Times



## Harvesting

---

Generally, in Springtime, a bamboo grove sends up new canes from its underground root system (called a rhizome), Technically, since bamboo is a grass, the grove you see above ground is really one plant - with lots of "blades" in the form of bamboo canes. Early on, while the young "bamboo babies" are no more than several inches to a foot out of the ground (looking somewhat like fat asparagus shoots), the bamboo grove owner decides which canes will be retained for landscaping beauty or later construction and which ones are to be harvested for food. In the East, folks often walk barefoot around the groves in early spring so they can feel the nubs of the emerging shoots. Those to be eaten may then have earth piled around them to enhance their tenderness as they rise beyond ground level. The rising canes can grow from one to three feet per day and living in a bamboo grove is an awesome experience - for this and many other reasons.

After the early shoots are harvested, the outer husk-like covering is removed much like husking corn. Depending on the variety of bamboo being grown (there are many varieties) the tender inside can be eaten raw, or if the particular variety of shoot is bitter, it must be put in boiling water - which is then poured off and boiled with new water from one to three times. The resulting bamboo shoots are a good source of nutrition - being high in protein and other nutrients. The flavor is typically a root-vegetable, nutty taste, with a rather crunchy texture. The concern that bamboo will "take over" if we plant it, commonly expressed among Westerners, is not quite accurate. One can plant bamboo and easily manage the grove, year-by-year, as the rhizome grows - leading to larger and larger canes in the case of running bamboo. Harvesting for eating and construction (even giving away) helps keep the grove size in check.

Offered by [Granville](#).

The young shoot of the culm is edible when harvested just before it emerges from the soil. The shoots are harvested in the morning. A special tool is used to cut them off about twenty cm below the surface. Depending on the species, the shoots appear in spring or fall. Because the outer sheaths are hard and fibrous, like those of artichokes, the shoots must be boiled, sautéed or roasted and then the sheaths removed to reveal the tender heart. The shoots are also sold pre-cooked in cans. They can be added to different dishes as a vegetable, or eaten cold in a salad.

Offered by [Mike](#).



# Troubled Times



## Growing

---

Bamboo is often introduced by digging up a small portion of the rhizome (root system) at the fringes of the grove and planting it in prepared (slightly acidic, enriched) soil. After a time, canes begin to come up - getting bigger and bigger every year as the rhizome grows. Thus, it is important not to remove root material from the middle of the grove, as it risks cutting the rhizome in half. Also, there should be a balance between allowing the root system to grow and giving parts of it away - unless cane size and grove size do not matter. (As far as I understand, this applies more to the temperate, running bamboos, and not as much to the smaller, clumping tropical bamboos.) An excellent, highly practical and inspiring book on the topic of bamboo is David Farrelly's *The Book of Bamboo*. An online search on the keyword, "bamboo," will bring up a lot of information - including bamboo nurseries where you can order rhizomes online. Be sure to order varieties of bamboo that are suited to your area - in terms of its present climate *and* anticipated climate in the future.

Offered by [Granville](#).

I searched, but can't find what bamboo requires as sunlight to start new growth, but I think very little. I have been in bamboo forests that are so thick that you can't walk, and very little sunlight is available; near constant shade, but new shoots are readily available. [Bamboo](#), of course is found in tropical regions where much rainfall is recorded, and due to the anticipated rain in the aftertime, and depending on one's location bamboo may be one of the trees that can survive. Bamboo has no peer as far as strength and durability is concerned, and if used in construction of small dwellings would serve well as a shelter.

Offered by [Mike](#).



# Troubled Times



## Cattails

---

Regarding eating cattails past their prime. I assume you mean they have turned to the brown, full of fluff, seed pod. If this is the case, you may want to try this. The Paiute eat cattail seeds. A friend of mine and I were scratching our heads about how they separated the seeds from so much fluff. Finally we just lit a pile of fluff which of course disappeared with a poof and continued adding a little at a time until what was left was some nice toasty seeds. Tasty but tiny.

### [Benjamin Pressley](#)

In addition to edible cattail seeds, spring buds on underground stems and young shoots can be eaten raw or cooked like asparagus. Cores of the young leaves can be cooked in the same way. Cook female flowers (male flowers are yellow above and female flowers are green below on the same stalk) like corn on the cob and use ripe pollen as a flour substitute. Starchy cores of underground stems in winter can also be ground into flour.

Offered by [Steve](#).

Common cattails shoots are very edible and the roots work well as a substitute for potatoes.

Offered by [Woodie](#).





# Troubled Times



## Lichens

Lichens are a symbiotic association between algae and fungus. The algae is a layer of single-celled plants on the surface, just below a gelatinized layer of fungal hyphae. The algae captures nutrients that land on its surface and provide energy through photosynthesis, while the fungus absorbs moisture, and provides a protective structure for the algae. These are otherwise independent organisms, capable of surviving without each other. Lichens can insert threads a half inch into solid rock. These threads are not true roots, but anchors. The fungus produces a potent acid, which is combined with an alcohol from the algae to form acid crystals. The varied and often bright colors of the lichens come from these acid crystals. The acid is used to etch holes in the rock, and threads are inserted for anchors (Platt). Most of the so-called "mosses", especially those found in trees, are actually lichens. The true mosses are distinctively green like other true plants.

Lichens gather most of their nutrients through their surfaces, directly from the air and rain. This habit gives the lichens an adaptability to live almost anywhere, even on rocks, trees, or buildings. ... The Lichen Division is comprised of at least 8 orders, 45 families, and 6,000 species. Information on the edible and medicinal uses of the lichens is scattered. Many lichens are known to have potent antibiotic properties, and many are edible. However, some lichens do contain toxic substances, so you should not graze randomly on them.

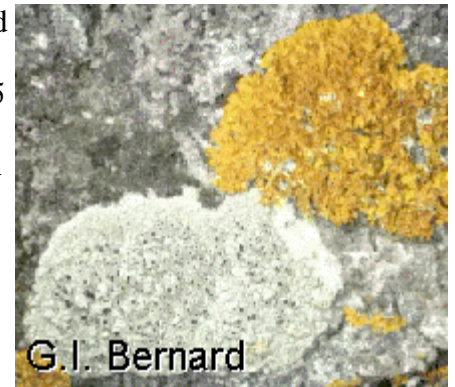

### **Gyrophora -Rock Tripe**

The lichen is edible, especially when boiled with meat (Sturtevant).

### **Umbilicaria-Rock Tripe**

This lichen is edible cooked. Soaking in a couple changes of cold water will help to remove the bitterness. They are said to be mucilaginous, great for thickening stews (Angier). It also has antibiotic properties (Angier).

### **Lecanora-Cup Moss, Manna**

The plants are edible (Sturtevant). One species, growing in the middle-east is the "manna lichen". During drought years the plant may be broken apart by the wind and blown across the land. This lichen became immortalized in the Bible when it showered down on the starving Israelis as the "manna rain".

### **Cetraria-Reindeer Moss**

Reindeer moss is bitter, antibiotic, and edible. The lichen is used as an expectorant to stimulate the release of phlegm, apparently due to the bitterness. This bitterness needs to be removed to make the plant edible. The lichen should be soaked over-night and for most of a day, in two changes of cold water to remove the acids, then strained and eaten (Angier). It is a source of gelatin (Asch).

### **Alectoria-Black Tree Lichen**

The black tree lichen is stringy and "moss" like. Montana Indians washed and soaked the lichen, then cooked it for one to two days in a steam pit. The cooked lichen was eaten or dried and powdered and used as a mush or thickener later. It is reported that Flathead Indian families ate 25 pounds of the lichen each year (Hart).

### **Evernia**

The plant is edible (Sturtevant). A thick tea is used on running sores (Murphey).

### **Letharia-Wolf Lichen**

This bright yellow tree lichen contains a highly toxic acid. It was once combined with animal fat and nails and used in Europe to kill wolves (Vitt). It is also used as a dye plant.

### **Usnea-Old Man's Beard**

The lichen is boiled for use as a dye (Gilmore). It is used medicinally as an antibiotic (Klein). (Usnea is a light grey color. Use the "rubberband" test for positive identification: break the stems and inside you will find a white, rubbery core that stretches a little like a rubberband.)

### **Sticta**

The lichen is edible (Sturtevant).

### **Cladonia-Pixie Cup Lichen**

The Cladonias contain didymic acid, used as an antibiotic against tuberculosis (Mabey). It is reported to be edible (Sturtevant).

### **Cladina-Reindeer Lichen**

Some species were boiled and the tea was taken for colds or as a laxative.

[Thomas J. Elpel](mailto:thomas@hollowtop.com)

thomas@hollowtop.com

**Hollowtop Outdoor Primitive School**

Pony, Montana

thomas@hollowtop.com



# Troubled Times



## Seaweed

---

Below is an article on the cultivation of seaweed.

Offered by [Steve](#).

### **Cultivation: Introduction**

Seaweed cultivation takes many forms but there is a kind of evolutionary process through which it develops, the rate of which is market-driven. If demand is low and natural resources adequate, cultivation is unnecessary. As demand increases, natural populations frequently become inadequate and attempts are made to increase production by resource management techniques such as improving harvesting techniques, removing competing species, adding artificial habitats and seeding cleared areas. Such techniques are most highly developed in Japan, China and south-east Asia.

Should such management prove to be inadequate, the use of artificial structures to grow seaweeds becomes inevitable. Fragments of adult plants, juvenile plants, sporelings or spores are seeded onto ropes or other substrata and the plants grown to maturity in the sea. To do this, intimate knowledge of both the biology and life history of the plants is critical. For example, kelps cannot be grown from fragments as there is a high level of specialization and fragments of sporophytes do not regenerate. On the other hand, many red algae do not have this degree of specialization and can easily be grown from portions of the adult plant. Knowledge of the life history is critical in many cases and on-land cultivation of particular life history phases is often necessary for seeding. A considerable amount of technology has gone into the development of reliable methods for the cultivation of seed-stocks and their improvement.

The penultimate development in seaweed cultivation is the growing of plants in artificial impoundments on land. This involves the use of either tanks or ponds into which seawater is pumped and the seaweeds are grown detached and at very high densities. This necessitates the careful study of the growth parameters of the seaweeds involved and the development of special strains, preferably with high growth rates, but more importantly, adapted to the artificial conditions. In some instances, the cultivation of seaweeds in association with animals has been attempted, which is often referred to as "polyculture". The ultimate development of seaweed cultivation will probably be the growth of genetically-improved strains in fermenter-like reactors, in which all environmental factors will be controlled and artificially-compounded seawater-like growth media used. It is likely that such strains will be developed by means of biotechnological techniques.

The world's most successful seaweed cultivation industries are in Asia, where low labour costs married to simple and intelligent maricultural techniques have proved very successful. The labour intensiveness of seaweed mariculture and the absence of a ready market have been the main reasons why seaweed mariculture has not developed to any great extent in the west. If seaweed-based cultivation is to develop in Europe and north America, we must look at the market potential of seaweeds and the various ways in which seaweed mariculture can be improved so as to reduce the labour content.

Large-scale seaweed mariculture is carried out only in Asia, where there is a very high demand for seaweed products and burgeoning populations to create market growth. Most cultivated seaweeds are grown for the food market, although the *Eucheuma* co-operatives in the Philippines and *Gracilaria*

cultivation in association with milkfish production in Taiwan are exceptions to this rule, the seaweeds being used for carrageenan and crude agar production, respectively. Cultivation of seaweeds in Asia is a relatively low-technology business in that the whole, attached plants are placed in the sea and there is a high labour content in the operation. Several attempts have been made in various western countries to introduce high technology to the cultivation of detached plants grown in tanks on land in order to reduce labour content but none of these has attained commercial viability to date.



# Troubled Times



## Chicory

---

From the book, *Honey from a Weed*

**Wild chicory** (*succory*) goes by a number of names.

The ways of cooking weeds are simple; the trouble is in cleaning them. Gathering the chicory with a stub of root in autumn or in spring, you scrape the root stubs with a knife, pick off old or yellowing leaves, and, plant by plant, throw them into a crock of rainwater. Change the water at least twice. Leave them in water till next day.

The Simple Way. Drain and rinse again the prepared chicory, and throw it into a cauldron of slightly salted boiling water. Cook for 20 minutes and strain. Serve hot with oil and lemon juice, the purest way. Or dress with olive oil and grated pecorino sardo.

Another Way. Clean and cook as above, strain and throw the chicory wet into a pan containing a little hot olive oil (or pure pork fat) with two cloves of peeled garlic and one hot chili pepper. Toss them in the oil or pork fat and serve, adding a few drops of wine vinegar.

For Feast Days. In the Salento in autumn, chicory is served with collar of pork. The pork, rather fat, is boiled with bayleaves, then cut into robust chunks and put into the pan to render some fat. When slightly browned, the pork is set on a heated dish and the cicuredda, already boiled, is tossed in the fat and served on a separate dish with slices of lemon.

Another Way. A more refined dish emerges if you cut a slice of pancetta (salt belly of pork, fat and lean) into neat small strips, brown them in a pan, then add the boiled chicory and toss it for a few minutes in the fat, then add a few drops of wine vinegar.

These simple preparations apply to many weeds, when not destined for salad.



# Troubled Times



## Sorrel

---

From the book, *Honey from a Weed*

**Wood sorrel**, a small trefoil: this 'of all Sorrel sauces is the best,' wrote John Gerard. These fragile leaves and stems were those originally used by the French in their Julienne soup, according to Auguste Kettner. Wood sorrel is less acid than field sorrel. It appears in the soup as little 'threads,' these being the stalks, the trefoil leaves having dissolved. They are the origin of the fact that a Julienne soup should contain little vegetable slithers finely cut and hence of the phrase *en julienne*. Gerard's sauce was sorrel 'stamped' (pounded) raw to which was added sugar and vinegar, a sauce for roast meat. In his day a polished brass cannon ball was sometimes used as pestle.

Field sorrel is well worth growing in the garden when woods and fields are far away. In the Salento three kinds of field sorrel, all forms of *R scutatus*, grow among the stones piled on the margins of the fields; one picks them in November at the same time as field agarics, in autumn and again in spring.

Uses of both include, besides sorrel soup:

- as a sauce, chopped and melted in butter over a gentle heat, stirring, for fish;
- as a stuffing for fish, chopped and mixed with breadcrumbs, egg yolks and butter;
- as a last minute addition to a wild spinach soup, just before passing it through the mouli;
- simmered in butter and used as a dressing for steamed potatoes.



# Troubled Times



## Salads

From the book, *Honey from a Weed*

**Lamb's quarters** (*Chenopodium album*) has to be my first choice. If it were not for this weed, my family would not have survived the last days of World War II, when we had nothing to eat except what we could find growing in ditches and along roadsides. My mother just dipped the leaves in hot water, but they taste just as good raw. I add this ingredient to all my summer salads. It tastes exactly the same as spinach. Germans have bred a variety which I call Giant German Spinach. It ordinarily grows to be 5 feet tall, but in my rich organic garden, everything gets to be twice the regular size. I allow a few plants to go to seed so that they can self-seed for the following summer's crop. Unlike spinach, lamb's quarters stays tender all summer long, even in drought, and it does not go to seed until late in the season.

Redrooted **pigweed** (*Amaranthus retroflexus*) can be recognized by its dark red stems. Its tender leaves make a good substitute for lettuce. In its mature state, it can be steamed or stir-fried like spinach. It is more palatable in damp conditions than in our dry prairie summers.

**Chickweed** (*Stellaria media*) is more delicate in taste and texture than most weeds and can be used raw at any stage of maturity. If the tiny stems become stringy, they can be cut with scissors.

To add something spicy to a salad instead of radish or cress, the mustard family weeds come in handy. **Wild mustards** (*brassicas*) tend to be too coarse and bitter except for small quantities of the flowers and the very young leaves, but the seeds and tender tops of shepherd's purse (*Capsella bursa-pastoris* or *Thlaspi bursa-pastoris*) and **pennygrass** (*Thlaspi arvense*) have been eaten by most children if only because of the interesting shapes of their seedpods.

The mucilaginous weeds are my favorite and the most common one is **mallow** (*Malva neglecta* or *parviflora*). The tender leaves are edible early in the season. Later on, the flowers and immature seedpods are most delicious. The seedpods are tiny replicas of those of hollyhocks and both are delicacies when eaten raw.

**Purslane** (*Portulaca oleracea*) makes a rather juicy salad ingredient, but it completely disappeared from my garden within a couple of years of cultivation. Apparently it does not like to be disturbed in its natural environment.

The new shoots of **dandelion** (*Taraxacum officinale*) are popular in European spring salads, but in our prairie climate, the leaves tend to be too dry for my liking. I much prefer to eat the flowers. Besides being juicier, they are sweet with nectar. I do not mix dandelion with other salad ingredients, but prefer to eat them alone. They taste exactly the same as cocoa beans. Many people, especially women, have a craving for chocolate. Eating dandelion or other bitter herbs satisfies that craving.

Wild lettuce (*Lactuca serriola* or *scariola*) and **sow thistle** (*Sonchus oleraceus*) are taller and more slender than dandelion but the taste is similar. The flowers are also yellow except for those of the blue sow thistle (*Sonchus alpinus*). Wild lettuce can be used exactly the same as dandelion. Here, too, I prefer the flowers.

**Wood sorrel** (*Oxalis corniculata*) is not a sorrel (*Rumex*). Its flavor is more delicate, sweet and sour. Its light green clover-shaped leaves are enhanced by showy yellow flowers. It is one of the most attractive weeds at the edge of many gardens. Warmer climates grow wood sorrel with white or purple flowers (*Oxalis acetosella*).

**Dock** (*Rumex crispus*), however, is a true sorrel (*Rumex*). This perennial weed pest grows profusely in swampy sections of fields, but seeds often find their way into gardens. In small quantities, the young leaves can enhance a salad. No one, however, has ever been able to talk me into enjoying any kind of cooked sorrel. The brown color alone is sufficient to turn me off.

If your property has swampy spots, you may be lucky enough to have access to **cattails** (*Typha latifolia* or *angustifolia*). Try to catch the young shoots early in the season. They pull out easily and you can bite off the tender bottom end, one of the favorite delicacies of my childhood.

In early summer, you might want to be more adventurous and experiment with the tender new shoots of **needle trees** just as they lose their brown wrapping. They have a delicate, slightly sour taste.

Hairy Weeds, too? Of Course!

Almost any green weed which can be found early in the season might end up in a salad. If it is too hairy, you can steam or stir-fry it for 4 or 5 minutes to eliminate the discomfort without minimizing the nutrient content.





# Troubled Times



## Many Others

---

**Puffballs** are great pan-fried, as are **fiddlehead ferns**. **Burdock roots** are good, kind of like potatoes. They are harvested out of the wet marshlands. There are also **wild onions**.

Offered by [Kristy](#).

From the book, *Honey from a Weed*

In March, or sooner in limestone districts, the succulent shoots of **fennel** are sought out at the base of the plant and cut off with their little plume of fronds emerging from a sheath. Boiled till tender and eaten with olive oil and lemon juice. Or boiled for a few minutes, dried, tossed in fine flour and fried in hot oil. Much used in preparing fish soups. ...

Cousin of the grape hyacinth, **tassel hyacinth** has a 'mad' flower with purple 'tassel' and a delicious edible bulb; it grows wild on limestone, but is so much appreciated in early spring that it is also cultivated. The wild bulbs are smaller and more excellent. They are dug out of the earth when three straggly leaves first appear. Recipe. Wash the bulbs, then boil them. When tender, say after 20 minutes, drain and remove the rough outer skins while warm. The peeled object slightly resembles a very small peeled onion, only it is tinged with faintest green and purple. Cut them in half (or not), sprinkle with salt, pour over them a little olive oil and wine vinegar. Serve cold as an antipasto; they are delicious. The corms of *Crocus cancellatus* on Naxos were prepared in the same way, dug up in autumn. ...

**Purslane** is a little succulent from Asia which reached the Mediterranean in antiquity. It appears spontaneously in late summer in cultivated ground in Greece, southern Italy and Spain, often close to the Indian fig or prickly pear, which came from central America. Fleshy-leaved, emerald green, purslane makes an excellent addition to a tomato salad, when picked before its small yellow flowers appear. It was grown as a pot-herb in England in Victorian times, a kitchen garden annual, but was already mentioned by Gerard in 1597, as was the then 'fabulous' Indian fig, which he showed, drawn from hearsay, as an arboreal cathedral!



# Troubled Times



## Grasses

---

It is my understanding that there are no known poisonous grasses in the world. Of course we are used to eating the fruit of the grain (in breads and pastas), but the blade is also consumable in time of need. They may taste bad, but the blades contain most of the elements that compose the human body, which is something to keep in mind.

In a survival situation, the best way to extract the nutrients is by locating a healthy patch of young grass, growing in shade or partial shade. You can cut the grass and bring it back home to share with family (it will keep in a plastic bag very well) or consume it right on the spot. You should think of it as your vitamin pill: chew it for several minutes so that the cell walls in the blades are crushed, and the green juices flow into the mouth where it will be swallowed. Spit out the pulp. Only very small quantities of the juice are needed to receive significant benefits, so you will only need to chew a few mouthfulls each day.

The modern *wheat* grasses have the best flavors, though the taste is incredibly strong, and it is hard to say which of the grasses have the "best" flavors. I have sampled many of the native grasses, too, which have even stronger flavors. But, you should remember that young green grass is a very valuable survival tool which can help your family through the hard times.



Graphic by [Michel](#).



# Troubled Times



## Lemon Grass

---

Lemon grass (*Cymbopogon citratus*) is native in India and is grown in Sri Lanka, the Seychelles and in Uganda. It also is grown sometimes in herbal gardens. It's name comes from it's strong lemon scented leaves. It's oil is used in the scent-industry where it is used to make fake lemon-oils. It is very easy to grow but difficult to get. Lately, it's strong lemon taste is much appreciated in a growing number of kitchens. Get your hands on a couple of them, grow them, and multiply them. Sell them to your local grocery shop, supermarket, or just give them to those people you know.

Offered by [Michel](#).

It is very easy to grow lemon grass. It needs moderate sunlight. Last year I planted it in the backyard, and did not pay much attention to it until the first frost. By then it was too late to transfer indoors. It will multiply by it self through its roots like bamboo. Regarding the soil itself, I guess if your lawn grass will grow, so will the lemon grass. To plant lemon grass; first, you can get a fairly fresh lemon grass with a fairly green stalk in a Chinatown from a Thai or Vietnamese grocery store, and make a thin slice at the base of the stalk, and then just dip it in a deep glass of water and let it sit for 3 to 10 days until the roots start to grow. After that you can transplant them in a pot with potting soil.

Offered by [Tian](#).

I have some lemon grass here in a pot. It is much like sugar cane, but not 15 feet tall. It grows about 3 feet tall (1 meter) and roots at the joints. I bought some for a Thai soup and rooted the bases, now its about a foot tall. It grows well in rich garden soil, lots of compost. Regular peat is too acid and lacks in nutrients. Rotten leaves and kitchen waste is rich and balanced. It is, however, a tropical. You will need to keep it indoors if you get hard frosts, Zone 9 is the likely northern limit in the East. It survives the winter here in the San Francisco Bay Area, but likes LA better. It looks ratty in the winter, but come March or April it perks up. We get cool rainy winters, but little or no frost.

Offered by [Brian](#).



# Troubled Times



## Sweetgrass

---

### **Rare indigenous plants flourish in Canadian nursery**

*Reuters*, September 21, 1998, by Leah Eichler

Ken Parker, like many new homeowners, dreamed of a perfect garden. But Parker, a Seneca Indian and former U.S. Marine Corps sax player, knew he would have a problem planting common flowers in his garden on the reserve west of Toronto since it consisted mainly of clay soil and limestone. So he decided to use plants indigenous to the area, ones hardy enough to survive Canada's long, cold winters as well as the poor soil. But to his surprise he could not find any. Thus began his search for the literal roots of his people - a quest that sometimes pitted him against his elders but eventually led to a thriving new business. "We just wanted a nice yard with a garden ... indigenous plants seemed like the logical choice but I couldn't find it," Parker told Reuters at his home on the Six Nations Reserve.

He searched for stores selling indigenous plants but found few that offered what he wanted, so he began traipsing around the continent looking for them in the wild. Now, with his wife Linda, he runs what may be the only nursery owned by Indians and dedicated to reestablishing native North American plants. His garden doubles as a showcase for indigenous plants. But his first commitment is to grow plants important to Indian cultures such as Sweetgrass and Sage, which are burned in religious ceremonies. His Sweet Grass Gardens carries several rare or hard-to-find species such as Canada's Prickly Pear, the Iroquois Potato, Buffalo Grass and Sweetgrass.

### **Sweetgrass used in Everyday Life**

"Sweetgrass is very uncommon now," he said. "Natives used to use it in everyday life ... to clear their minds and spirits and start their day. But no one was managing it and now the populations are relatively few." When it first opened, Sweet Grass Gardens carried about 12 varieties of plants. Now it has more than 200 listed in its catalogue as well as many that are not listed, which the Parkers keep in small quantities. Sweet Grass Gardens supplies combinations of plants suitable for different environments and soil conditions. For example, owners of a large piece of land can reproduce "prairie" conditions with a mixture of flowers and grasses, while more urban home owners can purchase rock garden plants or cacti native to the area that can survive winter.

Plants indigenous to colder climates develop deep root systems, Parker said. They are hardier but take longer to mature. Sometimes the only maintenance required is to till the land and cut back or burn the plants once a year. Originally, Parker's idea to sell native plants to Indians was received with trepidation since many on the reserve felt that people should not profit from ceremonial plants. "What got us around that is we told elders that we want to restore the numbers, preserve and maintain them, and then they understood. It wasn't that we were trying to be greedy and sell our natural resources," Parker explained.

### **Scientific Names Used for Plants**

Although their mission statement explicitly states their ambition to "preserve the history of North America and its First Nation people by encouraging the rediscovery and respect for our traditional Mother Earth," Parker sticks with the scientific name for all his plants. "I guess I was pretty naive because even here at Six Nations a single plant will have several names since Six Nations mean six distinct languages. And if I can only find a Seneca word for a plant the Cayuga may get mad and it became overwhelming," he explained. The Six Nations Reserve, where Sweet Grass Gardens is located, includes the Mohawk, Seneca, Oneida, Onondaga, Cayuga and Tuscarora people. It is the only native community in North America that has each of the Iroquois nations

represented.

Sweet Grass Gardens has also become an educational center, offering slide and multimedia presentations of native plants from an Indian perspective. Parker offers one-day workshops of topics ranging from propagation techniques to garden design. Although there is no standardized definition, Parker quickly realized that it would be necessary to differentiate between native plants and aboriginal ones. He defines native plants as those indigenous to North America before European settlement, while aboriginal plants are significant to Indian culture, whether medicinal, ceremonial or edible, and are not necessarily indigenous.

Business for Parker may not be booming yet but gardeners and landscapers have shown enough interest in his idea to keep him going. "When we first started we said, 'If we could sell Sweetgrass and Sage to 5 percent of the aboriginal population in Ontario, our business could be successful,' and that's not a lot if you think about it," Parker said. But the business took off in directions the Parkers did not anticipate and most of their sales go to non-Indians. Many environmentally conscious gardeners are attracted by the notion of native gardening, since chemicals are not necessary. "I hate to say it but it's very trendy now, even with non-natives," Parker said. "They're all interested in growing herbal remedies and stuff."



# Troubled Times



## Prickly Pear

---

I just read an article about the above.

Prickly pear planted around perimeter of your yard provides a steady supply of food, and serves as a natural fence through which most animal and human intruders won't penetrate. Also the cactus stops the spread of grass fires though the fire causes some temporary damage to the cactus.

Prickly pear cactus is easy-to-grow, drought resistant. The plants thrive in sunny arid regions but can't tolerate snow and frost or extremely wet environments. It is not isolated to the Arizona deserts as it is found throughout the United States on the plains as far east as Nebraska and grows along the Atlantic coast. Throughout Los Angeles it is so common that it is often regarded as a weed.

- It can produce several year-round foods as well as sweetener, red dye, hair conditioner and flour.
- The pads, fruits, seeds and flowers are all edible and can be prepared in a variety of ways.
- Cacti are about 90% water and the easiest way to obtain water from cactus is to peel the fruit or young pads and eat them raw.
- A glue-like liquid can be obtained if you mash and press the pulp.
- The fruit tastes like watermelon.
- The seeds can be dried and made into flour.
- Diced Pads can be used to thicken soups and stew.
- Peeled pads can be baked like squash or pickled.
- Researchers are verifying the value of eating the prickly pear pads to control diabetics and increase of pancreas to produce insulin.
- The fruit ripens in summer and can be used to make drinks, pies, jam, jellies, ice cream and other desert items.
- Artists can make a dye from the fresh red fruit.
- The peeled pads can also be sliced thin (like green beans) and boiled.

Recipes are available. Small to large plants available . One large pad for planting is \$3.00 including postage. To obtain prickly pear cactus plants contact:

### **Survival Services**

P.O. Box 41834

Los Angeles, CA 90041

Offered by [Debra](#).



# Troubled Times



## Many Benefits

---

The School of Self-Reliance has information on the benefits of prickly pear cactus (nopales). Nopalitos (the flat pads) taste a lot like bell pepper, can be eaten raw or cooked, and is high in fiber and Vitamin C. According to studies (mostly at Mexican universities and the Prickly Pear Council in Kingsville, Texas), something about the pectin acts as a kind of natural insulin for diabetes (although if you want to try it for diabetes, I'd urge you to do it under the supervision of an open-minded doctor). The younger, smaller pads are tastier. You peel them like potatoes; some folks soften the thorns before peeling by letting them sit in hot water for a little while. Tunas are the fruits that bulge out at the end of the nopalitos. They can be eaten raw or cooked, are sweet and high in Vitamin C and make candy, jam, beverages and syrup.

Offered by [Lyn](#).



# Troubled Times



## Flowers

---

### Day Lilies

Use young crisp tubers raw in salads or boil and eat like potatoes. Young shoots can be prepared like asparagus. Buds can be cooked and eaten like green beans or dipped with the flowers into batter and made into fritters. Fresh or dried buds and flowers can also be used in soups.

### Violets

Use the leaves in a green salad or cook and serve like spinach. Use dried leaves to make tea. It is best to use violet leaves only when the plants are in flower so you can be sure they are violets and not something else.

Offered by [Steve](#).





# Troubled Times



## Edibility Test

---

From *owner-primitive-skills-group@uqac.quebec.ca* on behalf of Dr AF Bourbeau

An edibility test, to be logical, has to work with the most poisonous plants on the planet. This means you don't want to die from testing the plants, nor be seriously ill. I think this test answers these criteria. Before I go on, though, I would like to inform you of the circumstances which would warrant using this test- of which I can only think of one. The only time you would need this test is when there is a very abundant plant available which could provide you with sustenance if it was edible, and you did not have access to information, such as on a lengthy trip. For example, on a month-long walkabout I did in the far north, I wanted to know if a very abundant weird looking orange berry was edible or not- looked to me like it was from the *Rubus* genus, so I decided to test it over a period of a few days. It ended up being delicious and comprised a great many of my deserts from then on. But if the berry had been extremely poisonous, I would not have been harmed by the following test suggested by William E. Harmon.

**WARNING! DO THIS AT YOUR OWN RISK!**

**I DO NOT RECOMMEND THIS UNLESS YOU ARE AWARE OF COMMON POISONOUS PLANTS AND ESPECIALLY COMMON POISONOUS MUSHROOMS.**

1. Touch a small piece of the plant to the inner forearm and wait an hour for reactions. If none, proceed.
2. Rub the plant on your inner forearm and wait an hour for reactions. If none, proceed.
3. Touch a small piece of the plant to your tongue and then spit. Wait an hour for reactions. If none, proceed. So far we would have eliminated Jack in the Pulpit or other plants with calcium oxalate crystals, plus most plants causing skin reactions.
4. Take a 1/4 inch by 1/4 inch by as-thin-as-you-can-slice piece of the plant in your mouth, chew it and then spit. Wait an hour for reactions. If none, proceed.
5. Swallow a 1/4 inch by 1/4 inch by as-thin-as-you-can-slice piece of the plant. *Wait twenty-four hours.* If no ill effects, proceed.
6. Swallow a 1/4 inch by 1/4 inch by 1/4 inch piece of the plant. *Wait twenty-four hours.* If no ill effects, proceed.
7. Eat a cubic inch of the plant. *Wait twenty-four hours.* If no ill effects, proceed.
8. Repeat step 7.
9. The plant is probably edible.

However, some plants, such as *gyromitra* spp. mushrooms, contain cumulative poisons, ie, eat a little it's OK but after eating a lot, you get sick. Again, this test is useful once you already know at least some characteristics of the plant in question. I have used this test successfully on several occasions, but I always tested plants I knew at least something about botanically. For example, I successfully tested unknown species of *Russula* mushrooms, *Hypomeces* mushrooms, *Clavaria* mushrooms, several unknown berries from the some known families, but I sure as hell wouldn't try anything from the potato family (*Solonaceae*), which contains deadly nightshade, or from the *amanita* mushroom genus, which contains the death angel etc.



# Troubled Times



## Poisonous Plants

---

From *owner-primitive-skills-group@uqac.quebec.ca* on behalf of Tom Elpel

I think it is safe to experiment with unknown plants as long as you can positively identify the few plants that are absolutely deadly, like water hemlock (Cicuta), hemlock (Conium) and death camas (Zygadenus). (Would anyone add other plants to this list?) As long as you can rule out these few serious plants then it would be somewhat difficult to kill yourself with the rest of the plants out there (although you might make yourself seriously sick).

A better approach than randomly sampling the vegetation is to experiment with unknown plants only in known plant families. Genetically related plants usually have similar characteristics for identification and they often have similar properties and uses. If you know the key patterns of a family then you can recognize a member of that family anywhere in the world.

The Mint Family is an easy example to use in this medium. The plants have opposite leaves (found in pairs with one leaf on each side of the stem, as opposed to alternating along the stem) and distinctly square stalks. (I won't describe the flowers without an illustration).

You do not need to know the precise name of a specimen as long as you can positively identify it as a member of the Mint Family. Most members of the Mint Family are rich in spicy volatile oils, and hence many can be found in the spice cabinet, including: rosemary (Rosmarinus), lavender (Lavandula), marjoram (Origanum), mint, peppermint, and spearmint (Mentha), germander (Teucrium), thyme (Thymus), savory (Satureja), horehound (Marrubium), sage (Salvia-not sagebrush!), and basil (Ocimum).

After giving you this list of names, let me repeat that you do not need to know the individual names of the plants, as long as you can identify the family. Certainly the potency of the volatile oils is going to vary from species to species--some mints have no aroma at all, while others will overwhelm you from ten feet away, but you can identify potency--and hence the uses--with your basic senses, without ever knowing the specific name of a plant.

Granted, not all plant families are as consistent as the Mint Family, but knowing the families will at the very least help you to know which plants to be wary of. For example, the Parsley Family includes many edible plants like carrots, parsley, celery, and most of the spices in your kitchen that are not from the Mint Family. *But*, the Parsley Family also includes the deadly Cicuta and Conium mentioned above. When you identify a plant as a member of the Parsley Family then you know you *must* get positive identification of the specimen.

The essential identifying characteristic of the Parsley Family is the "compound umbell" of the flowers. The flower cluster looks like an umbrella stripped of all the webbing, with the spokes pointing upwards. At the end of each spoke is another smaller "umbrella", again with the spokes pointing upward, but with one small flower at the end of each spoke. (It is really simple once you see an example, and it is so distinctive that you will never forget it.)

There are an estimated 300,000 to 800,000 species of plants in the world, but only about 300 families (many more if you include the subfamilies that are sometimes separated out). Across the northern latitudes there are only about 100 families of plants, which are a whole lot easier to learn than trying to identify all

the tens of thousands of plant species.

One of the problems in teaching primitive skills classes is that some students travel a thousand miles or more to attend a class, so the plants at home may be significantly different than the ones that are taught where the school is. It is somewhat useless to learn specific plants in that circumstance. Learning the families gives you much greater versatility to "know" plants where-ever you are. Dave Wescott at Boulder Outdoor Survival School arrived at a similar conclusion and started teaching families in their programs. He started compiling information on plant families for B.O.S.S. classes, but did not have the time to write a full book on the subject, so I did. Since I do not know of any other amateur-oriented books on plant families I will go ahead and give a plug for mine! The new user-friendly edition is called *Botany in a Day: Thomas J. Elpel's Herbal Field Guide to Plant Families*.



# Troubled Times



## Poke Plant

---

Poke is considered a poisonous plant. It grows all over Northern Virginia. It is a common weed, very, very easy to grow with no fussy requirements. I have seen poke growing in the shade, in the sun, in a dry patch and near to a swamp. Pick the young poke leaves from a plant without berries, enough to fill a pot. Soak them in salt water for a while to be sure the insects come off. Boil the leaves for 5 minutes to remove the toxic material from the leaves and throw that water away. Add more water and boil for about 10 or more minutes more, until the leaves are soft. Drain off most of the water, chop the leaves, place in bowl, season as desired and eat. Very young leaves can be eaten raw in a salad.

The berries of poke are considered mildly poisonous. I do not know why. I have used the crushed poke berries (also called ink berries) as a magenta lip stain for many years with no signs of poisoning. I have also eaten the berries, which taste bland, (not sweet at all) to no ill effect. The berries contain little hard yellow seeds which I have just realized that I should start collecting!

Offered by [Laura](#).

Poke weed is still a staple in the Appalachians. Try a search on Poke, Poke, or Polk and Salad, Salat, or Sallet (so many fun spellings) to see recipes for this common plant.

Offered by [Michael](#).





[Botanical.com Home Page](#)

*Do a Search of complete webpage*

# Dandelion

**Botanical: *Taraxacum officinale* (WEBER)**

**Family: N.O. Compositae**

- [Description](#)
- [Parts Used Medicinally](#)
- [History](#)
- [Cultivation](#)
- [Chemical Constituents](#)
- [Medicinal Action and Uses](#)
- [Preparations and Dosages](#)

---**Synonyms**---Priest's Crown. Swine's Snout.

---**Parts Used**---Root, leaves.



**Common Dandelion**

*(Taraxacum officinale)*

[Click on graphic for larger image](#)

---

The Dandelion (*Taraxacum officinale*, Weber, *T. Densleonis*, Desf; *Leontodon taraxacum*, Linn.), though not occurring in the Southern Hemisphere, is at home in all parts of the north temperate zone, in pastures, meadows and on waste ground, and is so plentiful that farmers everywhere find it a troublesome weed, for though its flowers are more conspicuous in the earlier months of the summer, it may be found in bloom, and consequently also prolifically dispersing its seeds, almost throughout the year.

---**Description**---From its thick tap root, dark brown, almost black on the outside though white and milky within, the long jagged leaves rise directly, radiating from it to form a rosette lying close upon the ground, each leaf being grooved and constructed so that all the rain falling on it is conducted straight to the centre of the rosette and thus to the root which is, therefore, always kept well watered. The maximum amount of water is in this manner directed towards the proper region for utilization by the root, which but for this arrangement would not obtain sufficient moisture, the leaves being spread too close to the ground for the water to penetrate.

The leaves are shiny and without hairs, the margin of each leaf cut into great jagged teeth, either upright or pointing somewhat backwards, and these teeth are themselves cut here and there into lesser teeth. It is this somewhat fanciful resemblance to the canine teeth of a lion that (it is generally assumed) gives the plant its most familiar name of Dandelion, which is a corruption of the French *Dent de Lion*, an equivalent of this name being found not only in its former specific Latin name *Dens leonis* and in the Greek name for the genus to which Linnaeus assigned it, *Leontodon*, but also in nearly all the languages of Europe.

There is some doubt, however, as to whether it was really the shape of the leaves that provided the original notion, as there is really no similarity between them, but the leaves may perhaps be said to resemble the angular jaw of a lion fully supplied with teeth. Some authorities have suggested that the yellow flowers might be compared to the golden teeth of the heraldic lion, while others say that the whiteness of the root is the feature which provides the resemblance. Flückiger and Hanbury in *Pharmacographia*, say that the name was conferred by Wilhelm, a surgeon, who was so much impressed by the virtues of the plant that he likened it to *Dens leonis*. In the *Ortus Sanitatis*, 1485, under 'Dens Leonis,' there is a monograph of half a page (unaccompanied by any illustration) which concludes:

'The *Herb* was much employed by Master Wilhelmus, a surgeon, who on account of its virtues, likened it to "eynem lewen zan, genannt zu latin Dens leonis" (a lion's tooth, called in Latin *Dens leonis*).'

In the pictures of the old herbals, for instance, the one in Brunfels' *Contrafayt Kreuterbuch*, 1532, the leaves very much resemble a lion's tooth. The root is not illustrated at all in the old herbals, as only the herb was used at that time.

The name of the genus, *Taraxacum*, is derived from the Greek *taraxos* (disorder), and *akos* (remedy), on account of the curative action of the plant. A possible alternative derivation of *Taraxacum* is suggested in *The Treasury of Botany*:

'The generic name is possibly derived from the Greek taraxo ("I have excited" or "caused") and achos (pain), in allusion to the medicinal effects of the plant.'

There are many varieties of Dandelion leaves; some are deeply cut into segments, in others the segments or lobes form a much less conspicuous feature, and are sometimes almost entire.

The shining, purplish flower-stalks rise straight from the root, are leafless, smooth and hollow and bear single heads of flowers. On picking the flowers, a bitter, milky juice exudes from the broken edges of the stem, which is present throughout the plant, and which when it comes into contact with the hand, turns to a brown stain that is rather difficult to remove.

Each bloom is made up of numerous strapshaped florets of a bright golden yellow. This strap-shaped corolla is notched at the edge into five teeth, each tooth representing a petal, and lower down is narrowed into a claw-like tube, which rests on the singlechambered ovary containing a single ovule. In this tiny tube is a copious supply of nectar, which more than half fills it, and the presence of which provides the incentive for the visits of many insects, among whom the bee takes first rank. The Dandelion takes an important place among honey-producing plants, as it furnishes considerable quantities of both pollen and nectar in the early spring, when the bees' harvest from fruit trees is nearly over. It is also important from the beekeeper's point of view, because not only does it flower most in spring, no matter how cool the weather may be, but a small succession of bloom is also kept up until late autumn, so that it is a source of honey after the main flowers have ceased to bloom, thus delaying the need for feeding the colonies of bees with artificial food.

Many little flies also are to be found visiting the Dandelion to drink the lavishly-supplied nectar. By carefully watching, it has been ascertained that no less than ninety-three different kinds of insects are in the habit of frequenting it. The stigma grows up through the tube formed by the anthers, pushing the pollen before it, and insects smearing themselves with this pollen carry it to the stigmas of other flowers already expanded, thus insuring cross-fertilization. At the base of each flower-head is a ring of narrow, green bracts the involucre. Some of these stand up to support the florets, others hang down to form a barricade against such small insects as might crawl up the stem and injure the bloom without taking a share in its fertilization, as the winged insects do.

The blooms are very sensitive to weather conditions: in fine weather, all the parts are outstretched, but directly rain threatens the whole head closes up at once. It closes against the dews of night, by five

o'clock in the evening, being prepared for its night's sleep, opening again at seven in the morning though as this opening and closing is largely dependent upon the intensity of the light, the time differs somewhat in different latitudes and at different seasons.

When the whole head has matured, all the florets close up again within the green sheathing bracts that lie beneath, and the bloom returns very much to the appearance it had in the bud. Its shape being then somewhat reminiscent of the snout of a pig, it is termed in some districts 'Swine's Snout.' The withered, yellow petals are, however soon pushed off in a bunch, as the seeds, crowned with their tufts of hair, mature, and one day, under the influence of sun and wind the 'Swine's Snout' becomes a large gossamer ball, from its silky whiteness a very noticeable feature. It is made up of myriads of *plumed seeds* or *pappus*, ready to be blown off when quite ripe by the slightest breeze, and forms the 'clock' of the children, who by blowing at it till all the seeds are released, love to tell themselves the time of day by the number of puffs necessary to disperse every seed. When all the seeds have flown, the receptacle or disc on which they were placed remains bare, white, speckled and surrounded by merely the drooping remnants of the sheathing bracts, and we can see why the plant received another of its popular names, 'Priest's Crown,' common in the Middle Ages, when a priest's shorn head was a familiar object.

Small birds are very fond of the seeds of the Dandelion and pigs devour the whole plant greedily. Goats will eat it, but sheep and cattle do not care for it, though it is said to increase the milk of cows when eaten by them. Horses refuse to touch this plant, not appreciating its bitter juice. It is valuable food for rabbits and may be given them from April to September forming excellent food in spring and at breeding seasons in particular.

The young leaves of the Dandelion make an agreeable and wholesome addition to spring salads and are often eaten on the Continent, especially in France. The full-grown leaves should not be taken, being too bitter, but the young leaves, especially if blanched, make an excellent salad, either alone or in combination with other plants, lettuce, shallot tops or chives.

Young Dandelion leaves make delicious sandwiches, the tender leaves being laid between slices of bread and butter and sprinkled with salt. The addition of a little lemon-juice and pepper varies the flavour. The leaves should always be torn to pieces, rather than cut, in order to keep the flavour.

John Evelyn, in his *Acetana*, says: 'With thie homely salley, Hecate entertained Theseus.' In Wales, they grate or chop up Dandelion *roots*, two years old, and mix them with the leaves in salad. The seed of a special broad-leaved variety of Dandelion is sold by seedsmen for cultivation for salad purposes. Dandelion can be blanched in the same way as endive, and is then very delicate in flavour. If covered with an ordinary flower-pot during the winter, the pot being further buried under some rough stable litter, the young leaves sprout when there is a dearth of saladings and prove a welcome change in early spring. Cultivated thus, Dandelion is only pleasantly bitter, and if eaten while the leaves are quite young, the centre rib of the leaf is not at all unpleasant to the taste. When older the rib is tough and not nice to eat. If the flower-buds of plants reserved in a corner of the garden for salad purposes are removed at once and the leaves carefully cut, the plants will last through the whole winter.

The young leaves may also be boiled as a vegetable, spinach fashion, thoroughly drained, sprinkled with pepper and salt, moistened with soup or butter and served very hot. If considered a little too bitter, use half spinach, but the Dandelion must be partly cooked first in this case, as it takes longer than spinach. As a variation, some grated nutmeg or garlic, a teaspoonful of chopped onion or grated lemon peel can be added to the greens when they are cooked. A simple vegetable soup may also be made with Dandelions.

The dried Dandelion leaves are also employed as an ingredient in many digestive or diet drinks and herb beers. Dandelion Beer is a rustic fermented drink common in many parts of the country and made also in Canada. Workmen in the furnaces and potteries of the industrial towns of the Midlands have

frequent resource to many of the tonic Herb Beers, finding them cheaper and less intoxicating than ordinary beer, and Dandelion stout ranks as a favourite. An agreeable and wholesome fermented drink is made from Dandelions, Nettles and Yellow Dock.

In Berkshire and Worcestershire, the flowers are used in the preparation of a beverage known as Dandelion Wine. This is made by pouring a gallon of boiling water over a gallon of the flowers. After being well stirred, it is covered with a blanket and allowed to stand for three days, being stirred again at intervals, after which it is strained and the liquor boiled for 30 minutes, with the addition of 3 1/2 lb. of loaf sugar, a little ginger sliced, the rind of 1 orange and 1 lemon sliced. When cold, a little yeast is placed in it on a piece of toast, producing fermentation. It is then covered over and allowed to stand two days until it has ceased 'working,' when it is placed in a cask, well bunged down for two months before bottling. This wine is suggestive of sherry slightly flat, and has the deserved reputation of being an excellent tonic, extremely good for the blood.

The roasted roots are largely used to form Dandelion Coffee, being first thoroughly cleaned, then dried by artificial heat, and slightly roasted till they are the tint of coffee, when they are ground ready for use. The roots are taken up in the autumn, being then most fitted for this purpose. The prepared powder is said to be almost indistinguishable from real coffee, and is claimed to be an improvement to inferior coffee, which is often an adulterated product. Of late years, Dandelion Coffee has come more into use in this country, being obtainable at most vegetarian restaurants and stores. Formerly it used occasionally to be given for medicinal purposes, generally mixed with true coffee to give it a better flavour. The ground root was sometimes mixed with chocolate for a similar purpose. Dandelion Coffee is a natural beverage without any of the injurious effects that ordinary tea and coffee have on the nerves and digestive organs. It exercises a stimulating influence over the whole system, helping the liver and kidneys to do their work and keeping the bowels in a healthy condition, so that it offers great advantages to dyspeptics and does not cause wakefulness.

[\[Top\]](#)

**---Parts Used Medicinally---**The root, fresh and dried, the young tops. All parts of the plant contain a somewhat bitter, milky juice (latex), but the juice of the root being still more powerful is the part of the plant most used for medicinal purposes.

**---History---**The first mention of the Dandelion as a medicine is in the works of the Arabian physicians of the tenth and eleventh centuries, who speak of it as a sort of wild Endive, under the name of *Taraxacon*. In this country, we find allusion to it in the Welsh medicines of the thirteenth century. Dandelion was much valued as a medicine in the times of Gerard and Parkinson, and is still extensively employed.

Dandelion roots have long been largely used on the Continent, and the plant is cultivated largely in India as a remedy for liver complaints.

The root is perennial and tapering, simple or more or less branched, attaining in a good soil a length of a foot or more and 1/2 inch to an inch in diameter. Old roots divide at the crown into several heads. The root is fleshy and brittle, externally of a dark brown, internally white and abounding in an inodorous milky juice of bitter, but not disagreeable taste.

Only large, fleshy and well-formed roots should be collected, from plants two years old, not slender, forked ones. Roots produced in good soil are easier to dig up without breaking, and are thicker and less forked than those growing on waste places and by the roadside. Collectors should, therefore only dig in good, free soil, in moisture and shade, from meadow-land. Dig up in wet weather, but not during frost, which materially lessens the activity of the roots. Avoid breaking the roots, using a long trowel or a fork, lifting steadily and carefully. Shake off as much of the earth as possible and then cleanse the roots, the easiest way being to leave them in a basket in a running stream so that the water covers them, for about an hour, or shake them, bunched, in a tank of clean water. Cut off the crowns of leaves, but



be careful in so doing not to leave any scales on the top. Do not cut or slice the roots or the valuable milky juice on which their medicinal value depends will be wasted by bleeding.

[\[Top\]](#)

---**Cultivation**---As only large, well-formed roots are worth collecting, some people prefer to grow Dandelions as a crop, as by this means large roots are insured and they are more easily dug, generally being ploughed up. About 4 lb. of seed to the acre should be allowed, sown in drills, 1 foot apart. The crops should be kept clean by hoeing, and all flower-heads should be picked off as soon as they appear, as otherwise the grower's own land and that of his neighbours will be smothered with the weed when the seeds ripen. The yield should be 4 or 5 tons of fresh roots to the acre in the second year. Dandelion roots shrink very much in drying, losing about 76 per cent of their weight, so that 100 parts of fresh roots yield only about 22 parts of dry material. Under favourable conditions, yields at the rate of 1,000 to 1,500 lb. of dry roots per acre have been obtained from second-year plants cultivated.

Dandelion root can only be economically collected when a meadow in which it is abundant is ploughed up. Under such circumstances the roots are necessarily of different ages and sizes, the seeds sowing themselves in successive years. The roots then collected after washing and drying, have to be sorted into different grades. The largest, from the size of a lead pencil upwards, are cut into straight pieces 2 to 3 inches long, the smaller side roots being removed, these are sold at a higher price as the finest roots. The smaller roots fetch a less price, and the trimmings are generally cut small, sold at a lower price and used for making Dandelion Coffee. Every part of the root is thus used. The root before being dried should have every trace of the leaf-bases removed as their presence lessens the value of the root.

In collecting cultivated Dandelion advantage is obtained if the seeds are all sown at one time, as greater uniformity in the size of the root is obtainable, and in deep soil free from stones, the seedlings will produce elongated, straight roots with few branches, especially if allowed to be somewhat crowded on the same principles that coppice trees produce straight trunks. Time is also saved in digging up the roots which can thus be sold at prices competing with those obtained as the result of cheaper labour on the Continent. The edges of fields when room is allowed for the plough-horses to turn, could easily be utilized if the soil is good and *free from stones* for both Dandelion and Burdock, as the roots are usually much branched in stony ground, and the roots are not generally collected until October when the harvest is over. The roots gathered in this month have stored up their food reserve of Inulin, and when dried present a firm appearance, whilst if collected in spring, when the food reserve in the root is used up for the leaves and flowers, the dried root then presents a shrivelled and porous appearance which renders it unsaleable. The medicinal properties of the root are, therefore, necessarily greater in proportion in the spring. Inulin being soluble in hot water, the solid extract if made by boiling the root, often contains a large quantity of it, which is deposited in the extract as it cools.

The roots are generally dried whole, but the largest ones may sometimes be cut transversely into pieces 3 to 6 inches long. Collected wild roots are, however, seldom large enough to necessitate cutting. Drying will probably take about a fortnight. When finished, the roots should be hard and brittle enough to snap, and the inside of the roots white, not grey

The roots should be kept in a dry place after drying, to avoid mould, preferably in tins to prevent the attacks of moths and beetles. Dried Dandelion is exceedingly liable to the attacks of maggots and should not be kept beyond one season.

Dried Dandelion root is 1/2 inch or less in thickness, dark brown, shrivelled, with wrinkles running lengthwise, often in a spiral direction; when quite dry, it breaks easily with a short, corky fracture, showing a very thick, white bark, surrounding a wooden column. The latter is yellowish, very porous, without pith or rays. A rather broad but indistinct cambium zone separates the wood from the bark, which latter exhibits numerous well-defined, concentric layers, due to the milk vessels. This structure is quite characteristic and serves to distinguish Dandelion roots from other roots like it. There are

several flowers easily mistaken for the Dandelion when in blossom, but these have either *hairy* leaves or *branched* flower-stems, and the roots differ either in structure or shape.

Dried Dandelion root somewhat resembles Pellitory and Liquorice roots, but Pellitory differs in having oil glands and also a large radiate wood, and Liquorice has also a large radiate wood and a sweet taste.

The root of Hawkbit (*Leontodon hispidus*) is sometimes substituted for Dandelion root. It is a plant with hairy, not smooth leaves, and the fresh root is *tough*, breaking with difficulty and rarely exuding much milky juice. Some kinds of Dock have also been substituted, and also Chicory root. The latter is of a paler colour, more bitter and has the laticiferous vessels in radiating lines. In the United States it is often substituted for Dandelion. Dock roots have a prevailing yellowish colour and an astringent taste.

During recent years, a small form of a Dandelion root has been offered by Russian firms, who state that it is sold and used as Dandelion in that country. This root is always smaller than the root of *T. officinale*, has smaller flowers, and the crown of the root has often a tuft of brown woolly hairs between the leaf bases at the crown of the root, which are never seen in the Dandelion plant in this country, and form a characteristic distinction, for the root shows similar concentric, horny rings in the thick white bark as well as a yellow porous woody centre. These woolly hairs are mentioned in Greenish's *Materia Medica*, and also in the British Pharmaceutical Codex, as a feature of Dandelion root, but no mention is made of them in the *Pharmacographia*, nor in the British Pharmacopoeia or United States Pharmacopoeia, and it is probable, therefore, that Russian specimens have been used for describing the root, and that the root with brown woolly hairs belongs to some other species of *Taraxacum*.

[\[Top\]](#)

**---Chemical Constituents---**The chief constituents of Dandelion root are Taraxacin, acrySTALLINE, bitter substance, of which the yield varies in roots collected at different seasons, and Taraxacerin, an acrid resin, with Inulin (a sort of sugar which replaces starch in many of the Dandelion family, *Compositae*), gluten, gum and potash. The root contains no starch, but early in the year contains much uncrystallizable sugar and laevulin, which differs from Inulin in being soluble in cold water. This diminishes in quantity during the summer and becomes Inulin in the autumn. The root may contain as much as 24 per cent. In the fresh root, the Inulin is present in the cell-sap, but in the dry root it occurs as an amorphous, transparent solid, which is only slightly soluble in cold water, but soluble in hot water.

There is a difference of opinion as to the best time for collecting the roots. The British Pharmacopoeia considers the autumn dug root more bitter than the spring root, and that as it contains about 25 per cent insoluble Inulin, it is to be preferred on this account to the spring root, and it is, therefore, directed that in England the root should be collected between September and February, it being considered to be in perfection for Extract making in the month of November.

Bentley, on the other hand, contended that it is more bitter in March and most of all in July, but that as in the latter month it would generally be inconvenient for digging it, it should be dug in the spring, when the yield of Taraxacin, the bitter *soluble* principle, is greatest.

On account of the variability of the constituents of the plant according to the time of year when gathered, the yield and composition of the extract are very variable. If gathered from roots collected in autumn, the resulting product yields a turbid solution with water; if from spring-collected roots, the aqueous solution will be clear and yield but very little sediment on standing, because of the conversion of the Inulin into Laevulose and sugar at this active period of the plant's life.

In former days, Dandelion Juice was the favourite preparation both in official and domestic medicine. Provincial druggists sent their collectors for the roots and expressed the juice while these were quite fresh. Many country druggists prided themselves on their Dandelion Juice. The most active

preparations of Dandelion, the Juice (*Succus Taraxaci*) and the Extract (*Extractum Taraxaci*), are made from the bruised fresh root. The Extract prepared from the fresh root is sometimes almost devoid of bitterness. The dried root alone was official in the United States Pharmacopoeia.

The leaves are not often used, except for making Herb-Beer, but a medicinal tincture is sometimes made from the entire plant gathered in the early summer. It is made with proof spirit.

When collecting the seeds care should be taken when drying them in the sun, to cover them with coarse muslin, as otherwise the down will carry them away. They are best collected in the evening, towards sunset, or when the damp air has caused the heads to close up.

The tops should be cut on a dry day, when quite free of rain or dew, and all insect-eaten or stained leaves rejected.

[\[Top\]](#)

**---Medicinal Action and Uses---**Diuretic, tonic and slightly aperient. It is a general stimulant to the system, but especially to the urinary organs, and is chiefly used in kidney and liver disorders.

Dandelion is not only official but is used in many patent medicines. Not being poisonous, quite big doses of its preparations may be taken. Its beneficial action is best obtained when combined with other agents.

The tincture made from the tops may be taken in doses of 10 to 15 drops in a spoonful of water, three times daily.

It is said that its use for liver complaints was assigned to the plant largely on the doctrine of signatures, because of its bright yellow flowers of a bilious hue.

In the hepatic complaints of persons long resident in warm climates, Dandelion is said to afford very marked relief. A broth of Dandelion roots, sliced and stewed in boiling water with some leaves of Sorrel and the yolk of an egg, taken daily for some months, has been known to cure seemingly intractable cases of chronic liver congestion.

A strong decoction is found serviceable in stone and gravel: the decoction may be made by boiling 1 pint of the sliced root in 20 parts of water for 15 minutes, straining this when cold and sweetening with brown sugar or honey. A small teacupful may be taken once or twice a day.

Dandelion is used as a bitter tonic in atonic dyspepsia, and as a mild laxative in habitual constipation. When the stomach is irritated and where active treatment would be injurious, the decoction or extract of Dandelion administered three or four times a day, will often prove a valuable remedy. It has a good effect in increasing the appetite and promoting digestion.

Dandelion combined with other active remedies has been used in cases of dropsy and for induration of the liver, and also on the Continent for phthisis and some cutaneous diseases. A decoction of 2 OZ. of the herb or root in 1 quart of water, boiled down to a pint, is taken in doses of one wineglassful every three hours for scurvy, scrofula, eczema and all eruptions on the surface of the body.

[\[Top\]](#)

**---Preparations and Dosages---**Fluid extract, B.P., 1/2 to 2 drachms. Solid extract, B.P. 5 to 15 grains. Juice, B.P., 1 to 2 drachms. Leontodin, 2 to 4 grains.

**---Dandelion Tea---**

Infuse 1 OZ. of Dandelion in a pint of boiling water for 10 minutes; decant, sweeten with honey, and

drink several glasses in the course of the day. The use of this tea is efficacious in bilious affections, and is also much approved of in the treatment of dropsy.

Or take 2 OZ. of freshly-sliced Dandelion root, and boil in 2 pints of water until it comes to 1 pint; then add 1 OZ. of compound tincture of Horseradish. Dose, from 2 to 4 OZ. Use in a sluggish state of the liver.

Or 1 OZ. Dandelion root, 1 OZ. Black Horehound herb, 1/2 OZ. Sweet Flag root, 1/4 OZ. Mountain Flax. Simmer the whole in 3 pints of water down to 1 1/2 pint, strain and take a wineglassful after meals for biliousness and dizziness.

#### **---For Gall Stones---**

1 OZ. Dandelion root, 1 OZ. Parsley root, 1 OZ. Balm herb, 1/2 OZ. Ginger root, 1/2 OZ. Liquorice root. Place in 2 quarts of water and gently simmer down to 1 quart, strain and take a wineglassful every two hours.

For a young child suffering from jaundice: 1 OZ. Dandelion root, 1/2 oz. Ginger root, 1/2 oz. Caraway seed, 1/2 oz. Cinnamon bark, 1/4 oz. Senna leaves. Gently boil in 3 pints of water down to 1 1/2 pint, strain, dissolve 1/2 lb. sugar in hot liquid, bring to a boil again, skim all impurities that come to the surface when clear, put on one side to cool, and give frequently in teaspoonful doses.

#### **---A Liver and Kidney Mixture---**

1 OZ. Broom tops, 1/2 oz. Juniper berries, 1/2 oz. Dandelion root, 1 1/2 pint water. Boil in ingredients for 10 minutes, then strain and add a small quantity of cayenne. Dose, 1 tablespoonful, three times a day.

#### **---A Medicine for Piles---**

1 OZ. Long-leaved Plantain, 1 OZ. Dandelion root, 1/2 oz. Polypody root, 1 OZ. Shepherd's Purse. Add 3 pints of water, boil down to half the quantity, strain, and add 1 OZ. of tincture of Rhubarb. Dose, a wineglassful three times a day. Celandine ointment to be applied at same time.

In Derbyshire, the juice of the stalk is applied to remove warts.

[\[Top\]](#)

Purchase from Mountain Rose Herbs

[Dandelion Seeds](#)

[Dandelion Root \(roasted\)](#)

[Dandelion Leaf](#)

[Dandelion Root powder](#)

[Dandelion Root](#)

[Dandelion extract](#)

[Dandelion root capsules](#)

[Common Name Index](#)  
[A MODERN HERBAL Home Page](#)

**Bear in mind "A Modern Herbal" was written with the conventional wisdom of the early 1900's. This should be taken into account as some of the information may now be considered inaccurate, or not in accordance with modern medicine.**

© Copyright Protected 1995-2012 Botanical.com





[Botanical.com Home Page](#)

*Do a Search of complete webpage*

## Scurvy Grass

**Botanical:** *Cochlearia officinalis* (LINN.)

**Family:** N.O. Cruciferae

---**Synonym**---Spoonwort.

---**Part Used**---Herb.

---**Habitat**---Abundant on the shores in Scotland, growing inland along some of its rivers and Highland mountains and not uncommon in stony, muddy and sandy soils in England and Ireland, also in the Arctic Circle, sea-coasts of Northern and Western Europe and to high elevations in the great European mountain chains.



**Scurvy Grass**

(*Cochlearia officinalis* LINN.)

[Click on graphic for larger image](#)

---

---**Description**---It is a small, low-growing plant, annual or biennial, with thick, fleshy, glabrous, egg-shaped, cordate leaves (hence its name of spoonwort). The upper leaves are sessile - lower ones stalked, deltoid orbicular or reniform entire or toothed angularly. Flowers all summer in white short racemes - pods nearly globular - prominent valves of the mid-rib when dry. It has an unpleasant smell and a bitter, warm, acrid taste, very pungent when fresh.

---**Constituents**---Leaves abound in a pungent oil containing sulphur, of the butylic series.

---**Medicinal Action and Uses**---Formerly the fresh herb was greatly used on sea-voyages as a preventative of scurvy. It is stimulating, aperient, diuretic, antiscorbutic. The essential oil is of benefit in paralytic and rheumatic cases; scurvy-grass ale was a popular tonic drink.

The infusion of 2 OZ. to a pint of boiling water is taken in frequent wineglassful doses.

[\[Top\]](#)

[Common Name Index](#)  
[A MODERN HERBAL Home Page](#)

**Bear in mind "A Modern Herbal" was written with the conventional wisdom of the early 1900's. This should be taken into account as some of the information may now be considered inaccurate, or not in accordance with modern medicine.**

© Copyright Protected 1995-2012 Botanical.com



# Troubled Times



## Database

---

Someone donated these plants to us and we are making a [Complete List](#) of edible shrubs. Here is a list of good ones I know so far and they are all good sources of food:

asimina triloba (pawpaw)  
ginkgo biloba  
cornus mas macrocarpa  
cornus kousa  
poncirus trifoliata  
amelanchier obovalis  
akebia quinata  
decaisnea fargesii

ilex verticillata  
hovenia dulcis  
aronia melanocarpa  
schisandra chinensis  
eleagnus multiflora  
phyllostachys  
petasites japonica  
gleditsia triacanthos

Offered by [Hans](#).





# Troubled Times



## Sources

---

Edible and useful plants for arid and semi-arid land by the [Royal Botanic Gardens](#), in French, Portuguese, and Spanish as well as English.

A site by Berglund, Bendt, and Clarke E. Bolsby, recommends the following books:

- *The Complete Outdoorsman's Guide to Edible Wild Plants*, by James A. Duke, published by Charles Scribner's Sons, 1977, New York.
- *Handbook of Edible Weeds*, by Thomas S. Elias and Peter A. Elias. CRC Press, 1992, Boca Raton.



# Troubled Times



## Kudzu

---

### Encarta 97 Encyclopedia

Kudzu, common name of a vine native to China and Japan. The plant is a coarse-growing perennial with large trifoliate leaves having coarsely lobed leaflets. The flowers, borne on long racemes, are large and purple. The fruit is a flat, papery pod covered with a tawny down. Kudzu plants are grown from root cuttings. They produce long, lateral runners that generate roots at intervals.

Kudzu produces edible roots, and the stems yield a fiber called ko-hemp. Since the introduction of kudzu into the United States in 1876, it has become important as a source of hay and forage and for its use in controlling soil erosion. Kudzu is well adapted to the southern United States; in northern regions, other legumes, such as clover and alfalfa, grow more plentifully. As a hay plant, the viny nature of kudzu makes it difficult to harvest, but as pasturage, kudzu is valuable for its high protein and vitamin A and D content. Because of the binding capacity of its long runners, kudzu is valuable in reducing soil erosion. In some places, however, it has spread into forest borders, drainage ditches, and other places, and many farmers and foresters consider it a weed.

Scientific classification: Kudzu belongs to the subfamily Papilionoideae, family Leguminosae. It is classified as *Pueraria lobata*.

### Habitat

*A hardy opportunist, kudzu grows in a variety of habitats and environmental conditions but does best on deep, well-drained, loamy soils. Almost any disturbed area is suitable habitat for this vine. Roadsides, old fields, vacant lots and abandoned yards are all prime spots for new kudzu growth.*

There's a guy in Mississippi that takes the vines and makes baskets and other weavable items out on it.

Offered by [Jon](#).

*In Georgia, the legend says  
That you must close your windows  
At night to keep it out of the house.  
The glass is tinged with green, even so...*  
From the poem, **Kudzu**, by James Dickey

*There's so much of this fast-growing vine in the Southeastern US, you might think it was a native plant. Actually, it took a lot of hard work to help kudzu spread so widely. Now that it covers over seven million acres of the deep South, there are a lot of people working hard to get rid of it! But kudzu is used in ways which might surprise you.*

[Kudzu's History](#)



# Troubled Times



## Edible

---

I have heard that it can be fried like a potato chip. Maybe it could be used like spinach. We might have to eat it someday, you know, when there is nothing else.

Offered by [Ivy](#).

I tasted Kudzu today. It has a normal leafy green flavor and could easily be used as a salad item. No after-taste, no bitterness, your basic lettuce substitute. I was pleasantly surprised! The clippings can be rooted just like ivy; i.e. stick them in a glass of water until roots start to form then plant. It grows all over Georgia and Arkansas. It does destroy everything in it's path. But, I've seen older buildings here in Georgia covered in it that are still standing. Maybe the Louisiana breed is hardier because it is warmer there more months of the year.

Offered by [Leila](#).

If it grows like it does, a new crop every week. It could possibly feed the animals if nothing else. I did some searching on the web and found Janie Sue Yearwood, who says kudzu tastes similar to kale or mustard greens, tells how to add kudzu to your cuisine. And more on growing Kudzu:

*Growing kudzu from seeds is not very practical . It must be done under controlled conditions and requires 2 years to develop crowns which can then be transplanted to field conditions. According to the U. S. **Department of Agriculture** Leaflet No. 91 kudzu has a protein content equal to or better than that of alfalfa and is readily eaten by all kinds of livestock. In addition hogs will eat the starchy roots. Therefore, heavy grazing by livestock can be a means to control or even eradicate kudzu.*

And eating kudzu

*From ancient times to the present days, the root of Kudzu has been commonly used in Far Eastern culture as a food, rich source of starch ... Starch derived from Kudzu Root contains a high amount of iron, a fair portion of calcium and phosphorus, and a little sodium. Interestingly, it has more calories per gram than honey, but unlike honey, which is quick burning sugar, Kudzu is a long sustaining source of energy in an organism. Presently, Kudzu is becoming popular in other places of the world such as the United States, Canada, and Europe.*

And its explosive growth

*Because the plant is a member of the bean family (Fabaceae), the bacteria in the roots fix atmospheric nitrogen and thus help increase soil fertility. Although the vines are killed by frost, the deep roots easily survive the mild winters of the South and produce a new and larger crop of vines each growing season. The vines grow as much as a foot per day during summer months, climbing trees, power poles, and anything else they contact. Under ideal conditions kudzu vines can grow sixty feet each year.*

Offered by [Clipper](#).



# Troubled Times



## Cautions

---

*USA Today*, September 28, 1998, South Carolina

Aiken - An insect called the soybean looper caterpillar may effectively control the spread of a green Kudzu weed that has taken over land, trees and telephone poles near the Savannah River, federal officials say. Herbicides and shading techniques have not eradicated Kudzu, introduced in the U.S. more than a century ago.

*New York Times*, September 7, 1997

[War on Kudzu Weed](#), a Scientific Strategy, by Rick Bragg

"The way you handle something down here is you eat it," Thomas said. "But you'd have to eat fast," and kudzu has never really caught on as a food source for humans. Cows like it. That is how Williams handles it now, in Alabama. But it takes great patience. Cows have to graze it down to the roots for two years to kill it, "but you still see it" creeping, he said.

I am originally from Louisiana. Kudzu is the fastest growing plant I have ever seen. It grows about *2 feet/day*. It grows so fast you can literally see it grow. It grows in anything. You can't kill it. Nothing works. I believe it would even grow in gasoline. You can wipe out one spot, dig down until you think you have gotten it all and two weeks later it pops up 50/100 feet or more away. It just infests the ground. I have no idea of how deep you would have to go to get it all, and believe me I have seen people try. It is a 24 hr. a day job.

I have seen whole farms destroyed because once you get it you can't seem to get rid of it. I actually saw it *pull a house level with the ground* in less than a year. It is almost impossible to get rid of. Gas, insecticide, fire, pesticide, herbicide all seem to have no effect. I know. I have tried. The house was abandoned because the owners could not fight the Kudzu. You see it is a vine that travels underground. The vines don't just cover they actually pull with a force. Imagine a telephone post. You can see a vine cover it but can you really imagine the force that it would take to pull it down. That is exactly what Kudzu does to telephone poles and anything else it latches on to. I never went digging around to see if the boards were still intact under the Kudzu but my family always assumed that the Kudzu had some enzyme that broke down the building material.

I think this can be used as food for both animals and humans because of its fast growth potential but I think that one must be very careful. It could not be used in any type of mud/wood/brick structure. It would dismantle it leveling the ground as it went. Concrete could be used but any small cracks would attract the suckers or tendrils. Once they get a hold, the pulling would start. From the bottom the roots would start to push until the flooring gave way. The pressure would not stop. I know there is a way to make a dwelling Kudzu proof but it will take a great deal of planning.

Offered by [Pat](#).

It takes over the landscape. In the SE, forests go under and die, the vines climbing up and over the trees, and the coverage is not just a couple inches thick, so you could walk through it, it's several feet thick and the trash under is covered. Buildings get covered. Can't walk through it, etc. It's the monster that threatens to cover the South East US! It brings down forests. I mean *brings down!* It climbs up and all over a tree, killing it as not a ray of sunshine gets through, and then the tree rots and topples. The weight of all the Kudzu, and the kudzu vines that string like spider web between the trees too, help flatten the landscape. *all* natural vegetation, man maintained or otherwise, disappears. *All* manmade structures other than sky scrapers also disappear.

Kudzu doesn't just sent up cute little tendrils and curl all by themselves. It is such an aggressive plant that it winds along its own tendrils, as the best place to crawl along. In short order, it has created a web, like a spider web, of vines. As the new vines reach out and attach, this would have the *effect* of pulling anything else that the web was attached to! At first the web is light in weight, then heavier. Also, the vines attach by tendrils curling about, and the very curling motion is a pull, perhaps. Like touching and then making a fist around something. Making the fist may pull *towards* the arm. It was brought into the US from Japan, my understanding, and outside of its natural environment went crazy. They can't stop it. Can't get rid of it. And in due time there will be no orange trees or peach tree groves, no dogwoods under the pine forests - just kudzu.

Offered by [Nancy](#).



# Troubled Times



## Control and Use

---

When Kudzu takes down a house, does the weight build up and break up the house or do the roots pry it apart or is it still intact but just completely covered as the pictures show. I suspect over time a combination of all of the above. I believe covering is the primary effect then root damage then finally weight. After the pole shift, there is a possibility that kudzu can be used by some to advantage. What if one built a house out of supported mud. This plant as it grows up around and over the house would tend to hold it together and camouflage it and provide food. Granted one might have to do a lot of constant trimming to allow for easy access.

With low light conditions I believe this plant will slow way down and have a hard time somewhat like the all the rest of the plants. I also believe where there is food there will be things that eat it. In other words if this grows at all after the pole shift due to change in climate in any particular place, I believe a natural balance will occur where it will attract things that eat it, and keep it under control. I somehow do not fear this plant in terms of long term damage to the environment. The pole shift will do far worse in mixing things up.

If one had this near a monolithic concrete dome. What can be predicted. It would cover it, giving it a nice camouflage appearance. Again the roots with time could tend to break it apart. This could start with any cracks left unrepaired after the pole shift. Do to the reinforcing in the concrete I believe this would take some long time. One would need to keep it from climbing any windmill towers and frequently clear a path to access the dome. The constant maintenance and grooming would be there to guide it in the right direction, away from things that should not be covered. Much of this could be done with the help of livestock or other plant eating animals.

If one really fears it one can make a monolithic dome for growing it only and keep it inside. Giving it only enough light to grow as much as one needs at the time. Will it grow an take over the whole county? I doubt it. A natural balance will be established at some point. I am no expert on this subject. Should we fear it or use it?

Offered by [Mike](#).



# Troubled Times

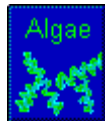

## Primary Source

---

Algae alone does not make for a balanced nutritional profile, but it must be considered as the primary source for food Calories. Additionally, other plants will have to be grown to balance out the nutritional profile, but cannot be considered as primary sources for Calories. For instance, I would not consider grains to be a very high priority because they are mostly starch, but peppers are a rich source of vitamin C, I would consider them a higher priority.

Growing fish, chickens, goats etc. I would consider a low priority because by adding a link in the food chain the efficiency of the overall system is drastically reduced, you see, animals expend a lot of energy throughout their lifecycle which does not go to food production, this makes them very inefficient at converting food energy. Worms however expend very little energy throughout their life cycle making them more efficient, I think this is the case with some mollusks also, insects with exoskeletons might not be the best choice because they move around a lot expending energy and energy goes into the production of the indigestible exoskeleton. The bottom line is prioritizing food production for energy efficiency and nutrient value.

Offered by [Steve](#)



# Troubled Times



## Food Source

---

I've been growing algae for my algae-eater fish in my aquarium. Algae requires light to grow. I don't know what water temperature is best for algae, though I'm sure warm is better than cold. My solution for growing algae is very simply. I've placed two dozen quartz rocks into a five gallon bucket. I've filled the bucket with tap water, and placed the bucket in the backyard in a location that gets the most sunshine. I use quartz rocks so I can see the algae growing on the white rock. As water evaporates from the bucket, I add more water. In two months, the water is probably too alkaline for the algae, so I change out the water. My algae-eater fish love the algae covered rocks.

I was thinking the same thing about algae as a source of food for people. I don't know, can people eat algae?

Offered by [Charles](#).

I don't think algae grow quickly enough to be food under normal circumstances. Not eating algae at all is an option, otherwise change the circumstances. More light and more nutrition in the water would stimulant algae growth. There are cold water and warm water algae, sea water and fresh water algae.

Offered by [Michel](#).

Most definantly. I know of several varieties (spirulina, sun chlorella and super blue-green algae to name a few) that are used in the health food industry to supply minerals, vitamins and other vitally needed basic nutrients. These being classed as super-foods. There may be other varieties. How to grow these is a subject we all need to know more about.

Offered by [Mike](#).





# Troubled Times



## Fully Utilized

---

The mindset should be changed from supplying "food" to supplying "nutrient intake." While these two terms may seem the same, "food" implies a business as usual mindset while "nutrient intake" is a survival mindset. For example, some may be thinking along the lines of a hydroponic garden growing beans. The beans will be harvested, cooked and eaten. The fallacy here is that only the bean is used, 75% of the nutrients are going to be discarded with the rest of the plant and 75% of the nutrients available in the bean are going to be destroyed by cooking. My opinion is that in a true survival mode the problem becomes self correcting since everyone would eventually end up eating the entire plant, raw, roots and all once the onset of starvation became apparent. So, my point here is begin planning from a "survival" mode rather than a "business as usual with some minor inconvenience" mode and, in the case of food, this would be to think in terms of nutrient intake. And yes, that would include worms, bugs and grubs.

Along that line, here are some considerations. I have for many years "survived" on nothing more than about 40 oz. per day of raw vegetable juices supplemented with beans and grains in various forms (cooked, sprouted, juiced wheat grass, soy milk, bread, etc). I would consider myself in excellent health and a side benefit is I don't get sick including colds, flu or anything else. Maintaining one's immune system in the aftertime should not be a small consideration especially if others are depending on one's survival. The vegetables are juiced to extract the nutrients and leave behind the fiber which your body does not need (except in small quantity). Unjuiced, the body labors to extract the nutrients from the fiber and most of the nutrients are lost. Cooking likewise destroys nutrients. My point here is nutrients are necessary for survival, food is not. So, one of my survival tools is a good quality juicer (actually 2 for a back up). Anything that manages to grow in the aftertime conditions (including critters) can be juiced and converted to nutrients and I have hopes that dandelions or other hardy weeds will fit that bill. But I am not counting on that as a solution but it is something everybody should think about. A durable quality juicer for \$350 is the **Green Life** juicer. It is plastic but very durable. Next in line would be the all stainless steel Norwalk for \$2000. Juice quality of the Green Life is equivalent to the Norwalk.

Offered by [Gary](#).



# Troubled Times



## Nutrient Producer

---

As a solution to nutrient production, here are some of the problems I considered:

1. Renewable source.
2. Need to provide all essential nutrients.
3. Must have resources available to produce in aftertime conditions.
4. Must be simple. Consider this, any nutrient production will entail a system. Any system efficiency is the product of the efficiency of the components. Thus, if a system has 4 components and each one is 80% efficient then the efficiency of the system is only 41% (80% x 80% x 80% x 80%). Keep it simple and efficient.
5. Along with #4, any production system must be easily recovered from the inevitable catastrophe. Murphy's Law would say something will go wrong.

What I have chosen with the problems noted in 1. and 2. above in mind is spirulina cultivation. [Spirulina](#) is easy to cultivate (I have yet to prove this but research indicates it so) and [Provides Most](#) (not all) of the essential nutrients needed to survive. I am not a nutritionist but would really appreciate any input from anybody out there regarding the nutritional values and required daily intake of spirulina and what other supplement might be required. Based on my uninformed research, I have determined that 1.5 oz. per day of dry spirulina will supply most of an adult's daily nutrient requirements. Under ideal conditions, 100 square feet will produce 12 oz. of dry spirulina daily. So the potential is under ideal conditions 100 square feet could produce nutrients for 8 adults. Again, I cannot verify this and would welcome any input from anyone who is more knowledgeable. But before anybody should shrink in disbelief, take your own current diet, remove all the fiber and dry the remaining liquid to a powder. What do you think would be left? Or maybe you think the body needs fat and meat to survive then look at this way, what do cows eat to survive? And what would the non-fiber content of that be in dry weight?

In regards to the problems noted in 4. and 5. above, is that Spirulina requires little in the way of "nurturing." It is supposed to be forgiving in that it will grow within a wide range of it's requirements provided the basics are supplied. Along with 4. above, the production system must be easily recovered from the inevitable catastrophe. The spirulina growing cycle is very short. If there is an "upset" production can resume very quickly. Provide for redundancy. It is never a question of "if" something will go wrong but "when" something will go wrong. Thus, instead of 1 large growing trough, operate 2 or more smaller ones. And always have multiple sources of "seed" stock available. If all the spirulina dies, the game is over. Spirulina "seed" culture can be obtained from the biology dept. of U. of Texas. The recommended strain is Spirulina Plantensis, culture number LB2340.

Offered by [Gary](#).



# Troubled Times



## Aftertime

---

Even with an efficient nutrient producer, one must have resources available to produce in aftertime conditions. Spirulina requires a culture medium to grow. It appears to me an adequate culture medium can be concocted using water, [Wood Ash](#) and/or soil and urine. This is another item I have yet to prove so I don't have a formula yet. But basic ingredients should all be available in aftertime conditions. The medium can be replenished using nothing but urine in a survival mode. Spirulina requires a temperature above 68 F to grow and closer to 85 F or higher for ideal growth. This means if the ambient temperature is below this range then external heating must be supplied. (This is true for all hydroponic systems and many seem to be overlooking this. We aren't all going to end up near the equator post shift). There is an abundance of hard wood in my area so I will be relying on that as a basic source of fuel to supply heat and it should remain useable for a long time even after the trees die. The good news about spirulina is the ideal light requirement for growing is 30% of full sun light. It is possible that spirulina may not require an additional lighting source in aftertime conditions. Still, I will be experimenting with LED lighting to determine the minimum requirement in absolute darkness.

I plan here to build my own standard [LED Modules](#) (straight line sticks that can be spaced variously for testing purposes). The modules will be built with the ability to plug into a central 12v power supply. I am using white Nichia NSPW500BS 3.6v@20mA, 20 degree, 5.6 candle power LEDs and these are being sourced for \$1.50 each if anyone is interested. I have no idea yet how many LEDs might be required per square foot to grow spirulina in total darkness but am looking at this as "supplemental" lighting basically. The lighting will require a DC power source. The LEDs require very little in the way of power but I am planning other power needs for 2000Whr per day (mostly to pump water from my well though I have a manual backup for that also). My [White LED](#) source charges \$1.50 each in minimum quantities of 50.

I have opted for a battery system using a steam powered generator (wood is the available fuel) to recharge the batteries. In any battery powered system, the most important component is the battery. I would recommend using the "industrial" grade of battery (used for electric fork lifts). These have a life near 4,000 recharges. I will size my system to require recharge every 8 days thus 90 recharges per year or potential battery life of well over 15-20 years. I will use 2 batteries in case 1 should fail and would fall back to recharge every 4 days. These batteries are not cheap but for a dependable power supply, that is where to put your money. I live near a manufacturer of these batteries and I think I can get the 12v, 843Ahr (10,000 Whr) battery for about \$1000. (I would suggest you deal with the manufacturer directly or find someone who works in a purchasing department for a business who buys these type of commodities as the wholesale price may be 60% of retail especially if you can transport the battery yourself. This battery weighs about 800 lb. though). I would suggest going for the very long life industrial grade such as the Bulldog and negotiate a price below retail somehow. There is a [Bulldog](#) factory in Wabash, IN.

A wind generator is also possible but I question the reliability of adequate wind speed post shift. What does one do if the wind doesn't blow for a couple of weeks? I would consider wind power a potential minimum backup source and it would probably supply all the needs to use LED lighting under almost any wind speed condition. I will probably go with a 500W generator as a backup to supply LED light power only. Be careful though as most of these machines provide very little output in wind speeds less than 10mph and don't reach their rated output under 25mph.

So basically to grow spirulina requires water, wood ash, urine, a temp >68 F and 30% of full sun light. And this is what I will attempt to prove into a solution.

Offered by [Gary](#).



# Troubled Times

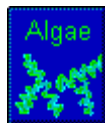

## Spirulina

---

The **Spirulina** company reports:

Spirulina is a blue-green algae that has been living on the planet for 3.6 billion years. ... As one of the oldest living plants on the planet, spirulina has been a source of food for some cultures for centuries. Spirulina is 60% protein, higher than any other food, and is known to assist recovery from malnutrition. ... Spirulina also has the highest level of the protective antioxidant, beta carotene, which is good for the eyes and vision. Rich in Vitamin B-12 and iron, this chlorophyll-rich food contains the rare essential fatty acid, GLA, and, gram for gram, has more calcium and magnesium than other foods. These are essential nutrients for healthy skin and strong bones.

Scientists are discovering unusual phytonutrients in spirulina. The National Cancer Institute has identified compounds in blue-green algae as remarkably active against the AIDS virus. A Russian patent was awarded to spirulina as a medical food for improving the immunity of the "Children of Chernobyl" suffering from radiation illness. ... Animal researchers are also realizing the power of spirulina. Scientists in North Carolina, Japan and China have discovered that small amounts of spirulina added to animal feed greatly help animals resist infections. ...

Earthrise Farms, located in the remote California desert, is the world's largest spirulina farm. Producing over 300 tons a year, Earthrise Spirulina is grown without pesticides and processed without preservatives. Rigorous quality control tests ensure farm cultivated spirulina exceeds all US and international food quality standards.

### EarthNet

424 Payran Street  
Petaluma, CA 94952 USA.  
Tel: 707-778-9270  
Fax: 707-778-1572



# Troubled Times



## Spirulina Algae

---

Spirulina is a type of Blue-Green Algae.

### Botanical Names

*Spirulina maxima*, *Spirulina platensis*

### Health Benefits of Spirulina

Spirulina suppresses the proliferation of *Candida albicans*. Spirulina (1 gram per day) inhibits Leukoplakia (a pre-cancerous condition that can lead to Mouth Cancer). Spirulina enhances the production and activity of Macrophages. Spirulina enhances the function of NK Lymphocytes. Spirulina enhances the production and activity of Phagocytes. Spirulina reduces total serum Cholesterol levels and lowers LDL Cholesterol levels. Spirulina alleviates Hypoglycemia by increasing Blood Sugar levels and increasing the endogenous production of Insulin (due to Glycogen). Spirulina Enhances the Function of Cytokines. Spirulina increases the production of Interleukin 1 Spirulina stimulates the body's production of Adrenaline.

### Spirulina Contains (mg of Substance per 100 grams)

Amino Acids: 66,000 Alanine Arginine  
Aspartic Acid Cystine  
Glutamic Acid Glycine  
Histidine Proline  
Serine Tyrosine  
Isoleucine Leucine  
Lysine Methionine  
Phenylalanine Threonine  
Tryptophan Valine  
Carbohydrates: 14,700 Glycogen  
Carotenoids Beta-Carotene 250 Xanthophyll  
Enzymes: Superoxide Dismutase (SOD)  
Lipids: Gamma-Linolenic Acid Alpha-Linolenic Acid  
Arachidonic Acid  
Minerals: 7,200 Cobalt Trace Iron 28.5  
Calcium Gluconate 110 Magnesium 160  
Potassium Phosphorus 800  
Chlorine 420 Manganese 2  
Zinc 3 Bismuth Trace  
Selenium Trace Germanium  
Proteins: 50,000 Chromoproteins: Chlorophyll  
Phycocyanin  
Vitamins: Biotin Vitamin B1 5.5  
Vitamin B2 4 Vitamin E 19  
Vitamin B3 12 Vitamin B6 0.3  
Vitamin B5 1.1 Inositol 35  
Folic Acid 50 mcg Vitamin A  
Vitamin B12 160 mcg



# Troubled Times

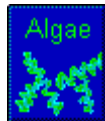

## Immunity Boost

---

The **Spirulina Company** report on an article.

Sacramento, CA, March 5, 1995- *The 44th Western Poultry Disease Conference*

Scientists announced the natural food spirulina dramatically strengthens the immune system. Immunologist and Professor M.A. Qureshi, PhD, released a study sponsored by Earthrise Company of California. "Immunomodulatory Effects of Spirulina Supplementation in Chickens" 1,2 shows small daily doses of spirulina in a poultry diet (less than 1%) greatly improve T-cell and thymus function. Spirulina especially boosts cells called macrophages, the first line of body defense. These cells communicate with T-cells to coordinate the fight against infections.

Spirulina caused the cells to increase in number, be more active and display more effective microbial killing. The whole immune system array of killer cells, helper cells and antibody production is supercharged. This means spirulina fed birds are much more resistant to infection, with no undesirable side effects.

Researchers are testing the theory that spirulina acts like a broad spectrum vaccine against bacteria. It may also protect against other disease causing microbes and cancer. Because it is a safe natural food, it has created a sensation among animal scientists. They are scrambling to replace ineffective antibiotics with probiotics like spirulina that strengthen immune systems and prevent disease.

Scientists in China and Japan independently reported spirulina and its extracts fed to mice increase macrophage function, antibody production and infection-fighting T-cells. 3,4,5 One study found spirulina extracts inhibited cancer by boosting the immune system.6 The active phytonutrients are a *polysaccharide* (a complex sugar molecule) unique to spirulina and *phycocyanin* (the blue pigment found only in blue-green algae). In 1979, Russian scientists published initial research on the immune stimulating effects on rabbits from *lipopolysaccharides* in spirulina.7

These discoveries are significant for human health. Overused antibiotics have created highly resistant bacteria. Most antibiotics are no longer effective. Now scientists want to identify probiotics that strengthen the immune system to prevent disease and cancer. Based on this animal research, as little as 3 grams per day of spirulina may be effective for humans. It seems to turbocharge the immune system to seek out and destroy disease causing microorganisms and cancer cells.

Spirulina, blue-green algae, is 60% all-vegetable protein, easy-to-digest, with the highest food concentration of the antioxidant beta carotene, iron, vitamin B-12, and the rare gamma-linolenic acid (GLA). Its dark green color comes from the combination of the phytonutrients carotene, chlorophyll and phycocyanin. It is also a source of polysaccharides and sulfoglycolipids. In the past 15 years, this nutritious microscopic aquatic plant has gained worldwide acceptance.

Spirulina is a safe whole food consumed by traditional people for centuries. It has been enjoyed by millions of people as a natural food in the USA, Japan and Europe. **Earthrise Farms**, the world's largest spirulina farm located in the sunny California desert, produces over 300 tons per year. The immune enhancement study with chickens used spirulina ecologically grown at Earthrise Farms free of pesticides.

### References:



Immunomodulatory effects of spirulina supplementation in chickens. by M. Qureshi, et al. May 1995. North Carolina State. Pub. in **Proc. of 44th Western Poultry Disease Conference**, pp 117-120. USA.

Immune enhancement potential of spirulina in chickens. by M. Qureshi, et al. August 1994. Poultry Science Assoc. Dept. of Poultry Science, North Carolina State, NC. Pub. in **Journal of Poultry Science** Vol 73, S.1. p. 46. USA.

Study on effect and mechanism of polysaccharides of spirulina on body immune function improvement. by G. Baojiang, et al. April 1994. South China Normal Univ. China. Pub. in **Proc. of Second Asia Pacific Conf. on Algal Biotech**. Univ. of Malaysia. pp 33-38. China.

Effects of polysaccharide and phycocyanin from spirulina on peripheral blood and hematopoietic system of bone marrow in mice. by Zhang Cheng-Wu, et al.. April 1994. Nanjing Univ. China. Pub. in **Proc. of Second Asia Pacific Conf. on Algal Biotech**. Univ. of Malaysia. p.58. China.

Enhancement of antibody production in mice by dietary spirulina. by Hayashi, et al. June 1994. Kagawa Nutrition Univ. Japan. Pub. in **Journal of Nutr. Science and Vitaminology**. Japan.

Inhibitive effect and mechanism of polysaccharide of spirulina on transplanted tumor cells in mice. by Lisheng, et al. 1991. Pub. in **Marine Sciences**, Qingdao, N.5. pp 33-38. China.

Immunostimulating activity of lipopolysaccharides from blue-green algae. by L. Besednova, et al. 1979. Pub. in **Zhurnal Mikrobiologii, Epidemiologii, Immunobiologii**, 56(12) pp 75-79. Russia.



# Troubled Times



## Reduces Allergies

---

The **Spirulina Company** reports on January 2, 1995:

A Russian patent was awarded for the use of spirulina as a medical food for improving immunity of the Children of Chernobyl. Studies showed that 270 children, living in highly radioactive areas, had chronic radiation sickness and elevated levels of Immunoglobulin E (IgE), a marker for high allergy sensitivity. Thirty five pre school children were prescribed 20 spirulina tablets per day (about 5 grams) for 45 days. Consuming spirulina lowered the levels of IgE in the blood, which in turn, normalized allergic sensitivities in the body.

Spirulina is a safe whole food consumed by traditional peoples for centuries. It has been enjoyed by millions of people as a natural food supplement in the USA, Japan and Europe for over 15 years. This edible blue-green algae is 60% all-vegetable protein, easy-to-digest, with the highest food concentration of beta carotene, iron, vitamin B-12, and the rare gamma-linolenic acid (GLA). A growing number of scientific studies have documented its immune enhancement benefits.

Spirulina for this research was grown at Earthrise Farms in California, and was donated by Earthrise Company and Dainippon Ink & Chemicals of Japan. Since 1990 Earthrise has donated spirulina to radiation clinics for the Children of Chernobyl. Earthrise Farms, the world's largest spirulina farm located in the sunny California desert, has produced over 1200 tons since 1982, ecologically grown without pesticides.

### Reference:

Means to normalize the levels of immunoglobulin E, using the food supplement Spirulina. by L. Evets, et al. 1994. Grodenski State Medical Univ. Russian Federation Committee of Patents and Trade. **Patent (19)RU (11)2005486**. Jan. 15, 1994. Russia.



# Troubled Times

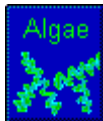

## Articles & Books

---

### **Earth Food Spirulina**

4th Edition 1997, by Robert Henrikson, who pioneered algae as a world resource for 20 years, and is the President of a major algae company and a director of the world's largest spirulina farm. This easy-to-read book has over 160 charts, tables and photographs. Pub. by Ronore Enterprises, Inc. PO Box 1188, Kenwood, CA 95452 USA. Clean water, bubbling CO<sub>2</sub> up through the water; using mineral nutrients like nitrogen, potassium, iron and essential trace elements rather than manure; avoiding chemical weed treatment by controlling and balancing the pond ecology; large paddlewheels in each pond.

### **Spirulina National Symposium (India)**

by C.V. Seshadri and N. Jeeji Bai. 1992. Pub. by Shri Amm Murugappa Chettiar Research Center (MDRC), Madras, India.

### **Algoculture: Spirulina, hope for a hungry world**

by Ripley D. Fox. 1986. Pub. by Edisud, Aix-en-Provence, France (in French).

### **Biotechnology & Utilization of Algae: The Indian Experience**

by L.V. Venkataraman and E.W. Becker. 1985. Pub. by Sharada Press, Mangalore, India.

### **Production of high quality spirulina at Earthrise Farms**

by Amha Belay and Yoshimichi Ota. 1994. Pub. in Proc. of Second Asia Pacific Conference on Algal Biotech. Univ. of Malaysia. USA.

### **Spirulina, Algae of Life**

April 1993. Bulletin Special No. 12. Pub. by Institute Oceanographique, Monaco.

### **Spirulina. A Good Health Guide**

by Jack Joseph Challem. 1981. Pub. by Keats Publishing, New Canaan, CT. USA.

### **Spirulina, the Whole Food Revolution**

by Larry Switzer. 1982. Pub. by Bantam Books, NY. USA.

### **The Spirulina Cookbook**

by Sonia Beasley. 1981. Pub. by Univ. of the Trees, Boulder Creek, CA. USA.

### **The Spirulina Diet**

by Sandra Howard. 1982. Pub. by Lyle Stuart, Secacus, NJ. USA.



# Troubled Times

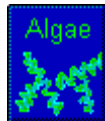

## Chlorella

---

Chlorella is a form of unicellular Green Algae found in still, fresh water; or soil, or bark of trees.

### Botanical Names

*Chlorella pyrenoidosa*, *Chlorella vulgaris*

### Health Benefits of Spirulina

Some studies suggest that Chlorella may be useful for lowering Blood Pressure in people afflicted with Hypertension. It is claimed by some researchers that Chlorella (8 grams per day) can detoxify persons affected with Cadmium poisoning. Chlorella prolongs survival times in persons afflicted with various forms of Cancer (by boosting the Immune Response, i.e. not by directly killing Cancer cells). Chlorella prolongs survival times in persons afflicted with Breast Cancer and Leukemia (by boosting the Immune Response, i.e. not by directly killing Cancer cells). Recently (1998), Chlorella (*Chlorella vulgaris* species) has also been shown to contain a Glycoprotein (named CVS) that inhibits the metastasis of some forms of Cancer. Chlorella facilitates the production of Granulocyte-Macrophage Colony-Stimulating Factor (GM-CSF). Chlorella facilitates the production of Interferon Gamma. Chlorella facilitates the production of Interleukin 1 (Interleukin 1 alpha form).



# Troubled Times



## Super Blue Green

As reported, the **Cascade Mountains** variety:

Algae have been used as vital staple foods in human dietary traditions throughout the world. Most well known are the many ocean algae, commonly called "seaweeds" or "sea vegetables" traditionally eaten by coastal peoples of both the East and West. Freshwater algae also formed an important part of many culinary traditions, such as in parts of Africa and Central America. However, unlike the case with seaweeds, by the time we discovered this most ancient miracle, all the viable natural sources for harvesting freshwater algae were either too polluted or too ravaged by drought to serve any purpose.



Then, in the early 1980s, a single researcher discovered one overlooked, solitary source for the most remarkable blue-green algae of all, *Aphanizomenon flos-aquae* - and he found it growing organically and abundantly in the wild, within the United States, in an environment that is in the pristine environment of the Cascade Mountains - and, in fact, is the richest biomass producer on the planet.



# Troubled Times

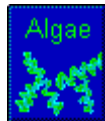

## Cell Tech

---

As reported by *Cell Tech*:

Freshwater algae is sensitive to light and heat. If the algae is exposed to heat during harvesting, transport, or processing, it quickly loses much of its nutritional value. By building an on-site processing facility, Cell Tech has defeated these obstacles, allowing us to quickly "lock in" 97% of SBGA's original nutrients.



# Troubled Times

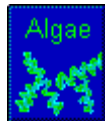

## Klamath Lake

---

As reported, located in Oregon:

Klamath Lake Algae (KLA) contains no artificial ingredients or additives. It grows naturally in Oregon, USA. There are no preservatives in this product. It has a very high protein content of at least 60% with an amino acid profile almost identical to that required for human consumption. This intensely nutritious whole food contains a comprehensive natural spectrum of minerals and vitamins. It possesses the most extensive known source of chlorophyll and is also high in the B vitamins, including B12, as well as in Beta Carotene. ... Klamath Lake Algae's vitamin profile is an exceptionally well-balanced complete single complementary food. ... Klamath Lake Algae contain's a full spectrum of chelated (organically bound) minerals due to its unique environment source.



# Troubled Times

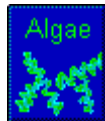

## Sea Vegetables

---

Sea vegetables (for our purpose) consists of edible seaweed and mosses. They have played an important role in the cuisine of traditional societies for thousands of years. Sea vegetables are classified by color into four families: Green Algae, Brown Algae, Red Algae, and Blue/Green Algae. Stretching back to ancient times, these algae have been harvested from oceans, lakes, and rivers for daily consumption. In the Far East, seaweed with names like Kombu, Wakame, Hijiki, Arame, Nori, and several other marine and fresh water varieties are gathered and sold around the world.

In the British Isles, harvested varieties included Tangle, Irish Moss, Sea-Whistle, Dulse, Driftweed, Purple Laver, and Sea Cabbage. Until very recent times, these and other varieties were popular among Celtic and English societies. A similar tradition existed in Scandinavia, Russia, Siberia, the Mediterranean region, the Iberian Peninsula, the African coastline, Southeast Asia, Australia, the Pacific Islands, and both the Atlantic and Pacific coastlines of North and South America.

The daily consumption of sea vegetables, however, has practically disappeared from contemporary life. This is all the more a pity because sea vegetables are generally among the least processed natural foods and the safest. While some species are malodorous, tough, or unpleasant to the taste, most varieties sold are pleasant tasting and satisfying. There are no toxic varieties and none are harmful to people or plants. After harvesting, seaweed should be washed immediately to remove the salt, dried quickly outside in the shade, and stored in dark, dry places. Treated this way, it will keep indefinitely. If gathered from clean shores and ocean beds that are far from industrial areas and toxic materials that may have seeped into the water, sea vegetables provide one of the cleanest sources of multiple (trace) minerals, vitamins, and fiber.

Offered by [Ed](#)





# Troubled Times



## Edible Limu

---

In ancient Hawaii the common diet consisted mainly of fish, poi, and limu. Poi consists of pounded taro root and limu is the Hawaiian name for algae. Besides adding variety to an otherwise monotonous diet, limu was a source of valuable vitamins and other mineral elements. Original Hawaiian methods of preparing limu for eating involve cleaning, chopping or pounding it, salting, drying, and serving it uncooked. Limu were also added to stews or put in the imu (underground oven) to thicken meat juices. In modern Hawaii, limu is also prepared in other ways that were introduced by Japanese, Korean, and Chinese immigrants.

Some of the most common edible algae are:

- Scientific name Hawaiian name
- Enteromorpha prolifera 'Ele'ele
- Ulva fasciata Palahalaha
- Codium edule Wawae'iole
- Codium reediae 'A'ala'ula
- Dictyopteris plagiogramma Lipoa
- Sargassum echinocarpum Kala
- Porphyra sp. Pahe'e
- Asparagopsis taxiformis Kohu
- Grateloupia filicina Huluhuluwaena
- Halymenia formosa Lepe 'ula'ula
- Graciliara coronopifolia Manauea
- Ahnfeltia concinna Ko'ele'ele or 'Aki'aki
- Laurencia dotyi, L. succisa Lipe'epe'e
- Laurencia nidifica Mane'one'o

This information was obtained from, *Limu: An Ethnobotanical Study of some Hawaiian Seaweeds*, by Isabella Aiona Abbott.

### **Laurencia sp.**

Some of the most common Laurencia species that can be found in Hawaii are, Laurencia nidifica, L. obtusa, and L.succisa. This genus is generally characterized by cylindrical branches that can be found in a variation of colors. Laurencia nidifica is known as mane'one'o in Hawaiian and is edible.

### **Sargassum sp.**

Both Sargassum polyphyllum and S. echinocarpum can be found in abundance at the Diamond Head tide pools. This type of algae is well known by Hawaiians who call it kala. All of the Sargassum species look very similar with golden to dark brown blades with mid rib arranged in large bunches and found in wave swept rocky areas, in tidepools and on reef flats. These are classified as "brown" (division Phaeophyta) algae and belong to the order Fucales. Sargassum polyphyllum can be distinguished by short spiny projections on the stems. Sargassum echinocarpum can be distinguished by round smooth stems and stalks.

### **Ulva fasciata**

This is one of the most common species of algae in Hawaii and is also known as "sea lettuce" in many parts of the world and as palahalaha in Hawaiian. It belongs to the division Chlorophyta, green algae, and is grass-green

in color. *Ulva* sp. can be found on intertidal rocks, in tidepools, and on reef flats.



# Troubled Times



## Contamination

---

Algae is considered a super food with lots of vitamins and minerals. There is one thing we must master to make this work. We need to be able to keep the algae tank from getting contaminated and growing something else possibly a parasite that would be harmful to consume. The how to quality check and the how to naturally have the tank grow in the right algae food producing way will take some know how.

Offered by [Mike](#).

Check out patent number 4267038: Controlled natural purification system for advanced wastewater treatment and protein conversion and recovery. I am using this as a model to help in the design of a complete sustainable biosystem. It is claimed that the algae produced is sterile. I suppose the water, if put through a tertiary treatment like filtering through sand and ozonisation could be made to be drinkable. The way I understand it, if the conditions are favorable for the strain of algae or any other microorganism you are producing, contamination of the culture is controlled naturally through competitive exclusion.

Offered by [Steve](#)

I had the opportunity to talk to a couple of people who work for the company that makes spirulina a couple of weeks ago. They were quick to point out that the algae growing in my Michigan pond was not what they were selling, nor was it what you would get in those many pills that are out there. There are many forms of algae of which spirulina is but one, and some algae are poisonous to humans.

Offered by [John](#).



# Troubled Times



## Dried Algae

---

Some manufacturers of the Chlorella use a mechanical cracking process that cracks the cell open so that it will digest more easily in humans. If you have a choice try to stay away from these brands as they probably won't have as many live cells. I believe if my memory is correct it was in Japan where the mechanical cell cracking was developed.

Note: You can get spirulina at \$25/lb. from Pacific Botanicals, 4350 Fish Hatchery Rd., Grants Pass, OR 97527, or call (541) 479-7777. It is sold as a food supplement. This place has high quality organic and wild crafted herbs at a reasonable price also. Their statement is

Our Spirulina is grown in Hawaii in man made ponds lined with food grade plastic. It is carefully cultured in pure water and fed vitamins and minerals to give optimum nutrition. Each lot is tested for E. coli and aerobic plate counts. Beta carotene is almost twice that of any other Spirulina grown. This is due to a unique low oxygen drying technique which also preserves other nutrients such as B vitamins.

I don't know how alive it is other than the above statements.

Offered by [Mike](#).



# Troubled Times

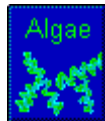

## Live Algae

---

The University of [Texas Botany](#) Department maintains a culture collection, which I guess is where most of us might try and get a spirulina culture to start out with. There don't seem to be too many places that have spirulina platensis or spirulina maxima, two forms of spirulina that the good doctor says she has grown. It would be nice if Dr. Solowey could create a web site showing in detail how to do everything. Yesterday I received two small packages from [Dr. E.M. Solowey](#) with information on spirulina. I will be reading it and so far the information seems pretty good. I am sure that she would be happy to send you that same information.

### **Efficiency of Sunlight Utilization: Tubular Versus Flat Photobioreactors**

Mario R. Tredici, Graziella Chini Zittelli

The species used, *Phaeodactylum tricornutum* UTEX 640, was supplied by the University of Texas at Austin. ... Although it is a freshwater strain, it is able to tolerate high salinity (Yongmanitchai and Ward, 1991). Nutrient concentrations for the outdoor operation were successively increased to avoid growth limitation; a tripled concentration ensured nutrient-saturated growth.

Offered by [Glenn](#).



# Troubled Times



## Indoor Ponds

---

I have found two web sites that dispel the myth that school children cannot grow spirulina and do it well. In fact, one of those websites discusses a Helical Tubular system which looks very easy to build. And I imagine it could be built for less than \$500. The students are using it to study carbon dioxide removal but they are using spirulina to do that. I hope that I can learn enough to design a system that feeds me.

Also, you might be interested to visit the following web address. This is a company that sells Tubular Photobioreactors and I have to say I am impressed with the info they sent me in the mail however, as always, the cost of their system may be very high (they did not list prices) but I think one could build their own system modeled after something like this for a fairly low price. In this article there is a neat little diagram of an air lift system. As you know, the shearing effect on the spirulina cells in typical pump systems has a negative impact and therefore it seems like many systems opt for the air lift pump, which uses compressed air to “lift” the water. Also, this system features a cooling/heating mechanism which could be important in outdoor environments.

### **A Model for Light Distribution and Average Solar Irradiance Inside Outdoor Tubular Photobioreactors for the Microalgal Mass Culture** excerpts, by FG Acie´ n Ferna´ ndez, F Garcı´ a Camacho, JA Sa´ nchez Pe´ rez, JM Ferna´ ndez Sevilla, E Molina Grima

Industrial-scale biomass production of highly valuable chemicals, such as those used in the fine-chemical and phar-maceutical industries, is today one of the most important challenges facing microalgal biotechnology (Ben-Amotz and Avron, 1989). Until a few years ago, this production was carried out in quasiartisan facilities essentially made up of open ponds. These ponds were later improved with temperature control systems, supplies of appropriate nutrients, optimization of pond depth, CO<sub>2</sub> injection systems, etc. In spite of these improvements, productivity remained fairly low, moreover, only the production of certain microalgal species was pos-sible. Closed reactors soon began to appear for large-scale production of the so-called “sensitive” strains with higher productivities (Richmond, 1990).

Many very different designs for a reactor of this kind such as outdoor open ponds (Terry and Raymond, 1985), vertical alveolar panels (Tredici and Materassi, 1992), flat plate reactors (Ratchford and Fallowfield, 1992), tubular reactors (Pirt et al., 1983; Gudın and Thepenier, 1986; Richmond et al., 1993), etc., have been proposed. Among them, the tubular photobioreactor, in which the circulation of fluids is induced by bubbling air, allows better control of the culture variables, enabling higher productivities, and reducing power consumption and cellular stress (Gudın and Chaumont, 1991; Molina Grima et al., 1994c).

Both photobioreactors are made of Plexiglas with an airlift system to recirculate the fluid and an external loop which acts as solar receiver submerged in a thermostatic pond of water. The walls of the pond were unpolished and painted white to increase the reflection of the solar radiation. The air-lift was made up of a degasser in which the dissolved oxygen, pH, and temperature probes were in-serted, all of them connected to an on-line control unit and a computer for data monitoring and backup (Molina Grima et al., 1994c, 1995).

Offered by [Glenn](#).

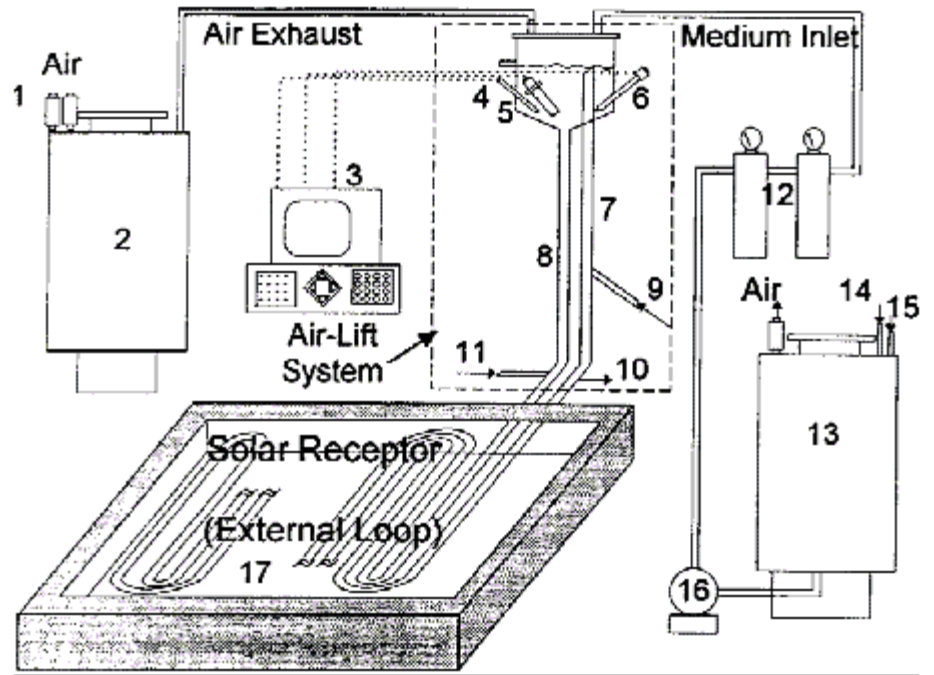

**Figure 1.** Scheme of outdoor culture system. (1) Air filters, (2) harvest tank, (3) control unit, (4) temperature sensor, (5) dissolved O<sub>2</sub> probe, (6) pH probe, (7) riser, (8) downcomer, (9) air injection, (10) sampler, (11) CO<sub>2</sub>, (12) medium sterile filters, (13) fresh medium, (14) nutrient inlet, (15) sea water inlet, (16) pump, (17) thermostatic water pool.

# Troubled Times

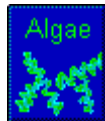

## Lighting

### Efficiency of Sunlight Utilization: Tubular Versus Flat Photobioreactors, excerpts

Mario R. Tredici, Graziella Chini Zittelli

The importance of the light saturation effect in outdoor algal cultivation was recognized very early. Burlew (1953), in the introduction to the famous book *Algal Culture: From Laboratory to Pilot Plant*, referred to this phenomenon as “the challenge of light saturation,” and suggested two different strategies to overcome it: turbulent mixing and spatial light dilution. Spatial dilution as a means to overcome the light saturation effect and limit damages due to strong light is a strategy commonly adopted by phototrophs in nature, especially among the higher plants which, being fixed in space, are much more endowed than microalgae to cope with excessive light. Whereas phytoplankton in natural waters essentially adopt avoidance strategies (van Liere and Walsby, 1982), plants have developed a very complex array of responses to light of excessive intensity (Long et al., 1994; Powles, 1984). Among these, the reduction of the chloroplast surface area exposed to strong light plays a relevant role.

This strategy is implemented through rapid movements of chloroplasts within the cells, by changing the leaf angle, through leaf flutter, or, more efficiently, by adopting a special canopy architecture that distributes the impinging PPF as uniformly as possible over the leaves and minimizes the fraction of leaves that are exposed to PPFD levels above saturation (Nobel et al., 1993; Powles, 1984). Particularly relevant to the objective of this study is the consideration that the leaf area index (i.e., the leaf area per unit land area) is often much greater than 1 (e.g., some coniferous canopies support leaf area indexes higher than 15). This means that plant leaves usually do not receive orthogonal rays of light and a moderate PPFD of a few hundred micromoles of photons per sq. meter per second can occur at the top of the canopy even with full sunlight overhead (Nobel et al., 1993).

Unlike plants and phyto-plankton, microalgae cultivated outdoors in artificial basins or photobioreactors experience a rather unnatural and stressful situation, because turbulence forces the cells to move back and forth along the "dense" profile of the culture and subjects them to short-term fluctuations in light intensity from full sunlight to complete darkness. When these shade-adapted cells are brought to the surface by mixing and exposed to high PPFD, they achieve lower photosynthetic efficiencies than they are potentially able to achieve and can even suffer severe damage (photoinhibition). Artificial algal cultures, like terrestrial plants, thus have to compromise between maximizing light interception to attain maximum volumetric productivity and reducing excessive light to achieve high light conversion efficiency.

The experiments described in this article demonstrate that dilution of excessive light, achieved through a particular arrangement or shape of the reactor, can lead to significantly higher light conversion efficiency and, consequently, to higher productivity under both artificial and natural illumination. It is expected that the higher the light intensity or the higher the dilution factor, the higher the beneficial effect of spatial light dilution.





# Troubled Times



## pH Balance

---

One of the good things about spirulina is the particular growth conditions that it prefers. What I mean is a pH of around 9.5 (most hydroponics systems are kept at a pH of only 6.5 or so!). However, this is a blessing in disguise because if the pH of the nutrient medium in which the spirulina grows is kept *high* then this will (I have read) discourage other forms of algae from taking root in the medium.

I have also read that Chlorella (another algae which people consume) does not have this high pH requirement and therefore it is more difficult to keep the growing medium monoalgal (all the same algae). Also Chlorella's cell wall is indigestible for us and so commercial growers must crack this cell wall using some type of process. And also I have read (all of this in Robert Henrickson's *Earthfood Spirulina*) that Chlorella is harder to harvest because the cells are small and so they cannot be "screened" through a filter like spirulina. They have to be centrifuged in some way and therefore spirulina seems to be much easier to get started with than Chlorella.

Offered by [Glenn](#).



# Troubled Times

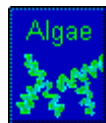

## Grow My Own

---

Leila Loomis and Robert Henrickson both have discouraged me from trying to grow spirulina because they say that it requires a great deal of technical expertise but they also say that since we are dealing with a micro organism then contamination can be a big problem. This is a wonderful food and should be able to be grown by normal people, but **when we give step-by-step instructions to people they should be aware they might end up eating contaminated algae**. I don't think any of this is going to stop me from trying to grow my own algae, but there are some issues with regard to quality control and scientific testing that should not be swept under the rug. Leila says that the testing is very expensive.

Offered by [Glenn](#).



# Troubled Times



## Without Sunlight

---

### Scientists Alter Algae to Grow Without Sunlight

Reuters, June 14, 2001

Scientists said on Thursday they had genetically engineered a type of algae to grow without sunlight, a breakthrough that could cut the cost of growing the single-celled plant used in dietary supplements. The addition of a single gene caused the algae to give up sunlight as its primary energy source - a process known as photosynthesis - and use glucose, a sugar, instead, researchers said in a study appearing in the journal *Science*. Commercial cultivation of algae is typically done in large outdoor ponds, where contamination by microbes and variations in sunlight and temperature can reduce the quality and quantity of the plants, the scientists said. "Eliminating contamination means that the algae can be produced at a high purity for pharmaceutical applications or dietary supplements," said study co-author Kirk Apt of Martek Biosciences Corp. In addition to dietary supplements such as beta-carotene and the fatty acid DHA, algae is used in fluorescent pigments for scientific labeling and in food for commercial fish farms.

The scientists said they also found that the gene-altered algae grew at 15 times the density of sunlight-grown algae, partly because the algae in outdoor ponds can shade each other, restricting the available light. To get the algae called *Phaeodactylum tricorutum* to feed off glucose or another carbon compound instead of sunlight, a single gene from either human red blood cells or another type of algae was inserted, they said. These so-called glucose transporter genes changed the metabolism of the algae into glucose eaters, allowing them to grow in darkness. The scientists said future efforts to change the metabolism of plants through genetic engineering likely would be more complicated than just adding a single gene. *P. tricorutum* was primed for the change because it has the complete cellular pathway for breaking down glucose "preinstalled" and the additional gene simply allowed the plant to take advantage of its own biology, they said.

This algae without light seems like a great idea, but I have a feeling it's coming to late, meaning how quick will it make to any kind of marketplace. This is an engineered organism so I don't think we'll see it any time soon. Also, trying to grow one type of organism is always a challenge. Keeping competitors out would be tough, especially post pole shift. I think we are better off trying yeast, it essentially does the same thing (eats sugar without needing light). But if we have sugar why wouldn't we just eat it ourselves. In my opinion we should concentrate on algae, provided we can supply the light. We can feed it to our ducks, chickens, fish etc.

Offered by [Stan](#).



# Troubled Times



## Sugarroot

---

Sugarroot (*Sium sisarum*) is native to middle Europe, Russia and China. In the north of Italy it lives generally everywhere. The plant grows in the wild in a moist environment. Sugarroot has got a white, aromatic tuberlike root. It's stem is 45 cm long, it's has feathery leaves and small white flowers which normally bloom in late summer. Since the 16th century Sugarroot is grown in western Europe for it's edible roots. These roots are nutritious and have a positive effect on the digestive track. It purifies. It also can work as a laxative and diuretic. The young sprouts are very pleasant in taste and are very healthy for the body, in general! In this day and age the sweet tasting roots are first boiled, and then served with some butter. Sugarroot can be grown in soil, in the sun as well as in the shadow.

Offered by [Michel](#).



# Troubled Times



## Weeds

---

Post pole shift forage plants:

**Dandelions** grow in shade and sun. I eat the leaves all year, contrary to what the books say which is to eat them when tender in the spring. I find them almost everywhere I travel. Our Chippewa neighbors say they came with the white man but that they instantly figured out what to do with them.

**Pigweed.** Anybody eat pigweed?

**Lambs Quarters**, in fact all the goose foots are favorites of mine. Mild flavor

**Nettles** love shade and really wet conditions. According to Karate lore Masutatsu Oyamu would live on nettles and fresh water each summer living in a cave. When the tree he worked out on fell over he would return to town. My wife says you have to put them in boiling water first to keep them from stinging your mouth.

**Purslane** grows everywhere and is high in EFA's.

A friend of mine found a big **Puffball** once and ate it for weeks, slicing some off each day, frying and eating it raw.

In this part of the country wild **Leeks** are common in mature woods and a sign that **Morel** mushrooms might be nearby.

**Garlic Mustard** grows in the shade. It is an invasive pest plant around here.

**Plantain** grows on the shady side of our house. The seed tops have lots of vitamin A. I remember someone making a poultice for hemorrhoids from plantain once.

If it is wet then maybe **Bull Rushes** will grow. I tried cooking the rhizomes once and it was a lot of work. The green tops are ok as I have heard but I have not tried them. Native Americans used the pollen for flour too.

Offered by [Steve](#).



# Troubled Times



## Dim Light

---

Just how dark is it supposed to get, really? I ask because I've been thinking about the practicalities of growing sufficient food under artificial lighting and am beginning to wonder if this is at all realistic for anything but seedling development or very specific crops. Is it more likely that a [Solarium](#) could be constructed to house the garden, or will it be too dark for even growing plants in these conditions (assuming one has sufficient glass or similar to construct)? Any thoughts or pointers?

Offered by [Gino](#).

So much of the planet will be in near total darkness (from volcanic ash, etc.) and the areas that may have more light are too difficult to predict. Our advice and intent in planning is to plan for little or no light. If you happen to be in an area that is fortunate enough to have good climate and clear skies, you will likely also be in an area that has high winds (on the order of a couple of hundred miles per hour) and these solarium designs will have difficulty withstanding them (the high winds).

Offered by [Roger](#).

Moses bemoaned the lack of light, the gloom, where nothing grew, essentially. I think the range will be from something like dawn or dusk, worse near active volcanoes (upwind), better in some spots.

Offered by [Nancy](#).

I have always heard the number six months and how dark. Take those cloudy dreary days when it is drizzling and about two hours before sunset with the cloud cover will be about it. After six months it will take 2 years for weather patterns to stabilize a little, so the green houses are to protect against frost or weird snows, etc. Plants that can tolerate moderate frosts don't have to be in a green house. Tomatoes (needed for vitamin C) and other plants will need one. The high winds are done after the first six months. You need a good years supply of food and for six months you can do little but sleep and rest. I feel the earth tremors etc., will happen for months after so hard to start a green house if the winds are still strong the ground still trembles. Best to live off food stored and maybe wait a year to start a green house.

Offered by [Dave](#).

I have thought at length about what might happen in the future. A huge range of potential scenarios spring to mind. It seems to me that as the first level one has to take all the potential events scenarios) that might eventuate and then consider these individually or in concert with other mishaps. The second level will be the scale of the impact for any of the events that might affect us. The third level is about the measures we have to take to protect us and our friends and families from the potential impacts. These impacts may be zero for a distant comet pass to 10 for a direct hit of a 150 mile diameter object which will destroy this planet. In this case we can not prepare for it. We may have winds, floods, flash fires and prolonged darkness as well as sulphurous rains.

Offered by [Stephen](#).



# Troubled Times



## Artificial

---

There just isn't a crop that will grow in shade or partial shade. Low light plants certainly exist but can you eat them? Hostas like the shade but you can't eat them. Ferns grow in low light and you can actually eat the emergent fronds of some species (fiddleheads), but its not something you can rely on. Crops can be grown in artificial light, but only under high intensity bulbs like metal halide bulbs (400 watt or larger). LED lighting has been suggested but can they really grow crops quick enough? Plus they are more expensive than the high intensity bulbs used by commercial growers. I'm gathering as much lighting as I can right now, metal halide or very high output flourescent. These bulbs consume a lot of wattage so you have to find a way to generate electricity, through wind or water.

The comment has been made that we need a bulb that is long lasting or unbreakable, I personally don't see it happening, even if there is an emerging technology. We need it right now! The high intensiy bulbs (metal halide, sodium vapor, mercury vapor) exist everywhere in our cities. You can find them in street lights, supermarkets, gymnasiums, Wal-marts. Sure a lot of them won't make it through the pole shft, but certainly some will. They will grow plants, they may not be the optimum spectrum, but intensity is more important when it comes to their basic growing needs. One thing you might invest in if you plan on using these bulbs are electronic ballasts, instead of the old iron core heavy ones used now. They will save you a lot of electricity and increase the life of the bulb. You can sometimes find them on e-bay for a reasonable price under the fish section. Good luck in whatever route you choose.

Offered by [Stan](#).





# Troubled Times



## Source of Food

---

Possible no-light/low-light food sources and their method of acquisition can be listed.

### **Mushrooms, fungi**

Can be cultivated, or gathered. The *Field Guide to North American Mushrooms* by the National Audubon Society is a great picture reference guide, with lots of information about each mushroom. Of course, its geared to N. America.

### **Worms**

Can be farmed, or gathered. An article on worm gatherers in southern US states explains that you get a stob (piece of wood) and hammer it into the ground. You then rasp a bit of iron along the top of the bit of wood, causing it to vibrate. This brings the worms to the surface, where they can be collected. Immerse worms in water to get them to expell the earth inside.

### **Fish**

Can be farmed, or fished for.

### **Grubs, maggots and bugs**

Can be gathered from dead and rotting wood.

### **Burrowing animals**

Moles, and other burrowers that eat worms and grubs, might survive well for some time after the pole shift.

### **Snails, slugs and frogs**

Popular foods already in France. These might these be plentiful after the shift.

Offered by [Euan](#).



# Troubled Times



## Moles

---

The diet could be supplemented by hunting burrowing animals, such as moles, which feed on worms, plus snails and slugs if available.

Offered by [Euan](#).



# Troubled Times



## Low Light Crops

---



- Potatoes thrive well in the climate provided by Ireland, which is damp and with little sunlight.
- Carribou herds roam the far north, and thrive on the moss that is the only vegetation available to them.
- Ferns prefer the shade, and require a lot of moisture. A caution on eating ferns is that the fiddleheads, the new growth part of the leaves that is curled like the neck and head of a fiddle, are poisonous unless boiled first.
- Dandelion is a hardy weed that most consider a curse, but the leaves are edible as a green and dandelion wine is a common home-made wine.
- Leafy vegetables such as spinach and kale are easy to grown in any light.

Graphic by [Michel](#).



# Troubled Times



## Mushrooms

A couple of years ago I started buying *one* of each of the very expensive mushrooms like **Reiki** or **Portobellos**, harvesting the spores and letting them go to town in rich compost. The plant itself is actually the stringy rhizomes underground; whereas the mushrooms are disposable fruiting bodies that can be picked and picked and will still come back. They are fantastically flavorful, and don't need light. Not many calories, but interestingly they do provide vitamin D which may be hard to come by in landlocked areas. Just don't go larking about picking wild mushrooms unless you are very savvy about which ones are poisonous. I bent that rule only once, earlier this year, when I found an unexpected small gold mine of morels growing in our front yard. There are no poisonous ones which resemble them and so after scrutinizing the photos repeatedly I decided it was safe.

I now have them in flats in my closet. Simple mushroom flats: wooden crates lined with window screening or hardware cloth and filled with a mixture of soil and compost. The spores of mushrooms are virtually too tiny to see easily and actually escape constantly from the mushroom's gill surface. I have read of wild harvesters who recommend carrying the ones you have picked in mesh bags so that as you walk, spores drift downwards to propagate new supplies. You can shake whole mushrooms over your culture medium. You can also cut out the gills and let them roll around gently in the medium. One thing that should be mentioned, and I didn't do so before, is that your culture might contain fungal spores of its own. These can be eradicated by sterilizing the medium, either with heat or with ethylene dioxide gas, which is sold at many nurseries.



Offered by [Jenny](#).

My wife, who is a vegetarian, is also pretty excited about the fact that some mushrooms (at least **Shiitake**) contain a complete protein like meats. There are different classifications of mushrooms that attack the rotting things at different stages during their decay. Some, like Shiitake, are aggressive rotters and need recently cut (at least 2 months, but not starting to decay) hardwood stumps or branches while others thrive in a decaying material, like Portabella and white buttons.

Offered by [John](#).

Spore Prints. These will last a long, long time. Just need the medium to grow them in.

Offered by [Bruce](#).



# Troubled Times



## Fungi Cautions

---

From the *Food Bible* site.

### Fungi:

**All forms of fungus growth must be avoided!** All fungi & mushrooms. Beside being of Negligible food Value most are *extremely* dangerous & to date very little is known of them. One exception is the mushroom but as stated above unless you know them; **leave them alone!**

### Mushrooms:

After much research on it, the conclusion is that one should *avoid* whenever possible turning to mushrooms for emergency food. **Mushrooms have very little general food value.** So unless you are an expert, the incurred risks will be far out of proportion to the possible gain, since no single practical test is recognized unfortunately by which all poisonous mushrooms can be detected. **We repeat! No single test short of eating it can distinguish between a safe & poisonous mushroom.**



# Troubled Times



## Distinguished

The best edible mushrooms are 72% water, although they can be up to 80-92% water. High humidity requirements necessitate the proximity of water. Do not expect to find mushrooms following 48 hours of high wind. Saline soils are definitely hostile to mushroom growth. Once picked, mushrooms should be cut length wise to make sure they don't contain insect larvae. Mushrooms should be eaten quickly and should not be kept for more than 24 hours in warm weather, they are very nitrogenous and can become dangerous when spoiled. If they can not be eaten then they should either be sundried or string them up to be wind dried. Basic guidelines for the inexperienced are:

Stem: with ring	to be rejected
with covered cup at the base	"
with ring and cup	"
Cap: with gills	reject
with pores	
- meat turns blue when cut (meat is not edible if color changes)	reject
with pinprick-like pores	edible
with folds	edible
with alveoli (sponge appearance)	edible

Even though some edible mushrooms will be discarded, you will atleast be certain to discard all poisonous ones.

**Source Book:** *Survival; How to Prevail in Hostile Environments* by Xavier Maniguet, pages 358-360

Offered by [Steve](#).

To see if a mushroom is poisonous, boil it and throw a coin in the water. If the coin tarnishes, then the mushroom is poisonous.

[Mike](#)

I've been reading some survival books, and they say, you can eat pretty much any mushroom that does *not* have a white milky sap though don't take my word for it please! Some books say to stay away from all mushrooms as they don't hold much food value and aren't worth the risk. The coin test looks like it's for alkaloids, I assume, which are certainly poisonous, and I'm assuming the coin is a penny as copper is an easy tarnish. I would say, buy some shrooms from the grocery store and test the theory, see if the coin does or doesn't tarnish.

Offered by [Aron](#).

The rule I abide with is that all mushrooms with white gills are poisonous. (I know this is not so, only most of them are poisonous, but because of my lack of specific expertise I avoid them all). I have a go at most mushrooms with dark gills. I know I can eat all 'sponge' mushrooms. Those with a sponge appearance rather than gills on the underside. Some of them may be bitter (nutty) , but they are all healthy.

Offered by [Stephen](#).



# Troubled Times



## Dead Wood

---

I've been working with mushroom cultivation as a crucial part of my survival solution set for over a year now. In many ways they are bedrock for a permaculture solution (pre or post shift). There is no photosynthesis involved with mushroom growth and in fact the only thing they use light for is to let the fruitbody know when it is time to release spores for propagation. The amount of light necessary to trigger this is very, very minimal. There is a lot to all of this but some other basic information. They are wonderful sources of proteins and amino acids and many species have medicinal properties. In a wooded environment you can use materials on hand (fallen trees, etc) to propagate several 'runs' of fruitbodies (mushrooms) during various stages of decomposition of the material (mushrooms are decomposers). At the end of these processes what you are left with is very rich soil that you can then use to grow other crops. Another use for certain species is detoxification of soil and water. If you want more information on the subject please feel free to write.

Offered by [Andy](#).



# Troubled Times



## Propagation

---

I guess the big question about mushrooms is how to keep the "culture going and how to avoid harmful contaminants (other fungi) from infecting a culture. My question is, Can you keep propagation going through "spawn" without ever having to go through the sexual cycle and deal with the spores? In other words, can you keep essentially clones going without ever introducing any new genetic material through new cultures. Of course this happens naturally all the time, but not on any production scale. In a post pole shift environment ( wet, dark with lots of rotting vegetation) we can go hunting mushrooms as long as we are familiar with what's edible. Have you kept any continuous propagation going from a single culture?

Offered by [Stan](#).

It is definitely possible to do so but I am not sure its necessary. I'll look in to it more and see what information I can find. It is pretty easy to go through the whole process with spores, actually. For instance a method Stamets uses for propagating certain species is to mix spores in with wooden dowels in a plastic bag. The spores inoculate the dowels and then you basically hammer them in to logs. They will then grown throughout the wood and produce mushrooms...rinse ... repeat... If you are going to harvest mushrooms from the wild you had better know what you are doing. Many of them (I'm sure most know this) are very, very poisonous and look very similar to species that are perfectly safe.

Offered by [Andy](#).





# Troubled Times



## Books

---

Two good books on mushroom culture are:

*Introductory Mycology* by Alexopolous

*Mycology in Sustainable Development* by Palm and Chapela

Both are available from Amazon.com. The first book is expensive but covers all aspects of fungi and mushrooms, including their medical values and growing habits. The second book is very progressive and a great growing guide with applicability to post-disaster circumstances.

Offered by [Jenny](#).

Buy or check out from the library any book by Paul Stamets (*The Mushroom Cultivator* and *Growing Gourmet and Medicinal Mushrooms*).

Offered by [Andy](#).



# Troubled Times



**TEAM:**  **Mushrooms**

---

Troubled Times members are starting to prepare for the gloom that lasts for years after a pole shift by trying their hand at growing mushrooms. One complication has been [Mold](#).

# Troubled Times



## Growing

First the bad news:

I attended a mushroom cultivation course a year or so ago (with the pole shift in mind) and I can tell you that in post pole shift conditions, raising mushrooms will be pretty difficult. You need an absolutely sterile "clean room" and a scientific transfer table (with a hepa filter and fan for starters to create tissue cultures as well as agar medium, scalpels, petri dishes, pressure cooker etc. You need grain and a means of sterilizing it to then grow your tissue culture in, to create spawn, and then you need a substrate (straw or saw dust etc.) to grow the spawn you have created (and a means of initially sterilizing the substrate), to produce the mushrooms. I'm not saying this is impossible, but even if you have the equipment and it made it though the shift, you need a lot of stuff like grain and chemicals (not to mention power) that once you use up your supply, your out of business. Growing them also requires temperature and humidity control that varies at different stages, which could be difficult. By the way it is a misconception that mushrooms are grown in the dark. There are times to stimulate the mushroom to create fruiting bodies by exposure to light, although we can still consider it a low light plant (actually it is not a plant and is scientifically recognized as its own category, being made of chitin not cellulose like plants).

Now the good news:

Mushrooms are said to thrive on "catastrophica", and I would say we have some pretty good catastrophica headed our way. They will love the dead trees and plants and they love the rain (there is a good pocket guide called *All that the Rain Promises and More*). So there are two things I suggest you can do to prepare.

1. Get some good books to identify wild mushrooms as there should be lots and follow the rules for eating them... i.e. if in doubt, throw it out, it could mean your life.
2. You can grow your own outdoor mushroom patches from kits (by mail from Fungi Perfecti in Olympia Washington). These kits contain the spawn and detailed instructions on how to "plant" them (substrate etc.), and once established can produce mushrooms for a couple of years or more and may also spread to other areas. The kits were only \$24 +/- the last time I checked and you can get "Garden Giant", Morel, Maitake and Shaggy Mane. I plan to get one of each at least.

An important thing to remember about mushrooms is that while they can contain various vitamins, minerals, medicinal properties, protein, fat, ash, fiber etc., *they must be cooked* because the cell walls of chitin (the same stuff that insects exoskeletons are made of) are much stronger than cellulose cell walls in plants. If you don't cook/steam them, you might as well be eating cardboard, for all the nutrients you'll get out of them.

Offered by [Kraige](#).





## The Finest Mushroom Products for Home and Garden, Farm and Forest, People and Planet

Fungi Perfecti is a family-owned, environmentally friendly company specializing in using gourmet and medicinal mushrooms to improve the health of the planet and its people. Founded by mycologist and author [Paul Stamets](#), we are leaders in a new wave of technologies harnessing the inherent power of mushrooms and fungal mycelium worldwide. Fungi Perfecti is Certified Organic by the Washington State Department of Agriculture. In business since 1980, we offer an ever-expanding product line for the mushroom enthusiast.

### NEW FROM FUNGI PERFECTI

#### PAUL TALKS AT TEDMED

TEDMED, the acclaimed cutting-edge medical conference, has released the video of Paul Stamets' 2011 talk, "[Is the world ready for a Medical Mushroom Mystery Tour?](#)" Check it out!

#### Understanding Beta-Glucans

Currently, there seems to be a lot of confusion about beta-glucans and their contribution to the beneficial properties of mushrooms. In order to shed more light on the subject, Paul Stamets has written a new article, "[Beta-Glucan Analysis and the Seven Pillars of Immunity](#)".



#### Making the Most of Winter

This may be a time for crazy weather in your area, but it can also be a great time to start planning your outdoor mushroom projects for the Spring. Stormy Winter winds can mean lots of logs to set aside for inoculating with [Gourmet Mushroom Plug Spawn](#) when the warmer months (eventually) come around. Check out the [newest testimonial](#) from one of our customers!

- [WHAT'S NEW](#)
- [JUST FOR KIDS](#)
- [ABOUT US](#)
- [SUPPLEMENTS](#)
- [GOURMET DELIGHTS!](#)
- [MUSHROOM KITS](#)
- [PLUG SPAWN](#)
- [MYCOGROW™](#)
- [THE LIFE BOX™](#)
- [MUSHROOM BOOKS](#)
- [MUSHROOM GIFTS](#)
- [SPAWN & CULTURES](#)
- [CULTIVATION TOOLS](#)
- [SEMINARS](#)
- [CLEARANCE ITEMS](#)
- [MYCOTECHNOLOGY](#)
- [MUSHROOM INFO](#)
- [POLICIES](#)
- [SEARCH FUNGI.COM](#)
- [PSILOCYBES](#)

[Click Here](#)



To See a Picture of Fungi Perfecti's Home

A Personal Appeal to our Customers from Paul Stamets



#### Mushroom Kits



Ready-To-Grow Indoor and Outdoor Mushroom Patches™

#### Supplements



Quality Certified Organic Mushroom Products

#### Plug Spawn



Grow Gourmet & Medicinal Mushrooms on Logs & Stumps

#### Mycogrow™



#### Mushroom Books



#### Mushroom Cultures



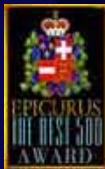

Mycorrhizal Fungus  
Products for Healthy  
Plants & Soils

Mushroom Cultivation  
Texts, Identification  
Guides & More...

Pure Mushroom  
Sawdust Spawn, Grain  
Spawn & Cultures

Cultivation Tools



Mushroom Cultivation  
Tools for Hobbyists  
& Professionals

Mushroom Gifts



Posters, Playing  
Cards, T-Shirts and  
Other Mushroom Gifts

Seminars

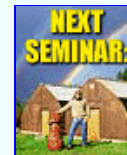

The Stamets Seminars  
on Professional  
Mushroom Cultivation

## FUNGI PERFECTI, LLC

PO Box 7634 • Olympia, WA 98507 • USA

Order Toll Free (US & Canada): 800 780 9126

Phone: 360 426 9292 • Fax: 360 426 9377

email: [info@fungi.com](mailto:info@fungi.com)

Hours of Operation: Monday-Friday, 8:30am-4:30pm Pacific Time

3038500

WEB counter™



Prices and other information on this site are subject to change without notice. All pictures and documents presented on this site are copyrighted by Paul Stamets and Fungi Perfecti LLC, all rights reserved, unless otherwise noted. Do not duplicate without express written permission of Paul Stamets. Why bother appropriating our intellectual property when you can just give us a link? :-)

Mushroompeople.com



if this site does not send you to **Mushroom *people***, click [here](#)

# Troubled Times



## Comic Strip



**Frumpy the Clown** comic strip by [Judd Winick](#), *San Francisco Chronicle*, July 14, 1996 in part, but the [Entire Strip](#) is available.



# Troubled Times



## Food Chain

---

Using worms as the foundation for a food web seems an ideal solution to me. As well as being a direct food source for humans, worms could be used as food for chickens and fish. As long as there is a steady supply of worms humans could conceivably count on a diet of worms, chicken, eggs, fish, insects and mushrooms.

Offered by [Euan](#).

Does anyone have any experience raising earthworms? I looked into it years ago. As I recall, the favored breed was called Red Wiggler. I'm wondering if regular night crawlers from my yard would work, maybe in 5 gallon buckets in the basement. Seems like a good crop to raise, since they require no light and feed off dead vegetable matter. High in protein. I have actually seen recipes for cooking earthworms (I believe they dried them first). Although I hope not to become that desperate, they would still be good fish and chicken feed, as well as a good protein component for dog and cat food. Not to mention the castings are good fertilizer.

Offered by [Wendy](#).





# Troubled Times



## Water Purge

Worms are an excellent protein source. Dig for them in damp humus soil or watch for them on the ground after a rain. After capturing them, drop them into clean, potable water for a few minutes. The worms will naturally purge or wash themselves out, after which you can eat them raw.

Offered by [Clip](#).

PREP: (for both commercial and self-harvested worms)

- Earthworms must be purged and cleaned before cooking or freezing
- Commercial worms (store bought/mail order) are generally purged already (they purge [deficate/poop] every 24 hours, and will have done so during shipping). Discard all dead worms you end up with (spread them out by the handful on [ideally wax] paper, if they don't move around, they are dead. Be sure they are moving, not just "look alive" cuz one is moving another.)
- Worms you gather from the earth should be purged to remove intestinal waste immediately after gathering (but if necessary you can keep them for 2 days in refrigerator or similar cool place, in vermiculite or meal).
- To purge them, place them in a box of moist vermiculite/peat moss, (or moist cornmeal/ flour, or similar material for 24 hours). OR for immediate use place them in a bucket of cool tap water for 1 hour and they will purge themselves. Purging makes certain the worms will be clean inside and ready to bathe, then freeze or cook (which must be done immediately). (If you've ever de-veined loads of shrimp you will certainly appreciate this purging method instead!)



Posted on the [Pole Shift ning](#).



# Troubled Times



## Cleaning

---

I seem to recall that preparing escargot for consumption involves putting the snails in corn meal for some days to clean out their digestive systems. Perhaps this would work for worms as well.

Offered by [Maggie](#).

The instructions at a New Zealand site were:

Purge your worms. Simply wash and place in moistened cornflour for 48 hours. Wash corn flour off and remove any dead worms.

Cooking and boiling: bring to boil for 15 minutes then change water and boil again.

Baking: freeze worms first. This stops them from slithering off the baking tray. Bake for 30 minutes at 125C (200F). Baked worms may then be ground into "worm flour". (I like this idea!)

I am going to try purging first in water of course and then in crushed cattails (dried to make flour) and if that doesn't work I'll try other native plants. I want to try the baked worms, I think this will be easier for me to start cooking with than working with the soft goey meat. I will keep you posted.

Offered by [Mary](#).

After purging, place a handful of worms in a colander (beware: if you are too slow/timid they will crawl through holes and get stuck in your collinder, which is no fun for either of you, so don't be squeemish, just give them a good, quick bath)! Rinse vigorously with cold water, place on paper towels and pat dry; they are now ready for cooking, freezing, or drying (one cup of earthworms weighs a one-half pound. Freeze in handfuls, in sandwich size freezer baggies). Rinsed worms are generally boiled (plunged live into roiling water) before inclusion in any recipe. Boil them for as little as ten minutes once and drain; or boil twice/thrice for 5 minutes between water changes. (Sorry to mention it, but worms produce alot of mucus for locomotion). Change the water and boil again if water seems dirty, or slimy (opinions vary on the boil/water change/boil again cycles, depending on your culture, as seen in the recipes below). Personally, at home I cook like a Chef and boil/drain/boil repeatedly; on expedition I cook like Guide and boil twice; when camping I cook like a man and boil once: when on a remote adventure I eat like the natives with a gulp and a smile.

Posted on the [Pole Shift ning](#).

I think the small red wigglers might be hopeless as far as getting the dirt out completely so they might have to be regulated to compost duty or feeding catfish.

Offered by [Michael](#).

Take a blender, blend the worms (red worms too), and the cocktail you are left with (with some water to thin it) may perhaps have the heavier particles at the bottom and the worm particles, the meat, at the top.

Offered by [Michel](#).



# Purging/Cleaning Techniques

## Photos of initial attempts at purging small worms

The initial step in purging is to place in fresh water where the worms will defecate. This is, however, only very partially effective.



Cutting small worms



Pressing worm pieces to remove dirt and sand



pressing\_pieces\_2.jpg (83101 bytes)

Further vigorous pressing of worm segments



Many times during the above processes the worm segments must be rinsed thoroughly in running water.



**Further work in this area is planned, as the presence of soil and especially sand is a major problem not easily remedied.**

---

This page was produced by Ron Darby.

# Troubled Times



## Earthworm Powder

---

After boiling they may be used in recipes, or they can be baked (and dried) on a cookie sheet in a 200 degree oven for 15 to 30 minutes (Freeze the worms first to kill them, which stops them from wriggling off the baking tray! Always be sure to defrost the worms thoroughly, before baking). Or they can be salted, or sun dried like other meats (on hot rocks in the sun, hung or tossed by the fire, or dri-pressed like dried flowers, etc). After boiling/baking use them whole, chopped, or ground into flour. Grind into flour using a blender, mortar and pestle, grinder, sieve, or grinder, (blender is easiest/fastest if available). This high protien flour can then be made into sauces, gravies, pastes/spreads (pate), stock/bullion, breads/pancakes/muffins, fillers/thickeners,etc., and even no fat yogurt!

Posted on the [Pole Shift ning](#).





# Troubled Times



## Recipes

---

Earthworm subtle, earthy flavour lends itself well to all sorts of delightful dishes (a few sample recipes provided below). Many people around the world eat earthworms as a staple; Aborigines in Australia, the Maoris of New Zealand, and some Asians. Many other worms can be eaten as well, some are noted in the recipes below. The meat can be used like ground beef, or as meat filler: made into burgers, sausages, chilli/spagetti, scrabble/scramble, meat pies/caseroles/quiche, etc.

### **Worm Banana Bread**

Ingredients:

1/2 cup shortening

3/4 cup sugar

2 bananas, mashed

2 cups flour

1 teaspoon soda

1 teaspoon salt

1/2 cup chopped nuts

2 eggs

1/4 cup dry-roasted army worms, or earthworms chopped into 1/4 inch segments

Directions: Mix together all ingredients. Bake in greased loaf pan at 350 degrees for about 1 hour.

### **Applewood Flavored Meat**

Chop apples (red delicious) into chunks

Layer apples and cleaned boiled earthworms in a container with a tight fitting lid

Refrigerate in closed container for 24 hours

Remove apples and roll in a mix of all purpose flour seasoned with paprike, salt & pepper.

Then roll worms in same flour mix.

Deep fry both in the same pan together.

### **Worm Fried Rice**

Ingredients:

1 egg, beaten

1 tsp. oil

3/4 c. water

1/4 c. chopped onions

4 tsp. soy sauce

1/8 tsp. garlic powder

1 c. minute rice

1 c. cooked mealworms (or earthworms chopped into segments)

Directions:

Scramble egg in a saucepan, stirring to break egg into pieces.

Add water, soy sauce, garlic and onions. Bring to a boil.

Stir in rice & worms. Cover; remove from heat and let stand five minutes.

### **Earthy Worm Stroganoff**

1 c. earthworms

1/2 lg. onion, chopped  
1/2 c. water  
1 bouillon cube  
1 c. yogurt or sour cream  
3 tbsp. butter  
1/2 c. mushrooms  
Whole wheat flour  
Utinsels: Saucepan

Wash earthworms thoroughly and place in boiling water for three minutes. Pour off water and repeat the boiling process twice. Bake on cookie sheet at 350 degrees F. for 15 minutes. Roll the worms in flour, brown in butter, add salt to taste. Add bouillon and simmer for 30 minutes. Saute onions and mushrooms in butter. Add onions and mushrooms to the worms. Stir in sour cream or yogurt. Serve over rice or noodles.

Posted on the [Pole Shift ning](#).



# Troubled Times



## Easy to Grow

---

Here's my \$0.02 worth to the topic of raising worms. Many years ago my father actually raised worms. His worm beds were outside.

One of the main concerns is keeping the worms in the bed and not escaping. Worms don't like strong light so at night (or in any dark environment) he had lights over the beds.

Also, one source of food for the worms was cardboard boxes. They love it. He would get used boxes for free from the grocery store and tear them up to large flat pieces. These were then laid on top of the worm beds and watered down. The next day if you lifted one of the pieces of cardboard, the bottom of it would be full of worms eating away. Other than that we actually fed the worms chicken feed. Obviously cardboard and chicken feed aren't going to be around much in the Aftertime but I thought it might be some food for thought.

Also the soil needs to be kept loose. We accomplished this by sprinkling the surface with hay and then using a pitchfork, turning and mixing the entire bed.

Another issue if your worm bed is kept outside is animals. Here in Texas we have lots of armadillos and they *love* worms. You must have some sort of fence to keep this type of critter out.

Offered by [Michael](#).

The main reason why worms would crawl out of the bed is that the bedding wouldn't be comfortable for the worms, this could have many different reasons:

- soil too soggy
- food rotting
- temperature too high/low

In order to prevent this, make sure the bedding/soil etc. are good. Also, cover the bed with a piece of carpet made of non-natural fibers (will be eaten otherwise). Also, bedding must be deep enough for crawlers, and there must be enough food available for wrigglers. Worms in general need soil, where they eat it so that the tiny grains within it can be used within the stomach that stretches over the entire body of the worm, it helps the worm with digestion. In general, earthworms need an environment not too wet and not dry, so they can't be kept in a place where they are submerged, so to speak. Worms also shy away from light, if there is a way to avoid light in the system to reach the worms (by a form of covering) then that is problem solved, too. Earthworms eat pre-digested compost (the red worms eat the compost and output vermiculite which the earthworms eat outputting an even finer form of vermiculite, which comes out via the drainage together with the water as an excellent fertilizer).

Offered by [Michel](#).



# Troubled Times



## Mother Earth

---

From [Mother Earth News](#), June/July 2000

*Sort out citrus rinds, avocado pits, and onions. ... Lawn grass and leaves will be the mainstay of your earthworms diet. Kitchen scraps are a secondary, albeit important, source of food. In addition to vegetable and fruit scraps, you can add egg shells, tea bags, and coffee grounds. Do not use meat scrap or fat. ...*

*[Worms add] all of the nutrients your plants need - including as much as three times the magnesium, five times the nitrogen, several times the phosphorous and 13 times the potassium of the surrounding soil. ...*

*In general, through, worms reproduce rapidly, a pair will produce an egg capsule weekly containing up to 20 eggs. These eggs will lie dormant until the proper temperature and moisture conditions allow them to hatch - normally within two or three weeks. Within eight to 12 weeks of hatching the new worms are themselves ready to reproduce. ...*

*For bin-based vermiculture, it is generally recommended that folks use red wigglers (*Eisenia foetida*). ...*

*The worms tend to remain most active near the pile's surface, where they are continuously lured by newly applied organic material. ...*

*If the worm pile is built too high, the weight of the organic material will speed decomposition, boosting the pile's internal temperature to levels dangerously above the worm's ideal 70 degrees F.) ...*

*Soils high in clay or organic material lack the grit, or small pieces of soil material, necessary for worm digestion. ... you can try mixing the sand into your soil.*



# Troubled Times



## Multiply Rapidly

---

The small red worms (*Rumbricus Rubellus*) are ideal for composting, giving you with vermiculite in exchange for your kitchen and garden trash. The red worms multiply in such a rate that a healthy colony will double it's numbers every month. You can calculate how much worms you take from the wormbox without negatively influencing the colony's size, as you wish to keep this in a growing rate. So my guess is you take 25% away every month, so you have a 25% extra amount of worms as added growth of the colony still left.

Month 1: 1000 worms (may cost \$30 USD or less)  
Month 2: 2000 worms - 500 worms (25%) = 1500 worms left to reproduce  
Month 3: 3000 worms - 750 worms (25%) = 2250 worms left to reproduce  
Month 4: 4500 worms - 1125 worms (25%) = 3375 worms left to reproduce  
Month 5: 6750 worms - 1687 worms (25%) = 5063 worms left to reproduce  
Month 6: 10126 worms - 2531 worms (25%) = 7595 worms left to reproduce

As you can see, even with taking off 25% each month of the healthy colony you can have a 750% increase of your population within half a year. Each additional month will provide you with enough worms to feed chickens (kept for the eggs) and fish (fishfarm-food). Keeping worms means you can feed fish and chickens (chickens also need other foods!). A thriving colony, expanding every month, will need more food every month, too! This can and has happened on many occasions with people keeping red worms, where they did not have enough rubbish to feed the worms! You can of course solve this by taking 50% of the worm colony instead of 25% each month, once the colony has reached the size where you can just feed them. This benefits the other animals you keep which eat the worms.

Offered by [Michel](#).

The *Chicago Tribune* carried a story last week about maintaining [Worm Bins](#), and it was carried by our newspaper here in Pennsylvania. Interesting that it appeared on the *Kids* page! A couple tips from the story:

- Feed the worms scraps from fruit, vegetables, grains, coffee grounds and filters, tea bags, bread crust, corn cobs, pasta, and cereal.
- Don't feed them meat, fish, cheese, bones, gravies, salad dressings, butter, or salty foods like chips.

Offered by [Mike](#).



# Troubled Times



## Efficient

---

As soon as it warms up outside (in a month or two,) I will have my worm/insect systems up and running. I will create a website to demonstrate how to build and run one yourself. The reason that worms are even considered, is that they can be feed things that are abundant in most areas, need no light, and breed quickly. I believe that your worries about feeding the worms are exaggerated. Worms eat almost anything organic; leaves, cardboard, etc. Unless a firestorm burns up everything around you, there will be plenty of decaying organic matter around you. The worms can be used as food for chickens or fish. Based on early calculations (using chickens, fish would use half) 64 cubic feet of worm bin space is all that is needed to feed each person (with the addition of 23 pounds of organic matter for worm food per week). Any part of the fish or chicken that is not consumed can be feed back to the worms along with all fecal matter. The biggest obstacle is feeding and producing the quantity of worms you'll need, and for this we must use the most efficient means possible. It is possible to maintain your worms in a [Minaturized State](#), then grow them out to full size in 10-15 days for useage. While small, they eat very little.

Offered by [Michael](#).

My original concerns about food for the worms stemmed from the fact that I had read many articles and some book on raising worms, which all seemed to agree that grass and leaves could be used as bedding, but food either in the form of table scraps or manure was also needed. But it seems indeed that the worms *can* live off of just cardboard or compost as evidenced in the excellent article *Raise 100 pounds of Worms in One Room*; this guy even grew red worms in soil! So my worries were misplaced. Worms will be a very good base for an ecosystem. Now I have two questions (I will run my own experiments but this will save me time):

1. must the yard waste be composting before adding it the the worm bin and if so for how long?
2. and raising fish *solely* on worms seems to me like it adds an extra layer to the ecosystem introducing more inefficiencies and it is a lot more work. Why this extra level?

The method of shrinking the worms down does give us an easy and effective way to take lots of worms into the aftertime with us.

Offered by [Pythag](#).



# Troubled Times



## Feeding

---

I started putting some dog poop in one of the beds, you know, thinking I was not feeding the worms enough, and brushed aside the straw and found a half dozen adult worms along the edge of one of the poops! Folk-lore here is that one can always find a bunch of nightcrawlers under a cow pie, or where coffee grounds have been dumped on the ground.

Offered by [Nancy](#).

Actually you find worms only where organic material has the right bacteria count and yes you are right, mostly they are not fed and are struggling to survive any way when they are living in cast. Cast as far as bacteria is concerned is worked out material, if the bacteria is not there the worms can not eat a thing. The rule for feeding is *only* use the freshest of manure and organic waste, feed again when approx two thirds of the last feed has been converted to vermi-compost (the stage just prior to the darker and finer vermi-cast). Also if you are using other than manures, then everything should be ground to the smallest particle size to allow the bacteria to access all the material. A good way to understand this is if you take a whole pumpkin and put it in a worm pit, chances are you could pull it out in a weeks time and it would be as good as when you put it in. Take the same pumpkin and cut it into four pieces and in a weeks time the cut faces will have some worm activity. Take the same pumpkin and mill or grind it and in a weeks time it will have been consumed. This is because of one reason only, the bacteria will have got at *all* the material, remember you create a bacteria "farm" first to have a worm farm. There is no role for fresh "soil" in Vermiculture, the beds should always be 100% organic, with about 25% max in worked out material (cast) as a bed on the bottom to act as a safe haven. Definetely *no* soil.

Offered by [Darryl](#).



# Troubled Times



## Harvesting

Just like fish farming, you need to cull fish to grow fish, the same with worms, with a big extra. The secret to worm farming is simple you have to extract worm all the time, but unlike fish farming you also have to remove the cast at the same rate. With fish farming you leave their water behind. Without doubt you are leaving cast behind as well as not harvesting, when you harvest they rapidly replicate themselves. When you leave cast behind the mechanism for cocoon burst and egg creation is switched off. Think of a bell curve, on the left hand side is worm multiplication in fresh food, then as cast appears the bell curve peaks, from there on it goes down hill in direct proportion to the quantity of cast remaining. It is always the same mistake. So harvest on the left hand of the curve and replication will be doubling every thirty days, then strip stock at the peak when cast appears, reset the pits and the growth rate remains near vertical. In the bell curve, the 20kg figure relates to the introduction of "start up" worm stock to get on the vertical part of the curve from the beginning in a pit that is 4.5 square metres in size. You can scale up or down from this area to calculate the start up stock and the growth factor. This assumes that pit management is constant and correct. The right hand side of the bell curve means that when the worms have converted the material fully to cast then there will be *no* worm stock left, but 100% cast.

### Bell Curve

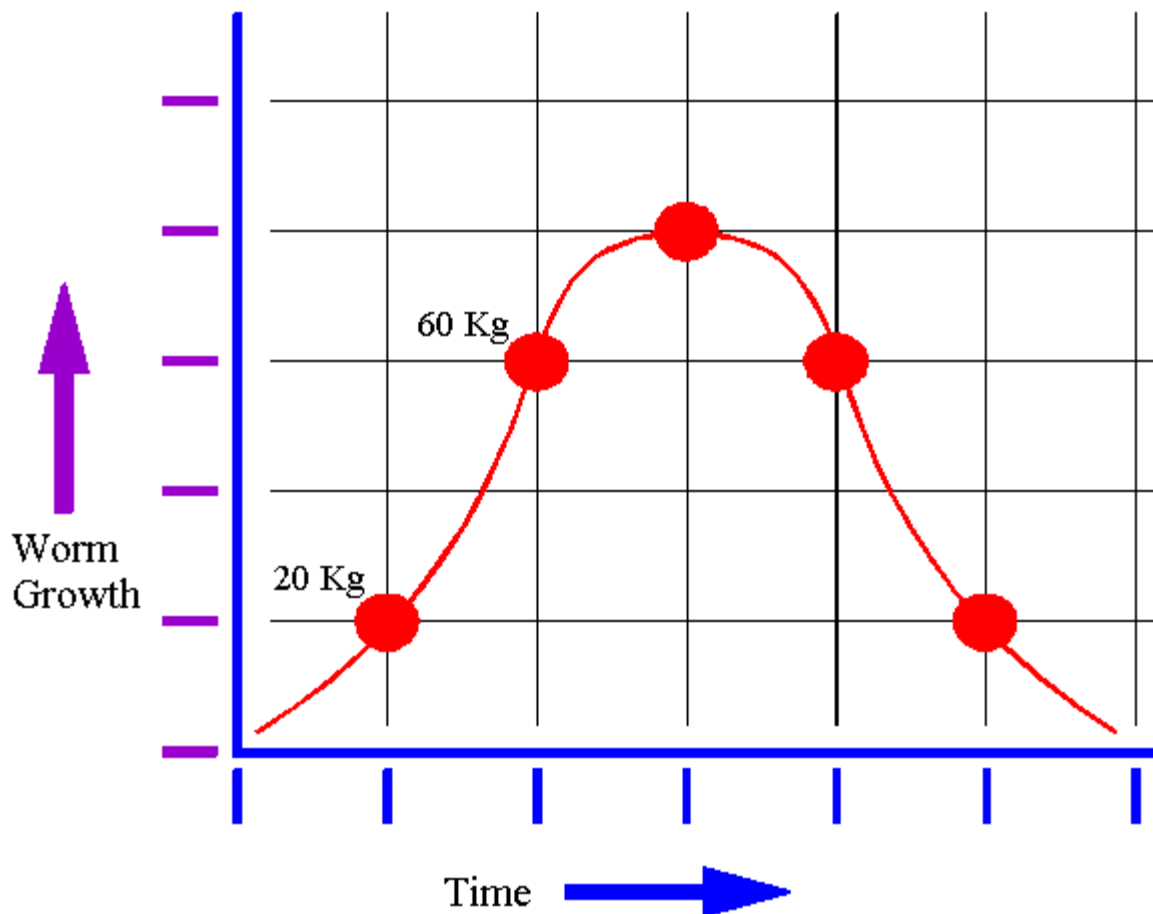



We have a weekly harvest all the time by drawing worms to a special formula they love over all other materials, we use simple experience about how many kilos to remove. Do not over harvest as you slip to far down the left hand side of by now a flat section in the bell curve, likewise keeping too much allows you to plateau. Everyone who has ever grown worms ends up always some where down the right hand side. It took me a long time to figure out what was really going on. When the worm stock has been harvested at the 60 kg reference point, you can take the cast out, at this time we call it vermi-compost not vermi-cast and we feed it to a pit where "sacrificial" worm easily converts it to vermi-cast so as you also end up with the best possible cast. The trick here is to keep feeding vermi-compost to the "sacrificial" worm so as not to sacrifice them! A vertical pit is best for this so you in fact top feed it and the worms continue to move up and do the conversion to cast. In the meantime you have extracted peak worm and reset the first pit to 20 kilos only for peak regrowth.

Offered by [Darryl](#).



# Troubled Times



## Tips

---

The uniformity of particle size and the darkening colour are good indicators of worm casings. But the best is to just simply check to see if worms are mating and making cocoons, check to see that more cocoons have been made each day. A cardboard template laid over a few areas is an easy way to see if you can count more cocoons. Check to see worms are coupled up making a cocoon each, but don't disturb for long.

No mating signs means the food is insufficient or the pH is wrong, as pH is the next biggest thing that goes wrong after too much cast. You are running a bacteria farm primarily, worms have *no* bacteria naturally like every other animal, so pay attention to pH first or the wrong bacteria will grow and the worms can not use them to break down the food first, next keep moisture levels high and constant, once again to peak bacteria, keep light out primarily for the bacteria as well. Peak the bacteria count and you peak worm growth, which simply responds to an apparent over supply of suitable food. So add large quantities of AG lime to keep the pH up to around 6.5 to 7.5 ideally, peak. Correct bacteria is best maintained in that range.

In true commercial growing you really need a [Separator](#) to harvest the 40 kgs in the fastest way, our separators have proven to be very popular.

Offered by [Darryl](#).



# Troubled Times



## Composting

---

Started my first worm farm in a plastic bin in my basement last week. So far the worms seem happy and healthy. I followed some instructions on the Net and used shredded newspaper for bedding, but I mixed a little rotting leaves in, too. And I've added dry matter like chaff since then. So far the worms seem to congregate in the areas of leaves and chaff, and in the bottom corner where water collects (I have the bin at a slant). So offhand I'd say natural material like leaves, very wet, is better than the shredded newspaper, wet, wrung out, and fluffed up as the instructions told me to make it.

I have a compost bin that consists of an old tractor tire that was once used as my children's sandbox. The tire is under a maple tree, in the shade. My purpose for the compost bin is to dispose of dog droppings (I have 4 dogs) with little odor, and provide fertilizer for my flower beds (not to mention the now very healthy maple tree). My method is to take a bucket, fill it half full with dried leaves, carry it around my yard picking up dog droppings and putting them on top of the leaves. Then I upend the bucket into my compost bin. This prevents icky dog doo from sticking to my bucket, and covers it with leaves in the bin, to prevent it from smelling. I also add any vegetable matter I have during the summer. Threw in tomato pulp last year, and now have tomato plants in my flower beds from the compost. I turn out the compost each fall into a pile next to the bin, to make room for the winter's worth of dog droppings. Since they include snow, it takes up a lot of room. Here in my Minnesota climate, under the tree, it takes 1-2 years to make compost.

The basic ingredients for successful compost are balancing 'green' (manure, green plants, vegetable parings, etc.) with 'brown' (dry leaves, etc.) and the proper amount of moisture. Air is also essential, and is provided by turning the pile (including sticks and large roughage helps, too). If you provide the proper environment/ingredients, it should create heat and make compost fairly quickly (3 months). On the other hand, I wonder about the viability of composting with worms. This would obviously be different, as it would not need turning and should not be hot. I intend to try adding some worms to my compost bin next spring to see if they survive and speed up the process. As for compost tea - just put some in a bucket of water, stir it up, and let it sit a few days. As for nutrient component, I have no idea, but my flowers and the maple tree seem to like it.

Offered by [Wendy](#).



# Troubled Times



## High Heat

---

I can speak with authority on this issue. Temperature is the main problem. Last July I used fresh tree branch chippings in my worm bin and succeeded in killing about 6 pounds of worms. At first they tried crawling out to the outside of the stacked bin container, but within a week they died all at once. Stunk a lot they did. Turned into liquid worm sludge and it seemed like I had a pound or two of maggots in there too. My advice is to allow compost to get through the thermophilic stage before adding to worm bed. It will take me a long time to get my population back to what it was.

Offered by [Steve](#).



# Troubled Times



## Grunting

---

On my [Outdoor Survival](#) page I've just added notes from two books about raising worms. I'm intrigued by two methods of "calling up" worms out of the ground, a process also known as [Grunting](#). According to one book, take a seasoned piece of wood, about four feet long. It should be in the shape of a wedge, about two inches wide at the top and ½ inch wide at the bottom. Pound this wedge three feet into the ground. To create vibrations down the wedge and into the ground, rub a piece of tapered steel across the wood, just like you're playing a violin. Some people make their "grunting bows" out of wood. These bows have lots of raised notches that vibrate when gently rubbed across the surface of the wedge. And here's a method from another book: *Drive two metal rods into the ground, about two feet apart. To each rod, hook up jumper cables connected to a car battery. Worms are said to just jump out of the ground.*

Offered by [Mike](#).

This is wild if you have never seen it, and the setup does not have to be all that fancy. A farmer friend of mine showed me how just by stomping a shovel into the ground and then sort of drumming on the side of the shovel handle with his outstretched fingers. I have done it on a small scale with a trowel in my garden. It does help to have worms in the soil though. If there aren't any they won't show up. It is a good way to tell if you have worms nearby once you are predictably good at it. Must be some survival behavior to get out of the ground when moles approach or something that makes sound like that. Perhaps the sound is not specific either, I wonder. If you intend to eat them after the pole shift then you might want to practice a bit.

Offered by [Steve](#).

Here is a [video of the process](#) by some Florida folks who sell their produce to fishermen.

Offered by [Nancy](#).

Almost every indigenous society around the world utilizes "earthworm calling" techniques. The concept is simple: For some reason, vibrations seem to drive earthworms out of the ground. So here's what you do. Take a smooth piece of wood and drive it into the ground. Then take a notched piece of wood and draw it back and forth over the smooth piece in a sawing motion. The idea is to create a constant dull vibrating series of closely spaced thuds underground, sort of like a slow motion jackhammer. It may take around 15 minutes for the worms to start surfacing.

Posted on the [Pole Shift ning](#).



# Troubled Times



## Vital Earth

---

The Vital Earth company is committed to exploring and utilizing to the fullest limits the application of natural and little known technologies and subtle combinations of these alternative methods for soil rejuvenation and organic agriculture all within an environmentally safe and conscious approach. We have coined two new words to describe the process:

- **Vermioreduction:** the application of compost worms to reduce by volume - up to 90% - otherwise useless and/or costly to dispose of organic waste.
- **Vermioconversion:** the conversion by compost worm application Organic Waste o useful organic liquid and solid fertilizer.

The application range from dairy farm waste reduction and conversion, to municipal waste recycling. Earthworm growing can also be a means of converting animal waste in one step to high protein feedstock for agriculture, Silver Perch and Yabbies or birds such as Duck, Quail, or Poultry. Being an underground, tough creature it has important potential for those of us concerned about cataclysms, i.e. the worm is living in near radiation proof conditions, its ability to survive in highly toxic conditions is now being employed in toxic land fill reclamation. A cocoon pack for later hatching could become a useful survival pack for inclusion for those concerned with these matters.

Our modular Earthworm pit is designed for easy transportation via a trailer of small flat top truck. It can be hoisted via gantry and slings, or Forklift. Our system is in operation throughout Australia and will operate in any climate. When installed and fed with a wide variety of organic wastes, the Earthworms will reduce the volume and enrich the material substantially. The resultant casts, solid and liquid, making perfect plant food. For those that wish to grow earthworms to harvest for resale this system will ensure maximum Earthworm production at all times.

Our modular above ground system allows for easy harvesting of Earthworms and cast, additional modules can be added at any time.

- Each pit will produce approximately 20 litres of liquid cast per day that can be further diluted 50:1 giving a useable liquid fertilizer of 1000 liters per day.
- Solid casts have been shown to have 6 times more available nitrogen than feed material, 7 times more phosphorus, 2 times more calcium and magnesium, and a neutral pH thus confirming Charles Darwin's original observation "of Earthworms: It may be doubted whether there are any other animals which have played so important a part in the history of the world than these lowly but organized creatures."
- Alternatively if the application of the pit is for maximum Earthworm production, then a kilo of worms (approximately 4000) per day can be raised and harvested.
- The control valve, filter, and misting system ensures correct moisture levels, and inbuilt liquid cast filter provides a solid free liquid fertilizer, the optional tarpaulin cover is useful in extreme heat, rain or wind but normally is not required, the method of construction and materials used ensures a very long life.

The Vital Earth Modular Earthworm Pit specifications are:

Length : 3.0m  
Width : 1.5m  
Height : 300mm  
Weight : 700-800 Kg (moisture dependant)  
Material: H3 Grade Treated Pine

Output : 20 litres Liquid cast per week

1 Kg of worms per day

4 Kg of solid cast per day



PO Box 3, Lemon Tree Passage N.S.W. 2319, Australia

Call: 61-49-826080, Fax: 61-49-6278, Ans: 61-49-420010

For additional information contact Darryl Jones of the [Vital Earth](#) company.



# Troubled Times



## Human Diet

### Insects as Human Food - Microlivestock

By William F. Lyon, From *Ohio State Fact Sheet on Entomology*  
(nutritional content chart at website)

The January 2, 1996 Wall Street Journal reported on a "small energetic group of entomologists, farmers and chefs" who are promoting edible insects, a foodstuff better known in academic circles as "Microlivestock." Entomophagy (the eating of insects) has yet to become a day-to-day activity for most people in the United States and Europe in spite of the superior nutritional content of edible insects compared to other animals. Other cultures around the world have made insects a main ingredient in their diets, providing an excellent source of protein. Insects are an inexpensive substitute for meat in many developing countries. In Mexico, grasshoppers and other edible insects are sold by the pound in village markets and are fried before being eaten. Many are sold in cans as fried grasshoppers, chocolate covered ants, etc. Tortillas are served with red and white agave worms in many Mexico city restaurants. Columbian citizens enjoy eating a variety of insects such as termites, palm grubs and ants. Ants are ground up and used as a spread on breads. Popular insects eaten in the Phillipines are June beetles, grasshoppers, ants, mole crickets, water beetles, katydids, locusts and dragonfly larvae. They can be fried, broiled or sauteed with vegetables. In parts of Africa, ants, termites, beetle grubs, caterpillars and grasshoppers are eaten. Some insects such as termites are eaten raw soon after catching, while others are baked or fried before eating. The giant waterbug roasted and eaten whole is a favorite food in Asia. It is easily collected around lights at night around bodies of water. Sago grubs are popular for cooks in Papua New Guinea, most often boiled or roasted over an open fire. Other edible insects eaten in this country include larvae of moths, wasps, butterflies, dragonflies, beetles, adult grasshoppers, cicadas, stick insects, moths and crickets.

In the United States, some restaurants (Washington, DC) are incorporating insects into their recipe books and menus. On the menu are interesting dishes such as stir-fried mealworms and caterpillar crunch (a combination of trail mix and fried caterpillars). Insects can be substituted for everyday recipe ingredients. Tom Turpin, Professor of Entomology at Purdue University enjoys "chocolate chirpy chips" which is a variation of chocolate chip cookies. He uses the chocolate chip cookie recipe but adds roasted crickets to the cookie dough before baking. The cricket's wings and legs are removed before roasting. Most American insect recipes are based on limited types of insects easily purchased from supply companies, pet stores or bait shops. Ants, crickets, grasshoppers and mealworms are the most common insects used for cooking. Over 1,000 insect species are eaten by humans world wide. Not all insects are edible. Some insects are toxic and may create allergy problems. Use only species mentioned in this Entomology fact sheet. Along with nutrition comes the added benefit of good taste. Doug Whitman, Entomologist at Illinois State University, enjoys eating raw yellowjacket larvae which have a sweet, nutty flavor. Gene R. DeFoliart, retired Entomologist at the University of Wisconsin, prefers the greater wax moth larvae (deep-fried will melt in your mouth, tasting like bacon) and crickets deep-fried have a crunchy, tangy flavor. He feels the honey bee has a good chance of becoming an American bug food. A pound of honey bees is about 3,500 bees. They can be put in an oven at low heat for eight hours and then used in flour for cookies. Some feel insect popcorn, using crickets, would be a new theater treat.

Most insects are cheap, tasty and a good natural protein source requiring less land and feed than raising cows or pigs. Many insects are far cleaner than other creatures. For example, grasshoppers and crickets eat



fresh, clean, green plants whereas crabs, lobsters and catfish eat any kind of foul, decomposing material as a scavenger (bottom water feeder). By weight, termites, grasshoppers, caterpillars, weevils, house flies and spiders are better sources of protein than beef, chicken, pork or lamb according to the Entomological Society of America. Also, insects are low in cholesterol and low in fat. If Americans could tolerate more insects (bugs) in what they eat, farmers could significantly reduce the amount of pesticides applied each year. It is better to eat more insects and less pesticide residue. If the U.S. Food and Drug Administration would relax the limit for insects and their parts (double the allowance) in food crops, U.S. farmers could significantly apply less pesticide each year. Fifty years ago, it was common for an apple to have worms inside, bean pods with beetle bites and cabbage with worm eaten leaves. Most Americans don't realize that they are probably already eating a pound or two of insects each year. One cannot see them, since they have been ground up into tiny pieces in such items as strawberry jams, peanut butter, spaghetti sauce, applesauce, frozen chopped broccoli, etc. Actually, these insect parts make some food products more nutritious. An issue of the Food Insects Newsletter reports that 80 percent of the world's population eats insects intentionally and 100 percent eat them unintentionally.



# Troubled Times



## Testimonials

---

The Australian Aborigines still eat witchetty grubs (big fat larvae found in the bark of trees) live, the only part not eaten is the head. I have tried witchetty grubs cooked in the coals and they are delicious, so are snakes (though somewhat tough and chewy). As we are going to have to put aside our aversions to many things after the pole shift just to survive, it would be a good idea to start conditioning our minds with regard to these issues now.

Offered by [Jan](#).

I've eaten bugs. In fact, every time I'm in the woods; or the back yard, for that matter, I try to find at least one bug and try it out. My purpose is to adapt my psyche to eating them. These days my only thought before popping something new into my mouth is to look for signs that it may be poisonous or taste very bad. Nature usually indicates this by making the creature very flashy - lots of color, contrasting markings, etc. After over two years of this practice I have never felt any ill effects, even after crunching a couple of roaches I came across in the house!

Not the tastiest of treats, in general; and sometimes having to spit out the exoskeleton on things such as roaches and beetles; but not that horrible either. For me, it's mostly the texture that I have to get used to. For instance, a moth tastes mildly like a blade of grass. Just ignore the fuzzy texture. Just chew it up and swallow. That's about it.

Offered by [Ron](#).

But hey! Roaches are not only gross because of *our* loathing to see them in our houses, they are also epidemiologically dangerous, as their scavenging brings them in direct contact with feces and rotting things. Flies are also disease spreaders, as they also prefer to land and dine on feces and rotting things. They are on an entomologists list of disease spreaders! (I have a minor in entomology) So, I hope you washed that roach before you crunched it up.

Offered by [Leila](#).

Yup, I washed them with dishwashing liquid and very hot water. No ill effects. Besides, household roaches found in the US currently don't have access to feces or even rotting things; although this is *not* the case in most third world countries. In the Aftertime, at least for quite a while, I wouldn't touch a roach and certainly not a fly; as there will probably be plenty of rotting corpses, both animal and human. However, not all rotting things are bad. A couple of years after the pole shift I expect that most former vegetation will be rotting, especially trees. It is within these trees that some of the most nutritious insects are to be found. If possible I would thoroughly wash, if for no other reason than that the grubs, etc. are dirty.

The insects do, however, have various bacteria in their digestive systems that could make humans sick because our bodies aren't used to them and haven't produced natural defenses against them. That's another reason that I make a point of eating various insects whenever I run across the opportunity. To start building up natural defenses against these organisms. If one waits until there is no other food, they well could get sick from eating the only thing that's available.

Offered by [Ron](#).



# Troubled Times



## Third World

---

Article by Deborah Churchman found in my son's *Ranger Rick* magazine from the **National Wildlife Federation**, December 1998 issue.

Offered by [Pat](#).

### **They Eat What?**

... dragonflies are delicious. She lives in Bali, an island in the Pacific Ocean. But why, you may ask, would anyone eat insects? Because the little flying buggers make a high-protein meal. And they're free for the catching! People in Bali go "fly fishing" with strips of palmwood. First they dip the strips in sticky sap. Next, they run through the rice fields, waving their sticky sticks. Dragonflies hit the sticks and get glued. Then the people fry the insects in coconut oil- and eat them like candy. Dragonflies don't look yummy to you? ...

This Cambodian woman is about to have a spider inside her. She's eating a fried tarantula - a popular treat in her Southeast Asian country. How'd you like to have that between your teeth?

### **What A Mouthful!**

Indonesian children ... usually eat taro and yams, potato-like tubers. The tubers have lots of vitamins and carbohydrates but not much protein. So for a high protein snack, these kids hunt stinkbugs. For real. They look for the bugs along forest trails. There, big kids climb trees to catch them. The big kids then hand the bugs down to younger children. To cook their catch, the kids stuff the bugs into bags made of leaves. Then they toss the bags into a fire. How do the bugs taste? One American said, "They were better than some worms I've tried." People in Indonesia eat other creepy crawlies as well, including the grubs .... They say they're chewy and taste like bacon.

### **Good 'N' Gooshy**

People in Botswana (a country in southern Africa) eat mopane worms for the same reason that people in the United States eat hamburger - to get lots of protein. But mopane worms have three times as much protein as beef. The worms are really caterpillars of one of the largest moths in the world. Here's a tip: Don't eat the caterpillars when they're young and little. They're yucky then. Wait until they've fattened up on the leaves of mopane trees. The next step is to squeeze the guts out of the caterpillars. ... The guts are filled with a yellow-green slimy mess that smells like ground-up leaves. Then the caterpillars are boiled in salt water ... and spread out to dry. Dried worms last for many months. The worms taste like beef bits with a woody flavor.

### **And Now For Dessert!**

Got a sweet tooth? How would you like a mealworm lollipop? Or a chocolate-covered cricket? What's that you say - you'd rather not eat these? Well, how about a candied apple covered with mealworms? Doesn't look yummy? You can find these insect candies in the United States. Some candy companies here have figured out what people in many other countries already know - insects make great food. Many insects are good-tasting and high in protein. Honey ants, for example, are sweet treats. Fried grasshoppers and crickets taste something like fried shrimp. Fried mealworms taste like pretzels that were once alive. And leaf-footed bugs are fruity.

Insects are also easy to find and free for the taking. So they're good food for people who don't have much money. Does this mean you should eat every insect you can catch? Well, no- some of them taste really bad, and some can make you sick. But you may want to think again about what is and is not OK to eat. And if you see someone munching on an insect- try not to let it bug you.

Based on the book, *Man Eating Bugs: The Art and Science of Eating Insects* by Peter Menzel and Faith D'Aluisio (A Material World Book, Ten Speed Press, Berkley, 1998)





Google™ Custom Search

[Site Map](#) | [Contact](#)

## Academic Programs

[Graduate Program](#)  
[Undergraduate Program](#)ENTfacts: Insect  
Advice[Kentucky Pest News](#)  
[Consejo sobre los insectos](#)

## Programs &amp; Units

[Office of State Entomologist](#)  
[Insects & Human Health](#)  
[UK Hymenoptera Institute](#)  
[CAPS Pest Surveys](#)  
[Graduate Student Club](#)

## Outreach Entomology

[K-12 Entomology](#)  
[Youth/Public Events](#)  
[Bug Camps: K-5 | 11-12](#)[KY Critter Files](#)[4-H Entomology](#)

## Meetings &amp; Events

[Meetings](#) | [Public Events](#)  
[Weekly Seminar](#)  
[Department Calendar»](#)

Visit us:



# Bug Food: Edible Insects

[Insects As Food](#) | [Insect Snacks From Around the World](#) | [Insect-Themed Party Food](#)  
| [Links](#) [En Español](#)

## Insects as Food!?!

by Stephanie Bailey, Entomology Extension Specialist



Activities from this unit would make a very interesting 4-H talk or demonstration to spark interest in a classroom setting.

### Discussion Topic #1: Introduction

The thought of eating insects may be very unsettling to most people in this day and age. However, in many cultures insects and other arthropods have been eaten as a staple and/or as a delicacy. Research this topic in groups, finding out what might be a typical diet for a given culture.

List/Discuss all foods we think are delicacies, and research some of the ingredients. You might start with caviar (fish eggs), or how the cacao bean is processed to become the chocolate we love. Next, discuss some of the arthropods and other invertebrates that are commonly eaten, such as crab, lobster, shrimp, and escargot (snails). Most often these animals are marine. Why wouldn't terrestrial arthropods and snails be just as good? Is it because we can see terrestrial arthropods living day to day? Put forth ideas.

### Discussion #2: Insects as a source of nutrition

In many parts of the world today, insects are a part of people's diets. Why? (Possible reasons might include: they are a good source of protein, easy to find, take up less space than cows, etc.) Their nutritional value is equal to if not better than our traditional meat choices. Which insect is the most nutritious? Which would be the easiest to rear? Try rearing mealworms in the classroom, to use in bug recipes later. Students may also attempt to determine some of the economic impacts such as time and costs in rearing insects, labor to catch insects, shipping costs, etc., compared to grocery prices for other types of meat.

An internet discussion list named entomo-I discussed the topic of edible insects over the course of a few weeks. There were several contributors, and unfortunately some of the names were deleted, but where possible

the names are posted as written. See if this whets your appetite!! (Items are reproduced here without editorial corrections.)

"I want to share some of my experiences. I'm living in Ecuador, South America and I tried some wonderful, tastier and amazing insects here. Near the Ecuador's capital, Quito, there is a small town called Cotacollao where people cooks the white beetles (Scarabaeidae: Cyclocephala). They cooks it with some pork meat and some vegetables. Some people in the Amazonian region eats the cerambicid's larvae and Cicadas."

"I tried the cerambicid (longhorn beetle) larvae, and I can guarantee satisfaction. There are some kinds of ants edible here. One is the lemon ant, that most of the people eats alive (Really delicious, but hard to keep on the mouth). Another delicious ant is the "Hormiga Culona," a big ant that is eaten fried." Gustavo F. Morejon J. BioBanco - Wildlife Monitoring Centre Project International Federation of Scientific Societies & Fundacion Maquipucuna P.O. Box 01.01.1135 E-mail: gmorejon@fiss.org.ec (Internet) Cuenca - Ecuador South America

"Food Insects Newsletter". This excellent newsletter is put out by Dr. Gene DeFoliart three times a year. It was free, originally, but with 2418 copies distributed in 1993, there is now a \$5 fee. Contact Dept. of Entomology, 1630 Linden Dr., University of Wisconsin, Madison, Wisconsin 53706 (checks payable to Board of Regents, University of Wisconsin).

"I have tasted several species including dragonfly, grasshopper, cerambycid larvae, honeybees and termites and have found them all satisfactory. I DO recommend cooking all insects before eating. Grasshoppers, in particular, can carry several parasitic worms that can be passed to humans (so does beef, for that matter.)" Dave Pehling, W.S.U./SNOHOMISH CO. COOPERATIVE EXTENSION

"In relation to edible insects, certainly in Mexico there is a great prehispanic tradition in the cuisine of many insects. Just two examples: 1. In the south of Mexico there is an ant (*Atta cephalotes*), which is consumed in the rainy season, when there is wing females, these ants have 42% of protein and his taste is wonderful. 2. In the mexican states of Oaxaca, Guerrero, Morelos and Veracruz, the people frecuently cook a "salsa," which have as main condiment crushed "jumiles" *Euschistus crenator* and other species of the same genera (Hemiptera:Pentatomidae)[stinkbugs]. These bugs have an aromatic and deep flavor like a mint or cinnamon. Also these bugs are eaten lives with the traditional "tacos"."

"In has been a long standing tradition (since before the Europeans came to Mexico) to use a large variety of insect species in the traditional cuisine of Mexico. There is even a book on insect edible species written by a mexican entomologist. My favorite are redlegged grasshoppers (*Melanoplus femurrubrum*) marinated in lemon juice, salt, and chile (of course)"

"I have found that some of the local grasshoppers are fairly tasty when eaten fresh (ie, live). I've enhanced the entomology education of the neighbor kids by making them fork over a dollar before I'll let them see me eat one." From: "Victoria Nations"

"I've tried several recipes out of "Entertaining with Insects" (available through BioQuip), and have found mealworms to be the tastiest. However, I've tried to present these dishes at a few Biology Dept. functions, and was distressed by the disgusted reactions of my colleagues. I'll admit that getting exoskeletons stuck between your teeth can be a daunting, but I would think that biologists would be more adventurous about eating their study organisms. Alas not." From: Carol Vervalin

"We have a faculty member in my biology department that brings cookies/brownies with meal worms mixed in and garnished with one worm on top before baking. they don't taste bad!"

"We fried moths once (the grey ones) as a survival exercize, just catch them and place them in the pan with a little hot oil. Some salt and pepper might help."

"In Australia, *Oecophylla* are eaten as bush food. Snatch the ant from its activity and bite off the abdomen ... good! a mixture of sweet and sour and quite thirst-quenching."

"According to F.H.E. Philippi, (maybe it was E. Perris), 1864, Zoological Record (I paraphrase, as it's been so long since I saw it): 'There's a tribe in the Andes of South America, which collects species of dryopoid beetles, dries them, grinds them up, and uses them as a spicy additive for food flavouring.'"

### Discussion #3 Food Defect Action Levels: How many bugs have you eaten today?

Many foods we eat have insects or insect parts in them, that we don't see. The Department of Health and Human Services has set a standard called the Food Defect Action Levels, which (to quote a publication) "are set on the basis of no hazard to health... These levels are set because it is not possible, and never has been possible, to grow in open fields, harvest and process crops that are totally free of natural defects."

"The alternative to establishing natural defect levels in some foods would be to insist on increased utilization of chemical substances to control insects, rodents and other natural contaminants. The alternative is not satisfactory because of the very real danger of exposing consumers to potential hazards from residues of these chemicals, as opposed to the aesthetically unpleasant but harmless natural and unavoidable defects."

"Defect action levels do not represent an average of the defects that occur in any of the food categories (averages are much lower). They are the limit at or above which FDA will take legal action against the product and remove it from the market."

Portfolio topic(s): How do you feel about FDAL's, and the idea that some of your food may be contaminated with insects or other defects? What are the tradeoffs? Do you accept the tradeoffs, or do you believe in zero tolerance, even at very high prices and environmental pollution? What about your tolerance to pesticides that are used?

Activity #1 Determine FDAL's for a few common foods (such as hot dogs, flour, noodles, etc., some examples are listed below). Convert these values into pounds per package bought in a grocery store, e. g. per 5 pound bag of flour, 12-ounce can, etc.

Are Bugs A Part of Your Diet?	
Product	Action Level
Apple butter	5 insects per 100g
Berries	4 larvae per 500g OR 10 whole insects per 500g
Ground paprika	75 insect fragments per 25g
Chocolate	80 microscopic insect fragments per 100g
Canned sweet corn	2 3mm-length larvae, cast skins or fragments
Cornmeal	1 insect per 50g
Canned mushrooms	20 maggots per 100g
Peanut butter	60 fragments per 100g (136 per lb)
Tomato paste, pizza, and other sauces	30 eggs per 100g OR 2 maggots per 100g
Wheat flour	75 insect fragmnets per 50g



Source: *The Food Defect Action Levels: Current Levels for Natural or Unavoidable Defects for Human Use that Present No Health Hazard. Department of Health & Human Services 1989.*

Activity #2 Buy a few of these products (generics and/or brand names) and use a microscope to examine the products for parts of insects, rodent hairs, etc. How many, if any, are found? Do they exceed the action level? What would YOUR action level be?

#### Discussion/Activity #4: The Bugfeast

If the class and teachers are adventurous, perhaps a real hands-on way to get to know insects is to eat them (I had a zoology teacher who once said studying helps but you never forget what you eat!). Teachers will probably want to send home a form for parents to sign, allowing students to take part. Activities surrounding the bugfeast may include:

- Creating a menu of bug delicacies (real or imaginary dishes)
- Shopping for the bugfood and other supplies

#### Cleaning and Preparing the Insects (taken from *Entertaining with Insects*)

Insects, like lobster, are best if cooked while alive or fresh frozen. In contrast to beef, lamb, and poultry, postmortem changes rapidly render insects unpalatable. To facilitate meal planning, many species of insects may be kept alive for several days in the refrigerator. In fact, refrigeration before cooking is advised for the more active forms because it slows down their movements and facilitates handling.

Mealworms and crickets are easy to obtain from bait and tackle shops, or from distributors. If mealworms came packed in newspaper, they need to be changed to bran meal or corn meal or starved for 24 hours, to purge their guts. To separate mealworms from any attached food, waste material, or other debris, place a handful of them in a colander and gently toss. Remove any dead worms, and wash the remaining live insects under cool water. Place the worms on paper towels and pat dry. The mealworms are ready to be cooked or frozen for later use. Crickets should be placed in a refrigerator before attempting to wash them, to slow them down. If, before they are completely washed, they become very active, put them back in the refrigerator. You may want to remove the legs, wings, and ovipositor of crickets after dry roasting them.

#### Preparing Dry-Roasted Insects (taken from *Entertaining with Insects*)

Take cleaned insects out of the freezer. Spread them out on a paper-towel covered baking sheet. Bake at 200 degrees Fahrenheit for 1-2 hours, until the insects can be easily crushed with a spoon.

#### Bugfood Recipes

Alternatively, go to gourmet shops, or ethnic shops and buy canned insect treats such as chocolate-covered insects. Dry-roasted insects can be included in most any recipe that could include nuts, such as cookies, breads, brownies, Rice Krispie Treats (a.k.a. Crispy Critter Krispies), etc.

## Invite other classes to sample the bugfood

### Reading List

Taylor, Ronald L., Entertaining with Insects Or: The Original Guide to Insect Cookery, Salutek Publ. Co.

Ramos-Elorduy, Julieta and Peter Menzel, Creepy Crawly Cuisine, Park St. Press, (1998) Naylor, Phyllis R., Beetles Lightly Toasted, Yearling Books, (1989) (ages 9-12)

Manes, Stephen, Chocolate-Covered Ants, Apple Publ.(1993) Holt, Vincent M. Why Not Eat Insects? E. W. Classey Ltd.,Hampton, Middlesex. 1967 (1885).

Taylor, R. L. Butterflies in my Stomach (or: Insects in Human Nutrition). Woodbridge Press Publishing Company, Santa Barbara, California. 1975.

The Food Defect Action Levels: Current Levels for Natural or Unavoidable Defects for Human Use that Present No Health Hazard. Department of Health & Human Services 1989.

*Last updated: 26 Jan 2009*

---

Department of Entomology, University of Kentucky College of Agriculture | Copyright 2010  
S-225 Agricultural Science Center North, Lexington, KY 40546-0091 | 859.257.7450  
[An Equal Opportunity University](#) | [iforms](#) | Last Updated: 1/10/2010

# Troubled Times



## Catching

---

I just read a valuable tip in *The Outdoorsman's Emergency Manual* (1976) by Anthony Acerrano:

*To find aquatic insects, upturn underwater rocks, especially in shallow, fast-moving water. In deeper water, a cloth tied to two poles makes a useful net for collecting the insects. Place the net downstream, near the bottom of the stream. Then start kicking over rocks to disturb the streambed. Incidentally, aquatic insects also make excellent bait for fishing.*

Offered by [Mike](#).



# Troubled Times



## Bugs as Food

From the Survival:Bug site.

Bugs can be crushed and added to stews. This disguises the appearance and reduces the spew factor. Bees and wasps are OK eaten after a good boiling. The poison is basically a protein which disassembles at boiling temperatures. The stinger softens. Pounding them before boiling is effective. Bee and Wasp larvae are delicious! Many insects are edible (grubs, grasshoppers, ants, slugs, maggots, and earthworms to name a few).

Avoid insects which carry disease, are poisonous, have fine hairs, bright colors, or eight or more legs. One of the most dangerous insects is in the cantharidin family (blister beetles). I doubt that you will run into those unless you pop over to the Mediterranean just to munch bug. There are of course many cautions. ... Just a note. Beetles amount to about 40% of the known insects. The larvae of many beetles are very high in fat and protein and make great snacks.

When in doubt about a bug do the insect safety test. And follow these time tested rules.

- Always try to cook insects.
- Never eat bugs you find dead.
- Don't eat bugs that bite back!
- If it smells really bad, don't eat it!

One last thought ... If you have a strong stomach, or at least a clear spew zone for a technicolor yawn ... try maggots. Road kills are often infested with them. Gather a handfull or two, drop your prize into an old sock and rinse in cold clear water a couple of times, then boil. After about five minutes toss in a bullion cube. When it is finished dissolving, settle back to a fine hot stew of what looks like brown rice. It is really a fine meal.



# Troubled Times



## Newsletter

---

I also recommend [The Food Insects Newsletter](#) available for only \$5 from the following address:

Florence V. Dunkel, Ph.D.  
Associate Professor, Editor, Dept. of Entomology, Room 324  
Leon Johnson Hall, Montana State University,  
Bozeman, MT 59717-0302, USA.

[Benjamin Pressley](#)

benjamin@perigee.net

The current edition of *The Millennium Whole Earth Catalog* lists:

**The Food Insect Newsletter**

University of Wisconsin,  
Dept. of Entomology,  
1630 Linden Drive  
Madison, WI 93706

[Chris Smith](#)



# Troubled Times



## Frugal's

---

From *Frugal's Home Page*

Insects as Food Yes! Oui, oui!: There is scarcely any kind of insect which a survivor could not safely eat. Starvation next to impossible! Insects are wonderful food being mostly fat and far more strengthening than either fish or meat. It does not take many insects to keep you fit. (Ask a bear.) Don't be squeamish about eating insects as it is entirely uncalled for. In parts of Mexico the most nutritious food is made from the **eggs of small insects** found in the marshes.

In Japan **draning needles** or **dragon flies** are delicacy. They have a delicious delicate taste so be sure to try them after all millions of Japanese can't be all wrong. **Moths, mayflies** in fact about all the insects found in the woods are very edible = (Good). The only one which gives a bitter taste is the ants because they contain formic acid. **Grasshoppers or locust** are considered a delicacy in many countries. It is best to remove wings and legs & toast the body on a stick. So are **cicadas, termites, locusts and crickets** are *edible*. Remember that *all locusts, crickets, termites, ants, larva* etc. have double advantages; easy to catch and nourishing, fried or roasted gives a better taste and they are an excellent source of *proteins*.

However as for *all* the insects one must remember to cook them all in order to get rid of any parasites. Just remove the head, wings and legs & cook them in steam or fry them. Also **chenille** are good food sources but *avoid* to eat the **chenille a poils** since numerous species of them are toxic.

### **Insects Hunting: (It bugs me?)**

An ancient method for securing already cooked insects, reptiles and small animals is to fire large tracks of grassland and then to comb them for whatever may have been roasted by the fire.

A small light at night is all that you need to get you all the insects you need to keep you in good conditions even Rambozoro or Jane.

If the weather is too cold for flying insects, kick open some rotten logs or look under stones and get some grubs. They keep bear fat and healthy and will do the same for you dear.

Insects can be used as bait to get birds or fishes and that the best time to capture them is in the morning when they are still numbed by the cold night.

### **Ant's Lemonade: (Anyone?)**

Some aborigines have capitalized on the ants' acidity by mashing them in water sweetened with berries or sap to make a sort of lemonade. The eggs and the young of the ant are also eaten.

### **Insects & Worms:**

Best boiled. Cook and mince them by crushing in a can. More acceptable dried on hot rocks and then ground into a powder with which to enrich soups and stews. The large types of worms particularly are eaten in many countries. So eat them before they eat you?!

### **Grubs:**

The white wood burrowing Larvae of Beetles is usually found in rotten logs. Remove the head,

thorax and legs and eat. The eggs *are edible* but are dry and tasteless. Maggots are good to eat too.

**Snails:**

Both aquatic or terrestrial snails are an excellent source of food when obtainable.



# Troubled Times



## Mealworms

---

My family and I visited the Smithsonian last summer and the nice little old lady at the insect displays mentioned bug recipes on their web site. I expect my children will need to know some of these methods of food preparation.

**Gary**

I'm not sure whether you've told your children about what is going to happen with the pole shift or not, but either way I think that you could get them started with a project that they would find fun no matter what age they are. Get them started with a small mealworm farm. I've heard that mealworms can be used in a stirfry and are very tasty. This would have a double benefit. First, if you raised them yourselves you may get over the "dirty bug" thinking that makes wild bugs hard to start eating. Second, it would teach them the basics of cultivating their own food on a small scale. They may think you're weird at first, but show me kids who don't think their parents are weird. They'll appreciate it in the long run.

Offered by [John](#).

Posted on misc.survivalism, the following quote on mealworms:

*Well, I dunno about garden grubs, but fried mealworms are really quite tasty. Crunchy, with a flavor sort of like almond slivers. I believe pet stores sell them (live) to feed to lizards and things. Hm, I should see about picking some up and making my "favorite rice recipe" to share with friends when they come over. Anybody have nutritional or livestocking info for mealworms?*

*Andrew Piskorski  
atp@hopper.unh.edu*





# Troubled Times



## Grasshoppers

I can only speak practically about insects in the US however, it is my experience and also from things I have read that any insect is edible. Priority-wise you would want to avoid insects with poison and stingers, however, there are ways to prepare even these, similar to eating venomous snakes, remove the poisonous parts, then prepare the rest of the insect. Of, course this means having a knowledge of where the poisonous insects poison sacs are located. You also want to remove all parts that would hang in your throat, like legs and wings. It is also best to remove the head in most cases.

All wild meat should be cooked thoroughly, for wild animals contain parasites that can get into your system, this includes insects, even small ones. Insects may be roasted and ground to a powder and mixed in a stew with other edibles. This is more palatable in most cases. This is also practical whenever you have several small things to eat, to make a stew and drink the broth and whatever is cooked in it. In some cases you can even strain out the solids and drink the broth for nutritional value. Most insects are high in nutritional content, like grasshoppers. Grubs are high in fat and nutrition.



One thing to keep in mind in hunting any animal you are going to eat is to never expend more energy in capturing it than it is going to give back to you upon consumption. Observe when insects are least active, if they are a type of insect that is particularly active, like a grasshopper. Grasshoppers crawl to the top of grass blades during the night and become very dormant and still, They are most easily captured in the early morning, while still dormant and smacked with a twig and gathered into a basket or pocket. I have read that Indians would drive the grasshoppers across a field to another group of Indians waiting with dried grass in a row across a field that they would light and roast them on the spot. I have not tested this, so I don't know how practical it would be or if it even works.

[Benjamin Pressley](#)

benjamin@perigee.net



# Troubled Times



## Crickets

---

Here's a recipe from the late 60's *Last Whole Earth Catalog*.

Recipes for eating insects: This recipe comes from parts of Asia and Africa. Insert fried peanuts into cricket's abdomen (preferably cleaned). These prepared crickets are then fried. They are supposedly very tasty to those whose palate accepts them.

[James Do](#)

One recipe I learned to enjoy. The Montagnards would catch crickets put them in a container which had a 2 inch strip of oil painted on the inside. The oil kept the little buggers inside the jar. The little guys would hang out inside the jar for about 24 hours. This gave them a chance to empty their intestinal tracts (the cause of some bitterness in the flavor). After they were "clean" they were dumped into a cloth bag which was then hung by a fire to dry (cook slowly) or left in the pot and heated in situ on a slow fire. When dried they were munched as a tasty snack or used in rice meals. Grass hoppers are prepared in the same way but it is best to pull the legs off before the feast.

[Ron Hood](#)

diogenes@SURVIVAL.COM



# Troubled Times



## Termites

---

The June 20, 1970 (vol.26, no.6) issue of *Science Digest* has a recipe that looks like it would adapt itself to a variety of insects.

1 pint termites  
1 tablespoon vegetable oil  
1/2 teaspoon salt

Remove termite wings, if any. Spread termites on stone to dry in sun. Pour oil in pan and spread dried termites on it. Toast over hot coals until almost crisp. Sprinkle with salt. "It helps the flavor, say those that have tried the recipe, if you eat the termites in handfuls." *Science Digest* credits the Bantu's with this recipe and reminds readers that there is "lots of vitamin B" in termites.

[Chris Smith](#)

Termites aren't all the plentiful in parts of the US, but I suppose that the recipe would be just fine for ants.

[Frank Walsh](#)



# Troubled Times



## Ants

---

I have eaten dried red ants sprinkled on my grits. They are sweet and quite flavorful.

[John Wither](#)

Ants are, for the most, part one of the best bug feasts. The formic acid pretty much disappears when they are boiled. Black ants eaten raw have a semi sweet flavor. Sorta like crunchy raw sugar with legs. We use them to sweeten ephedra tea.

[Ron Hood](#)

diogenes@SURVIVAL.COM



# Troubled Times



## Maggots

---

All I ever do is boil them, thoroughly. Sometimes I get a little white foam on the top of the boiling water, This stuff has an interesting odor. If you want to taste it, it's good to have a cold. Either way, the flavor of the foam isn't bad though I prefer to skim it off. The dogs *love* it! Usually the maggots I collect are from range cattle who've died over the winter. In addition to the maggots I often find the carcass's contain good material for other uses. The stiff skin can be softened and used, there are the tendons, hooves and even some aged beef (occasionally).

[Ron Hood](#)

diogenes@SURVIVAL.COM

Reminds me of something the Danish explorer Knud Rasmussen wrote about his stay with the Netsilik Inuit:

Right alongside the spot where we pitched our camp we found an old cache of caribou meat - two years old I was told. We cleared the stones away and fed the dogs, for it is law in this country that as soon as a cache is more than a winter and a summer old, it falls to the one who has use for it. The meat was green with age, and when we made a cut in it , it was like the bursting of a boil, so full of great white maggots was it. To my horror my companions scooped out handfuls of the crawling things and ate them with evident relish. I criticised their taste, but they laughed at me and said, not illogically:

*You yourself like caribou meat, and what are these maggots but live caribou meat? They taste just the same as the meat and are refreshing to the mouth.*

I guess if you think of it that way, then they are just processed meat. Sort of like tiny, wriggling hot dogs. Maybe thats what he means by eating them with 'relish'.

[Tim Rast](#)

The Inuit people once considered live maggots (fat and protein) a delicacy in their diet, and as a goodwill gesture always offered their guests the first morsels.

Offered by [Jan](#).



# Troubled Times



## Grubs

---

Critters like insects are both nutritious and delicious. They generally taste best cooked--roast or fry grubs, for instance. But unless you find them near fecal or polluted material, it is generally fine to eat most grubs and many other insects raw. Whenever I get hungry on a trail I kick open a rotting log and pop a few in my mouth for energy. Slimy yet satisfying.

[Bryce Rogow](#)

brogo@GATE.NET

In New Guinea (and elsewhere I suppose) they dig up *large* grubs, about 3 inches long, 1 inch diameter. and roast them. They are supposed to taste nutty.

[John Waltz](#)

JWaltz@AOL.COM

Graeme Newman wrote *The Down Under Cookbook* more than 10 years ago. I met him in Albany, New York, in 1988 and traded him a boomerang for one of his cookbooks. One of the recipes is as follows. There may be some errors because I OCR'd with my scanner.

### Witchety Grubs

Witchety grubs (from the Aboriginal witjute, the name of roots in which the grubs are often found) are various larvae that feed in the wood of eucalyptus trees, most often between the bark and the trunk. They are about 1 to 2.5 inches long, with a fat creamy body about the width of a man's thumb, and stumpy legs. The Australian Aborigines who live in the Outback are said to consider them a delicacy. As with most food taken by the Aborigines in the Outback, they eat their witchety grubs raw. I have never tried them prepared in that way. I recommend them cooked as follows, Outback style.

- witchety grubs
- an old piece of metal
- salt and pepper to taste
- a little cooking oil (optional)
- yams

So you're stuck in the Outback without anything except a little salt and pepper! The Outback is desolate often without vegetation, but one is sure to find somewhere a scrap piece of metal left from some failed effort to drive an enormous distance, or maybe from a Mad Maz movie set. Scrub the metal clean, hopefully in a little sand and water from a nearby trickling creek. Prepare a fast, trench fire and place the metal across the top. Immediately place yams in coals beside the fire. After about 2 an hour, when the hot plate is quite hot, drop the witchety grubs down and rapidly roll across the metal plate. Keep rolling until they are browned all over. Remove from heat, allow to cool. Remove ya.ms from coals. Break open yams and serve each yam with a witchety grub nestled in the middle.

On a dare, I once ate a witchety grub cooked according to this recipe. It tasted quite delicious, somewhere between roast pork and chicken, and it stayed down too. But I have to admit that I haven't eaten one since. Grub is a word used by Australians to refer to any larvae found in the garden and elsewhere. When I have asked my American friends what a grub is, they invariably reply that it is a "freeloader" and rarely relate the word to insects (real insects that is).

Australians have their own word for a freeloader: a bludger.

[Ted Bailey](#)

tbailey@ic.net



# Troubled Times



## Cooking

---

Apparently insects have been adding nutrition to our diets for quite some time. It wasn't unusual for hard tack and salt beef to get wormy, that is get **maggots** and other **larva** and men would eat it, because it was all they had. I've eaten **ants** - tart. Accepted technique for eating any insect is to toss them in a basket with coals from your fire then remove legs and wings and eat the body. The larger **tarantulas** apparently taste much like crab. To eat them you need to tie the legs back and then toss them onto a bed of coals. Make sure you suck or split all the meat out of the legs. I also hear that some people dry the insects, pull off the legs and wings and then grind them up and use them as an additive to soups. I've read that **mayflies** were an important part of the diet for Indians in areas where they have large swarms of them.

[Jim Burdine](#)

[jburdine@pipeline.com](mailto:jburdine@pipeline.com)

I did a search on the word "entomophagy" and located the following sites on cooking and eating insects:

- [Huang's Bug Eating](#) page

Offered by [Gerard](#).

I found a pretty extensive insect eaters [Links Page](#).

Offered by [George](#).







ENTOMOLOGY

## Iowa State University's Tasty Insect Recipes

As featured on The Tonight Show with Jay Leno!

### Insect Recipes

- Bug Blox
- Banana Worm Bread
- Rootworm Beetle Dip
- Chocolate Chirpie  
Chip Cookies
- Crackers and Cheese  
Dip with Candied  
Crickets
- Mealworm Fried Rice
- Corn Borer  
Cornbread Muffins
- Chocolate-Covered  
Grasshoppers
- Nutrition
- Where to Buy  
Insects
- Entomology  
Club
- Site Index



Photo © [National Broadcasting Corporation](#), 1993

Recipes compliments of Kathy Gee and Julie Stephens  
(pictured above with Jay Leno) and the Iowa State University  
[Entomology Club](#).

[Click at left for more information!](#)

Disclaimer: The Department of Entomology at Iowa State University is not responsible for gastric distress, allergic reactions, feelings of repulsion, or other problems resulting from the ingestion of foods represented on these pages.

**IOWA STATE  
UNIVERSITY**

# Troubled Times



## Parasites

---

I'm supposed to camp with a friend of mine from south Louisiana this weekend. He says he is gwine-a teach me how to eat dem insects. His theory is that they are very plentiful, and that they require a minimum of energy expenditure to catch. he says "You would be amazed at the food available in a rotting log - look at dem bears, dey eaten grubs". Now from my limited reading on the matter, most insects and such are OK to eat, except for the parasites, etc. that they might be hosting. So the question becomes: if one cooks-em, can he eat with gusto, without worry about ill effects? What can't you eat in the way of grubs and insects? Now if my buddy is popping these little fellows in raw, do I do likewise, or be a woosy and say naw I got a cook-em first?

In a prolonged low light long-term survival situations, grubs, fungus et al, might be a food solution. photosynthesis will be zip, but you will have a plenty of decaying plant matter.

H. Carter Mesick  
hmesick@goldinc.com

Malaria in mosquitoes. Bubonic plague in fleas. Lyme disease in ticks. I have also had the experience of crushing a cricket and finding it full of tapeworms (there's a stimulus for your gorge!).

Wes Gietz



# Troubled Times



## Precautions

---

What does need to be pointed out is that many (but not all) tarantula species (and there are a lot of species in different parts of the world) carry urticating hairs on the abdomen. These are hairs that the spider flicks up off its body into the face of a chasing predator. The hairs are fine and barbed and have a nasty habit of getting into eyes and nasal membranes and staying there. Thus, two things need to be stressed here.

1. Careful handling of the whole spider (be it dead or alive) is necessary, not just the business end with the fangs! Handling the spider with tongs, gloves, or impaled on a stick is probably wise.
2. Rub any body hairs off your cooked tarantula, but not with your bare hands!

Beware tarantulas with bald patches! (This is usually a good sign they have those barbed hairs and aren't afraid to use them!).

Offered by [Phil](#).



# Troubled Times



## Techniques

---

There is a way to delay larvae from pupating, this I saw on tv where somebody made his living breeding maggots. when they were large enough and close to pupation, the maggot-farmer put the maggots in boxes and placed all boxes in a cooling cell. I don't think we'll have a cooling cell in the aftertime though. Well, maybe 2% of those preparing will have to some degree the technology to have one. So we have to be quickly eat the critters before they pupate, which is a matter of timing.

In the case of larvae of beetles I think the beetles can be eaten, too. And should be left to pupate here and there so they can mate and provide new larvae. In order to prevent escape a simple plastic aquarium (they're almost unbreakable, have rounded corners etc.) could be used, over which one fits the top with a lid with gaze/grate in it. Of course, opening it will give some the chance to fly off (some beetles do fly).

Another solution is to make a hole in the side (burn it out with hot iron or something that you can hold in a fire). The plastic will melt and you can cut any shape from the tank. Make the hole at such a size that you can put your arm through it and touch the bottom of the tank. Now take a longstocking, glue it or otherwise firmly attach it to the outside of the hole. One should be able to put one's arm through the stocking, into the tank and take out what one wants. This way no critter will fly off. If you're done, bind a wire around the stocking so it is closed, so even beetles smart enough to reach the stocking can't get out. One can also do this with other critters that fly, like flies, locusts, other types of beetles, crickets. Of course, some beetles, locusts and crickets will be able to know/eat their way through the stocking, so a stronger material might be advised.

Offered by [Michel](#).



# Troubled Times



## Raising Insects

---

I'm planning on acquiring a full seed stock prior to the shift, and I've spent much of the last few months improving my gardening ability and knowledge. However, it occurs to me that intentional [Rearing of Insects](#) might produce more nutritional results with less effort. Conditions may not be adequate for gardening for quite some time, especially with our problems producing enough light.

Offered by [Mike](#).



# Troubled Times



## Snakes

---

I worked in the snake pits of a zoo while in high school and later worked with snakes in the service. Most people who eat snakes prefer larger ones which can be butchered by removing the "rib eye" tenderloin along the spine which will be without bones. It will separate by being pulled away from the spine, usually intact. The balance of the carcass will be exceptionally boney and probably best used for fodder for the crawfish ponds. The skins dry easily and make nice belts or hat bands. If I had to eat the rest for calcium and survival, I would boil it in a stew and soften the bones if it were a large one. Small ones would not be a problem.. Just like chicken nuggets.

Authored by [Jack](#).

Graphics by [Michel](#).



# Troubled Times



## Frog Legs

---

I believe raising of frogs for food to be somewhat practical after the pole shift. Eating frogs may be more palatable for many than bugs. Depending on where one is located on the planet after the pole shift, with all the rain, frogs may even be plentiful. Lots of bugs, water and relatively easy to catch them. Even if not plentiful one could introduce them to the region after the pole shift. They might even be used to indicate when the toxins in the water one is using are too high. Like the parakeets taken into the mines to indicate the presence of methane gas.

Offered by [Mike](#).

In Asia, the frog meat is considered a delicacy, and personally, I prefer frog meat to chicken meat. In Asia, we didn't have to raise them, there were plenty of them in the rural area or in the wet rice field. Up here in Canada, a friend of mine built a fairly large outdoor fish pond complete with water plants to make his pond as natural as he could. He caught a bull frog in the wild and put the frog in the pond, and after the second winter has passed the bull frog has still survived. Somehow, during the winter, the bull frog hibernated.

One catches them at night with a flash light. Just shine the light into the frog's face and catch them by hand. Frog skin is very toxic. There was a case here in Canada, which happened recently. A youngster caught a toad and licked the toad's skin and this youngster was in a coma for several days. One will never find any bacteria on a frog skin. To prepare frogs, one should remove the head and the skin, just keep the legs and the torso. Deep fried or in soup, either way they are delicious.

Offered by [Tian](#).

Almost all frogs excrete poison of some sort through skin glands. So stick to the, legs only for meat, and minus the skin, cleanse meat thoroughly. To raise them you treat them much as you would a tortoise/terrapin, in a tank or pond, providing dry land/stones to feed and bask, and a dry place to hibernate in winter. To feed them it is best to use meal worms (larvae of darkling beetles) these are extremely easy to breed yourself, also live house flies, moths and mosquito larvae. My friend who has been raising frogs from tadpoles, for her grandchildren, has had them in a 24" fish tank for two years now and they have never been outdoors or in the sun they remain happily basking indoors under fluro' lighting with the occasional light from a window. Some are now so fat they can hardly hop for their dinner of meal worms which they love.

Offered by [Jan](#).

Frogs love mosquitoes. We have a swamp behind us with tons of frogs and no problems with mosquitoes.

Offered by [John](#).



# Troubled Times



## Frog Info

---

Here are a few frog farming links:

[Ken's Fish Farm](#)

offers fish & frog farming consultant services & products.

Offered by [Charles](#).





# Troubled Times



## Rats

---

I saw a restaurant on the news last night, located in china, which cooks only rats. Anyway you like em. I thought this might be a feasible meat source. Does anyone know how fast they reproduce? As in, how many rats would it take to maintain a stable population. A natural garbage disposal and source for meat? One could start now building an enclosed rat city. I hear they taste great!

Offered by [Aron](#).

I have no idea about how fast they reproduce, but if kept in a clean environment they should be as healthy and safe to eat as any other food source. I don't have an answer to your question, Aron, but it's an excellent idea!

Offered by [Doug](#).



# Troubled Times



## Snails

---

To prepare snails for eating you can put them in a container with lettuce for a few days, which will help to get rid of the sand from inside them. Also, I think it is very important to cook them as they can carry parasites. I grew up in Perth, Australia and over there all the snails were escaped culinary snails, although I have never eaten any.

Offered by [Jennifer](#).

Will snails live well after the poleshift? I think yes. There will be humid places for them all the time and they love it. I think they eat moss and there will be lots of it during those times. So here is a snail recipe:

1. Wash the snails with water 2 or 3 times, to take the sand/earth away.
2. Put a pot 1/2 full of water with the snails, a little salt and some onions. Some put a beet of garlic for taste. Put a little piquant (hot sauce) if you want.
3. Slow fire until it boils and let it boil for 30 minutes.

Then taste it. You can improvise also!

Offered by [Rui](#).



# Troubled Times



## Carcass

---

How does one identify contaminated meat? We all will run into stale and contaminated or rotting meat of one kind or another. The question is rather than get rid of it what can it be safely used for? Could some of this contaminated meat be safely fed to dogs, bugs, worms, and/or frogs? Can we farm maggots and worms on this stuff? Could at the very least it be used as bait for traps for animals and bate to catch bugs or buried where a long term future garden will be planned? What are some of the things that need to be know to (yuck) intelligently recycle this natural resource? What are the dangers in handling and recycling this stuff?

Offered by [Mike](#).

Contaminated meat can be very dangerous. Some of the toxins present during infection/ decomposition/ toxic contamination will withstand even extraordinary methods of sterilization. Heavy metal poisoning can not be removed by any ordinary decontamination scheme and the pathogens involved are down right scary. The best thing to do with contaminated meat is to destroy it by high temperature burning or bury it very deep underground away from water sources and not within 15 feet of your water table. As to reusing the contaminated meat, please remember that the so called mad cow disease is believed to have been spread mostly by using the discarded flesh, bone and blood of infected cattle as processed ingredients of cattle feed.

Offered by [Ray](#).

A few hints as to what to look for or how to recognize disease or contamination. After you skin the animal, look at the flesh side of hide for small blue, gray, or yellow circles this indicates that the animal has a ring or tapeworm. It's still edible with proper cooking to kill the worms and neutralizes the diseases that can be left behind by regular cooking. I have found the best way for me to do this is to boil the meat in saltwater and vegetable oil before frying or BBQ'ing or roasting to a turn on a spit over an open fire.

For detection on the heart and liver, I have found out that in some cases if the heart and liver look like they have been chewed up a little (about the way a squirrel nibbles in an acorn) this usually indicates that the animal is not only past their prime but had a disease that slowly starts at the heart and moves throughout their bodies. In this case the heart and liver need to be discarded or burned. If you only just discovered this in your meat house or butchering station, then discard as above and wash your meat house or butchering station thoroughly with hot water and wood ash. To look for meat contamination you need only to look at the hide, heart, and liver. Look to see if the pouch (organs) have come in contact with the meat or have been cut and the liquid has gotten on the meat. If you wash the meat in room temp to slightly warm water, there should not be any problems. If you plan to dry the meat then after you wash with water just cure the meat with some salt. The best way to do this is to dilute the salt in some water and soak the meat for about 20-30 minutes.

Offered by [Matthew](#).



# Troubled Times



## Soybeans

Copyright 1997 [Alan T. Hagan](#). All rights reserved.

Republished in part by express permission. Please note [Disclaimer](#) below.

Entire text also available as an [ftp download](#).

An entire university could be founded on the culinary and industrial uses of the soybean. It is by far the legume with the highest protein content in commercial production as well as being the other legume oilseed producer alongside the peanut. The beans themselves are small, and round with a multitude of different shades. Although the US grows a very large percentage of the global supply of these beans, we actually consume virtually none of them directly. Most of them go into cattle feed or are used by industry. What does get eaten directly has usually been processed in some form or fashion. Soybean products range from tofu, to tempeh, to textured vegetable protein and hundreds of other uses. Although they are very high in protein, they don't lend themselves well to just being boiled until done and eaten the way other beans and peas do. For this reason, if you plan on keeping some as a part of your storage program (and you should) you would be well served to begin to learn how to process and prepare them *now* when you're not under pressure to produce. That way you can throw out your mistakes and order pizza, rather than having to choke them down, regardless.



**DISCLAIMER:** Safe and effective food storage requires attention to detail and proper equipment and ingredients. The author makes no warranties and assumes no responsibility for errors or omissions in the text, or damages resulting from the use or misuse of information contained herein. Placement of or access to this work on this or any other site does not mean the author espouses or adopts any political, philosophical or meta-physical concepts that may also be expressed wherever this work appears.



# Troubled Times



**SoyFood Org**

---

You can get a copy of the 1998 [U.S. Soyfoods](#) Directory by calling 800-TALKSOY. This directory lists soyfoods by state, by product, places to get seed etc. I am convinced that soybeans will be essential. The product's versatility is unmatched from flour to a potential energy source, this food should be in everyone's garden.

Offered by [John](#).



# Troubled Times



## Amaranth

[Amaranth](#) is found and grown in India as well as South and Central America. It is adaptable to a wide range of climatic conditions. This characteristic will be especially important in the coming years with great variability and changes in weather and climate.

Offered by [Phil](#).



John Kaprielian

# Troubled Times

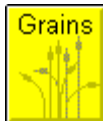

## Buckwheat

---

If Buckwheat is a grain you haven't eaten before, you're about to discover a tiny seed that's packed with hearty goodness. It is sold as buckwheat groats (whole seeds), grits (finely ground), or buckwheat flour. When the seeds are roasted, it's called kasha, an old Russian term. Kasha is available as whole groats and in coarse, medium, and fine grinds. All have a nut-like flavor.

Whatever its form, buckwheat is the best source of high biological protein in the entire plant kingdom. It has over 90% of the value of non-fat milk solids and over 80% of whole egg solids. In other words, buckwheat protein comes closer to animal protein than any other plant and no more calories than wheat products or most other grains. It is high in potassium and phosphorus and the green immature plant contains large amounts of rutin. Buckwheat also contains 50% more vitamin B than wheat. This versatile grain boosts the flavor, fiber and nutrition of a wide variety of recipes including soups, salads, stews, and sweets.

For a buckwheat cookbook, send \$2.50 to cover postage and handling to:

**Pocono Buckwheat Cookbook**

PO Box 440PC

Penn Yan, NY 14527

Birkett Mills in New York state also has [Recipes](#) and growing tips on buckwheat available.

Offered by [Toni](#).

I found buckwheat flour in my local grocery store and my family and I have enjoyed buckwheat pancakes and waffles a couple of times already. They are heavy and very dark in coloration. The recipe also calls for an equal amount of regular wheat. It's very expensive, but I wanted to try it out before I start worrying about how to mill my own, etc.

Offered by [Roger](#).



# Troubled Times



## Black Beans

---

Copyright 1997 [Alan T. Hagan](#). All rights reserved.

Republished in part by express permission. Please note [Disclaimer](#) below.

Entire text also available as an [ftp download](#).

Also known as turtle beans, these small, dark-brownish black, oval-shaped beans are probably best known to us in Cuban black bean soup. They are very commonly used in Central and South America and in China. They tend to bleed very darkly when cooked so they are not well suited to being combined with other beans, lest they give the entire pot a muddy appearance.

**DISCLAIMER:** Safe and effective food storage requires attention to detail and proper equipment and ingredients. The author makes no warranties and assumes no responsibility for errors or omissions in the text, or damages resulting from the use or misuse of information contained herein. Placement of or access to this work on this or any other site does not mean the author espouses or adopts any political, philosophical or meta-physical concepts that may also be expressed wherever this work appears.





# Troubled Times



## Black-eyed Peas

---

Copyright 1997 [Alan T. Hagan](#). All rights reserved.

Republished in part by express permission. Please note [Disclaimer](#) below.

Entire text also available as an [ftp download](#).

Although there is tremendous variation among the many varieties of field peas eaten throughout the Southern United States, it is black-eyed peas that are the most commonly known nationwide. The coloring of field peas is as varied as the rest of the legume family, with black-eyed peas being small and oval-shaped with an overall creamy color and, of course, their distinctive black-eye. Dried field peas cook very quickly and combine very tastily with either rice or cornbread.

**DISCLAIMER:** Safe and effective food storage requires attention to detail and proper equipment and ingredients. The author makes no warranties and assumes no responsibility for errors or omissions in the text, or damages resulting from the use or misuse of information contained herein. Placement of or access to this work on this or any other site does not mean the author espouses or adopts any political, philosophical or meta-physical concepts that may also be expressed wherever this work appears.



# Troubled Times



## Chickpea

---

Copyright 1997 [Alan T. Hagan](#). All rights reserved.

Republished in part by express permission. Please note [Disclaimer](#) below.

Entire text also available as an [ftp download](#).

Also known as the garbanzo bean, it tends to be a creamy or tan color, rather lumpily roundish and larger than dried garden peas. Many have eaten chickpeas, even if they've never seen a whole one. They are the prime ingredient in hummus and falafel and are one of the oldest cultivated legume species known, going back as far as 5400 B.C. in the Near East.

**DISCLAIMER:** Safe and effective food storage requires attention to detail and proper equipment and ingredients. The author makes no warranties and assumes no responsibility for errors or omissions in the text, or damages resulting from the use or misuse of information contained herein. Placement of or access to this work on this or any other site does not mean the author espouses or adopts any political, philosophical or meta-physical concepts that may also be expressed wherever this work appears.



# Troubled Times



## Kidney Beans

---

Copyright 1997 [Alan T. Hagan](#). All rights reserved.

Republished in part by express permission. Please note [Disclaimer](#) below.

Entire text also available as an [ftp download](#).

Just like the rest of the family, kidney beans can be found in wide variety. They come in both light and dark red color in their distinctive kidney shape. Probably best known here in the US for their use in chili, they figure prominently in Mexican, Brazilian and Chinese cuisine.

**DISCLAIMER:** Safe and effective food storage requires attention to detail and proper equipment and ingredients. The author makes no warranties and assumes no responsibility for errors or omissions in the text, or damages resulting from the use or misuse of information contained herein. Placement of or access to this work on this or any other site does not mean the author espouses or adopts any political, philosophical or meta-physical concepts that may also be expressed wherever this work appears.



# Troubled Times



## Lentils

---

Copyright 1997 [Alan T. Hagan](#). All rights reserved.

Republished in part by express permission. Please note [Disclaimer](#) below.

Entire text also available as an [ftp download](#).

Lentils are an odd lot. They don't fit in with either the beans or the peas and occupy a place by themselves. Their shape is different from the other legumes being roundish little discs with colors ranging from muddy brown, to green to a rather bright orangish-red. They cook very quickly compared to beans and have a distinctive flavor. They are much used in Far Eastern cuisine from Indian to Chinese.

**DISCLAIMER:** Safe and effective food storage requires attention to detail and proper equipment and ingredients. The author makes no warranties and assumes no responsibility for errors or omissions in the text, or damages resulting from the use or misuse of information contained herein. Placement of or access to this work on this or any other site does not mean the author espouses or adopts any political, philosophical or meta-physical concepts that may also be expressed wherever this work appears.



# Troubled Times



## Lima Beans

---

Copyright 1997 [Alan T. Hagan](#). All rights reserved.

Republished in part by express permission. Please note [Disclaimer](#) below.

Entire text also available as an [ftp download](#).

In the South, they are also commonly called butter beans. They are one of the most common beans found in this country in all manner of preservation from the young small beans to the large fully mature type. Their flavor is pleasant, but a little bland. Their shape is rather flat and broad with colors ranging from pale green to speckled cream and purple.

**DISCLAIMER:** Safe and effective food storage requires attention to detail and proper equipment and ingredients. The author makes no warranties and assumes no responsibility for errors or omissions in the text, or damages resulting from the use or misuse of information contained herein. Placement of or access to this work on this or any other site does not mean the author espouses or adopts any political, philosophical or meta-physical concepts that may also be expressed wherever this work appears.



# Troubled Times



## Peanuts

---

Copyright 1997 [Alan T. Hagan](#). All rights reserved.

Republished in part by express permission. Please note [Disclaimer](#) below.

Entire text also available as an [ftp download](#).

The peanut is not actually a nut at all, but a legume. Peanuts are another odd species not much like the more familiar beans and peas. Whatever their classification they are certainly not unfamiliar to U.S. eaters. Peanuts have a high protein percentage and even more fat. They are one of the two legume species commonly grown for oilseed in this country, they are also used for peanut butter, boiled and roasted peanuts. Many Central and South American, African and Chinese dishes incorporate peanuts so they are useful for much more than just a snack food or cooking oil.

**DISCLAIMER:** Safe and effective food storage requires attention to detail and proper equipment and ingredients. The author makes no warranties and assumes no responsibility for errors or omissions in the text, or damages resulting from the use or misuse of information contained herein. Placement of or access to this work on this or any other site does not mean the author espouses or adopts any political, philosophical or meta-physical concepts that may also be expressed wherever this work appears.



# Troubled Times



## Pinto Beans

---

Copyright 1997 [Alan T. Hagan](#). All rights reserved.

Republished in part by express permission. Please note [Disclaimer](#) below.

Entire text also available as an [ftp download](#).

Anyone who has eaten Tex-Mex food has probably had the pinto bean. It is one of the most commonly eaten beans in the U.S., particularly in the southwestern portion of the country. It is stereotypically bean shaped with a dappled pattern of tans and browns on its shell. Pintos have a flavor that blends well with many foods. When ground together with white or navy beans they make my favorite home-made version of falafel.

**DISCLAIMER:** Safe and effective food storage requires attention to detail and proper equipment and ingredients. The author makes no warranties and assumes no responsibility for errors or omissions in the text, or damages resulting from the use or misuse of information contained herein. Placement of or access to this work on this or any other site does not mean the author espouses or adopts any political, philosophical or meta-physical concepts that may also be expressed wherever this work appears.



# Troubled Times

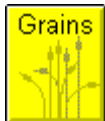

## Oats

Copyright 1997 [Alan T. Hagan](#). All rights reserved.

Republished in part by express permission. Please note [Disclaimer](#) below.

Entire text also available as an [ftp download](#).

Though the Scots and the Irish have made an entire cuisine from oats, they are still mostly thought of in this country as a bland breakfast food. It is seldom found as a whole grain, usually being sold processed in one form or another. Much like barley, oats are a difficult grain to separate from their hulls. Besides their longtime role as a breakfast food, where they can be made very flavorful with a little creative thought, oats make an excellent thickener of soups and stews and a filler in meat loafs and casseroles. Probably the second most common use for oats in this country is in cookies and granolas.



Listed below in order of desirability for storage are the forms of oats most often found in this country. Rolled and cut oats retain both their bran and their germ.

### **Oat groats**

These are whole oats with the hulls removed. They are not often found in this form, but can sometimes be had from natural food stores and some storage food dealers. Oats are not the easiest thing to get a consistent grind from so producing your own oat flour takes a bit of experience.

### **Steel cut oats**

These are oat groats which have been cut into chunks with steel blades. They're not rolled and look like coarse bits of grain. This form can be found in both natural food stores and many supermarkets.

### **Rolled oats**

These are also commonly called "old fashioned" or "thick cut" oats. To produce them, oat groats are steamed and then rolled to flatten. They can generally be found wherever oats are sold. They take longer to cook to suit than do the quick cooking oats, but they retain more flavor and nutrition. This is what most people will call to mind when they think of oatmeal.

### **Quick cooking rolled oats**

These are just steamed oat groats rolled thinner than the regular or old fashioned kind so that they will cook faster. They can usually be found right next to the thicker rolled oats.

### **Instant rolled oats**

These are the "just add hot water" or microwave type of oat cereals and are not at all suited for a long term food storage program. They do, however, have uses in "bug out" and 72 hour food kits for short term crises.

### **Whole oats**

This is with the hulls still on. They are sold in seed stores and sometimes straight from the farmer who grew them. Unless you have some means of getting the hulls off, I don't recommend buying oats in this form. If you do buy from a seed supplier, make certain that they have not been treated



with any chemicals that are toxic to humans.

**DISCLAIMER:** Safe and effective food storage requires attention to detail and proper equipment and ingredients. The author makes no warranties and assumes no responsibility for errors or omissions in the text, or damages resulting from the use or misuse of information contained herein. Placement of or access to this work on this or any other site does not mean the author espouses or adopts any political, philosophical or meta-physical concepts that may also be expressed wherever this work appears.



# Troubled Times

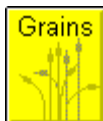

## Barley

Copyright 1997 [Alan T. Hagan](#). All rights reserved.

Republished in part by express permission. Please note [Disclaimer](#) below.

Entire text also available as an [ftp download](#).

Barley is thought by some to be the first grain ever grown by man. It has short, stubby kernels with a hull that is difficult to remove. Excluding barley intended for malting or animal feed, most of this grain is consumed by humans in two forms. The most common is the white, highly processed "pearl" barley that has had most of its bran and germ milled off along with its hull. It is the least nutritious form of barley. The second form it's found in is called "pot" or "hulled" barley and it has been subjected to the same milling process as pearled, but with fewer trips through the polisher. Because of this, it retains more of the nutritious germ and bran. Unless you are prepared to try to get the hulls off I don't recommend buying barley still in the hull. Barley can be milled into flour, but its low gluten content will not make a good loaf of raised bread. It can be combined with other flours that have sufficient gluten to make good raised bread or used in flat breads. Barley flour and flakes have a light nutty flavor that is enhanced by toasting. Whole barley is commonly used to add thickness to soups and stews.



Recently, a hull-less form of barley has become available on the market through a few suppliers. This is whole grain barley with all of its bran and germ intact and should have the most nutrients of any form of this grain available.

**DISCLAIMER:** Safe and effective food storage requires attention to detail and proper equipment and ingredients. The author makes no warranties and assumes no responsibility for errors or omissions in the text, or damages resulting from the use or misuse of information contained herein. Placement of or access to this work on this or any other site does not mean the author espouses or adopts any political, philosophical or meta-physical concepts that may also be expressed wherever this work appears.



# Troubled Times

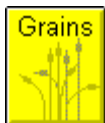

## Wheat

Copyright 1997 [Alan T. Hagan](#). All rights reserved.

Republished in part by express permission. Please note [Disclaimer](#) below.

Entire text also available as an [ftp download](#).

Wheat comes in a number of different varieties. Each variety is more or less suitable for a given purpose based on its characteristics. The most common classifications for wheat varieties are spring or winter, hard or soft, red or white.

The hard wheats have kernels that tend to be small, and very hard and have a high gluten content. Gluten is the protein in grains that enables the dough made from them to trap the gasses produced by yeast fermentation and raise the bread. Low gluten wheat does not produce as good a loaf as high gluten wheat, though they can still be used for yeast breads if necessary. As a general rule, hard varieties have more protein than soft varieties.

The soft varieties have kernels tending to be larger, plumper and softer in texture than hard wheats. Their gluten content is less and these are used in pastries, quick breads, pastas, and breakfast cereals.

Winter wheats are planted in the fall, over winter in the field and are harvested the next summer. Spring wheats are planted in the early spring and are harvested in the fall. Red wheats comprise most of the hard varieties while white wheats comprise most of the soft. Recently, hard white wheats have been developed that are suitable for raised bread making. Some feel the hard white varieties make a better tasting whole wheat bread than the hard red.

The most commonly stored are the hard red varieties, either spring or winter, because of their high protein. They should have a protein content of no less than 12%, with higher the better. The hard white spring wheats are still relatively new and are not yet widespread. They have the same excellent storage characteristics as the hard red wheats.

**DISCLAIMER:** Safe and effective food storage requires attention to detail and proper equipment and ingredients. The author makes no warranties and assumes no responsibility for errors or omissions in the text, or damages resulting from the use or misuse of information contained herein. Placement of or access to this work on this or any other site does not mean the author espouses or adopts any political, philosophical or meta-physical concepts that may also be expressed wherever this work appears.



# Troubled Times

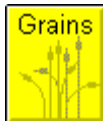

## Buckwheat

---

Copyright 1997 [Alan T. Hagan](#). All rights reserved.

Republished in part by express permission. Please note [Disclaimer](#) below.

Entire text also available as an [ftp download](#).

Buckwheat is another of those foods commonly considered to be a "grain", but which is not a true cereal. It is a close relative to the docks and sorrels. The "grain" itself is a dark, three cornered seed resembling a tiny beechnut. It has a hard, fibrous hull that requires a special buckwheat huller to remove it. Here in the US, it is most often used in pancakes, biscuits and muffins. In eastern Europe and Russia it is known in its toasted form as kasha. In the Far East, it's often made into soba or noodles. It's also a good bee plant, producing a dark, strongly flavored honey. The flour is light or dark depending on how much of the hull has been removed before grinding. Dark flour is far superior nutritionally as you might expect, but it also much more strongly flavored. Buckwheat is one of those foods with no middle ground in peoples opinions - they either love it or they hate it. Like amaranth, it's high in lysine, an amino acid commonly lacking in the true cereal grains.

**DISCLAIMER:** Safe and effective food storage requires attention to detail and proper equipment and ingredients. The author makes no warranties and assumes no responsibility for errors or omissions in the text, or damages resulting from the use or misuse of information contained herein. Placement of or access to this work on this or any other site does not mean the author espouses or adopts any political, philosophical or meta-physical concepts that may also be expressed wherever this work appears.



# Troubled Times

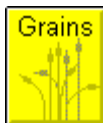

## Rye

Copyright 1997 [Alan T. Hagan](#). All rights reserved.

Republished in part by express permission. Please note [Disclaimer](#) below.

Entire text also available as an [ftp download](#).

Rye is a well known bread grain in this country, though not as popular as wheat. It has dark brown kernels longer and thinner than wheat, but less gluten. Bread made from this grain tends to be somewhat dense unless gluten is added (often in the form of a lot of wheat flour) with color that ranges from pale to dark brown. German pumpernickel, made with unrefined rye flour and molasses, is the blackest, densest form. Rye makes for excellent variety in the diet.



What I am about to say in the following is for those who may be interested in buying field run rye straight from the producer or distributor before it has been cleaned. If you purchase your rye from a food store *after* it has been cleaned, it is not much of a concern.

There is a fungal infection of grain called "ergot". It is attracted to rye more so than other grains, particularly if the growing conditions were damp where it was grown. This fungus causes a nervous disorder known as St. Anthony's fire. When eaten in large quantities the ergot alkaloids can cause constriction of the blood vessels, particularly in the extremities. The effects of ergot poisoning are cumulative and lead to numbness of the limbs and other, frequently serious symptoms.

The fungal disease affects only the flowering parts of many members of the grass family. The fungus bodies are hard, spur like, purple black structures that replace the kernel in the grain head. The ergot bodies can vary in size from the length of the kernel to as much as several times as long. They don't crush as easily as smut bodies of other funguses. When they are cracked open, the inner broken faces can be off-white, yellow, or tan. The infected grain looks very different from ordinary, healthy rye grains and can be spotted easily. Ergot only rarely affects other grains. If you purchase field run rye, you should closely examine it first for the presence of ergot bodies. If you find more than a very few, pass up that grain and look elsewhere.

**DISCLAIMER:** Safe and effective food storage requires attention to detail and proper equipment and ingredients. The author makes no warranties and assumes no responsibility for errors or omissions in the text, or damages resulting from the use or misuse of information contained herein. Placement of or access to this work on this or any other site does not mean the author espouses or adopts any political, philosophical or meta-physical concepts that may also be expressed wherever this work appears.



# Troubled Times



## Corn

Copyright 1997 [Alan T. Hagan](#). All rights reserved.

Republished in part by express permission. Please note [Disclaimer](#) below.

Entire text also available as an [ftp download](#).

Corn is the most commonly grown grain in the U.S., but it is mostly consumed indirectly as animal feed or even industrial feedstock rather than directly as food. Nevertheless, it comes in an amazing variety of forms and, like wheat, some of them are better suited for a particular purpose than others. The varieties intended to be eaten as fresh, sweet corn are very high in sugar content and do not dry or store well. The other varieties are the flint, dent, and popcorns. All of them keep well when they have been properly dried. To a certain extent, they're all interchangeable for purposes of grinding into meal or flour, but some make better meal than flour and vice versa. As a general rule of thumb, the flint varieties make better meal as they have a grittier texture than the dent corns which make better flour. If meal, hominy and grits are what you are most interested in, use the flint type. If you intend to make corn masa for tortillas and tamales, then the dent type is what you want. Popcorn is what you need if you want to pop it for snacks and it can also be ground into meal or flour. It seems to me it makes a very good meal, but it's just a bit gritty for flour. Your mileage may vary.

Popcorn is one form of a whole grain available to nearly everyone if they know where to look. Since it's so popular as a snack food, particularly in movie theaters and events like fairs and ball games, even the smallest of towns will generally have at least one business selling it in twenty five or fifty pound bags. Since it's meant to be eaten it's safe for food. To be at its most poppable, this corn needs to have a moisture content between 13.5%-15.5% which makes it just a little too moist for ideal storage. A small amount of drying will need to be done before it's packed away. If wanted for popping later, it can always be re-hydrated by sprinkling a small amount of water on the kernels, shaking vigorously and allowing it to be absorbed.

Once you've decided between flint, dent or popcorn, you now have to decide upon it's color: there are yellow, white, blue, & red dried varieties. The yellow and white types are the most common by far with the blues and reds mostly being relegated to curiosities, though blue corn has been gaining in popularity these last few years. It should be kept in mind that white corn does not have the vitamin A content of yellow. Since vitamin A is one of the major limiting vitamins in long term food storage, any possible source of it should be utilized so for this reason I suggest storing yellow rather than white corn. Additionally, much of the niacin content of corn is chemically bound up in a form not available for human nutrition unless it has been treated with an alkali. If grits, hominy or corn masa are not a part of your diet and you're storing corn, it is a very good idea to begin to develop a taste for some or all of these alkali treated forms of corn foods.

**DISCLAIMER:** Safe and effective food storage requires attention to detail and proper equipment and ingredients. The author makes no warranties and assumes no responsibility for errors or omissions in the text, or damages resulting from the use or misuse of information contained herein. Placement of or access to this work on this or any other site does not mean the author espouses or adopts any political, philosophical or meta-physical concepts that may also be expressed wherever this work appears.



# Troubled Times

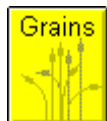

## Fungus

---

There is a wheat fungus spread by airborne spores that has appeared in Africa threatening the wheat crop on the continent. As this fungus spreads through the air, it is only a matter of time before it reaches Europe and then North America and Australia. When this happens, the press will rightly say this isn't the first time. It happened in the 1950's and 50% of the wheat crop was lost.

Offered by [John](#).





# Troubled Times

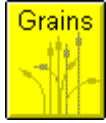

## Milling

---

On page 50 of the July 1999 issue of *Mother Earth News* magazine is an article on growing grains.

### Oats

All except the A. Nuda variety (from Johnny's Selected Seeds, etc.) have inedible hulls and are impractical for the small-scale farmer to remove, but make excellent feed for a horse! The A. nuda variety is literally nude and can be threshed and winnowed like wheat. Sow roughly 1 pound per 100 square foot bed.

Offered by [Roger](#).



# Troubled Times

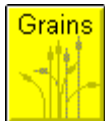

## Gluten

---

On page 50 of the July 1999 issue of *Mother Earth News* magazine is an article on growing grains.

### **Amaranth**

Sow in flats in early spring and thin to the most robust individuals. Plant one to two feet apart (the closer the better, especially in raised beds). Harvest when dry and a tap on the stalk loosens the seeds, or wait until after the first frost and harvest in a bag. Can be ground into flour, but lacks gluten. Can be boiled for porridge using a 1:2 grain to water ratio or popped in a hot pan with *no* oil.

### **Rye and Triticale**

Rye and the cross between it and wheat (triticale) are the most hardy of grains and will tolerate low moisture, poor soil, and abuse or neglect. Fast growing and thereby self-weeding. Plant roughly 1.5 to 3 pounds per 100 square foot bed. Has no gluten, but makes a dark, chewy leavened peasant bread.

Offered by [Roger](#).



# Troubled Times

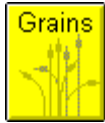

## Easy to Grow

---

Buckwheat is grown in the US primarily as a cover crop, not as a commercial food or industrial crop. Buckwheat will grow almost anywhere. Just broadcast it and harvest when the seeds turn dark brown. Keep the ground moist (by watering daily) until they start to sprout. In thirty days you have a nice 12 to 18 inch tall crop and in another week or two you have an abundance of buckwheat seeds! When the hulls turn from white to dark brown its time to harvest. I harvested at 60 days (when the hulls were black) and let them rest in the sun for a couple of weeks.

I planted about 2 and a half pounds in an 80 square foot bed and harvested more than 10 pounds in less than two months (short growing season means more than one crop in a season - far more efficient than conventional wheat!). They do not stand up to high winds or heavy rains (doesn't harm them, just lays them over and they tend to twist together). Buckwheat grows well in warm weather. I have not tried to grow it in the early Spring. I have tried late fall and it dies quickly with the first light frost. I would suggest you hold off until after the last frost before planting it.

Buckwheat forms blooms along the whole height of the plant at stalk branches. The flowers are small, come in bunches, and are dispersed throughout the entire plant (as low as just above ground level all the way to the tops). The bloom stems start from stem joints and grow upwards. I didn't observe any tendency to self disperse. In fact I had to remove the seeds by hand. My method: pull or cut the plant (at it's base) and turn it upside down, hold it over a bucket and, grasping with both hands, slide a hand downwards (up the plant). If your grip is sufficient, you may be able to do two or three plants at a time. Your bucket will soon become full of leaves, stems, flowers, and of course, seeds!

Next take your bucketsful of seeds, leaves, etc. and dump them into flats or onto plastic or whatever you can use to get the lot spread out as thin as possible and place in the sun. I used flats because I didn't want to leave them out overnight. It took about four days for the leaves and other waste to dry out well enough for me to separate them from the seeds. I did this by grasping a handful and rubbing my hands together - grinding the leaves, etc. into a fine dust while not harming the seeds. You can separate this dust (chaff) by pouring over another bucket in a stiff wind (or use a fan on a still day). I suppose that if you ground the leaves, etc. on a windy day, you might not have much chaff to separate and would not have to do as much pouring. The remaining plant stalks will dry quickly and can either be left on the bed (growing area) and tilled in, composted, or used as a straw type mulch. The dried stalks resembled straw and I suppose that one could use these as food for grazing animals.

I tried leaving some of the plants laid out to dry so I could thresh them in a more traditional way (like regular wheat), but buckwheat is such a lush plant that only the top layer of plants dried out, the rest stayed green and moist and some of the seed at the bottom of the pile sprouted! I just didn't have the space to lay them out one by one without any overlap so my 'piles' were about 6 or 8 plants tall. I didn't want to risk reseeding the bed so I didn't try leaving the plants in the ground long enough to dry out naturally (like wheat). Next time I grow buckwheat, I will leave a few to see if they dry out and can be harvested like conventional wheat.

You can purchase Buckwheat from just about any garden catalog. Look in the cover crops section, you'll find clover, vetch, rape, rye, buckwheat, and sometimes alfalfa and oats. It usually costs in the neighborhood of \$7 per 3 lb. The following comes from R.H. Shumway's 1999 seed catalog. Their prices are a bit high at \$4.99 per lb. I have found it as low as \$5.95 for 5 lb. in other catalogs!

*Northern grown high yielding Buckwheat grows well in any soil. Well known summer green manure crop. Also used for poultry feed, wild bird game food, flour and general grain for stock. Sow in May or June for green manure crop and incorporate into the soil after about a month when flowering begins. For grain harvest, sow 3 months before expected fall frost. Sow 2 to 3 lb. per 1,000 ft. (60 lb. per acre) for green*

*manure crops, 15 lb. per acre when planting for grain harvest.*

Offered by [Roger](#).



# Troubled Times

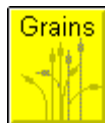

## Suppress Weeds

---

Buckwheat appears to be a great wheat alternative.

Offered by [John](#).

I found this related information from [Cornell](#).

*The general recommendation for harvesting buckwheat is when 70% of the grains are black.*

*Allelopathy helps buckwheat suppress weeds. Growers and extension staff often ask whether buckwheat has been shown to be allelopathic. We know that it shades out weeds well, and that summer tillage for buckwheat planting disrupts perennial weeds. The first report of actual allelopathy has finally come out. S.H. Eom at Kangwon University (in the buckwheat-growing region of Korea) has demonstrated that a compound called diethyl phthalate is produced by buckwheat and is responsible for weed suppression. This weed-suppressing compound is mainly in the stem rather than the shoots, so it is likely to be most active by suppressing weeds after the buckwheat is harvested. It was especially active on pigweed, and not particularly effective on plants in the mustard family.*

Offered by [Mike](#).



# Troubled Times

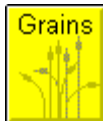

## Millet

Copyright 1997 [Alan T. Hagan](#). All rights reserved.

Republished in part by express permission. Please note [Disclaimer](#) below.

Entire text also available as an [ftp download](#).

Millet is an important staple grain in North China, and India, but is little known as a food in the U.S, mostly being used as bird feed. The grain kernels are very small, round, and usually ivory colored or yellow, though some varieties are darker. The lack of gluten and a rather bland flavor may account for the anonymity of this grain here, but it's alkaline content is higher than other grains and makes it very easy to digest. It also has a higher iron content than any other grain but amaranth. It swells a great deal when cooked and supplies more servings per pound than any other grains. When cooked like rice it makes an excellent breakfast cereal. Though it has little gluten of its own, it mixes well with other flours.



**DISCLAIMER:** Safe and effective food storage requires attention to detail and proper equipment and ingredients. The author makes no warranties and assumes no responsibility for errors or omissions in the text, or damages resulting from the use or misuse of information contained herein. Placement of or access to this work on this or any other site does not mean the author espouses or adopts any political, philosophical or meta-physical concepts that may also be expressed wherever this work appears.



# Troubled Times

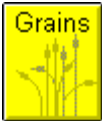

## Sorghum

Copyright 1997 [Alan T. Hagan](#). All rights reserved.

Republished in part by express permission. Please note [Disclaimer](#) below.

Entire text also available as an [ftp download](#).

Sorghum is probably more widely known in this country for the syrup made from the juice squeezed from the canes of one of its many varieties. Also widely called "milo", it is one of the principle cereal grains grown in Africa. Its seeds are somewhat round, a little smaller than peppercorns, with an overall brown color with a bit of red and yellow mixed in. The varieties called "yellow endosperm sorghum" have a better taste. Sorghum is a major feed grain in the southwestern part of the country and is where the vast majority of the national milo production goes to. Like most of the other grains, sorghum is low in gluten, but the seeds can be milled into flour and mixed with higher gluten flours or made into flat breads, pancakes or cookies. In the Far East, it is cooked and eaten like rice, while in Africa it is ground in meal for porridge. It's also commonly brewed into alcoholic beverages.



**DISCLAIMER:** Safe and effective food storage requires attention to detail and proper equipment and ingredients. The author makes no warranties and assumes no responsibility for errors or omissions in the text, or damages resulting from the use or misuse of information contained herein. Placement of or access to this work on this or any other site does not mean the author espouses or adopts any political, philosophical or meta-physical concepts that may also be expressed wherever this work appears.



# Troubled Times

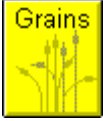

## Triticale

---

Copyright 1997 [Alan T. Hagan](#). All rights reserved.

Republished in part by express permission. Please note [Disclaimer](#) below.

Entire text also available as an [ftp download](#).

Triticale is not a creation sprung whole from the foreheads of Star Trek script writers, tribbles notwithstanding. It is, in fact, a cross or hybrid between wheat and rye. This youngest grain combines the productivity of wheat with the ruggedness of rye and has a high nutrition value. Triticale kernels are gray-brown, oval shaped larger-than-wheat kernels and plumper than rye. It will make a raised bread like wheat flour will, but the gluten is a bit weak so wheat flour is frequently added to strengthen it. Because of the delicate nature of its gluten, excessive kneading must be avoided. This grain can be used in much the same way wheat or rye is. Although it is the youngest of the grains, it's been around for some years now. For reasons I've never understood, triticale has never achieved much popularity. Whether this is for reasons of agricultural production or public acceptance I don't know.

**DISCLAIMER:** Safe and effective food storage requires attention to detail and proper equipment and ingredients. The author makes no warranties and assumes no responsibility for errors or omissions in the text, or damages resulting from the use or misuse of information contained herein. Placement of or access to this work on this or any other site does not mean the author espouses or adopts any political, philosophical or meta-physical concepts that may also be expressed wherever this work appears.





# Troubled Times

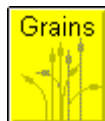

## Kamut

---

An interesting grain to consider for a survival package is called \*Kamut\*. It was brought to the US in '49. Plantings were gradually increased until 60 acers were planted in '88 in Big Sandy, Montana, when it received the registered trademark name Kamut, identifying the organically grown pure uncrossed strain. The '92 harvest produced on 4000 acres in Montana and Canada yielded 5 million pounds.

Genetically, Kamut belongs to the wheat family. Its slightly yellowish grains are larger and longer than wheat kernels. Kamut contains gluten and can be substituted in recipes calling for wheat. It has three advantages over wheat:

1. Many with wheat allergies are enjoying Kamut without negative effects.
2. Whole grain Kamut flour produces lighter, more tender baked goods than whole grain wheat flours.
3. Kamut has 3-5% more protein by weight than wheat. These facts recommend it for inclusion in a survival seed bank.

Offered by [Phil](#).



# Troubled Times

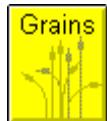

## Spelt

---

This is a grain that can be ground into flour and is a distant cousin of wheat, so to speak. You can learn more about this grain from **Purity Foods**.

Offered by [John](#).



# Troubled Times



## Amaranth

---

Copyright 1997 [Alan T. Hagan](#). All rights reserved.

Republished in part by express permission. Please note [Disclaimer](#) below.

Entire text also available as an [ftp download](#).

Amaranth is not a true cereal grain at all, but is a relative of the pigweeds and the ornamental flowers we know as cockscomb. It's grown not only for its seeds, but for its leaves that can be cooked and eaten as greens. The grain is high in protein, particularly the amino acid lysine which is limited in the true cereal grains. The grains can be milled as-is, or the seeds can be toasted to provide more flavor. The flour lacks gluten, so it's not suited for raised breads, but can be made into any of a number of flat breads. Some varieties can be popped much like popcorn, or can be boiled and eaten as a cereal, used in soups, granolas, and the like. Toasted or untoasted, it blends well with other grain flours.

**DISCLAIMER:** Safe and effective food storage requires attention to detail and proper equipment and ingredients. The author makes no warranties and assumes no responsibility for errors or omissions in the text, or damages resulting from the use or misuse of information contained herein. Placement of or access to this work on this or any other site does not mean the author espouses or adopts any political, philosophical or meta-physical concepts that may also be expressed wherever this work appears.



# Troubled Times



## Quinoa

---

Copyright 1997 [Alan T. Hagan](#). All rights reserved.

Republished in part by express permission. Please note [Disclaimer](#) below.

Entire text also available as an [ftp download](#).

Quinoa is yet another of the "grains" that is not a true cereal. It's botanical name is *Chenopodium quinoa* (pronounced "keen-wah"), and is a relative of the common weed Lambsquarter. The individual kernels are about 1.5-2 mm in size and are shaped rather like small flattened spheres, yellow in color. When quinoa is cooked, the germ of the grain coils into a small "tail" that lends a pleasant crunch. This exotic grain should be thoroughly washed before cooking in order to prevent the cooked product from tasting bitter. There are several varieties of quinoa that have color ranging from near white to a dark brown. The larger white varieties are considered superior and are the most common found.

**DISCLAIMER:** Safe and effective food storage requires attention to detail and proper equipment and ingredients. The author makes no warranties and assumes no responsibility for errors or omissions in the text, or damages resulting from the use or misuse of information contained herein. Placement of or access to this work on this or any other site does not mean the author espouses or adopts any political, philosophical or meta-physical concepts that may also be expressed wherever this work appears.



# Troubled Times

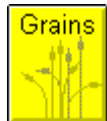

## Flax

---

Talked with some folks from Edmonton this week and they were pitching flaxseed for various food applications. Seems this grain grows well in lots of light but cool temps: 80+ degrees is too much. Combine this with the LED's that were have talked about as a source of light and this might work well. Note also that flaxseed is very nutritious and extremely high in Omega 3.

Offered by [John](#).



# Troubled Times

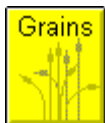

## Rice

Copyright 1997 [Alan T. Hagan](#). All rights reserved.

Republished in part by express permission. Please note [Disclaimer](#) below.

Entire text also available as an [ftp download](#).

Rice is the single most commonly consumed food grain in the world. The U.S. is the leading exporter of it, though we actually only produce about 1% of the global supply. It is my favorite grain and in the form of brown rice, we eat a great deal of it here at the House.

Much like wheat and corn, rice comes in a number of varieties, each with different characteristics. They are typically divided into classes by the length of their kernel grains; short, medium and long.

### Short Grain Rice

Short grain rice is a little softer and bit moister when it cooks and tends to stick together more than the longer rices. It has a sweeter, somewhat stronger flavor than long grain rice.

### Medium Grain Rice

Medium grain rice is not very common in this country. It has flavor like short grain rice, but with a texture more like long grain rice.

### Long Grain Rice

Long grain rice cooks up into a dryer, flakier dish than the shorter grains and the flavor tends to be blander. It is the most commonly found size of rice on the grocery shelves.

Each of these may be processed into brown, white, parboiled or converted and instant rices. Below is a short discussion of the differences between the various types of rices.

### Brown Rice

This is whole grain rice with only the hull removed. It retains all of the nutrition to be found in rice and has a pleasant nutty flavor when boiled. From a nutrition standpoint it is by far the best of the rices to put into storage, but it has one flaw: The essential oil in the germ of the rice is very susceptible to oxidation and soon goes rancid. As a result, brown rice has a shelf life of only about six months from the date of purchase unless given special packaging or storage processing. Freezing or refrigeration will greatly extend its storage life. It's also possible to purchase brown rice from long term food suppliers specially packaged in air tight containers with an inert nitrogen atmosphere. In this kind of packaging, (if properly done), the storage life of brown rice can be extended for years.

### Converted Rice

Converted rice starts as brown rice which undergoes a process of soaking and steaming until it is partially cooked. It is dried and then polished to remove the bran and germ. The steaming process drives some of the vitamins and minerals from the outer layers into the white inner layers. This makes it more nutritious than polished white rice, but also makes it more expensive.



## White Rice

This is raw rice that has had its outer layers milled off, taking with it about 10% of its protein, 85% of its fat and 70% of its mineral content. Because so much of the nutrition of the rice is lost, white rice sold in this country has to be enriched with vitamins to *partially* replace what was removed.

**DISCLAIMER:** Safe and effective food storage requires attention to detail and proper equipment and ingredients. The author makes no warranties and assumes no responsibility for errors or omissions in the text, or damages resulting from the use or misuse of information contained herein. Placement of or access to this work on this or any other site does not mean the author espouses or adopts any political, philosophical or meta-physical concepts that may also be expressed wherever this work appears.



# Troubled Times

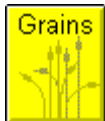

## Per Capita

---

Per capita consumption of flour was 224 lb. per person in 1900. In 1970, it was down to 111 lb., and now up to 148 lb. per person. For each person, you should plan on a way to have available 250 lb. of flour per person. Flour doesn't have to be made from wheat, though that's what we're used to. Food for thought. US flour per capita annual consumption is 150 lbs. per person in 1997. In 1998 it is 148 lbs. per person so 4 people should plan on 600 lbs of flour per year. Flour in cans has a shelf life of 18 months minimum if you can find it in cans. Foodservice distributors (**Sysco, FSA, Alliant, Gordon's**) are the best sources. Almost all of them have cash n carry operations for walk-in customers.

Offered by [John](#).





# Troubled Times

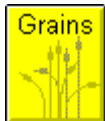

## Harvest/Acre

---

On page 50 of the July 1999 issue of *Mother Earth News* magazine is an article on growing grains. Therein they report that the average harvest is about 30 bushels of wheat per acre. They also report that an acre will supply approximately 2000 pounds of wheat. They further show that one can expect to harvest one bushel of wheat from a conventional (row type) 30 by 30 foot garden plot. A 30 x 30 plot has about 288 square feet of planted space or approximately the equivalent of 3 5 x 20 foot beds. This means one third of a bushel (20 lbs.) of wheat per 100 square foot raised bed. How many beds need to be reserved to provide enough flour for a community? I can't answer that but you could figure that one out by determining your flour usage per year (consider making all your own bread, etc.).

The planting rate suggested by the article is 2 to 8 pecks per acre. A peck is 8 quarts or 1/4 of a bushel (about 15 pounds). You will need from 1/4 to a whole pound of wheat to plant a 100 square foot bed. When broadcast seeding, the more the better and the thicker the growth, the fewer tillers (secondary stems that lower the yield per plant). Hard, red wheat is what you want to grow especially for making bread as it contains gluten (soft, white wheat does not and the flour from it will not rise - it is best for cakes, etc.).

Offered by [Roger](#).



# Troubled Times

**TEAM:**  **Grain**

---

Inexperienced Troubled Times members trying to grow grain for the first time find [Winter Wheat](#) vulnerable to erratic weather.

For more information on developing TEAM activities, contact [Roger](#).

# Troubled Times



## Yeast

---

Copyright 1997 [Alan T. Hagan](#). All rights reserved.

Republished in part by express permission. Please note [Disclaimer](#) below.

Entire text also available as an [ftp download](#).

Yeast is just not a product you can stow away and forget about until you need it next year. It is, after all, a living organism and if it's not alive at the time you need it, you won't get any use out of it. This ancient leavening, brewing, fermenting agent is a single celled microscopic fungus. When we incorporate it into our bread dough, beer wort or fruit juice it begins to reproduce madly (we hope) and produce several by-products. If you're baking, the by-product you want is carbon dioxide which is trapped by the dough and subsequently causes it to rise. In brewing or vintning what is wanted is the ethyl alcohol. Almost all yeasts used for these purposes are in the same genus (*Saccharomyces* or "sugar fungi"), but many different species have evolved and some are more suitable for a particular task than others. It's entirely possible to use grocery store bread yeast to brew beer or ferment wine, but the results may leave a great deal to be desired. It's also possible to use yeast from beer brewing to make bread and from what I've read the results were pretty much indistinguishable from bread yeast.

Leaving aside the brewing and vintning yeasts which are really outside the scope of this FAQ I am going to concentrate on bread yeast. It comes in two generally available forms; compressed or fresh and dried, sometimes called granular or instant active dry yeast. They are different genetic strains of the same species, but have different characteristics.

Compressed yeast is only partly dried (about 70% moisture) and requires refrigeration and keeps even better in the deep freeze. If kept in an air- and moisture-tight container to prevent it from desiccating this type of yeast will keep for a year in the freezer (0 degs F or less, but only about two weeks (maybe a bit more) in the refrigerator. Unless your kitchen is rather chilly it will not keep on the shelf. It should not have a mottled color or a sour odor.

Dried yeast has only an 8% moisture content and comes packed in foil envelopes. The smaller single use packets are not generally vacuum packed, but the larger commercial sized "bricks" of about a pound or two each generally are. They can last for months on the shelf, up till the expiration date which should be clearly stamped on the package. If packaged in the same manner as recommended for compressed yeast above and kept in the refrigerator or freezer it can last for several years. The larger packs of yeast should be transferred to an air and moisture tight container after opening.

Either type of yeast can be tested for viability by "proofing" them. This is nothing more than mixing a small amount of the yeast with an equal amount of sugar in warm water (105-115 deg F for dried; 95 deg F for fresh). Within about five minutes active yeast will become bubbly and begin to expand (at normal room temperature). Yeast which only slowly becomes active can still be used, but you will have to use more of it. If it shows no activity at all, it's dead and should be thrown out.

There is another means of providing yeast for baking besides buying it from the grocery store and that is by using a sourdough starter. I'm not going to address it here, but I will point out that it has a newsgroup all its own (rec.food.sourdough) and several FAQ's devoted to it. Drop in and read for awhile and you'll learn more than you thought you could ever want to know.

---

**DISCLAIMER:** Safe and effective food storage requires attention to detail and proper equipment and ingredients. The author makes no warranties and assumes no responsibility for errors or omissions in the text, or damages resulting from the use or misuse of information contained herein. Placement of or access to this work on this or any other site does not mean the author espouses or adopts any political, philosophical or meta-physical concepts that may also be expressed wherever this work appears.



# Troubled Times



## Alcohol

---

We had a seafaring friend (now deceased) who sailed on a Norwegian whaling ship. In those years pole shift and survival weren't even in our vocabulary so unfortunately I never thought to take notes or ask questions on "how to" so missed a great opportunity to find out how to make potato peel yeast in a bucket, as this is how they made yeast for baking on the high seas (vodka was also a byproduct). Has anyone got any clues to the method for this yeast as we will need many types of yeast. We won't be able to rely on just raisins or even potatoes due to shortages, climate, ad infinitum.

Offered by [Jan](#).

I've made moonshine from sugar, vodka from potatoes, and bourbon from corn. The initial process of fermentation is the same. You mix the food with water and then cover and stir each day. If the purpose is to make alcohol then you need a hydrometer to tell you the alcohol content and when ready then siphon off the liquid and distill at 182 degrees F at sea level (the temperature is a couple degrees above the boiling point of alcohol and is from memory, so you might want to look it up ... also adjust for altitude). What is left after removing most of the liquid is what's left of the food and very concentrated yeast. The "starter" yeast is in the air and gets incorporated during the initial preparation and during stirring.

The process is that the yeast eats the food and expels alcohol and rapidly multiplies. If you let this process go for too long, uncovering and stirring will eventually allow another organism (I think a bacterium, but may be another type of yeast) in from the air. This organism eats alcohol and expels vinegar and will take over the culture. To make the potato peel yeast the only thing I would add besides the potato peel and water would be some sugar to help get that initial yeast colony going faster.

It's so simple to do that you can just try it and see what happens. Keep the stirring time short and give it, say, 10 days. Pour off the liquid and squeeze as much liquid out of the left over material as you can. Taste it. If sour then the batch is bad. Test by using a couple table spoons of the material instead of packaged yeast to make a loaf of bread. Come to think of it, I think the organism that eats alcohol and excretes vinegar is yeast also as sour doe bread starter is very sour, so maybe you would want to try both by letting it sit until it gets a sour taste. If the mixture starts to smell like rotten eggs it has gone bad because of air-born anaerobic bacteria.

Offered by [Ron](#).



# Troubled Times



## Without Yeast

---

Yeast is *not* necessary to make bread. Stone House Bread, 407 S. Main St., Leland, MI 49654. 616-256-2577 uses only organic flour and well water. They don't have e-mail etc. Very quaint place. He doesn't use or need yeast or sugar. They buy organic wheat from a particular farm in the midwest, use only well water, rye, and sea salt. According to the people who work there, the oven is no different then one used in a normal bread making facility. The bread is prepared and baked as you normally bake bread. (I thought it might run hotter and I do suspect it does regardless of what the people at the counter say.) He let's the dough rise overnight in a hot environment. It just doesn't need yeast and sugar.

Offered by [John](#).



# Troubled Times



## Essene Bread

---

From the book *Survival Into the 21st Century* by Viktoras Kulvinskis

Soak 2 or more cups of wheat berries - **red winter wheat** - (overnight or 12 to 24 hours). After soaking, pour off water and let sit 1 to 1-1/2 days depending on how long they were soaked. This can also be done with **rye berries** or even mixed. Now you have 2 or 3 day sprouts ready to grind. Can be ground in the Corona food mill at a fine setting, or in a Chop-Rite wheat grass juicer or in a Champion juicer. Now is where the fun begins.

You can add crushed garlic, kelp powder and ground caraway seeds or add onion (copped fine) and kelp powder or add raisins, apples, & cinnamon. Form into bread sticks (roll in sesame seeds) or patties or whatever (hearts) then bake in the sun for 4, 8 or 12 hours, depending on sun and humidity; or you can put them on your radiator or in your oven at a very low temperature until they are dry.



# Troubled Times



## Raisin Starter

---

The **California Raisin Marketing Board** has released a booklet of bread-making formulas that use a natural yeast starter cultured in raisins. The technique was developed in Japan, which used raisins and sake rice wine as yeast starters in the period after WWII. The yeast starter is formed by mixing water, raisins, sugar and malt syrup. The resulting "brew" is fermented from 4 to 6 days and can be used as a starter for one to two months depending on the season. Bread produced with the raisin starter does not have a noticeable fruit or raisin taste, but is more savory in flavor. The booklet also includes formulas for starters made from beer, sake and lemon. Raisins should be stored away from brick and concrete so as to avoid moisture. They have a 15 month shelf life when stored between 40 and 50 degrees Farenheit. They can also be frozen.

Offered by [John](#).





# Troubled Times



## Grinding Grain

---

I'm looking at purchasing a grain grinder. I know that **Country Living** and **Lehman's** have good products, but what is a good entry level grinder. I'm looking at a back-to-basics model any thoughts or ideas?

Offered by [Mike G.](#)

Thinking primitive, folks doing it by hand use a flat stone and another that they can grip in the hand. Crunch, crush, grind. Mills that use force of water from a water wheel also use this technique, just putting the grain between two heavy rocks and grinding to break open the husks. The result is flour. Prior to this, I think the grain and extraneous particles of leaves or whatever are separated by tossing the lot into the air from a cloth held by more than one person. The light particles drift off in the wind, the heavier fall. Then it's a matter of picking out the pebbles before the grinding starts. (Yuck, gravel between the teeth!)

Offered by [Nancy.](#)

Look at the grinders King Arthur Flowers has several. The **Braun Electric Mill** is \$59.95, The **Magic Mill Plus** is \$255.00 The range of things is wonderful. Anyone can get a Catalog from them:

**The Bakers Catalogue**  
P.O. Box 876  
Norwich, Vermont 05055-0876

Offered by [Gini.](#)



# Troubled Times



## Potato Bread

---

You can grind potatoes into flour in the same manner as any other plant. It's just gooey if it hasn't dried out sufficiently.

Offered by [John](#).



# Troubled Times



## Dandelion Wine

---

### Ingredients

- 4 qts blossoms
- 4 qts boiling water
- 3 lbs sugar
- 1 orange
- 1 lemon
- 1/2 tsp. yeast

Steep the blossoms in the water and then strain them and squeeze the orange and lemon, reserving the juice and peels. Simmer blossom water with the sugar and peels together for 5 minutes. Cool to lukewarm and add reserved juice and yeast. Let ferment as you do for wine.

Offered by [Kristy](#).



# Troubled Times



## Brewed

---

Why not make a still from items you have or can readily get. All you need is a closed pot that holds some pressure some flexible tubing and a heat exchanger (can be made from solid tubing). Study the principle of how to re-condense back to liquid by cooling the vapors. Look around you and see what will work and try it out. A pressure cooker and copper and rubber tubing should be enough to get you started. Improve the process from there.

Offered by [Mike](#).



# Troubled Times



## Herbal Tinctures

---

Tinctures of herbs will become quite useful in the future. Water tinctures will work but are not long lasting. Ethyl alcohol pulls the resinous and oils out of plants better than most other solvents to make a extremely long lasting tincture. This will be important for those handling the sick and ill.

Offered by [Mike](#).



# Troubled Times



## Mash

How to make alcohol for fuel and medicinal purposes. First you must obtain a holding tank, 6 gallons or so. Now, put it where you are going to put your still. Keep your still somewhere with a good breeze or away from people who will smell it. When you are fermenting the stuff, it will smell like puke or even worse. When you are distilling it, your heater might put off smoke. The alcohol will smell like alcohol, and heated mash smells worse than an outhouse. Now go get a load of fresh or frozen whatever (check the list below). Corn will be easiest to deal with because it is very forgiving with beginners. Besides, it's all part of a great American tradition: Moonshine! All kidding aside, remember, in some locales, there are laws against making your own alcohol.

Ingredient	Product
Rye or Potatoes	Vodka
Molasses or Sugar Cane	Rum
Corn	Moonshine
Wheat or Rye	Whiskey
Barley or Rice	Beer
Grapes	Wine
Apple Juice	Hard Cider
Rice	Sake

Put about 10 bags of corn in each holding tank and no more, because the carbon dioxide being released sometime pushes it up and out and you could get the mash all over the ground. What a waste. Besides, it will start to rot in the ground and smell even worse. Anyway, add just enough lukewarm water to cover the surface and leave the stuff exposed to air for about 2 weeks at room temperature. Fermentation is a living process of the yeast cell which converts sugar, if you can manually add yeast it will help the process along from 1-2 weeks without adding yeast to 3-5 days with, or until the bubbling pretty much stops. Any place that sells beer/wine making supplies is a good source. Room temperature in the dark is best. If you wait too long then you will get vinegar instead of alcohol.

After a few days it will bubble and look and smell like puke, but that's no problem. It should do that. Just be sure you've got adequate ventilation. Installing a small fan in your holding tank is no problem. Drilling holes in the sides of plastic or metal with a sharp drill bit is easy. Drill two holes near the top, where there won't be any corn (fans do tend to heat up and short circuit when exposed to water) and insert two tubes. Make the fan blowing air into your jug, and not out. The mist from the mash will wear it down after awhile.

Offered by [Steve](#).



# Troubled Times



## Still

Now, for the still. This is complicated, so bear with me. First, take a big beaker or something like it and put a big tube going out the top. You should glue around this tube, so none of the gas will escape. Now, run a smaller tube into the side of the bigger tube, and connect a valve to it. Now, connect the other side of the valve to your huge thing of fermented whatever, but make sure the tube connects at the bottom and goes straight across so the pressure of the water will push it along the pipe (pumps get too messy). I mount my holding tank on bricks, so now the whole thing looks like this:

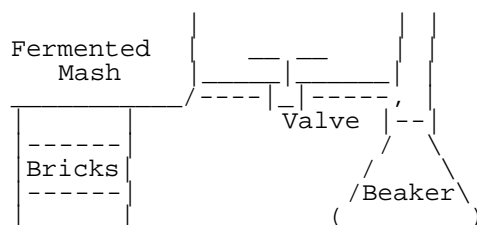

Now, bend the big pipe around, so it is pointing down at a 45 degree angle. Connect a bigger pipe to it. This will be the condenser. Connect a small pipe leading out of the condenser to a big cup or something that you will catch your 200 proof alcohol in. Also, make a rack to put the beaker on, so you can put a can of sterno or a bunsen burner under it. I would recommend putting a thermometer inside the beaker, so you can leave the temperature just above the boiling point of ethyl alcohol of 173F or 78C. If you don't, you won't get very strong alcohol.

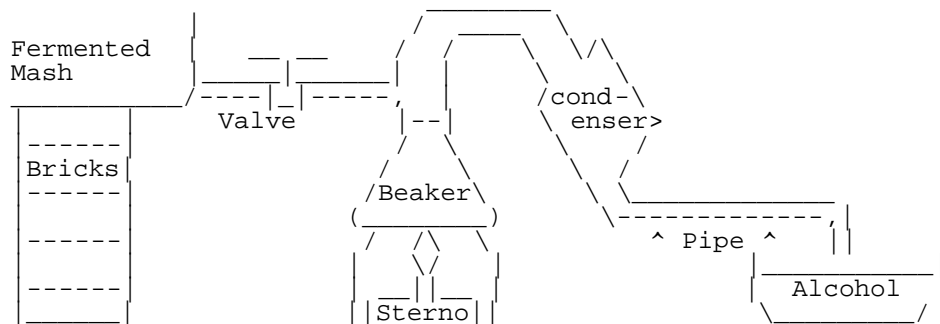

Everything should be a little farther apart than depicted in the picture. However, the longer the tube leading away from the beaker to the condenser, the longer the distillation process will take, so keep that quite close. If you get the alcohol too close to the flame, it might evaporate. Keep that at the end of a long pipe.

Now, there is only one last step. Take a very long length of surgical tubing and wrap it around the condenser, leaving almost no space in between coils. I usually wrap some duct tape around the tubing so it keeps it in place and insulates it a bit. Now, run one end of the tubing to the flower garden and the other end to a valve. Connect the other end of the valve to a hose or some other cold water source. Don't do anything stupid like use liquid nitrogen instead of water cause it won't speed up the distilling process. This is what the finished still should look like:

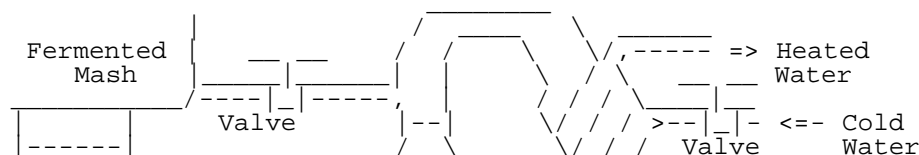

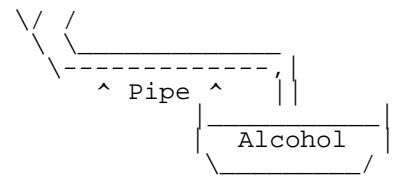
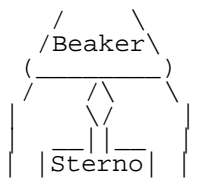
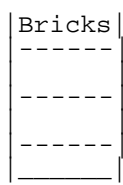

Offered by [Steve](#).





# Troubled Times



## Water Source

---

A friend of mine was going to be doing a lot of distilling cause he made a *huge* still. He was going first- class. He lived near a creek that stayed pretty cool, so he was going to figure out how to use that unlimited supply of water. But he still didn't have any water. He couldn't have a small electric pump, cause he didn't have any electricity. As it turns out, he now has 4 lengths of surgical tubing going down to the water, around his (superhuge) condenser. He made a rock and concrete dam about 3.5 feet high, to get a fast stream of suction. He then ran the tubes down to below the dam, and sucked on them. He siphons the water up and out of the creek, through the condenser, and back into the creek. That thing can run as much as he wants it too, cause he isn't wasting any water, and it won't show up on any water bill.

If you are going to be distilling a lot of stuff, you better make a tube going out of the bottom of the beaker so you can dump out the water and garbage every now and then. Of course, connect it to a valve, so you won't lose any precious alcohol that's trying to turn into steam in the beaker. Make sure any tubes (like this one) aren't made out of glass and can melt. It's bad when tubes melt, cause that means you have to rebuild the still almost from scratch.

Offered by [Steve](#).



# Troubled Times



## Distilling

---

Now that you've got it all set up and the corn (or whatever) is fermented and hooked up to the beaker, turn the valve on a bit to drip some smelly stuff of your holding tank into your beaker. Turn on the sterno or bunsen burner to a high flame so it will heat up the beaker. Turn on the cold-water valve so you have cold water flowing around the condenser at a trickle. If the water coming out of the condenser is cold, turn the valve so even less water is coming out, because you don't want to use too much water. But, if it's warm, it's not doing its job. Keep the water coming out about lukewarm.

As this thing's just starting up, keep a good eye on your thermometer. You want to keep the temperature just above the boiling point of alcohol (which is less than the boiling point of water: 212 degrees) but below the boiling point of water. This is so you can separate the water from the alcohol by turning only the alcohol into steam, and you can get better stuff. Now, watch it, and adjust the valves so the fermented stuff coming out of the holding tank just equals the steam going up the pipe, and it won't fill up or boil dry. Adjust the cold water valve so the water coming out of the surgical tubing is slightly warm. Now, wait. Read a book, but always keep an eye on the still. When the holding tank is empty and the beaker is dry, you are done. Don't expect this to go very quick, however.

If you like almost pure alcohol, distill it again. If you do it right, you could have no water at all inside your liquid high. However, even I haven't been able to get a batch that good. All it takes is practice and getting to know your still. They all have different personalities.

Offered by [Steve](#).



# Troubled Times



## Variations

---

Remember, alcohol is highly flammable and can be explosive if mixed with the right amount of air and ignited with fire or a spark. You want to treat this process with a lot of respect, and do it in the open air away from burnable building, etc. Ran into a documentary on TV on distilling in the everglades once. Was showing a large steel still with steel tubing wrapped in a circle from top to bottom of a water barrel. The water barrel was filled with water to do the cooling.

The alcohol vapor went in at the top. Alcohol liquid dripped out at the bottom. It was being said to pour back in the pot the first bit that comes out. Cleans the tube. Also if the distillation process gets to fast you can get what was call "puking" where the liquid foams up inside the still and gets into the distillation tubing. If this happens you cool it down a bit, and after clean alcohol is coming out you pour back this bad batch back into the still. The still they had was made with a small weighted sealed top so that it could pop off if it got too hot and also became the place for pouring in the source fermented liquid.

For making the heat exchanger used to condense the alcohol after the pole shift, the following items are possibilities. Car heater, car radiator, car gas line wrapped into a coil, and copper tubing coiled. For the container to heat and evaporate the alcohol one could use a modified pressure cooker, old hot water heater, metal garden sprayer, empty propane bottle, or paint sprayer 2-5 gal pot. All of the above would need modifying for proper in and out flows.

Offered by [Mike](#).

Just about any metal container will do, usually what can be found around the farm or junk yard. Many have "rolled their own" using sheet metal or a modified a pot belly stove. 5-6 gallons is a good starting point if you're serious about making building a [Still](#) and alcohol.

Offered by [Steve](#).



# Troubled Times



## Dangers

---

You now have around 198 proof ethyl alcohol in that collecting cup. The stuff may now be safe to drink, but don't. One swig of 200 proof alcohol will probably kill you. 150 proof is only for experienced drinkers (derelicts). The highest proof I've ever had is 138, and it must have been the worst experience of my life, tasted like concentrated potato juice. To give you an idea, beer is around 6 proof, wine coolers are around 12, and wine is around 20. I wouldn't recommend more than 100 proof at all. Also, proof is roughly percentage times 2. 50% alcohol is 100 proof alcohol. 100% is way too high to drink. Never go above 75 percent alcohol (3 parts alcohol, 1 part something else), which is 150 proof. That stuff could kill you.

Wood alcohol is poisonous to drink but makes a great fuel. What you find in the hardware store is usually wood alcohol/rubbing alcohol. If the purity is low, you can distill it to get a higher alcohol content. Actually all alcohol is poison but since the molecule of ethyl alcohol is so close to sugar, your body can digest it. If some moonshiners put some rubbing alcohol or other additives in to increase volume, or failed to remove the impurities, at some point it would be dangerous enough to your health, like blindness or death. It usually takes 2-3 distillations to get a more pure and safer alcohol. The only way I know of is to distill it out, but even that would be difficult at best. Ethyl (drinking) alcohol boils at 173F/78C. Isopropyl alcohol boils at 180F/82C. Methyl alcohol boils at 149F/65C. Benzyl alcohol boils at 401F/205C.

Offered by [Steve](#).

I agree 7 degrees is a bit close for fractional distillation of Isopropyl from Ethyl after a the pole shift. Not practical even before the pole shift.

Offered by [Mike](#).



# Troubled Times



## Fuel

---

Now that it passes the taste test, you can use the pure stuff in place of gas. A little water that's left in it won't hurt since this will raise the octane. Get real familiar with your fuel injectors or carburetor and your spark plugs, You will see them a lot. Alcohol will eventually cover things with a whitish film and will need to be cleaned - often. Also your timing may need to be adjusted, since alcohol has a lower density than gas. If it works, you still may find that the car will quit when you press the brakes. Just fire it back up or put it in neutral when slowing down so you can keep giving it gas as you brake.

Offered by [Steve](#).

I attended a carburetor class once where it was said that the same carburetor can run alcohol if you make the jets bigger by about 60% of the high speed jet hole surface area. Assuming the low speed needle can be adjusted for smooth engine idle. Practically what you do is just drill it out a little at a time until it runs smooth. Now what I don't know is what the water to alcohol mixture ratio was assumed to be. I believe they were talking about Methyl.

Offered by [Mike](#).



# Troubled Times

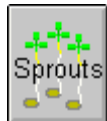

## Many Types

---

Here is a book that details a sproutarian diet and is available from Amazon.com:

*Survival into the Twenty First Century*  
Viktoras Kulvinskis, Richard Jr. Tasca (Editor)  
Paperback / Published 1975

In the book, you will find the following seeds are recommended: Alfalfa, mung bean, lentil, sunflower, wheat, and probably more. In addition, these sprouts are also available at the supermarket where I work: Radish and broccoli. Sprouts make an excellent source of nutrition due to their "live" and "fresh" properties. Seed storage can have purposes, including a sprout diet. In my opinion, a diet supplemented by sprouts is an intelligent plan for post pole-shift survival needs.

Offered by [Charles](#).



# Troubled Times

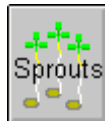

## Addition

---

Here is a great source of amino acid's. Amino acids are protein components. The human body produces almost all of them, but there are some essential amino acids that we have to provide through our food. This is one of the cheapest way you produce them. I'm talking about seeds germination. This kind of food, contains all the essential amino acids plus all of this good points:

- No ground needed
- No sun needed
- No chemical substances needed
- No insecticide needed

The reason for its nutritional power is the endosperm they have (The albumen) which is the seed food before it develops roots and leaves. In addition to this, the germinated seeds, have also phosphorus, calcium, sulfur, copper, iron, nitrogen, all the vitamins, and chlorophyll all of them, in great quantities. And all is done with just seeds. I'm sure this is a very good way to maintain our well nourished body in the Aftertime (and at the present time too!)

You can eat them in thousand ways, (soups, tarts, salads, alone, etc.) Of course, there are other types of seeds like Wheat, Rice, Barley, Oat, Rye and Sunflower. This seeds are germinated using a diferent process, where you let the grass grow to about 12 cm. tall. This type of grass is dificult to eat, you may crush it and add to your juice. When the seeds are ready, you can refrigerate them, and they will mantain freshness for about eight days without loosing their properties.

Offered by [Salvador](#).



# Troubled Times

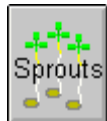

## Sprout Sources

---

### **Sproutamo**

PO Box 5324  
Madison, WI 53705

### **Sprouting Publications**

PO Box 62  
Ashland, OR 97520- 9989

### **The Sprout House**

PO Box 1100  
Great Barrington, MA 01230

### **Gardens of Greenery**

*Vegetarian Times*, Feb. 1989 Article  
Sprout Your Own 25 Cent a Pound Salad Greens All Winter Long.





# Troubled Times

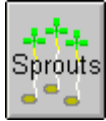

## Purchased

---

I got a recommendation of where to get high quality organic sproutable seeds and beans. This was given to me by a local company that grows and sells sprouts to health food stores and at local farmers markets. Request a *Wholesale Catalog* and order by the 50 or 25 lb. You essentially become a food-co-op. Prices are reasonable. I believe this to be a good source for food storage and possibly seeds for growing more. I have been growing **Kamut, Garbanzo, Soy** and some others from this source and will let you know latter if the second generation sprouts OK. To give you an idea of the prices. For 50 lb. of organically grown **Soy Beans** (\$27.75), **Peas** whole (\$24.90), **Barley** sprouting (\$22.50), **Wheat Berries** sprouting (\$19.90), **Long Grain** brown rice (\$35.75). They ship UPS.

### [Sundance Country Farm](#)

P.O. Box 2429

Valley Center, CA 92082

Toll Free 1-888-269-9888

Fax 760-751-1141

How to use: To prepare this after the pole shift, one would use sprouting technology. This softens up the seeds and beans over a few days. Whether they sprouted or not after years of storage you would not care, they would still be edible. One could add a bit of colloidal silver to the batches of soak water to cut down on parasite growth possibility. This allows for minimal use of scarce cooking energy after the pole shift.

Offered by [Mike](#).



# Troubled Times

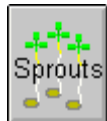

## Easily Stored

---

Sometime ago I purchased 25 lbs. of organic alfalfa seeds from a co-op with the intention of growing sprouts. Then I found that the seeds only last two years before losing their capacity for germination. What I went on to do was put one or two cinnamon sticks in each gallon jar of seeds that I had in the cupboard. After seven years, I was still growing sprouts from the same batch of seeds. **Cinnamon** has an anti-biotic property to it, and I had figured that it could stem the tide of bacteria and mold in the containers. I think it played it a major part in preserving the seeds. So try this when you are creating your seed stocks. Its also important to keep the seeds dry and in a cool place.

Offered by [Charles](#).

Here's an add-on to Charles' idea: Spray or wash any seeds for storage with **Colloidal Silver** and allow to air dry (not in the sun). The mold and bacteria inhibiting ability of Colloidal Silver is simply incredible.

Offered by [Ed](#)



# Troubled Times

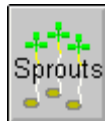

## Sprout Seeds

---

### Soaking Sprouts

1. Soak your sprouts for 6 hours in a quart or gallon sized jar.
2. Drain the water. Rinse in cold water. Drain again.
3. Cover top of jar with cheesecloth, secure with elastic band and store the jar upside down at a 70 degree angle to allow for constant drainage.
4. Rinse sprouts in fresh water at least 2 times daily. In hot weather 3 times daily.
5. On the last day of growth, expose to light so they will naturally green.
6. Drain the sprouts before harvesting them and store in refrigerator in airtight container.
7. Enjoy!

### Sprouting Chart

Seed	Amount	Soaking Time	Harvest Time
Alfalfa	1 T/qt, 3 T/gal	6 hours	5-7 days
Fenugreek	2 T/qt, t T/gal	6 hours	5-7 days
Lentil	1/4 jar seed	6 hours	5-7 days
Mung Bean	1/4 jar seed	6 hours	3-4 days
Radish	1 T/qt, 3 T/gal	6 hours	3-4 days
Red Clover	1 T/qt, 3 T/gal	6 hours	5-7 days
Sunflower	1/4 jar seed	6 hours	1 1/2 to 2 days
Wheat	2 T/qt, 4 T/gal	6 hours	3-4 days

Offered by [Pat](#).



# Troubled Times

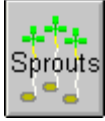

## E. coli

---

### Alfalfa Sprouts Risky for Kids, Elderly - FDA

September 02, 1998

Washington (*Reuters*) - Children, pregnant women and the elderly should not eat alfalfa sprouts until growers find a way to reduce the risk of a deadly bacteria that infects some sprouts, the Food and Drug Administration said. The warning came after California health officials urged vulnerable consumers to stop eating sprouts because of three food poisoning outbreaks in the state. Some 60 consumers in California fell ill after eating tainted sprouts during the past summer, according to federal and state officials. An outbreak of E. coli 0157:H7, a microscopic and especially virulent form of the bacteria, was linked to alfalfa sprouts last year in Michigan and Virginia. Some 36 people were hospitalized for treatment.

University of Wisconsin Department of Bacteriology, Bacteriology 330 Lecture Topics: Pathogenic E. coli has an overview, and the U.S. Food & Drug Administration (FDA) gives more detail on this particularly virulent strain of E. coli. Being that E. coli is an animal bacterium and extremely small, chances are the bacteria are in the dirt and/or irrigating system and can enter through the root system or enter via a tear or cut on the vegetable. Once inside the vegetable it will be impossible to remove it short of cutting out the damaged part. So, using manure that is not properly sterilized to fertilize can be hazardous.

Offered by [Pat](#).



# Troubled Times

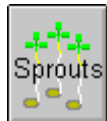

## Salmonella

---

### Co. Recalls Sprouting Clover Seeds

*Associated Press*, June 10, 1999

Pinetree Garden Seeds is voluntarily recalling its Sprouting Clover seeds because they have the potential to be contaminated with Salmonella. The seeds, which came in a 3 oz. plastic bag, were sold via mail order from the company's 1999-2000 seed catalog to customers in the United States and Canada. The individual bags were labeled SP9, Packed for 1999 Sprouting Clover and also were sold as part of the Sprouting for Health Gift Set. The company, based in Gloucester, Maine, said Thursday that the seeds have been implicated by the Centers for Disease Control and Prevention in an outbreak of salmonella in Colorado. The company has not received any reports of illness. But it said customers should destroy any seeds purchased as well as any sprouts produced from the seeds.



# Troubled Times



## Ready to Eat

---

The largest MRE provider is a company called The Wornick Company. Orders anywhere in the world can be filled by this company. If you are an individual, they will try to put you in touch with a distributor close to you. If you are a wholesaler or distributor, the Wornick Company can sell direct to you.

### **The Wornick Company**

McAllen, Texas

Sergio Moreno, [SMORENO@Wornick.com](mailto:SMORENO@Wornick.com)

956-687-9401 x289

Heater Meals is another supplier with a connection with CINPAC, which is a military MRE packer in Cincinnati. I saw this company at a Home Meal Replacement show put on by the Food Marketing Institute in September, 1996. Buyers from Costco, Sam's Club, and Safeway were drooling at the mouth over his stuff. Judging by the buyers, I assume these meals are not available in club stores.

### **Heater Meals Inc.,**

311 Northland Blvd.,

Cincinnati, OH 45246

1-800-503-4483

The meals have an 18-24 month shelf life with food products that are extremely high in sodium, but otherwise OK - Grilled Turkey Breast w/ Gravy & Mashed potatoes, Mashed Potatoes & Beef, Homestyle Chicken and Noodles in Gravy, Cheese Ravioli in Tomato Sauce, Green Pepper Steak w/ Rice, and Chili with Beans. Each entree is 3/4 pound or larger. These products get hot and ready to eat in 14 minutes without electricity, fire or flame. The heating product is made of iron and magnesium. Add water and it produces heat. Each packet contains entree, flameless food heater, fork, salt, pepper, napkin and 2 oz. pouch of water. The boy scouts will never be the same.

Offered by [John](#).

**Note:** MRE can also be purchased from the [Epicenter](#).

I purchased one package last month from **Swede and Sons** which included a variety of assorted meals. The cost was about \$65 if I remember correctly, but the purchase price is on the site.

Offered by [John](#).

You should keep a minimum amount of 1 year per person food reserves. MRE (meals ready to eat) are an excellent source since they can last 10-15 years. Though they can be pricey, they generally come in boxes of 12 meals for around \$60-65 a box.

Offered by [Steve](#).



# Troubled Times



## Short Supply

---

The reason MRE's are in short supply has nothing to do with current production. It has to do with what is termed the *gray or black market*, depending on where the organization that has MRE's for sale falls. After Desert Storm, MRE's were extremely plentiful as the military planned for a two month assault on Iraq that lasted all of a couple days. They had lots of leftovers. Many were given to prisons at great discounts. Many were handed over to food banks. A great number of these were resold to purveyors who have been profiting by selling them on the internet and through end of the world type publications.

Keep in mind that at this point, these things are 8 years old. They are all Julian code dated in case you have purchased them in the past and are curious to know when they were produced. The goal of MRE's is a 3 year shelf life at 90 degrees. Obviously, normal room temperature can extend their shelf life. The military and the people who make MRE's for the military have been trying to establish a commercial market for their product as that would bring down the cost of the product to the military and bring additional revenue to MRE providers who have suffered during the troop cutbacks.

Offered by [John](#).



# Troubled Times



## My Own Meals

---

Another company supplying shelf stable meals, and they are pretty good is [My Own Meals](#) located in Chicago. Their meals have a 5 year shelf life at room temperature.

Offered by [John](#).





# Troubled Times



## Pre-Assembled

---

Pre-assembled food package supplies are another economical alternative. These are pre-packed 1 year or 4 year supply with a variety of different foods stored in #10 cans. I ordered a 1 year supply for a family of 4 which came in 44 boxes totaling about 30 sq. ft of storage. Two good sources are [Marketplace](#), 406-585-9324, and talk with Rodney Bonvicino; and [The Epicenter](#). These sites not only sell food but other items for disaster preparedness.

Offered by [Steve](#).



# Troubled Times



## Dried Food

---

I found a company that sells both meat and vegetarian dried food products. They are guaranteed to last for 10-15 years, although the lady I spoke to claimed that she tried them after 20 years, and they were still good! The company is **Golden Eagle Products**, and the number is 1(800) 447-7911. It is \$1,998.00 for one person per year for the vegetarian system, and \$2,998.00 for the meat included system. All of the meals are gourmet, and includes some good recipes, like apple crisp, and mountain chili. This breaks down to 2.73 per meat meal, and 1.82 per veggie meal. And yes, the vegetarian system contains dried milk products and dried cheese. The calorie content per day is 2,048 for veggie, or 1,868 for meat systems. They will send you a free catalog.

Offered by [Alanna](#).



# Troubled Times



## Insulated Pot

---

When you heat water over a fire, it'll be important to be able to store hot water. There are 'air pots' which keep water hot and dispense with a push on the bellows type top when needed. Probably not much of a service life, but will sure be nice to have when you have to start a fire rather than 'nuc' hot water..

Suggestion from [Jack](#)



# Troubled Times



## Can Opener

---

I knew somebody who crossed mountains from Iran to Turkey with a knife only and survived. This is the tip that I learned from him: How to open a can without any tools. This means with your bare hands. It is very simple:

1. You need a flat rock
2. Scratch the top or bottom of the can on the flat surface of the rock - the can will open in less than one minute.

Try it . It may save your life one day.

Offered by [Chris](#).



- [Product Catalog & Price List](#)
- [New Products](#)
- [Newsletter: Preparedness Info](#)
- [Other Links](#)
- [Sitemap](#)
- [Email](#)



700 East Shawntel Smith Blvd.  
 Muldrow, OK. 74948-1376  
 Phone 918-427-3600  
 Fax 918-427-3214

[Home](#) :: [About Us](#) :: [Search Our Site](#) :: [Contact Us](#)

Displaying 1 through 1 of 1 products.



**Survival Tabs Emergency Food Rations**

Product Code: 1213

***"The Best Possible Nutrition in the Smallest Possible Volume"***

A compact, light weight, life saving food ration for any emergency.

Ultra high calorie food tablets provide all essential vitamins and minerals, protein for strength, fat for endurance, dextrose and lactose for fast energy.

Average consumption of **twelve tabs per day** may be decreased when other food is available in adequate amounts and quality, or increased in times of complete starvation or extreme physical exertion.

The container may be carried easily in a standard G.I. canteen pouch. A separate plastic bag is packed under the lid so that the tabs may be removed and carried in pocket or backpack, while the container is used as an extra canteen. The estimated shelf-life of the Survival Tabs is in excess of ten (10) years, but we would suggest rotating them to ensure maximum food value every 2-3 years.

Like Sign Up to see what your friends like.

Nutritional Information Per Serving

- Serving size ..... 12 tablets
- Servings per container ..... 15
- Calories per serving (approximately 20 cal/tab) ..... 240
- Protein (grams) ..... 4
- Carbohydrate (grams) ..... 26
- Fat (grams) ..... 12
- Sodium per serving (mg) ..... 140

Percentage of US Recommended Daily Allowance (US RDA)

- Protein ..... 12
- Vitamin A ..... 100
- Vitamin C ..... 100
- Thiamin ..... 100
- Riboflavin ..... 100

- Niacin ..... 100
- Calcium ..... 30
- Iron ..... 100

**Ingredients:** Non-fat dry milk solids, sucrose, vegetable oils (including sunflower and/or safflower oil), natural and artificial flavors, sodium ascorbate, vitamin E acetate, niacinamide, ferrous fumarate, zinc gluconate, calcium pantothenate, potassium chloride, manganese glucomate, pyridoxine hydrochloride, riboflavin, thiamine hydrochloride, vitamin A palmitate, vitamin D3, folic acid, potassium iodine, cyanocobalamin.

**180 tabs/container Available in Unflavored or Chocolate please specify when ordering.**

Select Flavor option

<b>1-9</b>	<b>10 +</b>
\$28.75	\$24.75

Shipping: \$5.95

**Qty**



[Tweet](#)

**Displaying 1 through 1 of 1 products.**

Copyright 2012, BA Products Ltd. Co.

[Emergency Preparedness Items](#) | [Disaster Preparedness](#) | [Emergency Drinking Water](#) | [Emergency Survival Items](#) | [Emergency Water Filtration](#) | [Survival Food Supplies](#)

Services by: Ambitious Web

[Web Hosting Company](#) | [Online Shopping Cart Software](#) | [Search Engine Marketing](#)

# Troubled Times



## Ensure

---

Just wanted to remind everyone that people can survive for years on supplemental drinks such as **Ensure**. Don't you think stocking up on cans or a powdered form of nutritional supplements that provide 100% of your daily requirements of calories, vitamins and minerals might be a good solution until things settle down and food can be acquired. Just a thought.

Offered by [Arlene](#).

And I think a very good thought! While I have concerns about just how complete these supplemental drinks are, and their shelf life, we're not really comparing them to a Thanksgiving Feast every day either! What I like about the idea is that these are not sold as survival foods with the corresponding price markup. Where \$1,000 won't get you very far at the MRI or survival food market, I bet you could get quite a few cans of Ensure!

Offered by [Ron](#).



# Troubled Times



## Softened by Heat

---

### What softens the bones in canned fish?

The bones in canned fish are softened by heat, not by oil, as popularly supposed. Canned foods are processed after the containers are sealed. Processing is heating for a certain period at temperatures sufficiently high to kill all organisms that may cause spoilage. It is this heating that softens the bones in canned salmon, sardines, kippered herring and similar fish products.

From the *A Book About a Thousand Things*, by George Stimpson, copyrighted in 1946 by Harper and Brothers. This information could prove useful to folks who may be lucky enough to be in a fish area. I have been through four kids, and worry each time we have fish for dinner. Bones can choke a child, or anyone for that matter. And there may be no doctors around. Sometimes, it's the little things that count.

Offered by [Clip](#).





# Troubled Times



## Leftover Parts

---

Most parts of animals can be used - chicken heads and feet can go into a stockpot as a base for soup, as can other animals' heads, tails and feet. Bowels can be emptied and cleaned, and then the tube used to make sausage casings, putting in ground meat, organs and spices. These can then be boiled or roasted. Don't throw out the blood - it is almost a complete food, and can be used in broth. Be careful to discard the gall bladder (stores bile, used in breaking down fats) - although some Oriental folks use them for some medication - bile can foul the meat, if it spills over it. Bones can be boiled with a small amount of vinegar to release the calcium, the marrow will release fat as well as the storehouse of other vital nutrients it contains as the factory for blood cells. Also remember that boiling bones etc. produces gelatin - high protein content, and excellent for nourishing infants and infirm people.

Hoofs of goats or other parts made of horn can be boiled into glue, probably also edible if nothing else is around. Fat can be used for eating, cooking and for making candles and soap. Rabbit fur can be used to line boots, or sewn together as mitts/gloves/hats. Feathers can be used to make flights for arrows, or kept in a bunch to make pillows or other bedcoverings. Don't forget bones can also be used as needles, in a pinch. Fish parts make great fertilizer, but I'd do that only after I'd used everything to create a fish broth, then throw it out! You should have substantially less waste if you use most of the animal parts. Remaining parts may be useful as fish/animal baits if you are planning to hunt.

Offered by [Cass](#).

For complete nutrition you should eat as much of the animals as possible. The meat is the least nutritious part. The marrow, heart, liver and kidneys should be safe to eat and very nutritious. Save the brains of at least your goats for tanning the goats' skin for clothing (oils from the liver and kidneys can also be used, however these are probably better off eaten). If you eat most of the animals you can survive on nothing else as all nutrients one needs to survive are contained within animals. If you ate the meat alone you would eventually die of malnutrition. This according to John McPherson in *Primitive Wilderness Skills - Applied and Advanced (Naked into the Wilderness II)*.

Offered by [Ryan](#).

If you have any more questions on some of the methods of turning the tendons in to cording or thread, or the animals brains for tanning, please feel free to ask me as I have done this many many times in making hats an mittens as well as numerous articles of clothing.

Offered by [Matt](#).



# Troubled Times



## Marrow

---

Yes the bones are a good source of food as they are very good for you and the marrow (from native belief ) can help you from getting sick when cooked with wild herbs and the inner bark of the birch tree.

Offered by [Matt](#).



# Troubled Times



## Nutrients

---

Honey is probably the only food in the world that can be stored indefinitely without preservatives. It consists of 35% protein and contains half of *all* amino acids. It is also a highly concentrated source of nutrients such as carbohydrates (sugars), B-complex vitamins and vitamins C, D and E. Nutritionally, honey is used to promote energy. For healing purposes, it is used as a salve for burns and wounds because is a natural antiseptic. However, this wonderful substance is not safe for infants under the age of one because honey contains spores that cause botulism and in infants, the spores can colonize in the digestive tract and produce the fatal botulin toxin there.

Offered by [Lyn](#).



# Troubled Times



## Healing Properties

---

My wife and I have stated to do a lot of research on honey and honey bees. Last week we went to a bee farm and spoke with the owner for a few hours. The more I learn about it the more I feel it is one of our keys to survive. My family and I use unprocessed honey for all cuts and burns. The owner of the farm actually strings himself with the bees to help ease the pain of his arthritis. He told us that when an individual is severely burned in China they cover the individual up in honey and wrap them in gauze. I have been amazed at the results for the cuts and burns I have had.

Note: We only use unprocessed honey, found at farmers markets or local health stores.

I am not sure if there will be enough vegetation available after the pole shift to maintain outside colonies. Even so I understand edible honey was found in the Egyptian pyramids. With such a long shelf life it is a product that will be worth its weight in gold. At least it could give flavor to any foods we could be forced to eat. My wife and I have joined a bee keeping club and are going to set up a colony next year. If there is a feasible way to set up a colony around hydroponics we could have a real winning solution.

Offered by [David](#).

What you say about the healing qualities of honey is absolutely true, and in fact honey is just one of the many healing materials available from bee by-products. There's bee propolis, the stuff the bees use to cover the insides of the combs and the supers to prevent infection - that stuff is one of the best natural antibiotics available and is widely used in all your 'vitamin' therapies. Then there's nectar, used for energy and strength, and, of course, queen's food, which is supposed to be vital for women during pregnancy and nursing. There's some more, such as using actual bee-sting therapy. A whole science around it.

Offered by [Sol](#).





# Troubled Times



## Indoor

---

So far I've not been able to find some way in which bees could be utilized in the environment we envision. It seems we won't have many bees in the aftertime, not without the sun. From all the information I've been able to gather, bees are absolutely dependent on sunlight for all of their many cycles. They don't necessarily have to live outdoors, and there is a special bee variety developed in Israel for indoor strawberry pollination. But these bees live in the strawberry hothouse, which is covered with clear plastic which lets all the sunlight through. Whereas in the immediate post-shift environment, we're supposed to have very little sunlight (or am I wrong about that?) If any research is to be done with bees, it has to involve low-light settings, such as a complete hydroponic garden in a very large basement. My bee-man friend says he doesn't know any bees that can live like that. The big problem is creating 'low-light' bees.

Offered by [Sol](#).

One of the projects on my plate is to produce a database/Excel application to determine, based upon the number and types (gender/age) of people at a survival site, the number of calories required per day and thus the amount of hydroponics grown indoors, and from that the amount of artificial lighting - thus electricity generation capacity required. This pre-supposes a "high-tech" settlement capable of growing the required amount of hydroponic vegetation. From preliminary calculations it is clear that such a hydroponic setup will require a very large "shelter". The size of shelter required, and the continuously blooming vegetation appears to be quite adequate for a hive or two of bees. The only problem in this regard is that when working in the hydroponics "shelter", one would probably be required to wear the same sort of protective clothing used by bee keepers. So, my vision of a viable community hydroponic setup would certainly include one or more bee hives and thus the by-product of honey. By the way, the large shelter could easily be a group of interconnected smaller shelters. This wouldn't matter to the bees as long as they can get back to the hive.

Offered by [Ron](#).



# Troubled Times



## Survive the Shift

---

From the magnetic diffusion before and after the pole shift, most bees will probably have trouble finding their way back to their hives. This is already becoming a problem in various areas around the world from what I understand as a bee that cannot find its way back is soon doomed! Question is: How are you going to keep the bees inside when all hell breaks loose on the outside? Are we to plug their hive with wax for the 30-90 days we are likely to be without the sun?

Offered by [Steve](#).

I know that bee keepers use smoke to quiet bees while gathering honey combs. What do bees do in the winter? Do they hibernate in their hives? If so, can a bee keeper induce hibernation somehow? If that were possible, then they could hibernate through the shift! I posed the question "what do bees do in the winter, Hibernate?", to my stepfather, who is a bit of a naturalist. He said when it gets cold, they go into hibernation mode, and all stay in the hive. They need lots of honey, because this is what they survive on through the winter. This is why beekeepers have to be careful how much they remove from the hive - take too much, and they starve to death.

So, I'm thinking that if a group were to try and keep bees, they would have to protect the hives during the shift, somehow make them cold so as to trick them into believing it's winter, and not touch any of the honey for many months into the "healing" period just after the pole shift so they will survive. Also, since the pole shift is to happen in mid May, the colony will be just coming *out* of a winter's hibernation in the northern hemisphere, so should probably be kept from waking in the early spring. This protected hive set up should probably be set up no later than next spring or early summer for the best results. As far as a protective hive set up, I would think that an enclosed space in a protected outbuilding would work. Small opening to the outside for the bees, that could be covered during the pole shift. On the inside, possibly a wooden or Plexiglas box that is openable for future honey gathering, but sealable for the long hibernation.

Of course, this whole idea would only work for an established survival site pre-pole-shift. Honey should be on everyone's list of things to stock up on!

Offered by [Brent](#).



# Troubled Times



## Transporting

---

How did Europeans bring bees to the New World? (I do have a number of bee books in my home library that repeat that the honeybee was originally imported; but none say how.) I don't know how much you all know about bees, but "skeps" are those romantic little old fashioned wicker human-made bee hives that we used back in the olden days. "Stores" means honey. Anyway, from Ireland, here is a fine speculation.

Offered by [Laura](#).

*If I had been around when America was settled, this is what I would have done. I would select several skeps that were "heavy" meaning that there was plenty of stores. I would place them in the bilge's but in a position they could not get wet. (this would approximate to cellar conditions) and I would start my journey at a time when the bees were clustered at the start of winter so that on arrival in spring the survivors would be "ready to go". I would be prepared for losses.*

[Dave Cushman, Beekeeping and Bee Breeding](#)

Surely, post pole shift, there will be some flowers or crops that will need pollinating! Five bee hives and some knowledge could add to our survival chances! If you are going to keep bees, don't forget to get or make a veil, some long gloves, a full overall (all should be in white, and close all the gaps with Velcro so that the little critters don't sneak in there and sting you), a hive tool and smoker, plus a thousand other things! It's a great pleasure to work with them.

Offered by [Pierre](#).





# Troubled Times



## Honey

---

Copyright 1997 [Alan T. Hagan](#). All rights reserved.

Republished in part by express permission. Please note [Disclaimer](#) below.

Entire text also available as an [ftp download](#).

Honey is probably the oldest sweetener known to man. It predates recorded history and has been found in the Egyptian pyramids. It's typically sweeter than granulated sugar by a factor of 25%-40% depending upon the specific flowers from which the bees gather their nectar. This means a smaller amount of honey can give the same amount of sweetening as sugar. The source flowers also dictate the flavor and the color of the sweetener as well. Honey color can range from very dark (nearly black) to almost colorless. As a general rule, the lighter the color and the more delicate the flavor, the greater the price the honey will bring. As you might expect, since honey is sweeter than table sugar, it also has more calories as well - 22 per teaspoon compared to granulated sugar's 16 per teaspoon. There are also trivial amounts of minerals and vitamins in the bee product while white sugar has none. Raw honey may also contain minute quantities of botulinum spores and should not be fed to children under one year of age. Please read the [post](#) from Geri Guidetti concerning this .. Raw honey is OK for older children and adults. Honey is not a direct substitute for table sugar however, it's use in recipes may call for a bit of alteration to get the recipe to turn out right.

Honey comes in a number of forms in the retail market and they all have different storage characteristics:

### **Whole-Comb**

This is the bee product straight from the hive. This is the most unprocessed form in which honey comes, being found as large pieces of waxy comb floating in raw honey. The comb itself will contain many unopened honey cells.

### **Raw**

This is unheated honey that has been removed from the comb. It may contain bits of wax, insect parts and other small detritus.

### **Filtered**

This is raw honey that has been warmed slightly to make it more easy to filter out small particles and impurities. Other than being somewhat cleaner than raw honey it is essentially the same. Most of nutrients remain intact.

### **Liquid**

This is honey that has been heated to higher temperatures to allow for easier filtering and to kill any microorganisms. Usually lighter in color, this form is milder in flavor, resists crystallization and generally clearer. It stores the best of the various forms of honey. Much of the trace amounts of vitamins, however, are lost.

### **Crystallized or Spun**

This honey has had some of its moisture content removed to make a creamy, spread. It is the most processed form of honey.

Much of the honey sold in supermarkets has been blended from a variety of different honeys and some

may have even had other sweeteners added as well. Like anything involving humans, buying honey can be a tricky business. It pays to deal with individuals and brands you know you can trust. You should buy and store honey labeled *US Grade A* or *US Fancy* if buying in retail outlets. However, be aware there are no federal labeling laws governing the sale of honey, so only honey labeled "pure" is entirely honey and not blended with other sweeteners. Honey grading is a matter of voluntary compliance which means some producers may be lax and sloppy about it. This can be a real nuisance when producers use words like "organic", "raw", "uncooked" and "unfiltered" on their labels, possibly to mislead. Fortunately, most honey producers are quite honest in their product labeling so if you're not certain of who to deal with, it is worthwhile to ask around to find out who produces a good product.

Honey may also contain trace amounts of drugs used in treating various bee ailments, including antibiotics. If this is a concern to you, then it would be wise to investigate with your local honey producer what has been used.

**DISCLAIMER:** Safe and effective food storage requires attention to detail and proper equipment and ingredients. The author makes no warranties and assumes no responsibility for errors or omissions in the text, or damages resulting from the use or misuse of information contained herein. Placement of or access to this work on this or any other site does not mean the author espouses or adopts any political, philosophical or meta-physical concepts that may also be expressed wherever this work appears.



# Troubled Times



## Storing Honey

---

Copyright 1997 [Alan T. Hagan](#). All rights reserved.

Republished in part by express permission. Please note [Disclaimer](#) below.

Entire text also available as an [ftp download](#).

Honey is much easier to store than to select and buy. Pure honey won't mold, but may crystallize over time. Exposure to air and moisture can cause color to darken and flavor to intensify and may speed crystallization as well. Comb honey doesn't store as well liquid honey so you should not expect it to last as long.

Storage temperature is not as important for honey, but it should be kept from freezing and not exposed to high temperatures if possible. Either extreme can cause crystallization and heat may cause flavor to strengthen undesirably.

Filtered liquid honey will last the longest in storage. Storage containers should be opaque, airtight, moisture- and odor-proof. Like any other stored food, honey should be rotated through the storage cycle and replaced with fresh product.

If crystallization does occur, honey can be reliquified by placing the container in a larger container of hot water until it has melted.

Avoid storing honey near heat sources and if using plastic pails don't keep it near petroleum products (including gasoline engines), chemicals or any other odor-producing products.

**DISCLAIMER:** Safe and effective food storage requires attention to detail and proper equipment and ingredients. The author makes no warranties and assumes no responsibility for errors or omissions in the text, or damages resulting from the use or misuse of information contained herein. Placement of or access to this work on this or any other site does not mean the author espouses or adopts any political, philosophical or meta-physical concepts that may also be expressed wherever this work appears.



# Troubled Times



## Honey Cautions

---

Copyright 1997 [Alan T. Hagan](#). All rights reserved.

Republished in part by express permission. Please note [Disclaimer](#) below.

Entire text also available as an [ftp download](#).

From: [Geri Guidetti](#) <arkinst@concentric.net>

Duane Miles wrote:

>

>If I recall correctly, honey contains very, very small amounts of the  
>bacteria that cause botulism. For adults, this seldom causes problems.  
>Our immune system is capable of dealing with small numbers of even  
>nasty bacteria, they do it all the time. The problem is when we get  
>large numbers of bacteria, or when our immune system is damaged or not  
>yet developed.

>

>That is where the problem with honey comes in. Some people used to use  
>honey to sweeten milk or other foods for infants. Infants immune  
>systems sometimes cannot handle the bacteria that cause botulism, and,  
>of course, those infants became seriously ill. So pediatricians now  
>advise strongly against using honey for children under a certain age.

Yes, honey can contain the temperature resistant spores of *Clostridium botulinum*, the bacterium that causes botulism. The organism is a strict anaerobe, meaning that it only grows in the absence of molecular oxygen. The problem with infants and honey is that the small, intestinal tract of an infant apparently is sufficiently anaerobic to allow the spores to germinate into actively growing *C. botulinum* organisms. Essentially, the infant serves the same role as a sealed, airtight, contaminated can of beans as far as the organisms are concerned. There in the infant's body the bacteria secrete the dangerous toxin that causes the symptoms of botulism. There have been quite a few documented infant deaths due to honey. As I recall, the studies identifying honey as the source were done in the '80s. Most pediatricians recommend no honey for the first year. It is probably best to check with your own for even later updates ...

Geri Guidetti, *The Ark Institute*

---

Q: My can of honey is bulging. Is it safe to use?

A: Honey can react with the can lining to release a gas especially when stored over a long period of time. Honey's high sugar content prevents bacteria growth. If there is no sign of mold growth, it is safe to eat.  
FREQUENTLY ASKED FOOD QUESTIONS, FN250

**DISCLAIMER:** Safe and effective food storage requires attention to detail and proper equipment and ingredients. The author makes no warranties and assumes no responsibility for errors or omissions in the text, or damages resulting from the use or misuse of information contained herein. Placement of or access to this work on this or any other site does not mean the author espouses or adopts any political, philosophical or meta-physical concepts that may

also be expressed wherever this work appears.



# Troubled Times



## Tropical

---

These are but a few possible candidates for survival. An excellent source for different and alternative fruit is the California Rare [Tropical Fruit Growers](#) association. They have a large listing of suppliers of just about every fruit and food bush/tree that you can think of, as well as online postings in the care, growing, and maintenance of each.

Offered by [Steve](#).

### Avacadoes

The problem with avacadoes is that they are not very tolerant to wind, though will grow in shady areas. The Mexican varieties can tolerate temperatures as low as 19° F. They are a dense evergreen tree upwards of 80 feet in height, though seedlings take anywhere from 8 to 20 years to produce, grafted ones maybe 2 years. The leaves are high in oils and slow to compost. Leaf and seed extracts have been used for a variety of medical applications, including treatment of diarrhea and dysentery and as an antibiotic.

### Bananas

Hardest varieties stop growing when the temperature drops below 53° F. Growth of the plant begins to slow down at about 80° F and stop entirely when the temperature reaches 100° F. Bananas require wind protection for best appearance and maximum yield. They are also susceptible to being blown over.

### Currants

Currants can withstand wind and like shade. Bushes grown from seed bear when two or three years old, best for juices jellies and purees. The red and white varieties are much better tasting than the black. Best grown in temperate zones.

### Feijoa

Feijoa or pineapple guava is a slow-growing evergreen shrub that can reach 15 ft. high and 15 ft. wide. When planted close together, the shrubs make a nice hedge, screen, or windbreak, generally adapted to areas where temperatures stay above 15° F. Tolerates partial shade.

### Guava

Guava is an evergreen, shallow-rooted shrubs or small trees to 33 ft. The adaptability of the guava makes it a serious weed tree in some tropical areas. Not frost tolerant. Older trees, killed to the ground, have sent up new shoots which fruited 2 years later.

### Jaboticaba

Jaboticaba is a slow growing large shrub or small, bushy tree. It reaches a height of 10 - 15 feet and will take full sun or some shade and are small enough fit into many parts of the garden landscape. They are fairly wind tolerant but do not like salty sea air, keep above 24°F.

### Jujube

Jujube is a small, deciduous tree. The wood is very hard and strong. Originated in China where they have been cultivated for more than 4,000 years. Can withstand temperatures to about -28° F. Very high vitamin C content. Besides eating, most popular uses is as a tea for sore throat.

### **Miracle**

Miracle fruit is an evergreen bush or tree growing to 18 ft. in its native habitat, but rarely to 5 ft. otherwise. It is said to do best in partial shade. Intolerant of frost . Although not sweet itself, when a single fruit is eaten and the fleshy pulp allowed to coat the taste buds of the tongue and inside of the mouth, an extraordinary effect occurs. The fruit will now allow one to eat a slice of lemon or lime without wincing. The marvelous aroma and inherent sweetness of the citrus remains but the sourness is almost completely covered. The effect remains for some 30 minutes or more.

### **Olives**

Olives are long-lived with a life expectancy of 500 years. The trees are also tenacious, easily sprouting back even when chopped to the ground. Quite wind-tolerant. Green fruit is damaged at about 28°.

### **Pineapple**

Pineapple is a tropical or near-tropical plant, but will usually tolerate brief exposures to 28°F, and is a herbaceous perennial, 2-1/2 to 5 ft. high with a spread of 3 to 4 ft. Prefers sun though shade resistant, pretty wind resistant.

### **Pomegranate**

Pomegranate will grow and flower in part shade, severely injured by temperatures below 12°F, tolerant of moderately saline water, can take considerable drought.

### **Raisin Tree**

Raisin Tree is native to partially shaded sites in China, cold-hardy to about -10° F, wind hardiness unknown, the "fruit" though eaten, can be made into a beverage called "tree honey" that is said to neutralize hangovers.

### **Sapodilla**

Sapodilla is an attractive upright, slow-growing, long-lived evergreen tree, It is strong and wind-resistant. Can be killed by 30° F. It is highly drought resistant and approaches the date palm in its tolerance of soil salinity. Besides the edible fruit, the bark of the tree has been used as a chewing gum base.

### **Tamarind**

Tamarind becomes a fairly large tree, so this should be kept in mind when planting out the tree. Prefers full sun and is highly wind-resistant with strong, supple branches. Not very frost tolerant.



# Troubled Times



## Mango

---

I've germinated a mango seed and have a little half inch two pronged sprout growing more nodes quite well. I have it in about two gallons of miracle grow potting soil and it seems to be doing well, I had to use the soap treatment on some whiteflies, but otherwise it's fine. Does anyone have any tips or experience with tropical fruit trees? I worried the soil may not be the best suited as tropical soil I assume has more sand content. The soil has been moist for a while, is that a bad thing? I assume at this seedling point all the moisture it can get is good.

Offered by [Aron](#).

Sand is present in the desert sub-tropics, not the tropics, and the mango doesn't 'like' sand, actually. It's a relatively hardy tree though, surprisingly, so that if it encounters sand after it's about six to twelve months old - that doesn't harm it, but it's not advisable to have sandy soil in it's initial growth. It's a much more delicate tree than, say, the fig or the palm. Constant moisture in the soil is also what the tropics are all about (the mango actually hails from India, where it's wet much of the time) - but don't overdo it, you don't want to 'drown' the sapling. Make sure to give it some fertilizer, your dealer should know the kind and the amounts.

If it's a 'normal' mango (not a 'miniature' hybrid one) - you can expect it to grow to a height of about 15-18 ft, and quite wide as well. It's not a bad shade tree, actually. If you have it growing in an apartment - you'll have to transplant it outside, with its soil, into a hole with some fertilizer, and make sure you water it at least once a day. If you live in the actual city itself and have a back-yard or something, remember also that 'delicate' tropical trees can get various kind of leaf-diseases just from the city grime and smog, especially tropical trees with wide leaves like the mango, papaya and avocado. Sprinkle the tree from above often in periods of no rain, and get treatments for the leaf diseases

Offered by [Sol](#).

Though I don't live in California, I am a member of the [California Rare Fruit Growers](#). It has a wealth of information. Plus, the articles in the magazine make it worth subscribing to.

Offered by [Steve](#).

I soaked it for some days in water with B1 mix (plant starter/rooting hormone/wetting agent - comes in a bottle) the dicots split and started growth on each side. I'm assuming it was the magic bottle of potion that got the seedling started. I'm in a top floor apartment with lots of windows, my mom suggested the south side was best, better than the west facing side. It's in one of those clear water containers with the spout on the bottom, so as soon as I see roots hitting the side I'll move it, but I figure I have about a year before that happens as it's only about two months old.

This was just your standard mango from the supermarket, so I think every one would have access to this possibility. I removed the seed from its shell, took off the layer of skin between and soaked the dicot in water with hormone for about five days. I think I've got lucky intuition, as I'd buried it a bit deep but after a few weeks got curious so I dug down and found the sprout struggling and white with the outer edges of the growth browning. As soon as I exposed it the brown parts dried black and the sprout turned green with the light. It's now growing more little nodes at its intersecting points. I only hope I can keep it alive after the shift with artificial light, which I will test as soon as the plant is established and has real leaves.



Offered by [Aron](#).



# Troubled Times



## Grape Mildew

---

In the latest issue of the *California Rare Fruit Growers* (May/June) I came across a letter to the editor about preventing mildew on grapes.

Offered by [Steve](#).

*This is in response to a statement by Rufus Elliott in the Ask the Expert column (Jan/Feb) in which he states that he discarded certain seedless grape varieties because of mildew. I also had a mildew problem with my 'King's Ruby' seedless grapes and wasn't looking forward to a spraying solution either. By accident I discovered a quick, easy solution to the problem. I found that by putting worm castings at the base of the plant, no mildew formed. I haven't seen any mildew in three years. People might want to explore this option with other plants, too. I found it gave the same results on a honeysuckle I have. I hope this information will allow people to more easily grow more varieties.*



# Troubled Times



## Stored Fresh

---

Apart from the obvious of making raisins from grapes. Grapes can be stored for several months. In Victorian England, grapes kept for many months without refrigeration using an ingenious "pre-technology" method. Instead of cutting the cluster from the vine, the whole shoot was cut off several inches on either side of the cluster. The shoot was then inserted into a wine bottle with a bit of charcoal to keep the water fresh, and the bottles placed in a rack at an angle in a cool, windowless brick or stone shed. This let the fruit "keep" as though still on the vine. The cluster stem stayed green and alive and the fruit hung free where air circulation reduced the chances of spoilage. This doesn't work for every variety perfectly but will extend the shelf life of all. "Lakemont" is a good variety that will keep at least 6 months.

A method for storing fresh grapes that pre-dates Christ, using these same basic principles was to hang clusters by their stems in a cave, where they would keep for several months. Some records suggest fruit could keep as long as six months this way.

Traits of Good Storers.

1. Berries are tight to the stems. Some grapes, particularly American *Lubrusca* types, often have a tendency to "shell" off the clusters, because of weak attachment between the stem and berry.
2. The berries don't crack readily. Varieties that crack easily during ripening usually spoil in storage. One variety known for this trait to crack is "Golden Muscat".
3. Firm, meaty types with fairly tough, cling skins generally keep better than soft, slipskin types. Varieties like: Himrod, Interlaken, and Lakemont are good varieties in increasing order. Seeded Canandaigua is also a good variety.

Guidelines for Good Storage.

1. When harvesting, clip the stems carefully and lay the clusters in a shallow box rather than piling them deep in a bucket. Piled too deep, the weight may crush or damage the fruit.
2. Before storing, remove any spoiled berries by clipping the stem off the cluster. Pulling off berries leaves a wet "brush" that becomes a site for infection.
3. Inspect regularly and remove anything showing signs of spoilage.

**Source:** *California Rare Fruit Growers*, July/August issue.

Offered by [Steve](#).



# Troubled Times



## Tannic Acid

---

In the latest issue of the *California Rare Fruit Growers* (May/June) I came across a short article on cranberry and blueberry health benefits.

Offered by [Steve](#).

### Benefits of Blueberries

I was happy to learn that blueberries and cranberries share a unique healthful property. I had always thought that cranberries owed their beneficial effect in the case of urinary tract infection (UTI) to all the (can't you taste it?) acid. However, *Modern Medicine* (66 #12:11, '98) reports bacteriologists at Weisman Institute in Isreal discovered a substance in cranberries that inhibit the stickiness of coliform bacteria (commonest causative agent of UTI). Apparently if they can't stick, they can't infect. Recently Rutgers researchers found the same **tannin substance** in blueberries. If you ever had to drink a glass of cranberry juice a day, this should be good news.



# Troubled Times



## Dried Fruits

---

Dried fruits are somewhat of a very big thing around the Near East, with the people around here eating them as part of the regular daily diet. Dried fruit can keep for a very long time in tightly closed metal or glass containers, often several years. Nuts, of course, which contain almost no water to start with, keep much longer than the juicier dried peaches and papaya. But heavily dried apples, bananas, and raisins can also keep in jars for over a year. In markets - the fruit is usually sold from burlap sacks, but those are not good for storing over a couple of months, depending on your climate (in a dry desert climate - raisins and pistachio nuts can keep a year in a regular burlap sack.) Usually humidity makes its way in to start a fungus mold. I've come across raisins packed in regular nylon store packages, that have been sitting around shelves for several years - and were still edible. Perhaps one needs vacuum packing for that, but I think that just manually processing the bag to get the air out is enough. Of course, those old raisins are pretty lame tasting, and are basically as hard as crackers. That's the whole point, there's no water left in them, so they keep longer... But the important thing is that the energy parts of it - the sugar and vitamins - stay in there after it's dried.

Having written all that - I did a search and just found a great link on the Internet which is an [Online Book](#) of fruit and vegetable processing! It has an absolutely incredible wealth of information. It's geared mostly for fruit producers who want to make money, but gives great pointers to everyone.

Offered by [Sol](#)



# Troubled Times



## Tips

From the FAO.org [Online Book](#)

### **Handling, sorting, packing and storage of dried and dehydrated fruit and vegetables**

It is not easy to assess when drying has been completed. In absence of instrumentation, the characteristics of the various products after drying / dehydration can only be assessed by experience. Although this cannot be conveyed adequately on paper, some general indications can be given. Fruit products. - When a handful of fruit is squeezed tightly together in the hand and then released, the individual pieces should drop apart readily and no moisture be left behind on the hand. It should not be possible to separate the skin by rubbing unpeeled fruit and the fruit center should no longer reveal any moist area. Banana should be leathery and not too tough to eat in their dry state. Vegetable products. - Onions should be dried until they are crisp, whereas tomatoes should be leathery. In general, the lower the moisture content, the better the keeping quality will be, but overtired products generally have an inferior quality. Also the loss in weight from excessive drying cannot be tolerated in a commercial operation designed to run profitably.

It is, however, essential to dry up to an optimum / safe moisture level, related to the type of the product and its designed shelf life, and to avoid running the risk of the products becoming spoiled due to excess water content. When drying is completed, the material should be sorted either on trays or on a table in order to remove pieces of poor quality and color and any foreign matter. After selection and grading, dried products should be packed immediately, preferably in polythene bags which must be folded and closed / tied tightly. However, plastic bags are easily damaged and therefore they must be packed into cartons or jute sacks before they are transported.

### **Deterioration of dried fruit during storage**

Dried fruit must be considered as a relatively perishable commodity in the same category as cereals, pulses and similar stored products. It is subject to deterioration resulting from mold growth, insect and mite infestation and physical and chemical changes.

### **Mold growth**

When the moisture content of dried fruit is allowed to exceed the maximum permissible level for safe storage then mold growth may occur. Table 8.4.1 indicates the moisture levels applicable to various types of fruit; and it can be seen that the safe moisture levels for dried fruit are much higher than those for other similar commodities. At the present time, suitable field moisture meters for use with dried fruit are not readily available, and moisture determinations can only be satisfactorily carried out where laboratory facilities are available. Various species of drought resisting fungi may develop on dried fruit when the moisture content is just above the safe level, and a number of osmophilic yeasts are quite commonly associated with spoilage in dried fruit. Many of the yeasts bring about fermentation with the production of lactic acid or alcohol, and yeasts are frequently present in wart-like crystalline growths which occur in fruit which has become "sugared". In very moist fruit mucoraceous fungi may predominate and are visible as white fluffy growths on and within the fruit.

### **Mite infestation**

Severe mite infestations are often associated with the growth of osmophilic yeasts in fermenting

dried fruit products. Many of these mites are unable to complete their development in the absence of yeast. They have been reported as occurring on dried fruit, and particularly figs and prunes in Mediterranean countries. Such infestations are difficult to eradicate.

### **Insect infestation**

Insect infestations may begin in the field before harvest, may continue during bulk storage after drying, and unless measures are taken to prevent it, may occur in the finished packaged product during storage prior to distribution and consumption. Regular treatments of the stack of dried fruit with a suitable insecticide will be necessary as a routine to combat light insect infestations. Pyrethrins synergised with piperonyl butoxide are commonly used as a surface spray or as an aerosol fog for this purpose. Heavy infestations will require that the fruit be fumigated.



# Troubled Times

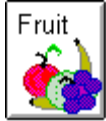

## Manual Juicers

---

Juicing without electrical power can be done with a heavy duty hand operated hydraulic floor or shop press. As an example, these are sold by [Harbor Freight Tools](#), (800) 423-2567. They range from 6, 12 and 20 ton sizes and prices from \$70, \$120 to \$230. They are floor mounted and weigh 62, 112 and 200 lbs respectively. There are often on sale in their stores for much less. One would need to build or purchase several stainless steel plates or small cooking pans (one to fit inside the other) to press the juice between. These two thin plates are used with a slightly smaller size but thicker steel backing plates. This is so the thin stainless doesn't bend. A drain in the lower stainless plate would allow the juice to run into a container as the two plates or pans are pressed together. The lower plate or pan needs to have some low sides to it to guide the liquid to one outlet. I plan to juice grass and weeds using this approach when electricity is not available. It is also, good for juicing herb plants (roots included) for medicinal purpose. I recommend going for the 20 ton one if you can afford it.

Offered by [Mike](#).

I began to think about the possibility of using an old hydraulic cylinder as the vessel. Clean it up take off the retainer at the piston end for easy placement of the food to be juiced into the cylinder, then use your operating press cylinder to squash the contents of the lower cylinder. Most of these cylinders are stainless inside and there is a hole at the lower end that would have been used to operate the cylinder in the opposite direction for draining out the liquid. if you didn't have an operating hydraulic cylinder you could simply set up a lever system to push in the piston, sort of like a giant garlic press.

Offered by [Michael](#).





# Troubled Times



## Fish Farms

An article called **Farmed Fish** on page 3 of the June '92 issue of *USA Today* magazine describes how farmed fish lack a fishy smell and taste. Excerpts of the article follow:

Aquaculture is the world's fastest-growing food-producing industry, according to the **Institute of Food Technologies**. Its defenders say that it is an economical way of making easily available a highly nutritious food, without incurring the great environmental and occupational hazards of commercial fishing. ... And, with the exception of a case of toxic algal bloom traced to farmed shellfish, health and environmental problems have as yet been few in the United States. ... Cooks say that penned fish are flaccid for lack of exercise, and often flavorless because they eat packaged feed. ... Most people, of course, *don't* like strong flavored fish, which accounts for the phenomenal popularity of some kinds of farmed fish - especially channel catfish, once a strong-flavored fish.

An article called **Urban Oasis** on page 74 of the January '95 issue of *Popular Science* magazine diagrams a technique for creating a synergy of plant and fish growth with sewage purification - all in an urban Tokyo setting! Excerpts of the article follow:

Four cylindrical tanks, lit by fluorescent lights and filled with water, contain spirulina algae. The algae absorb nutrients from human waste pumped into the tanks. They also take up carbon dioxide and release oxygen. As they multiply, the algae spill over into an aquarium holding tilapia fish. The fish eat the algae, and the fish-tank effluent is sprayed on the roots of a camphor tree dangling in the air above the fish tank.

An article called **Firewater Fish** on page 99 of the August '91 issue of *Scientific American* magazine describes the productivity and challenges of growing fish in indoor tanks. Excerpts of the article follow:

**Brown-Forman** corporation .. is taking a plunge into another market: fish farming. ... Brown-Forman has chosen the most technically difficult path to enter the business. Rather than raising fish in outdoor ponds, the facility in Louisville relies on indoor tanks in which water is recirculated as many as 30 times a day. ... The technical challenge is to remove fish waste from the series of narrow, five-foot-deep tanks, called raceways. A two-stage process uses filters lined with bacteria that first convert the ammonia secreted by fish through their gills into nitrates, which are flushed out. Another filtration system rids the tanks of solid wastes. ... The technology also allows for more intensive production: a million gallons of water can yield a million pounds of fish, an amount 200 times greater than that for fish raised in ponds.

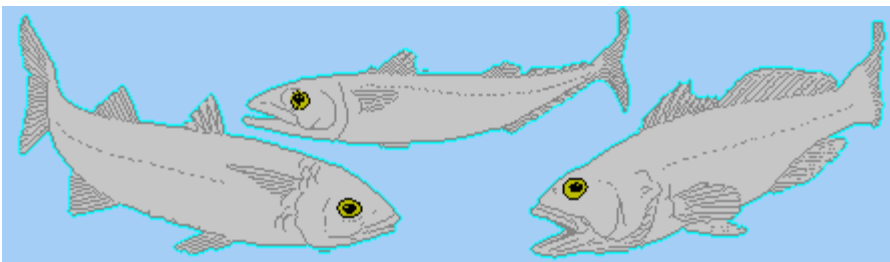

An article called **A feast of Gene-Splicing Down on the Fish Farm** on page 512 of the August 2, '91 issue of *Science* magazine describes how faster growing and more disease resistant farmed fish are developed via gene-splicing. Excerpts of the article follow:

Fish eggs ... are large and readily accessible - deposited by the thousands in open water. As a result, researchers are making rapid progress in tweaking the genes of salmon, trout, catfish, and other farm fish. ... [Researchers] hope to serve up "domesticated" fish that, thanks to genetic engineering, will reach market weight faster than natural strains and will also be hardier - more resistant to diseases and to freezing in winter. ... [Thomas Chen's group at the **University of Maryland's Center for Marine Biotechnology** in Baltimore] pioneered the technology in carp and rainbow trout. ... The transgenic fish and their offspring both grew from 20% to 46% faster than ordinary specimens.

Other researchers are taking a different tack for boosting aquaculture productivity: Genetically boosting survival rather than growth. John Spense, director of the **Canadian Aquaculture R&D Council of Vancouver**, points out that fish farms lose much of their potential revenue to diseases. .. [There] are no commercially available remedies or vaccines for fish viruses. So Chen and others are dreaming of ways to engineer immunity into their fish.



# Troubled Times



## Information

---

From the *Resource Guide to Aquaculture Information*

There are numerous international as well as North American electronic resources of value to the person interested in aquaculture or aquatic information. The listing here is not comprehensive but provides selected basic sources with a focus on the United States and Canada. The first section covers databases. These are usually bibliographic and are available online as well as by CD-ROM subscription. Many charge a fee to access directly or charge a subscription for the CD-ROM. Many libraries subscribe to these CD-ROMs and make them available to their patrons. Check your regional library for availability or contact the address provided in the description. The second section lists Bulletin Board Systems (BBS). These usually provide electronic messaging services (e'mail), archives of files, announcements, public and private conferencing sections, and any other services or activities of interest to the Bulletin Board System's operator. A BBS may be small and regional in scope, but an increasing number are currently operated by government, educational, and research institutions.

FTP/Gopher Sites and gopher servers can be reached via telnet address or gopher address and lead the user to a list of files/documents that can be obtained electronically and/or read online. Listservs are mailing list programs for electronic communication that allow users to exchange data and ideas through the Internet by subscribing. You must have an e'mail address to belong. Services listed below are sometimes a combination BBS/Database/Listserv, so their selection for a particular section has been made somewhat arbitrarily. The final section lists the various commercial and noncommercial vendors which provide communication access for your computer to some of the services in the preceding sections.

Acknowledgment is given to John Bostock at the University of Stirling in Stirling, Scotland, for information he provided on several of the following resources in this section. A comprehensive listing of international aquatic sources with a broader scope has been compiled by John Bostock and an electronic version of that list is available via anonymous FTP from [ftp.stir.ac.uk](ftp://ftp.stir.ac.uk) directory /aqua; file online.txt.



# Troubled Times



## CD-ROM

---

From the *Resource Guide to Aquaculture Information*

**Name:** AGRICOLA (AGRICultural OnLine Access)

**Host:** U.S. Department of Agriculture

**Address:** National Agricultural Library

10301 Baltimore Blvd.

Beltsville, MD 20705-2351

**Phone:** (301) 504-5479

**Access:** via DIALOG Information Services; also on CD-ROM

**Cost:** Yes

**Scope:** Comprehensive bibliographic database on the agricultural sciences including aquaculture. This is an index to the document collection at the National Agricultural Library as well as materials not in the library's collection.

**Name:** AGRIS (Agricultural Information System)

**Host:** FAO (Coordinating agency)

**Address:** Information Services Division

National Agricultural Library

10301 Baltimore Blvd.

Beltsville, MD 20705-2352 **Phone:** (301) 504-6813

**Access:** via CompuServe; via DIALOG Information Services; via DATA STAR  
(account required)

**Cost:** Yes

**Scope:** Bibliographic database of worldwide agricultural literature which includes aquaculture.

**Name:** Aquaculture II

**Host:** National Agricultural Library

Aquaculture Information Center

10301 Baltimore Blvd.

Beltsville, MD 20705-2351

**Phone:** (301) 504-5558

**FAX:** (301) 504-6409

**E'mail:** [aic@nalusda.gov](mailto:aic@nalusda.gov)

**Access:** CD-ROM

**Cost:** Free while supplies last

**Scope:** 154 aquaculture publications in full text with page images.

**Name:** AQUAREF

**Host:** Environment Canada

**Address:** Environment Canada

Ecosystem Sciences and Evaluation Directorate

WATDOC

Ottawa, ON Canada K1A 0H3

**Phone:** (613) 993-1210

**Cost:** Yes

**Access:** CAN/OLE also as CD-ROM: Citations and abstracts on Canadian water resources and environmental topics - retrospective only.

**Name:** **AQUIRE (Aquatic Toxicity Information Retrieval Database)**

**Host:** Scientific Outreach Program

**Address:** U.S. EPA

Environmental Research Laboratory-Duluth

6201 Congdon Blvd.

Duluth, MN 55804

**Phone:** (218) 720-5602

**FAX:** (218) 720-5539

**Access:** via Internet: telnet epavax.rtpnc.epa.gov or telnet 134.67.208.95 (request packet from above address prior to accessing database)

**Scope:** Contains records on data on acute, chronic, bioaccumulative and sublethal effects of approximately 5,100 chemical substances and on 2,400 freshwater and saltwater organisms.

**Name:** **ASFA (Aquatic Science and Fisheries Abstracts)**

**Host:** FAO (Coordinating agency)

**Address:** Cambridge Scientific Abstracts

7200 Wisconsin Ave.

Bethesda, MD 20814

**Phone:** (301) 961-6750

**Access:** via CompuServe; via DIALOG; also on CD-ROM

**Cost:** Yes

**Scope:** Bibliographic citations on biology of aquatic organisms, as well as aquatic issues in ecology, ecosystems, fisheries, policy, legislation, technology and engineering, commerce, and pollution.

**Name:** **BIOSIS PREVIEWS**

**Host:** BIOSIS, Philadelphia, PA

**Address:** BIOSIS

User Communications

2100 Arch St.

Philadelphia, PA 19103-1399

**Phone:** (800) 523-4806 or (215) 587-4847

**Access:** via CompuServe; via Dialog; also on CD-ROM

**Cost:** Yes

**Scope:** Citations and abstracts in the biological and biomedical sciences.

**Name:** **CAB Abstracts (formerly Commonwealth Agricultural Bureaux)**

**Host:** CAB International

**Address:** Farnham Royal

Slough, United Kingdom

**Access:** via CompuServe; via Dialog; via NISS gateway in United Kingdom; also on CD-ROM

**Cost:** Yes

**Scope:** Provides citations and abstracts in English to the worldwide literature of agriculture. Comprised of some 50 subfields including veterinary medicine/science.

**Name:** **CRIS (Current Research Information System)**

**Host:** U.S. Department of Agriculture

**Address:** CRIS/USDA

5th Floor

National Agricultural Library

Beltsville, MD 20705-2351

**Phone:** (301) 504-3816

**Access:** via Dialog; also on CD-ROM; also future searching via Internet

**Cost:** Yes

**Scope:** Contains project summaries of ongoing research conducted by USDA and State agricultural research entities.

**Name:** **FARAD (Food Animal Residue Avoidance Databank)**

**Host:** Food and Drug Administration

**Address:** [East Region]

FARAD

4700 Hillsborough St.

Raleigh, NC 27606

**Phone:** (919) 829-4431

**Access:** via Internet: farad@ncsu.edu

**Address:** [Central Region]

FARAD

Animal Poison Control Center

University of Illinois

College of Veterinary Medicine

Urbana, IL 61801

**Phone:** (217) 333-3611

**Address:** [West Region]

FARAD

Veterinary Medicine Extension

University of California

Davis, CA 95616

**Phone:** (916) 752-7507

**Access:** via Internet: farad@ucdavis.edu

**Cost:** Free

**Scope:** Cannot access database directly but must go through staff. Database lists approved trade names, generic drug, access by species, withdrawal times, and indications for use. Also contains specific generic drug data, levels in feeds, tolerances, USDA Residue Avoidance Program projects, and bibliographic files.

**Name:** **FISHLIT**

**Address:** FISHLIT Information Service

J.L.B. Smith Institute of Ichthyology

Private Bag 1015

Grahamstown 6140, South Africa

**Phone:** (0461) 27124

**Access:** Direct dial and future via Internet: ihmc@hippo.ru.ac.za

**Cost:** Yes

**Scope:** Includes literature on aquaculture particularly practical information, information on finfish and abalone, and South Africa aquaculture information as well as general fisheries information.

**Name:** **Fish and Fisheries Worldwide**

**Host:** National Information Services Corporation

**Address:** Ste. #6

Wyman Towers

3100 St. Paul St.

Baltimore, MD 21218

**Phone:** (410) 243-0797

**Access:** CD-ROM

**Cost:** Yes

**Scope:** Combines the databases from U.S. Fish and Wildlife Service's Fisheries Review, the FISHLIT database from J.L.B. Smith Institute of Ichthyology at Rhodes University in South Africa, the National Oceanic and Atmospheric Administration Aquaculture file, and Fish Health News abstracts.

**Name: FSTA (Food Science and Technology Abstracts)**

**Host:** International Food Information Service

**Address:** Herriotstrasse 5

D-60000 Frankfurt am Main 71

Federal Republic of Germany

**Phone:** 069/6687 281

**Access:** via CompuServe; via Dialog; also on CD-ROM

**Cost:** Yes

**Scope:** Research and new development literature in food science and technology.

**Name: National Water Quality Database**

**Host:** Purdue University

**Address:** Extension Specialist, Water Quality and Environment

Cooperative Extension Service

Purdue University

West Lafayette, IN 47907-1530

**Phone:** (317) 494-7924

**Access:** via Internet; telnet hermes.ecn.purdue.edu (login id: cerf; password: Purdue); gopher hermes.ecn.purdue.edu; select "The Purdue Cooperative Extension Gopher Information Server" select "Environment" then select "National Water Quality Database" (Write for guide).

**Cost:** Free

**Scope:** Lists current water quality publications, audiovisuals, bibliographic citations in the Water Quality Bibliography and more than 100 Extension documents.

**Name: NTIS (National Technical Information Service)**

**Host:** National Technical Information Service, U.S. Department of Commerce

**Address:** 5285 Port Royal Rd.

Springfield, VA 22161

**Phone:** (703) 487-4650

**Access:** via Dialog

**Cost:** Yes

**Scope:** U.S. government-sponsored research, development, and engineering plus analyses.

**Name: TOXLINE**

**Host:** National Library of Medicine

**Address:** MEDLARS Management Section

National Library of Medicine

8600 Rockville Pike

Bethesda, MD 20894

**Phone:** (800) 638-8480 or (301) 496-6193

**Access:** via CompuServe; via Dialog

**Cost:** Yes

**Scope:** Toxicological, pharmacological, biochemical and physiological effects of drugs and chemicals.

**Name: UIAIS (University of Idaho Aquaculture Information Service)**

**Host:** University of Idaho

**Address:** Librarian

Aquaculture Information Service

Aquaculture Research Institute

University of Idaho

Moscow, ID 83844-2260

**Access:** (208) 885-5992 for information

**Cost:** Direct dial costs

**Scope:** Information on references held in the Idaho Fish and Game Library, the Western Regional Aquaculture/Fisheries Distinguished Scientist Collection, the National Agricultural Library, the U.S. Fish and Wildlife Reference Service, the Southern Regional Aquaculture Center, the Montana Fish and Wildlife Parks Library, the U.S. Department of Interior Office of Water Research and Technology, among others.

**Name:** **Water Resources Abstracts**

**Host:** Cambridge Scientific Abstracts

**Address:** 7200 Wisconsin Avenue

Bethesda, MD 20814

**Phone:** (800) 843-7751

**Access:** CD-ROM and CSA's Internet Database Service, <http://www.csa.com>.

**Cost:** Yes

**Scope:** WRA contains comprehensive coverage of water planning ( including demand, economics, and cost allocations), the water cycle (including precipitation, snow, groundwater, lakes and erosion), and water quality (including pollution and wastewater treatment). Related legal and engineering issues are also examined.

**Name:** **WATERNET**

(American Water Works Association and  
AWWA Research Foundation bibliography)

**Host:** DIALOG

**Address:** Dialog Information Services Inc.

Marketing Department

3460 Hillview Ave.

Palo Alto, CA 94304

**Phone:** (800) 334-2564 or (415) 858-3785

**FAX:** (415) 858-7069

**Access:** via Dialog; via CompuServe

**Cost:** Yes

**Scope:** Index of publications related to water and waste water.





# Troubled Times



**BBS**

---

From the *Resource Guide to Aquaculture Information*

**Name: ALF (Agricultural Library Forum)**

**Host:** National Agricultural Library

**Address:** 10301 Baltimore Ave.

Beltsville, MD 20705-2351

**Access:** Direct Dial (301) 504-6510, or 504-5111, or 504-5496, or 504-5497; or via Internet through Fedworld; or telnet fedworld.gov

**Cost:** Direct dial costs if you do not have Internet access.

**Scope:** Agriculture- and aquaculture-related publications produced in the library in addition to some specialized conferences and mail messaging. For assistance call systems operator at (301) 504-5113.

**Name: AQUADATA**

**Host:** CompuServe

**Address:** 500 Arlington Centre Blvd.

P.O. Box 20212

Columbus, OH 43220

**Phone:** (614) 457-8600

**Access:** via CompuServe

**Cost:** Yes - per minute

**Scope:** Fish drugs, chemicals, aquatic publications, etc.

**Name: AQUAFORUM**

**Host:** CompuServe

**Address:** 500 Arlington Centre Blvd.

P.O. Box 20212

Columbus, OH 43220

**Phone:** (614) 457-8600

**Access:** via CompuServe

**Cost:** Yes - per minute

**Scope:** Bulletin board and files relating mostly to aquariums with small section for aquaculture.

**Name: Aquaria and Fish Forum**

**Host:** CompuServe

**Address:** 500 Arlington Centre Blvd.

P.O. Box 20212

Columbus, OH 43220

**Phone:** (614) 457-8600

**Cost:** Yes

**Access:** via CompuServe

**Scope:** Provides trade and hobby information on fish, aquaria and aquatic sciences with international coverage.

**Name: CIDS (Commercial Information Delivery Service)**

**Host:** U.S. Department of Agriculture

**Address:** Charles Hobbs

Office of Communications

U.S. Department of Agriculture

Commercial Information Delivery Service

Administration Building

14th and Independence Ave., S.W.

Washington, DC 20250

**Phone:** (202) 720-9045

**Access:** Direct dial or via telnet

**Cost:** Yes

**Scope:** Federal bulletin board network that provides access to time-sensitive U.S. Government information.

**Name:** FISHNET

**Host:** FISHNET

**Address:** 102 Haram St.

Sheffield, AL 35660

**Phone:** (205) 383-3009

**FAX:** (205) 386-7615

**Access:** via CompuServe

**Cost:** Yes

**Scope:** Includes fish farming and aquatic conservation as well as a number of files useful to aquarists on fish chemicals, drugs, and identification guides.



# Troubled Times

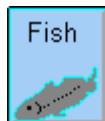

## ftp/Gopher

---

From the *Resource Guide to Aquaculture Information*

**Name: AquaNIC (Aquaculture Network Information Center)**

**Host:** Purdue University

**Address:** Cooperative Extension Service

Purdue University

West Lafayette, IN 47907-1530

**Phone:** (317) 494-6264

**Access:** via Internet gopher or via telnet at thorplus.lib.purdue.edu

(path=scholarly\_database/AquaNIC); or via direct dial (317) 494-1440; via ALMANAC at almanac@ecn.purdue.edu

**Cost:** Free-direct dial costs only

**Scope:** Provides a computer gateway to other aquaculture resources and provides educational products and scientific-based products electronically.

**Name: Biotechnology Information Center**

**Host:** University of Maryland

**Address:** Biotechnology Information Center

National Agricultural Library

10301 Baltimore Blvd.

Beltsville, MD 20705-2351

**Phone:** (301) 504-5340

**FAX:** (301) 504-7098

**Access:** via Internet: inform.umd.edu

Path=1/Ed.\_Res./Acad.\_Res.\_By\_Topic/Ag.\_and\_Env.\_Resources/

**Cost:** Free-direct dial costs only

**Scope:** Access to a variety of information services and publications on agricultural biotechnology.

Includes text files of some aquatic biotechnology bibliographies published through the Center at the National Agricultural Library.

**Name: CRIS (Current Research Information System)**

**Host:** nic.sura.net

**Access:** via Internet: Path=waissrc:/network.res/.linkdir/usdacris.src; or via Dialog or CD-ROM

**Cost:** Free and at cost depending on access

**Scope:** Limited search capability on USDA Current Research Information System database of currently funded research projects.

**Name: Economic Research Service (ERS) Reports**

**Host:** zeus.esusda.gov

**Access:** via Internet: Path= 1/feds/usda-info/ers

**Cost:** Free-direct dial costs only

**Scope:** Text of current U.S. Department of Agriculture (USDA) Situation and Outlook Reports including Aquaculture Situation and Outlook Report from the Economic Research Service of USDA.

**Name: Fishing for Information**

**Host:** University of Stirling

**Address:** John Bostock

Institute of Aquaculture

University of Stirling

Stirling, Scotland FK9 4LA

**Access:** Anonymous ftp to ftp.stir.ac.uk; directory /aqua; file online.txt

**Cost:** Free

**Scope:** Comprehensive international listing of network and online resources on aquaculture and aquatic science.



# Troubled Times



## List Serve

---

From the *Resource Guide to Aquaculture Information*

**Name:** AQUA-L

**Host:** University of Prince Edward Island

**Address:** Nigel Robbins

Canadian Aquaculture Institute

University of Prince Edward Island

**Internet:** NROBBINS@UPEI.CA

or

T. B. (Ted) White

NovaCulture Inc.

**Internet:** WHITE@MALA.BC.CA

**Access:** via Internet: send subscribe message to listproc@UPEI.CA

**Cost:** Free

**Scope:** Discussion covers issues on rearing aquatic larvae, diseases, parasites, pathology, water quality, recirculation technologies, systems design and operation, genetics, etc.

**Name:** BRINE-L

**Host:** Mercer University--Contact Lamar Jackson Jackson@uga.cc.uga.edu

**Access:** via Internet: send subscribe message to

LISTSERV@UGA.CC.UGA.EDU; Bitnet: LISTSERV@UGA.

**Cost:** Free

**Scope:** Brine shrimp (Artemia) electronic conference.

**Name:** CRUST-L

**Host:** Smithsonian Institution---contact Jan Clark hiv002@sivm.si.edu

**Access:** via Internet: send subscribe message to LISTSERV@sivm.si.edu

**Cost:** Free

**Scope:** Discussion of the systematics, distribution, and ecology of members of the arthropod Subphylum Crustacea.

**Name:** FISH-ECOLOGY

**Host:** Sunet (Swedish University Network)

**Access:** via Internet: subscribe to the listserv by sending message to  
LISTSERV@SEARN.SUNET.SE (Subscribe FISH-ECOLOGY)

**Cost:** Free

**Scope:** International computer conference for academic personnel and students involved in issues related to ecology of fish and fisheries, evolutionary aspects, population dynamics, modeling, management, conservation, and bioeconomics.

**Name:** FISH-JUNIOR

**Host:** Sunet (Swedish University Network)

**Address:** Aldo-Pier Solari

SOLARIS@SEARN.SUNET.SE

University of Umea (Umea})

S-901-87 Umea, Sweden

Phone: 090-16-50-00

**Access:** via Internet: send subscribe statement to

LISTSERV@SEARN.SUNET.SE (or LISTSERV@SEARN.BITNET)

**Cost:** Free

**Scope:** FISH-JUNIOR is a forum for knowledge transfer between marine scientists and children/high school students. The aim of this forum is to enable juniors of early age to interact with scientists and scientific issues mainly related to Fisheries ecology and related topics. The FISH-ECOLOGY management would like to encourage the participation of scientists, advisors, PhD students, and other research personnel who would like to be involved as teachers in FISH-JUNIOR.

**Name:** MAR-FACIL

**Host:** Dalhousie University

**Address:** Aquatron Laboratory

Halifax, Nova Scotia, Canada B3H 3J5

**Access:** via Internet: send subscribe statement to mailserv@ac.dal.ca

**Cost:** Free

**Scope:** MAR-FACIL is a mailing list for managers and technical staff at marine research facilities, aquaculture operations, public aquaria and other facilities supplying seawater for the support of marine life; intended as a forum for the discussion of technical and business topics.

**Name:** SHELLFISH

**Host:** Kenyon College

**Address:** Scott Siddall

Kenyon College

Department of Biology

Gambier, OH 43022

**Phone:** (614) 427-5696

**Access:** via Internet: send subscribe statement to shellfish-request@kenyon.edu

**Cost:** Free

**Scope:** Forum for the discussion of shellfish research, shellfish industry worldwide, funding opportunities, employment in shellfish research and industry, and meetings and conferences.



# Troubled Times



## Beginner

---

I have been contemplating a fish tank.

- How should it be mounted? Outdoors or indoors?
- If indoor mounting is preferable, what size area should be allocated for such a tank?
- What will it require of facilities like electricity, running water etc, or is it a self-sufficient system?

Offered by [Jan](#).

I do not have experience in this but do have experience in keeping tropical fish for years now in a large nearly 2 meter wide aquarium and I have read during and before these years a substantial amount of articles, books and magazines on the topic of keeping fish. I am absolutely *no* expert in this field of aquaculture.

There is no way to use the rainwater or water from rivers or pools in the aftertime, as it will be polluted and thus in the food chain (it might not kill the fish but it might kill you) will prove dangerous. So the aquaculture needs to be inside, away from the rain. And because this is for personal use only and not commercial, this will be feasible. I would think you must need a couple of tanks for the fish and the plants/filtration. Some space for the pumps and a means to provide electricity to the pumps. You need spare parts for everything that can break down in time. You need books on the subjects of fish-health and disease, fish farming etc. I can imagine this would take the space of a very large living room about the size of at least 8 x 8 meters.

You need the water to be pumped, and this takes electricity to drive the pump as the water needs to be flowing constantly in this system where a lot of fish are in a closed system of water. Next to the pumping the rest of the system can be made self-sufficient to the extent that the water flows from fishtank to plant-tank, gets filtered and the plants grow (you can mix this and grow your food plants in the fish water) and the water gets returned to the fish tank after a final filtration through another tank of sand and other filtration materials that can be cleaned now and then. You need to feed the fish, or the fish eat something else that comes from within the system.

Offered by [Michel](#).



# Troubled Times

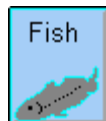

## Practical Advice

---

[The Krib](#) has a wealth of practical information about fish and how to maintain them, along with data on growing aquatic plants, retarding the growth of algae, plumbing, lights, and fish tanks. Has lots of data to a great depth from many contributors over the last 5 years.

Offered by [Mike](#).





# Troubled Times

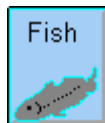

## Acquarium

---

Here is a lwebsite about keeping aquarium fish. It has excellent information on keeping fish, filters and how to make stuff for yourself for the aquarium. Naturally, a tank made of glass will not work! There are plastic tanks though and they can be found in many sizes. You should request information at your local aquarium specialist store if they can give you an address of companies who make these plastic/acrylic tanks (they can be big enough to carry 140 gallons of water easily).

Offered by [Michel](#).



# The Perch Puzzle

by Craig Bihrlé

North Dakota Outdoors Nov. 1995

Winter's Bite During North Dakota's open water season, walleye, a member of the perch family, attract more attention than any other fish. But by late November, waxworms replace fatheads as the bait of choice, and antsy ice anglers tentatively probe recently frozen water for secure support. It's perch-fishing time, and conventional wisdom says the earlier you get at them, the better.

"Perch is probably the number one winter fishery in the state," says Greg Power, central district fisheries supervisor for the Game and Fish Department.

Not many lakes offer the opportunity for truly large perch - those weighing three-quarters of a pound or more. But numbers seem more desirable than size. People like to catch lots of fish, and as long as those fish are big enough to keep, most anglers are happy. Perhaps that's why perch are so popular in winter. In the right lake they can dunk a bobber all day long and yield nice frying fillets as well.

## Wrong Lakes, Right Lakes

The popularity of perch as a winter fishery dictates that the Game and Fish Department try to manage certain lakes to sustain quality perch populations. Some lakes need little help. Others can benefit from a transplant of perch from other lakes, manipulating water levels, or introducing large predators (walleye or northern pike) to keep perch numbers from expanding too fast. And then there's lakes, perhaps a majority of those in North Dakota, that can't or won't support a quality long-term perch fishery no matter what people do.

Managing perch is a challenge. Meeting angler expectations of "A lot of big fish that are easy to catch," says eastern district fisheries supervisor Lynn Schlueter, must be balanced against what each lake can provide.

"It is important that fishery managers try to provide what the public wants," Schlueter added, "but sometimes what is wanted cannot be provided in that particular lake."

"Each lake has its own carrying capacity and its own capability of producing a certain type of fishery," Power said. "Some aren't geared toward perch....It all comes down to the food chain. Some lakes have it and some lakes don't." While perch will eat minnows and other fish smaller than themselves - young of-the-year gamefish, for instance - their primary diet is aquatic invertebrates. Gammarus, or freshwater shrimp, are a favorite. Part of the reason Devils Lake perch grow so large is because of abundant freshwater shrimp, but not all lakes can produce shrimp, and not all lakes with shrimp produce good perch fisheries.

Without an adequate food base, perch won't grow to a size - the breaking point seems to be around the 7-8-inch mark where they are desirable to anglers.

A good case in point is Fish Creek Dam, a small reservoir about 30 miles southwest of Mandan. When Fish Creek was chemically eradicated in 1992, it contained perhaps hundreds of thousands of yellow perch, most of which measured six inches or less. While an angler could catch perch all day long at Fish Creek, hardly anyone fished there for several years because the perch were too small.

It was a classic example of a stunted population (when they're bad they're horrid) - the fish found enough

food so they could live and reproduce, but there were so many perch there wasn't enough food for any of them to reach a quality size.

Fish Creek had been eradicated previously because of a stunted perch population. Game and Fish then stocked other species to create a new fishery, but someone illegally introduced perch back into the lake. Once that happens - and it has happened at other lakes around the state perch will likely reproduce, Power said. That first year class may do well. But once the population multiplies, the cycle starts again and within just a couple of years small perch dominate the lake. They don't grow large enough for angler harvest, and they limit the potential for other fish populations.

Other lakes in which stunted perch populations have been eradicated recently include Hooker Lake in the Turtle Mountains (1992) and Velva Sportsmen's Pond in Ward County (September 1995). Perch were illegally introduced into those lakes as well.



(Photo by Harold Umber)

On the positive side is Devils Lake, which from the late 1970s to around 1990 was a perch angler's dream. The lake harbored lots of perch, and they were big. In fact, so many perch weighing more than a pound-and-a-half (perch qualifying weight for the Whopper Club) came out of Devils Lake that the Game and Fish Department increased the minimum Whopper Club weight for Devils Lake perch to 1.75 pounds in 1980 and two pounds in 1982.

Ice fishermen came from throughout the Midwest to catch buckets of big perch. In the early 1990s, due primarily to poor reproduction caused by the drought and low water levels, perch numbers in Devils Lake dropped off, but it still attracts considerable perch fishing effort.

## Basic Biology

Yellow perch are members of the perch family, which also includes walleye and sauger.

Unlike walleye and sauger, which spawn over gravel or rubble bottom structure, perch prefer to spawn on or near underwater weeds. Lakes without submerged vegetation are unlikely to support perch reproduction. Weeds also provide escape cover for young perch, and they are food for the aquatic bugs perch eat.

But lakes with too much vegetation can overpopulate with perch, as excess weeds may provide too much protection from predators. Perch are not a fast growing fish. Under normal conditions it takes about three years for them to reach 7-8 inches long and attract significant interest from anglers. In four years they may grow to 9-11 inches, and perhaps beyond a foot in six or seven years. Age seven is about as old as perch get in North Dakota.

In lakes where perch are stunted, they may live a half dozen years and not even reach six inches in length.

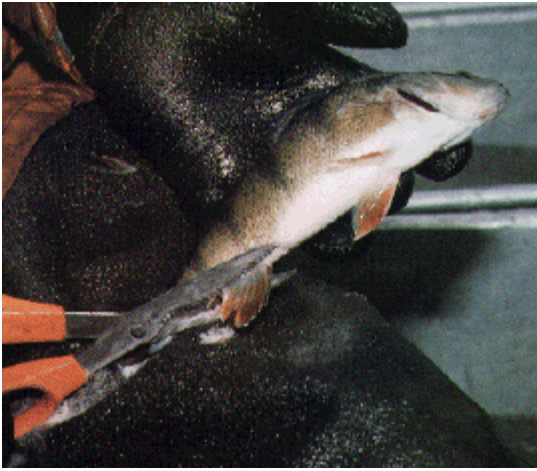

(Photo by Craig Bihrlle)

## Booms and Busts

Like many other fish species, perch populations rise and fall in cycles driven by water levels. When water from spring runoff floods vegetation, good perch spawning habitat is created. Stable water in lakes with residual cattails or bulrushes also aids perch spawning and recruitment of small fish.

But when lake water levels decline, leaving vegetation high and dry, perch spawning is curtailed. Without a spawn, there is no new year-class of fish to replace those caught by anglers or dying of old age. Two or three consecutive reproduction busts can greatly reduce an otherwise strong perch fishery. This situation leads to increased angling pressure on just one or two older year classes, which can be quickly fished down.

Such was the case with many North Dakota lakes, including Devils Lake, during the drought.

Now, the water cycle has switched to the plus side. Perch are finding flooded weeds in which to spawn. Formerly good lakes won't come back overnight, but the outlook is promising. "I think in the next few years we're going to see an explosion of interest and effort in perch fishing," Greg Power said.

## Managing the Interim

Even during the drought years, North Dakota had lakes with lots of perch. While some of these lakes had stunted populations, they served an important purpose: providing fish for transplant to other lakes. Over the years, Department biologists have learned that stunted perch can grow rapidly when moved to another body of water that contains the right requirements. "It is not unusual," says fisheries biologist Gene Van Eeckhout, Jamestown, "to hear reports of 3/4 to 1 1/4 pound perch coming out of renovated (eradicated) lakes a year or two after fingerlings and/or subadults were stocked."

For many years, Blacktail Dam provided perch for stocking in numerous lakes throughout North Dakota. In recent years, Brush and Strawberry lakes in McLean County have provided perch for this purpose. They've been put in lakes to supplement a lack of natural reproduction, and they've been used to start perch populations in lakes that had winterkilled or were chemically eradicated.

It is unfortunate, however, that Brush and Strawberry have perch at all. At one time, these McLean County lakes were two of the top bluegill lakes in North Dakota. They grew big bluegills, and lots of them. But they don't grow big perch. Sometime in the mid-1980s perch were illegally introduced into both lakes. They reproduced successfully. The population exploded. Now both lakes have hundreds of thousands of stunted

perch, and the quality bluegill fisheries are a thing of the past.

Few perch in Brush Lake grow beyond six inches, and most are smaller. Scale samples indicate five-inch fish from Brush could be two years old or five years old. Though great numbers of these fish have been moved elsewhere, the perch populations in these two lakes have changed little.

While transplanting perch to other lakes often helps the receiving lakes, removing perch has not generally proven effective in turning around lakes with stunted populations.

To give Mother Nature a little help at Devils Lake, in the early 1990s Game and Fish for the first time actually took eggs from perch and incubated them at Valley City National Fish Hatchery. When the eggs hatched, the fry were released in Devils Lake. Supplemental stocking couldn't replace natural reproduction, but it helped. For the last couple of years, hatchery-produced perch fry and fingerlings have been stocked in a number of state lakes.

## **Game Fish or Prey?**

Depending on the lake in which they are stocked, perch may have a dual purpose. Not only are they a popular fish with anglers they are also a food source for larger game fish such as northern pike and walleye.

Many North Dakota lakes are managed as pike/perch fisheries. In some lakes, perch are stocked primarily as food source, but if the right conditions exist, some will grow large enough to attract angler interest as well.

If predators can't keep perch in check when they're small, the perch can get out of hand. In turn, they may become a predator on stocked or naturally-reproduced game fish. Too many large predators, on the other hand, can limit a perch population's potential to provide opportunity to anglers. "Balance" is what fisheries managers strive to accomplish, Schlueter says, but weather, angling pressure and illegal introductions are all factors that can disrupt that balance.

## **The Long Run**

Managing perch is a complex business. They can be a dream come true, or a nightmare.

Fisheries biologists are still learning what it takes to nurture a healthy perch population.

For instance, the size of a lake may be an important factor in determining whether it can sustain a quality perch fishery. Biologists feel that small lakes those less than 50 acres - are not well suited to perch. Efforts to manage those lakes will more often concentrate on other fish.

Trying to manage small lakes for more than one panfish species, i.e. bluegill, crappie and perch, is often detrimental to a lake. "In situations where I have some control, such as winterkill or lake renovation," says Van Eeckhout, "I'm going with one panfish species to try to avoid some of the problems that occurred in the past. This is frequently unpopular with the angling public because they want bluegill, crappie and perch, as well as northern and walleye, etc., etc. But it just isn't working when we stock all these species in every lake."

Not every lake can grow lots of big perch. Says Greg Power: "We're still learning. We're developing that lake-specific information, and in time we hope to understand why some lakes produce perch better than others, and what we can do...to better manage those lakes over the long haul.

"Each lake is different, and how you manage them has to be different."

CRAIG BIHRLE is associate editor of North Dakota OUTDOORS. [Return to ND OutDoors](#)

All Rights Reserved  
[Terms and Conditions](#)

Last modified Feb. 7, 1996

# Troubled Times

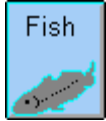

## Catfish

---

I've seen huge catfish farms in Mississippi. The primary expense, besides food, is keeping the water oxygen level up. It seems to me that with almost continuous rain falling into shallow fish ponds that the rain water would keep the oxygen level high. So now, we've got to find the optimum way of raising earth worms in great quantities as catfish *love* earth worms.

Offered by [Ron](#).



# Troubled Times

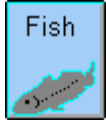

## Carp

---

Have you ever eaten carp? They certainly don't taste as good (to me) as catfish or even bass! Sure they are easy to grow, but why do you suppose they are called trash fish?

Offered by [Roger](#).

I've eaten carp, and I agree that they aren't one of the best tasting fish, not to mention the extreme number of small bones. I think they are grown because they eat vegetation. They are usually cooked (steamed) with a very strong tasting sauce, like fermented black beans. I certainly wouldn't waste my time with bass, as in a pond they are most likely to eat every small fish that is hatched/born. Post pole shift, I don't expect carp would work out, as all the fresh water plants I'm familiar with need lots of light, so they really wouldn't have anything to eat. Carp will eat most anything, but I don't think they will eat rotting vegetation. I've caught them, as you say, with bread and also cheese; but they can't resist worms or a piece of red meat. I think they are able to locate it more easily from it's smell.

Offered by [Ron](#).

Carp is an excellent food fish if you choose the correct species and is farmed all over the world for that purpose, cooked with herbs and spices, stuffed with rice etc., it can be a very acceptable meal to even the most discerning palate, and any bony fish is easily filleted for a meal and the bones, head, etc. used for soup.

Offered by [Jan](#).

Carp are a very hardy fish that can be pond-farmed without the need for aeration (which in turn would require electricity). In lesser developed countries including Central Europe and Asia, Carp are in fact the most popular fish produced through aquaculture methods. However, they are a lot less popular in places like America due to being somewhat oily and having lots of bones. I believe they should be considered a primary source of backup food supply in the event of a widescale catastrophe as they are highly efficient protein producers. Below is one article I found on preparing them. The great thing as well is that it would be difficult for a roving gang to see/take all of your pond fish, and thus pond fish are highly recoverable from attack esp given that fish eggs would spawn.

From the [Pole Shift ning](#).

From Mother Earth News, Issue No. 33 - May/June 1975:

*A two-foot piece of board ten inches wide, with a large nail driven through one end, is a great help in the skinning process . . . and you'll need a rough wooden table-far from the house but near a convenient supply of running water-to carry out the messy job of filleting. Other necessities include a long, thin, sharp knife, a pair of pliers or vice grips, a pan of salted water (half a pound of salt per gallon) for the fillets, and a bucket for the non-edible parts.*

*First, the skinning. Hose the slime off the carp and impale it near the tail on the spike that sticks up through the board. With the point of the knife, pry off a row of scales far back on the carcass and cut the tough skin underneath. Next use the backbone of the fish to pry against as you slit the skin along the spine from the tail to the bony skull. Then open the belly from end to end, being careful not to spill the guts. Catch hold of the flap of skin at the tail end with the pliers or vice grips and pull slowly toward the head, taking care to clean the meat off the skin with the knife if any starts to pull loose from the carcass (see*



*Fig.. 1). An extra pair of hands is really helpful at this point: one person tugging the skin with the pliers while the other holds the carp in place and frees the clinging flesh. Cut the meat along the spine and belly and across the skull end of the fillet, and begin to pull the flesh toward the tail, slicing it off the bony ribs as you go (see Fig. 2). Once the piece of meat is free, wash it off and put it into the pan of salted water. Then turn the carp over and repeat the process on the other side.*

*About the leftovers: Richard Reed uses the huge volume of eggs in the female carp as food for his flock of mallards, and we find that our chickens like the roe mixed with their mash. The rest of the carcass makes a high-quality fertilizer. We grind the leavings in our shredder-grinder, for easier spreading and less worry about turning up sharp bones in the garden next spring. Bury the fish-wastes deep, so the dogs and cats won't dig up the patch to get at them, and stand back ... because those plants will begin to grow and produce like nothing you've ever seen before,*

*Meanwhile, though, you've just cut up your first carp and will probably want to have a fresh fish fry right away. Soak the meat for ten minutes in the salted water, pat it dry, and cut it crosswise into slices the size of fish sticks. Beat one egg in a bowl with a little milk, dip the fillet strips into this mixture, and roll them in whole wheat flour or cornmeal seasoned with salt, parsley, and sage. Then get the frying pan hot and add vegetable oil or shortening. Brown the coated fish on all sides. (We mix the leftover egg and milk with the seasoned flour and add a dash of baking powder to make a dinner pancake. You'll find your carp feast worthy of all that labor. Carp has both. light and dark meat and is fattier than most fish, with a texture that reminds us of tender pork. The meat also has numerous sharp bones when cooked fresh and will have to be carefully picked over bit by bit before being served to young children. (Well, you knew there had to be some disadvantages!)*

*Much as we enjoy fresh fried carp, we prefer to can this meat because it makes the bones soft and digestible (a wholesome calcium bonus). Just cut the fresh or smoked fillets into strips and pack them tightly to within an inch of the top of pint canning jars. Add half a teaspoon of salt and two or three tablespoons of hot salad oil if desired. Put the cap on each jar and screw the band down firmly. Process the fish in a pressure cooker at 10 pounds for 100 minutes or at 15 pounds for 80 minutes. The finished product can be used in any recipe that calls for tuna.*



# Troubled Times

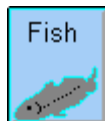

## Tilapia

---

### Tilapia - An Old Fish Tale with a New Twist

*Tilapia is a fish that has been raised for centuries with little fanfare. In recent years with the worldwide emergence of aquaculture, increased attention is being focused on tilapia because of its superior culture possibilities. Reportedly more than one billion pounds of Tilapia were raised last year. These fish are ideally suited for aquaculture because they are disease-resistant, reproduce easily, feed efficiently, and can tolerate poor water conditions.*

*Tilapia can be successfully grown in brackish water and some species can adapt to full strength sea water. Tilapia are members of the Cichlid family and are native to Africa. In many developing countries, tilapia are raised in ponds, cages and rice fields. Tilapia can also be grown in intensive culture systems, with corresponding greater investment cost. Tilapia produce mild, soft, white fish fillets, with a slightly sweet taste. These superior qualities make Tilapia a culinary delight, whether served in an expensive restaurant or prepared simply for home consumption.*

I'll second the praises of Tilapia!! Their only draw back that is they require temps in the 70's to thrive and spawn. The **AquaStore** looks like the best place to get Tilapia that I have found. They offer a breeding colony of 5 fish ( 4 female and 1 male). Personally I would like to have more males. Another disadvantage is that the females will throw off all male progeny. At some point you will need another source of females. I will contact them to see if they can offer a female that has mixedsex progeny.

Offered by [Stan](#).



# Troubled Times



## Crayfish

---

Have you considered fresh water crayfish as a source of food post pole shift? In Australia we have Yabbies and Marron, they are scavengers and mud dwellers and the hardest part in raising them is keeping them from migrating to other dams. They can be raised in indoor tanks for long periods of time on minced meat and fish food (brine shrimp etc.). When we finally re-locate to our safe place we intend to have both crustaceans and fish with a system for protecting a small amount of breeders to begin farming again post pole shift.

Offered by [Jan](#).

I have raised blue australian yabbies in my aquarium some years ago. They grow really fast, but when growing they tend to eat each other when smaller yabbies come into contact with stronger bigger yabbies (sort of fresh water crayfish). They practically ate everything I gave them, dinner leftovers, meat etc.

Offered by [Michel](#).

If I remember my biology, crayfish lay eggs which they keep beneath their tails until hatched and big enough to avoid being eaten. Ever caught a mother crayfish with babies clutching the underside of her tail?

Offered by [Roger](#).



# Troubled Times



## Methods

---

Summary of **Hydro/Aquatic Technologies** methods  
(011) 410-957-2859  
PO Box 777  
Princess Anne, MD 21853-0777

In an aquaculture system, *you* are controlling the feeding, stocking, and life support for your fish.

### Ponds

A pond is one of the cheapest ways to raise fish, but it does pose a few problems, like low densities of fish.

### Net Pen

A net pen is a very cheap to raise the fish, because it still doesn't take much equipment to run them up to harvest, though if all of your fish are living tightly confined in a net, they rely on *you* for their food and aeration for most of their requirements.

### Raceway

You could put your fish in long troughs or raceways, and feed freshwater into one end and let the dirty water and fish wastes flow out the other. This works great for trout if you have a good fast flowing *reliable* stream or spring.

### Recirculating

A recirculating aquaculture system recirculates the water around and around, cleaning the fishwastes and uneaten food from the water, and bringing the oxygenation up to desirable levels. It allows you to get maximum production in the smallest area. A recirculating system is easy to set up, and can pay for itself in less than two years.



# Troubled Times

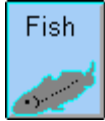

## Symbiosis

---

Summary of **Hydro/Aquatic Technologies** plant/fish symbiosis

(011) 410-957-2859

PO Box 777

Princess Anne, MD 21853-0777

Aquaponics is a combination of aquaculture, which is raising fish in a controlled environment, and hydroponics, which is growing plants without soil, providing the nutrients to the plants mixed into the water fed to the plants.

In an aquaponic system, you feed the fish, the fish wastes feed bacteria, the bacteria wastes feed the plants, and the plants clean the water for the fish. Fish waste is mainly ammonia nitrogen, that evil smelling stuff you clean windows with. If you feed the fish too much, and their ammonia laden wastes build up, the fish die. Even if they don't eat the food that you toss in the tank, the natural breakdown of the food will kick up the ammonia level. Certain bacteria eat ammonia, they thrive on it, can't live without it. The most voracious ammonia eating bacteria are called Nitrosomonas bacteria. and give off wastes full of nitrite nitrogen. Another bacteria, Nitrobacter, feeds on nitrites, and excrete nitrates. Nitrates are 10-100 times less dangerous to the fish. Still, if the levels of nitrates ever manages to get too high, it can still kill the fish.

Nitrates are the form of nitrogen that plants utilize. From the lowest form of blue/green algae to the tallest Redwood tree, they all use nitrates as their nitrogen source. When the plant dies, other forms of bacteria (along with bugs, fish, animals, and humans) feast on the plant. Their wastes start the cycle all over again. An *aquaponic* system contains all three of the necessary parts of the ammonia/nitrate cycle. They are: fish to produce the ammonia, bacteria to break the ammonia down to nitrates, and plants to feed on the nitrates to create fishfood to start the cycle all over again.

In the simplest aquaponic system, the fish live in a standard fish tank. A pump that sits in the tank with the fish pumps the water and fish wastes up to a series of troughs at the top of the tank. As the water sprays out of the pipes leading from the pump, it picks up oxygen, and flows down the troughs. The troughs contain blocks of rockwool, a sterile growing media similar in appearance to fiberglass. The water and dissolved fish wastes feeds up into the rockwool by capillary action, where bacteria are cultivated. The bacteria do their thing on the ammonia, and feed plants that are also growing on the rockwool cube. The cleansed water then flows down the trough, and pours into the fish area in the tank, completing the cycle. Aquaponics can be integrated into an indoor pond system to create a beautifully landscaped show system.



# Troubled Times



## Equipment

---

Summary of **Hydro/Aquatic Technologies** equipment needed

(011) 410-957-2859

PO Box 777

Princess Anne, MD 21853-0777

- adequate light to grow the plants.
- fishfeed
- seeds
- bacteria
- test kit for ammonia, nitrite, pH
- pH adjusting chemicals
- fishnet
- submersible thermometer
- airpump
- heater



# Troubled Times

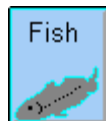

## Hydroponics

---

The Freshwater Institute is part of the Conservation Fund and is experimenting with a closed loop fish farming(aquaculture) and hydroponic system designed to feed off one another. I was told by a couple of people that this was very difficult because fish waste wasn't necessarily the correct NPK for plants and plant waste wasn't necessarily fish food. In any event, these guys are making the attempt.

### **Freshwater Institute**

PO Box 1746

Sheperdstown, WV 25443

Offered by [John](#).



# Troubled Times

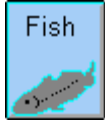

## Issues

---

In references to aquaponics there are contradictions. On one hand, it seems as though aquaponics is already a proven factor, and could be a viable solution. You feed the fish, the fish wastes feed bacteria, the bacteria feed the plants, and the plants clean the water for the fish. Wonderful! Except that aquaponics is proving difficult to put into practice, since fish waste is not necessarily the correct NPK for plants, and plant waste is not necessarily fish food. Does anyone know how far aquaponics has developed, and if it really is, as yet, a good solution?

Offered by [Helena](#).

I know there are a number of commercial operations that combine aquaculture and hydroponics, that produce lots of fish and bushels of veggies. Is it self-sustaining, probably not. I'm sure that some outside nutrients have to be added on occasion. I'm sure that fish poop does supply a lot of the Nitrogen (N) Phosphorus (P) and Potassium (K), that plants need, but maybe not all that's needed. This probably has more to do with growing the right number of fish in conjunction with right number of veggies. Certainly micronutrients such as iron, calcium, magnesium, etc might need to be added, in addition to NPK. The bottom line is you have to feed the fish and feed the plants, if you can feed the fish and at least partially feed the plants, then its worth it. Coming up with an outside source of nutrients is then the problem. Some fish will eat algae as a food source (Tilapia), and algae can be used to treat sewage. I know its not a appetizing solution but I think its the best one. After I get my hydro/aquaponics going I will look at ways of growing algae on some type of waste source.

Offered by [Stan](#).







[Home](#) ▶ [Technology](#) ▶ [Aquaponics](#)

**Main Menu**

- [Home](#)
- [About F.A.S.T.](#)
- [News](#)
- [Technology](#)
- [Links](#)
- [Search](#)
- [Travis' Travel Blogs](#)
- [Contact Us](#)
- [Photo Gallery](#)



**Aquaponics**



Aquaponics is the integration of aquaculture (fishkeeping) and hydroponic (soilless) plant growth techniques. It requires no soil and no chemicals to produce a vast and large amount of fish, fruits and vegetables in a very small space. Fish produce ammonia as waste. Bacteria convert that waste to nitrates used by the plants as the nutrient source. The water is recirculated to the fish clean and aerated. Water consumption is lower and plant density is usually at least twice that of soil based methods. No pesticides can be used as they would kill bacteria and fish in the system. Food produced is thereby pesticide free. Travis Hughey is the inventor of the Barrel-Ponics method of aquaponics and the author of ***The Barrel-Ponics® Manual*** which is available as a free download from this website.

Filter    Order    Title asc                          Display #    50

<b>Item Title</b>	<b>Hits</b>
<a href="#">The IBC of Aquaponics</a>	1859
<a href="#">Aquaponics and Food Safety</a>	6717
<a href="#">General Aquaponic Information</a>	11043
<a href="#">Aquaponics In Developing Countries</a>	4707
<a href="#">The Barrel-Ponics® Manual</a>	56751

<< Start < Prev 1 Next > End >>

Results 1 - 5 of 5

[\[ Back \]](#)

[Forgot Password?](#)  
[Register](#)



Enter Amount:

\$                          One Time

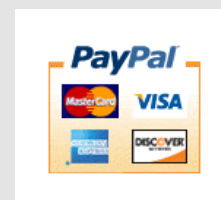

If you wish to make a donation by check, please send to:

F.A.S.T.  
229 Parker Rd.  
Andrews, SC 29510

Thank You!!

# Troubled Times



## Temperature

---

When building fish ponds, remember that unless you live in an environment where the temperature is the same year around you may have to change fish for different temperatures. For example:

Rainbow Trout	50-70 F	92 F is lethal
Sacramento Blackfish	65-70 F	
Fathead Minnow	60-85 F	95 F is lethal



# Troubled Times



## Winter Over

---

There are marshes and ponds east of where I live that I have fished and hunted all my life. These ponds are full of Catfish and Carp. I've never eaten the Carp, but there are three varieties of catfish - Blue Gill, Channel Cats, and what we call Yellow Bellies. There are several ponds in this area, the deepest is about 10 feet, with the average depth of the others at 4 to 5 feet. The pond bottoms are dark mud, and a 160 lb. man will sink into it about a foot. Every winter, these shallower ponds freeze up solid. The winter temperature in these marshes varies from 5 F above zero, to 10 below zero with a variable wind chill of 5 to 30 mph on the average. And every spring, the Catfish and Carp return. According to my dad and the other old timers, the fish survive the winter by burrowing into the mud. So, If someone were attempting to raise Catfish for a food source I would say, be sure the bottom of your manmade pond was not hardpan, or of sandy soil. Let those fish burrow in the mud!

Offered by [Brent](#).

Catfish will also burrow into the mud when a pond dries up, only to return again when there is water.

Offered by [Ron](#).



# Troubled Times

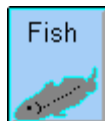

## Paddle Wheel

---

Years ago it used to get really cold here in Kansas and paddle wheels were used to churn small stock ponds so the cattle could get water. When used in this manner, the paddle would be completely submerged and there might be a thin layer of ice on the pond, but the cattle could easily break this themselves. Most of these paddles were powered by electric motors, but in windy conditions, a windmill would work. If the paddle were positioned so that it broke the surface of the water, it would aerate the pond. Of course this might not be necessary as catfish live well in small ponds here in Kansas without any aeration. There are algae that fix oxygen into the water naturally and as you said, after the pole shift the rainfall will take care of oxygenation.

Offered by [Roger](#).



# Troubled Times

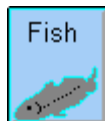

## Pools

---

I was thinking if you plan on all this gardening be it hydroponic or ground based. and especially if you plan on raising fish your going to need a ton of water. Where's that going to come from? Fish farming alone will need 1000-2000 gallons alone and that's for something very small. Also I saw at K-Mart or Target they have those metal sided with liner pools for less then \$200 which would work good for a start up pond.

Offered by [Yahbo](#).

I have seen trout being raised in the same pools with the pool liners.

Offered by [Stephen](#).



# Troubled Times



## Yield

---

How large would a fish tank for a group of 10 or 30 have to be?

Offered by [Jan](#).

If you have fish that are able to multiply every month with success, and you are with 30 people and each eats two - three fish a week then you will consume in total between 60 - 90 fish a week. That is a lot of fish. One fish a week per person would come down to a total of 30 fish per week and 120 every month. If the fish is about the size of a general human foot and about a general hand thick then that would do fine. So the type of fish you should be keeping must be:

1. freshwater
2. fast breeding
3. fast growing
4. not picky with food (a lot of fish types are)
5. insensitive to fluctuations in temperature
6. not needy of a lot of space
7. not too small (about 20 cm and up)
8. resistant to many diseases, has to be a strong type
9. insensitive to fluctuations in water pH and dH. (acidity and hardness)

The above are important factors for providing a consistency in the supply and quality of this food resource. Best thing to do is to look at the type of fish that fish farms breed where freshwater fish is concerned:

1. Salmon
2. Trout
3. Tilapia (subtropical)

then there are other types of animals that can be grown and bred in captivity as a food source:

1. fresh water prawns
2. fresh water crabs (they do tend to eat each other though but need but small space each)
3. crawfish (type of lobster from fresh water), like the Australian yappie (again, might eat each other sometimes. Solution to that problem is having them in several different tanks or one tank divided in smaller sections).

I do not know how large the fish tanks should minimally be, it is very important that you know the right amount of fish per tank, as crowding will stop the fish from breeding and the water quality will deteriorate rapidly. Water needs to be oxygenated. You can do this by aeration, meaning you have an apparatus that blows bubbles from the bottom of the tank. For this you need an air pump. You can also get the same effect of oxygenating the water without the bubbles, but then you need to have the surface of the water in constant motion. A water pump is needed here where the water is pumped into the tank from above, breaking the surface of the water. The water needs to be in constant motion and needs to be filtered. Filtration can be done mechanically via a water pump pumping the water through a filtration tank, or biologically by letting the water flow from the fish tank into a tank with plants where the organic substances in the water are used by the plants to grow (so you need light here too).

Offered by [Michel](#).



# Troubled Times

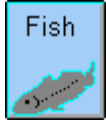

## Food Chain

---

On average, only 1% of the Sun's energy falling on vegetation results in vegetables: 1,000 kilocalories of light energy can produce 10 kilo calories of vegetables. On average, fish can obtain only 10% of the energy utilized by plants. Thus energy eaten by humans is on average only 1% of the total. This tells us that we would get the most food energy from a pond area eating the algae rather than growing fish. The first step in the food chain is to eat an edible species of algae such as *Chlorella* sp. The next step would be to raise plant eating fish. The last step would be to eat carnivorous fish, which are most fish species. Typically the amount of energy from eating a carnivorous fish like the catfish is only 670 calories from an original outlay of 2,700 calories, only 25% of the calories. Thus, by eating carnivorous fish there is yet another loss in energy.

For an algae/fish pond, the food cycle is as follows. Raw sewage is added to the algae pond. It has a surface area of 225 square feet, 15 feet by 15 feet, figuring solar input at 90,000 kilocalories per day, with a photosynthetic conversion rate of 3% yielding 2,700 kilocalories or about 5000 grams of algae. This is then fed into the Zoo Plankton pond which also has a 15 by 15 foot surface. The biological conversion here is 25%, a yield of about 670 kilocalories a day in Zoo Plankton or about 135 grams of protein, down to a quarter of a pound. This is then fed to the catfish pond. The pond volume here is 300 cubic feet. Since the biological conversion in this last step is 10% you only get about 14 grams of catfish per day.

Realistically, you're not going to live on a fish culture unless you are talking about really big ponds and lots of sunlight. You can increase this with intensive aqua culture, but even so you are looking at a maximum of 25 pounds of fish per year with the above setup.





# Troubled Times



## Shock

---

One problem I see is how to make sure any fish we would hope to farm will survive the pole shift. Tanks are so fragile. The more I thought about this, the more difficult it seemed. How could a tank be devised that would survive the earthquakes we could expect. Wouldn't it just be better to stock a pond (if available at our sites) with the fish we want to farm in the Aftertime? My guess is that a pond would be more natural for the fish, thus they would survive and could be reintroduced to our fish tank systems (which would probably have to be constructed after the earthquakes, etc.). There is a book I am sending for called *Earth Ponds - The country pond makers guide* which might have information about creating or revitalizing a pond.

Offered by [Craig](#).

The fish will jump out if possible when they feel quakes and tremors, as fish are very sensitive due to that special sensory organ on the sides of the body. Furthermore fish die easily due to shock, they get scared or there is a quick movement or a loud noise and bang! They are literally scared into their own death. I've been trying to imagine the quakes and the fish tanks together, there may be a means after all to minimize any loss of your precious fish-stock. Imagine the following construct:

1. tank made of waterproof sail/canvas
2. tank hangs in stable, well balanced steel structure
3. tank is filled with a minimum of water
4. fish are put in the water
5. the sail hangs in the structure but not by it's ends
6. remaining sail is taken and tight together by it's ends into a tip by means of a thick rope that goes through holes with strong rings
7. tip is kept up high above the rest of the tank by tying the rope to a ring in the ceiling (must be reinforced structure) to prevent any sloshing water and jumping fish from being able to get out of the tank; tank is also kept centered this way
8. tank is also prevented from swinging by sandbags around it's bottom area

Offered by [Michel](#).

A problem that anyone who has kept fish knows is the pretty rapid degradation of the water with waste and lack of air, so that aeration would become an issue rapidly. Of course, if we kept the fish in the temporary suspended tank for a brief period (just during earthquakes) it seems logical that they might survive. In light of possible poisoning of a pond due to volcanic ash, I do feel less optimistic about using a natural pond as a "holding tank" until after the pole shift. But it would make sense to stock and cultivate a pond anyway, even if merely as a backup. I would think we obviously can't predict conditions exactly at any given site and the more redundancy, the better. It might not be too costly to do at some locations. Assuring that live fish survive is the point.

Offered by [Craig](#).



# Troubled Times



## Sewage Treatment

---

An article called *Plants that Purify* on page 9 of the Jan/Feb '92 issue of *Audubon* describes how marsh plants effectively cleanse the effluent from sewage water. The marshes emit no unpleasant odors and are home to birds, turtles, and fish. Excerpts of the article follow:

- A floating, wind-driven aeration device anchored in the pond's center churns and oxygenates the resulting soup, allowing aerobic bacteria to slowly break down the solids, which then settle to the bottom as sludge. In this airless gunk, anaerobic bacteria continue the decomposition process. The time bacteria are given to consume nutrients is one of the main differences between a natural and mechanical sewage-treatment system. [The] sewage remains in its settling pond for three months, ample time for bacteria to chew on and break down pollutants.
- Rows of nutrient-absorbing plants such as African calla lilies, water irises, arrowheads, and miniature and giant bulrushes grow in the waterlogged gravel. A small group of plants with large leaf surfaces, such as the African calla lily, can suck up water at a prodigious rate - about 1,000 gallons per day, depending on sunlight - and release it into the air through evapotranspiration. Wastewater spends a month trickling through the rocks and roots of the filter, where bacteria and microbes attached to plant roots further break down pollutants. ... The key processes of natural sewage treatment are entirely invisible. Plant roots nurture and shelter countless microorganisms that not only consume ammonia, nitrogen, and phosphorous but also attack and break down such pollutants as industrial chemicals, detergents, and pesticides into simple compounds that the plants can then absorb.
- B.C. Wolverton, Ph.D., a pioneer in natural wastewater treatment ... has been researching the ability of plants to clean polluted water for more than 20 years. He spent much of that time at NASA's Stennis Space Center, in Picayune, Mississippi, developing a way to recycle waste at the agency's planned moon base. Now retired, he heads **Wolverton Environmental Services**, which advises towns and cities on natural treatment systems. Rock-reed filters like the one at [Benton, Louisiana] are his design, though the basic idea has long been used in European countries, principally Germany and the United Kingdom.
- In a 30 by 120 foot [Providence, Rhode Island] greenhouse ... rows of huge translucent cylinders contain water hyacinths, watercress, bald cypress seedlings, ginger, and philodendrons, as well as snails and tilapia (a fish species), which break down the waste as it flows from tank to tank. This unique system is the brainchild of John Todd, Ph.D., a visionary and former scientist at the Woods Hole Oceanographic Institution.

An article called *Space-Age Sewage System* on page 30 of the June '93 issue of *Popular Science* magazine describes a natural biofilter for processing sewage. Excerpts of the article follow:

- **Ocean Arks International** in Falmouth, Mass., has developed a down-to-Earth alternative to conventional wastewater treatment. By mimicking pond and marsh processes, his greenhouse-based "living machine" cleanses sewage without intensive energy or chemicals. ... Sewage flows into aerated tanks inside a small greenhouse, then to a series of solar silos inside a larger greenhouse. The silos contain microorganisms, snails, shellfish, and plants such as hyacinths and watercress; some also hold fish. In a clarifier, solids settle to the bottom for removal. The remaining liquid flows through a "biofilter" of plants such as bulrushes and cattails. ... Pilot projects are already being used to treat waste from septic tanks in Harwich, Mass.; municipal sewage in Providence, R.I.; and dairy wastes at the Ben and Jerry's ice cream factory in Waterbury, Vt.



# Troubled Times



## Water Lilly

---

The common Water Lilly is one of the most efficient and effective means known for removing pollutants and toxins from water. It does, however, require a lot of light.

Offered by [Ron](#).



# Troubled Times



## Lead

---

The [EPA](#) has information about lead in water, including effects on the body. Lead does not find it's way into ground water from the surface. Lead is not accumulated in fish, etc. If fish do not accumulate lead, they can be farmed in large ponds outside after the pole shift, in as great a quantity as can be fed!

Offered by [Ron](#).



# Troubled Times



## Eggs

Does anybody know how many eggs a chicken is generally lays in one day? I am trying to figure out how much protein in this way will be available on a daily basis, protein is of the utmost importance.

Offered by [Michel](#).

The number of eggs depends on the season, the amount of light. Some days none, some many.

Offered by [Toni](#).

According to a USDA report, the average hen lays about 21 eggs per month, or roughly four eggs per week. That is with commercial production feeds and methods. Post pole shift, home grown methods would be considerably less efficient.

Offered by [George](#).

Diet and stress factors are important as well in egg production.

Offered by [Gus](#).

We have 13 chickens we hope to get eggs from this winter (well 11 and 2 roosters), a friend has about 30 chickens. They get about 2 dozen a day from them depending on the season. They seem to slow down in the winter a little. Our chickens are part of the self subsistence program we are getting into.

Offered by [Clipper](#).

Okay, so 30 chickens for about 24 eggs a day. Lets say this would be for a very good day. For a bad day I would bring the amount down to half the production, so that will be 12 eggs a day. If I factor the stress in, the lack of nutritional food, the cold, the lack of light and perhaps the moisture which will kill off some chickens now and then by worsening any complications or illness that lays dormant. Perhaps if you divide the chickens into groups in separated coops in case illness breaks out, the loss would be less. 30 chickens, 10 die off, leaving 20 chickens. With the above circumstances I would expect no more than 1 egg per chicken per week, that still will be 20 eggs a week! In a community the amount of chickens will need to be much higher.

Offered by [Michel](#).



# Troubled Times



## Synergistic

---

Chickens can be raised in a manner to minimize waste and increase efficiency in a garden. A March 7, 1993 *New York Times* article called **What a Little Chicken Breath Can Do**, describes how growing chickens in an indoor green house can contribute warmth and nitrogen to the growing plants.

Even on a blustery zero-degree day, it's so warm - 80 degrees - in Anna Edey's solar greenhouse on Martha's Vineyard in Massachusetts that the vents are open. .. "Each chicken puts out eight BTU an hour per pound", Ms. Edey said, as the clucking of hens and the occasional crows of two roosters filtered through the north wall. Each hen, scratching about on the earth floor and laying eggs in coops next to the green house wall (lined with 50 gallon bags of water that collect heat), saves the business about two and a half gallons of fuel oil a year.

Not to mention the gold in chicken breath. .. "They're producing CO<sub>2</sub>, which plants need because carbon is their basic building block", said Ms. Edey. .. "The carbon dioxide content in the greenhouse is about three or four times as high as in the air outside", she added. ... The flock produced plenty of carbon dioxide and body heat for the green house, as well as high-nitrogen manure.

Did she ever smell ammonia, a byproduct of the bird's waste? [The] people at New Alchemy Institute had heated their greenhouse with manure and vented the ammonia through perforated pipes in the soil. "The moisture, carbon and microbes in the soil help transform ammonia into nitrogen, which fertilizes the plants," Ms. Edey said.



# Troubled Times



## Multiple Uses

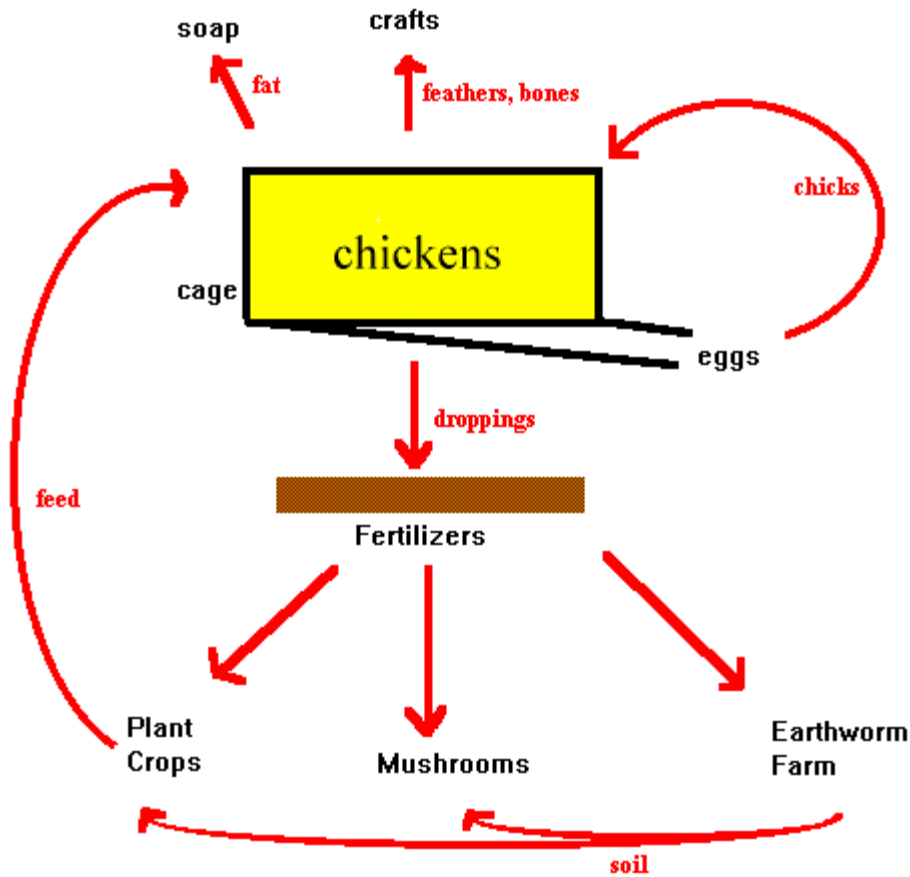

Offered by [Tim](#).





# Troubled Times



## Cautions

---

This is an excerpt from **In-Tele-Health**, a highly accurate and scientifically supported source of info. I would also like to add that eggs should not be eaten raw from a cholesterol point of view (not indicated below). Although *cooked* eggs do not contribute to cardiovascular disease, *raw* Whites of eggs *do* affect Cholesterol levels. Egg whites should be cooked completely (hard), yolks may be soft, as in soft boiled or poached eggs, the reason is that together cooked whites counteract the cholesterol from yolks, so one part cancels out the other.

Offered by [Jan](#).

*Eggs should not be eaten raw as (unless cooked) the Avidin in Egg Whites binds with Biotin in Egg Yolks preventing Biotin's absorption. Eggs should be stored in the refrigerator to avoid the risk of food poisoning from Salmonella Bacteria with which some may be contaminated. Despite its high Cholesterol content, statistics seem to exonerate the Egg from the blame for Cardiovascular Disease.*



# Troubled Times



## Roosters

---

My Chickens generally lay one egg each a day, but sometimes they don't lay at all. Don't get discouraged if they don't lay every day; they will always come through on another day. I have 7 laying hens, some of which just started laying, and I get anywhere from 2-4 eggs a day. It also depends on the season, and what the temperature is. Hens usually lay better without roosters in their pen, also.

**Arnie**

I have never noticed that chickens lay better without roosters. I have 10 hens and three (very happy) roosters. My sister next door has about 20 hens that are just now starting to lay. She is getting about 4 eggs a day. She (still) has about 10 roosters and this does not seem to affect the hens at all. You don't need roosters at all just to get eggs. Only if you want fertile eggs and want to make a few roosters happy. I can't tell you the biological reasons why chickens lay eggs without a rooster, but they do. They just are not fertile unless a rooster has done his thing first. I guess it's like the chicken is going to lay eggs anyway, without the rooster. The only way they will be fertile is if he gets lucky first. The mixing happens in the chicken.

Her chicken hut is built very well and warm. The chickens are still laying. Mine on the other hand is cold as of yet. My hens quit laying. Temperature is a big factor in whether hens lay or not going hand in hand with the season.

Offered by [Clipper](#).



# Troubled Times



## Fertile Eggs

---

I'm not sure of the exact and complete answer; but blood spots have to do with the egg having been fertilized, I believe. Had the egg been incubated a chick would have been produced. Eggs we buy at the store almost never have these "blood spots" because the hens aren't allowed even close to a rooster, so are never fertilized.

Offered by [Ron](#).

From an egg FAQ.

**Q:** *What causes blood spots?*

**A:** *Small spots of blood (sometimes called "meat" spots) are occasionally found in an egg yolk. These do not indicate a fertile egg; they are caused by the rupture of a blood vessel on the yolk surface during formation of the egg. Most eggs with blood spots are removed during the grading process but a few may escape detection. As an egg ages, water moves from the albumen into the yolk, diluting the blood spot. Thus, a visible blood spot actually indicates a fresh egg. Such eggs are suitable for consumption. The spot can be removed with the tip of a knife, if you wish.*

Offered by [George](#).



# Troubled Times



## Guinea Hens

---

A recent addition to my garden is some Guinea fowl. They are the best bug catchers you have ever seen; they took care of my potato beetle problem and some other pests I had. Unfortunately they eat the beneficial insects as well.

Offered by [Mike G.](#)



# Troubled Times



## Arucanas

---

The chickens I raised were an exotic assortment of breeds although most were Arucanas, originally from South America. Those are the ones that lay the colored eggs. My sister, who lived on a farm across the road, ordered chicks at the same time but opted to be sensible and get the commercial breed recommended for early egg production and fast development. The Arucanas started laying a full month earlier than hers and developed much faster as well. I also found them to be a very agreeable, calm and friendly flock whereas the other breeds I had and her flock were far more flighty and high strung. Their egg yolks were smaller than other eggs of the same size (ergo lower cholesterol) and people we shared them with thought they were extremely tasty and got a kick out of the pastel egg colors too!

Offered by [Sue](#).



# Troubled Times



## Free Range

---

What will we feed the chickens? My idea is that worms will do, but still, they need other nutrition as well, as we, like every other animal, need vitamins, minerals and proteins to make the day. Has anybody thought about how to grow what for which animal?

Offered by [Michel](#).

We have done a few experiments with our chickens. They seem to like food scraps. We turn them all loose at once sometimes. They dig and scratch for worms, bugs, etc. I had some chickens last summer. I would let them out of their pen once in a while and they would roam the yard. We had a lot of ants last year, at least until we let those chickens out. The ant population diminished extensively. Chickens have been around for eons and have survived. They will eat what they can get and scrounge for. They even eat grass and weeds. Mine even come when I whistle.

Offered by [Clipper](#).

Why not free range your chickens? Let them run free in a large fenced-in area (meaning acres) and they will fend for themselves. They will eat the bugs on your vegetable plants and fertilize your garden. Then you can eat chickens instead of the bugs.

Offered by [Granville](#).

I raised chickens for a year when I lived in Minnesota and they ran free around the house and dairy barn area. The house had not been lived in for many years and the area was totally overgrown with weeds. By midsummer of the year the chickens arrived, there were almost no tall weeds of any kind around the house/barn area and we are talking about maybe 40 chickens and a very large roaming area. I know they also enjoy bugs, but they did not have quite the same effect on the insect population as they did on the vegetation. The mosquitoes still bit the devil out of us if we had to be out after sundown! They did not get into the garden often because it was fenced, but when they did, they were somewhat destructive, especially where tomatoes were concerned.

Offered by [Sue](#).



# Troubled Times



## Egg Shells

---

I know some farmers even recycle the egg shells back to the chickens to help build stronger eggs.

Offered by [Clipper](#).



# Troubled Times



## Housing

---

Providing light for your chickens is actually easier than providing light for plants. There was a chicken farm just outside of town where I grew up. They used regular incandescent lights and would cover the windows in the winter. The chickens were never allowed to run free as this was a mass production farm, but they produced tons of eggs! If memory serves, the lights were spaced about 8 feet apart (in all directions) and were not too bright (compared to the lights in my house). The circadian rhythm was maintained and the chickens laid eggs. The cages were arranged above large troughs where their excrement was collected and eventually spread over the fields that grew the grain that fed the chickens. (Boy did the town stink when the wind was right!) The point is, chickens are easy. If you don't cage them and have a rooster or two, you should be successful at getting them to lay and reproduce with minimal electrical demand.

Offered by [Roger](#).

I gave them to my sister next door for the winter since she had a good coop. She has kept a simple 75 or 100 watt bulb in the coop all winter, mostly to keep them warm. At 30 F or 40 F below zero, the coop still stayed at about 45 and above. She also has a few rabbits in the same coop. She has had more eggs than she can get rid of. Literally. We eat what we can. I think after the shift, if chickens are allowed to roam and act naturally, they will reproduce. In the coop, a little light, mostly for heat, and their own body heat will keep them going in the winter. Here is a way to build a chicken pen. It worked great and took no time at all to make. It is made from old bed springs. We tied them together with small rope. We happened to be able to find some used bed frames at an Army surplus place so we bought some up. A hog farmer locally used this idea for pigs. He said it worked great for that also. Some of the holes between some of the springs are just big enough for the hens to squeeze through, so sometimes a few "free rangers" hang out around the outside of the pen area. This type of chicken pen could also be considered a "chicken tractor" as well, as it would not be hard to move it around.

Offered by [Clipper](#).





# Troubled Times



## Long Life

---

The standard "chicken" is normally considered the **White Leghorn** breed. There are tons of poultry that produce eggs and meat. Each breed has different characteristics. The Leghorn hen lives an average of 5-7 years, but can live up to 20 years. She'll lay eggs her entire life, with production decreasing every year from year one. The old school rule of thumb is that she's useful for egg production up until the time that she eats more than she produces - and then you eat her. Some hens produce mass quantities all their life. Keep some of her offspring as these are the ones you want for layers. Try'em out and if they don't bring in enough eggs by 18 months, get the skillet ready.

There's [Useful Info](#) for all.

Offered by [Geoff](#).



# Troubled Times



## Lamas

The Incas saw the benefits in keeping the ancestor of the lama as a pet for the same mentioned reasons as stated above. The Incas domesticated the ancestor, the guanaco, from which both the lama and the alpaca came to be. The lama is a species of South-American camel without the bumps and is smaller in size. The head looks a tad bit like that of a sheep. The alpaca is a domestic species of lama too and equal in almost every aspect to the lama as described above. The alpaca is just a bit smaller and lighter, and it's wool is even finer than that of the lama. Below I have put some additional information

### Lama (*Lama guanicoe glama*)

<b>Gestation</b>	10 to 12 months
<b>Adult weight</b>	70 to 140 kilos
<b>Full length</b>	140 cm.
<b>Tail length</b>	18 cm.
<b>Shoulder height</b>	130 cm.
<b>Full height</b>	160 cm.
<b>Lifespan</b>	20 years
<b>Food</b>	Grasses, herbs and mosses (the lama can survive on very little food and water for a significant amount of time)
<b>Coat color</b>	Brown/white/black, the coat can be multicolored spotted, other times it has just one color.
<b>Group life</b>	It is best to keep them in groups of about 12 lamas. Instinctively males watch out over the group of females (1 per group).
<b>Space</b>	They need now and then the space to graze and run if possible. Lamas can run fast, a large fence is advised.
<b>Strangers</b>	They can attack strangers/imposters (be it animal or human) and are very alert.
<b>Shaving</b>	Only the females are shaved for wool because the males are used as beasts of burden and therefor need their coat to avoid stressdamages to the skin.
<b>Spit</b>	Lamas do spit when agitated, keep in mind that lamas are pretty whimsical.
<b>Oxygen</b>	The lama is for those living at high altitude in the Andes very important as a beast of burden. The lama by day can walk long distances. This it can do because it's lungs have a large capacity in proportion to it's size,

and the blood can absorb much more oxygen than most other animals can, which is an adaptation to its high altitude living.

Offered by [Michel](#).



# Troubled Times



## Many Benefits

I once saw a TV program of which I can't recall the name about people who keep unusual pets. Therein was a family who in their big garden kept lamas for several purposes. As a consequence I went to the library in order to gather the right information, from which I now conclude that keeping lamas in the Aftertime will have many benefits which I have composed into the document below:

- Lamas provide milk (Calcium, Vitamin D, plus butter, cheese and yogurt can be made from milk).
- Lamas provide meat.
- Lamas provide dung with which, when dried, a fire can be fueled. Furthermore dung can be used as fertilizer.
- Lamas provide fat for, for instance, candles.
- Lamas provide leather for, for instance, sandals (belts, shoes, jackets, ropes etc.).
- Lamas provide one of the finest wool in the world. Lamas survive in almost any type of climate, this is due to their wool which is very isolating against both the heat of sun and the cold of winter (the wool is an excellent material to stuff for example clothes, blankets and pillows with and make woolen clothes from).
- Lamas provide a helping hand as beasts of burden, carrying loads and goods for long distances.



Offered by [Michel](#).





# Llamapaedia

HOME FARMS YARN SWEATERS FOR SALE

## Llama & Alpaca Info!

[Ads by Google](#) [Alpaca Wool](#) [Alpaca](#) [Alpaca Farm](#) [Alpaca Farms](#)

Llamapaedia's purpose is provide a centralized information database on llamas and alpacas. Covering history, breeders, books, shows, etc., we strive to provide a wide assortment of information for your research needs. Our most popular sections tend to be [alpaca farms](#), [alpaca yarn](#), and [breeder](#) information for both llamas and alpacas. Refer to our 'Categories' section for additional sections.

### [Alpaca Rugs Free Shipping](#)

Alpaca Rugs from Peru - Hand Made use this code: FREE  
[www.allpakaperu.com](http://www.allpakaperu.com)

AdChoices 

Also, this site is operated for the greater good. We strive to update the site on a regular and constant basis. If you're like to add to the existing content on the site, drop us a line. We're more than happy to add any relevant information / business / service into appropriate categories.

We hope you enjoy the site as much as we enjoyed assembling it!

### Categories:

- » Books/Mags
- » Breeders
- » Care
- » Clothing
- » Farms
- » For Sale
- » Glossary
- » History
- » Origin
- » Rescue
- » Rugs/Blankets
- » Shows
- » Terms
- » Wool/Fiber
- » Yarn

### Links:

- » OSWD

# Troubled Times



## Sources

---

The [Alpaca Owners and Breeders Association](#) in the USA can be contacted for information on where you can find alpaca's (a lama species with good quality wool). I have been asked several times recently about where these animals can be bought in the USA (I know there are breeders in Europe too).

Offered by [Michel](#).



# Troubled Times



## Goats

---

Goats have most of the same advantages of the lama except for size and thus can't carry as much weight. However, it is more practical to have a larger herd and thus be able to distribute a load over many more animals. The primary advantage of using goats, for me, is that once bonded to you they will follow you where ever you go - a big advantage when one must be traveling on foot and directing one's attention to other things such as looking for plants, game, and humans. They will eat *anything* and being smaller than the lama require less food be provided for them when not on the move. The major disadvantage when traveling is the increased likelihood that they could be noisy, thus giving away your location when trying to avoid any undesirable folks you may run across.

Offered by [Ron](#).



# Troubled Times



## On the Move

---

If you are a hunter you will follow game that moves to find food . You will have goat as an animal of choice because it eats almost everything and its milk is quite rich. Sheep is also a good choice and you will get wool for clothing as well.

Offered by [Chris](#).







[Cognition Index](#) | [Virtual Library](#) | [Magazine Rack Search](#) | [Join the Ecological Solutions Roundtable](#)

## GOAT KEEPING

*by Marti Matin-Wood*

As organic growers, we are always thinking of ways to improve the structure and fertility of our soil. At the same time, we need to be concerned about the "cleanliness" of compost ingredients. The ideal is to have a closed circle of production within our farms.;

Here at Two Wings Farm, we are trying to get closer to this ideal by using goat manure and bedding as a main compost ingredient. We have a small herd (under a dozen) of registered Alpine dairy goats.

Why goats? Manure that is easily managed is just one of the many gifts provided by these wonderful creatures. Fresh milk, cheeses, yogurt, meat, skins, and fiber produced at home without the antibiotics, hormones, and dyes sometimes present in the commercial stuff are a few other benefits. Goats are easy to care for: chores take only about 20 minutes morning and evening. These very hardy animals give birth with ease, usually have multiple births and have very few health problems. They can be kept on a small acreage and they are economical: you can keep six to eight goats for the same amount of feed it takes to keep one cow, and you'll get twice the milk. Goats are delightful, funny, smart, affectionate and clean. They will accept you as a herd member when humans won't, and in this plastic and artificial world, there are few things as real, exciting and joyful as seeing your favorite doe give birth to her kids.

The cons? Goats will eat your garden and, given half a chance, will bark your fruit trees and eat your neighbor's roses, so good fences are a must. You will have to be dedicated, especially if you are milking: usually, it's required every 12 hours although it's possible to milk only once a day. However, there's always the possibility of trading off with other goat keepers.

You will need a shelter for your goats, in the form of a shed, stable or barn. Recommendations range from 12 to 20 square feet *per animal*. I would suggest taking a look at the setup of a few goatkeepers and asking them what they would do differently to improve things. Goats are herd animals so you'll need to get more than one. They don't do well as single animals. You'll also need a dry place to keep hay. They eat from three to ten pounds a day, depending on a number of factors. A rodent-proof place for grain is also essential.

The thing I would most strongly recommend to anyone looking into goats is to get in touch with your local goat breeders' association and just hang around, go to meetings, get an education. I've met terrific people who were always willing to advise me and pitch in when I needed help.

There are six breeds of dairy goats in the Canadian livestock registry. The first four are Swiss breeds. *Alpine*,

imported from the Alps in 1920, are large, beautiful, gentle, intelligent, excellent milk providers with feminine lines. *Saanan*, always white, are noted for excellent milk production. *Toggenburg* are always brown with white face markings. *Oberhasli*, a beautiful bay brown with black markings, are the oldest and rarest of the Swiss breeds. *Nubian*, developed in England of Egyptian and Indian ancestry and characterized by Roman noses and pendulous ears, are excellent milk producers though they are sometimes noisy. Docile *La Mancha*, genetically earless ("gopher-eared") and developed in Texas, are good milk producers. In addition to these dairy breeds, *Angora* and *Cashmere* are used for mohair fibers, and *Boer*, from South Africa and New Zealand, are for meat production. It is important to keep the breeds going for genetic diversity. Just as we need to maintain pure varieties of tomatoes, we need also to maintain pure breeds of animals or they will be lost in a "homogenization" effect. So buy pure breeds from the breeder if you can, and don't cross. Too many people are producing inferior animals with poor characteristics, and this serves to devalue goats in general. A breeder will guarantee health, and you will receive registration papers from the Canadian Livestock Records Corp.

At the present time, it is illegal for a goatkeeper to sell, give away or even transport goat's milk that is not from a certified grade A dairy. I feel that this is outrageous and discriminatory to the small holder.

Last year, in British Columbia, there was a 124% increase in small holdings and an 8% decrease in large operations. I suspect other provinces show a similar trend. Those of us with small farms must be released from the straitjacket of legislation that favors the large stakeholders in agriculture. We need to have access to our market.

*Marti Martin-Wood lives with her husband and two children at Two Wings Farm, a small organic holding on Vancouver Island. They produce a wide variety of tree fruits and vegetables which they sell through Victoria's Moss Street Market, and Marti maintains a large collection of rare tomatoes.*

[Copyright](#) © 1996. Marti Martin-Wood

*Reprinted with permission. All rights reserved.*

---

[Info Request](#) | [Services](#) | [Become EAP Member](#) | [Site Map](#)

[Give us your comments about the EAP site](#)

---

Ecological Agriculture Projects, McGill University (Macdonald Campus)

Ste-Anne-de-Bellevue, QC, H9X 3V9 Canada

**Telephone:** (514)-398-7771

**Fax:** (514)-398-7621

**Email:** [info@eap.mcgill.ca](mailto:info@eap.mcgill.ca)

To report problems or otherwise comment on the structure of this site, send mail to the [Webmaster](#)

# Troubled Times



## Protein

---

I have started raising meat rabbits (mixed grade does/purebred New Zealand buck). I have been researching possible alternative feed for them that would be easy to grow. I have come up so far with sunflowers, comfrey, New Zealand Spinach, corn, potatoes (but they must be cooked which could be a problem large scale), pea vines, and of course dried grass if available. I also remember reading on a website that rabbit droppings are 19% protein and can be fed to chickens with great success. Do you know anything about this?

**Robin**

I also seem to remember reading something about feeding rabbit droppings to chickens. Fact is, chickens will eat about anything. One very good food for chickens would be earth worms, which will be extremely easy to raise in vast amounts post pole shift. They can also be fed the vast quantities of insects expected post pole shift, including many that we humans just won't be able to stomach. With the exception of sunflowers and corn (both of which grow too large and require too much light energy for hydroponics/artificial lighting) the others look very promising. One of my priority projects is to find a way to get fat into the diet. That could be well addressed by chickens.

Offered by [Ron](#).



# Troubled Times



## Rabbits

---

I have been researching the possibility of raising rabbits and the techniques in catching small animals, such as wild rabbits. If there are lots of insects there will probably be a goodly number of rodents and animals like rabbits. Rabbits are a great choice to grow and they certainly don't make the noise that chickens do, informing everyone for miles around that you have food to be grabbed. And rabbits grow fast enough so that you can share when you want to. I would hope that the majority of the survivors will be in a sharing mood. It'll certainly be my intent.

I do have experience raising rabbits for food, and will be starting again this summer. One buck and 3 does will produce approximately 250 pounds of dressed offspring a year. You only feed the adults and harvest the offspring when they are weaned. *And you get lots* of material (droppings) for your worm and compost and mushroom operations. I haven't calculated how efficient this will be post pole shift; but it sure should help pre pole shift when groceries, especially when meat is scarce. You can grow the food for the adult rabbits on your own. After the pole shift, soybeans would probably be the best for bulk protein, but a little meat would be a nice treat now and then.

Offered by [Ron](#).



# Troubled Times



## Wild Rabbit

---

Rabbit meat does not have much nutritional value. Early French settlers in Quebec ate plenty of rabbit meat every day during their first winter and suffered heavily from malnutrition.

Offered by [Chris](#).

With regard to wild rabbits, I've read in several sources that on a diet of strictly wild rabbits you can starve to die; due to the lack of nutrients in wild rabbits. You need to check in the internal organs closely while cleaning because wild rabbits carry several diseases that they can transmit to humans. Check the liver and heart very closely for green spots.

Offered by [Mike G](#).

And check the liver for white spots also.

Offered by [Clipper](#).



# Troubled Times



## Liverfluke

---

Our company earns the bulk of its money from controlling rabbits in England and we gut and clean hundreds of rabbits each year that we have shot with a rifle. The white spots are from liverfluke caused by Myxomatosis. Myxomatosis was first discovered in a laboratory population of rabbits in South America in 1896 and was successfully released in to Australia in 1950, followed by its introduction into England in 1953 to control rabbits. It is carried by rabbit fleas and attacks the liver and eyes which almost pop out of the rabbits head before it dies. As the rabbit is blind it cannot eat well and suffers a great deal of weight loss. 98% of all rabbits in the 50's and 60's died. We still have the disease in England but it only seems to effect us every 3/4 years and the survivors are immune. The white spots on the liver seems to be on every rabbit with Myxomatosis and while there is no evidence of humans capturing it as we do not eat them. There is no sign of it in foxes, stoats and birds of prey. While our wild rabbit population is not as high as in Australia our numbers are increasing every year and we have 6 men shooting, trapping, and gassing rabbits all the year round to prevent damage to farmers crops and young tree plantations in the Yorkshire, Lincolnshire and Nottinghamshire areas.

**Regards, John Austerfield, Greenacres Vermin Control**

We don't eat rabbits with Myxomatosis even though we have been told it is harmless to humans. They don't release the Myxomatosis fleas here in Australia anymore, they now use a virus as it is a more humane way to deal with rabbits that are considered vermin, (Myxy, as we call it, is a horrendous way for rabbits to die). I'm not sure if rabbits can be immunized against Myxy as it is carried by a flea, but they can be immunized against the virus.

Offered by [Jan](#).



# Troubled Times



## Diseases

---

What do you know about the white spots on the rabbits liver and surrounding area? We are noticing much of this in my area.

**Melissa**

The cottontail rabbit is important as a game animal across its entire range. In the United States, deer are the only game more pursued by hunters than the rabbit or hare. In Nebraska more pheasants, quail and doves are harvested each year than cottontails, which may indicate that rabbits are an under utilized resource. Since the mid-1980s an average of 150,000 cottontails have been taken by approximately 26,000 hunters each year. Unfortunately, many rabbit carcasses are needlessly discarded by hunters each year due to the presence of two parasites which do not affect man. The larvae of botflies (commonly called warbles) are sometimes found under a rabbit's skin. If the hunter encounters a warble in a rabbit or finds an abscess under the skin where a warble has recently left the rabbit, he can remove that area of the meat and still use the rest of the carcass, provided the meat is cooked properly.

Tapeworm cysts are also found in rabbits. These are sacs of clear fluid that contain small white floating objects and are found attached to the rabbit's liver, intestines and occasionally to its lungs. These cysts are the larval stage in the life cycle of the dog tapeworm. If a dog or wild canine consumes one of these larvae it may develop into a tapeworm, but tapeworms do not develop in humans from these larvae. All of the larvae are normally removed when the rabbit is dressed. Any overlooked cysts are destroyed during the cooking process. This disease is often confused with "white spots on the liver" that are known to be indicative of Tularemia.

Tularemia is a bacterial disease of rabbits that is transmittable to man, usually through openings in the skin. Hunters who notice small white or yellow spots on the surface of the rabbit's liver when they are field dressing it should discard the entire rabbit immediately. During the early stages of the disease the liver can appear normal, though the infected rabbit may behave oddly, move slowly or be easily captured. It is a good idea to wear rubber gloves when dressing a rabbit and it is important to always cook rabbit meat thoroughly. Tularemia is transmitted between rabbits by fleas and ticks. Rabbits die from the disease, so it is not a problem once there has been a good hard frost and the temperature remains cool. A hard frost kills ticks and fleas which carry the disease, and a rabbit infected prior to the freeze will normally die within a few days of contracting the disease.

Offered by [Matt](#).



# Troubled Times



## Sheep

Sheep provide homespun yarn, homegrown meat, lustrous and very warm skins, and beside they are quite amiable animals. They only grow to moderate size; they are quiet, their shelter needs are minimal; they are sure-footed in difficult conditions, and they can graze for almost all their food which is definitely a plus in times when there may be little else to feed them.

When buying them get mixed breed ewes. See if you can locate one that is a twin, cause there will be a very great chance the ewe will then have twins itself. But when buying a Ram, get the best purebred you can buy. You want your flock to have excellence. Go to a reliable breeder ahead of time. There are a number of types:

- Corriedales: grow quickly, are easy to handle and produce good spinning wool.
- Columbias produce good meet.
- Romneys produce long silky fleece, a favorite among spinners.
- Merinos have great wool, but forget about getting much meat off them.

If you have a good pasture for them, you don't have to feed them much else. You need to fence them unless you invest in a couple of good border collies. These animals will constantly keep them in line, and will defend them against predators. An acre of good pasture land and legumes will feed four sheep for most of the summer. You will need to rotate the grazing area, since sheep will eat the grass into the ground. If you do add other items to their diet, you have to do it very gradually.

Except when they are lambs, sheep thrive in cold weather.

There are plenty of good books on sheep herding. For what you get and what you have to do, you won't find a better animal. This is not high tech. Goats and sheep have been herded for thousands of years for clothing and food. And if you supplement them with goats, you have two sure-footed and hardy animals who would require little in the way of food supplementation such as grain, which you won't have immediately in the Aftertimes: one for meat and wool clothing, and one for milk and cheese. Could you do better for small space, and durability. I think not.

Offered by [Eric](#).





# Troubled Times



## Sunlight Dim

---

Concerning vitamin C deficiency, there are many low-light plants that contain an abundance of vitamin C. In fact, I'd be hard pressed to find a plant that didn't contain it. I spent time in the jungles of Panama, and believe it or not, sometimes the natural canopy was so thick, sunlight was rarely seen! **Plantain, mango** and almost all tropical plants survive quite nicely without the benefit of direct sunlight. **Garcinia cambogia** contains more vitamin C than any other plant thus far found.

The hardy antioxidant herbs, garlic and echinacea are also good choices and should be included in a practical herb garden - even a hydroponic one. I believe that **kelp, algae, mushrooms, moss** and other plants can more than supply the vitamin C levels that humanity needs. Alfalfa is a plant that sometimes can grow down to 40 feet in the earth, extracting vitamins and minerals other plants cannot reach.

Offered by [Netkhertet](#).



# Troubled Times



## Vitamin D

---

Iguanas NEED, specifically UV-B rays in which to aid in the production of the vitamin D-3 which aids in the absorption of CALCIUM. Without UV-B to help create the D-3 Vitamin Iguanas can not absorb Calcium and thus develop weak and brittle bones often termed as Metabolic Bone Disease, Fibrous Osteodystrophy and/or Nutritional Secondary Hyperparathyroidism. You can provide this UV-B quite simply by adding a Vita-Lite to the enclosure and allowing about 12 hours of exposure to it per day. If this can happen to Iguanas then without light it can happen to our bodies. Suspect we will need to stock up on vitamin D-3 or supply UV-B light to our bodies in the proper minimum quantities.

The following is from:

Bi 231 Anatomy & Physiology

Lecture: Integument Dr. Walters PCC

Much of this is from Tortora & Marieb

1. In sunny areas, 1 hour/week of arm/face exposure to sun enough for making adequate vitamin D3, so no dietary supplement would be required. Aging reduces ability to make vitamin D3; have 4-fold reduction after age 70. Topical sunscreens may prevent vitamin D3 synthesis. Latitude is important: at our latitude, the sun's angle is low in the winter months and the ozone absorbs photons so well that no vitamin D is made in the skin between November & February
2. Milk has vitamin D3 added, so can go without sun. Other foods: fatty fish like salmon, eggs, butter, liver
3. vitamin D deficiency: if drink no milk & completely cover skin in sun or don't go outside
4. if get enough sun to cause mild sunburn, equivalent to taking 10,000 to 25,000 international units (IU) of vitamin D.
5. If no skin production of vitamin D, should take 400-600 IU/day, otherwise 200 IU/day is recommended.
6. If liver or kidney disease, get calcitriol deficiency. Ingesting vitamin D3 or synthesizing it in skin is ineffective. Need take Rocaltrol (calcitriol) 1,25(OH)<sub>2</sub>VitD3

The major role of vitamin D is calcium homeostasis - it does this by integrating absorption of calcium from the intestine with mobilisation and deposition of bone and its excretion in the kidney. Vitamin D : What happens if you don't get enough? A deficiency of vitamin D is known as hypovitaminosis D. Hypovitaminosis D causes decreased intestinal absorption and bone resorption of calcium, leading to low levels of blood calcium. Low levels of blood calcium stimulate compensatory parathyroid hormone production. This results in demineralisation of bone which presents as rickets in young growing mammals and osteomalacia in adult mature mammals. In mammals other symptoms include : loss of appetite, slow growth, general weakness, digestion problems and stillbirths. In fowl, symptoms include retarded growth, lameness, abnormal bone development, thin shelled eggs and fertility problems. Rickets is a disease of growing bones in which the deposition of calcium and phosphorus is abnormal. This results in the bones being weak, easily broken and the legs may be bowed. It may also result in convulsions and tetany.

Offered by [Mike](#).





# Troubled Times



## Calcium

---

*New York Times*, October 20, 1998

### **Finding Calcium Sources Outside the Dairy Case**

By Jane .E Brody

Achieving the recommended daily amounts of calcium is not difficult for people whose diets are rich in dairy products. Children who drink three or four glasses of milk a day, for example, would easily meet their needs. But there is much confusion about other food sources of calcium and the ability of calcium supplements to compensate for a dietary deficiency.

#### **Facts About Foods**

Food is nearly always a better source of calcium than supplements, if for no other reason than food provides more nutritional benefits than just calcium, including nutrients that help the body use calcium. A consensus conference convened by the National Institutes of Health concluded in 1994 that "to attain optimal calcium levels, a change in dietary habits, including increased consumption of dairy products and/or calcium-rich vegetable sources, is needed."

The experts might have also cautioned Americans about eating too much salt and protein, especially animal protein, which increases the loss of calcium in urine. Eating just one fast-food hamburger leads to a net loss of 23 milligrams of calcium, according to Dr. Robert P. Heaney, a calcium expert at Creighton University in Omaha. However, despite earlier concerns about caffeine, it only minimally increases calcium loss, by about 2 or 3 milligrams for a cup of coffee, Heaney said.

#### **Dairy Products**

Milk remains the best dietary source of calcium for two reasons: the lactose (milk sugar) naturally in milk and the vitamin D added to it enhance calcium absorption through the gut. (For those who have trouble digesting lactose, ample calcium is absorbed from lactose-reduced milk and from yogurt with active cultures, which is also low in lactose.) Ounce for ounce, nonfat plain yogurt has more calcium than milk, although it contains no vitamin D. Among frozen dairy desserts, nonfat frozen yogurt is a much better source of calcium than ice cream or ice milk.

Hard cheese, high or low in fat, is quite rich in calcium. Ricotta cheese is also an excellent, but cottage cheese, creamed or otherwise, is not nearly as good a source as milk and yogurt unless calcium is added by the maker. Using less water when reconstituting dry milk and adding nonfat dry milk powder to other drinks and foods are excellent ways to increase calcium. For children allergic to cow's milk or who become constipated when consuming it, soy milk fortified with calcium or a daily calcium supplement may be substituted.

#### **Vegetables**

Some of the best vegetable sources of calcium include kale, collard greens, turnip greens, mustard greens, Chinese cabbage, chicory and bok choy. Broccoli, chard and acorn squash, though not as rich in calcium, are more common sources. Although spinach has a lot of calcium, it also contains a substance -- oxalic acid -- that binds up its calcium and prevents absorption of all but about 5 percent of it. However, the oxalic acid in spinach and foods like rhubarb does not interfere with absorption of calcium from other foods eaten at the same time. Phytic acid, another substance in

foods like dried beans and peas, also depresses calcium absorption somewhat, but less than oxalic acid. Most forms of fiber have little or no effect on calcium absorption. Wheat bran, though, can partly block absorption of calcium from other foods, for example, the milk in a bowl of bran cereal.

### **Other Food**

Canned sardines with their bones included are especially rich in calcium -- 3 ounces of sardines have more calcium than 8 ounces of milk. Canned salmon, also with bones, is about half as good. Other sources include dry-roasted soybeans, blackstrap molasses, figs, some beans and peas (black-eyed peas, white beans, great northern beans, navy beans and soybeans, although the calcium in beans is only about half as available to the body as that in milk), poppy and sesame seeds, tahini, almonds, oranges and calcium-fortified orange juice. The acid in the juice enhances calcium absorption, and is especially good for older people short on stomach acid. ...

And don't forget vitamin D. Many Americans do not get enough of this vitamin to assure optimal calcium absorption. And the latest studies suggest that adults need 800 International Units a day, not 400 as is now recommended. Although milk is supposed to be fortified with vitamin D (400 units per quart), the actual amount in milk varies widely. About 90 percent of the vitamin D people get is made in skin exposed to the sun's ultraviolet-B rays. Try to expose some part of your body (without sunscreen) to the sun for 10 or 15 minutes a day year-round. Alternatively, eat fatty fish or take cod-liver oil or a supplement with D.



# Troubled Times



## Manufacture

---

The [Vitamin C Foundation](#) reports that Vitamin C is manufactured from glucose.

Date: Thu, 3 Jul 1997 14:17:32-500 (CDT)

From: Owen R. Fonorow

To: bruce@pmc.philips.com

Subject: Re: Manufacturing Vitamin C

Hi,

I was wondering if you could help me on this? I need to know how to "make" vitamin C without having citrus plants available. Is there anywhere I can find this info?

Thank-you,

[Bruce](#)

Thank you for contacting the Foundation which is still largely in the organizational stage. I'll pass this message along to individuals who may have an answer.

According to Patrick Holford in the first article in the first issue of Megascrobic Therapies, animals produce vitamin C in their bodies by converting glucuronic acid derived from glucose (sugar) into ascorbic acid (C<sub>6</sub>H<sub>6</sub>O<sub>8</sub>). Three enzymes are required to make this conversion. So the requirement is sugar (glucose) and not "citrus plants".

I hope this helps.

Owen Fonorow  
President and Co-Founder

I guess "humans" are the only "animals" that can't produce enough vitamin C.

[Bruce](#).

You may know that rose hips (the seed pods of rose plants) contain abundant vitamin C; some people gather them when "ripe" (in the fall) and boil them in water to make a syrup. I don't know whether the ascorbate keeps its potency for long, even in the dark and well covered; it tends to convert quickly to its oxidized form. I'm sure there are other ways of making natural vitamin C from plant parts with high ascorbate content. Of course it would scarcely be pure; you'd be getting phytochemicals in the brew (such as bioflavonoids) as well as other substances.

The most convenient and economical way to "make" your own supply of pure vitamin C is to purchase in bulk (say from Bronson Pharmaceuticals in Missouri) the dry powder or crystal form of ascorbic acid or its "buffered" or mineralized variants: sodium, calcium, and potassium ascorbate. You can stir it into water or juice, or sprinkle it over freshly cut fruit (such as peaches or apricots) to prevent the fruit from turning brown. (I believe the commercial product "Fruit Fresh" is basically vitamin C.) It can be used in canning, freezing,

and drying as well.

[Barbara Marinacci](#)

Executive Director

THE VITAMIN C FOUNDATION



# Troubled Times



## Be Practical

---

From what I've seen, the synthesis of ascorbic acid is a complex organic chemical process. Sure, you could stockpile the precursors and all the associated stuff to make it work and you just might come up with something that won't slowly poison everyone. It can be done, but it is a mis-application. If you are going to stockpile, then stockpile the Vitamin C. It's cheap, readily available, and stored properly it can remain biochemical active for a long time. I'm not in favor of it, but if you must stockpile Vitamin C keep it in small tightly sealed containers and keep away from heat. I suppose some clever person could figure out a way to produce a strain of e-coli to spurt out Vitamin C, but you would still have to feed it sugar. Where are you going to get sugar, I suppose you could stockpile that too. My point is that if you are depending on a stockpile of consumables for your survival you are doomed.

For consumable items like Vitamin C you are better off using biological process to replenish it. Peppers are a very good source of vitamin C. Did you know that vitamin C was first isolated from Hungarian Sweet peppers by Albert Szent-Gyorgyi in the 1930s? I picked that up from a biochemistry textbook found in the bargain bin for six bucks. Do keep in mind that in order to grow peppers you must have light. Vitamin C is vital to survival, but so is Vitamin D. Adults can go a while on Vitamin D stores in their livers, but children need Vitamin D for proper bone formation. Vitamin D in nature is only produced by the action of ultraviolet light on ergosterol or 7-Dehydrocholesterol. It can be produced either in your skin or in food like fish, but only in the presence of UV light.

Offered by [Steve](#)





# Troubled Times



## Wild Edibles

---

I found a site on the Vitamin A and C content of edible wild plants. Note particularly the Ascorbic Acid content of common Violet leaves and Beta Carotene content of Plantain, both very commonly available wild plants.

Offered by [Toni](#).

### **Ascorbic Acid and Vitamin A Content of Edible Wild Plants of Ohio and Kentucky**

Thomas M. Zennie\* and C. Dwayne Ogzewalla

Published in *Economic Botany* vol 31, pp76-79, 1977.

Fresh samples of 16 wild edible plants were assayed for Ascorbic Acid and 10 plants were assayed for Vitamin A. Many of the plants were found to be rich sources of these vitamins when compared with some common garden fruits and vegetables.

#### INTRODUCTION

There is a renewed awareness today of the value of natural resources, and this realization has led to experimentation with an increased utilization of wild plants as food sources. In some areas of the United States the utilization of such foods is not new. The practice has been handed down through generations and is undoubtedly a carry-over from the times when some pioneers and American Indians subsisted wholly on native foods. Wild spring greens are often available several weeks before garden varieties and are used extensively by individuals familiar with them. Dandelion and wild Asparagus are common foods to some people. Tender Poke greens and Lambs-quarters are consumed in such quantities by some families that they are a standard part of the diet - often being preferred to garden greens. Non-cultivated fruits such as blackberries, blueberries and plums are collected in sufficient quantities to be used in preserving for a winter home supply or for sale on the market. We utilize edible wild plants on a regular basis, and in fact, are delighted when various species are in their prime.

Books on wild edible plants often contain such statements as, "Rose hips are rich in Vitamin C" or "Sassafras leaves are anti-scorbutic" but only a few references have included quantitative analysis of tested wild foods of particular vitamins, minerals and/or other ingredients. Some references are difficult to locate and some do not include details of the assay procedures. At best there is a paucity of information regarding the nutritive values of wild plants, and it is for the purpose of extending the knowledge of vitamin content of commonly consumed wild plants that the study was undertaken.

#### PLANTS USED

A selection of wild foods utilized in southern Ohio and northern Kentucky were analyzed for their content of the vitamin A precursor, beta carotene, and ascorbic acid. The plants were chosen because of their availability at the time of the experiment and because their vitamin content was expected to be high. No effort was made to exhaust all the usable species of the area and no effort was made to follow the level of vitamins in the plants through their growing season, although there are values reported for several plants collected at different stages of development.

## CONCLUSIONS AND DISCUSSIONS

The carotene values of ten edible wild plants were determined. On a weight basis, six had higher values for carotene than spinach, which is reported to have the highest vitamin A level of the widely marketed garden vegetables. For the following plants - *Alliaria officinalis*, *Capsella bursa-pastoris*, *Chenopodium album*, *Chrysanthemum leucanthemum*, *Glechoma hederacea*, *Lactuca scariola*, *Plantago major*, *Portulaca oleracea*, and *Viola papilionacea* - each could provide for at least a daily dietary allowance (5,000 units) of vitamin A in a 100 g sample. One collection of *Viola papilionacea* contained a daily dietary allowance in a 25 g quantity.

The ascorbic acid values of 16 edible wild plants were determined. When compared with oranges, on a weight basis, ten of the wild plants had high values of vitamin C: *Alliaria officinalis*, *Allium vineale*, *Allium tricoccum*, *Barbarea vulgaris*, *Capsella bursa-pastoris*, *Cercis canadensis*, *Chenopodium album*, *Duchesnea indica*, *Oxalis stricta*, and *Viola papilionacea*. Each would provide more than a daily dietary amount of vitamin C in a 100 g sample of the food for an average man or for a woman during pregnancy and lactation (60 mg).

The edible wild plants tested have relatively high carotene or ascorbic acid values or both and could be useful components of the diet, particularly for rural families. Most of the plants are found in abundance in Ohio and Kentucky, and collection of a mess for a family sufficient to provide a daily dietary allowance of the vitamins would be a relatively easy task. Many of the plants may be collected in late winter or early spring when commercial sources of fresh foods may be scarce or expensive and a supply of vitamins from purchased foods may be relatively low. Preferably the plants should be consumed prior to wilting or aging so that the palatability and vitamin content would be high.



# Troubled Times



## Vitamin C

---

I have found that pure vitamin C can be bought at the chemist's shop (**ascorbic acid**) cheaply as a powder, which can be mixed with water. It is cheap and easy to store.

Offered by [Michel](#).



# Troubled Times



## Pine

---

From the *Food Bible*.

**Spruce tea** can be made by steeping fresh evergreen needles in water, that will be as potent with the both preventive & curative ascorbic acids as the ordinary orange juice. You can get it even more directly by chewing the tender new Spruce needles, whose starchy green tips are particularly pleasant to eat in the spring.

Pine may just be a popular Christmas tree to you, but to Indians, pioneers, mountain men and hikers, the tree has been a source of nutrition, medicine and at times a lifesaver. All pines share basically the same medicinal qualities. However the main medicinal varieties are scotch pine and white pine. The parts of the tree that are highly medicinal are the needles, inner bark and sap. Pine needle tea is high in vitamins A and C. In fact the fresh green needles have five times the amount of vitamin C found in one lemon. Throughout the centuries, people have literally survived on pine-needle tea as well as cured themselves of scurvy by drinking a tea of both the needles and inner bark of the pine tee.

Offered by [Susan](#).

While reading *Plants of the Rocky Mountains* I came across this passage under "Lodgepole Pines":

*The inner bark is succulent and sweet in May and June (when the sap is running), and it was eaten or chewed like gum. Because it is difficult to digest raw, it was usually boiled: too much caused a bellyache. The nourishing seeds were also eaten. Evergreen tea is high in vitamin C and was taken in winter to prevent or cure scurvy. It is still enjoyed today, often sweetened with sugar, honey, molasses or maple syrup, or spiced with cinnamon, nutmeg and orange peel. Evergreen teas should always be used in moderation, because large amounts can be toxic. Pregnant women should not drink this tea.*

From another source:

### *Pine Needle Tea*

*Crush and snip needles from yellow pine. Boil a pot of water, place pine needles in boiling water, cover, and remove from heat. Let steep from 20 minutes to all night. Refrigerate unused drink. The best tea will be a reddish color and a small amount of oil will rise to the top.*

*Note from author: if you simmer the tea it will contain less vitamin C.*

Offered by [Mary](#).

Pine needles are rich in vitamin C and A. That means that no one need get scurvy if there are pines around. All you have to do is once a day, take a few needles and chew on them for awhile. Swallow the juice to get the vitamins and spit out the needles. You could also make tea out of the needles, but heat kills vitamins, so chewing needles is easiest and best.

Posted on the [Pole Shift ning](#).



# Troubled Times



## Rose Hips

---

**Rose Hip** fruit has been utilized for centuries by native peoples. It has more vitamin C than most of our cultivated food crops, including citrus. Used dried, fresh, for soups, teas, jams and jellies, also in baking. Keeps well, and may be harvested in the winter. There are many seeds in the fruits to propagate for your own homegrown vitamin C. Definitely worth growing and saving the seeds.

Offered by [Toni](#).

Re the conundrum of getting enough vitamin C, rose bushes are very useful in several ways.

1. Selecting old fashioned very thorny climbing ones and rooting them in front of windows and other points on a dwelling that needs defense deters predators, human and otherwise.
2. The fragrance and flowers will lend valuable luxury to an otherwise spartan existence.
3. If the flowers are left uncut, the base will develop into rose hips, the classical source of Vitamin. C. Leave on the plant until deep red. They have a hard hull, so keep very well in a cellar, and can be simmered for rose hip conserve or eaten tender like artichoke hearts.

Offered by [Jenny](#).

I have wild rose bushes growing everywhere. If any plant will survive the pole shift it will be the wild rose. I have tried for 10 years to keep them under control to no avail. Cut them back and they come back in 100 different areas from underground.

Offered by [Mary](#).



# Troubled Times



## Blood

---

Vitamin C in its natural state is an *acid* (Ascorbic Acid). Pauling pointed out that only three species of mammals lost the ability to produce their own Vitamin C: humans, Guinea Pigs, and a fruit bat from South America. So have to get it from our food. But it doesn't take much to prevent scurvy. You could eat the animal or better yet **drink a small amount of blood** from an animal that produces it. Some native tribes do this in Africa. Many plants produce Vitamin C, including flowers (especially roses, which is what Nostradamus used to cure people of the Plague).

Offered by [Ed](#)

I remember a discussion in my anthropology class that yielded the Eskimos' source of this vitamin. They ate **raw polar bear meat!** We destroy so much of the nutritional components when we cook our food. The Lewis and Clark expeditions in what is now Alaska only survived when they realized their guides were eating raw meat so they copied this and after their systems got used to the raw meat, no more scurvy!

Offered by [Roger](#).



# Troubled Times



## Sorrel

---

While looking through one of my many seed catalogs, I came across the herb Broad-leaved Sorrel (also known as **Garden Sorrel**). It is a citrus flavored herb that can be used fresh or frozen in soups or salads. Can be cooked as greens or combined with spinach. It is rich in Vitamin C and is easy to grow (according to the catalog). The catalog was from the **Vermont Bean Seed** company. There is no mention of climatic requirements. My guess would be typical North American climate.

Offered by [Roger](#).





# Troubled Times



## Water Cress

---

I know that Nancy is looking for something that contains Vit. C. that can be easily grown after the pole shift. While hiking recently I came across a huge patch of wild water cress. This small plant grows in water and needs very little light to grow. I have tried to find out the vitamin content but have been unsuccessful. However, here is some information on what it does and what it is. If nothing else, it can be used in conjunction with hydroponic gardens for a fresh salad that grows quickly.

Offered by [Mary](#).

### WATER CRESSES

*Description : Our ordinary Water Cresses spread forth with many weak, hollow, sappy stalks, shooting out fibres at the joints and upwards long winged leaves made of sundry broad sappy almost round leaves, of a brownish colour. The flowers are many and white standing on long foot-stalks after which come small yellow seed, contained in small long pods like horns. The whole plant abides green in the winter, and tastes somewhat hot and sharp.*

*Place : They grow, for the most part, in small standing waters, yet sometimes in small rivulets of running water.*

*Government and virtues : It is an herb. They are more powerful against the scurvy, and to cleanse the blood and humours, provoke urine and woman's courses. The decoction thereof cleanses ulcers, by washing them therewith. The leaves bruised, or the juice, is good, to be applied to the face or other parts troubled with freckles, pimples, spots, or the like, at night, and washed away in the morning. The juice mixed with vinegar, and the fore part of the head bathed therewith, is very good for those that are dull and drowsy, or have the lethargy.*

*Water-cress pottage is a good remedy to cleanse the blood in the spring, and help headaches, and consume the gross humours winter has left behind; those that would live in health, may use it if they please; if they will not, I cannot help it. If any fancy not pottage, they may eat the herb as a sallad.*

*Water Cress (Nasturtium Officinale) is a hardy annual that grows naturally in the soil on the banks of cool to cold streams and spring-fed ponds. It can be found all winter long in unfrozen, sheltered areas. This is the same Water Cress that is sold in grocery stores and used in restaurants. You can eat the leaves and stems that you grow. They have a very peppery taste. Waterfowl eat it and fish like it also. The small floating leaves are rounded, dark green and waxy. The branching stems can spread out for 2'-3' over the surface. Slender roots hang down from the nodes of the stems. It is a very good oxygenator. It develops many small white flowers over the growing season. Plant in garden soil and put the pot by the edge of your pond with a couple of inches of water over the pot. It will do fine in an area of moving water. Water Cress will quickly form a mass of foliage and can outgrow a small pot within two months. You may see the root mass growing over the surface of the soil then as they take in growth of the plant may slow and become scraggly. Either re-pot the plant in a larger pot or chop out a big chunk of the plant and the root mass then fill the hole in with soil. Water Cress tolerates sun, shade or partial shade equally well. It is easily grown from the tiny seeds found at any gardening center that has a decent seed selection. It is also a prolific re-seeder and will re-sow itself yearly. You can also start it from a freshly purchased bunch at*

*the produce section of the grocery store. Make sure you can see the fine white roots on some of the stalks... Push these into wet soil and soon you will have enough Water Cress for all of the salads and sandwiches you could possibly want.*

Good source for Vitamin C perhaps, as it states, I quote;"cure for scurvy". Indeed, it is listed as a hydroponic candidate, and we have it on our list for the lab here.

Offered by [Nancy](#).

The hydroponics growers near me say they they can grow watercress year round. It is delicious fresh in salads and in juice. Much juicier and larger than wild.

Offered by [Toni](#).

I have both an outdoor pond and an indoor pond (for wintering baby fish as well as tropical water plants). I grow watercress in the pond. You don't even have to bother with soil. I just throw in a cutting and it forms its own roots and just grows (like Topsy). The roots take in the nutrient directly from the pondwater- how's that for hydroponics?!

Offered by [Cass](#).



# Troubled Times



## Veggies

---

Right now, it appears that the most likely source of Vitamin C after the pole shift will be the **potato, sweet potato, cauliflower** and **broccoli**. These are cool weather type plants which are good Vitamin C sources. Some of them mature in just a few months, so if one had enough vitamin tablets to last until then, one should be OK. Just how many potatoes does one need to eat? The RDA for Vitamin C is 60 mg/day for the average person. One potato, boiled (then peeled *after* boiling) provides 18 mg of Vitamin C. A half cup of broccoli (4 oz) cooked and chopped yields about 37 mg of Vitamin C. Cauliflower yield 30 mg. Greens are other sources.

Offered by [Lyn](#).

A source of Vitamin C is regular **bell peppers**. One usually sees them green, yet when allowed to ripen on the plant until red, a single bell pepper has more than 500 milligrams of Vitamin C - the greatest source available. They are annuals, and like other plants whose fruit is the important product they need *high* light or they will make a lot of foliage but little or nothing in the way of peppers. When planting a food garden, you can let your leafy veggies take the partially shady areas, but the fruiterers need to hog the light and get the chief benefit from reflecting surfaces.

Offered by [Jenny](#).



# Troubled Times



## Deficiencies

---

Vitamins and minerals are necessary for health. Deficiency diseases manifest gradually, some resulting in poor health and some eventually proving fatal. For some of the fat soluble vitamins, an excess is also harmful.

### Vitamin A

Eye and skin problems. Early symptoms are night blindness, an inability to see in the dark. Progresses to swollen, ulcerated eyelids and corneas, a disease called xerophthalmia which untreated with the missing Vitamin A and a high protein diet leads to blindness. Progresses to dry, rough skin and dry mucous membranes made susceptible to infection. Vitamin A in great excess is toxic, leading to blurred vision and scaling of the skin among other symptoms. Inhabitants of the arctic have been known to experience Vitamin A toxicity following meals of polar bear liver.

### Vitamin B

The B Vitamins are a complex that have similar effects on the body. They include thiamin, riboflavin, pyridoxine and related compounds, niacin, cyanocobalamin, folic acid, pantothenic acid, biotin, carnitine, choline, lipoic acid, myoinositol, and para-aminobenzoic acid. Beriberi, a nerve disease resulting in painful rigidity, develops due to thiamin deficiency. Cracks at the side of the mouth and a greasy inflammation of the skin result from riboflavin deficiency. Pyridoxine deficiency can cause convulsions in infants. A niacin deficiency causes pellagra, resulting in diarrhea, skin rash, and dementia symptoms such as confusion, apathy, and delirium. Pernicious anemia is caused by a deficiency of cyanocobalamin, as well as numbness and paralysis and other symptoms such as a smooth tongue and both constipation and diarrhea. Folate deficiency causes anemia, fatigue, diarrhea, and shortness of breath.

### Vitamin C

Scurvy, which can ultimately lead to anemia and death through hemorrhage, particularly in the skin and mucous membranes. Bleeding gums, slow healing wounds, and easy bruising are symptoms, as well as susceptibility to infections.

### Vitamin D

Vitamin D is fat soluble. Vitamin D is manufactured by the human body in adequate supplies with no more than 15 minutes a day exposure to ultraviolet in sunlight. Cloud cover or pollutants in the air interfere with ultraviolet penetration, and during winter or in urban areas, exposure to sunlight often does not suffice. Cereal grain bran, liver, meat, and eggs contain Vitamin D. Vitamin D builds in the body when taken in excess, and can result in nausea and weakness. Small yellowish deposits are found beneath the fingernails, in the eyes, and scattered over the skin.

### Vitamin E

Sterility in the male and spontaneous abortion in the female can be caused by a Vitamin E deficiency. Muscular weakness and degeneration also results.

### Vitamin K

Since Vitamin K is synthesized by intestinal bacteria, deficiency diseases are seldom seen except in newborn infants not breast fed or where the flow of bile has been inhibited. Vitamin K deficiency causes hemorrhage.

### Calcium

Softening of the bones, periodontal disease, and susceptibility to bone fracture. Lack of Calcium contributes to high blood pressure and depression.

### **Copper**

Skin sores, general weakness, and poor respiration.

### **Iodine**

Enlarged thyroid gland, slow mental reaction, weight gain, and dry skin and hair.

### **Iron**

Anemia, heart palpitations, constipation, and fatigue.

### **Magnesium**

Paralysis and convulsions, dizziness, muscle cramps, nervousness, and an irregular pulse. Blindness and deafness in infants. Magnesium deficiency contributes to kidney stone formation.

### **Potassium**

Respiratory failure, cardiac arrest, and poor muscle reflexes.

### **Zinc**

Slow wound healing, retarded growth and sexual maturity, skin and hair problems with white spots on the fingernails, and poor resistance to infection.

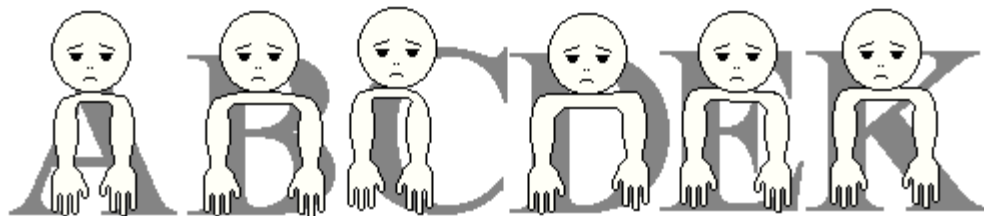

Offered by [Nancy](#).



# Troubled Times

Vitamin Deficiency Chart				
Vitamin	Functions	Sources	Deficiency Results	Highest Risk
A	For good vision; growth	Liver, fish, oils, milk, yolks, spinach, carrots	Coarse, dry skin; poor night vision	<a href="#">Cystic fibrosis</a> ; liver disease
B <sub>1</sub>	For brain, nerves and muscles	Pork, liver, whole grains, bread, cereal, nuts, eggs, milk, legumes	<a href="#">Cardiomyopathy</a> , numbness of extremities (Beriberi), mental confusion	Alcoholics
B <sub>2</sub>	Assists in breaking down food for energy	Liver, kidney, milk, cheese, eggs, legumes, breads, cereal	Cracked lips, sore tongue, skin disorders, impaired vision	Poor diet
Niacin	Assists in breaking down food for energy	Fish, meat, poultry, whole grain, breads, cereals, eggs, peanuts	Pellagra: sore, red, cracked skin, mouth sore, digestive irritation, diarrhea, anxiety/dementia	Alcoholics & transients
B <sub>6</sub>	Assists in breaking down food for energy	Pork, liver, whole grains, bread, cereal, nuts, eggs, milk, legumes	Skin irritation, dry lips, depression, nausea	Taking birth control pills
B <sub>12</sub>	Red blood cells production; healthy nerves	Liver, other animal products	<a href="#">B<sub>12</sub> deficiency anemia</a>	strict vegetarians
Folic Acid	Red blood cells production	Liver, vegetables, wheat, eggs, legumes	<a href="#">Anemia</a>	Pregnant women & alcoholics
C	Growth, health of cells, infection response, stress	Citrus fruits, vegetables	Skin & tissues hemorrhages, stiff limbs, bleeding gum (Scurvy)	Elderly on restricted diets; infants drinking only cow's milk
D	Good bone structure & teeth; Helps in calcium &	Liver, fish oils, eggs, milk, butter, sunlight	Rickets in children; <a href="#">Osteomalacia</a> in adults; bone fracture in the elderly	Babies and elderly people with low sunlight exposure

	phosphorus absorption			
E	Cells damage & degeneration protection	In most foods: wheat-germ; green leafy vegetables; eggs; nuts	None	None
K	Blood clotting	Green leafy vegetables, vegetable oils, liver	External & internal bleeding; affect baby during pregnancy	Fat <a href="#">malabsorption</a> , severe <a href="#">jaundice</a> , liver <a href="#">cirrhosis</a> ; on long-term antibiotic

Offered by [Tim](#).



# Troubled Times



## Food Sources

---

The food sources noted below do *not* include dairy products such as milk or eggs, the meat of large domesticated animals such as beef or sheep, or long growth cycle foods such as fruits and nuts which require mature trees. Where these items provide vitamins and minerals, more easily grown food sources prove to be equal if not superior sources of vitamins and minerals. The sources noted below are vegetables and fruits that can be grown hydroponically or have a short growth cycle, or protein sources from aquaculture that can be nourished from algae grown in sewage effluent or with garbage scraps, which is simply nature's way.

### Vitamin A

Vitamin A is fat soluble. Abundant in fish and fish oils and in animal fats, especially in the livers. Vitamin A is a fat soluble vitamin. Can be manufactured by the human body from components in fruits and vegetables, especially from beta-carotene found in yellow and green leafy vegetables. Carrots are an excellent source of beta-carotene.

### Vitamin B

The B Vitamins are water soluble. Thiamin is most abundant in cereal grains but beans and legumes are a close second. Riboflavin is most abundant in animal hearts and livers followed by soybeans and vegetables such as sweet potato. Pyridoxine and related compounds are most abundant in cereals, followed by fish and fowl and then yellow and green vegetables. Niacin is abundant in cereals, fish and fowl and stewed rabbit, liver, mushrooms, and vegetables such as peanuts, peas, soybeans and potato skins. Cyanocobalamin is abundant in clams and oysters, liver, and cereals. Folic acid is abundant in beans and legumes, brewer's yeast, cereals, and liver.

### Vitamin C

Vitamin C is water soluble, and is destroyed by heat or exposure to oxygen or alkaline substances. Abundant in cranberries and quite high in broccoli, cauliflower, cabbage, kohlrabi, and sweet red or green peppers, tomatoes, and melons, especially where these fruits and vegetables are eaten raw. The new buds in the spring from a pine tree when boiled will make a good tea that one can use to treat scurvy. Scurvy grass in Scotland is also high in Vitamin C.

### Vitamin D

Vitamin D is fat soluble. Vitamin D is manufactured by the human body in adequate supplies with no more than 15 minutes a day exposure to ultraviolet in sunlight. Cloud cover or pollutants in the air interfere with ultraviolet penetration, and during winter or in urban areas, exposure to sunlight often does not suffice. Cereal grain bran, liver, meat, and eggs contain Vitamin D.

### Vitamin E

Vitamin E is fat soluble. Abundant in wheat germ oil, sunflower seeds, peanuts, kale, and sweet potatoes.

### Vitamin K

Vitamin K is fat soluble, and is found in the leaves of all plants.

### Calcium

Abundant in soybeans and other beans, oysters, and fish, and quite high in amaranth, sesame seeds, broccoli, kale, turnip greens, spinach, pumpkin, leeks, mustard greens, okra, parsley, and collards.



### **Copper**

Highly abundant in oysters and abundant in crabs, liver, sesame seeds, peanuts, lentils, beans and peas, mushrooms, potatoes, rice and cereal grains, and fish.

### **Iodine**

Found in algae and seaweed, where it is extracted from sea water. Iodized salt should be stocked in preparation for the Pole Shift for those living inland.

### **Iron**

Abundant in soybeans, bulgar wheat, lentils, liver, spinach, sunflower seeds, pumpkin seeds, squash seeds, and sesame seeds.

### **Magnesium**

Abundant in spinach, swiss chard, navy beans, peas, peanuts, beet greens, broccoli, okra, and leeks.

### **Potassium**

Abundant in carrots, beans and lentils, swiss chard, beet greens, cauliflower, kohlrabi, and potatoes.

### **Zinc**

Zinc is found in great abundance in oysters, and is abundant in poultry, cowpeas and black-eyed peas, beans, and peanuts.

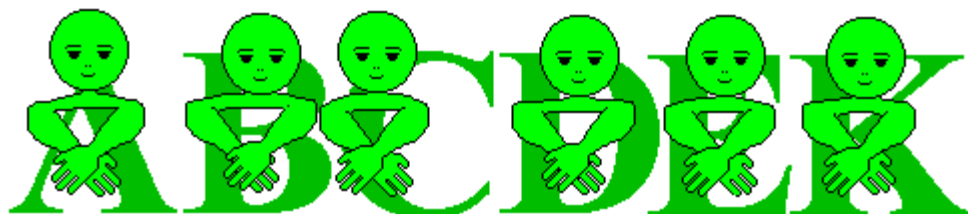

Offered by [Nancy](#).



# Troubled Times



## Eat Smart

It should be noted that small, frequent meals allow the body to absorb nutrients more efficiently. In addition, water used to cook foods should not be discarded as it is high in vitamins and minerals drained from the cooked food. Use this water in soups. Raw fruits and vegetables retain the Vitamin C best, and the bran from cereal grains is one of the best sources of Vitamin B complex. Cook and eat smart when food is scarce, to maximize the vitamin and mineral potential.

	A	B	C	D	E	K	Ca	Co	Ir	Ma	Po	Zi
Recommended Food	Vitamins						Minerals					
<b>Amaranth</b>							Ca					
<b>Beans and Legumes</b>		B					Ca	Co			Po	Zi
<b>Beet Greens</b>										Ma	Po	
<b>Black-eyed Peas</b>												Zi
<b>Brewer's Yeast</b>		B										
<b>Broccoli</b>			C				Ca			Ma		
<b>Cabbage</b>			C									
<b>Carrots</b>	A										Po	
<b>Cauliflower</b>			C								Po	
<b>Cereal Grains</b>		B		D	E			Co				
<b>Clams</b>		B										
<b>Cow Peas</b>												Zi
<b>Crabs</b>								Co				
<b>Cranberries</b>			C									
<b>Eggs</b>				D								
<b>Fish</b>		B		D			Ca	Co				
<b>Fowl</b>		B										Zi
<b>Greens (all leafy)</b>	A	B				K	Ca					
<b>Kale</b>					E	K	Ca					

<b>Kohlrabi</b>			C							Po	
<b>Leeks</b>						Ca			Ma		
<b>Lentils</b>		B						Ir			
<b>Liver</b>		B		D			Co	Ir			
<b>Melons</b>			C								
<b>Mushrooms</b>		B									
<b>Mustard Greens</b>						K	Ca				
<b>Navy Beans</b>									Ma		
<b>Okra</b>						Ca			Ma		
<b>Oysters</b>		B				Ca	Co				Zi
<b>Peanuts</b>		B			E		Co		Ma		Zi
<b>Peas</b>		B					Co		Ma		
<b>Potato (with skin)</b>		B					Co			Po	
<b>Pumpkin</b>						Ca					
<b>Pumpkin Seeds</b>								Ir			
<b>Rabbit</b>		B									
<b>Rice</b>							Co				
<b>Sesame Seeds</b>						Ca	Co	Ir			
<b>Soybeans</b>		B				Ca		Ir			
<b>Spinach</b>						Ca	Co	Ir	Ma		
<b>Squash Seeds</b>								Ir			
<b>Sweet Peppers</b>			C								
<b>Sweet Potatoes</b>		B			E						
<b>Swiss Chard</b>						K			Ma	Po	
<b>Sunflower Seeds</b>					E			Ir			
<b>Tomatoes</b>			C								

Offered by [Nancy](#).



# Troubled Times



## Not Necessary

---

### Finding Calcium Sources Outside the Dairy Case

By Jane E. Brody

#### Facts About Foods

The experts might have also cautioned Americans about eating too much salt and protein, especially animal protein, which increases the loss of calcium in urine. Eating just one fast-food hamburger leads to a net loss of 23 milligrams of calcium, according to Dr. Robert P. Heaney, a calcium expert at Creighton University in Omaha. However, despite earlier concerns about caffeine, it only minimally increases calcium loss, by about 2 or 3 milligrams for a cup of coffee, Heaney said.

#### Other Food

Canned sardines with their bones included are especially rich in calcium -- 3 ounces of sardines have more calcium than 8 ounces of milk. Canned salmon, also with bones, is about half as good. Other sources include dry-roasted soybeans, blackstrap molasses, figs, some beans and peas (black-eyed peas, white beans, great northern beans, navy beans and soybeans, although the calcium in beans is only about half as available to the body as that in milk), poppy and sesame seeds, tahini, almonds, etc.

### What your doctor may not tell you about menopause

by John R Lee, MD

The obvious source of all calcium is from the earth's soil. Our best edible source of calcium is plants. Plants incorporate calcium into their structure along with other minerals, vitamins, and energy-rich compounds that facilitate calcium's absorption. The common perception, sponsored by the dairy association, is that dairy products are the primary source of calcium. Missing from this perception is the fact that well over 70 percent of the people on earth live in the equatorial zone (between the tropic of Cancer and the tropic of Capricorn), where food plants grow year-round and cows' milk is not used. These people have better bones than we in the more northern industrialized areas have. Also missing from the dairy perception is the fact that cows get the calcium for *their* bones and milk production from the plants they eat.

Too much protein in the diet creates an excess of acidity in the body. The kidneys need to buffer this acidic protein waste-product before they can be excreted in the urine. This buffering is accomplished with calcium, and if there's not enough in the bloodstream to buffer the acidic protein waste-product, calcium is pulled off the bones. This excessive loss of calcium creates a negative calcium balance.

Magnesium, the third most prevalent mineral in bones, not only increases calcium absorption but also facilitates its role in bone mineralization. Magnesium deficiency is common in the US due to our food-growing techniques, our food processing and our diet choices. This important mineral is normally abundant in nuts, seeds, whole grains, and vegetables of all sorts, the diet of our ancestors. Our grains, originally high in magnesium, are "refined," a process that removes the outer fibrous coat along with its magnesium, zinc, and other important minerals. The ideal calcium/magnesium intake ratio is 2:1 .



# Troubled Times



## Cause Problems

---

I just bought a copy of the latest *NEXUS New Times* magazine, October-November issue. On the cover, a title appears "The medical myths of Osteoporosis". The article goes into the myths of calcium, and bone loss. It is obviously important for us to have this supplement, and it is best to get it from vegetables! I wanted to add to the article posted below that Milk and other dairy products can *rob your body of calcium*! Don't believe the lie that dairy is the best thing for you! The American Dairy council, and dairy farmer's want you to believe this, so they have a booming business! According to the author, [Sherril Sellman](#), "Most calcium supplements are not only ineffectual in rebuilding bone, but they can actually lead to mineral deficiencies, calcification and kidney stones. And contrary to popular belief, dairy products have been proven to be a leading cause of bone loss."

This whole milk and dairy thing reminds me of when we tried to give the poor, starving children of Africa milk to survive. Duh! the majority of the world's population cannot even absorb milk in the intestines! The poor little children died of the diarrhea we gave them! Cow's milk is for baby cows. Human milk is for baby humans! We aren't meant to drink milk! Even Doctor Benjamin Spock rethought his entire outlook of raising children, he updated his book before he died. He mentioned that a Vegetarian, or Vegan diet is best for children. Milk can cause ear infections and sinus trouble in children! (It produces mucous!). It is also thought that dairy, and animal protein can cause arthritis!

Offered by [Alanna](#).

For about 6 months have been following [Dr. Peter D'Adamo's](#) *Eat Right for Your Type* (blood type) food recommendations with good results. Cow's milk and milk products are on the Avoid list for A's and O's.

**Type O's** should severely restrict their use of dairy products. Their system is ill designed for their proper metabolism, and there are no highly beneficial foods in this category.

**Type A's**, dairy products inhibit nutrient metabolism. Type A's can tolerate small amounts of fermented dairy products, but should avoid anything made with whole milk, and also limit egg consumption to organically grown eggs. Most dairy products are not digestible for Type A's-for the simple reason that Type A blood creates antibodies to the primary sugar in milk-D-galactosamine, the essential sugar that, along with fucose, forms the type B antigen. Since the Type A immune system is designed to reject anything B like, the antibodies it creates to ward off B antigens will also reject whole-milk products. Soy milk and soy cheese are recommended as good dairy alternatives, and he does recommend goat's milk and calcium supplements.

**Type B** (the herdsman) is the only blood type that can fully enjoy a variety of dairy foods.

Dr. D'Adamo also discusses differences between food allergies and food intolerances. Since most people today are either A's or O's, very few of them can utilize cow's milk products. I'm sure that the dairy industry will try to suppress the results of his studies. I bought buffalo milk cheese and goat cheese this week. They are very good and would certainly think of keeping goats as a companion animal. When my first Type A son developed severe milk allergies at age 5, we put the whole family on goat's milk with a great improvement in our health.

Offered by [Toni](#).

This is a very interesting book by Dr. D'Adamo. His ideas are quite intriguing and some people I know have really been helped by his strategies for diet based on your blood type. My best friend has been enormously helped by his

strategy.

Offered by [Craig](#).

It is indeed related to your ancestors. My physician has informed me (and I've read it from other sources) that 90% of Asians, American Indians (North, Central and South), Middle Easterners, Africans, Mediterranean(ers), and Jewish are lactose intolerant. 50% to 75% of the rest of the population are lactose intolerant. Symptoms can range from mild to severe in all groups. (I am lactose intolerant and have been since my early teens. I'm part Cherokee and my level is severe...) Humans are the only mammals to drink milk after being weaned. Even adult cats, if not fed milk continuously after being weaned, will usually be intolerant.

Offered by [Leila](#).



# Troubled Times



## Potassium

---

Potassium is key for maintaining proper nerve and muscle function and helps your cells maintain proper fluid levels. Adults need about 3500mg of potassium daily. However, since potassium overdose can be a problem, it is not recommended that you take potassium supplements. Where can you get potassium? Bananas are a potassium powerhouse, containing about 700 mg of potassium each, but plenty of other foods provide it as well. The following foods each contain more than 350mg of potassium each.

- 1 cup of cantaloupe or honeydew melon
- 1/2 medium baked potato
- 1 glass of orange juice
- 2 tablespoons of tomato paste
- 1/2 cup of cooked spinach
- 1/2 cup of skim milk





# Troubled Times



## Trace Minerals

---

What do humans get without Selenium: Fatigue, Muscular pain, Scoliosis, Heart Palpatations, Infertility, Cystic Fibrosis, Multiple Sclerosis, Cirrhosis of liver, Pancreatitis, ALS (Lou Gehrig's Disease), Parkinson's Disease, Alzheimer's Disease, and Cancer. Missing minerals have an effect on human bodies.

Offered by [Mike](#).



# Troubled Times



**MSM**

---

A way of getting the most out of what you are eating including vitamins is MSM (methyl sulfonyl methane) which is the solid substance in your body that has the third largest occurrence (carbon being number 1 and calcium being number 2). An added benefit is that it is cheap and has a long shelf-life. It has helped me by giving me more energy (previously I had a tendency to get tired/exhausted real easily). I wouldn't say it was as severe as chronic fatigue syndrome but it was similar although less severe. It has also had other benefits. Below is a quote from the Healthy Living site.

Offered by [Thomas](#).

MSM is not a medicine, a drug, or a food additive. It is a *food* - a pure white sulfur powder. It comes from the ocean and is water soluble. Sulfonyl sulfur is found in plants, meats, dairy products, and vegetation. MSM is the 3rd largest ingredient found in your body.

Don't be confused

... Sulfonyl Sulfur is not Sulfa, Sulfite or Sulfate. These are harmful derivatives of the Sulfur family which the body does not need. - Sulfa is used in wounds to burn and cauterize - Sulfites are put in corn flakes so the bugs won't eat them, and - Sulfates are used in sausages to preserve them.

We may be allergic to sulfa's, sulfites, and sulfates which are the sulfur family. But, Sulfonyl, also in the sulfur family, is nutritional, and you can't be allergic to it, Your Body *needs* MSM!

Have you heard of DMSO?

MSM is DMSO without the bad smelling chemical D1-Methyl. Research chemist Robert Herschler discovered how to oxidize DMSO, causing the MSM to crystallize becoming pure and stable. This process made it possible to store MSM and use as needed without the bad taste or smell.

The body uses MSM to create New Good Healthy Cells. Vitamins and amino acids work with MSM to repair and create these Healthy Cells Without proper levels of MSM, our bodies are unable to build good healthy cells, and this leads to illness.

To maintain good health, we need good flexible, healthy cells. Illness is the result and consequence of a body deficient of materials needed to repair damaged tissue and organs. To fight this deterioration process we must supplement our diets with MSM to provide the body with the proper building materials to maintain a healthy body.

The only side effects are stronger fingernails, toe nails, and your hair grows faster because you have more sulfur in your finger nails and hair than any other cells of your body.





# Troubled Times



## Shelf Life

---

One good thing about mega vitamins is that depending on what brand you buy they have a long shelf life, some for as long as ten years. Granted vitamins are a cheap substitute for getting them in your food they are better than nothing.

Offered by [Mike G.](#)



# Troubled Times



## Maintain Life

---

Amino acids are found in many different foods, for example: meat, milk, eggs, fish, plants, mushrooms, brewer's yeast, cashews, beer, chocolate, potatoes, cola drinks, peanuts, barley, cereals, peas, etc. Amino acids are just as important as vitamins and minerals are. According to *The Doctors' Vitamin and Mineral Encyclopedia* (1991), by Sheldon Saul Hendler, M.D., Ph.D., the following can be said about amino acids:

In principle, an amino acid is any compound that contains an amino group and an acidic function. When biologists talk about amino acids, they usually mean the twenty amino acids that are necessary for the synthesis of proteins. Proteins are large molecules that are *crucial* to life; they are involved in the formation of living structure and they catalyze the chemical reactions necessary for the maintenance of life.

In addition to participating in the synthesis of proteins, amino acids are involved in other important biologic processes such as the formation of the brain neurotransmitters.

The twenty amino acids involved in protein biosynthesis are divided into two broad groups- essential and non-essential. Healthy human adults require dietary intake of eight of these amino acids to maintain good health; phenylalanine, valine, threonine, tryptophan, isoleucine, methionine, lysine and leucine. The remaining twelve - the non-essential amino acids- can be made by the body from other substances. Healthy children require, in addition to the eight amino acids listed above, histidine and arginine. Situations exist in which non-essential amino acids become essential. For example, a physically traumatized adult requires arginine for optimal repair processes to occur.

The twelve non-essential amino acids are; alanine, asparagine, aspartic acid, cysteine, glutamic acid, glutamine, glycine, proline, serine and tyrosine.

Offered by [Michel](#).



# Troubled Times

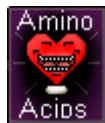

## Essential

Below I have translated important information taken from *The Doctors Vitamin and Mineral Encyclopedia*, about essential amino acids which will be necessary to maintain life in the coming Aftertime.

<b>Essential Amino acids</b>			
<b>Amino acid</b>	<b>Effect(s)</b>		<b>Intake p/day</b>
	<b>positive</b>	<b>negative</b>	
<b>L-Phenylalanine</b>	<ul style="list-style-type: none"> <li>• provides pain relief (only DL-Phenylalanine does this which is available in health food stores too)</li> <li>• dispels depression</li> </ul>	<ul style="list-style-type: none"> <li>• elevates blood pressure (not to be used by people with high blood pressure!)</li> <li>• Dangerous in combination with anti-depressant drugs which contain monoamine oxidase inhibitors. Combination causes dangerously high blood pressure</li> <li>• may help nourish the growth of pigmented melanoma (form of skin cancer) when already present. It doesn't produce melanoma though when melanoma are not present!</li> <li>• persons with PKU (phenylketonuria, an inherited inability to metabolize L-</li> </ul>	<ul style="list-style-type: none"> <li>• Max. 1.5 grams</li> <li>• DL-ph. comes in 375 mg. doses</li> <li>• L-ph. comes usually in 500 mg. doses</li> <li>• as anti-depressant take with L-ph. 20-30 mg. of vitamin B6 on an empty stomach for maximum effect.</li> </ul>

		<p>phenylalanine) should avoid phenylalanine supplements!</p>	
<p><b>L-Leucine</b>  <b>L-Isoleucine</b>  <b>L-Valine</b></p> <p>Note: Leucine, isoleucine and valine are the branched-chain amino acids</p>	<ul style="list-style-type: none"> <li>restores muscle mass in those who have liver disease, those who have undergone surgery and those who have suffered injury or other trauma.</li> <li>treats and in some cases reverses a form of liver damage called hepatic encephalopathy, a frequent feature of alcoholism (helps curb muscle wasting caused by this disease. Also it helps prevent a number of adverse neurologic effects of chronic liver disease through their actions on brain neurotransmitters)</li> </ul>	<ul style="list-style-type: none"> <li>no significant side effects</li> </ul>	<ul style="list-style-type: none"> <li>no specifics</li> </ul>
<p><b>L-Tryptophan</b></p>	<ul style="list-style-type: none"> <li>natural sleeping aid</li> <li>reduces and most times cures chronic insomnia</li> <li>reduces severity of anxiety attacks</li> <li>reduces significantly aggressive behavior</li> <li>controls partially and sometimes wholly the manic phase of the manic-</li> </ul>	<ul style="list-style-type: none"> <li>no significant side effects</li> </ul>	<ul style="list-style-type: none"> <li>as a natural sleeping aid take 1-2 gr. just before bedtime with carbohydrates</li> <li>against insomnia take 2 gr. of tryptophan thirty minutes before bedtime, for three days in a row. Then four days without etc. 'till it's over.</li> <li>as reliever of</li> </ul>

	<p>depressive disorder</p> <ul style="list-style-type: none"> <li>• reduces and can cure a number of depression types</li> <li>• relieves some chronic pains</li> <li>• appetite suppresser (in lean to mildly obese humans only)</li> <li>• reduces severity of hyperventilation attacks when combined with vitamin B6</li> </ul>		<p>chronic pain take 1-3 gr. with carbohydrate rich diet (this combination boosts levels of serotonin and diminishes pain)</p> <ul style="list-style-type: none"> <li>• as appetite suppresser take 2-3 gr.</li> <li>• as reducer of panic, anxiety and hyperventilation attacks take 2-3 gr. with vitamin B6</li> </ul>
<p><b>L-Lysine</b></p>	<ul style="list-style-type: none"> <li>• reduces recurrence rate of herpes outbreaks (it does not reduce duration or severity of herpes once underway)</li> <li>• regenerates and strengthens muscle (only in those who regularly do hard labor/exercise)</li> </ul>	<ul style="list-style-type: none"> <li>• no significant side effects</li> </ul>	<ul style="list-style-type: none"> <li>• in order to reduce recurrence rate of herpes outbreaks take up to 1.5 gr</li> <li>• to regenerate and strengthen muscles use (1200 mg) together with arginine(1200 mg). This combination promotes a significant release of GH (growth hormone) which in turn improves overall health and immunity when the physique is exercised regularly (whether it be through training or physical labor (long walks/working with heavy equipment))</li> </ul>



Offered by [Michel](#).



# Troubled Times

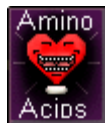

## Extra for Children

Below I have translated important information taken from *The Doctors Vitamin and Mineral Encyclopedia*, about those amino acids which will be required for children growing up in the coming Aftertime.

<b>Extra essential for children</b>			
Amino acid	Effect(s)(for adults too)		Intake p/day
	positive	negative	
<b>L-Histidine</b>	<ul style="list-style-type: none"> <li>• counteracts rheumatoid arthritis</li> <li>• boosts activity of suppressor T cells(rheumatoid arthritis is one of many autoimmune diseases in which suppressor T-cell activity is subnormal)</li> </ul>	<ul style="list-style-type: none"> <li>• no significant side effects</li> </ul>	<ul style="list-style-type: none"> <li>• against rheumatoid arthritis take 1-1.5 gr.</li> </ul>
<b>L-Arginine</b>  Note: is conditionally/essential for adults	<ul style="list-style-type: none"> <li>• boosts very significantly immunity!(promotes production of more and more active and effective lymphocytes which are crucial for immunity. And it stimulates the thymus gland and improves secretion of endocrine hormones ergo overall a greater resistance against infections!)</li> <li>• fights infection</li> <li>• is an enhanced wound-healer after injury and improves healing of burns!</li> <li>• has dramatic anti-tumor properties(regresses cancer, slows down it's growth and/or decreases it's</li> </ul>	<ul style="list-style-type: none"> <li>• children should not take supplementary arginine until their long-bone growth is complete(can cause, in large doses, skin and bone disorders)</li> <li>• causes nausea and diarrhea when taken at very high doses(these effects quickly recede when doses are lowered)</li> <li>• prolonged high doses</li> </ul>	<ul style="list-style-type: none"> <li>• max. 1 gr. for non-adults and those with some forms of kidney and liver failure</li> <li>• for burns, infection, injury and male fertility doses are unknown. It is better to be safe and take not more than 1.5 gr. Higher dosages better to be taken no longer than a couple of days</li> <li>• When a dramatically enhanced lymphocyte activity is desired within just 4 days(for example to fight a nasty infection/prevent infection when infection is spreading from one person to another) then take a</li> </ul>

incidence)  
• inhibitor of loss of muscle tissue after injury or surgery  
• has a detoxifying property(detoxifies some harmful substances(like ammonia) as a liver-detoxifying agent)  
• enhances male fertility(enough to result in pregnancies)

might pose some peril to those with some forms of kidney and liver failure(only to be used under knowledgeable supervision)

high doses(10-30 gr.) for a max. of one week!(better NOT for people with a liver disorder)

Take on an empty stomach. Do not take combined with other amino acids at the same time. Arginine can be combined though with lysine(see lysine) at the same time

Offered by [Michel](#).



# Troubled Times

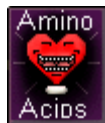

## Non-Essential

Below I have translated important information taken from *The Doctors Vitamin and Mineral Encyclopedia*, about those amino acids which are non-essential but often beneficial.

<b>Non-essential amino acids</b>			
<b>Amino acid</b>	<b>Effect(s)</b>		<b>Intake p/day</b>
	<b>positive</b>	<b>negative</b>	
<b>L-Aspartic acid</b>	<ul style="list-style-type: none"> <li>• might help overcome the rigors of opiate withdrawal</li> <li>• fights fatigue</li> </ul>	<ul style="list-style-type: none"> <li>• no significant side effects</li> </ul>	<ul style="list-style-type: none"> <li>• max. 1.5 gr</li> </ul>
<b>L-Cysteine</b>	<ul style="list-style-type: none"> <li>• might increase 'survival' time (in that it extends lifespan, protects against degenerative diseases linked to aging- cysteine is an established anti-oxidant)</li> <li>• protects against certain toxins and pollutants (acetaldehyde, aldehydes, sigarrette smoke, carcinogens, etc.) when combined with vit. C and B1</li> </ul>	<ul style="list-style-type: none"> <li>• can cause kidney stones(see intake p/day)</li> <li>• can interfere with insulin, so not to be taken by diabetics!</li> <li>• those suffering from Chinese restaurant syndrome should not take cysteine (it can increase the toxicity of monosodium glutamate. Symptoms are: headache, burning sensations, sometimes dizziness and disorientation following the digestion of monosodium-glutamate-laced foods)</li> </ul>	<ul style="list-style-type: none"> <li>• take up to 1.5 gr. (or up to 2 gr. for a couple of days)</li> <li>• take with vit. C (two to three times the amount of cysteine) as a precaution against kidney-stone and bladder-stone formation</li> </ul>
<b>L-Tyrosine</b>	<ul style="list-style-type: none"> <li>• mental</li> </ul>	<ul style="list-style-type: none"> <li>• in some it may</li> </ul>	<ul style="list-style-type: none"> <li>• for PMS take</li> </ul>

energizer and stress reliever (more alert, more efficient, less anxious, fewer discomfort at ascending altitude, less muscle soreness, less headaches and more resistance to cold)

- effective anti-depressant
- may help relieve symptoms of PMS (premenstrual syndrome)
- addictive-drug detoxifier

elevate blood pressure, people with high blood pressure should not take tyrosine!

- elevates blood pressure dangerously when combined with anti-depressants containing monoamine oxidase inhibitors
- migraine sufferers might find this amino acid to increase the incidents of migraine headaches

500 mg. before each of the three meals. (try 1 gr. if 500 mg. is not effective)

- to counteract stress(better take before stressful situations will be encountered) take 1.5 gr.
- for depression take 1.5 mg. up to 12 gr.(12 gr. for a week or two)

Do not combine with other amino acids. Take with a max. of 50 mg. of vit. B6. Take on an empty stomach!

Offered by [Michel](#).



# Troubled Times

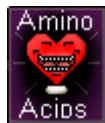

## Non-Protein

Below I have translated important information taken from *The Doctors Vitamin and Mineral Encyclopedia*, about those amino acids which are not involved in protein synthesis but are nonetheless beneficial.

<b>Non-essential amino acids, not involved in protein synthesis</b>			
<b>Amino acid (not involved in protein synthesis)</b>	<b>Effect(s)</b>		<b>Intake p/day</b>
	<b>positive</b>	<b>negative</b>	
<b>L-Ornithine</b>	<ul style="list-style-type: none"> <li>• detoxifies(see arginine)</li> <li>• stimulates GH release(enhances wound healing, arginine too)</li> <li>• enhances immunity</li> <li>• liver-regenerator</li> </ul>	<ul style="list-style-type: none"> <li>• no significant side effects</li> </ul>	<ul style="list-style-type: none"> <li>• take up to 1.5 gr.</li> </ul>

Offered by [Michel](#).



# Troubled Times

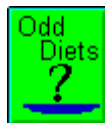

## Mongols

---

The tribes in Mongolia, who have such a heavy dairy diet they eat *no* vegetables or fruit as a rule, my understanding. Their average life span is about 10 years shy of otherwise, but considering the way they live, kind of amazing!

Offered by [Nancy](#).

The key to eating meat and dairy is not to be eating much carbohydrate. Metabolism wise - you will assimilate the fat fine with causing deposits on your arteries. But with sugar added to the diet, the fats combine to make deposited fat.

Offered by [Eric](#).



# Troubled Times

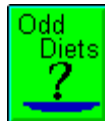

## Himalayan

---

In the 60's a small village was discovered in Himalayas. The settlement was above 4000 meters above sea level. The only plants that were growing in the valley were wild grass and oats. The whole village including dogs was eating bread and drunk beer made out of it. On average people were living there for 102 years.

Offered by [Chris](#).





# Troubled Times



## Glacial Milk

From Dr. Robert Marshall's office newsletter October 1995 he states:

Many researchers calculate the life span (or "genetic potential") of mankind to be around **145 years of age**. Yet, the average lifespan of an American is only 75.5 years. What happened? Maybe we can take a few lessons from 5 well-known human cultures whose peoples routinely live from 120 to 140 years of age. These 5 cultures are: the **Tibetans** of northwest China, the **Hunzakut** of eastern Pakistan, the **Georgians** from Russia, the **Vilcabamba** of Ecuador and the **Titicaca** of the Peruvian Andes. They are all famous for there large number of centenarians. The Georgians consider "youth" to be from 0 to 80 years of age, "middle-age" from 80 to 100 years, and the seniors are those from 100 to 160 years of age!

Although the longest lived peoples all have differing lifestyles and locations, they have 6 common denominators: 1) they live at elevations ranging between **8,500 to 14,000 feet in mountain valleys**, 2) the annual rainfall is less than 2 inches, 3) there is no heavy industry to pollute their air, food or water, 4) Western allopathic medicine was not historically available for them to take (they used herbs and natural remedies), 5) their water source for drinking and irrigation comes from "**glacial milk**" water with precious ground-up minerals from glaciers that actually make the water look milky, 6) they use only natural fertilizers for their crops (manure, plant debris, irrigation with "glacial milk").

He goes on to explain "**Glacial milk**" is a solution of ionically dissolved elements and suspension of finely ground rock dust with an average particle size of 7,000 times smaller than a human red blood cell. The bottom line is there is a lot of colloidal minerals ready for biological use in the water they consume and grow their crops with. About 10 years ago from a friend - I heard that the Darma or "hymns of the dawn child" a many volume book from about 10,000 to 12,000 BC in Asia, had in it a passage that indicated that "some of the boys had come down to eating" in other words the beings in this area took in air, water, and minerals. They looked at "eating" as we would (now days) look at someone taking drugs.

My comments: I think after the shake up of the pole shift there will be plenty of minerals in all water, some good and some bad. We will learn how to filter out the bad. Ultimately, when the sun comes back growing should be very good, and the bad chemicals will eventually go away for all water. The use of herbs will come back naturally as a matter of necessity. I believe number 3) through 6) above will come about through natural causes of the pole shift, and that 1) and 2) are not a major factor. Thus, we should start to see mankind living much longer for those born after the pole shift.

We can help the process along by producing, mineral rich, toxin free, organically grown (or as close to it as we can) food and herbs in our pole shift shelters. This, I believe to be attainable, and is something we can all work to achieve. If we lay out the technology of how to do this, then we will have an improved live style ahead for all those living now. Something to look forward to - more healthy food, that helps to clean and rebuild the body.

Offered by [Mike](#).



# Troubled Times

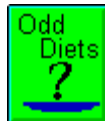

## Meat Only

### Principles of Combining Foods Properly

By Dr. Herbert M. Shelton, Dr. Shelton's Hygienic Review

Author of *Food Combining Made Easy*

There are sound physiological reasons for eating foods in compatible combinations. In other words, some foods, if mixed in the digestive system, will cause distress! The principles of food combining are dictated by digestive chemistry. Different foods are digested differently. Starchy foods require an alkaline digestive medium which is supplied initially in the mouth by the enzyme ptyalin. Protein foods require an acid medium for digestion- hydrochloric acid. As any student of chemistry will assure you, acids and bases (alkalis) neutralize each other. If you eat a starch with a protein, digestion is impaired or completely arrested! The undigested food mass can cause various kinds of digestive disorders. Undigested food becomes soil for bacteria which ferment and decompose it. Its by products are poisonous, one of which, alcohol, is a narcotic that destroys or inhibits nerve function. It plays havoc with nerves of the digestive tract, suspending their vital action such that constipation may well be a result! As set forth in Dr. Herbert Shelton's book, *Food Combining Made Easy*, these are the salient rules for proper food combining.

#### The Basic Rules of Proper Food Combining:

1. Eat acids and starches at separate meals. Acids neutralize the alkaline medium required for starch digestion and the result is fermentation and indigestion.
2. Eat protein foods and carbohydrate foods at separate meals. Protein foods require an acid medium for digestion.
3. Eat but one kind of protein food at a meal.
4. Eat proteins and acid foods at separate meals. The acids of acid foods inhibit the secretion of the digestive acids required for protein digestion. Undigested protein putrefies in bacterial decomposition and produces some potent poisons.
5. Eat fats and proteins at separate meals. Some foods, especially nuts, are over 50% fat and require hours for digestion.
6. Eat sugars (fruits) and proteins at separate meals.
7. Eat sugars (fruits) and starchy foods at separate meals. Fruits undergo no digestion in the stomach and are held up if eaten with foods that require digestion in the stomach.
8. Eat melons alone. They combine with almost no other food.
9. Desert the desserts. Eaten on top of meals they lie heavy on the stomach, requiring no digestion there, and ferment. Bacteria turn them into alcohols and vinegars and acetic acids.



# Troubled Times

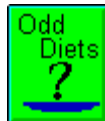

## Raw Food

---

### How to Live on a 100% Raw Diet Healthfully

By [Dr. Stanley Bass](#), N.D. D.C. Ph.D., Natural Hygiene doctor

In preparing the table of contents, I was surprised to find that on four separate occasions, I had tested the 100% raw food diet successfully on the mice. I include in this article all of these diets and the conclusions reached and am pleased that the results were verified four different times, which only strengthens and validates the conclusions.

- [Mice Experiments](#)
- [Conclusion](#) - basis for the ideal raw diet
- Comparing my mice to those in the pet shop
- [Ultimate Raw Diet](#) for humans
- Ultimate raw vegetarian diet
- Foods which can be used on a 100% raw diet
- Sample 100% raw daily menu



# Troubled Times

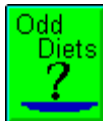

## Enzyme Boost

---

From [Interview with Dr. Edward Howell](#),  
author of *The Status of Food Enzymes in Digestion and Metabolism*

In an exclusive interview, food enzyme researcher Dr. Edward Howell tells why he believes: "Enzymes may be the key factor in preventing chronic disease and extending the human lifespan." Dr. Howell tells: What enzymes are, what they do in our bodies, why he believes a state of enzyme deficiency stress exists in most people, and finally, what he believes you can do about it. "Neither vitamins, minerals or hormones can do any work - without enzymes."

**HDN: What are enzymes?**

**HOWELL:** Enzymes are substances which make life possible. They are needed for every chemical reaction in that occurs in our body. Without enzymes, no activity at all would take place. Neither vitamins, minerals, or hormones can do any work - without enzymes. Think of it this way: Enzymes are the "labor force" that builds your body just like construction workers are the labor force that builds your house. You may have all the necessary building materials and lumber, but to build a house you need workers, which represent the vital life element. Similarly, you may have all the nutrients - vitamins, proteins, minerals, etc., for your body, but you still need the enzymes - the life element - to keep the body alive and well.

**HDN: Are enzymes then just like chemical catalysts which speed up various reactions?**

**HOWELL:** No. Enzymes are much more than catalysts. Catalysts are only inert substances. They possess none of the life energy we find in enzymes. For instance, enzymes give off a kind of radiation when they work. This is not true of catalysts. In addition, although enzymes contain proteins - and some contain vitamins - the activity factor in enzymes has never been synthesized. Moreover, there is no combination of proteins or any combination of amino acids or any other substance which will give enzyme activity. There are proteins present in enzymes. However, they serve only as carriers of the enzyme activity factors. Therefore, we can say that enzymes consist of protein carriers charged with energy factors just as a battery consists of metallic plates charged with electrical energy.

**HDN: Where do the enzymes in our bodies come from?**

**HOWELL:** It seems that we inherit a certain enzyme potential at birth. This limited supply of activity factors or life force must last us a lifetime. It's just as if you inherited a certain amount of money. If the movement is all one way - all spending and no income - you will run out of money. Likewise, the faster you use up your supply of enzyme activity, the quicker you will run out. Experiments at various universities have shown that, regardless of the species, the faster the metabolic rate, the shorter the lifespan. Other things being equal, you live as long as your body has enzyme activity factors to make enzymes from. When it gets to the point that you can't make certain enzymes, then your life ends.

**HDN: Do people do anything which causes them to waste their limited enzyme supply?**

**HOWELL:** Yes. Just about every single person eats a diet of mainly cooked foods. Keep in mind that whenever a food is boiled at 212 degrees, the enzymes in it are 100% destroyed. If enzymes were in the food we eat, they would do some or even a considerable part of the work of digestion by themselves. However, when you eat cooked, enzyme-free food, this forces the body itself to make the enzymes needed for digestion. This depletes the body's limited enzyme capacity.

HDN: How serious is this strain on our enzyme "bank" caused by diets of mostly cooked food?

HOWELL: I believe it's one of the paramount causes of premature aging and early death. I also believe it's the underlying cause of almost all degenerative disease. To begin with, if the body is overburdened to supply many enzymes to the saliva, gastric juice, pancreatic juice and intestinal juice, then it must curtail the production of enzymes for other purposes. If this occurs, then how can the body also make enough enzymes to run the brain, heart, kidneys, lungs, muscles and other organs and tissues? This "stealing" of enzymes from other parts of the body to service the digestive tract sets up a competition for enzymes among the various organ systems and tissues of the body. The resulting metabolic dislocations may be the direct cause of cancer, coronary heart disease, diabetes, and many other chronic incurable diseases. This state of enzyme deficiency stress exists in the majority of persons on the civilized, enzyme-free diet.

HDN: Did human disease begin when man started [Cooking his Food](#)?

HDN: When people get enzymes from food, aren't they destroyed by [Stomach Acid](#) and therefore of little or no value?

HDN: Most - if not all of us, eat lots of cooked foods every day. Can we [Make Up](#) for this enzyme loss by eating raw foods in addition?



# Troubled Times

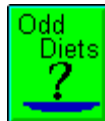

## Eskimo

---

Consider the possibility that Weston A. Price points out in Nutrition and Physical Degeneration, which is that the replacement of local small-scale food production with large-scale production of mostly carbohydrates that can be mass marketed has universally harmed our species. As Price reports for example, the one native American tribe that had no need for healers were the Eskimos of old. The name Eskimo translates to “he eats it raw.” The website of the [Weston A. Price](#) foundation is an excellent place to read up on the contrary-to-common-wisdom advice that he and his followers offer. Ideas like maximizing enzyme consumption and the non-avoidance of fat in ones diet.

Offered by [Steve](#).



# Troubled Times



## Pine Bark

---

Remember that old Euell Gibbons commercial for Grapenuts cereal? Well, Euell was right, many parts of the pine tree are edible. Since pine trees grow almost everywhere in the world, their food value is worth knowing. (Take the time to learn how to distinguish the pine trees in your area from other evergreens!)

- Pine needles are rich in vitamin C and A. That means that no one need get scurvy if there are pines around. All you have to do is once a day, take a few needles and chew on them for awhile. Swallow the juice to get the vitamins and spit out the needles. You could also make tea out of the needles, but heat kills vitamins, so chewing needles is easiest and best.
- The inner bark of pine trees is edible. There are 600 calories per pound of inner bark, which may not seem like much, but it'll keep you alive. I found a Ponderosa Pine once that had recently been felled. I scraped off the outer bark to get to the smooth, white, inner layer. I was able to pull hunks of it out, sort of rubbery. I chewed and swallowed little strips and they were fairly mild tasting. I referred to them as "chicken of the tree"! Indians used this inner bark to survive when low on food during winters--maybe it will save your life someday, too.
- Pinyon pines grow profusely in the West and produce pine nuts. They are delicious. You can pay a high price to get them from specialty stores. Pine nuts contain all 20 amino acids, i.e., complete protein! Most pinyon pines only produce cones about once in 7 years, probably to conserve energy in the dry areas where they grow. Pick the cones when they are still green, in late summer, to beat the animals to them. Allow the cones to ripen back at your camp, then place them near a fire to get them to open. I have heard that one Indian could gather over 100 pounds of pine nuts in a single day during a bumper year!

Posted on the [Pole Shift ning](#).





# Troubled Times



## Earthworms

---

Sanitation comes first to mind at the thought of eating a live earthworm. I certainly soaked my first few over a half hour before I decided that the purging of those little digestive tracts was proceeding just too slowly. Yes, there were a few little black specs still visible in those little G.I. tracts. Did I die? No. I may have felt a little sick but that was more an emotional response. The emotional thing will take some work if you have not conquered it already. If you are curious the flavor of earthworms is largely affected by what they have been eating. Mine tasted a lot like onions, but not until I tried hemp oil did I recognize that special flavor. Hemp oil is high in essential fatty acids (EFAs), just like earthworms. It is that cod-liver-oil like essential nutrition that will help keep your brain sharp and make your cellulite disappear if you have any. Lots of EFAs, as my wife and I both experienced, will eliminate your need for sunscreen, although post pole shift gloom may make that benefit moot. Given all those benefits, were I to choose between feeding my worms to chickens or fish, or eating them myself, I would have to think. Do some math maybe.

At the 2000 Vermillion earthworm conference in Kalamazoo Michigan, I was astounded to see a chart presented by someone reporting on the U.S. EPA trials of using earthworms to process solid waste in three medium sized towns. They were processing about 2 tons of solid waste a day as I recall, and the chart was showing a logarithmic scale of the population of the three organisms they measure when evaluating the safety of a disburseable substance: Amoebae, Helminth Ovae (tapeworm eggs), and enteric viruses. The chart showed a fairly straight line that got lower and lower with each day until it crossed the safety level at about the seventieth day. The line kept decreasing at the same rate after that. The implication I came away with is that those invisible sand filled gizzards are really capable of grinding up even viruses, which boggles my mind, and that the nickname "lions of the soil" is well deserved in the case of earthworms. They sure don't look like predators, but I do imagine I hear little lips smacking each time I open one of my worm bins. Of course the worms themselves have plenty of bacteria in their little rear ends, but apparently none harmful to us. Nice to know. So if you do find yourself in astonishing circumstances you may be glad you can easily recognize the entire annelid family.

Offered by [Steve](#).



# Troubled Times



## Raw Beans

---

I have translated the next from a Dutch book on medicinal plants.

Bean (***Phaseolus vulgaris***) - in general (Fabaceae): Toxicity: residing especially in the seeds and unripe beans is the toxic protein 'phasine'. Raw beans and unripe bodies of fruit, all in general, cause with children repeatedly poisoning effects, because often children recognize the beans as an eatable vegetable. The toxic protein 'phasine' though is destroyed only after a lengthy period of boiling the vegetable, and not by drying. Medicinal value: works as a diuretic, especially where people suffer kidney- and heart disease, rheumatism, in the form of a laxative tea. A nice side effect is that it also lowers the level of sugar in the blood.

Offered by [Michel](#).



# Troubled Times



## Phytohaemagglutinin

---

### FDA's Bad Bug Book

The onset time from consumption of raw or undercooked kidney beans to symptoms varies from between 1 to 3 hours. Onset is usually marked by extreme nausea, followed by vomiting, which may be very severe. Diarrhea develops somewhat later (from one to a few hours), and some persons report abdominal pain. Some persons have been hospitalized, but recovery is usually rapid (3 - 4 h after onset of symptoms) and spontaneous. The disease course is rapid. All symptoms usually resolve within several hours of onset. Vomiting is usually described as profuse, and the severity of symptoms is directly related to the dose of toxin (number of raw beans ingested). Hospitalization has occasionally resulted, and intravenous fluids may have to be administered. Although of short duration, the symptoms are extremely debilitating.

Phytohaemagglutinin, the presumed toxic agent, is found in many species of beans, but it is in highest concentration in red kidney beans (*Phaseolus vulgaris*). The unit of toxin measure is the hemagglutinating unit (hau). Raw kidney beans contain from 20,000 to 70,000 hau, while fully cooked beans contain from 200 to 400 hau. White kidney beans, another variety of *Phaseolus vulgaris*, contain about one-third the amount of toxin as the red variety; broad beans (*Vicia faba*) contain 5 to 10% the amount that red kidney beans contain.

The syndrome is usually caused by the ingestion of raw, soaked kidney beans, either alone or in salads or casseroles. As few as four or five raw beans can trigger symptoms. Several outbreaks have been associated with "slow cookers" or crock pots, or in casseroles which had not reached a high enough internal temperature to destroy the glycoprotein lectin. It has been shown that heating to 80 degrees C may potentiate the toxicity five-fold, so that these beans are more toxic than if eaten raw. In studies of casseroles cooked in slow cookers, internal temperatures often did not exceed 75 degrees C.



# Troubled Times



## Green Potatoes

---

I know that raw green potatoes are toxic.

**Lyn**

The green part is toxic as it contains more solanine than the other part of the potato. Even the potato itself contains a very small amount of that toxin.

**Gerard**

The poisons in potatoes are aflatoxin and solanine. Solanine is concentrated in the eyes and skin of green potatoes, both can effect the nervous system.

**Janar**

When the potatoes grow under the ground, sometimes one will expose it's self. Cover this with dirt or the sun will burn it and that part will be green. Some say that part is toxic but I am still here. I eat them anyway possible. Raw, baked, fried, boiled and with the skins on. If the green sun burnt potato was toxic, I sure wouldn't be here now.

**Clipper**

I do not remember off the top of my head what the actual name of the poison is, but it seems to me that it is a derivative of arsenic. Basically, it is only harmful in large (and I mean *large*) quantities. There is nothing you can do to reduce its concentration in the potato. You can only do this by consuming greater amounts of other foods, like additional vegetables, or make sure that the green potatoes in your meal are minimal in comparison to the good ones.

**Roger**

Indeed, the potato like the tomato or cucumber is part of the nightshade family. If you eat enough of these plants you will get poisoned. There were four guys killed by eating five plates of mashed potatoes. These were biological potatoes, which have more solanine in themselves. This is why they are more resistant against decreases. So the point is, don't eat too much of these plants at once. Give your body and your liver a chance to clear the mess up.

**Jeroen**



# Troubled Times



## Toad Skins

---

There are several types of toxic substances found in toads, including cardioactive agents, catecholamines, indolealkylamines and non-cardiac sterols. These toxins are located in the skin and parotid glands and may be transferred by handling or ingesting a toad's skin.

- Secretions of the toad parotid glands will cause pain and severe irritation when placed in eyes, nose, and throat.
- Dogs who have been poisoned with bufagins develop ventricular fibrillation and symptoms resembling digitalis poisoning. Vasoconstriction may also be seen.
- Dyspnea and weakened respirations may be seen.
- Paralysis and seizures have been reported in both humans and animals. Many bufagins have local anesthetic actions, especially on the oral mucosa.
- Salivation and vomiting were often seen in animals. These toxins may cause numbness of the oral mucosa if ingested.
- Cyanosis has been seen in poisoned dogs.
- Drug users have been known to smoke the chopped skins of toads for their hallucinogenic effect.
- The skin of one toad is sufficient to cause significant symptoms and even death in both animals and humans.



# Troubled Times



## Honey

### FDA's Bad Bug Book

Honey intoxication is caused by the consumption of honey produced from the nectar of rhododendrons. The grayanotoxins cause the intoxication. The specific grayanotoxins vary with the plant species. These compounds are diterpenes, polyhydroxylated cyclic hydrocarbons that do not contain nitrogen. Other names associated with the disease is rhododendron poisoning, mad honey intoxication or grayanotoxin poisoning.

The intoxication is rarely fatal and generally lasts for no more than 24 hours. Generally the disease induces dizziness, weakness, excessive perspiration, nausea, and vomiting shortly after the toxic honey is ingested. Other symptoms that can occur are low blood pressure or shock, bradyarrhythmia (slowness of the heart beat associated with an irregularity in the heart rhythm), sinus bradycardia (a slow sinus rhythm, with a heart rate less than 60), nodal rhythm (pertaining to a node, particularly the atrioventricular node), Wolff-Parkinson-White syndrome (anomalous atrioventricular excitation) and complete atrioventricular block.

In humans, symptoms of poisoning occur after a dose-dependent latent period of a few minutes to two or more hours and include salivation, vomiting, and both circumoral (around or near the mouth) and extremity paresthesia (abnormal sensations). Pronounced low blood pressure and sinus bradycardia develop. In severe intoxication, loss of coordination and progressive muscular weakness result. Extrasystoles (a premature contraction of the heart that is independent of the normal rhythm and arises in response to an impulse in some part of the heart other than the sinoatrial node; called also premature beat) and ventricular tachycardia (an abnormally rapid ventricular rhythm with aberrant ventricular excitation, usually in excess of 150 per minute) with both atrioventricular and intraventricular conduction disturbances also may occur. Convulsions are reported occasionally.

Grayanotoxin poisoning most commonly results from the ingestion of grayanotoxin contaminated honey, although it may result from the ingestion of the leaves, flowers, and nectar of rhododendrons. Not all rhododendrons produce grayanotoxins. *Rhododendron ponticum* grows extensively on the mountains of the eastern Black Sea area of Turkey. This species has been associated with honey poisoning since 401 BC. A number of toxin species are native to the United States. Of particular importance are the western azalea (*Rhododendron occidentale*) found from Oregon to southern California, the California rosebay (*Rhododendron macrophyllum*) found from British Columbia to central California, and *Rhododendron albiflorum* found from British Columbia to Oregon and in Colorado. In the eastern half of the United States grayanotoxin-contaminated honey may be derived from other members of the botanical family Ericaceae, to which rhododendrons belong. Mountain laurel (*Kalmia latifolia*) and sheep laurel (*Kalmia angustifolia*) are probably the most important sources of the toxin.



# Troubled Times



## Aflatoxins

---

### FDA's Bad Bug Book

Aflatoxicosis is poisoning that results from ingestion of aflatoxins in contaminated food or feed. The aflatoxins are a group of structurally related toxic compounds produced by certain strains of the fungi *Aspergillus flavus* and *A. parasiticus*. Under favorable conditions of temperature and humidity, these fungi grow on certain foods and feeds, resulting in the production of aflatoxins. The most pronounced contamination has been encountered in tree nuts, peanuts, and other oilseeds, including corn and cottonseed. These toxins are usually found together in various foods and feeds in various proportions.

Aflatoxins produce acute necrosis, cirrhosis, and carcinoma of the liver in a number of animal species; no animal species is resistant to the acute toxic effects of aflatoxins; hence it is logical to assume that humans may be similarly affected. Animal species respond differently in their susceptibility to the chronic and acute toxicity of aflatoxins. The toxicity can be influenced by environmental factors, exposure level, and duration of exposure, age, health, and nutritional status of diet. In each species, the liver is the primary target organ of acute injury. The relative susceptibility of humans to aflatoxins is not known, even though epidemiological studies in Africa and Southeast Asia, where there is a high incidence of hepatoma, have revealed an association between cancer incidence and the aflatoxin content of the diet. These studies have not proved a cause-effect relationship, but the evidence suggests an association.

One of the most important accounts of aflatoxicosis in humans occurred in more than 150 villages in adjacent districts of two neighboring states in northwest India in the fall of 1974. According to one report of this outbreak, 397 persons were affected and 108 persons died. In this outbreak, contaminated corn was the major dietary constituent, and aflatoxin levels of 0.25 to 15 mg/kg were found. The patients experienced high fever, rapid progressive jaundice, edema of the limbs, pain, vomiting, and swollen livers. One investigator reported a peculiar and very notable feature of the outbreak: the appearance of signs of disease in one village population was preceded by a similar disease in domestic dogs, which was usually fatal. Histopathological examination of humans showed extensive bile duct proliferation and periportal fibrosis of the liver together with gastrointestinal hemorrhages. A 10-year follow-up of the Indian outbreak found the survivors fully recovered with no ill effects from the experience.

A second outbreak of aflatoxicosis was reported from Kenya in 1982. There were 20 hospital admissions with a 60% mortality; daily aflatoxin intake was estimated to be at least 38 ug/kg body weight for an undetermined number of days.



# Troubled Times



## Canola Oil

---

### Canola Oil - Is It Safe? Evidence Points To *Big Trouble*

Compiled by Darleen Bradley, May 5, 1999

Canola oil from the rape seed, referred to as the Canadian oil because Canada is mainly responsible for it being marketed in the US. The Canadian government and industry paid our Federal Food and Drug Administration (FDA) \$50 million dollars to have canola oil placed on the (GRAS) List "Generally Recognized As Safe" . Thus a new industry was created. Laws were enacted affecting international trade, commerce, and traditional diets. Studies with lab. animals were disastrous. Rats developed fatty degeneration of heart, kidney, adrenals, and thyroid gland. When canola oil was withdrawn from their diets, the deposits dissolved but scar tissue remained on all vital organs. No studies on humans were made before money was spent to promote Canola oil in the US.

Adrenoleukodystrophy (ALD) is a rare fatal degenerative disease caused by in a build up long-chain fatty acids (c22 to c28) which destroys the myelin (protective sheath )of the nerves. Canola oil is a very long chain fatty acid oil (c22). Those who will defend canola oil say that the Chinese and Indians have used it for centuries with no effect, however it was in an unrefined form.\* My cholesterol level was 150. After a year using Canola oil I tested 260. I switched back to pure olive oil and it has taken 5 years to get it down to 160. Thus began this project to find answers since most doctors will say that Canola oil is OK.

My sister spilled Canola oil on a piece of fabric, after 5 pre-treatings and harsh washings, the oil spot still showed. She stopped using Canola oil ,wondering what it did to our insides if it could not be removed from cloth easily. Our Father bred birds, always checking labels to insure there was no rape seed in their food. He said, "The birds will eat it, but they do not live very long." A friend who worked for only 9 mo. as a quality control taster, at an apple-chip factory where Canola oil was used exclusively for frying, developed numerous health problems including loose teeth; gum disease, gum and nail beds turned gray; numb hands and feet with cramps, swollen arms and legs upon rising in the morning; extreme joint pain especially in hands; cloudy vision; constipation with stools like black marbles; hearing loss; skin tears from being bumped; lack of energy; hair loss; and heart pains. It has been five years since she has worked there and still has some joint pain, gum disease, and numbness. A fellow worker, about 30 years. old who ate very little product, had a routine check up and found that his blood vessels were like those of an 80 year old man. Two employees fed the waste product to baby calves and their hair fell out. After removing the fried apple chips from the diet their hair grew back in.

\* taken from *Fats that Heal and Fats that Kill* by Udo Erasmus.





# Troubled Times



## Histamine

---

### FDA's Bad Bug Book

Scombroid poisoning is caused by the ingestion of foods that contain high levels of histamine and possibly other vasoactive amines and compounds. Histamine and other amines are formed by the growth of certain bacteria and the subsequent action of their decarboxylase enzymes on histidine and other amino acids in food, either during the production of a product such as Swiss cheese or by spoilage of foods such as fishery products, particularly tuna or mahi mahi. However, any food that contains the appropriate amino acids and is subjected to certain bacterial contamination and growth may lead to scombroid poisoning when ingested.

Initial symptoms may include a tingling or burning sensation in the mouth, a rash on the upper body and a drop in blood pressure. Frequently, headaches and itching of the skin are encountered. The symptoms may progress to nausea, vomiting, and diarrhea and may require hospitalization, particularly in the case of elderly or impaired patients. The onset of intoxication symptoms is rapid, ranging from immediate to 30 minutes. The duration of the illness is usually 3 hours, but may last several days.

Fishery products that have been implicated in scombroid poisoning include the tunas (e.g., skipjack and yellowfin), mahi mahi, bluefish, sardines, mackerel, amberjack, and abalone. Many other products also have caused the toxic effects. The primary cheese involved in intoxications has been Swiss cheese. The toxin forms in a food when certain bacteria are present and time and temperature permit their growth. Distribution of the toxin within an individual fish fillet or between cans in a case lot can be uneven, with some sections of a product causing illnesses and others not. Neither cooking, canning, or freezing reduces the toxic effect. Common sensory examination by the consumer cannot ensure the absence or presence of the toxin. Chemical testing is the only reliable test for evaluation of a product.



# Troubled Times



## Mushrooms

---

### FDA's Bad Bug Book

Mushroom poisoning is caused by the consumption of raw or cooked fruiting bodies (mushrooms, toadstools) of a number of species of higher fungi. The term toadstool (from the German Todesstuhl, death's stool) is commonly given to poisonous mushrooms, but for individuals who are not experts in mushroom identification there are generally no easily recognizable differences between poisonous and nonpoisonous species. Old wives' tales notwithstanding, there is no general rule of thumb for distinguishing edible mushrooms and poisonous toadstools.

The toxins involved in mushroom poisoning are produced naturally by the fungi themselves, and each individual specimen of a toxic species should be considered equally poisonous. Most mushrooms that cause human poisoning cannot be made nontoxic by cooking, canning, freezing, or any other means of processing. Thus, the only way to avoid poisoning is to avoid consumption of the toxic species.

There are four categories of mushroom toxins: protoplasmic poisons (poisons that result in generalized destruction of cells, followed by organ failure); neurotoxins (compounds that cause neurological symptoms such as profuse sweating, coma, convulsions, hallucinations, excitement, depression, spastic colon); gastrointestinal irritants (compounds that produce rapid, transient nausea, vomiting, abdominal cramping, and diarrhea); and disulfiram-like toxins. Mushrooms in this last category are generally nontoxic and produce no symptoms unless alcohol is consumed within 72 hours after eating them, in which case a short-lived acute toxic syndrome is produced.

Several mushroom species, including the Death Cap or Destroying Angel (*Amanita phalloides*, *A. virosa*), the Fool's Mushroom (*A. verna*) and several of their relatives, along with the Autumn Skullcap (*Galerina autumnalis*) and some of its relatives, produce a family of cyclic octapeptides called amanitins. Poisoning by the amanitins is characterized by a long latent period (range 6-48 hours, average 6-15 hours) during which the patient shows no symptoms. Symptoms appear at the end of the latent period in the form of sudden, severe seizures of abdominal pain, persistent vomiting and watery diarrhea, extreme thirst, and lack of urine production. If this early phase is survived, the patient may appear to recover for a short time, but this period will generally be followed by a rapid and severe loss of strength, prostration, and pain-caused restlessness. Death in 50-90% of the cases from progressive and irreversible liver, kidney, cardiac, and skeletal muscle damage may follow within 48 hours (large dose), but the disease more typically lasts 6 to 8 days in adults and 4 to 6 days in children. Two or three days after the onset of the later phase, jaundice, cyanosis, and coldness of the skin occur. Death usually follows a period of coma and occasionally convulsions. If recovery occurs, it generally requires at least a month and is accompanied by enlargement of the liver. Autopsy will usually reveal fatty degeneration and necrosis of the liver and kidney.

Certain species of False Morel (*Gyromitra esculenta* and *G. gigas*) contain the protoplasmic poison gyromitrin, a volatile hydrazine derivative. Poisoning by this toxin superficially resembles *Amanita* poisoning but is less severe. There is generally a latent period of 6 - 10 hours after ingestion during which no symptoms are evident, followed by sudden onset of abdominal discomfort (a feeling of fullness), severe headache, vomiting, and sometimes diarrhea. The toxin affects primarily the liver, but there are additional disturbances to blood cells and the central nervous system. The mortality rate is relatively low (2-4%).

Poisonings with symptoms almost identical to those produced by Gyromitra have also been reported after ingestion of the Early False Morel (*Verpa bohemica*). The toxin is presumed to be related to gyromitrin but has not yet been identified.

The final type of protoplasmic poisoning is caused by the Sorrel Webcap mushroom (*Cortinarius orellanus*) and some of its relatives. This mushroom produces orellanine, which causes a type of poisoning characterized by an extremely long asymptomatic latent period of 3 to 14 days. An intense, burning thirst (polydipsia) and excessive urination (polyuria) are the first symptoms. This may be followed by nausea, headache, muscular pains, chills, spasms, and loss of consciousness. In severe cases, severe renal tubular necrosis and kidney failure may result in death (15%) several weeks after the poisoning. Fatty degeneration of the liver and severe inflammatory changes in the intestine accompany the renal damage, and recovery in less severe cases may require several months.



# Troubled Times



## Toxic

Here is a list of poisonous plants. It must be understood that different parts of plants may not be poisonous, but one must be careful and study well. There is a herbal medicine book one can buy called *Herbally Yours* by Penny C. Royall that is helpful for knowing which parts to use safely. Below is a list of toxic plants that was printed in a hospital newspaper that was sent to me.

aneome	holly berries	marcissus
angel trumpet tree	horsetail reed	nightshade
apricot (kernels)	hyacinth	oleander
arrowhead	hydarnea	periwinkle
avacado (leaves)	iris	peyote
azaleas	ivy (certain varieties)	philadendron
betel nut palm	jack in the pulpit	poison hemlock
bittersweet	jerquirity bean or pea	poison oak
buckeye	jeruaslem cherry	poppy (except California)
buttercups	jessamine	pokeweek
caladium	jimson weed (thorn apple)	potatoe sprouts
calla lily	jonquil	primrose
castor bean	lantana camara (red sage)	ranuculus
cherries (wild and cultivated)	larkspur	rhododendron
crocus (autumn)	laurels	rhubarb (blade)
daffadil	lilly of the valley	rosary pea
daphne	lobelia	star of bethlehem
delphinium	marijuana	sweet pea flower
devils ivy	mayapple	tobacco
dieffenbachia (dumb cake)	mistletoe	tomato (vines)
elderberry	moonseed	tulip
elephant ear	monkshood	water hemlock
english ivy	morning glory	wisteria
four o'clock	mushroom	yew
foxglove		

Offered by [Kristy](#).



# Troubled Times



## Non-Toxic

Here is a list of non-poisonous plants. It must be understood that different parts of plants may not be poisonous, but one must be careful and study well. There is a herbal medicine book one can buy called *Herbally Yours* by Penny C. Royall that is helpful for knowing which parts to use safely. Below is a list of non-toxic plants that was printed in a hospital newspaper that was sent to me.

abelia	corn plant	monkey plant
abyssian sword lily	crab apples	norfolk island pine
african daisy	creeping myrtle	peperomia
african palm	creeping jennie	petunia
african violet	dahlia	poinsetta
airplane plant	daisies	prayerplant
aluminum plant	dandelion	purple passion
aralia	dogwood	pyocantha
arucaria	donkey tail	petunia
asparagus fern (dermatitis)	dracaena	poinsetta
aspidistra (cast iron plant)	easter lily	prayerplant
aster	echeveria	purple passion
baby's tears	eucalyptus (caution)	pyocantha
bachelor buttons	eugenia	rose
bamboo	gardenia	sansevieria
begonia	grape ivy	schefflera
bird's nest fern	hedge apples	sensitive plant
blood leaf plant	hens and chicks	spider plant
boston ferns	honeysuckle	swedish ivy
bougainvillea	hoya	umbrella plant
cactus (certain varieties)	jade plant	violets
California holly	kalanchoe	wandering jew
California poppy	lily (day,easter,or tiger)	weeping fig
camellia	lipstick plant	weeping willow
christmas cactus	magnolia	wild onion
coleus species	marigold	zebra plant

Offered by [Kristy](#).



# Troubled Times



## Red Tide

---

### Sarasota Marine Lab

Red tides occur throughout the world, drastically affecting Scandinavian and Japanese fisheries, Caribbean and South Pacific reef fishes, and shellfishing along U.S. coasts. Most recently, it has been implicated in the deaths of hundreds of whales, dolphins, and manatees in North American waters.

These red tides are caused by several species of marine phytoplankton, microscopic plant-like cells that produce potent chemical toxins. Red tide is the result of a massive multiplication (or bloom) of tiny, single-celled algae called *Gymnodinium breve*, usually found in warm saltwater, but which can exist at lower temperatures. Some red tides have covered up to several hundred square miles of water.

*G. breve* produces potent neurotoxins. Filter-feeding shellfish, such as oysters, clams, mussels and other bivalve mollusks, that consume *G. breve* concentrate the toxin in various organs. Whereas red tide toxins are deadly to finfish, shellfish are unaffected. Shrimp, Crab, Scallops and Lobsters in red tides are *safe* to harvest and eat, since these shellfish do not accumulate the red tide toxin in the meaty or hard muscle tissue which we normally consume.

It is *not* a good idea to eat liver, organs, or other soft tissue of shellfish. The muscle or hard meat of freshly caught finfish in red tides are *safe* to eat, provided the fish behave normally. Although no evidence of harmful effects in humans from contaminated fish have been reported, it is *not* a good idea to eat liver, organs or other soft tissues. Oysters, Clams, Mussels, Mollusks, Whelks are *unsafe* to harvest and eat since they may accumulate red tide toxins in their tissues.



# Troubled Times



## Ciguatera

---

### FDA's Bad Bug Book

Ciguatera is a form of human poisoning caused by the consumption of subtropical and tropical marine finfish which have accumulated naturally occurring toxins through their diet. The toxins are known to originate from several dinoflagellate (algae) species that are common to ciguatera endemic regions in the lower latitudes.

Initial signs of poisoning occur within six hours after consumption of toxic fish and include perioral numbness and tingling (paresthesia), which may spread to the extremities, nausea, vomiting, and diarrhea. Neurological signs include intensified paresthesia, arthralgia, myalgia, headache, temperature sensory reversal and acute sensitivity to temperature extremes, vertigo, and muscular weakness to the point of prostration. Cardiovascular signs include arrhythmia, bradycardia or tachycardia, and reduced blood pressure.

Ciguatera poisoning is usually self-limiting, and signs of poisoning often subside within several days from onset. However, in severe cases the neurological symptoms are known to persist from weeks to months. In a few isolated cases neurological symptoms have persisted for several years, and in other cases recovered patients have experienced recurrence of neurological symptoms months to years after recovery. Such relapses are most often associated with changes in dietary habits or with consumption of alcohol. There is a low incidence of death resulting from respiratory and cardiovascular failure.



# Troubled Times



## Mussels

---

Some mussels even create an alkaloid substance themselves, which is toxic to us.

Offered by [Jeroen](#).

Even under circumstances of present-day resources some people sometimes die as a result of eating toxic clams, oysters, etc.

Offered by [Granville](#).





# Troubled Times



## Shellfish

### FDA's Bad Bug Book

The 20 toxins responsible for paralytic shellfish poisonings (PSP) are all derivatives of saxitoxin. Diarrhetic shellfish poisoning (DSP) is presumably caused by a group of high molecular weight polyethers, including okadaic acid, the dinophysins, the pectenotoxins, and yessotoxin. Neurotoxic shellfish poisoning (NSP) is the result of exposure to a group of polyethers called brevetoxins. Amnesic shellfish poisoning (ASP) is caused by the unusual amino acid, domoic acid, as the contaminant of shellfish.

Ingestion of contaminated shellfish results in a wide variety of symptoms, depending upon the toxins(s) present, their concentrations in the shellfish and the amount of contaminated shellfish consumed. In the case of PSP, the effects are predominantly neurological and include tingling, burning, numbness, drowsiness, incoherent speech, and respiratory paralysis. Less well characterized are the symptoms associated with DSP, NSP, and ASP. DSP is primarily observed as a generally mild gastrointestinal disorder, i.e., nausea, vomiting, diarrhea, and abdominal pain accompanied by chills, headache, and fever. Both gastrointestinal and neurological symptoms characterize NSP, including tingling and numbness of lips, tongue, and throat, muscular aches, dizziness, reversal of the sensations of hot and cold, diarrhea, and vomiting. ASP is characterized by gastrointestinal disorders (vomiting, diarrhea, abdominal pain) and neurological problems (confusion, memory loss, disorientation, seizure, coma).

PSP Symptoms of the disease develop fairly rapidly, within 0.5 to 2 hours after ingestion of the shellfish, depending on the amount of toxin consumed. In severe cases respiratory paralysis is common, and death may occur if respiratory support is not provided. When such support is applied within 12 hours of exposure, recovery usually is complete, with no lasting side effects. In unusual cases, because of the weak hypotensive action of the toxin, death may occur from cardiovascular collapse despite respiratory support.

PSP is associated with relatively few outbreaks, most likely because of the strong control programs in the United States that prevent human exposure to toxic shellfish. That PSP can be a serious public health problem, however, was demonstrated in Guatemala, where an outbreak of 187 cases with 26 deaths, recorded in 1987, resulted from ingestion of a clam soup. The outbreak led to the establishment of a control program over shellfish harvested in Guatemala. The mouse bioassay has historically been the most universally applied technique for examining shellfish (especially for PSP).

ASP first came to the attention of public health authorities in 1987 when 156 cases of acute intoxication occurred as a result of ingestion of cultured blue mussels (*Mytilus edulis*) harvested off Prince Edward Island, in eastern Canada; 22 individuals were hospitalized and three elderly patients eventually died.



# Troubled Times



## Pufferfish

### FDA's Bad Bug Book

Fish poisoning by consumption of members of the order Tetraodontiformes is one of the most violent intoxications from marine species. The gonads, liver, intestines, and skin of pufferfish can contain levels of tetrodotoxin sufficient to produce rapid and violent death. The flesh of many pufferfish may not usually be dangerously toxic. Tetrodotoxin has also been isolated from widely differing animal species, including the California newt, parrotfish, frogs of the genus *Atelopus*, the blue-ringed octopus, starfish, angelfish, and xanthid crabs. The metabolic source of tetrodotoxin is uncertain. No algal source has been identified, and until recently tetrodotoxin was assumed to be a metabolic product of the host.

However, recent reports of the production of tetrodotoxin/anhydrotetrodotoxin by several bacterial species, including strains of the family Vibrionaceae, *Pseudomonas* sp., and *Photobacterium phosphoreum*, point toward a bacterial origin of this family of toxins. These are relatively common marine bacteria that are often associated with marine animals. If confirmed, these findings may have some significance in toxicoses that have been more directly related to these bacterial species.

The first symptom of intoxication is a slight numbness of the lips and tongue, appearing between 20 minutes to three hours after eating poisonous pufferfish. The next symptom is increasing paraesthesia in the face and extremities, which may be followed by sensations of lightness or floating. Headache, epigastric pain, nausea, diarrhea, and/or vomiting may occur. Occasionally, some reeling or difficulty in walking may occur. The second stage of the intoxication is increasing paralysis. Many victims are unable to move; even sitting may be difficult. There is increasing respiratory distress. Speech is affected, and the victim usually exhibits dyspnea, cyanosis, and hypotension. Paralysis increases and convulsions, mental impairment, and cardiac arrhythmia may occur. The victim, although completely paralyzed, may be conscious and in some cases completely lucid until shortly before death. Death usually occurs within 4 to 6 hours, with a known range of about 20 minutes to 8 hours.

From 1974 through 1983 there were 646 reported cases of pufferfish poisoning in Japan, with 179 fatalities. Estimates as high as 200 cases per year with mortality approaching 50% have been reported. Only a few cases have been reported in the United States, and outbreaks in countries outside the Indo-Pacific area are rare. The mouse bioassay developed for paralytic shellfish poisoning (PSP) can be used to monitor tetrodotoxin in pufferfish and is the current method of choice. Pufferfish poisoning is a continuing problem in Japan, affecting 30 - 100 persons/year. Most of these poisoning episodes occur from home preparation and consumption and not from commercial sources of the pufferfish. Three deaths were reported in Italy in 1977 following the consumption of frozen pufferfish imported from Taiwan and mislabelled as angler fish.



# Troubled Times



## Inner City

---

Excerpts from an article in *The Associated Press* by Paisley Dodds

PERRYVILLE, Ark. (Aug. 19) - No overalls or straw hats in this crowd. Fresh from Chicago's Cabrini Green housing complex and another development in Milwaukee, a dozen kids are visiting Arkansas to learn how to become inner-city farmers. Growing cucumbers may keep 16-year-old Helen Marshbanks from joining a gang. Raising catfish under an apartment window sill may put more food on the table for the family of 14-year-old Darius Moore. For 19-year-old Eric Brown, urban farming is a "cool" complement to playing basketball and watching television. "I want to be a writer when I grow up," Brown said. "But this thing, yea, it's been real cool." "For me, doing these kinds of projects has kept me out of trouble and out of gangs that are in my neighborhood," Marshbanks said Monday.

All are at a four-day, inner-city farming seminar at the Heifer International Project, an international grassroots organization. The seminar, held on Heifer's 1,100-acre ranch in central Arkansas, provides some of the budding farmers their first time out of the city. They stay at the "Heifer Hilton" - a barn that sleeps about two dozen. For many here, growing things isn't new. Marshbanks is already involved in one of Chicago's inner-city gardening projects, where community members grow vegetables, then sell them to restaurants. The seminar aims to show how to boost inner-city crops and expand into rooftop beekeeping, catfish harvesting, worm composting, goat-cheese making and organic farming.

The crops and produce can feed a family or be sold for cash, said Rex Enoch, global education manager for Heifer International. "Even if these kids don't end up becoming farmers, these projects can help a family who doesn't have a lot of money for food, and it also gives them something to do," says Jonathon Woods, an aquaculture trainer from Toronto. "Two essential things needed for these projects to work is a desperation for food and accessibility of land - two things quite common in American cities," he said. The idea is a step beyond community gardens, common in Chicago and most other North American cities, to urban farms. Europe already has about 850 of them, Enoch said.

One day is devoted to learning to harvest fish - catfish and trout work best in an apartment environment, with barrels serving as tanks. Composting techniques use earthworms and kitchen scraps to produce fertilizer. Another technique is how to make cheese from goat's milk - a simple process of heating the milk, separating the curds from the whey, then wrapping the product in cheese cloth. "We feel really good about doing this," Moore said. "There are a lot of people who can't afford things in our neighborhood. I think when people see what we're doing, they'll want to get involved too." Learning professional techniques could help the gardening projects already running and encourage donors to keep them afloat, Marshbanks said. "We can see what a difference it's made in our neighborhood," she said. "It makes people happy."

AP-NY-08-19-97 0734EDT Copyright 1997 *The Associated Press*. The information contained in the AP news report may not be published, broadcast, rewritten or otherwise distributed without the prior written authority of *The Associated Press*.





# Troubled Times

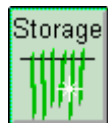

## Basics

---

Food preservation is one of the most important aspects of survival. Do what the natives did all over the world:

Smoking,  
Air Drying, or  
Freezing.

Offered by [Chris](#).



Home > Science > Innovation > Edible Innovations

# How Food Preservation Works

by Marshall Brain

Print | Cite | Feedback | Share | Tweet

### Inside this Article

1. Introduction to How Food Preservation Works
2. Refrigeration and Freezing
3. Canning Food
4. Dehydrating Food
5. Freeze-Drying
6. Salting and Pickling
7. See more »

What do you know about salt?



Take the Quiz »

## VIDEO FAVORITES



- Robot Videos
- Extreme Engineering Videos
- 10 Ways The World Will End Videos
- Space Station Videos

### Food Pyramid Image Gallery



Find out what's being done to your food to make it last longer. See more [food pyramid pictures](#).

### FOOD SCIENCE

- [5 Tips for Keeping Vegetables Fresh](#)
- [How Freeze-Drying Works](#)
- [PlanetGreen.com: Build a Solar Food Dehydrator](#)

Because food is so important to survival, food preservation is one of the oldest technologies used by human beings. In this article, we'll look at all of the different preservation techniques commonly used today, including:

- Refrigeration and freezing
- Canning
- Irradiation
- Dehydration
- Freeze-drying
- Salting
- Pickling
- Pasteurizing
- Fermentation
- Carbonation
- Cheese-making
- Chemical preservation

The basic idea behind all forms of food preservation is either:

- To slow down the activity of disease-causing bacteria
- To kill the bacteria altogether

In certain cases, a preservation technique may also destroy enzymes naturally found in a food that cause it to spoil or discolor quickly. An enzyme is a special protein that acts as a catalyst for a chemical reaction, and enzymes are fairly fragile. By increasing the temperature of food to about 150 degrees Fahrenheit (66 degrees Celsius), enzymes are destroyed.

## GREEN HOMES



- [10 Cutting-edge Building Materials](#)
- [Quiz: Green Your Home on a Budget](#)
- [Top 10 Green Tools](#)
- [10 Technologies Used in Green Construction](#)
- [More Green Construction»](#)

Shop DVDs, Gear & More!



A food that is sterile contains no bacteria. Unless sterilized and sealed, all food contains bacteria. For example, bacteria naturally living in milk will spoil the milk in two or three hours if the milk is left out on the kitchen counter at room temperature. By putting the milk in the refrigerator you don't eliminate the bacteria already there, but you do slow down the bacteria enough that the milk will stay fresh for a week or two.

Let's look at all of the different forms of food preservation in detail.

More [Videos Online](#)

Ads by Google

[Food Handler Card \\$14.95](#)  
ANSI Recognized CA Food Handler Certificate.  
Online Training.  
[www.mindleaders.com](http://www.mindleaders.com)

[Herba Healer Academy](#)  
25 year storage food, free samples Be prepared for anything!  
[www.herbalhealer.com/gofoods.html](http://www.herbalhealer.com/gofoods.html)

[Freeze-Dried Food](#)  
Save to 20% off. Up to 25 Yr. SL. Low Prices . Buy Here!  
[www.nitro-pak.com/Freeze-Dried](http://www.nitro-pak.com/Freeze-Dried)

[Next Page](#) ▶

Ads by Google

[Emergency Food](#)  
20+ Years Shelf Life. Great Variety Free shipping on most products  
[www.survival-supply.com](http://www.survival-supply.com)

[Courses in Freeze Drying](#)  
Science, practice and engineering Industry-experienced instructors  
[www.biopharma.co.uk](http://www.biopharma.co.uk)

[D 5 food dehydrator](#)  
100% stainless steel dehydrators All sizes, home & commercial models  
[www.HarvestEssentials.com](http://www.HarvestEssentials.com)

## MORE TO EXPLORE

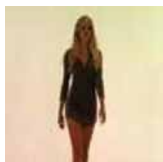

[Science of Sex Appeal: A Sexy](#)



[How long can you go without](#)



[How to Detect if Someone's](#)



[The Look of Love: Top 5](#)



[10 Myths About Video Games](#)

## RELATED CONTENT

Walk

food and water?

Stealing Your WiFi

Physical Signs of Attraction



Why are there dozens of dead animals floating in space?

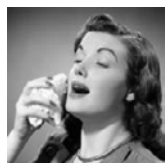

What happens in the brain during an orgasm?



How the Dyson Bladeless Fan Works



10 Cool Things You Didn't Know About Stephen Hawking



What are the five most prevalent forms of torture and why?

Powered by Vertical Acuity



## ALL THINGS SCIENCE



10 Incredible Wind Power Facts



10 Remarkable Exoplanets



Fact or Fiction: Earthquake Quiz



Top 10 Things That Women Invented



Strange, Spooky, Scary: The Supernatural Quiz

[Watch 100 Greatest Discoveries videos »](#)

## YOU MIGHT ALSO LIKE

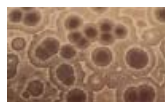

**What's this white stuff on my chocolate?**  
You're about to bite into a luscious chunk of chocolate when you notice its pale, spotty appearance. What's that white stuff -- and is your sweet treat a goner?



**5 Strange Items Developed from NASA Technology**  
Many commercial products based on NASA research are a part of our everyday lives. Some things, however, are more unusual than others. Check out our list of five strange items developed from NASA technology.

### Popular Articles

[How to Make a Battery Powered Light Bulb](#)

[Do backscatter X-ray systems pose a risk to frequent fliers?](#)

[How are Crayons and markers made?](#)

### Related Ad Categories

[Food Idea](#)

[Food Storage](#)

[Recipes Food](#)

### Inside this Article

1. Introduction to How Food Preservation Works
2. Refrigeration and Freezing
3. Canning Food
4. Dehydrating Food
5. Freeze-Drying
6. Salting and Pickling
7. Pasteurizing, Fermenting, Carbonating
8. Cheese Making
9. Chemical Food Preservation
10. Food Irradiation
11. Lots More Information
12. See all Edible Innovations articles

[Next Page ▶](#)

Prices: Food Preservation Books



### Unit Operations in Food Engineering (Food Preservation Technology)

In order to successfully produce food products with maximum quality, each stage of processing must be well-designed. Unit Operations in Food Engineering systematically presents the basic information necessary to design food processes and the equipment needed to carry them out. It covers the most common food engineering unit operations in detail, including guidance for carrying out specific design calculations. Initial chapters present transport phenomena basics for momentum, mass, and energy transfer in different unit operations. Later chapters present detailed unit operation descriptions based on fluid transport and heat and mass transfer. Every chapter concludes with a series of solved problems as examples of applied theory.

\$187.17

[GO](#)



### Handbook of Vegetable Preservation and Processing (Food Science and Technology)

Representing the vanguard in the field with research from more than 35 international experts spanning governmental, industrial, and academic sectors, the Handbook of Vegetable Preservation and Processing compiles the latest science and technology in the processing and preservation of vegetables and vegetable products. This reference serves as the only guide to compile key tools used in the United States to safeguard and protect the quality of fresh and processed vegetables. A vast and contemporary source, it considers recent issues in vegetable processing safety such as modified atmosphere packaging, macroanalytical methods, and new technologies in microbial inactivation.

\$279.95

[GO](#)

[Food Identity Preservation and Traceability: Safer Grains](#)





A Practical Roadmap to IPT Integration From baby formula and peanut butter, to E. coli-tainted peppers and salmonella-tainted pistachios, no food product or means of its production is immune to risks. And while these risks may never be fully eliminated, identity preservation and traceability (IPT) systems make it easier to determine the source and extent of contamination, thereby reducing the often deadly consequences. With a core emphasis on grain, this encyclopedic reference documents the state-of-the-science throughout the entire food chain in both domestic and international markets as it relates to food safety and economics. The book provides a cohesive introduction to IPT systems and summarizes the programs currently available, in effect developing a conceptual model of IPT at the producer level. Addresses the History, Theory, and Design Components Beginning with an informative history of IPT, the book continues with examples of IPT programs and standards of official seed organizations. It then provides a sampling of government, industry, and company approaches toward IPT systems throughout the past two decades. For ease of use as a reference, most chapters begin with a brief description of the essentials necessary to understand the chapter's contents allowing readers to jump right in, rather than having to read chapters in sequential order. Providing an in-depth understanding of the complexity of IPT systems, the rules they function under, and how they are shaped and modified, this valuable resource effectively demonstrates why IPT is a critical practice for food safety.

\$99.94

GO

HOWSTUFFWORKS

[Adventure](#)  
[Auto](#)  
[Culture](#)  
[Entertainment](#)

MORE STUFF

[Blogs](#)  
[Games](#)  
[HSW Tools](#)  
[RSS](#)

OUR WEBSITES

[Animal Planet](#)  
[Consumer Guide Auto](#)  
[Consumer Guide Products](#)  
[Discovery Channel](#)

CUSTOMER SERVICE

[Advertising](#)  
[Contact Us](#)  
[Help](#)

TAKE US WITH YOU

[Health](#)  
[Home & Garden](#)  
[Lifestyle](#)  
[Money](#)  
[Science](#)  
[Tech](#)

[Maps](#)  
[Podcasts](#)  
[Quizzes](#)  
[Newsletters](#)  
[Video](#)

[Discovery Fit & Health](#)  
[HSW Brazil](#)  
[HSW China 博闻网](#)  
[Investigation Discovery](#)  
[Oprah Winfrey Network](#)  
[Planet Green](#)  
[Science Channel](#)  
[TLC](#)  
[Discovery Education](#)  
[Store](#)

**CORPORATE**  
[About Us](#)  
[Careers @ Discovery](#)  
[Privacy Policy](#)  
[Visitor Agreement](#)



**FOLLOW US**



© 1998-2012 HowStuffWorks, Inc

# Troubled Times



## Pros and Cons

---

**Salted** foods can preserve meats for a long time. Salted foods, if consumed on a regular basis (over years), however, also have a well documented reputation for causing cancers, especially stomach cancers. The traditional Japanese diet was high in salted fish (not as much today). The Japanese also had one of the highest rates of stomach cancers compared to other forms of cancer. **Pickled** foods also have a cancer-connected reputation.

Chemical Preservatives are not health promoting and cause a wide array of problems, from allergies to cancers (e.g. **Nitrites**).

**Irradiation** of food gives it an indefinite shelf life, which is wonderful for the food manufacturers, but not so great for you. The irradiation scrambles the DNA of the food, breaking gene links and all kinds of sensitive bond structures. After ingesting it, your body no longer recognizes it as normal food, the way it came from Nature. Rather, It reacts to it as a foreign, un-natural substance (e.g. subtle allergic reactions), which is exactly what it is.

It's probably unnecessary to say this, but the only type of alcohol that should be used for any form of food preservation is **grain alcohol** (ethanol). 100 proof Vodka, is 50% grain alcohol. I use it for a preservative and sterilizer all the time.

Don't forget about using **Colloidal Silver**. It's a powerful germicide. It can be useful for preservation purposes, e.g. Right after cooking hard boiled eggs, soak them for 30-45 minutes in a solution of colloidal silver. The silver will migrate through the shell. Take them on a long road trip or camping without any worries of refrigeration. I once experimented by cooking 6 hard boiled eggs. I preserved 3 of them with CS and left the other 3 untouched. I put all six of them out in the sun for 3 weeks. The regular eggs were totally black and foul smelling when cracked open. The CS preserved eggs, lost about 30% of their moisture, but otherwise, looked and smelled sweet as can be. Try it yourself!

Offered by [Ed](#)



# Troubled Times



## Smoking

One of [Prices'](#) observations was that the shortest life spans always accompanied the most vegetarian continent. Certainly one of the features that has helped us hominids survive all sorts of environmental challenges has been our ability to live on whatever is available. Vegetables, though messy, present little challenge to most of us, but the hands on traditions of thousands of years ago regarding meat have been fairly lost among most of us civilized folks. People who study fossilized dung report that our cave people ancestors ate bones, fur and all whenever the opportunity presented itself. Weston Price reports that some native tribes let the dogs eat the muscle meat of a large kill first, while the tribe went first for the organs, fat and marrow. Only then did they compete with the dogs for the less nutritious muscle meat.

Meat spoils quickly, but in ages past nearly every human on earth knew first hand how to preserve it. When introduced to Wallace Black Elk a few years ago I desperately searched my brain cells for something we might find to talk about. To him I was probably just another Caucasian, perhaps with a strange aura if anything of interest. I got an idea though. "Say", I began, "on the reservation when you made jerky from deer or elk, did you cut off the fat first"? Wow, did I have his attention! He began shaking his head to say no. "I read on the internet that people always trim off the fat. How do you keep the jerky from going rancid"? I really lucked out with this question, and I still am grateful today. "Ah, rancid", his grammar was not the kings English but it was music to my ears, "is caused by bacteria. Smoke kills bacteria. Ash, hickory, maple, and oak. Those trees are the ones you use. You smoke the jerky, and the smoke kills the bacteria. The fat does not go rancid." Wow did I thank him.

It does not matter to me that rancidity is actually an oxidative reaction and does not depend on the presence of bacteria. Modern sources say it is the phenols in the smoke that get into the fat that prevents oxidation. I bought a big smoker that week, and have never trimmed the fat off my jerky since. I have stuff two years old in zip lock bags that show no sign of spoilage. Smoke. Think about it. I imagine that the typical situation is someone with a small fire with forked twigs holding up other little branches with strips of meat hanging around the fire. Although I have not done it, I can easily imagine the smoke blowing in all directions if the wind is light. Certainly my clothes pick up the odor of smoke very easily when I visit a bar or attend a campout, and help me imagine how quickly meat can pick up the chemical assist.

Offered by [Steve](#).

You are on a good track about smoking your meat. I also do this every chance I get as I prefer wild meat rather than the store bought stuff. Although I do not make the jerky, I completely dry my meat after I trim off all of the fat. I then in turn slowly melt the fat after I cut it into 1" cubes rendering it into tallow out of which I use with other meats that are too lean to survive on as in squirrels and rabbits. I have found that by drying it completely it has a shelf life of 4 to 6 years, and the tallow can last up to 3 in the right conditions. The woods you listed are very good for smoking your meats, I have also found that cotton wood (if you have it around) works well for this too as many insects do not like it. I live in Alaska so I have an abundant supply of cotton wood.

Offered by [Matt](#).



# Troubled Times



## Drying Techniques

---

Dried foods must be stored in a special reserved storage facility, be this as small as a cupboard or as large as a farm-silo. The storage facility must have a fixed temperature of 15 degrees Celsius all year round and a relative humidity of 60%. Because many dried foods can get invested by parasites the storage facility must be extremely clean, and dried foods must be checked periodically in order to prevent parasite infestations or even outbreaks of parasites. Use watertight packaging-material/products if the storage facility isn't dry and isn't at a fixed temperature all year round. So adapt the packaging to the environment of storage. The storage facility should be a well-ventilated space. Put dried foods in large bottles and preserving-jars with preferably a cork as shutter, or use a screwing lid *with* a rubber ring. When a food product has just been dried then immediately put it in the bottles and or preserving-jars under the driest and coldest of circumstances available and shut the lid on as soon as possible.

### Fruit

To dry fruit after the cataclysms without the sun can be done easily and best by using an infra red lamp. The fruit to be dried should be laid in small portions on gauze, spanned when needed by a wooden frame so the air can circulate above and under, in a well-ventilated space under the light of an infra red lamp. The benefit of using an infra red lamp over sunlight is that under the influence of the infra red light more nutrients are preserved than when dried under sunlight.

### Vegetables in general

Infra red light shouldn't be used with vegetables, it will dry them out too quickly. Vegetables are normally dried using just the dry air ventilating around the food. Some vegetables are dried by raising the temperature around them up to 60 to 70 degrees Celsius. In a oven this can be reached easily, or in a pot above a small fire, or in a small room where a fire causes the temperature to rise. Turn the vegetables around once in a while to prevent them drying out too rapidly. Never dry vegetables in the sun.

### For the leaves of carrot-related vegetables (parsley, celery etc.)

The leaves of these type of plant can be preserved very well for a long time. Remove withered leaves. Dry outdoors in nice sunny weather or in a space with a temperature of 50 degrees Celsius. When the leaves are dry, make a powder of them. Put in tightly shut jars.

### For carrot-related vegetables (parsley, celery etc.)

Clean the roots of debris well, then wash them. Then cut them in slices and dry in a temperature between 65 and 70 degrees Celsius. For 1 kilo of carrot-related vegetables there should be approximately 140 grams of dried vegetables.

### For Carrots

Take healthy carrots of a beautiful orange color (with as few root threads as possible). Wash them. Put them in boiling water to blanch them until they are soft. Take them out and let them cool. Then cut them in slices of 3 to 4 mm thickness. Dry them in a temperature at a maximum of 80 degrees Celsius. When blanched the precious Vitamin A will be preserved.

### Onions

Peel them, wash them and then cut them in slices of 3 to 4 mm thickness. Dry them in a temperature of 60 degrees Celsius.

### **Herbs (dragon, thyme, oregano etc.)**

When drying at temperatures too high or incorrectly preserved they will lose their aroma. Wire pieces together into a small parcel. Dry quickly! Dry them in a temperature of 50 to 55 degrees Celsius. When the leaves are touched they fall apart. Preserve them in tightly shut jars.

### **Cabbage**

Remove leaves from cabbage. Wash the leaves and remove any veins. Cut the leaves in strips and 'blanch' them for 3 minutes in boiling water. Thereafter they must be laid in cold water to cool. Pour the water off the cold leaves and dry them in a temperature of 65 to 75 degrees Celsius. Before consumption put them in water for 2 hours and then boil for 45 minutes.

### **Peas**

Preferably take sweet peas. Blanch them for 3 minutes, then cool them down then in cold water. Pour the water off the peas and dry in a temperature of 65 to 70 degrees Celsius.

### **French beans**

Preferably soft ones. Remove the tops and threads. Blanch them for 10 minutes in boiling water. Cool them down by placing in cold water, then pour off the water and dry in 65 degrees Celsius.

### **Mushrooms**

They *must* be fresh without any traces of fungus, aging or parasites! When dried they have lost a lot of their nutrients but the taste and scent will be preserved. Clean them with a knife and rub them with a dry cloth. Remove parts eaten by worms. They *must not* be washed because then drying will no longer be possible! Cut them in slices of 3 mm thickness. Then lay them on a gauze immediately. Mushrooms can be dried in the sun, in a hothouse or an oven, or a combination of these methods. In the oven never exceed a temperature of 45 degrees Celsius until the mushrooms are entirely dry on the edges, then raise the temperature slowly up to 70 degrees Celsius. It is of the utmost importance to store mushrooms in a very dry surroundings. Small mushrooms can be dried on a wire. Mushrooms are dry enough when they make a slight crunchy sound when you pinch them softly. If they are over dry they will fall apart when touched.

### **Medicinal Plants**

Use only plants well known. Dry carefully. Dry any poisonous plants separately from the non-poisonous ones. Store poisonous plants separately, in their own facility preferably. and don't allow children in the storage facility. Protect hands by wearing gloves. Dry medicinal plants at a maximum of 35 degrees Celsius. Best is to dry them using an infra red lamp, as by this method you will avoid a high temperature. Medicinal plants dried in the sun they will lose their potency. In general roots of medicinal plants are best be taken out of the ground when they haven't grown into fully leafed plants yet (early spring), then their level of medicinal nutrients is highest. Cut them after washing in cold water into strips along the length of the root. Dry at a maximum of 40 degrees Celsius. Roots are perfectly dried when parts can be broken off with some ease. Small roots can be dried as a whole.

Offered by [Michel](#).



# Troubled Times



## Foxfire Tips

---

Listed below is a synthesis from the *Foxfire* book series on how to preserve vegetables by drying. Only those vegetables that are likely to be grown after the pole shift have been listed, given the environmental conditions.

### Sweet Potatoes

Boil until done. Take off the skins and slice. Put on a white cloth and put out in the sun each day. Then stack for future use.

### Green Beans

String green beans together using a needle and thread. Hang the string by one end in the warm air, but not in direct sunlight. Let them hang until dry. Store until ready to use.

### Peas

Let ripe peas dry in the sun. Once they are completely dry, beat the hulls off with a stick. Store in a dry place until ready to use.

### Potatoes

Dig a hole one to two feet below the frost line. Put the potatoes in and cover with straw. Pack dirt in over that. Put a piece of tin over the dirt. They'll keep all winter.

### Cabbage

Dig a shallow circular trench on a sloped plot of ground. Dig a drainage ditch leading downhill and away from the circular trench. This will drain off any surface water that may accumulate and rot the cabbages. Throw dirt from the trench into the center of the circle. Cover this mound with straw. Place cabbages (root and all) so that the root of each is covered by the head of another. Then cover with dirt and straw.



# Troubled Times



## Backwoods

---

For large quantity food dehydration try this homemade gem from the past by Rev. J.D. Hooker [Issue 41](#). This article came out of a magazine that might be right up our alley, its called [Backwoods Home Magazine](#) - *practical ideas for self-reliant living, alternative energy, your homestead, and much more.*

Offered by [Ted](#).





# Troubled Times



## Jerky

---

Here are some recipes for a kind of beef jerky using moose meat. Deer meat will make a good substitute too. These recipes are good in that they require *no* refrigeration which will be a plus in the Aftertime.

Offered by [Kristy](#).

### Pemmican 1

**Ingredients:**

- 2 lb dried beef
- 1 cup raisins
- 1/2 cup yellow raisins
- Beef suet

**Instructions:**

Using a blender, mince meat to a fine pulp. Stir in raisins. Chop just enough to break up raisins. Turn into bowl and mix well. Pour melted suet over top, using only enough to hold beef and raisins together. Allow to cool slightly. Turn onto a jelly roll pan and allow to cool completely. Cut into strips and then into bars about 1" wide and 4" long. Store in ziplock bags. These bars can be stored for several months.

### Pemmican 2

**Ingredients:**

- 1 cup finely ground jerky
- 1 cup raisins or other dried fruit
- 1 cup chopped roasted nuts
- 1/3 teaspoon chile powder
- 2 tbs honey
- 4 tbs peanut
- 3 cups butter

**Instructions:**

Mix all ingredients thoroughly and press into a shallow pan. Cover with wax paper and refrigerate overnight. Cut into bars and wrap in foil. Pemmican will keep a long time but will become messy in hot weather. This is a modernized version of a food the North American Indians ate for hundreds of years.



# Troubled Times



## Biltong

One can make many foods oneself with very long life. In South Africa like much of the USA we have a good climate to dry foods such as fruit and meat. Here are some tips on drying meat. In the USA you call it jerky, but we in South Africa call it Biltong and it's like a national dish here! Biltong, Beer, Sunnyskies and Chevrolet. You can dry most meats, like beef. Ostrich is good, buck and even horse meat.

### Method:

1. Cut the meat into strips, the fillet or rump is the best. Don't make it too thick, about 1" maximum else it may go moldy. Best cut is along the grain of the meat.(better for the sealing process).
2. Wipe the meat well with vinegar, or dip it, which is better. The important thing here is to get rid of all water on the outside of the meat as this causes it to go moldy and rotten.
3. Mix the following spices: Salt (1), ground coriander (2), ground cloves (1/16). The ( ) indicate proportion. You can experiment with other spices and herbs to your taste.
4. Wipe the meat well with the mixture and Lay the meat for 24 hr. in a cool place. (The moisture from the vinegar will combine with the mixture and marinate into the meat.
5. Hang with paperclips in a cool drafty place. (This is important). Do not hang it in the sun, or in a damp place. On the farm when I was young we had a cabinet outside under the tree. The sides of the cabinet had 'windows' on all sides covered in bird mesh to keep the robbers out! If you have a fan, this is better still, as you can blow cool air through the cabinet and this reduces humidity.
6. After about 3 days the meat should be sealed on the outside and you then can continue with the drying process to a point which suits you. Some like it a little moist in the inside, others like it dry. If you have not done this before make only a small amount until you have got the process as you like it.

Offered by [Ray](#).



# Troubled Times



## Make Shift

---

I've been thinking about how we would be able to dry things without electricity and our commercial dehydrator. The design to our commercial dehydrator is very simple. It has a heating coil at the bottom and drying racks above that. Almost anything could be used for the racks. Old window screens is what I have in mind. Of course, you would want to clean them thoroughly first. Build or obtain a wooden case to hold your drying racks. I thought that an old chest of drawers might do nicely. This would give you significantly more space than my commercial dehydrator and make it convenient to check your dried goods. Knock out the bottom of your chest of drawers to allow the heat from the "heating element" to rise through your drying foodstuffs.

When we dry food we will mostly dry things in increments. We will turn it on for a while, then turn it off to allow things to cool for a while. I don't know if this is good or bad, but we burn a lot less this way. This same effect could be achieved by adding fire heated rocks to a pit dug below the chest of drawers. If you wanted to smoke things with this same set up it should be fairly easy to build a fire in the pit instead. Of course, be careful not to build too hot a fire or you'll burn your drying box. You don't really want a big or a hot fire when you're smoking things anyway. Maybe moving hot coals from your fire to the pit and then adding grass or twigs to smoke the food would work best.

Offered by [John](#).



# Troubled Times



## Light Bulb

With lots of rain there is going to be a lot of humidity. With energy scarcity, drying foods becomes a challenge. We know we will need many lights to grow our food. Some types of lights generate a lot of waste heat. Heat rises. If a 500-1000 Watt halogen light is used, a hole can be drilled in the topside so that the air circulates up throughout a conventional wood or plastic food dryer. This would be placed or build directly above and around each light. The metal parts of the top of the light will radiate lots of heat this should not be lost. One such simple dryer could be simply a big funnel over the top of each lamp feeding into a zigzag stair step box that is say 2-3 ft high and 1 ft square. Front side opens to put the items in. See the following figure for ideas.

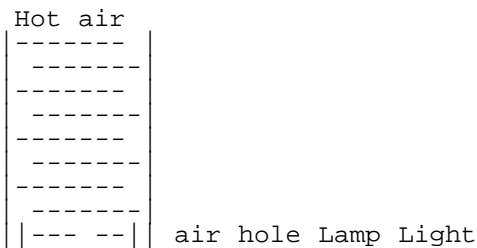

Enzymes begin to die off at about 118-180 degrees Fahrenheit as best I can recall. It would be a good idea when building this to stick a thermometer in this unit near the inlet and where the air comes out to adjust the air flow volume by the size of hole in the bottom, until the temperature comes out to be below say about 118 degrees or whatever our experts on this subject say. It may be that some foods are OK to dry at hotter temperatures.

Offered by [Mike](#).



# Troubled Times



## Winnowed Clean

Copyright 1997 [Alan T. Hagan](#). All rights reserved.

Republished in part by express permission. Please note [Disclaimer](#) below.

Entire text also available as an [ftp download](#).

If you've chosen to purchase field-run grain or if the pre-cleaned product you've bought isn't clean enough to suit you, you can do it yourself.

The fastest and easiest method is "fanning", a form of winnowing. This is done by pouring the grain slowly through the air stream of a fan or blower into a clean, deep container such as a cardboard box or trash can. The wind blowing through the falling grain will blow out most of the broken kernels, chaff, smut balls, mouse droppings, etc. If you're losing too much good grain, try turning the fan down or moving it further back from the container. The deep container will cut down on the amount of kernels that bounce out. Repeat fanning as necessary until the grain is clean enough to suit or you've blown all of the lighter contaminants out.

If the fanning didn't get the grain clean enough then it can be further cleaned by running it through a screen or sieve. This should be made with holes just big enough to pass an average sized grain of what it is you're cleaning. Obviously, the size of the holes will necessarily vary depending upon the kernel size of the grain.

Should the kernels still not be clean enough to suit then you'll just have to resort to "hand picking" out the offending particles. I'd strongly suggest doing this just prior to grinding where it can be done in small batches rather than trying to do your entire storage all at once. It's much easier to do a few pounds at a time than fifty or a hundred.

If you have it in mind to wash the grain, this should not be done prior to storage, but, rather, just before use. After it's been rinsed, it should be dried immediately in the oven by placing it no deeper than 1/2 inch and heated at 150 F for an hour. It should be stirred occasionally to improve drying.

**DISCLAIMER:** Safe and effective food storage requires attention to detail and proper equipment and ingredients. The author makes no warranties and assumes no responsibility for errors or omissions in the text, or damages resulting from the use or misuse of information contained herein. Placement of or access to this work on this or any other site does not mean the author espouses or adopts any political, philosophical or meta-physical concepts that may also be expressed wherever this work appears.



# Troubled Times



## Vinegar

Copyright 1997 [Alan T. Hagan](#). All rights reserved.

Republished in part by express permission. Please note [Disclaimer](#) below.

Entire text also available as an [ftp download](#).

There is vinegar and then there is vinegar and it is not all alike. The active ingredient in all vinegars is acetic acid, but what the sour stuff is made from can vary widely. The most common vinegar is the white distilled variety which is actually just diluted distilled acetic acid and not true vinegar at all. It keeps pretty much indefinitely if tightly sealed in a plastic or glass bottle with a *plastic* cap. The enamel coated metal caps always seem to get eaten by the acid over time. It is usually about 5-6% acetic acid and for pickling it is the type most often called for.

The next most common variety is apple cider vinegar. There are two kinds of this type. A "cider flavored" distilled acetic acid type and a true cider vinegar fermented from hard cider. Either will store indefinitely at room temperature until a sediment begins to appear on the bottom. Stored vinegar will sometimes develop a cloudy substance. This is called a "mother of vinegar" and it is harmless. As long as the liquid does not begin to smell foul it can be filtered out through cheesecloth or a coffee filter and rebottled in a clean container. The mother can even be used to make more vinegar. If it begins to smell bad, however, it's gone over and should be tossed out.

The more exotic wine vinegars, balsamic and other types all can be stored like cider vinegar. Age and exposure to light and air, however, eventually begin to take their toll on their delicate flavors. Tightly capped in a cool, dark cabinet or refrigerator is best for their storage.

**DISCLAIMER:** Safe and effective food storage requires attention to detail and proper equipment and ingredients. The author makes no warranties and assumes no responsibility for errors or omissions in the text, or damages resulting from the use or misuse of information contained herein. Placement of or access to this work on this or any other site does not mean the author espouses or adopts any political, philosophical or meta-physical concepts that may also be expressed wherever this work appears.



# Troubled Times



## Herbs and Spices

---

Copyright 1997 [Alan T. Hagan](#). All rights reserved.

Republished in part by express permission. Please note [Disclaimer](#) below.

Entire text also available as an [ftp download](#).

It is difficult to give exact instructions on how best to store culinary herbs and spices because there are dozens of different seeds, leaves, roots, etc. we call an herb or a spice. There are, however, some general rules to be followed to best preserve their flavors. All spices, particularly dried, are especially sensitive to heat, air and light. Room temperature is fine for keeping them, but they should be kept away from heat sources. It is common for the household spice cabinet or shelf to be located over the stove, but this is really a very poor place. Dark opaque glass is best for storage, but failing that, keeping a tightly sealed glass container in a dark place is next best. The cellophane packets some products come in just won't do for storage. Tightly sealed metal containers will work as well. Even dense plastic will do, but glass is best.

Where possible, buy spices whole. Whole nutmegs will keep their flavor far longer than ground nutmeg, same for other seeds and roots. You'll have to get a grater, grinder or whatever, but the difference in flavor will be worth it.

If you buy spices in bulk containers (which is certainly cheaper) consider transferring some into smaller containers and keeping the larger one tightly sealed in a cool, dark place. This will prevent unwanted light and air from continually getting in and playing havoc.

Included in the suppliers addresses is a listing for **Penzey's**. I have never dealt with them myself, but they consistently get many good reviews in the rec.cooking newsgroup for the quality and price of their herbs and products. It might be worth your while to order a catalog.

**DISCLAIMER:** Safe and effective food storage requires attention to detail and proper equipment and ingredients. The author makes no warranties and assumes no responsibility for errors or omissions in the text, or damages resulting from the use or misuse of information contained herein. Placement of or access to this work on this or any other site does not mean the author espouses or adopts any political, philosophical or meta-physical concepts that may also be expressed wherever this work appears.



# Troubled Times



## Salt

---

Copyright 1997 [Alan T. Hagan](#). All rights reserved.

Republished in part by express permission. Please note [Disclaimer](#) below.

Entire text also available as an [ftp download](#).

Storage life for salt is indefinite. So long as you keep it dry and do not let it get contaminated with dirt or whatever, it will never go bad. Over time, iodized salt may turn yellow, but this is harmless and may still be used. Salt is rather hygroscopic and will adsorb moisture from the air if not sealed in an air-tight container. If it does adsorb moisture and cakes up, it can be dried in the oven and then broken up with no harm done.

All salt, however, is not the same. Salt comes in a number of different varieties, each with its own purpose. Very little of the salt produced in the US is intended for use in food. The rest of it, about 98%, has other uses. Therefore, it is important to be certain the salt you have is intended for human consumption. Once you are satisfied it is, you should then determine its appropriateness for the tasks to which you might want to set it to. Below is a partial list of some of the available salts. I hope to make it more complete as I find better information.

### Table Salt

This is by far the most widely known type of salt. It comes in two varieties; iodized and non-iodized. There is an ingredient added to it to absorb moisture so it will stay free flowing in damp weather. This non-caking agent does not dissolve in water and can cause cloudiness in whatever solution it is used if sufficiently large quantities are used. In canning it won't cause a problem since there is very little per jar. For pickling, though, it would be noticeable. If you are storing salt for this purpose, you should be sure to choose plain pickling salt, or other food grade pure salt. In the iodized varieties, the iodine can cause discoloration or darkening of pickled foods so be certain not to use it for that purpose.

### Canning Salt

This is pure salt and nothing but salt. It can usually be found in the canning supplies section of most stores. This is the salt to be preferred for most food preservation or storage uses.

### Kosher Salt

I'm not precisely sure what makes kosher salt different from canning salt. I'm presuming that it must have been processed in a particular manner in accordance with the kosher dietary laws of the Jewish faith because it is used in preparation of kosher foods. It is generally larger in grain size than table or canning salt and may have even been rolled to produce "flaked" kosher salt. Grain size can vary from manufacturer to manufacturer.

### Sea Salt

This type of salt comes in about as many different varieties as coffee and from about as many different places around the world. The "gourmet" versions can be rather expensive. In general, the types sold in grocery stores, natural food markets and gourmet shops have been purified enough to use in food. It's not very suitable for food preservation, though, because the mineral content it contains (other than the sodium chloride) may cause discoloration of the food.



### **Rock or Ice Cream Salt**

This type of salt comes in large chunky crystals and is intended primarily for use in home ice cream churns to lower the temperature of the ice filled water in which the churn sits. It's also sometimes used in icing down beer kegs. It is used in food preservation by some, but none of the brands I have been able to find label it as food grade so I would not use it for this purpose.

### **Solar Salt**

This is also sometimes confusingly called "sea salt". It is not, however, the same thing as the sea salt found in food stores. Most importantly, it is *not* food grade. It's main purpose is for use in water softeners. The reason it is called "solar" and sometimes "sea salt" is that it is produced by evaporation of sea water in large ponds in various arid areas of the world. This salt type is not purified and still contains the desiccated remains of whatever aquatic life might have been trapped in it. Those organic remains might react with the proteins in the foods you are attempting to preserve and cause it to spoil.

### **Halite**

For those of us fortunate enough to live far enough south to not need it, halite is the salt that is used on roads to melt snow and ice. It, too, is not food grade and should not be used in food preservation.

### **Salt Substitutes**

These are various other kinds of metal salts such as potassium chloride used to substitute for the ordinary sodium chloride salt we are familiar with. They have their uses, but should not be used in foods undergoing a heated preservation processing, they can cause the product to taste bad. Even the heat from normal cooking is sometimes sufficient to cause this.

**DISCLAIMER:** Safe and effective food storage requires attention to detail and proper equipment and ingredients. The author makes no warranties and assumes no responsibility for errors or omissions in the text, or damages resulting from the use or misuse of information contained herein. Placement of or access to this work on this or any other site does not mean the author espouses or adopts any political, philosophical or meta-physical concepts that may also be expressed wherever this work appears.



# Troubled Times



## Fats and Oils

---

Copyright 1997 [Alan T. Hagan](#). All rights reserved.

Republished in part by express permission. Please note [Disclaimer](#) below.

Entire text also available as an [ftp download](#).

All oils are fats, but not all fats are oils. They are very similar to each other in their chemical makeup, but what makes one an oil and another a fat is the percentage of hydrogen saturation in the fatty acids of which they are composed. The fats and oils which are available to us for culinary purposes are actually mixtures of differing fatty acids so for practical purposes we'll say saturated fats are solid at room temperature (70 F) and unsaturated fats we call oils are liquid at room temperature. For dietary and nutrition purposes fats are generally classified as saturated, monosaturated and polyunsaturated, but this is just a further refinement of the amount of saturation of the particular compositions of fatty acids in the fats.

There is a problem with storing oils and fats for the long term and that is the fact that they go rancid rather quickly. Rancid fats have been implicated in increased rates of heart disease, atherosclerosis and are carcinogenic (cancer causing) so we want to avoid them if possible.

Oxygen is eight times more soluble in fat than in water and it is the oxidation resulting from this exposure that is the primary cause of rancidity. The more polyunsaturated a fat is, the faster it will go rancid. This may not, at first, be readily apparent because vegetable oils have to become several times more rancid than animal fats before our noses can detect it. An extreme example of rancidity is the linseed oil (flaxseed) that we use as a wood finish and a base for oil paints. In just a matter of hours the oil oxidizes into a solid polymer. This is very desirable for wood and paint, very undesirable for food.

Because of this difficulty in storing fats and oils for any long period of time many books and articles on the subject of food storage make only passing mention of them, if they say anything at all. This is unfortunate because fat contains nine calories to the gram compared to the four calories contained by either carbohydrates or protein. This makes fat a valuable source of concentrated calories that could be of real importance if faced with a diet consisting largely of unrefined grains and legumes. For small children, infants and the elderly, they may not be able to consume the volume of food that would be necessary in the course of a day to get all of the calories they would need to avoid weight loss and possible malnutrition. Additionally, fats play an important role in our perception of taste and texture and their absence would make many foods more difficult to prepare and consume. Furthermore, a small amount of dietary fat is necessary for our bodies to properly absorb fat soluble vitamins like A,D,E and K.

Long term storage of fats may be problematical, but it is not impossible. There are some general rules you can follow to get the most life out of your stored cooking oils and fats.

1. Exposure to oxygen, light and heat are the greatest factors to rancidity. If you can, refrigerate your stored oil, particularly after it's been opened. If possible, buy your oils in opaque, airtight containers. If you purchase it in plastic, particularly clear plastic, then transfer it to a gas impermeable glass or metal container that can be sealed airtight. If you have a means of doing so, vacuum sealing the storage container is an excellent idea as it removes most of the air remaining inside, taking much of the oxygen with it. Transparent glass and plastic containers should be stored in the dark, such as in a box. Regardless of the storage container, it should be stored at as cool a temperature as possible and

rotated as fast as is practical. Oils and fats with preservatives added by the manufacturer will have a greater shelf life than those without them, provided they are fresh when purchased.

2. Unless they have been specially treated, unopened cooking oils have a shelf life of about a year, depending upon the above conditions. Some specialty oils such as sesame and flax seed have shorter usable lives. If you don't use a great deal of it, try to not buy your fats in large containers. This way you won't be exposing a large quantity to the air after the you've opened it, to grow old and possibly rancid, before you can use it all up. Once opened, it is an excellent idea to refrigerate cooking fats. If it turns cloudy or solid, the fat is still perfectly usable and will return to its normal liquid, clear state after it has warmed to room temperature. Left at room temperatures, opened bottles of cooking oils can begin to rancid in anywhere from a week to a couple of months, though it may take several more months to reach such a point of rancidity that it can be smelled.
3. Although darker colored oils have more flavor than paler colored, the agents that contribute to that flavor and color also contribute to faster rancidity. For maximum shelf life buy paler colored oils.
4. If you have no particular problem with using it, the culinary fat with the most shelf life as it comes from the store is hydrogenated shortening in its unopened metal or metal lined can. The brand most familiar in the U.S. is probably Crisco, but there are many others. Solid shortening is usually composed of partially hydrogenated vegetable oils, but there are some that also contain animal fats. Some brands will also contain anti-oxidant preservatives as well. All other conditions being equal, those with preservatives will have a longer shelf life than those without. It is not possible to give an exact answer, but it is reasonable to expect an unopened metal can of shortening to have a shelf life of eight to ten years if kept reasonably cool, particularly if it has preservatives in it.

**DISCLAIMER:** Safe and effective food storage requires attention to detail and proper equipment and ingredients. The author makes no warranties and assumes no responsibility for errors or omissions in the text, or damages resulting from the use or misuse of information contained herein. Placement of or access to this work on this or any other site does not mean the author espouses or adopts any political, philosophical or meta-physical concepts that may also be expressed wherever this work appears.



# Troubled Times



## Sugars

---

Copyright 1997 [Alan T. Hagan](#). All rights reserved.

Republished in part by express permission. Please note [Disclaimer](#) below.

Entire text also available as an [ftp download](#).

There are a wide number of sugars to be found for purposes of sweetening foods. Fructose is the primary sugar in fruit and honey; maltose is one of the sugars in malted grains; pimentose are found in olives and sucrose is what we know as granulated or table sugar. Sucrose is a highly refined product made mostly from sugar cane though some may still be made from sugar beets. Modern table sugar is now so highly refined as to be virtually 100% pure and nearly indestructible if protected from moisture. Powdered sugar and brown sugar are simple variations on granulated sugar and share its long life.

Liquid sweeteners do not have quite the longevity of dry sugars. Honey, molasses, corn syrup and maple syrup may crystallize or mold during long storage. These syrups are chemically not as simple as table sugar and therefore lose flavor and otherwise break down over a long period of time.

Buying granulated sugar and its close cousins is really a very simple matter. Buy a brand you know you can trust and be certain the package is clean, dry and has no insect infestation. There's very little that can go wrong with it.

### **Granulated Sugar**

Granulated sugar does not spoil, but if it gets damp it will likely cake up or get lumpy. If it does, it can simply be pulverized again until it regains its granulated texture.

### **Powdered Sugar and Confectioner's Sugar**

Both names refer to the same kind of sugar, that is white granulated sugar very finely ground. For commercial use there is a range of textures from coarse to ultra-fine. For home consumption, what is generally found is either Very Fine (6X) or Ultra-Fine (10X). Not all manufacturers will indicate the grind on the package though. Sugar refiners usually add a small amount of corn starch to prevent caking.

Powdered sugar is as inert as granulated sugar, but it is even more hygroscopic and will absorb any moisture present. If it absorbs more than a little it may cake up and get hard. It's difficult to reclaim hardened powdered sugar, but it can still be used like granulated sugar.

### **Brown Sugar**

In the United States brown sugar is basically just refined white sugar that has had a bit of molasses added to it. Dark brown sugar has more molasses which gives it a stronger flavor, a darker color and makes it damp. Light brown sugar has less molasses which gives it a milder flavor, a blonder color and is slightly dryer than the dark variety. For storage purposes you may want to just stock the dark variety. Light brown sugar can be made by combining one fourth to one third white sugar to the remainder dark brown sugar and blend thoroughly.

Both varieties need to be protected from drying out, or they will become very hard and difficult to deal with. Nor do you want to allow them to become damper than what they already are.

There are granulated and liquid brown sugars available, but they don't have the same cooking qualities as ordinary brown sugars. They also don't dry out and harden quite so readily either.

### **Raw, Natural or Turbinado Sugar**

In recent years, sugar refiners have realized that there is a market for less refined forms of cane sugar here in the US and have begun to sell this kind of sugar under various names and packaging. None of it is really "raw" sugar since it is illegal to sell it in this country due to the high impurities level in truly raw sugar. All of it has been processed in some form or fashion to clean it, but it has not been subjected to the full refining and whitening processes of ordinary white table sugar. This leaves some of the natural color and a mild flavor in the sweetener. All of these less refined sugars should be stored and handled like brown sugar.

All granulated sugars have basically the same storage requirements. They need to be kept in air tight, insect and moisture proof containers. For powdered, granulated and raw sugar you might want to consider using some desiccant in the storage container if your local climate is damp. Since brown sugars are supposed to be moist, they do not need desiccants. Shelf life is indefinite if kept dry, but anything that you intend to eat really should be rotated over time. Time has a way of affecting even the most durable of foods.

I've used brown sugar that was six years old at the time it was removed from storage and other than the molasses settling somewhat towards the bottom it was just fine.

**DISCLAIMER:** Safe and effective food storage requires attention to detail and proper equipment and ingredients. The author makes no warranties and assumes no responsibility for errors or omissions in the text, or damages resulting from the use or misuse of information contained herein. Placement of or access to this work on this or any other site does not mean the author espouses or adopts any political, philosophical or meta-physical concepts that may also be expressed wherever this work appears.



# Troubled Times

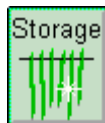

## Liquid Sugars

---

Copyright 1997 [Alan T. Hagan](#). All rights reserved.

Republished in part by express permission. Please note [Disclaimer](#) below.

Entire text also available as an [ftp download](#).

### **Molasses, Cane, Sorghum, and Table Syrups**

Molasses and cane syrup are not precisely the same thing. Molasses is a by-product of sugar refining and cane syrup is simply cane juice boiled down to a syrup, in much the same way as maple syrup is produced. Non-Southerners may know it better as "unsulphured molasses" even if this is not completely correct. Sorghum syrup is produced in the same manner, but sorghum cane, rather than sugar cane, is used. Sorghum tends to have a thinner, slightly sourer taste than cane syrup. All these syrups are generally dark with a rich, heavy flavor. There are many "table syrups" sold in supermarkets, but close examination of the ingredient lists will reveal mixtures of cane syrup, cane sugar syrup and corn syrup. They usually have a much less pronounced flavor.

All of the above syrups, except for those having corn syrup in their makeup, have the same storage characteristics. They can be stored on the shelf for about two years and up to a year after opening. Once they are opened, they are best kept in the refrigerator to retard mold growth. If mold growth does occur, the syrup should be discarded. The outside of the bottle should be cleaned of drips after each use. Some pure cane and sorghum syrups may crystallize in storage, but this causes no harm and they can be reliquified using the same method as for honey.

### **Corn Syrup**

Corn syrup is a liquid sweetener made by an enzyme reaction with corn starch. Available in both a light and a dark form, the darker variety has a flavor similar to molasses and contains refiners syrup (a byproduct of sugar refining). Both types often contain flavorings and preservatives. They are commonly used in baking and candy making because they do not crystallize when heated.

Corn syrup is a poor storer compared to the other common sweeteners and because of this it often has a "best if sold by" dating code on the bottle. It should be stored in its original bottle, tightly capped, in a cool, dry place. New unopened bottles keep about six months from the date on the label. After opening, keep the corn syrup four to six months. These syrups are very prone to mold and to fermentation so be on the lookout for bubbling or a mold haze. If these present themselves, throw the syrup out. You should always be certain to wipe off any drips from the bottle after every use.

I don't recommend corn syrup as a storage food since it stores so poorly.

### **Maple Syrup**

Maple syrup is probably the only sweetener that has developed a cult-like following (OK, cane syrup has its ardent fans too). Produced by boiling down maple sap until it reaches a syrup consistency, it is slightly sweeter than table sugar. Maple syrup is judged by much the same criteria as honey: lightness of color, clarity and taste. Pure maple is generally expensive and most pancake syrups are corn and cane sugar syrups with either natural or artificial flavorings.

New unopened bottles of maple syrup may be kept on a cool, dark, shelf for up to two years. The

sweetener may darken and the flavor get stronger, but it is still usable.

After the bottle has been opened, it should be refrigerated. It will last about a year. Be careful to look out for mold growth. If mold occurs, discard the syrup.

Flavored pancake syrups should be kept and stored as corn syrups.

**DISCLAIMER:** Safe and effective food storage requires attention to detail and proper equipment and ingredients. The author makes no warranties and assumes no responsibility for errors or omissions in the text, or damages resulting from the use or misuse of information contained herein. Placement of or access to this work on this or any other site does not mean the author espouses or adopts any political, philosophical or meta-physical concepts that may also be expressed wherever this work appears.



# Troubled Times



## Leavening Agents

---

Copyright 1997 [Alan T. Hagan](#). All rights reserved.

Republished in part by express permission. Please note [Disclaimer](#) below.

Entire text also available as an [ftp download](#).

### Baking Powder

This powder is a combination of an acid, an alkali, and a starch to keep the other ingredients stable and dry. The powder reacts with liquid by foaming and the resulting bubbles can aerate and raise dough. Almost all baking powder now on the market is double acting, meaning it has one acid that bubbles at room temperature and another acid which only reacts at oven temperatures. Unless a recipe specifies otherwise, this is the type to use.

Don't expose baking powder to steam, humid air, wet spoons, or any other moisture. Store in a tightly lidded container for no more than a year. Even bone dry baking powder eventually loses its potency. To test its strength, measure 1 tsp powder into 1/3 cup hot water. The mixture should fizz and bubble furiously. If it doesn't, throw the baking powder out.

For those folks concerned with aluminum in the diet, the Rumford brand has none in it and there may be others.

### Baking Soda

This gritty powder is sodium bicarbonate also called sodium acid bicarbonate ( $\text{NaHCO}_3$ ), a mild alkali. It is used in baking to leaven bread and does so in the same manner as baking powder. When combined with an acid ingredient, the bicarbonate reacts to give off carbon dioxide bubbles which causes the baked good to rise. If kept well sealed in an air- and moisture-proof container its storage life is indefinite. If kept in the cardboard box it usually comes in, it will keep for about eighteen months. Do keep in mind that baking soda is a wonderful odor absorber. If you don't want your baked goods tasting of whatever smells it absorbed then keeping it in an airtight container is an excellent idea.

**DISCLAIMER:** Safe and effective food storage requires attention to detail and proper equipment and ingredients. The author makes no warranties and assumes no responsibility for errors or omissions in the text, or damages resulting from the use or misuse of information contained herein. Placement of or access to this work on this or any other site does not mean the author espouses or adopts any political, philosophical or meta-physical concepts that may also be expressed wherever this work appears.





# Troubled Times



## Milk Products

---

Pasteurization at 145 degrees slows bacteria growth, but doesn't eliminate bacteria. Dr Hulda Clark has pointed out that all store-bought milk has repeatedly tested positive for Salmonella, and Shigella. Milk also contains tumor-causing species of bacteria called **Clostridium** and **Rhizobium**. If you add a pinch of salt and boil milk for *10 seconds*, you will kill off all of these organisms. Now you have truly sterilized milk. After the milk cools, you can add a half teaspoon (quart to half gallon) of powdered Vitamin C to break down the **Malonic Acid**, another undesirable compound. Finally, add a small amount of colloidal silver to give it even more shelf life. The taste is different, of course, but many people say that they prefer it. I put the milk in a glass jug with a screw on lid and stick it in the fridge. I recommend 2% milk for its nutrient content. Use the same procedure for cream.

Cheese can last a long time, but it also contains the above organisms that were originally in the milk that the cheese was made from. If you only consume cheese that has been melted first, you can avoid consuming these live bacteria. Store bought yogurt, cottage cheeses, and ice creams also contain the above organisms. It's very easy to make your own yogurt with your own boiled milk. Cottage cheese is not as easy, but nonetheless doable at home. You can make your own ice cream as well.

Offered by [Ed](#)



# Troubled Times



## Infant Formula

---

Copyright 1997 [Alan T. Hagan](#). All rights reserved.

Republished in part by express permission. Please note [Disclaimer](#) below.

Entire text also available as an [ftp download](#).

In examining the offerings at my local grocer I see that infant formula is also offered as a dry powder to be mixed by the parent. I could not come to a ready idea of how long the formula powder might be good on the shelf since it seemed to vary radically depending on exact type and manufacturer. The shortest use-by date was only a year, but some had use-by dates three years into the future. Clearly, this is an area that is going to need much investigation. I hope some of our knowledgeable readers out there will be able to help out.

**DISCLAIMER:** Safe and effective food storage requires attention to detail and proper equipment and ingredients. The author makes no warranties and assumes no responsibility for errors or omissions in the text, or damages resulting from the use or misuse of information contained herein. Placement of or access to this work on this or any other site does not mean the author espouses or adopts any political, philosophical or meta-physical concepts that may also be expressed wherever this work appears.



# Troubled Times



## Molds in Food

Copyright 1997 Alan T. Hagan. All rights reserved.

Republished in part by express permission. Please note [Disclaimer](#) below.

Entire text also available as an [ftp download](#).

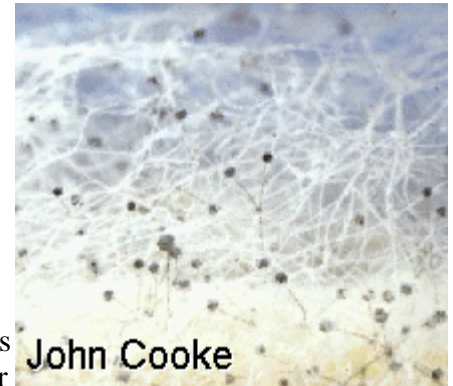

Molds are fungi just like mushrooms and yeast. Also like mushrooms, they reproduce by releasing spores into the air that land on everything, including your food and food storage containers. When those spores begin to grow, they create thin threads that spread through out their growing medium. These threads are the roots of the mold fungus, called mycelium. The stalk of a mold fungus is the portion above or on the surface of the food. It produces the spores and gives the mold its color. We've all seen examples of this when we discover a dish of something or other left way-y-y too long in the refrigerator and has become covered in mold fuzz.

Molds can grow anywhere they have a growing medium (their food), sufficient moisture and enough warmth. Some can even grow at refrigerator temperatures, albeit more slowly than they would if it were warmer. They can also withstand much more salt and sugar than bacteria, which is why you sometimes find mold in jellies and jams with their high sugar content and on cured products like ham or bacon with their high salt content.

In the past, it was often felt a slight amount of mold was harmless and the food could be consumed anyway. For molds that were intentionally introduced into the food, such as the mold in bleu cheese, this is just fine. For the unintentional molds, it can be a very serious error in judgment. These unwanted molds might just be producing a toxic substance called a "mycotoxin" which can be very bad indeed. Mycotoxins are produced around the root or mycelium of the mold and the mold roots can penetrate very deeply into the food. These mycotoxins can survive for a long time in foods, and unfortunately most are not destroyed by cooking. The molds probably best known for this are the various *Aspergillus* varieties which produces a mycotoxin known as "aflatoxin", but there are other dangerous molds as well, such the *Fusarium* molds. Both of the above affect grain and some legumes.

In wet pack foods such as your home canned goodies, molds can do something else, possibly leading to lethal consequences. If they are present in wet pack food by reasons of improper procedure or contamination after the fact, they can consume the natural acids present in the food. The effect of this is to *raise* the pH of the food in the container, perhaps to the point that it becomes possible for spores of *Clostridium botulinum*, better known as "botulism", to become active and reproduce. If you're not already aware of the consequences of botulism poisoning, please read the bacterial spoilage section .. where it has an entry all its own. This is the most deadly kind of food poisoning there is. For this reason, moldy wet pack foods should be *safely* discarded.

Molds in low acid foods canned by the pressure canning method are equally dangerous and should also be discarded in a safe manner.

**DISCLAIMER:** Safe and effective food storage requires attention to detail and proper equipment and ingredients. The author makes no warranties and assumes no responsibility for

errors or omissions in the text, or damages resulting from the use or misuse of information contained herein. Placement of or access to this work on this or any other site does not mean the author espouses or adopts any political, philosophical or meta-physical concepts that may also be expressed wherever this work appears.



# Troubled Times



## Minimize Molds

---

Copyright 1997 [Alan T. Hagan](#). All rights reserved.

Republished in part by express permission. Please note [Disclaimer](#) below.

Entire text also available as an [ftp download](#).

You can do a number of things to minimize unwanted mold growth in your kitchen, food storage areas and refrigerators. If your kitchen is at all like mine, it is the refrigerator that is going to collect the most fungal growth. This can be dealt with by washing the inside every couple of months with a tablespoon of baking soda dissolved in a quart of warm water. Rinse clean and allow to dry. The black mildew that grows on the rubber door gaskets and other places can be dealt with by wiping down with a solution of three tablespoons of household bleach in a quart of water. I generally use a soft bristle brush for this.

The rest of the kitchen can be kept mold free by keeping it clean, and dry and by spraying occasionally with a product such as Lysol. Patches of mold growing in spots can be eliminated with the bleach solution used on the refrigerator doors.

Try not to purchase more fresh food than you'll be able to eat in a short period of time. This will keep you from having to deal with the moldy remains that didn't get eaten. If food does go moldy, *don't sniff it*. This is a good way to give yourself respiratory difficulties if you are at all susceptible to mold allergies. Moldy food should be disposed in such a manner that your animals and children won't be able to get into it. Mycotoxins are every bit as bad for your animals as they are for you.

Obviously, you don't have to throw out everything that shows a spot of mold on it. Some foods can be safely dealt with and still partially saved if they show signs of fungal growth. Below is a set of guideline from M. Susan Brewer, Ph.D., RD, a specialist in food safety. Her articles and works are found in many state university extension services publications lists.

If the food shows even a tiny mold spot, follow these guide lines:

1. Hard or firm foods with tiny mold spots can be trimmed; cut away the area around the mold (at least an inch) and rewrap in clean wrap. Make sure that knife does not touch the mold.
2. Soft foods such as cheese slices, cream cheese, sour cream and yogurt should be thrown away.

### TOSS:

- Soft Cheeses, (Mozzarella Brie)
- Sour Cream, Yogurt, Cottage cheese
- Bacon, Hot dogs, Sliced lunch meats
- Meat pies
- Opened canned ham
- Most left-over food
- Bread, Cakes, rolls, flour, pastry
- Peanut butter
- Juices, berries
- Jam, Jellies, Syrups
- Cucumbers, Tomatoes

- Spinach, Lettuce, other leafy vegetables
- Bananas, Peaches, Melons
- Corn-on-the-cob
- Stored nuts, whole grains, rice

**TRIM:**

- Hard Cheese (Cheddar, Swiss)
- Bell Peppers, Carrots, Cabbage
- Broccoli, Cauliflower, Brussels Sprouts
- Garlic, Onions
- Potatoes, Turnips
- Zucchini
- Apples, Pears

**DISCLAIMER:** Safe and effective food storage requires attention to detail and proper equipment and ingredients. The author makes no warranties and assumes no responsibility for errors or omissions in the text, or damages resulting from the use or misuse of information contained herein. Placement of or access to this work on this or any other site does not mean the author espouses or adopts any political, philosophical or meta-physical concepts that may also be expressed wherever this work appears.



# Troubled Times



## Prevent Molds

---

Copyright 1997 [Alan T. Hagan](#). All rights reserved.

Republished in part by express permission. Please note [Disclaimer](#) below.

Entire text also available as an [ftp download](#).

The easiest method to prevent mold growth in your stored grains and legumes is simply to keep them too dry for the mold to grow. The Aspergillus and Fusarium molds require moisture contents of 18% and above to reproduce. This is subject to some variability, but in all grains and soybeans, they must have a moisture content of that level. If you are storing raw (not roasted) peanuts, in the shell or shelled, you want to get the moisture content to less than 8% as peanuts are particularly susceptible to mold growth. The recommended moisture content for all other grain and legume storage is no more than 10%. ... At 10% moisture, it is simply too dry for fungi to grow. ...

**DISCLAIMER:** Safe and effective food storage requires attention to detail and proper equipment and ingredients. The author makes no warranties and assumes no responsibility for errors or omissions in the text, or damages resulting from the use or misuse of information contained herein. Placement of or access to this work on this or any other site does not mean the author espouses or adopts any political, philosophical or meta-physical concepts that may also be expressed wherever this work appears.



# Troubled Times



## Molds in Canned Goods

---

Copyright 1997 [Alan T. Hagan](#). All rights reserved.

Republished in part by express permission. Please note [Disclaimer](#) below.

Entire text also available as an [ftp download](#).

If good equipment and proper technique are used, then it is unlikely you will ever have mold growth in your unopened canned goods. If you do have such, then there was either a flaw in the procedure you used, or something affected the jar or can after the fact to break its seal. In any event, once the food has molded, it is past saving and should be discarded in such a way that children and animals will not be able to get into it.

The most likely home canned products to show mold growth are jams and jellies sealed with paraffin wax. There are a number of points in the canning process where this can occur.

1. in the time after the jar is taken out of its boiling water bath, but before it is filled,
2. in the time between when the jar is filled and covered with the melted wax,
3. when the wax cools, if it pulls away from the side of the jar, leaving an opening for the mold to get in, and
4. if bubbles form in the paraffin, which break and leave holes. It is for this reason that most canning authorities no longer recommend using this technique. If you must use it, the jelly jars should be boiled for at least 10 minutes before the jelly is poured into the jars. The filled and wax capped jars should then be covered with some sort of protective lid.

The book, *Putting Food By* has excellent instructions on this or see the applicable section of the [rec.food.preserving FAQ](#) by Leslie Basel.

**DISCLAIMER:** Safe and effective food storage requires attention to detail and proper equipment and ingredients. The author makes no warranties and assumes no responsibility for errors or omissions in the text, or damages resulting from the use or misuse of information contained herein. Placement of or access to this work on this or any other site does not mean the author espouses or adopts any political, philosophical or meta-physical concepts that may also be expressed wherever this work appears.





# Troubled Times



## Molds in Grains and Legumes

---

Copyright 1997 [Alan T. Hagan](#). All rights reserved.

Republished in part by express permission. Please note [Disclaimer](#) below.

Entire text also available as an [ftp download](#).

It's long been known that eating moldy grain is bad for your health. The ugly consequences of eating ergot-infected rye probably make the best known example. It's only been for about thirty years, though, that intensive study of these grain fungi have been carried out on other varieties of molds and their respective mycotoxins. Fortunately, for those of us in the US, the USDA and the various state departments of agriculture go to a great deal of trouble to detect grain and legumes infected with these toxic fungi. In some of the less developed countries, the citizenry are not so lucky. Still, it is good to have something of an understanding of what one should do to prevent mold growth in one's stored grains and to have an idea of what to look for and ask about when purchasing grains and legumes.

The one fungal type that has caused the most commotion in recent history are the various *Aspergillus* species of molds. Under certain conditions with certain grains, legumes and to a lesser extent, nuts, they can produce a mycotoxin called "aflatoxin". This is a serious problem in some parts of the world, most especially in peanuts, occasionally in corn. There have been no deaths I am aware of in the United States from aflatoxicity, though other countries have not been so fortunate. What makes aflatoxin so worrisome in this country is that it is also a very potent carcinogen (cancer causing agent).

In addition to the *Aspergillus* molds, there is also a very large family of molds called *Fusarium* and these can produce a wide variety of mycotoxins, all of which you do not want to be eating directly or feeding to your animals where you will get it indirectly when you eat them.

---

The Federal government and the various state governments continuously monitor food and forage crops. Those products which are prone to mold growth and toxin production are not allowed to be sold for food. Once purchased however, it is up to you to keep your food safe from mold growth. If you have already found mold growth in your whole grains, meals, flours or other grain products, they should be discarded. Most mycotoxins are not broken down or destroyed by cooking temperatures and there is no safe way to salvage grain that has molded.

**DISCLAIMER:** Safe and effective food storage requires attention to detail and proper equipment and ingredients. The author makes no warranties and assumes no responsibility for errors or omissions in the text, or damages resulting from the use or misuse of information contained herein. Placement of or access to this work on this or any other site does not mean the author espouses or adopts any political, philosophical or meta-physical concepts that may also be expressed wherever this work appears.



# Troubled Times



## Botulism

Copyright 1997 Alan T. Hagan. All rights reserved.

Republished in part by express permission. Please note [Disclaimer](#) below.

Entire text also available as an [ftp download](#).

*C. botulinum* is one of the oldest types of life forms found on the planet. Like the gangrene bacteria, it is an anaerobic organism meaning it lives and grows in the absence of free oxygen. It forms spores when conditions are not suitable for it to grow and it is commonly found in the soil. This means it can be brought into your life on raw produce, tools, hands or anything else that came into contact with dirt. To further complicate matters, botulinum spores are extremely heat-hardy. The bacteria itself can be killed by exposing them for a short time to boiling water (**212 F at sea level pressure**), but their spores can not. To kill them, the food product and container must be exposed to temperatures of **240 F (again at sea level pressure)** for a long enough period of time. Only a pressure canner can reach the necessary temperature.

It's not the bacteria or its spores which are directly deadly, but the toxin the bacteria creates when it grows and reproduces. In its pure form, botulism toxin is so potent that a mere teaspoon of it would be enough to provide a fatal dose to hundreds of thousands of people. It is this lethality that is why every responsible book on canning, food preservation, food storage, and the like hammers constantly on the need for care in technique and method and why spoilage must be taken so seriously.

*C. botulinum*, like any other life form, must have suitable conditions for it to grow and become a danger to you. One of the conditions it must have is a suitable pH range in its environment. pH is the measure of the acidity or alkalinity of a substance and is measured on a scale of 1-14 with anything above 7 being considered alkaline and everything below 7 being considered acid. If the pH of your wet pack food is *below* 4.6 then botulism is unable to grow. Keep in mind pH is not eternal in foods and it is possible for it to change. If it should change to a lesser acidity than 4.6 pH your previously botulinum proof food may start allowing the lethal spoiler to grow .... This is why it is vital to use proper technique, even for acid foods like tomatoes. It has been found that when this occurs and botulinum becomes active and produces its lethal toxin it also produces minute amounts of acid which can lower the pH of the poisoned food back into what should have been the safe zone had the pH not jumped up and allowed the bacteria to grow. Again and again - use good technique and pay attention to what you are doing.

Botulinum toxin, unlike fungal mycotoxins, can be destroyed by boiling the food briskly in an open vessel for fifteen minutes. Because of this, if your canned food shows *any* safety problems you should follow this procedure. If the food shows even the slightest mold growth, keep in mind that mycotoxins are not for the most part broken down by heat and dispose of the food safely.

**DISCLAIMER:** Safe and effective food storage requires attention to detail and proper equipment and ingredients. The author makes no warranties and assumes no responsibility for errors or omissions in the text, or damages resulting from the use or misuse of information contained herein. Placement of or access to this work on this or any other site does not mean the author espouses or adopts any political, philosophical or meta-physical concepts that may also be expressed wherever this work appears.



# Troubled Times



## Bacterial Spoilage

---

Copyright 1997 [Alan T. Hagan](#). All rights reserved.

Republished in part by express permission. Please note [Disclaimer](#) below.

Entire text also available as an [ftp download](#).

Just like the fungi, bacteria are everywhere. They're in the water, soil, air, on you, your food and your food storage containers. Fortunately, the vast majority of the bacteria we encounter are relatively harmless and only a few represent a danger to us and our stored foods.

Bacteria can be very much more difficult to kill off than molds and insects. Some of them are capable of continued growth at temperatures that would kill other spoilage organisms. When conditions are such that they are unable to grow, some bacteria can go dormant and form spores. These spores can be quite hardy, even to the point of surviving a rolling boil.

In order to grow, bacteria need moisture, some as little as a 20% moisture content. For dry grains, legumes, powdered milk and other low moisture foodstuff bacterial spoilage will seldom be a problem so long as the moisture level in the foodstuff remains too scant to support its growth. For this reason, it is imperative that such products be drier than 20% and preferably below 10% to ward off mold growth as well. The botulism bacteria need moisture in the 35% range to grow. Thus, using desiccants in your food packaging is also an excellent idea.

It is in wet pack canned goods (where the container has free liquid in it) and fresh foods we must be the most concerned about spoilage bacteria. It is here that a little bad luck and a moment's inattention to what you are doing could kill or seriously injure you or some other person who eats the foods you've put by. In both home-canned and commercially-canned goods, **if the can is bulging, leaking, smells bad, or spews liquid when you open it then throw it out!** But, throw it out safely so that children and animals cannot get into it.

**DISCLAIMER:** Safe and effective food storage requires attention to detail and proper equipment and ingredients. The author makes no warranties and assumes no responsibility for errors or omissions in the text, or damages resulting from the use or misuse of information contained herein. Placement of or access to this work on this or any other site does not mean the author espouses or adopts any political, philosophical or meta-physical concepts that may also be expressed wherever this work appears.



# Troubled Times



## Dehydrated

---

Dear sir,

I am a young European lad and hope you can answer some important questions that I have:

Question one: Is there an identical company like yours in Europe?

No, not to our knowledge. However, you might contact a large Mormon church in your area and ask them. They should know.

Question two: How long can the offered products on your site be stored away before use? Is that weeks, months, years, decennia?

Dehydrated, 7-15 years, depending on temperature stored. The lower the longer. Freeze dried, in cans 15 years.

Question three: Which products can be stored longest from those you offer on your site? Is that dehydrated food, freeze-dried food, other?

Vegetables, wheat, beans are longest-storing. Dairy products shortest.

Regards, [Michel](#)

Thanks, Bruce Hopkins



# Troubled Times



## Buying Bulk

---

There are bulk food stores all over the US. **Meijer** is in Ohio and has a large bulk food section. The warehouse club stores are great too, as are foodservice distributors such as **Gordon's** and **Sysco** who have outlet stores. Stay off the web, much too expensive for food.

Offered by [John](#).

For any of you who have not yet visited this [Buying Bulk](#) site, I recommend that you do! There is a great variety of freeze-dried and dehydrated foods there, as well as hand mills for grinding and containers for storing. I have checked for bulk buying all over the place and this site has a fine variety at excellent prices! One of the major benefits is that the food is *already* freeze dried or dehydrated. This means you wouldn't have to go through that process with your purchased food items.

Offered by [Shekhina](#).



# Troubled Times



## Hard Tack

---

Hard-tack is extremely hard crackers that don't rot easily. There is hard-tack in museums from the Civil War that hasn't rotted away yet. It can get infested with some insects, though. To eat it you have to soak it in water first or crush it up and put it in your mouth until it softens enough to chew. I bet it tastes lovely.

### Recipe:

2 cups of flour.

A dash of salt.

2 tablespoons of shortening. (lard if possible, no oil)

Water

With just enough water to make it very thick, roll the dough made from the above ingredients into a 1/2-inch thickness. Cut that into 4-inch squares. Poke holes in the top. Bake at 350 degrees until it's real hard. (about 30 minutes) It should even be hard when hot. Don't wrap it in plastic wrap. You need to wrap it in brown paper or brown paper bags or something that won't hold moisture. I'm eventually going to make some for the hell of it, just to learn how. (Like there's much to learn) Learning how to eat it might be the real challenge.

Offered by [Joe](#).



# Troubled Times



## Dog Food

---

The following chart outlines important information about dog food. Examine the quality ingredients and the major nutrients they provide, and learn why these nutrients are important for your ( dogs ) good health. Who would notice if you had a warehouse full of this stuff? It's dry, stores almost forever. I think it covers a lot of nutritional health issues I have read here. You could pop them in your mouth like cheese puffs. (Sorry kid's, ran out of chips, here, snack on this!) And it sure beats eating *bugs*!

### **Protein**

Poultry by-product meal, ground yellow corn, ground wheat, meat and bone meal, animal digest, fish meal. Builds and maintains strong muscles, maintains healthy skin and coat, maintains and develops healthy bones and teeth, enhances good taste, high biological availability.

### **Fat and Fatty Acids**

Poultry fat, poultry by-product meal. Good source of energy, enhances good taste, highly efficient digestibility, contributes to healthy skin and coat.

### **Carbohydrates**

Ground yellow corn, ground wheat. Good source of energy, highly digestible.

### **Fiber**

Beet pulp. Promotes normal digestion, contributes to firm stools.

### **Sodium, Chloride**

Salt. Regulates body fluids.

### **Calcium**

Poultry by product meal, calcium carbonate, meat and bone meal. Growth and maintenance of strong bones and teeth.

### **Phosphorus**

Poultry by product meal, meat and bone meal. Growth and maintenance of strong bones and teeth.

### **Vitamins**

Niacin, riboflavin, thiamin. Maintains enzyme system, assists digestion. Vitamin A and Vitamin D3. Promote strong bones and teeth, healthy skin and healthy vision.

### **Trace Minerals**

Ferrous sulfate(source of iron), copper, zinc. Promote healthy blood and healthy skin.

Offered by [Clip](#).





# Troubled Times



## Pigeon Food

---

Pigeon food believe it or not is something with a high value of nutrition, it has many vitamins and minerals. It has peas, all sorts of grains and alike in it. When thinking of food for pigeons you think of rock hard dried out grains, but the idea is that after 30 minutes of cooking the pigeon food is soft, therefor eatable. You must not expect to have the luxury of choosing to eat only that what your taste buds appreciate. Imagine a group of famished children, you find them near your site, you take them with you. What are you going to give them?

Fairly recently I saw a man on TV who ate pigeon food in the morning, for breakfast and dinner(though next to this food he also ate bread). He was telling the viewers that since he began to eat pigeon food that he never became ill again. Not even a cold. He did 2.5 years with 125 kilos of pigeon food which costs him approximately 37 US dollars. He boiled the stuff for half an hour and then ate it, it looked like normal peas and stuff on a plate.

I can imagine that this is quite boring and that one needs proteins and fats too, but do I state that this is a complete foodstuff? No, it's additional, it would complement the chicken, the eggs or whatever. Now lets go back to those famished children, you've taken them home with you, what are you going to feed them? Yep, pigeon food! As it's cheap, easy to make ready to eat, and it can be stocked and bought everywhere (practically, but don't store in a moist place). If you can boil water then make use of this option.

Offered by [Michel](#).



# Troubled Times



## Vacuum Sealing

---

Instead of fumigating flour and grains (too much fuss), purchase a vacuum packer (about \$199.00-makes a great X-mas gift) and vacuum pack up flour and grains as you purchase them on sale. Toss them into one of those **Rough Neck** style 30+ gallon containers or a plastic garbage pail and before long you are preparing. The **Rough Neck** can also be used for hydroponics growing later on. When the containers are full, label and seal with duct tape.

We use it to pack food when we go camping. All food is prepared ahead of time and put in the bags. They can then be frozen if you want, or refrigerated if needed. We never have anything but our empty baggies to pack back out, no cans, no boxes, etc. The bags are reusable. I have also stored antique clothing and material in the bags, anything that you don't want getting soiled or wet. Old knives or metal items do not rust as there is no air in the bag.

A vacuum pack is similar to the seal-a-meal device. You have a roll consisting of pieces of two-sided plastic, 2 sizes, 8" wide or 11" wide. Roll out the amount you want, any length, cut off and seal one end on the heated clamp on the device. Place anything, (dry or liquid, towels, batteries, anything that will fit that you can imagine) into the bag, put the open end of the bag onto the device, clamp down and it sucks all the air out of the bag and seals it. It's so simple to use. I know you can get this from **Cabella's** at **1-800-237-4444** (you can get a catalog mailed to you at this number too) and I think **Sears** and **Wards** still carry it. It's called a "**FoodSaver**<sup>TM</sup> vacuum packing system".

Offered by [Mary](#).

FoodSaver also has vacuum sealers and supplies. The last bags I bought at K-mart were **FoodSaver** bags and not **Seal-a-Meal** bags. I think they are better bags anyway.

Offered by [Clipper](#).



# Troubled Times

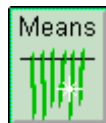

## Nitrogen

---

A **Mormon** website talked about wheat packed in nitrogen but the site didn't talk about how to get it. I know a person who is Mormon and works for the warehouse system they have based in Salt Lake. I asked him about it and he referred me to the local "cannery" as their called. I was also told that while some would say that wheat packed in nitrogen has an infinite shelf life, he wouldn't trust it more than 3 years.

The most important thing for me was that these "canneries" which are in most major cities, have bulk supplies at very reasonable prices for those who are stocking up regardless of faith. Therefore, you don't need to be Mormon to purchase from them. In addition, 80% of what they can, they grow, so you know where it came from. To get the location nearest you, look up the **Mormon's** under churches in your yellow pages and start calling.

Offered by [John](#).



# Troubled Times



## Dehydrating

---

Here is some dehydrating links from the Noahs ark page.

<http://muextension.missouri.edu/xplor/hesguide/foodnut/gh1562.htm>

I have worked up a pattern for a solar screen type dehydrator that is completely enclose that can be hung on some kind of a hook out in the sun. If anyone wants a drawn pic and instructions, let me know. I saw these for sale for quite a lot on a web site and decided to make my own. To make your own costs under \$10.

Offered by [Cynthia](#).

Where do we get the sun from? Consider using waste heat from lights, refrigerator, and cooking.

Offered by [Mike](#).

Excellent point, Mike. This simple food dehydrator could be used before the pole shift to prepare food, and after in low light conditions using the residual light you mention.

Offered by [Brent](#).



# Troubled Times



## Diatomaceous Earth

Diatomaceous Earth is the hard shells of sea creatures. These shells have sharp edges and tend to tear an insect up from the inside out. Diatomaceous Earth is not harmful to humans or other large animals because they can not do enough damage in our mostly liquid bodies to harm us. Mellingers sell 50 lbs. of Diatomaceous Earth for \$25.95 as well as many other gardening goodies!

Offered by [Roger](#).

When Diatomaceous Earth is sprinkled on the ground, on an ant mound, or mixed with grains, legumes, etc., it slices and dices the insects that walk through it. If you're planning to can or bucketize your own food, mixing in a cup of Diatomaceous Earth will help keep it pest-free. And it won't hurt *you* when you ingest it, 'cause the 'sharp pieces' are too small to cut you, you lucky guy. (In fact, many farmers deliberately mix Diatomaceous Earth with animal feed to kill internal parasites in farm animals. The Diatomaceous Earth in the animal feces even kills the fly maggots that invariably appear in the patties.)

*Scientists estimate that there may be as many as 12,000 species of Diatoms, each identifiable by their delicate, ornate shells. Diatoms are a dominant species of phytoplankton, ... This fine, crumbly substance is used in insulating materials, abrasives, ceramics, and in filtering and filling materials. More than 270,000 metric tons of it are extracted annually from a quarry near Lompoc, California.*

Diatomaceous Earth comes in at least two grades: Horticultural Grade and Food Grade. It's important to use only Food Grade Diatomaceous Earth if you're using it to store grains. If you want to use it on plants, *don't* get any on the flowers. It'll slice up the few honeybees we have left. And I don't recommend incorporating mass quantities into the soil. Earthworms are good things: You don't want to hurt them until you put 'em on your fishhook. Diatomaceous Earth is also effective against fleas, but again, take care not to let your pet breathe it.

*Diatomaceous earth has both a drying and irritating effect on many insects, including ants, roaches, fleas, snails, and slugs. It is composed of the skeletons of sea diatoms. [Horticultural](#) grade. Stock #381049 2 lb. bag \$4.95 (2 lb.)*

So, how many [Pounds](#) do you want?

5 lbs	(BPx)	\$10.00
10 lbs	(BP6)	\$16.00
50 lbs	(BP7)	\$27.50

Offered by [Mike](#).

There is quite an impressive [List](#) of uses for diatomaceous earth, among the ones we already know. It seems to do everything from genetic engineering to flea powder to water purification to colon cleansing.

Offered by [Pat](#).

OSHA: Diatomaceous Earth: A soft siliceous solid composed of skeletons of small prehistoric aquatic plants. Contains primarily silica. Silica: Group 3, not classifiable as to its carcinogenicity to humans (Amorphous Silica)

Glossary: Diatomaceous Earth: An earthy deposit of fine, grayish, siliceous material composed chiefly or wholly of the remains of Diatoms. It may occur as a powder or as a porous, rigid material. (terre de diatomées)

Diatomaceous Earth for dog's fleas: Diatomaceous Earth is a natural, non-chemical product. It appears to be a powder, but it is actually razor-sharp crystals to fleas. It blocks and cuts the [Fleas' Gills](#), and they die.



# Troubled Times



## Perma Guard

A recent quote from the **Bob Livingson Letter - Special Issue**.

I will share with you a grain storage idea that really works. It is a personal story.

*Many years ago we went into the rice fields of Louisiana and bought 2000 lbs of rice. It was brown rice with only the husk gone, not polished into white rice. Brown rice is an excellent, nutritious food and easy to store for long periods. We then bought a nontoxic and tasteless powder called Perma Guard (diatomaceous earth). We put the rice into metal barrels with brown meat wrapping paper next to the barrel wall and saturated the rice with Perma Guard. Perma Guard keeps the grain dry and dehydrates any bugs or insects that may get into the barrels. Stored grains have to be preserved with low moisture content. Well, we raised our children on nutritious brown rice that cost us ten cents a pound. We also shared the rice with family. It didn't require all that much effort, but it had long-term value. We still enjoy brown rice as perfect as it was 37 years ago.*

To order **Perma-Guard**,

Call: (505) 873-3061 or

Fax (505) 873-3261

**Perma-Guard, Inc.**

115 R10 Bravo Se

Albuquerque, NM 87102

Bag sizes come in 1 lb (\$4.90) to 50 lb (\$24.95). Apply one measuring cup full of Perma-Guard per 50 pounds of clean, dry grain. Mix thoroughly, making sure that a light coating covers all kernels. One lb. Perma-Guard makes 6 cups. One application good for 10+ years. Contains 14 trace minerals which when incorporated into bread, yield no change in flavor or texture.

Offered by [Mike](#).

I remember reading about some ancient civilizations where grain was found - still edible after thousands of years. This sounds like bull but I'm sure I read it. Can't remember where, which civilization or which grain.

Offered by [Craig](#).



# Troubled Times



## Aluminum

*Notice the chemicals in Azomite - hydrated sodium calcium aluminosilicate. How about aluminum chlorohydrate, under arm antiperspirant (more poison). Aluminum cookware is banned in some countries; also teflon also put on aluminum cookware gives off toxic fumes. Check out a search for aluminosilicate.*

**Ken Hickman**

Alumina (AL<sub>2</sub>O<sub>3</sub>\*) is present at about 11.35% in Azomite. An analysis says - *The alumina is not biologically available. It is bound to the silica and is an aluminosilicate. Sand, clay, most rock deposits, and soil deposits are primary aluminosilicates.* Based on this statement I don't consider Azomite to be dangerous. It does have some vital trace minerals that plants and human bodies cannot get just any place. Aluminum is the 21st most common element in the body. Our bodies are made up of about .00009% or about .06 grams of Aluminum. There is more Aluminum in the body than Cadmium, Boron, Barium, Tin, Manganese, Iodine, Nickel, Gold, Molybdenum, Chromium, Cesium, Cobalt, Uranium, Beryllium, and Radium. All of these are essential for the vital functioning of the body.

Aluminum shows up a lot in Enzymes. It is reasonable to assume that without adequate aluminum enzyme action would be suppressed. According to **Trace Elements, Inc. (TEI)** (high tech hair analysis lab), *When in excess, aluminum will have an adverse effect upon metabolism, often being associated with memory loss, confusion, and depression.* One then could ask - how do we end up getting too much aluminum? According to **TEI** lab Aluminum compounds are typically ingested in the form of intentional additives, such as: preservatives, coloring agents, leavening agents, etc. Other sources include processed cheese, spices, pickles and baked goods. Additional sources include: Antacids (most), Salt (some), Aluminum Cookware, Buffered Aspirin (some), White Flour (some), Treated Water, Baking Powder (some) Antiperspirants (some), Aluminum Cans, Vaccines (some). Things to avoid: Antacids containing aluminum as hydroxide. This is a major source of ingested aluminum. Cooking acidic foods in aluminum cookware. Inhaling antiperspirants, especially those containing aluminum chlorohydrate.

Offered by [Mike](#).

Just because Azomite contains some vital trace minerals that the body requires doesn't mean that Azomite is safe. Uranium ore also probably contains some essential trace elements, but are you going to grow your corn in it? Trace elements should be obtained from food sources, such as seaweed, which are known to be safe. Considering that Aluminum is found in large biological quantities in every plant grown in soil, including all food plants, we don't have to worry about not getting enough. The problem is in getting too much and the form that the Aluminum is in. The colloidal form found in plants is probably OK, but how about the elemental form found in aluminum cookware and cans (or Azomite)? Not all of the above elements are essential or vital for functioning of the body.

For example, every element above lead (Pb, atomic #82) in the Periodic Chart is radioactive and they all emit ionizing radiation particles. These particles damage both cellular structures and the chromosomes in DNA which leads to mutations and disease conditions. These include Uranium and Radium. Nickle in extremely tiny amounts is required, but like Aluminum, deficiency is not the problem. Soil is loaded with it. Cadmium, like lead, is bad news for the body. Read *Metal Ions in Biological Systems* by Helmut Sigel (1980) if you want to find out what even trace amounts of Cadmium can cause. Also, just because an assay performed on a modern human corpse reveals the above mentioned elements doesn't necessarily mean that the body requires those elements or in those quantities. It's just an assay report. No more. You're only considering those few enzymes that normally utilize Aluminum, but metals are part of every enzyme molecule. And there are tens of thousands of different enzymes in the body. The entire problem with metal toxicity is based on the fact that a toxic metal will replace the correct (normal) metal in that enzyme molecule and



cause it not to function in its normal role.

Offered by [Ed](#)



# Troubled Times

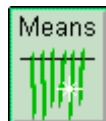

## Fluoride

---

I have been aware of water fluoridation and its implications for some years now and made a conscious effort to remove it from our lives. Now I feel it is time to pass the info on, though I'm sure most of you already know about this poisonous substance that is the waste byproduct from bauxite mining (for producing Aluminum). The powers that be found it too expensive to dispose of it as waste, so decided to delude us into thinking it was good for us, so now they sell it to us, Killing two birds with one stone so to speak.

**Ken Hickman**

I think everyone should be aware of the dangers of this product in regards to Fluoride.

Offered by [Jan](#).



# Troubled Times



## Infestations

---

We purchase about 25 lb. of rice a month and it is contained in what is known as a "rice box". In order to maintain the rice and to keep pest's away, a large bulb of garlic is used, it is wrapped in a single piece of cheese cloth and it is tied to a string and placed in the container. It has to be changed every month or so. Once I forgot and when there was about 4 lb. left in the container (it holds 55 lb.) I noticed that it was infested with bugs, little black ones with legs and little white worm like bugs. In sight of this I decided to try an experiment involving food. I removed the rice from the container and bagged it up. Proceeded to clean the container completely and let it dry.

As some of you may have guessed, I consumed the rice pest's and all over a period of 5 days. Having spent 10 years in the Army and being in as many counties I have consumed worse. I have tried it boiled, fried and steamed. I would suggest having plenty of garlic powder pepper and any thing else spice wise you like, because it seems like (mental attitude) it taste better even though I could not tell the difference in taste. And someone said that there are bug parts in everything we consume. I feel fine and have not noticed any change in my health. The first time was a bit hard to take but I managed to keep it down and everything was fine. I think it all boils down to knowing what you are eating. I figure I know I can do it now if and when it comes down to it.

Offered by [Lou](#).



# Troubled Times



## Store Well

---

I'm not a pro on this, but for leftover in the frig, guideline is a week, for frozen foods, 3 months, for canned or dried foods. I think they do not go bad in the sense that spoilage occurs, they start to become something other than food. Wine turns to vinegar eventually, but can last for centuries and still be wine. I would suspect that a bag of beans would be good 20-30 years later, as food if not 100% nutrients as at first. Seeds can germinate after years and years, and the criteria *there* is a lot higher! We're talking about living cells!

Offered by [Nancy](#).

My dad and grandfather sold canned goods. They have a 3 year shelf life where the food is guaranteed to be as good as day 1. The exception is tomatoes. The acid in tomatoes makes storing them in cans not great for long periods. The reality of canned foods is unless it is bulging, the food from a nutritional point of view is generally good for at least 10 years. That doesn't mean it tastes as good.

Offered by [John](#).

My sister from Texas wrote:

The shelf life of canned goods depends on the environment. A cool dry climate will let cans stay good for years. Hot muggy weather makes them go bad quicker. A can is not good if the top or the bottom of the can is domed out. If you eat the contents, you may get sick from bacteria that has grown after the can lost pressure. The best way to get ready is to store dried foods - legumes, rice, fruit, veges, etc. Every time I go to the store I spend a dollar extra and buy something to dehydrate. I have a closet full of zip lock bags in big plastic boxes ready to go. Most of it will not need cooking as who knows if this will be possible for awhile. Once something is dehydrated it is good forever as long as it stays dry and in a dark place. You can dehydrate anything. Lemons even taste wonderful as a crisp treat full of vitamin C.

Dehydrators are all different. We have had two brands. **American Harvest** makes a good one. Don't buy **Ronco**. American Harvest has different heat settings *and* a dryer fan. The fan is essential for good circulation. The settings are 95F for herbs, 105F for seeds and nuts, 135F for fruit and vegetables, and 145F for meat and fish. You just put the stuff on and leave it for a day or two and it dries. You can dry stuff whole or cut up.

Offered by [Mike](#).

This something to look into as it requires no power except the sun. **OHP**- None-Electric Dehydrator.

Offered by [Lou](#).



# Troubled Times

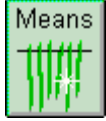

## Buckets

---

I found a good place to get five gallon buckets for free. These buckets are heavy duty with a rubber seal top that closes tightly. I have practiced using these for six months so far with great results. All I do is put whatever dry products (rice, pasta, potato flakes.) into the container with the little air absorber pack and its worked so far. I found these for free at local pizza shops and restaurants that carry pepperchinnis or pickles or cake icing. They throw these away in great numbers and I asked them to save them for me. I have received fifty so far and they are just like new. You clean them out with bleach to get rid of any residual product or smell and air dry for a day, ready to use for free. I have dropped them full from a third story window and some have the top dislodge but the buckets are fine and inside products in perfect shape. The places I have gotten a large supply from are Papa John's and Dominos Pizza.

Offered by [Bill](#).

Several days ago, I bought from a recycling depot, five large plastic barrels that had been used to store/import pickles. There are hundreds of barrels there, and we'll be getting more. They each have a screw top and hold about 70 gallons!! And the price - \$7.00 each, Canadian \$, which is about \$5 each American!! We are going to use one for a rain barrel, one for a shower at our cottage property (pump water up into black barrel, wait for sun to heat - voila, warm shower).

Offered by [Cass](#).



# Troubled Times



## Cans

---

My dad and grandfather sold canned goods. They have a 3 year shelf life where the food is guaranteed to be as good as day 1. The exception is tomatoes. The acid in tomatoes makes storing them in cans not great for long periods. The reality of canned foods is unless it is bulging, the food from a nutritional point of view is generally good for at least 10 years. That doesn't mean it tastes as good.

Offered by [John](#).

I started researching canning equipment suppliers. I found one which looked promising and emailed a request for a manual #10 can sealer and supplies. I just got a reply.

Date: Mon, 16 Feb 1998 14:20:16 -0800  
From: [wellsan@lightspeed.bc.ca](mailto:wellsan@lightspeed.bc.ca) (Ken Statham)  
Subject: Re: Can Sealer

Steve, we sell the can sealer for \$695.00 CDN and the can plus end for \$1.55 ea. There would be an approx 4-5 week delivery for the sealer. We accept Visa or M/C by phone or fax. It is important for us to know whether the intended product is "wet" or "dry" so that we can ensure the inside coating is correct. Shipping is extra and we usually utilize UPS standard service "collect. Once you have reviewed this info, pls let us know how we may be of further assistance. Thank you for visiting our website. Regards, the Tinman.

Offered by [Steve](#)

We need to cover as many angles as possible. It's vital that as well as producing our own food after the Pole shift, that we *also* have supplies at hand to feed us until such time that we're able to be fully self-sufficient. I would actually aim to store supplies that would last out for several years in order to cover the more pessimistic estimates. Whose to say that our initial attempts at gardening and farming utterly fail due to factors outside of our control, such as localized toxic poisoning. Simply put, I think we *must* do both, and with equal emphasis. The Aftertime is going to be stressful enough as it is, but consider the relative peace of mind someone would feel if they were able to work hard all day producing food for their future, safe in the knowledge that in the meantime they had guaranteed food waiting on the table. There are quite a few resources on the net for storage supplies, AlpineAire Foods is one of the best I've come across so far.

**AlpineAire Foods**  
FOOD STORAGE CENTRAL  
P.O. Box 561  
Salem, OR 97308

Offered by [Paul](#).



# Troubled Times



## Plastic Containers

---

I store 700 gallons of distilled water and rotate supplies since the safe "life expectancy" is supposed to be around a year so says the Mire's store manager when asked of its manufacturing lifetime and plastic container. Can you imagine the use of storing anything in glass or ceramic during a 9.5 Richter earthquake. I think not. There goes your water supply. My concern is also safety of plastics for storage. But they do seem like the best choice for safety of the contents during extreme jarring and juggling about.

Offered by [Bill](#).

I read somewhere that the plastic containers leach into the water. In my search to verify that I came across this article.

Offered by [Pat](#).

*Most people don't know this, because it is not very publicized, but plastic leaches into the foods that are stored in it, especially oils. It may sound far fetched, but I have seen programs on this, and scientists have proved it. They don't know which plastics are harmful and which are not, therefore, all plastics should be avoided when it comes to food storage, and cooking. If you cook in the microwave, use glass or ceramic. Always try to use glass or ceramic for all food storage.*

**Anna B.**

At the **Country Store** and other preparedness sites, there is an item called Gamma-seal lids. This is a screw on adapter and screw on lid that fits most 5 gal plastic buckets. They sell for about \$9.00 each. Place your prepackaged food items in the bucket, screw down tight and it is as waterproof as possible. I have read where you should line the bucket with heavy duty plastic bags to ensure the food does not pick up any contaminants from the plastic bucket.

Offered by [Mary](#).



# Troubled Times



## Plastic Jugs

---

The fastest way to start water storage (if you think you can trust your supply), after every gallon of milk you drink, thoroughly clean the plastic container and refill with water. Place the cap back on and shrink wrap it. Not a lot but until one can save the money to purchase mega-gallon storage facilities, one person could safely store at the rate of one gallon per week. This particular amount will at least help that one person with water rations.

Offered by [Brian](#).

Water in a plastic container has a shelf life of 6 months. It is virtually impossible to prevent bacteria growth in water placed in a plastic container. This information comes from a food technologist. You should add chlorine to it prior to drinking if it's longer than 6 months. Your stomach will thank you.

Offered by [John](#).

Water in a plastic container will have an indefinite shelf life if you prevent bacteria, etc from growing in it. Keeping it covered and cool will do it most of the time, but adding a little colloidal silver is cheap , fast, and very effective.

Offered by [Ed](#)

The big problem with this type of plastic container is that it probably won't last the G-force of a pole shift unless uniformly supported on all sides. As far as bacteria are concerned, being passed in front of an ultraviolet light will kills bacteria. There are other methods just as effective.

Offered by [Mike](#).





# Troubled Times

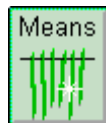

## Reserves

---

Granted being able to produce your own food stuffs is the way to go; however for the first few weeks after a disaster you will be in shock and it will take all you can do to carry on, that's when stored food comes in handy or if you have a crop failure your first year.

Offered by [Mike G.](#)

For those who might be interested this is a **Food Storage Planner** by the Mormons. It will give you an idea of how much is need for your family. **Revelar, Inc.** home page I think that it could be of help.

Offered by [Pat.](#)

This is year 2 in hydroponics for myself and you better have at least a 3 month supply of "shelf stable" food, because it takes at least that long to get things going and that really is a *minimum*. This assumes you do everything right. Hydroponics is chemistry and it takes practice. I strongly suggest you start practicing *now*.

Offered by [John.](#)



# Troubled Times



## Concrete Culverts

---

What If we were to take some 3 or 4 foot sections of concrete culvert, sink them upright in the ground on small concrete pads? These can then be filled with supplies and a manhole cover or concrete lid fitted on top and buried. The tensile strength of culvert is very good as are the chances of the supplies inside. As far as fastening goes how about drilling 4 holes in a cross pattern into the base of the pipe, then inserting rebar through the holes. Then, pour a pad, wait about 10 minutes and plunk the pipe down followed by pouring another 3 inches or so of concrete inside and covering the rebar cross bracing.

As far as water I plan to coat the entire pipe with a rubber waterproofing compound most commonly used on foundations. The lid itself is probably the most crucial of the issues facing this idea. I know that these sections of culvert are commonly held together by rubber gaskets and I am still working on the problem of fitting a practical lid to it. The lid must be light enough for 1 person to lift but strong enough to resist the forces of nature. The items inside must also be protected from water in case the integrity of the pipes is compromised, possibly by wrapping them in a thick layer of plastic and filling any spaces with an expandable foam product such as **Great Stuff**.

Offered by [Linda](#).

This sounds like an excellent Idea to me. I have a couple of additional thoughts. The culverts should be attached to the concrete pads, possibly while the pad is still wet. Or maybe it would be easier to seal one end of the culvert with concrete and steel mesh before lowering it into the ground. I think that your manhole cover should also be sealed so that it is water tight, possibly with foam or a rubber compound. **Great Stuff** is an excellent foam sealer. I've used it myself. But I'm not sure how it stands up under water pressure or even seepage. Your fastening with rebar idea seems feasible also. No matter what sealers you use, best to play it safe and individually wrap your stored items in plastic, and then I would group wrap everything. When they bury a time capsule for 20 or 30 years, what type of seals do they use on those cement cylinders? Might be worth looking into.

Offered by [Brent](#).

To enhance the viability of this storage method, I would think one should bury the culvert using the concrete/steel mesh for sealing the bottom. Additionally, it should be buried in a gradually sloped hill with drainage rock and a 3 inch drain pipe in the bottom as well as up the sides of the hole to prevent a seepage problem that could destroy the contents. The 3 inch drain pipe should be ditched out and the ditch refill with drain rock to prevent surface contamination. *Do not do this in the lowlands.*

Offered by [Michael](#).



# Troubled Times



## Liquefaction

---

The ingenious technique you choose to make the base could be used to make a lid. Seal off a section of pipe at one end as you described. Turn it upside down have a large eyebolt embedded in the center top. Build a three pipe A-frame and use a chain hoist, block-en-tackle or cable puller and lift fit the thing in place. Build the unit such that the top is one foot or more below ground level. Tie a bright colored 8 feet or more polypropylene rope (florescent in UV if possible) to the eyelet on the lid. Cover the top with dirt and let the rope lay on the ground. The wind will blow it. It will float to the surface of the water. It will float to the surface of liquefied dirt. Hopefully some of the rope will be visible to discover where to dig. The area could get more dirt blown in or some dirt blown away.

My only comments have to do with needing to protect against possible liquefaction of the soil in the vicinity. In other words tie it all together so it doesn't separate when the strong shaking starts. Also, provide a way to minimize water damage. Expect the area to flood or be sometimes under water, water to get into the cracks and through the holes in the manhole cover. We will get near constant rain after the pole shift. After the pole shift, to get it open you can use the same A-frame and hoist or dig down beside it and pound a hole in the side with a sledge hammer. By the way I think these sections of pipe will need some way of holding them together other than slip joint friction. Pins or a strap over the joint or some other way of holding these joints needs to be provided for.

If the soil liquefies due to the shaking and the container and it's contents is lighter than the dirt it displaces, then it will float to the surface or above the surface of the ground. Like a cork in water. This may allow the unit to be blown apart from the wind or things hitting it. I recommend you store heavy things in this storage space or make the unit able to hold together if it pops up above the surface of the ground.

Offered by [Mike](#).



# Troubled Times



## How-To

---

The following describes one way (definitely not the only way) to store beans and seeds for later food use. This method should work for seeds you plan to plant and grow up to a limited storage time of 2-3 years or less depending on temperature.

Purchase 5 gal plastic paint buckets with lids (about \$3/each), and heavy duty Compactor plastic bags (about 2 Mil) at your local discount building supplies store (Home Depot, HomeBase ...).

If you are worried about plastic absorption into the food then use Mylar rugged food grade liner bags 4 mil.

Purchase some Diatomaceous earth.

[Line the Bucket](#) with a 2-4 mil plastic bag and pour in the seeds or beans until the bucket is about 1/2 full.

Add about 1/2 a cup or less of [Diatomaceous Earth](#) and stir it in completely. The recommended amount is 1 cup for every 50 lb. of seeds or beans. Pour in more seeds or beans until the center forms a mound just even with the top of the pail. This will go down to about 1" below the top once it is stirred.

Pour in a 1/2 cup of Diatomaceous earth and gently [Stir It](#) in. DE needs to mix with all of the seeds or beans uniformly. One easy way to do this is to put some seeds and the appropriate amount of DE in a closed bucket and shake it until mixed, then pour this into the storage bucket and repeat until storage bucket is full. Mix at the rate of about 1 cup (1/6 lb) of DE for every 50 lbs of grain or seed.

This step is optional, do it if you think it is needed. Add 3 table spoons or more of [Silica Gel](#) (a drying agent some times sold to dry flowers, I got it at Michael's) to the center of a small square of fine weave cloth. I used 8"-10" square pieces of old bed sheeting. Lift the corners and bring them together, twist and tie with a stainless steel or copper wire (I believe Iron will rust over time and may rust through). Cut off the excess wire and bend the pig tale back so that it doesn't puncture the cloth.

Place the bag upside down in the center with the excess cloth fanned out, to give an extra [Layer of Cloth](#) between the silica gel and the seeds or beans.

Close the 2-4 mil plastic bag so as to not trap any air. This can be done by holding down on the bag close to the seeds or beans on the top then twisting it. Tape with some black plastic [Electricians Tape](#) with several turns. Copper or stainless steel wire can now be used over this tape to tighten it so it is even more air tight, and the tape will not relax over time. Use pliers to get it tight. Cut off the excess wire and the remaining pig tail, bend it around the tape. Add another layer of black electrical tape over the top of the wire. This keeps the wire from punching a hole in the plastic bag.

Lay the round taped area of the bag down on the seeds or beans and push it flat. The seeds or beans will move around and make room for it. Check that there is enough room for the lid to properly close. If needed push the seeds or beans around to make it level. While holding the excess plastic on the top of the

bag away from the edge of the bucket put the top on. Use a heavy weighted [Rubber Mallet](#) to pound the lid on. Caution: Don't stand on the lid to close it. It's too easy for the bucket to tip over with one possibly getting hurtt from the fall. I almost fell off, several times on my first few buckets using this method. Label the container as to its contents using a permanent marking pen. Put a clear plastic tape (box closure tape) over the top of it so it doesn't rub off. Even permanent marking pens will rub off on this type of plastic.

When you're ready to open it, use a [Special Tool](#) to get it open (can be purchased at building supplies store). This tool has several shapes and sizes depending on where you get it. It basically has a metal lip, that pries up the edge of the lid without damaging it. No broken finger nails, etc.

The number of pounds of raw beans or seeds that I was able to get in a 5 gallon bucket is listed below for Organic seeds. This weight does not include the bucket, which weighs about 3 lb., lid included.

<b>Grain of Bean</b>	<b>Pounds</b>
Barley	28.5
Garbanzos	35
Brown Rice	31.5
Adzuki	33.5
Soy	31.5
Winter Wheat	36
Kamut	35
Peas	35
	<hr/>
Average	33.25 lb.

Notes on other options: **Seal a Meal**, or an electric iron could be used to seal the plastic bags. Food grade 4 mil Mylar (metalized) plastic bags could be used. Iron fillings (**Fresh PAX**) in a bag could be used to remove the oxygen for further protection. These can be purchased at **Major Surplus and Survival** 800 441 8855 or search for a better price on the web.

Offered by [Mike](#).



# Troubled Times



## Ice House

---

From the *Leelanau Enterprise*

Before electricity and refrigerators kept food cool and safe, men toiled long hours "harvesting" ice from lakes and rivers in the winter to use during warmer months. Most harvested ice in January, February and early March. The work was done with tools found on any farm. Small operations used a saw, ax, ice tongs and a few men. An average block was 24 inches long and wide, about 12 inches thick and weighed between 125 and 175 lb. Workers would take the blocks to a specially designed "ice House" where they would be stacked on top of insulating sawdust. Sawdust would be packed around the sides and on top of the ice pile before the ice houses were sealed shut. These buildings had well ventilated eaves. Many had the sheathing or walls on the inside so that they wouldn't "pop" off from the pressure of the ice and sawdust packed inside.



# Troubled Times

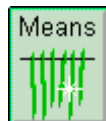

## Foil Coil

---

There is an antenna right under the label on the front of a bottle of St. John's Wort. Manufactured by

**Upsher-Smith**  
Laboratories, Inc.  
Minneapolis, Mn 55447

The antenna is like a printed coil, laid flat, like a spiral of metal foil, only in this case in a square shape. Upsher-Smith has a web site. From the research I've done, this coil delays food from spoilage, up to three days on milk at room temperature. In three experiments this has proved to keep milk from souring three time longer than the same bottle with the antenna removed. I've have two of these bottles. I removed the printed coil from one. Then I put milk in both bottles. The one with the coil didn't sour.

Offered by [Bruce](#).

I talked with Rob Lovenger at **Upsher-Smith** in the marketing department (800-328-3344). He was unaware of the antenna function on the bottle other than thinking it had to do with anti-theft in the store.

Offered by [Steve](#).

Why don't you try making your own mini-coils with very thin gauge wire, cementing them in place and perhaps lacquering over that. Even a single strand from #20 or 22 gage ought to work OK. The ends of each individual coil should not touch. The individual coils should be placed one inside the other, but none of them touching each other at any point. These coils will capture cosmic frequencies and harmonics that may or may not be the correct supporting frequencies of the foods that you are trying to prevent from spoiling. You'll have to experiment to see what size coils provide the greatest activity.

Offered by [Ed](#)



# Troubled Times

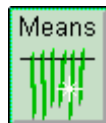

## Theory

---

Following the end of WWI and throughout the 1920's, a Russian engineer living in France named **Georges Lakhovsky** developed an unusual theory about the nature of cellular-level organization and biological activity. He theorized that various structures within a cell's nucleus such as the genetic strands of DNA, with its attendant protein sheath (along with the cellular fluid) possessed electrical/magnetic attributes that we normally associate with electronic circuits: specifically radio circuits.

He proposed that the nuclear strands of DNA functioned exactly as the coils of a radio oscillator circuit and possessed the electrical characteristic of self- inductance. He further argued that since the DNA strands were physically separated from its surrounding protective sheath , that these two elements acted like the two plates of a capacitor and possessed the electrical characteristic of capacitance (the intracellular fluid possibly playing the role of the electrolyte found in a conventional electrolytic capacitor). He proposed the revolutionary idea (at the time) that organic, biological substances possessed electromagnetic characteristics and could conduct electrons (current) and exhibit the property of conductance. Finally, he reasoned that any organic substrata, not being a perfect conductor, is going to exhibit some resistance to the flow of electrons and therefore the electrical characteristic of resistance is also present within this structure.

These 3 characteristics, Inductance, Capacitance, and Resistance (or inversely, Conductance) combined in a favorable configuration can exhibit a phenomenon of physics known as resonance and create a type of radio circuit called an oscillator. Assuming that the values of inductance, capacitance and resistance are fixed, an oscillator will continually produce a sine wave of a specific frequency. All oscillators have a feedback loop in which a portion of the "output" energy is returned to the "input" side of the circuit. This feedback of energy allows the oscillator to reinforce the resonance of the circuit and continually produce sine waves at its specific resonant frequency. If you change one of the parameters that affects the oscillation rate (E.g. the inductance, capacitance, or the resistance) , then the frequency of the oscillation will change.

Offered by [Ed](#)





# Troubled Times



## Lakhovsky

---

Lakhovsky first experimented with plants and later confirmed his theory with animals and finally people. In 1924, he intentionally inoculated 10 potted germanium plants with a tumor-causing disease (*Bacterium tumefaciens*, a plant cancer). To one of the potted plants, he attached a single coil of heavy copper wire (ends not connected), holding it in place with a wooden stake stuck into the pot. The coil was about 30cm in diameter and was fashioned around the center of the plant, about 8 inches up from the soil. All of the plants had identical care and were exposed to the same lighting conditions. Over the next 60 days, the 9 inoculated germanium plants without the coil withered and died from their tumors. The single plant with the attached coil, threw off its tumors in about 30 days and continued to thrive and grow healthy. Why?

According to Lakhovsky, the coil acted as an antenna and was able to capture a portion of the frequency spectrum of cosmic waves that continually bombard the earth. These captured cosmic radiations (of the correct frequency range) were able to induce or reinforce favorable oscillations in plant cells. All living cells (plants, or animals), in a healthy state, oscillate at a characteristic frequency and maintain a condition that Lakhovsky referred to as equilibrium. Pathogenic organisms (disease-causing bacteria, virus, etc.) oscillate at a different frequency and if brought into close proximity to those healthy cells, will adversely affect the frequency of the oscillations of those cells and introduce a state of disequilibrium. Lakhovsky essentially viewed it as a war taking place between the oscillatory energies of the pathogenic microbes and the host cells. If the host cells were sufficiently 'swamped' by the invading organisms' oscillations, then the host cell would succumb to the mounting disequilibrium and die off.

If the resonant oscillations (the characteristic, healthy frequency) of the host cell could be stimulated or reinforced, then the host cell could overcome the disequilibrium and overpower the oscillations of the pathogenic organisms, thus defeating them. In Lakhovsky's plant experiment, the coil was able to capture cosmic radiations of a specific band of frequencies which was able to reinforce the healthy, characteristic resonant frequency of that germanium plant cell. Lakhovsky later constructed a generator that could produce a wide spectrum of high frequency waves that could simulate the effects of captured cosmic radiations, but at much higher power levels. With his multi wave oscillator, Lakhovsky was able to stimulate diseased cells back into a healthy state much more quickly than depending on cosmic radiation alone. However, (and this is important), if coil antennas of the correct size are employed, cosmic radiation alone will stimulate the diseased cells back into a healthy state (in people or plants); it just takes longer.

Offered by [Ed](#)



# Troubled Times

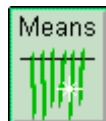

## Books & Articles

---

Lakhovsky laid out all his theories and experimental results in a book titled *The Secret of Life*. It was translated into English and came out in September, 1939, only to go completely unnoticed due to the outbreak of WWII.

Offered by [Ed](#)



# Troubled Times



## Canned

---

Canned foods have extraordinary shelf life. When it comes to vegetables and fruits, they are certainly edible for 10 years or more. The exception to this rule is fruits and vegetables that are acidic such as oranges and tomatoes. The acid in these foods eats at the cans. If you store them long enough, they will eat right through them.

A USDA certified Can Flow Rack, that holds 162 #10 cans or 216 #5 cans, is 35" long, 35" deep, and 71" high, weighs 60 lb., with aluminum construction is available from **Hubert Mfg.** for \$495. Call them at 800-543-7374 It can be loaded from the front or rear. Angle guides provide easy access for product selection and inventory rotation and control. Lifetime guarantee against rust and corrosion.

Offered by [John](#).

The new types of cans we get in South Africa are coated with an anti-corrosive, so these cans can be left in the fridge longer when opened. I do know that you should be very wary of consuming food in a can if the lid is bulging.

Offered by [Ray](#).

**Hormel** main office stated that all there canned goods have unlimited shelf life if they are in good shape. (no dented or bulging sides). I always smell and inspect anything I open just to make sure.

Offered by [Bill](#).



# Troubled Times

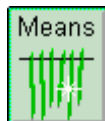

## Date Codes

Here is one of Hormel's codes. Their packing code is a letter followed by five numbers. The letter is their plant location and the numbers are the dating code in a MM-DD-Y format.

**Example:** A code of G07048 decodes to mean:

G = plant location

07 = July

04 = The fourth day of the month

8 = 1998

The can was packed July 4, 1998 at plant location G. There is also a closed dating code used by some food manufacturers. In spite of the fact that increasing numbers of food processing companies are moving to open dating it is not yet universal. For those products that do not come with a plain "best used by" date it is still possible, albeit with much more difficulty, to determine the rotation period for that specific product. For processors to move their products in interstate commerce it must exhibit a packing code. This allows them to easily track their product for purposes of stock rotation and in the event of a recall.

These packing codes are usually a series of letters and numbers that indicate dates, times, and sometimes places of manufacture. These dates are not "use by" dates, but the time the container was actually filled. As they are not really intended for general public knowledge these codes are frequently unique to a particular processor and are not commonly published by them. Some processors use a system where all the days of the year are listed 1-365 (366 for leap year) as the first three digits in the code. This number is then followed by a single letter such as "B" and then by a single digit that represents the year.

**Some Examples** of this might be:

Packing code Date packed

045B97 February 14, 1997

101H98 May 1, 1998

134K96 July 4, 1996

252U98 October 31, 1998

Offered by [Jon](#).



# Troubled Times



## Best By

---

Although there are some twenty States in the U.S. that have food product dating laws the Federal government has little regulation concerning food product dating except for infant formulas and some baby foods. It does, however, require that if a manufacturer puts a calendar date on a food product it must also put wording to the effect of "use by" or "best before" next to it to explain what the date means. This is called "open dating" which is to say that it is a plain, easy to read calendar date rather than "closed or coded dating" that must be deciphered. Another date also commonly seen is the "sell by" date. While not as useful for food storage, it does have importance for day-to-day fresh food purchases.

Because the Federal government has so few food product dating standards manufacturers use their own to determine acceptable shelf lives. For the most part, they are based upon changes in texture, appearance, taste and cooking qualities. When a food item begins to exhibit signs of aging that would make it unappealing to customers then it is considered to be at the end of its marketable shelf life. Look for statements such as "use by", "best if used by", "best if used before" or similar wording to find this date. For shelf stable and frozen products it must include both the month, day and year. These dates are useful for determining how long a product can be retained in the storage program before it should be rotated out.

Offered by [Jon](#).



# Troubled Times



## Winter

---

After studying this topic I've come to the conclusion that to make it in the winter one must hunt. People who did that are saying that:

1. Day is too short to collect food versus hunting
2. Energy expenditure is too high just to keep the fire going and other simple tasks.

If somebody is going to be cut off from supplies must know basic hunting skills.

Offered by [Chris](#).



# Troubled Times

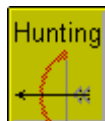

## Practice

---

All rural areas have local slaughter houses. From 8th grade to 12 grade I volunteered at a local slaughter house in my area. What can I say, I had a fascination for knives, really good knives and I wanted to be able to handle them.. It was a wonderful experience. If you explain that you admire their work most are willing to teach you. I learned to gut, clean and skin all commercial animals. Then I used these same skills to dress small game hunted by members of the family. You need to have a little experience before the skills are used for life and death. It's also good to know how to cure meat. I have thought about smoking for fish and meat but can't seem to get around the smell that might invite unwanted guest. I don't think we will have access to much salt in large quantities.

Offered by [Pat](#).

Hunting is not a skill you acquire overnight. Animals don't survive by being stupid, especially after a disaster. Game will become scarce because they will be hiding. You need to start now learning about wildlife and hunting skills; also learn how to clean and care for your game. Practice now while you have the chance, you don't want to wait till your hunger to start learning how.

Offered by [Mike G](#).



# Troubled Times



## Fish Net

---

There are 5 ft radius Hawaiian throw nets like you see pictures of the Tahitian kids throwing off the reefs. *very* easy to catch protein of all sorts. Small fish, crayfish, large fish. Fish nets are probably the *most* efficient way to catch protein. A mono-filament light weight gill net will be the most efficient way to catch larger fish. The source below has a catalogue for all types of nets and traps - mosquito netting, gill nets, cast nets, trot line setups, animal traps, trellis nets, seines, fish traps, fish hooks, etc.

### **Memphis Net and Twine Co, Inc**

901 458 2656 Voice  
901 458 1601 Fax

2481 Matthews Ave  
PO Box 8331  
Memphis TN 38108

Suggestion from [Jack](#)





# Troubled Times



## Fish Trap

---

A way to easily catch fish is to use a 2 liter bottle. Cut the very tip off (far enough to catch the size fish you want) then cut the top third of the bottle off, turn it upside down - facing into the bottom portion of the bottle -, then punch holes through the bottle where the edges meet and thread string or leather or something through the holes and tie them off. Put bait in if you want, I've done it successfully without, and fill it with water, tie a string somewhere to attach it the shore and set it in the water. The fish will swim in but will be unable to swim out. You can just leave this in the water, and come back at dinner time, the fish will still be alive. You can also do this by weaving a basket out of twigs, making a big opening and a small neck like a vase and making sure the twigs stick into the basket so that anything trying to escape will get poked by the twigs, but going in is smooth. You can leave this kind of trap in a tree and catch birds, or put it in the water and catch fish.

Offered by [Ryan](#).

We have a mouse trap like this, made of wire mesh and wire prongs, as I hate to kill anything, we catch them and then release them into the bush away from housing development.

Offered by [Jan](#).



# Troubled Times



## Boat

---

If you are to live by a freshwater lake I would recommend netfishing which is the most effective fishing method and doing this from your small plastic jolly boat (**Pioneer** boat) purchased before the pole shift which is solid and will survive. It's easiest to get the fish when able to go mid-lake. You should also try an Otter which you can either go along the shore with or use in the boat. The Otter is in many Norwegian small lakes forbidden, as it is too effective. A fishing-otter is not an animal! It's a board with a few hooks and it is connected to a fishing line which you drag along the shore or after the boat. The board has an angle so that when you pull the board forward through the water it will tend to be pushed away from you. I can't find any pictures or documentation of it, but go to a fishing store and buy one. It's a cheap thing. Bait-fishing is also quite effective. Then you can give the worms to the fish instead of have to eat them yourself. Maybe a stabile canoe might be an alternative as it is lightweight and transportable by using a wagon made of bicycle wheels. Then you can roll the boat to the next lake or to the ocean post pole shift, as I have planned to do. Fish during troubled times have often have saved Man.

Offered by [Erik](#).



# Troubled Times



## Hook & Line

---

If a person doesn't have access to a boat or canoe for fishing the middle of the lake, and doesn't have a net, then what is a person to do? I plan on having at least one spool each of 4 lb. and 6 lb. test fishing line, an assortment of hooks - 3 packages of 3 sizes each, lead fishing weights - a small dispenser pack of assorted weights is inexpensive and easy to carry, a stringer for the fish, and a small tool for extracting the hook if the fish swallows the bait. All of this can be carried in a sandwich size ziplock baggie, and weighs very little. As for a fishing pole, any small tree limb about 1/4 diameter or larger will do the trick, just ask Huck Finn!

Another alternative I'm contemplating is a small, lightweight telescoping fishing rod, and reel generally used by backpackers. A fancy one with a fairly nice spinning reel runs about \$25. I also just saw an "everything you need to go fishing" kit at Walmart the other day. For \$19 you get a telescoping rod and reel, line, hooks, a fish stringer, weights, bobbers, and rubber worm bait. And of course you would use any of these fishing setups from the banks of the lake, pond, or river. Bottom fish for Catfish, or Carp. Even Trout like to go for worms as bait. Don't have any worms? Any large insect that you can stick on a hook will work for bait, and it beats eating the insect for dinner!

Offered by [Brent](#).

Dynamite works well! So do blasting caps, the only problem currently is that the Fish and Wildlife department take a dim view of it for some reason.

Offered by [Steve](#).

Jigs will be the best lures. Order a jig lead mold and thousands of hooks, due to snags and break offs. Lead can be acquired from the junk yard. Buy a Penn Reel or similar model. All the same type, spare parts will be sparse. Ande tournament line is one of the best. Your line is the weakest link. Learn the knots, with out the knowledge your meal will swim off. Spray reels with WD - 40 or substitute to prevent parts from freezing. Plus don't forget feathers and plastic pieces to dress the ends of the jigs. You can lose 10 jigs on a day fishing trip, remember you are planning for 12 years.

Offered by [Robert](#).



# Troubled Times



## Bait

---

When my brother and I used to go catfishing, he would go out to the area we were going to fish several hours beforehand with a can of dogfood. He would punch several holes in the can, tie a stout line to it and toss it into the pond, then tie the other end to a stump, bush, or rock on shore. The fish were attracted to the dog food leaking from the can and would congregate. We caught Catfish by the dozen! If you don't have dog food, all you need is something that gives off a pungent odor, and you don't need a can. Any type of meal leftovers will work just as well, and you can place this in a burlap, cotton, or cheese cloth bag to throw in the lake.

Offered by [Brent](#).

My brother showed my oldest son a similar trick, often used in deep sea fishing, called 'chumming'. He caught a couple of small bluegill (which are overabundant in this lake anyway), chopped them up, and spread them over about a 10' square area. He then placed a trotline out with a small piece of bluegill as bait. About 15 minutes later he caught an 8 1/2 pound channel catfish!

Offered by [George](#).



# Troubled Times



## Fish Hooks

---

To make a bone fish hook at its strongest, you will need a rib bone, some fresh rabbit or other small game tendons, and a (small game) tooth. First you carve the bone to the shape of a hook, but with a little wider curve. (Note: use a knife and not a grinder as a grinder will produce cracks inside the bone and it will break easily.) When this is done, break the tooth so you can get a small barb. Hold that on the inside of the bone hook and proceed to wrap the tendon (fresh and slightly moist) around all the hook leaving exposed bone at the top of the hook so you can drill or burn a hole in it for your string. In wrapping the tendon on the hook you should do it so the tendon goes on as flat and smooth as possible so when the fish bite the hook will set. Hang this up in the sun (or by a grow light if there is no sun) to harden the moist tendon. Now you are ready to go fishing. One good sized moose bone can make about 30 fish hooks.

Offered by [Matthew](#).



# Troubled Times



## Carp

---

I grew up along a river, but didn't ever get the fishing bug, but I did hear some rumors from a friend who did fish. They said that you are supposed to be able to prepare carp and actually be able to eat them. I take this as a total rumor. Every attempt that I've seen of this has evidenced wrinkled faces and a barely eaten fish in the compost. Anyway here is the "supposed" preparation method. Do *not* clean a carp like a normal fish! Pack it in river bank mud/muck and bake it on a rock or something around the fire. When the mud hardens and you think your carp is finished, knock or scrape the mud off and remove the skin with the mud. Eat it right off of the bones (lots of bones, so be careful) and avoid the mud vein (don't know where it is so be careful again).

If anyone else has heard of a method to prepare these flavor-demons then please let me know. Carp are common in my area. Starve or carp is one tough decision. I'd eat the worms first Carp can sometimes be caught by hand so in a rough spot they might fill your belly, but might empty it just as well if you aren't careful. The trouble is they are big fish usually and seem to be somewhat tempting until you touch it.

Offered by [John](#).

To make common carp more edible: Have a container of clean water large enough to hold your fish and plenty of salt, throw the salt into the water and soak the (live) carp in the salt water. This will make the carp purge itself of the mud. This may take awhile (you may even need to wait until it drowns), but the wait will be worthwhile. Clean the carp *thoroughly* and stuff with rice mixed with onions, garlic, ginger and mixed herbs (or your own combination), heavily flour the outside of the carp and bake or fry till outside is crisp and inside tender, then peel the skin off and enjoy your meal. If you are still not happy with the taste pick the meat off the bones and pickle in vinegar, salt and peppercorns (black or white), or experiment with other ingredients such as chili.

Offered by [Jan](#).



# Troubled Times



## Crayfish

---

Here's how my friend made our crawdad trap. He took a rectangular length of chicken wire, and attached the ends to make a cylinder. He used bailing wire, but in a pinch you could use strong fishing line. Now, with another length of chicken wire, you need to cut triangles large enough to shape into cones that will fit on each end of the wire cylinder, wide end out, narrow end pointing into the cylinder. Cut the pointed tip of the cone to make an opening approx. the size of a Quarter/half dollar, or 1 inch to 1 1/2 inches diameter. Now attach your cones to the ends of the cylinder, both narrow ends of the cones pointing to the center of the trap. Now, lay your trap on it's side,(so it could roll), on the top of the rounded surface, cut a large square opening. Save the piece you cut out! Re-attach it on one side at each corner with wire. these are your hinges. on the opposite side, use a piece of wire for a "latch".

You now have a "trap door" to remove all the crawdads you've caught. To bait the trap, use fishing line, twine, or whatever you have to hang the bait to about the inside center of the trap. You can place leftover meat/grease scraps in a makeshift bag, or even hang it from a hook. The idea is for the Crawdads to "Smell" the bait, not grab it and eat it. It's an attractant only. Attach rope to each top end of the cylinder, and lower the trap into the water. For swift water, attach the other end of the rope to a tree or rock, etc. In calm water, you can attach the other end of the rope to a plastic jug, with lid on for a marker buoy. The crawdads will be attracted to the scent of the bait, crawl down the cones into the cylinder, and be trapped. We let the traps sit for about 3-4 hours before we checked them. On our trip, we averaged about 50 a night, and boy were they tasty!

You have to cook crawdads like lobster - you drop them into boiling water while still alive. This has something to do with toxins being released in their bodies after they die. I not sure of the specifics. I didn't want to test the theory, so any of the ones I found dead in the trap, I discarded. To keep them alive while we were getting the Dutch Oven of water to boil, we simply filled one of our coolers with lake water and dumped them in. Once the water boils, we would put seasoning in the water. They sell a packet of spices called "Cajun Crab Boil" that we would dump in, but we figured out its just garlic, onion, and cayenne pepper. So, once the seasonings get mixed in, keep the water at a slow rolling boil.

Grab 10 or 20 crawdads from your storage container, either with gloved hands or a colander (watch those pinchers!) Toss them into the water, let boil about 5 minutes or until they change color. Cooking time is approximate because they vary in size, but when they're done, they will get lighter and pinker in color. When they're done, lay them out on some cloth to dry and cool down a little. When their cool enough to handle, grab the 'dad by the middle, and break in half. Scoop out the meat from the tail (like lobster), and if the pinchers are big enough, snap them in half, and scoop out the meat. They're also great dipped in melted butter, or any number of sauces that you would use for shrimp or fish, although post pole shift, I'm sure just plain will be a treat!

Offered by [Brent](#).



# Troubled Times



## Trawling

---

In Australia we don't use bait when fishing for freshwater crayfish (yabbies), we trawl for them. To make a basket to trawl them, you just need to shape chicken wire into an open basket and strengthen the top with heavy duty fencing wire in a rectangular shape (to stop it from collapsing while dragging it), attach two ropes to corners, like crossover handles, then attach a long rope to the center of these handles and it's finished. Throw the basket out into the pond and wait awhile then start pulling the basket slowly over the bottom towards you. The basket picks up the yabbies out of the mud.

Offered by [Jan](#).





# Troubled Times



## Guns

---

I asked my friends what kind of gun they would prefer and naturally they split. One group is shotgun fans who claim that this is the best survival gun. You can hunt big game and birds with one gun. Other group says that in survival situation every shot counts and long range rifle with optical sight is necessary. The idea behind it is to kill effectively with one shot from long range. Preferred caliber is 7.62 mm (NATO size ) with heavy bullet, bolt action single shot. In addition they advise to buy high precision weapon corrosion and rust resistant, which will operate without oil (important in the winter). Bullets are lighter then shotgun shells.

Offered by [Chris](#).

Whether to chose a rifle or shotgun for hunting depends on what type of game you intend on hunting. I personally believe you should at least one of each; preferably in a common caliber and that isn't too complicated. You should have a good supply of ammo and spare parts, plus the knowledge on how to repair your weapon. Reloading your own ammo is option also. A sidearm would be preferable also for when you can't carry a long arm. Whatever option you chose you need to get training and practice beforehand. I don't think you need to get decked out like Rambo unless you feel it is necessary. Just stating on own opinion.

Offered by [Mike](#).



# Troubled Times



## Pellet Rifle

---

By far the best implement with which to hunt small game is the pellet rifle. A pellet rifle differs from a fire arm only in the method used to propel the projectile through the barrel and to the target. A fire arm uses an explosive (gun powder) to very rapidly produce high pressure gas to propel the projectile bullet to the target. A pellet rifle produces the same effect very rapidly releasing high pressure gas to propel the projectile pellet to the target. There are roughly three classes of pellet guns, classified by the method they use to provide the rapid release of high pressure gas.

- The first method is to provide a way of pumping air into a reservoir. When the trigger is pulled, the gas in the reservoir is released to propel the pellet. This method is generally the least preferred because of the time and energy required to pump up the reservoir.
- The second method is a variant of the first in that it uses a pre compressed carbon dioxide gas reservoir. When the trigger is pulled, a measured amount of this gas is released which propels the pellet. This method is very good in the modern world and some extremely powerful and accurate pellet guns use this method. In fact, there are a number of Chinese military weapons designed along these lines. For the purpose of a hunting rifle in the Aftertime, this method is inferior to the third method described below because of the problems of obtaining pre-compressed gas for 20 years or longer.
- The third method is called spring air. In this method, a lever (usually the rifle barrel) is cocked which compresses a very heavy spring inside a compression cylinder. When the trigger is pulled, the compression piston is driven by the compressed spring from one end of the compression cylinder to the other producing an explosion of compressed air which, in turn, propels the pellet to the target.

Spring air is the most popular propulsion system in pellet rifles today and there are many incredibly accurate and powerful rifles available today. The pellets come in .177, .20, .22, and .25 inch diameters. And modern pellet guns can shoot a .177 pellet at up to around 1060 feet per second or a .25 pellet at about 850 feet per second with a muzzle energy of over 40 foot-pounds. This is truly on a par with the .22 caliber rimfire rifle. The particular pellet rifle that I am planning to have is the Beeman Kodiak in .25 caliber. There is one other very important thing in favor of the spring air rifle. Both other major mechanisms, the hand pump up and the bottled CO<sub>2</sub>, produce a loud sound like a firearm. The spring air, on the other hand, makes hardly any noise at all. One can get in lots of practice in the back yard, not to mention not scaring other game in the area or giving one's position away to unwanted humans.

Since there is no powder to keep dry, the only thing one needs is spare parts and pellets. Compared to bullets, they are extremely inexpensive. In addition, one can make a mold and use lead from depleted lead-acid batteries to make all the pellets for a lifetime.

Offered by [Ron](#).



# Troubled Times



## Replacement

---

Obviously if you have Firearms they are likely to become redundant once your supply of ammunition has run out - unless you are capable of making your own. Unfortunately that will depend entirely on whether you can obtain the raw materials for making your own powder, caps etc., which is highly unlikely. Similarly if you possess your own pre-manufactured bows there is a high probability that they will not last forever in which case at some time or other it may be necessary for users to be able to construct their own.

Offered by [Brian](#).



# Troubled Times



## Birds

---

I found an opportunity for supper staring me in the face this afternoon. I've posted a bit lately advocating the use of spring air pellet rifles for harvesting small game. This afternoon I was walking my dog in the back yard and noticed an unusual number of birds congregating in the unused pasture abutting my back yard. I thought about it for a while and then made my decision. I decided to try a bird for supper tonight. With the medium sized dead bird in my hand, I had reservations about three things. First, how much difficulty would I have removing the feathers and cleaning the carcass? Second, just how much meat would I get from it? And third, how would it taste?

So, with a little bit of trepidation I set out to clean the carcass. I expected it to be very difficult to remove the feathers. *Wrong!* They came out clean as a whistle. Just easily stripped them off. Within about 3 minutes I had a necked bird. I removed the head, wings, tail, and legs in less than 30 seconds. The next step was to remove the internal organs and find out how much meat there was. The process can best be compared to splitting a whole chicken. The most difficult part was cutting the sternum - cartilage and breast bone that separates the two sides of the breast. A small pocket knife worked just fine and I was able to open the carcass up without almost any waste of meat. Removing the internal organs only required a swipe of a finger and a little scraping against the back with the knife blade to completely remove the lung area.

Careful inspection revealed that the only part left that was worth fooling with was the breast. I carefully removed the breast meat in two pieces - one piece on either side of the breast bone - exactly like one must deal with the breast bone when cutting a turkey. I ended up with two pieces of meat, each about an inch long and half an inch thick. The meat was a deep red without any cartilage. The rest of the carcass I threw away. I expected the meat to have a very strong gamy taste, so I mixed about 1/4th cup of water with a half teaspoon of salt and soaked the two breast pieces about an hour.

I next had to decide how to cook my meal. I learned long ago that I really like Chinese stir-fry with vegetables and a little meat. I usually use about a quarter pound of meat, two handfuls of vegetables, and about a half cup of a combination of chicken broth, soy sauce, 3 table spoons of gin, 1/2 tsp. of corn starch and other ingredients to make the dish unique (particularly like fermented black beans and dry mushrooms), and of course garlic and ginger root. Tonight, however, I didn't want to mask in any way the taste of the wild meat. So I decided on half a hand full of frozen vegetables, 1/8th tsp. of garlic, and no liquid sauce or rice.

Using a wok, I added 1/2 tbs. of canola oil, and cut the two breast pieces in half, giving 4 bytes of meat. I added this to the hot oil and cooked about 2 minutes. (that's longer than I would cook, say, the same amount of chicken; but I wanted it thoroughly cooked because I didn't know anything about potential pathogens, and red meat I usually cook a bit longer) When the breast was nicely brown ( I paid particular attention to any unusual smell, which I did *not* detect), I added the garlic powder and vegetables. These I cooked a minute or so until they were almost soft.

Then to the plate and a double Martini in case the experiment was distasteful. I first chose the largest piece of meat before drinking anything so my taste would be at it's height. To my great surprise, the taste was excellent. Actually, it was difficult to detect any taste any different than any other meat I would have prepared in the same way. After that I relaxed a bit and ate the entire meal, enjoying the entire thing. I never even thought to pick up the Martini, which I am enjoying as I type.

So there you have an account written within an hour from the taking of game to the eating of a meal of something I have never seen described. This was an important experiment for me though. It solidifies my gut feelings about the utility of the spring air pellet rifle in harvesting small game that might add greatly to post pole shift food sources. I

surely hope the birds survive to the extent that they can produce offspring, because there will be lots for them to eat and very few predators. That they actually taste good is, quite frankly, a God-send in my mind. That they can be easily taken with a spring air rifle whose ammunition is extremely inexpensive is a very important consideration. Believe me, I've eaten lots of different insects; but my meal tonight was very good. Period.

Offered by [Ron](#).



# Troubled Times



## Doping Birds

---

Some hunting tips that I learned during my overseas trips. For bird hunting without guns, what you need is a bottle with alcohol and bread. While the bottle is open you put a piece of bread on top. The alcohol will evaporate and will be absorbed by the bread. You leave it as a bait and pick up birds while they are sleeping. You can soak grain in alcohol. The effect is the same. I've never tried it, so can't guarantee it will work.

Offered by [Chris](#).



# Troubled Times



## Rabbit

---

You can trap wild rabbits with fresh lettuce and carrots placed inside a sturdy metal, wooden or plastic box with a spring side-door opened upwards, which springs shut when the rabbit enters it, much like a mouse trap. One can always make a sturdy cage out of sticks, (whose thickness depends on the animal you want to catch), which are tied together with several layers of strong twine. Cannabis is the strongest natural fiber, but in its absence even straw can be used. If you're even slightly mechanically inclined, you should be able to figure out how to make the release lever snap just at the right time. Long strips of rubber cut from old truck tire's inner-tubes can be used as a spring. There's usually plenty of scrap metal lying on the ground anywhere in the world, to make just the right kind of shape for the lever-release and step.

Depending on where you live, you can expect to catch not only rabbits with this, but most of your larger rodents and small herbivores. I have made rat-traps that work that way, and have caught many rats. Never used it for rabbits, somehow there were always enough cows and sheep and goats around if I wanted meat. To actually use rabbits as a source of food, you need many traps like that one, or a large 'mass' trap, which I don't really know about. The problem with this trap is that now you have caught this fluffy little wild rabbit, and alive, to boot. You'd have a hard time killing it, especially if you have children around. You wouldn't do it unless you were actually starving, and even then I know some people that would prefer to starve. I do know several other traps that present you with a dead rabbit at the end, but their description is pretty gruesome, so if you're interested - you can mail me privately on this.

Offered by [Sol](#).

Rabbits can be a dangerous meal if you eat too many of them. [Wild Rabbits](#) (not domesticated) are not all that nutritious, so relying on wild rabbit in one's diet leaves one malnourished. Just a word of caution.

Offered by [John](#).

Wild rabbits often carry Tularemia. Always wear gloves when skinning or preparing them, and don't touch or consume diseased animals.

Offered by [Toni](#).



# Troubled Times



## Turkey

---

Turkeys are pretty large animals to try to trap. Bow and arrow hunting is popular. If using a shotgun, try to aim for the head and neck. A good turkey caller is a must and are pretty cheap at most sporting goods stores. It's a good idea to scout around and know where the birds are, where they roost, where they feed and what travel routes they follow. On the farm I just bought I stumbled on an area that had 20-30 wild turkeys. I think the turkeys startled me more than I did them, but it did get me thinking. I will probably be setting out food for them so that they will live and roost in the area. I doubt I will hunt them until the time I absolutely need to, until then, lunch is on me. They can be quite entertaining to watch. While I'm at it, I may plant an acre or two of alfalfa to attract deer for the same reasons.

Offered by [Steve](#).





# Troubled Times



## Prey

---

The Aftertime has been described as the *Valley of the Shadow of Death* in the **Exodus** and by the Zetas as:

*A dense cloud cover that lasts for decades, resulting from the volcanic activity and loss of atmosphere due to the stripping away that occurs during lashing by the comet's tail. The dust filled clouds are low to the ground, and create a constant gloom. Rain occurs almost continuously. Where sunlight cannot penetrate and seldom manages to peek through this dense cloud cover, it does warm the Earth's atmosphere and thus its warming influence is not lost on the Earth. Less warmth from sunlight, but warm wet air.*

1. Decades implies 20 years or more.
2. Most plant life requires a good deal of sunlight, without which plants die. Consequently, where these conditions exist it seems reasonable to expect that within less than 1 year there would be very little plant life.
3. Most animal life subsists either directly from plant life or by eating other animals who do eat plants. This includes sea-life where the bottom of the food chain is plankton which ultimately get their energy from sunlight in the same way as plants on land.

What that leaves is plant life that requires very little sunlight, such as some ferns and other plant life that lives on the ground under the canopy of a rain forest, and plants and animals that can live off dead plants, or the animals that can live from those that can live off dead plants. There are lots of insects that live off dead plants, and there are some animals that can live off these insects; and a few animals that can live off these animals.

For instance, a bear can live off insect larva found within rotting trees if it can find enough. Mice and some other small furbearing animals can also live off insect larva, and fox, wolf, dog, and cat can live off these small furbearing animals. In addition, some birds also eat these insects and may also be present if they can survive the wind, fire, and rain. If there is still some remaining animal life, then there will probably be flies and mosquitoes. That allows for bats, which should have a reasonable chance surviving the fire and wind since so many live in protective caves.

What I'm getting around to is, why do all that work of searching for insects all the time when one can let the surviving animals do it for you? One must balance the energy expended to obtain a grub to eat with the energy provided by that grub. On the other hand, the higher up the food chain one goes, the less energy usually required to obtain the food. So, I've started thinking in an entirely new way about hunting animals for food, skins, and bone. Of course, the most efficient way to get wild animal food is to trap or snare it. In addition, though, one can hunt it.

Offered by [Ron](#).



# Troubled Times



## Deer

---

Bye the way, on several occasions I have personally downed buck deer with a .22 rimfire. The trick is to use a very good scope and hit the deer on it's spine as close to the head as possible. It doesn't kill the animal at this point but does paralyze it so you can move in close and kill it with a couple shots to the head (shoot for the lower part of the brain from the back just a couple inches above where the spinal cord enters the skull. This is the most vulnerable part of the brain and will cause the animal to stop breathing among other deadly functions.

I have also downed a deer by first hitting a rear knee cap, then the opposite front knee cap. The animal has to be standing still to get off a good shot, and one must place the second shot very quickly before the deer realizes what's going on. With both knee caps shattered it can't run and again you can then move in for the kill. With both methods hunt as if you were using a bow and arrow - use camouflage and shoot from no more than 40 yards. If you only get the rear knee cap the deer can still run, but not nearly as fast and as far. It will hole up and hide.

Tracking the deer is much easier than with only a bow because you not only have blood sign, but also the tracks are unmistakable. Look for brush quite close to where the deer was originally shot. Try to get in close enough for either the correct spine or head shot or even the opposite knee before spooking the deer again.

Offered by [Ron](#).



# Troubled Times



## Bear

---

The bear is more likely to be looking at *you* as food. I have been told by a bow hunter friend that he always carries a .22 sidearm when he bow hunts to finish off the kill. One day he was attacked by a brown bear. First he quickly climbed a very skinny tree. Then, using his .22, took out the bear's eyes followed by several shots into the nose and last several shots to each ear. The bear was deprived of it's senses and forgot about my friend. He then tracked it and finished it off with bow and arrow. A .25 pellet could do the same thing with both the deer and bear. I apologies to those of you that find this description offensive; but when it comes to eating and living under conditions of live or die, this has always been the way of the animal world.

Offered by [Ron](#).



# Troubled Times



## Mindset

---

Your basic instincts should take over with hunting. The rule is, strange as it sounds, become the animal. Learn how they live and how they react to certain situations. Like a rabbits always circles when chased. And make sure you kill on the first shot. Most animals stick to there trails. Set your traps there. You will be surprised at how "smart" you become when you are hungry.

Offered by [Clipper](#).



# Troubled Times



## Throwing

---

I have experimented with underhand, which tends to lob the projectile. I had read that this throw was primarily for heavy weights meant to be dropped into a crowd (ancient advancing troops for example). I can also throw with a single over-hand motion, sort of like throwing a grenade (stiff arm), and this works very well, but my favorite is still the helicopter whirl where the sling spins overhead in a horizontal plane and in the last 1/2 turn the arm extends to provide kinesthetic sense of where to release, but still in a horizontal plane above the head.

[Matthew Rapaport](#)  
mjr@crl.com

I started with the underhand throw. The main problem I find with it is that I tend to side arm it a bit and my throw will go off to one side of the target. I really think it is the throw of choice for long distance slinging, but it has a high looping trajectory. I've read that it was the throw of choice for teaching Roman troops to sling with only one movement and no wind up swings.

[James Burdine](#)  
jburdine@pipeline.com

I swing the sling in a circle around my head, line up with my target as it passes in front of my eyes. I then turn the circular path into a quick whip and overhand throw at the target. This is more natural, if you think about it, you are usually used to throwing overhand without a sling, so the sling becomes an extension of your arm.

[Benjamin Pressley](#)  
benjamin@Perigee.net

I'm an overhead slinger, i.e. I swing the sling horizontally overhead when I shoot. However, my prep is to put the stone in the pouch, let it hang loose, then bring it up to firing/moving mode by swinging it back once and on the forward return up and around. Thus, my maximum sling cord must allow me to clear the ground when my hand is at about waist level. My preferred throwing method is to load, lower the loaded pouch while keeping the thongs reasonably tensioned, then drop it so it swings back and on the forward swing whip it up and around my head. I may use only one swing, I may use several. I can keep it spinning around my head as I move for a better shot or as I wait for the target to get into view. Then I whip it hard around, and when my hand is beside my head, I continue forward to point at the target. The pointing releases the free end of the sling, and the projectile speeds to the target. The other end of the sling has a loop that I wear around my middle finger. The free end is held between my first finger and thumb as I whirl it.

There are several ways to sling the stone, vertically vs. horizontally, or a combination. One or more rotations before release. What position is best for your release? There are a few variables, but if you work on one style and get good at it, then add an alternative backup style, using a sling might be a good survival weapon. But it's not one of those weapons that is hard to learn, it just takes a lot of practice, which can be a lot of fun. Plus, it's easily made in the survival situation, usually. Learn the form first, then apply power. I also found that either horizontal spin or vertical spin have greater accuracy than a spin out of these axis. That is, a spin that goes by the ground beside you to over your opposite shoulder, for example, is going to be less accurate. For height I'll go vertical, for left/right accuracy I'll go horizontal.

[Bill Blohm](#)

bbloh@BOI.HP.COM

When I teach the sling in our advanced courses. I've learned that some folks can be accurate with a horizontal overhead swing, others take to the vertical swing which may be easier underhanded or over handed. I let them try all of the positions and choose the one most comfortable for them. Up on the Cordelierra in Chile, the Indians showed me how they teach their kids the overhead swing. They start with a short string about 1 foot long, until the kids learn the release points and coordination. Oddly the adults carry one of these short slings almost everywhere. The little slings don't have much range but they don't require a windup, can be used in brush and trees and will kill easily out to 20 yards or so. They're even good at the "fastdraw".

[Ron Hood](#)

diogenes@SURVIVAL.COM



# Troubled Times



## Ammo

---

I choose stones that are roundish, sort of egg-shaped with a flattish side. I lay the stone with the flat side flat in my sling pouch, not on its side as it would seem more natural to do. I have found the projectile to fly more predictably when loaded in this manner. Too flat of a stone will take all manner of unpredictable paths. I have seen flat stones take a 90 degree turn in mid-flight. I have also experimented with sun hardened clay.

[Benjamin Pressley](#)

benjamin@perigee.net

I've used ammo ranging from spherical to eggish, smooth to rough. I only avoid jagged ends that might cut my pouch from the force. I much, much prefer spherical ammo, I find it's much more accurate. If there is a flat side, I'll put that flat side against the pouch. But I would much rather shoot spheres and if I have to shoot one with flats, I'll try to find one with as many flats as possible on it. I also like to put several small stones in the pouch and shoot them all at once for the shotgun effect. This is particularly good with birds and small game, but does need a little larger pouch than my usual one. I've not experienced the erratic flight paths you describe, but this may be due to my avoiding if at all possible ammo with flat sides. The release from the pouch imparts a spin of sorts to the stone, and this may account for your erratic flights. This spin isn't much, but with a flat side that could rotate towards the path of flight, that might make it plane off. Oh, and for size, I like them to be about 1" diameter, but no more than 1 1/2" diameter or less than 1/2" diameter, unless I'm "shotgunning." I think the smallest I've used, even when shotgunning, is 1/8".

[Bill Blohm](#)

bblohm@BOI.HP.COM



# Troubled Times



## Construction

---

I am working on the pocket section of my fiber sling, Instead of wool yarns I used #18 nylon seine cord in yellow and white. I'm afraid that it's much too slick to use the 16 strand braid worked up as mentioned in the book on sling braiding. So, after making the finger loop, I separated my strands into 4 bundles of four strands each and did a 4 strand braid worked down until I had a length long enough for the retention cord. For making the pocket I'm using a separate length of yellow seine twine and the finger weaving pattern copied from the article on a sling pocket of the Paleo Indians found in Lovelock cave here in Nevada. I'll let you know when I'm done.

[James Burdine](#)

[jburdine@pipeline.com](mailto:jburdine@pipeline.com)

When we kids made slingshot pouches out of leather (invariably castoff shoe leather and hence a bit stiff) we cut two slits in them, about one-half of the distance between the center of the pouch and the attachment points for the rubbers. This made the pouch fit more closely around the rocks or marbles we used for ammunition. Sometimes we connected the two slits with a third slit, creating an H-shaped slit in the middle of the pouch, to allow a rock, especially an irregular pebble, to settle even deeper into the pouch. The split pouches on traditional slings undoubtedly are meant to do the same thing: contain a missile snugly and securely until the instant of release. (I can imagine an ancient hunter being seriously irritated when dinner got away because the stone fell out of his sling.) You could even gauge the size of missile the slingmaker customarily used by measuring the gap in the pouch.

[Sackett](#)

[sackett@dbo.eng.wayne.edu](mailto:sackett@dbo.eng.wayne.edu)

The slit or hole helps the stone nestle in the same spot in the pouch throw after throw. Without the slit, the stone can end up to the left or right of the pouch's center line and make the throw a little less consistent. What keeps the stone from falling out of the slit is the size of the stone. If the stone is too small for the slit, or you make the slit too big for the ammo you will throw, then it will fall out!

[Matthew Rapaport](#)

[mjr@crl.com](mailto:mjr@crl.com)

When I was a wee lad my dad made a sling for me. The pouch was from leather that you get in the harness repair bundles at the co-op. The strings were woven nylon parachute cord. the pouch was elliptical in shape around 4.5" major axis and about 2.5 " on minor axis. A small hole about the size of a dime or nicle was cut into the center of the pouch. The lenth of the strings were the lenth of my arm. a loop for the middle finger and a large knot that was held between the thumb and index. As I recall, the hole helped hold rocks in place and made it a little easier to load. Must have been something he learned as a kid (born in 1897)

Carter Mesick

[hmesick@GOLDINC.COM](mailto:hmesick@GOLDINC.COM)

Generally, I measure the sling folded in ready to load position from my heart to the end of my arm stretched out to my side. However, close range or long range shooting also dictates the length of a sling. As far as length I like measuring my sling on the average from the heart to the end of my arm held out to my side (folded). Historically, for warfare, slingers carried a short sling for close range, a medium length for medium range and a longer one for distance.



[Benjamin Pressley](#)

benjamin@perigee.net

Been slinging, on and off, since the age of 7. In general, my slings (after the first one my dad made me) are made out of any material that will work. I like the thongs to be flexible enough to roll up, but have used stiff thongs with success. Folded, I like my slings to be of a length to clear the ground when my elbow is at my side and bent 90 degrees. My current slings use leather boot thongs and a piece of leather 2" x 3" for the pouch, with the thongs tied snug against the 2" sides. I've used both rectangular and oval pouches without noticing enough difference in performance to worry about it. I'm not sure, as I'm deaf, but I think that the ovaled pouches are quieter. Sometimes the rectangular ones seem to vibrate as I whirl them. I like the leather for durability, mainly.

[Bill Blohm](#)

bblohm@BOI.HP.COM

I'm still learning the sling. I've made my first fiber sling from yellow and white nylon #18 seine twine(or what we would have called trotline cord in Oklahoma) It turned out very nicely and I'm proud of it. My only problem is that the socket is rather small in comparison to my leather sling 2.5 x 3.5 inches fiber as opposed to 4x6 inches leather. On the other hand, the fiber socket seems to grip projectiles fairly securely in comparison to the leather socket. This allows me to throw some smaller projectiles fairly well and continues to hurl golf ball sized rocks fairly well too. It does balk at the larger tennis ball sized rocks.

[Jim Burdine](#)

jburdine@pipeline.com



# Troubled Times



## Results

---

I have heard many anecdotes of shepherds using the sling to kill marauding foxes and coyotes. In each story, only one rock was slung at a time and the slinger had sufficient accuracy to kill, not merely frighten, the animal.

### [Ralph Ray Craig](#)

When I was a kid, up until I was about 16 had a car and could go fishing on my own, I did a lot of messing around (a good way to characterize what I was doing) with throwing stuff (sticks, spears, knives, and slings) and made my first slings. I never thought of the heart to hand measuring system but that does come out at about 30-36 inches which is where I ended up. At that time I would buy leather shoelaces for the straps and use soft waste leather from my Dad's leather projects for the pouch. Have used it to harass a friend in a canoe on a lake so I know that you can heave a good size rock quite a long way. I never got very good for accuracy but I could heave a rock a pretty good distance, 60-70 yards. I used to think it was closer to 200 yards :). I used the thing to scare game towards me by throwing the rock to the other side of brush piles, cedar clumps, etc.

### [Barent Parslow](#)

parslowb@CFW.COM

I've hunted small game with it, birds, rabbit and squirrel mostly. I've had limited success, but haven't been using it with the aim of using it to specifically hunt with. If I were to do that, then I imagine I'd be able to bag game OK, up to the level of a fox. Beyond that, I don't know. Of course, this depends on the range as well. However, I have sent a steel ball 1" diameter humming into a tree trunk some 80 yards away and had it hit with a very solid thud, so obviously the size of the ammo affects the range. (Sound effects courtesy of a very impressed group of people I was demonstrating to.)

### [Bill Blohm](#)

bblohm@BOI.HP.COM



# Troubled Times



## Sling vs Bow

Both the bow and sling are as easy to master, for one main reason: the bow allows repetition, but you tire after tens of shots while the sling isn't as easy to repeat the exact same motions with but you can practice so many more shots with it, and most anywhere. As a survival weapon - only if you've spent time getting good with it. As with bowhunting, spearing, and other ilk, you need good stalking skills as well. If you work on your accuracy, then birds would be good game for this. However, other methods should be worked on first, as using a sling can expend a lot of energy that you might not be wise to spend yet. One reason I carry three slings with me in my emergency pouch is that they're fun to play with, roll up small, weigh nothing, and have multiple survival and emergency use. For example, I can untie the thongs and use them for snares, lashings, tourniquets, fishing, and so on as well as a sling.

I use both bow and sling, so think I can compare the two somewhat. I think that a raw beginner, with no knowledge other than that from watching movies, and with a serious interest in mastering both would find both to be of the same difficulty. The reason I say this is that the arrow is a little more stable, and the bow is quite easily applicable to repetition. That is, I can pick up the bow, put my feet just so, hold the bow just so, draw to an anchor point just so, align the target against the bow just so, and shoot. But I can only shoot so many times before I get tired, and the minute I get tired, my aim and form will suffer. Now with the sling, it is *not* an easily repeated situation *but* the ammo is more plentiful and the areas where you can shoot are far more plentiful *and* you can carry the sling with you all the time and so shoot whenever you have a moment free and a good site. With the bow is the ease of repetition, with the sling is the abundance of practice.



If one had to learn alone, just pick up the equipment and try to work it out, then I'd say the beginner would have better luck with the bow, at least at first, simply because of the ease of repetition. The difficulty of the sling lies primarily with not being able to recall as accurately as with the bow exactly where your hand was, what angle your wrist was at, how fast you were slinging, where was your arm, etc., etc., when you release the stone. This is without anyone to provide comments, assistance, or instruction, as if you were out in the middle of the plains all by yourself, the nearest town 100 miles away and there on the ground lie a bow, arrows, and a sling.

Bill Blohm  
bblohm@boi.hp.com



# Troubled Times



## Staff Sling

---

The Kurds teach their kids to use a sling for small game. They use a thing "staff sling" to give the kids the right timing and arm motion. The only difference between the staff sling and a regular traditional sling is that one of the cords is replaced with a stick. The sticks are roughly oval in cross section and 2 to 3 feet long. Naturally they release the string and not the stick when they throw. I tried this method and it is really quite easy to use. Later I found out that Assyrians used it and some ancient seafaring nations used it because it wouldn't foul the rigging. There is basically no windup. It's used something like an atlatl and can be attached to a walking stick.

[Ron Hood](#)

diogenes@SURVIVAL.COM



# Troubled Times



## Resources

---

*Sling Braiding of the Andes*, by Adele Cahlander

ISBN: 0-937452-03-3

Softbound, 96 pages, profusely illustrated, purchase at:

**Unicorn Books and Crafts**

1338 Ross St.

Petaluma, Ca. 94954 - 6502

1 (707) 762-3362

1 (800) 289 9276

They go for \$12.95 each and \$4.00 for shipping and \$.60 for each additional copy.

*Atlatl's -- Ancient Weapon of the Ice Age*

a compilation of Benjamin Pressley's.

Thrower Ralph Craig's kindly distributing this title from the recent Ben Pressley TRIBE atlatl maker's/sling seminar that Ralph attended in Charlotte. Thanks big time Ralph. Your atlatl line art illustration is an excellent addition. Best note taking method I've ever seen - very professional. Nice touch. Well worth the \$4 turnaround. You deserve more. I have it on good authority that Ralph has another 6 copies. Another "for sure, this winter" project. Terrific printed material, as was the sling making book - and once again Ted Bailey was there ahead of most everyone.

[Chris Smith](#)



# Troubled Times



## Wasting Diseases

---

*Earthfile*, September 18, 1998

### **Mystery illness first appeared 30 years ago**

Health authorities in the American west are teaming up with federal and British scientists to study a new form of chronic wasting disease that is afflicting wild deer and elk - and stumping wildlife experts. Despite first being observed almost 30 years ago, little is known about the disease, which riddles brain tissue with microscopic holes, ultimately killing its victims.

The wasting disease is a form of spongiform encephalopathy, the same type of disorder as mad cow disease, Creutzfeldt-Jakob disease and scrapie, a disease that infects sheep. The course of the disease, first observed in the late 1960s in a small group of captive mule deer near Fort Collins in northern Colorado, is often unrelenting, experts say. Before they die, the animals become dazed, stumbling near-skeletons, drooling excessively and apparently experiencing dementia.

While humans eating beef from cattle infected with mad cow disease can develop Creutzfeldt-Jakob disease, it hasn't been established that eating deer or elk afflicted with chronic wasting disease would similarly infect people. Still, health and wildlife authorities in Colorado and Wyoming are concerned that hunters could become infected after eating meat from sick animals. ... Colorado hunters are advised to wear rubber gloves when field-dressing deer and elk carcasses, to minimize the handling of brain and spinal tissues and to wash their hands thoroughly afterwards. They are also cautioned against eating the brain, spinal cord, eyes, spleen and lymph nodes of their kill.



# Troubled Times



## Traditional

### Arab/Asiatic

Usually made of thin layers of horn and softened (soaked and softened) sinew glued to a central core of wood. They are often shorter (42"-72" = 107cm-183cm) than their European counterparts (60"-78" = 152cm-198cm) as they were more often used from horseback, whereas the European bows were more often used from the ground. The Japanese bow was different again, being up to 84" (=213 cm) (or more) in length. Many of the Turkish, Asian and Arab races drew the bow using a thumb- ring, a ring worn on the thumb of the drawing hand. The string was hooked behind it (in the palm of the hand) and the thumb closed over the string so that it rested tightly against the middle finger. For heavy bows, the forefinger could also be used to lock the thumb closed. To release, the thumb is opened, allowing the string to slip off the edge of the ring. (With the heavy bows, the forefinger should be raised first to save undue strain on the thumbnail as it slides free from the forefinger). Using the Asian release, the arrow would rest on the opposite side of the bow to that of those using a finger release i.e. for a right handed archer, the arrow would rest on the right side of the handpiece, whereas usually for those using a finger release, a right-handed archer will have the arrow resting on the left side of the grip.

### European/African/American Indian

Usually a wooden 'Self' bow of between 60"-78" (=152cm-198cm) and intended for use from the ground, although the American Indian used the shorter versions very effectively from horseback. The American Indian also often used composite (horn/sinew or wood/sinew) or backed bows. The traditional yew bow of Europe acted as though it were a composite bow, as it was preferably made of a section of yew taken where the sapwood and heartwood joined. The different properties of the two different wood types allowed the bow to act with the best features of each wood type. The properties of the 'Self Bow' are such that the minimum length of the bow is (2x Draw length) i.e. with a draw length of 28 inches (=71 cm), the minimum length of the bow will be 56 inches (=142 cm). The greater the length of the bow, the more even can be the spread of forces built up.

The short bows of the American Indian probably varied between 20-70 pounds, the European hunting bows normally ranged between 40-100 pounds, with the European war bow (e.g. the Welsh Longbows) ranged from 90-180 pounds. However, the European war bows were drawn both to the chin and to the chest. Due to their great draw weight, and the fact that they were often used in ranks of archers and fired at large masses of opponents at long range, they were often drawn to the chest (with the bow-string passing down the cleft of the chin) using a longer arrow (36" = 91cm) the 'cloth-yard' shaft, and fired high into the air in massive volleys to fall almost randomly into their targets. As the ranges got closer and the archers were more able to pick specific targets, they reverted to a more traditional aiming style, with the long arrow drawn past the side of the chin and the fingers of the nock hand back somewhere around the jawbone or ear and aimed normally. The heavy draw weight of these warbows requires a significantly heavier shafted arrow, usually with some form of bodkin head, which had enough weight to strike its target with frightening power.

Indications are that often many warbows were carried half made (as shaped staves) during prolonged campaigns, and finished as and when they were needed during the campaign. Normal (European) war tactics involved massed ranks of lightly armed or armored archers firing large volleys of arrows into formations of targets. It was the Welsh Longbow, in the hands of thousands of archers, which effectively obliterated the cavalry force of thousands of French knights at both Agincourt and Crecy. Bad weather and mud were major contributing factors in this, as the French cavalry were unable to close to attack effectively, so that massive volleys of arrows wiped out the opposing crossbowmen and then the French Knights (and their horses).

Offered by [Brian](#).





# Troubled Times



## Terms

---

### Backed Bow

A bow primarily of wood, but having a thin strip of another material along the back of the bow (see composite bow). Usually the material used was a thin strip of wood (e.g. bamboo or hickory), or a strip of raw hide or even silk glued in place. This backing did not add much (if anything) to the strength or efficiency of the bow, rather it helped the bow to return slowly to straightness. Bows backed with sinew are the exception to this, as the sinew greatly increases the tension of the bow.

### Bow Irons

Assembly that holds the Prod onto the front of the Crossbow. Can comprise of plates, blocks, wedges and stirrup.

### Composite

A bow made by laminating multiple materials together in thin layers. Materials most commonly used in traditional bows were different types of wood and layers of horn, often bound together with sinew and glued in layers. Modern bows usually use layers of wood, fiberglass and/or steel. Traditional Asiatic and Arab bows were often horn/wood/sinew re-curved composites. The different materials allow the bow to use the best properties in the best location to maximize their efficiency. Manufacture of these types of bows is a slow and painstaking task, as any weakness in any of the joints will give either reduced performance, or a bow which will break under load.

### Longbow

Usually a 'Self' or 'Backed' bow, the longbow is effectively a straight (or slightly curved) length of wood with string on each end. Fiberglass, steel and composite longbows are also often made. It has no re-curves, no pulleys or cams, and is the traditional shape associated with the European archers of the middle ages.

### Prod

Bow section of a crossbow. Can be constructed from fiber glass, sprung steel etc.

### Re-curve

Any bow which has the tips of the working limbs bent backwards in the opposite direction from the draw when at rest. This allows the bow to develop extra power when drawn, to store and release energy more efficiently, as well as increasing velocity in the arrow by adding an extra flick in the arrow at the last second as the arrow starts to leave the string. The amount of re-curve can vary from a slight curve at the tips, (similar to a 'J' shape) to a total curve whereby the whole working limb of the bow bends backwards from the handgrip, giving a totally reversed 'C' shape, sometimes curved backwards to the point that the two tips will actually touch when unstrung. (Also known as 'retro-flexed')

### Self Bow

A one piece bow, usually made of a single stave of wood, or any other single material (this now includes 'all steel' or 'all fiberglass' bows). Also used to mean a bow which may be made of 2 staves of wood of the same type, jointed at the midpoint (handle), to give a single length of uniform strength and uniform properties. This was often necessary due to the difficulty of getting a single bowstave of a decent length without knots, warps or other defects. This is the main European/African/American Indian etc. style of traditional bow but can be applied to solid fiberglass, steel, horn, etc.

**Stave**

Length of wood, a radial split from log, branch or commercially purchased timber from which the bow is to be constructed. (Also referred to as bow-stave.)

**Stirrup**

U shaped clamp or support at the front of a crossbow into which the foot is normally placed, enabling the crossbow to be held down while the bow string is locked into the firing position.

**Tillering**

The process of working a bow down evenly to reach the required draw weight at the required draw length and to ensure that bow limbs are balanced with respect to each other and ensuring that the "arc" of the drawn bow is even.

Offered by [Brian](#).





I strive to provide you with wood that I would like to work with myself. If you would like to try something that you don't see here, please let me know and I'll try to find it for you. Thank you for your interest and support.

Check out my articles on various aspects of bow building:

[All Wood Composite: Bow Building 101](#)

[Hickory Backing--The Available Alternative](#)

[Building a Durable Hickory \(White Wood\) Bow, Quickly](#)

[Red Mulberry, Its characteristics and application in Wood Bowery](#)

[Follow The Grain, Practical Advice for Working With Osage and Other Woods](#)

[Moisture Content as Related to Construction and Performance in Wood Bowery](#)

Here's a nice article on crafting your own [Flemish string](#), by John Hutton.

Here are pictures of my homemade [lamination grinder](#).

---

Check out my [price list](#).

More Traditional Archery [Links](#)

---





*[murray@murraygaskins.com](mailto:murray@murraygaskins.com)*



# Troubled Times



## Materials

I've found design and construction details for flatbow/longbow/crossbow. This includes details on making your own string and arrow making.

### Tools

To work these, you will need a straight edge (or string-line), pencil, saw, hand rasp and/or drawknife and/or spokes have, sandpaper. A vice is also very useful, as long as the bowstave is gripped between blocks of wood etc. to reduce damage to it. The professionals often speed the process up with a bandsaw, but these have a tendency to waste a lot of bowstaves until you know what you're doing.

### Wood

Ideally, the wood should be split rather than sawed, preferably Bow staves should be a radial split from a log/branch which is 4-6 inches diameter plus. This means that it is more likely that the wood will follow the grain, whereas sawing is often more likely to cut across grain. The more the bow-stave follows the grain of the wood, the less likely it is to break, and the stronger it is likely to be. If the grain runs across the bowstave at any sort of an angle, this will weaken the bow to a certain extent, the amount of weakening depending on the degree of the angle of the grain. Usually the sapwood becomes the back of the bow, particularly in the traditional "D" section longbow. Grain alignment is not as critical when using lemonwood/degame, which is recommended for the beginner.

The main criteria is that the wood has been seasoned (dried) fairly slowly. If you are using commercial stuff (from a timber yard) it has probably been kiln-dried. This is usually OK if done properly, although can sometimes weaken the wood slightly if done too quickly or dried too much. The general opinion amongst bowyers is that air-dried wood is far superior (Some timbers like Osage orange don't like kiln drying.) however, it is often difficult to acquire suitable air-dried timber without doing it yourself (over a long period). Also, if you have the equipment to be picky about it, the wood should ideally have been dried to suit the region it is being used in. This is sometimes relevant if the wood is imported, kiln-dried in one place and used in a region with a higher or lower humidity. And if kiln-dried too much, (below about 10% Moisture content) this is also likely to weaken the wood. However, as most people don't have the equipment to test, the moisture content is usually just assumed to be correct.

### Wood Types

Some of these are well suited to self-bows, some better suited to making laminations for composite bows. (These are all supposed to be the preferences in the Northern Hemisphere, USA, UK, Europe etc. Some or all of these may be available, some may only be available in the USA.) These include Yew, Osage Orange, Dagame (lemonwood), Elm, Ash (most of them), Hickory, Oak, Birch, Black Locust, Walnut, Cedar, Juniper, Mulberry, Maple, etc. Of the Ash varieties in the US: strong ash (white, red, green, Texas, & Oregon weaker ash), black or blue (both may be adequate for a bow).

The main New Zealand and Australia options include, for New Zealand: Tawa, Rewarewa (probably), Manuka/Kanuka (New Zealand Tea-Tree), and for Australia: Osage Orange, Acaias (Wattles, e.g. Blackapple, Gidgee Myal/Boree, etc.), Tasmanian Myrtle, Spotted Gum, Alpine Ash, Silver Ash. Pacific regions use Bamboo, Lancewood (this is New Zealand Lancewood), and Black Palm.

Offered by [Brian](#).



# Troubled Times



## Wood Grain

The greater the variation of grain and wood growth rings from the ideal, the more likely it will be that the completed bow will be weaker and more prone to breakage in use or in construction.

### CROSS SECTION

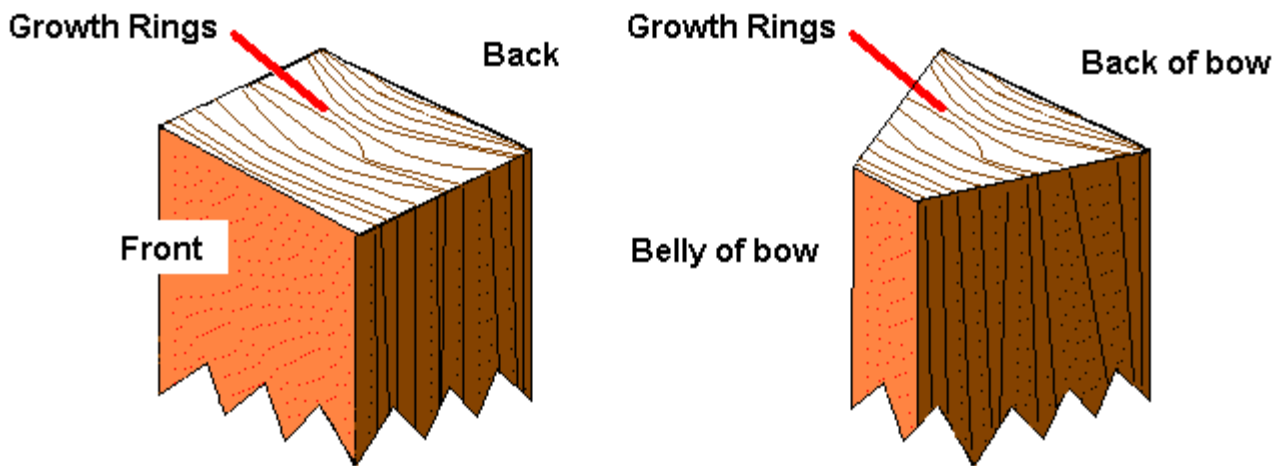

(Exaggeration of growth lines along the side of the bow)



The grain should also run straight along the length of the stave from end to end. If it curves up and down, then you have to alter the design to follow the grain. At all times, the back of the bow should follow the line of the grain and the front (belly) of the bow should follow the line of the back (with the appropriate tapering required). Likewise if there are any knots in the wood, you have to alter the design to allow slightly extra wood to go around and support the weaker knot wood (or 'pins'). E.g. if the grain dips down in the bowstave, then the bow should also be shaped to follow that curve (from a side view of the grain).

(Side View of grain)

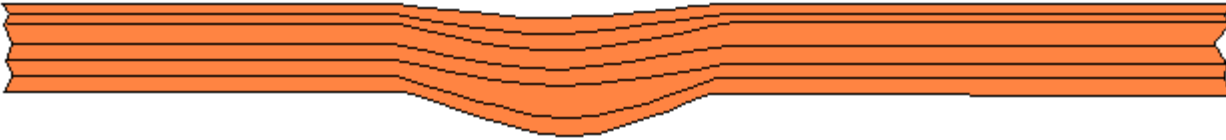

**Here the dip in the grain will be followed in the bow, resulting in the bow having a dip in one arm. If not followed the grain will be cut, weakening at this point.**

With twisted staves, it is best to joint two "sister" split pieces from the same log (i.e. two pieces split next to each other from the same log - and which would then have similar twists) and joint them at the handle using a Z - or fishtail splice (as below). This ensures that both limbs are complementary, even if badly twisted.



### Z - splice

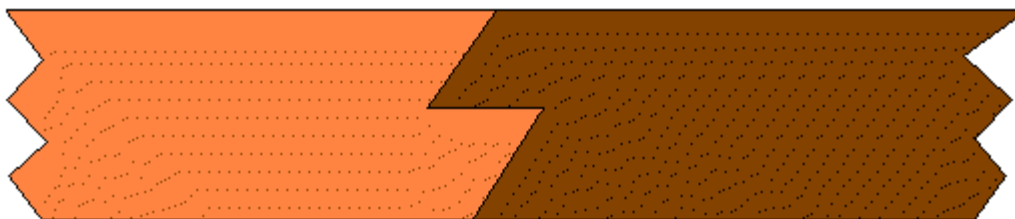

### Fishtail - splice

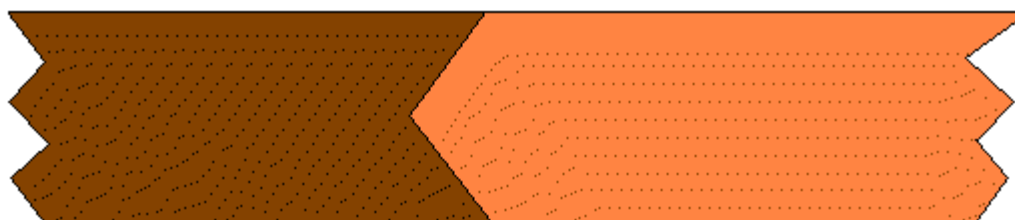

This can also be done if you are unable to find a single length of wood to make a complete stave. 2 half-lengths can be spliced using either of the above splices, such that the spliced section will be in the handle section of the bow and therefore covered by the handle wrapping etc.

Offered by [Brian](#).



# Troubled Times



## Wood Type

---

Probably one of the most common questions is whether it is OK to make a bow from a wood other than yew or Osage orange. Not only is it okay, in some cases it is more desirable. Firstly, white woods do not need to be coddled in terms of the sapwood to heartwood ratio. With yew and Osage, bark and outer wood should be removed to produce a good quality bow. For a beginner, this is a daunting task. However, white woods require no special treatment. Once dry, simply remove the bark and the exposed wood instantly becomes the back of the bow.

Secondly, yew staves can cost \$120.00 US now, while most people have the ability to go and cut down their own maple, ash, white oak, birch or hickory tree for little or no cost. Often, one can pull two or more staves from a white wood tree. I, personally, refuse to cut down a tree unless it can yield 5 bows. Sometimes this takes a bit of looking, like maybe two hours as opposed to the week or so it could take looking for the perfect yew tree - if such a thing exists at all. In speaking of the virtues of white wood bows, it's impossible to fully appreciate their value without first speaking about bow design and how it can affect performance.

If you have already made your first bow of some common wood, you will probably have found that the resulting bow has taken a massive set or amount of string-follow. Both of these terms refer to the amount that the bow has bent in the belly direction when unstrung. String follow or set is not a big problem unless the set is extreme (anything over 3"). Again, if you've made a white wood (common wood) you will probably have constructed a bow with anywhere from 6 to 10" of set. Set robs a bow of arrow speed - a factor that is very important in the construction of bows. Why? Because a higher arrow speed means that an arrow has a flatter trajectory, thereby making it easier to aim at varying distances. Additionally, if you're a hunter, you'll appreciate that arrow penetration into target is important to ensure a quick, clean kill. So how can we make a white wood bow with the same weight, arrow speed and poundage as a premier wood bow? Simple. Make your white wood bow wider (in the case of the flatbow) or longer (in the case of the longbow).

Most bowyers agree that white woods need a factor of 20 to 30% increase in width or length to equal the cast and speed of a premier wood bow. In the case of a flatbow, this amount only applies to the maximum width of the bow. In the case of a longbow, this applies to the entire length. Although 67" is by far the most efficient length to base a bow at, such a thing is practically impossible if making a D-Style longbow out of a white wood. In my experience, I have found 79 inches to be a good base point. This done, I don't have to adjust any other aspect or dimension of the weapon. With white wood flatbows, I always use 2 1/8" at widest point with handle remaining the same width and thickness as it would in a premier wood bow. Remember that these increases apply only to the widest point (in terms of flatbow) or entire length in the case of a longbow. Adjust no other dimensions, as these changes will do the job. Let's look at the advantages and disadvantages of making bows from "white woods".

### **Advantages**

- Cheap
- Easily obtainable
- More choice of woods
- Outside of tree becomes back of bow (no extra work)

### **Disadvantages**

- Requires wider or longer limbs
- Not as "prestigious" as premier woods

Offered by [Brian](#).



# Troubled Times

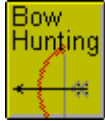

## Bow Back

---

The back of the bow should be the side which is closest to the outside of the tree or branch if it can be determined (i.e. sapwood - particularly for Yew).

In many bows, the back is sometimes made in the sapwood of the timber, with the bulk of the bow in the heavy heartwood. Whether to use the sapwood or not is dependent mainly on the type of timber being used. Yew's sapwood has properties that make it ideal to be left on as the back of the bow. With many species, all of the sapwood is removed and the back of the bow becomes the first layer of hardwood found (See below for a fuller discussion on whitewood bows). If the sapwood is being left on to form the back of the bow, it should be thinned down so that it only comprises up to a maximum of about 1/3 of the thickness of the finished bow. Most of the strength of the bow comes from the heartwood. Bows can be made totally from sapwood of many tree species, but some slight changes need to be made in the following designs to accommodate whitewood bows.

To prepare to work the bowstave, the back of the stave should be worked down until the full length of the back is all within a single growth ring i.e. there are no rings or 'feathers' showing through on the back. This means following the grain no matter what twisting occurs in the grain and in the stave. This should be done with hand tools, rather than a saw, as it is probably the main reason for weaknesses in a final bow. If the growth rings are cut through anywhere on the back of the bow, it is extremely likely that this will be the place the bow will snap at. Once the back is cleaned down to the same growth ring, the actual bow can be marked out.

Offered by [Brian](#).



# Troubled Times

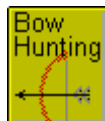

## Dimensions

---

How to build a bow yourself: Ash and elm are the types of wood that has the qualities witch is needed to accomplish sufficient power and recillience in a selfmade bow. The material is splitted in four lengthwise. The bark is allways the bow's back. The bow should be as long as the owner height. The stiffest part should be in the middle of the arrow. Patience is often tested during the adjustment. As a string you can use linen thread, and attach in each end in special cut notches. The easiest way is to use hacksaw or very sharp knife. It is also possible to twist the string yourself. The arrows can be made of pine tree or birch. The length should be as long as the owners arm. The arrow tip and tail feathers can be secured with glue or a thin rope in notches you make.

Offered by [Preben](#).



# Troubled Times



## Flatbow

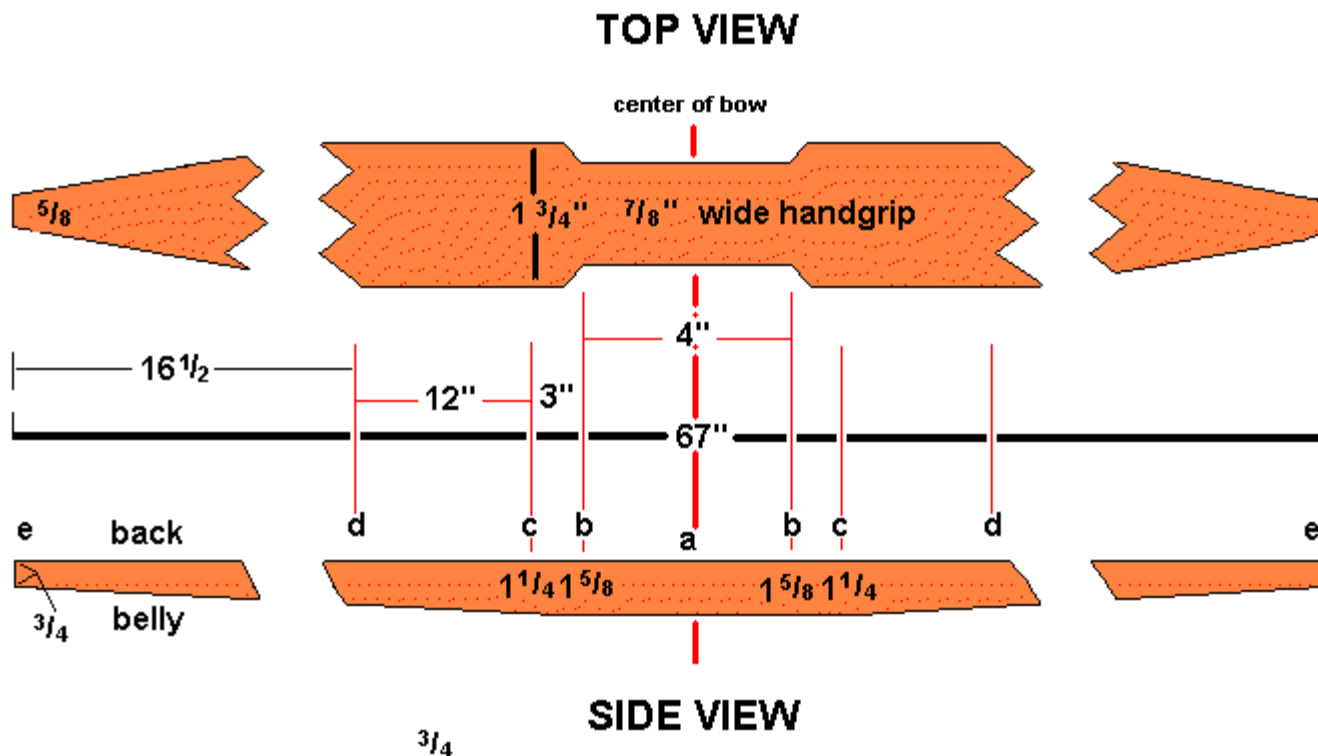

The bow is drawn to 67" length, designed for a 28" draw length. If your draw length is longer or shorter, alter the total length by 2" for every 1" draw length change (e.g. draw length of 26" gives a length of 63"). Handle section (c-c) remains the same, the rest (c-e) should alter in proportion.) Also, the handgrip on the belly side (c-c) can either be all of one part of the main bow, or else can be a second length of wood glued onto the belly to give the necessary depth.

First, draw a line the full length of the back, directly down the middle of the bow, using a straight edge or string line. Mark the middle of the length of the stave 33.5" from each end. (a) The handgrip will be 2" (a-b) either side of this, (giving a 4" long handgrip b-b) and will then widen over the next 3" (b-c) to the widest part of the bow (c). From c-d (12") the stave remains the same width (1 & 3/4" total width or 7/8" either side of the center line).

- From d-e, the bow width tapers as a straight line down to a final width of about 5/8" (5/16" either side of the center line). Once these are marked on the back, they can be cut to shape and smoothed with plane and sandpaper, giving the rough shape.
- From the side, the depth of the handgrip (b-b) should be about 1 & 5/8", tapering off to about 1 & 1/4" at (c) and then a straight taper down to about 3/4" at (e). Once this basic shape is sawed out, the belly can be worked down to meet the required weight using more cautious hand tools. The Belly is kept flat throughout it's length and the taper towards the tips kept constant.

Offered by [Brian](#).



# Troubled Times



## Longbow

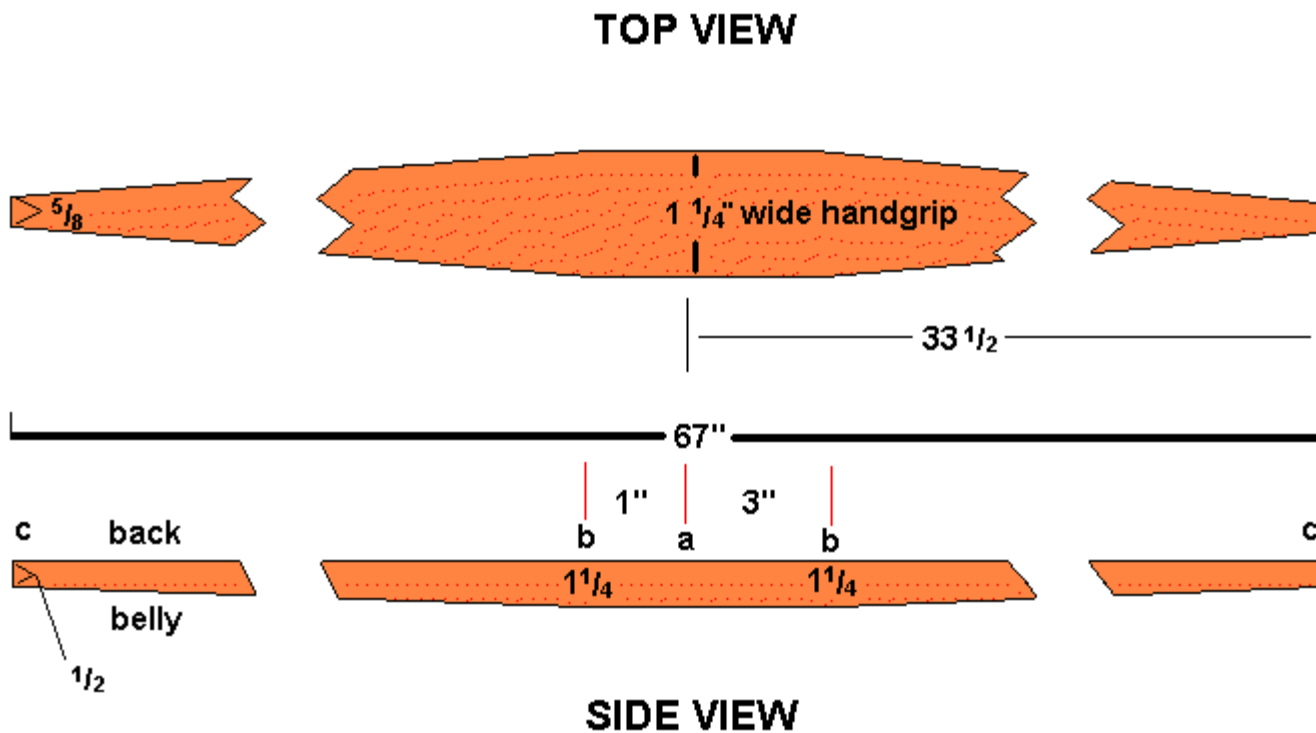

To mark the bow out, draw a line the full length of the back, directly down the middle of the bow, using a straight edge or string line. Mark the middle of the length of the stave  $33.5$ " from each end. (a) The handgrip will be  $1$ " from this (a-b) on the upper limb and  $3$ " on the lower limb, (giving a  $4$ " long handgrip b-b but meaning that the upper limb is  $1$ " longer than the lower one). From b-b, the width should be about  $1\frac{1}{4}$ " wide ( $\frac{5}{8}$ " either side of the centre line) and from b-c should taper smoothly down to about  $\frac{5}{8}$ " wide ( $\frac{5}{16}$ " either side of the centre line).

Once these are marked on the back, they can be cut to shape (cutting outside of the line to allow slightly extra wood) then smoothed to size with plane and sandpaper, giving the rough shape. From the side, the depth of the handgrip (b-b) should be about  $1\frac{1}{4}$ ", tapering straight down to about  $\frac{1}{2}$ " depth at (c). Once this basic shape is sawn out, the belly can be worked down to meet the required weight using more cautious handtools. This style of bow has the centre of the belly remaining high and the sides and belly completely rounded.

Offered by [Brian](#).





# Troubled Times



## Longbow

---

Here is one of the many descriptions of longbow construction that I have come across.

Offered by [Kerry](#).

### Making an English Longbow

**Materials:**

degame - 6' x 1 1/8" x 1 1/8"  
softwood - 4" x 1 1/8" x 1/2" to thicken the handle  
hickory - 6' x 1 1/8" x 1/4"  
horn for nocks

**Tools:**

Plane  
Clamps  
Saw  
Rasps  
Measure  
Pencil  
Car Inner tube

**Glue:**

Powdered resin glue (Cascamite)

**Bowstring:**

Dacron B50  
Beeswax

You will also need to fashion a tiller to test the strength of the bow - for this you will need some stout wood, 6' x 3" x 2", a pulley and a hook - preferably a fishing scale that goes at least to the weight you want the bow to draw at. Fix a block of wood to the tiller at about eye level (this supports the bow handle) . Fix the pulley to the bottom of the tiller, and fix the scale to a string (about 15" long) that passes through the pulley. Mark the draw lengths on the tiller so that they can be seen from a distance (it's always best to be a little away from a bow that hasn't been proven when it's drawn). It's useful to attach this to a wall for stability.

Degame is the wood most often used for a first bow - yew and osage make better bows, but are more difficult to make properly. This should produce a working bow first time. Check the true of the degame stave - if it has a natural curve, try and make use of it. Face the inside of the curve away from you, offsetting the natural curve that the bow will assume as it is tillered. The wood should be well seasoned, or the bow will perform badly - the fibres may also lift on the outside of the bend, particularly on the hickory. Prepare one side of the hickory strip and the chosen side of the degame. They should be flat and even - but slightly roughened to take the glue. When planing the hickory, take care to keep the blade sharp, as hickory is stringy and does not plane easily. Do not use the white, ready to use wood glues, as they are too rubbery and may cause the joint to move, even when dry. A powdered resin glue is much better, as it sets very hard and is waterproof.

Now comes the car inner tube. Cut it into a bandage, about 10' long and 1 1/2" wide. Spread the glue evenly and generously along the degame face, then lay the hickory strip along it. Slide it around a little to work out any air pockets. Clamp one end of the rubber bandage to one end of the stave, then bind the rubber around the stave very firmly, with about an inch between turns. Clamp at the other end when you reach it. Put the stave in a warm dry place and leave it for about 48 hours. Be very careful when unwrapping the rubber bandage - the dried resin glue is very sharp. Leave the unwrapped stave for another 24 hours - don't be impatient! This will all look pretty dirty and messy, but a beautiful longbow can come out of it! Clean up the hickory face and one side of the degame, so that outlines of the bow can be drawn directly on the wood.

The first and most important step is to draw a perfectly straight centre line onto the hickory, running the length of the stave. All other measurements will be taken from this line so be sure and make it accurate. Mark the line either with a good straight-edge, or mark points along a string drawn tightly from end to end. Next draw a line across the stave at exactly half the overall length. Rule in two more lines, the first one inch above (A), the second 3 inches below (B). This will form the handle - notice that the grip is not central, but slightly low, so that the arrow will pass over the top of the hand, nearer the true centre of the bow. Continue to mark out the hickory face as follows:- mark two more lines, one 4 inches above A (C) the other 4 inches below B (D); then a line 6 inches from either end of the bow (E) and (F) (The entire length of the bow should be 72 inches)

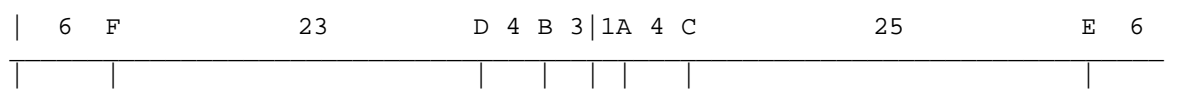

The width of the bow should be 1 1/8" from D to C, tapering to 3/4" at F and E, and again to 1/2" at the ends. Now turn the bow on its side and mark out the thicknesses - 1/2" at each end, 1 1/8" at B and A. Mark two extra lines 2" away from B and A. The thickness at these points should be 1". This should produce a bow 6ft long, with a draw weight of approximately 55lbs at 28", although each stave will be different. If a different weighting is required, adjust the measurements in proportion. Making the bow 1 1/8" wide and 1" thick prevents the bow from twisting. If the bow was just 3/4" thick the bow would be less likely to break or twist, but the cast would be reduced.

Now cut the bow shape out of the lines drawn. This is easy to say but much harder to do. Saw the side profiles first (the ones drawn on the degame), leaving the front profile lines intact on the hickory face. Alternatively, you could plane the surplus away. You should end up with a square looking, tapered stick, that almost looks like a bow if you squint at it a little. At this point, glue a piece of softwood 4" x 1 1/8" x 1/2" to the \*hickory\* face, covering the 4 inch handle area. This will be shaped to thicken the grip making the bow more comfortable to hold. Since you now have to wait for the glue to dry, you can either take a rest, or make your tiller, if you haven't done so already. The tiller holds the bow while you bend and train the limbs - remember that a bow has a lot of weight in its early stages, so be sure that the tiller is strong - you don't want the supporting block to come off while you're pulling the bow.

The next stage in shaping the bow is to smooth the hickory backing. Round the edges to a gentle radius. The final thickness of the hickory should be about 1/4" at the centre line. File or cut a temporary nock about 3/8" from the end of each limb - these will be file away after the bow is completed, when the tips are shaped for the horn nocks. Make them just deep enough to hold the bowstring. Turn the stave over and radius the degame with a rasp, including the handle area. A good way to do this is to draw a central line down the stave and make sure it stays there while you shave the edges. The hard work is pretty much over at this stage. Find a good strong string with a breaking strain of over 100 lbs to use as the training bowstring. Fit the string to the bow, but don't attempt to brace it at this stage. Put the bow on the tiller, with the handle section directly on the support - you may want to cut a groove into the support to help the bow to sit straight. Hook the pulley rope onto the bowstring, take a few steps back and pull gently. Pull just far enough for the limb tips to flex about 6 inches, and for you to see the first gentle curve of the bow. Do this a dozen times or so, noting the flex in the bow as you do.

The bow should curve more at the ends than in the centre, but not too much. If it only bends at the ends, the bow will be very hard to draw, and will take a set badly. If it curves too much near the centre, it will have a poor cast and be uncomfortable in the hand. The idea is to eliminate any irregularities before they have time to take a permanent set in the limb. If an area is too stiff and rigid, remove a little wood to let it bend. If an area bends too much, remove wood from the extremes of the bend to even it out. Remember that the more wood you remove, the more you reduce the cast of the bow. The working section of the bow should be the areas between F and D, and C and E. Keep working the bow, scraping the wood away while keeping the shape good, until you can draw the bow back to about 28", still using the training bowstring.

Now its time to brace the bow to about 6 or 7 inches. With the bow braced, rest one end on the ground and look along the string to check for twist. The string should exactly dissect the limbs end to end, although a slight variation can work. If there is a tendency for the bow to twist in one direction, try clamping the bow tightly onto the tiller block and pulling the string in the opposite direction to the twist. If you have managed to keep the width a little greater than the thickness, all should be well. Now gently feel the strength of the bow by drawing it a few inches. Don't try to draw it to full length as it will probably break, because the wood is not trained to complete the bend. The saying is that a good longbow is nine tenths broken at full draw. The bow should never be drawn past the length you have tillered for, once completed.

Back to the tiller, using the braced bowstring, with more scraping away of the wood until the draw is near the target. When you reach a draw length of 24" or so, test the pull again. If the bow is going to break, it will during these last few inches, so take care. Flex the bow about 50 times for each inch you increase the draw at this stage - less will increase the risk of the bow breaking. You cannot over-train the bow. Keep doing this until the required draw length is reached. When you do reach the target draw length, hold the draw for a few seconds, then repeat several times. If you still have a bow at this point, and not firewood, you have a bow you can shoot.

Remove the string from the bow. The bow should have a slight natural curve, having 'followed the string' during training. This curve will be more pronounced immediately after shooting, but this will lessen as the bow 'rests'. It may damage the bow to try and straighten it. You will need to know the draw weight of the bow, so return it to the tiller, and test the draw weight with a fisherman's spring scale. If the bow is too heavy, shave a little more wood off, but be careful, as it will lose the weight quickly. If the bow is too light, it can be shortened to increase the weight, but this will increase its chances of breaking. Now you can actually shoot the bow. Fit a proper string, braced to about 6 or 7 inches and shoot a dozen or so arrows. Examine the bow, and if all is well and the bow feels good, shoot a few dozen more. Unless you have shot longbows before, the arrows will almost certainly fly left, and be very haphazard.

When you are confident that the bow is sound and no further adjustments need to be made to the shape or draw weight, you can finish the bow. The first stage is to make the horn nocks. They make no difference to the cast, but they do make the bow look better. Also, if the bow is to be used under British Longbow Society rules, horn nocks must be fitted. Almost any solid horn will do (cowhorn are the most widely available). It is easy to work, but has a powerful smell - not a job to tackle after a heavy meal, or in a room with little ventilation. First, drill a round tapering hole into the base of the horn - the easiest way to do this is to drill a 1/8" hole about 1 1/4" deep and then enlarge this out with a 1/2" drill ground down to the required taper. The hole should end up being 1 1/4" deep and 7/16" in diameter. Remember that horn is quite soft, so a hand brace is preferable to a power drill, which may tend to snatch, and lacks control. To complete the work on the horn, glue it to a separate piece of wood (with the same taper as the horn) with a water-soluble glue. When the horn is finished, a good soak in hot water should release the horn from the wood.

Apart from fulfilling the purpose of holding the bowstring in place, the horn can be as plain or fancy as you please - some examples seen are leaping salmon, horses heads and eagles, but remember that the more delicate the design, the more chance of damage during use. Gradually work the surface down using files,

abrasive paper and polishing compound until all the scratches are removed. The final polish is achieved using metal polish, and this is best done on the bow, after fitting and cutting the string grooves. When the horns are completed, remove them from the sticks. Shape the bow ends to match the taper in the horn, and glue the horns on with Cascamite or some other strong glue. Make sure before the you do this that they fit the bow well and don't lean out of the line of the limb. This needs to be done well, as a badly fitted horn will spoil the look of the bow. When the glue is set, file the grooves that will hold the string. Clamp the bow so that about 6" protrudes and file away with a thin round rat-tailed file about 1/8" diameter with the groove being about a 60 degree angle at the sides, and not being above halfway up the taper of the limb inside the horn. If the groove is too high, the horn will break. Be careful not to cut right through the horn to the wood - while this is not a disaster, it will spoil the look of the bow.

Now it is time to put in an arrow plate. Mother of Pearl (cut from old buttons), horn, or contrasting hardwood is usual. This is more decorative than vital, and does add to the aesthetic appearance of the longbow. As you have already shot the bow, you will see where the arrows have rubbed on the wood just above the handle, so chisel out the desired shape and glue in your plate. When the glue is set, file and sand away the excess glue and waste. The plate only needs to be small, about 1" long, 1/4" wide and set into the wood about 1/16". The final finishing is to take some sandpaper of various grades, and work away at the bow, rubbing out all the scratches. Finish off with some steel wool to get that pearl-like bloom. You can also stain the wood if liked - make sure it is water-based, and only apply it to the degame. The reason for using water based products is to prevent the final coats of varnish from re-activating the dye and drawing it into the hickory, thus spoiling the effect.

Once the stain has dried, gently wipe with steel wool to remove any fibres the water has lifted up, then apply a thin coat of varnish. Lightly rub this down and apply a second and even a third coat if desired. Some people recommend a wax finish but this is not as durable as varnish. If any particulars are to be written on the bow - draw length and weight, makers identification etc. - do this with a fine pen in Indian ink before the final coat of varnish so that it is well sealed in. All that remains now is to polish the nocks with steel wool and then metal polish, and fit a grip of your choice. Upholstery braid, leather, and velvet ribbon on ladies bows are often used. It must feel comfortable to hold and not move in your hand, so be sure to glue it on securely with a waterproof glue. Your bow is now ready for use!



# Troubled Times

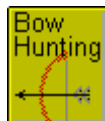

## Tilling

### LANGBOW

### FLATBOW

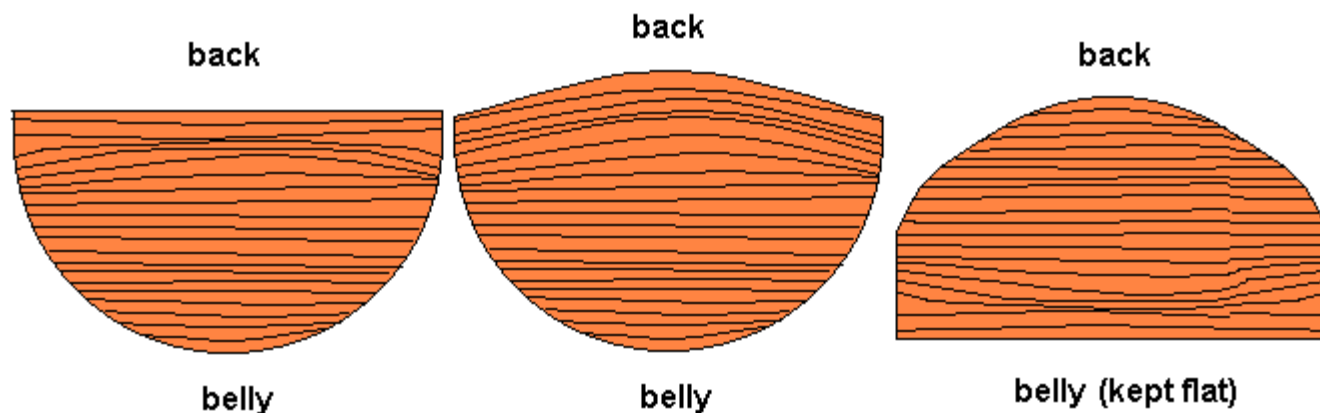

**(the back remains flat, or slightly convex, following the natural line of the growth rings and the sides and belly slightly rounded into a "D" shape. Wood is shaved off with rasp, spokeshave, drawknife or scraper until the appropriate tiller is maintained, all the time ensuring that the slope of the taper remains constant from handle to tip.)**

Tilling is the process of working a bow down evenly to reach the required draw weight at the required draw length and to ensure that bow limbs are balanced with respect to each other and ensuring that the "arc" of the drawn bow is even. The majority of the work here is simply removing wood from anywhere that is not bending enough, and \*not\* removing wood from places that bend too much. The final result is a bow that bends evenly throughout it's length. (Usually except for the handle section, although in some bows, even the handle section bends slightly.)

### Initial Process

Initially, wood is rasped evenly from the length of each limb on the bow. After a small amount of wood has been removed, rest the end of the limb on the ground, grasp the other end of the stave in one hand, grasp the center of the bow and press against the bowgrip. The object is to get the limb starting to flex evenly. Once both limbs have started to flex about 5-6 inches forward from the vertical, we are ready to move on to the more precise tilling. Initial nocks are cut 1/2" in from the end of each limb, sloping at a 45 degree angle from back to belly, using something like a 5/32" circular rasp, pocketknife or 4mm chain saw sharpening file. With practice, floor testing the bow can be used to get to within 20-30 lb. of the desired weight, when starting it is advisable to be a bit more cautious. (Floor-testing is resting one end of the stave on the ground and grasping the handgrip and end of the upper limb. Putting pressure on the handgrip causes the limb resting on the floor to flex, the amount of flex is determined by the amount of pressure applied to the handgrip.)

## Precise Tillering

The easiest way of doing this is to have a tiller stick and a pair of bowstrings. The first bowstring is a very heavy and very long one so the bow can be strung just by slipping the long string on without flexing the bow. The other bowstring is used later once the bow starts to flex evenly to about 12" or so.

The other alternative is to have a pulley rigged up in the workshop, so the bow can be drawn using a pulley and rope with the bow handle clamped down to the floor or bench, set up so that you can hold the rope and still stand back far enough to compare the developing curves. With a spring scale, this can also be used to determine the draw weight of the bow. It is also useful to trace the required curves on a section of wall or paper such that the developing bow can be compared against it. As long as both curves are graphed accurately, this helps to ensure that both limbs match perfectly when they are completed.

Offered by [Brian](#).



# Troubled Times



## Materials

### Tiller Stick

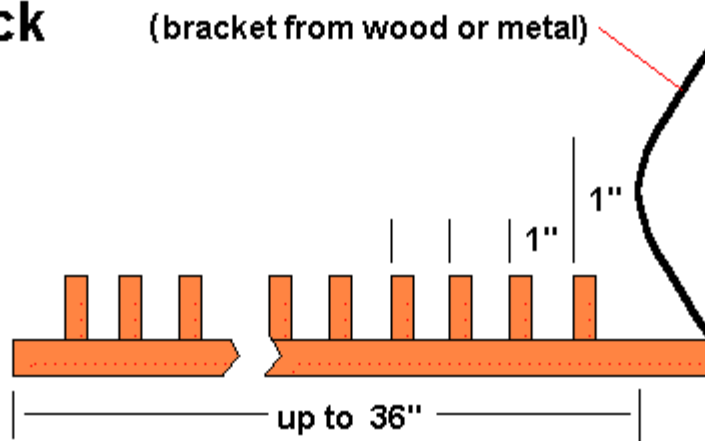

**wooden dowel pins glued/or slots cut into base at 1" intervals from bracket.**

The stick is made longer than you intend to draw the bow, up to 36" long is good, with slots cut into one side at every inch mark. The edges of these slots should be rounded so as to not wear the bowstring. The center of the bow rests in the hollow at the top of the tiller stick and the string is drawn down. This can be used to both show the current draw weight and also the current draw length. If the base of the stick is placed on a set of kitchen scales and the string drawn down level to the slots, the downward pressure on the stick shows as the draw weight on the scales. (The string must be held just clear of the stick to check the draw weight). Also, the string can be slid into any of the slots to hold the bow in a curved state while you stand back and look at it to check the developing curve. It is also useful to trace the shape of the arc on the wall/floor for various draw lengths to check shape/flexing. This is a sensible precaution to set up if you plan on making several different bows.

Once the first (long) bowstring is fitted, the bow is placed in the tiller stick and the string drawn till the bow has a small constant curve. From the first time the bow is bent, the curve must be gradually built up from a small gradual curve to the final state, flexing it slightly further at each stage. And once it starts bending, it should not be drawn to a greater weight than the intended final weight of the bow. (In fact, it should be worked to a couple of pounds higher than intended as it is likely to loose a couple of pounds in the final finishing). Once the nocks of the bow are flexing about 12-14" forward from straight, the normal length bowstring can be fitted and used from then on for testing. The belly of the bow should show the growth rings meeting in the middle of the bow as the curve develops, and these should be running steadily out to

the tips as the constant taper develops.

As the bow is placed in the tillering stick and drawn slightly, step back and look at both limbs. If they are not both curving equally, mark the places that are not bending enough, take the bow off the stick and work it down further. If there are areas that are bending too much, then don't touch these areas until those on either side are worked down so as to spread the curve more evenly. Both limbs must develop the same curve, and that curve should be fairly constant and even from grip to nocks. At every stage, and every time the bow is tested, check the curves of the limbs. Check the curve, get them even, then check the draw weight of the bow. Then draw the bow to the current distance several times (10-15), to exercise the wood. This allows the wood to slowly weaken and get used to bending. Once the curves are even, take the string down another notch in the tillering stick and repeat the procedure until the desired draw length is reached.

The final weight of the bow should be about 2-4 lb. higher than the desired weight. Final finishing (sanding etc.) plus initial shooting of the bow will cause it to drop the final 2-4 pounds so as to achieve the desired weight. When the bow is completed, it is usually preferable to glue a thin block of wood along the back of the handgrip, shaped to fit the hand better. Once the bow is sanded, it can be sealed with a decent polyurethane or similar to waterproof, seal and protect it. Alternatively use a polymerising gun stock oil such as Birchwood Casey Tru-Oil. Then fit nocks and handgrips as required. If desired, a backing strip can also be added before the handgrip block is glued in place. The backing strip is likely to raise the draw-weight by a small amount (2-5 pounds). Once the bow has reached it's desired draw weight, it should never be drawn to any greater draw length. To do so, greatly risks snapping the bow. So don't lend it to another archer without carefully supervising them.

Offered by [Brian](#).





# Troubled Times



## Nocks

Final nocks can be cut 1/2" in from the end of each limb, sloping at a 45-degree angle from back to belly, using something like a 5/32" circular rasp, pocketknife or 4 mm chain saw sharpening file. Care must be taken to keep the back of the bow as clean as possible, i.e. it should not be cut or worked at all when fitting the nocks. To do so is likely to cut the growth rings, weakening the limb.

### NOCKS (at each end)

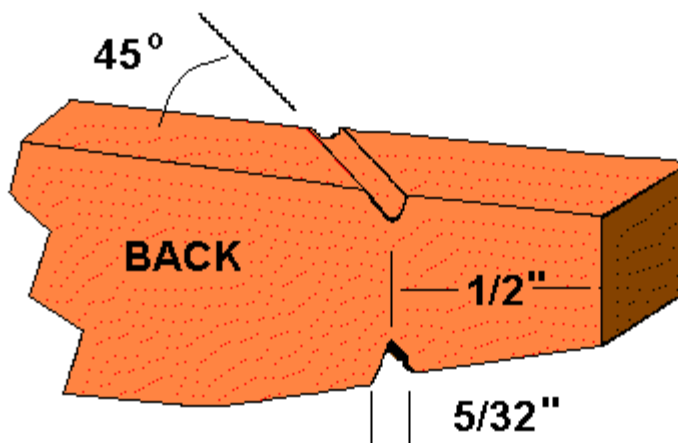

As an alternative, many longbows are fitted with antler or horn nocks, slid over the end of each limb and glued in place. This helps protect the wood from abrasion from the bowstring and is also quite decorative. To make these, take a section of antler or horn of up to 4" long and 1/2"-3/4" across at the base. The end of the limb should be shaped into a cone shape for about the end 1/2" of wood, and the base of the antler nock drilled out to fit. File or cut nocks into the antler, then spread a strong waterproof woodworking glue onto the end of the limb and slide the shaped antler nocks on, holding them firmly in position until the glue has set. Also, as another alternative to cut nocks, it is possible to tightly wrap sinew (or cord) around the nocking points of the bow and glue it in place. The string is then slid over the ends and held in place by the loop of sinew.

Offered by [Brian](#).



# Troubled Times



## Straightening

---

Virtually all all-wood (self) bows will slowly develop a constant curve during normal usage. This is termed "following the string" (Yew is one of the few woods which should return fully to its correct shape and even it will usually develop string follow.). This curving will effectively reduce the draw weight of the bow slightly. This curve can be removed by carefully and slowly heating the complete bow until the wood becomes slightly softer, the wood can then be curved to the desired shape and slowly cooled again. The whole bow should be warmed at the same time, not in stages, so this can be done in a section of pipe with the ends closed, and the heat applied to the pipe, rather than directly to the bow.

As long as the wood is not overheated or burned at all, it should return to straightness and recover most (if not all) of the lost poundage. This will, of course, not be permanent, but can greatly enhance the effective life of the bow. Because of this and other reasons, it is always a good idea to unstring any all-wood bow any time it is not required for use for more than an hour or so. Many modern composites (recurves and compounds) do not have this problem as much and are often left strung for extended periods, but for any self bow it is important to unstring them after use.

Staves made from twisted timber such as Osage Orange, can be straightened with careful application of heat from a gas stove provided that the timber is protected by application of fat or candle wax or similar to prevent burning. This method is also used to straighten bows which have developed curves or twists during use. Carefully and slowly heating the complete bow allows the wood to become slightly softer, the wood can then be curved to the desired shape and slowly cooled again. The whole bow should be warmed at the same time, not in stages, so this can be done in a section of pipe with the ends closed, and the heat applied to the pipe, rather than directly to the bow. As long as the wood is not overheated or burned at all, it should return to straightness and recover most (if not all) of the lost poundage. This will, of course, not be permanent, but can greatly enhance the effective life of the bow.

Offered by [Brian](#).



# Troubled Times



## Recurving

Recurving will usually significantly increase the poundage of the bow, without needing a greater drawlength. Recurving is bending the tips of the limb (or the whole limb) backwards in a curve. If this is done while the wood is wet or hot, the wood will retain the curve when relaxed, thus making the bow flex more when drawn. Recurves can be added to a bow by a variety of methods. One method is to glue extra lengths of wood onto the tips of the bow at an angle to the original stave.

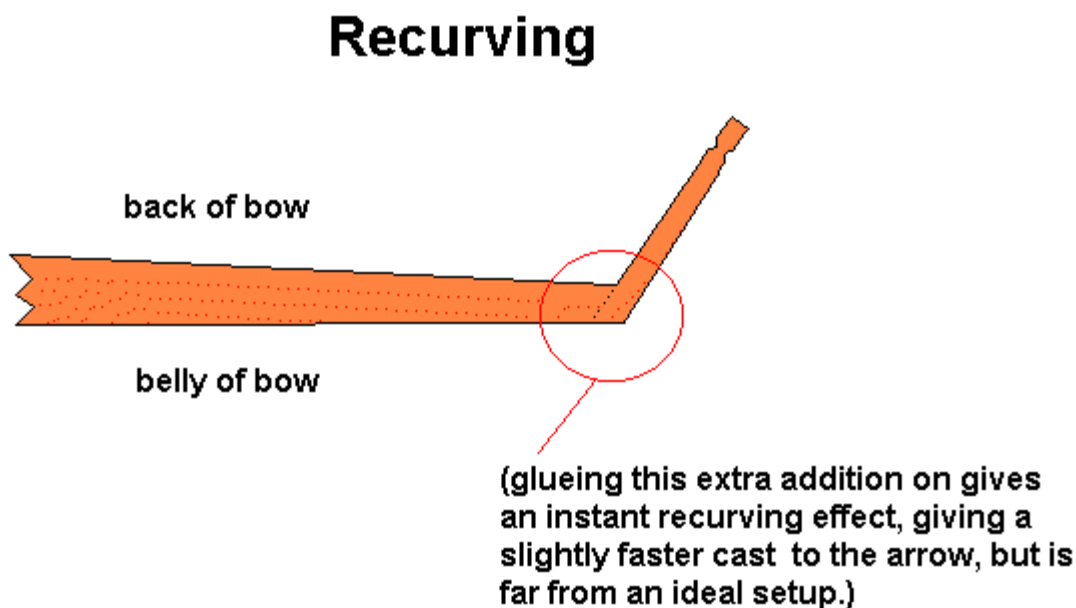

The more normal method to recurve a bow is to hold the area to be recurved over a pot of boiling water for quite some time, so that the steam slowly softens the wood fibres. After a while (20 minutes or more) the wood fibres will have softened enough for the limb to be fairly flexible. Shape it to the desired shape (Usually by wrapping it around something so as to give a uniform curve) then allow it to slowly dry and cool. Ensure that both limbs are recurved to the same extent, again ensuring that the curves in both limbs match at all times. Any mismatch in the flexing of the limbs will place an increased and unbalanced strain elsewhere in the bow, possibly with fatal effects (for the bow).

Offered by [Brian](#).





# Troubled Times



## Quickie Bow

Quickie bows can be constructed in less than five minutes from a variety of materials. And can have the added advantage of being a takedown (taken apart again for easy transport). Take just two branches whose cut dimensions are about 40" long, 1/2" in diameter at one end, and 1/8" or so at the other. Taper the wider ends and lash the limbs together overlapping the tapered faces to thicken the handle. Straight knot-less branches yield safer more efficient limbs. Tilling the final product will give a more efficient and accurate bow. Steeply tapered branches will permit 59" to 70" bows, an effective length range. Less tapered branches must be longer in order to tiller properly. Short low tapered limbs are too round in the handle, and too nock heavy, so efficiency suffers.

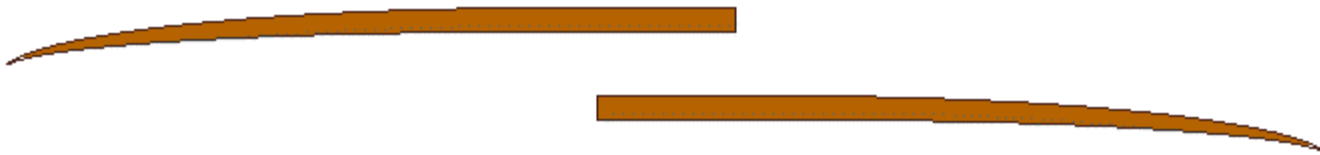

A simple two piece bow made from two similar branch arms, strapped together in the center.

(knotless branches are stronger.)



1

Another alternative is simple garden cane, or bamboo. With bundles of these you can raise the draw weight by increasing the number and also simulate tillering by using more cane mid bow, fewer canes towards the tip. Unlike a normal bow, each cane is strained independently. Strain on a single cane is the same whether bent alone or incorporated in a multi-cane bundle. Draw weight can be raised simply by adding canes. A good effective bow can be constructed from four 1/2" diameter, bamboo, garden supply bean poles. Good lengths are 23", 36", 54.5" and 70". Thick ends are staggered. Wrap every five inches. At 28" this bow will draw a staggering 58 lb. and cost practically nothing to make.

Even cane or thin bamboo lengths can be bound together to construct a simple, yet effective bow.

Alternatively many twigs strapped together can provide an adequate assembly.



(Information provided from *The Traditional Bowyers Bible*).

Offered by [Brian](#).



# Troubled Times

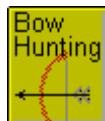

## Crossbow

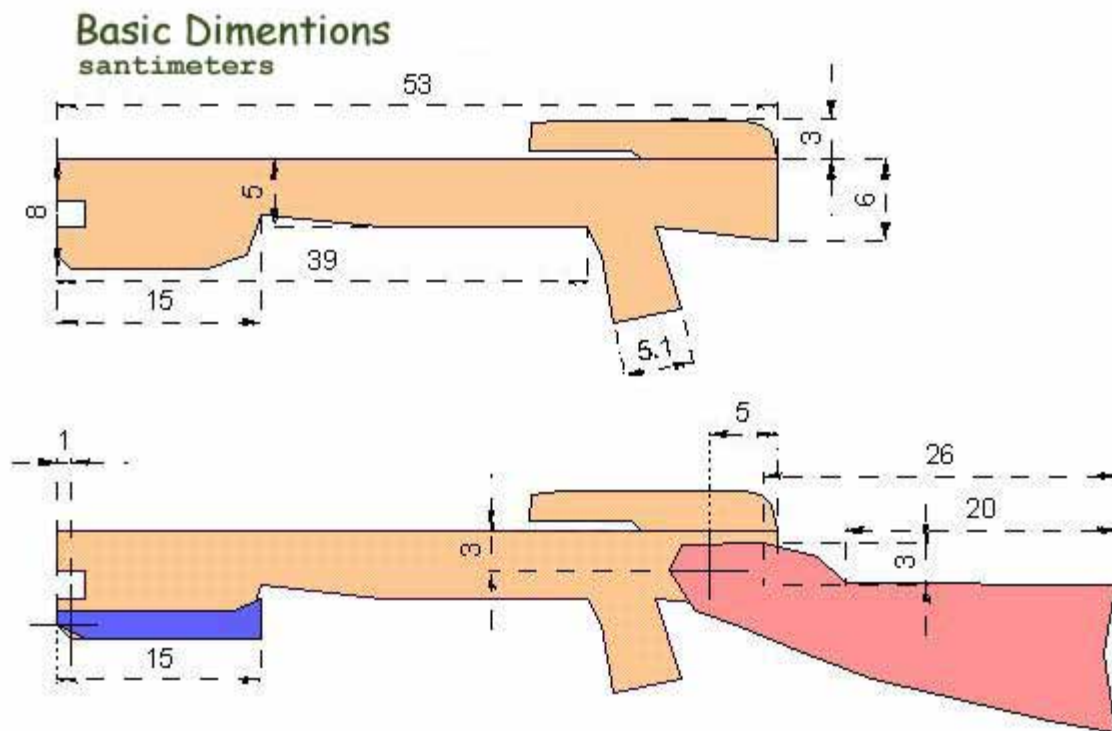

Material used for stock is Birch. The best material is the fiberglass, but I have not found a suitable piece of it. So, the first bow was made from some unknown plastic, found in the garage. It was 65 cm long and has about 37 kg draw weight. All was OK for some weeks, but then it got a terrible string follow. My current prod is made the next way: I took an old slalom ski, sawed back part of it, then cut it lengthwise. Thus I got limbs and mounted them on central section with long bolts. So I got a prod which is longer than normal, but it works well, and does not have any string follow. It's draw weight is about 43 kg.

Alternatively, commercially produced prods can be purchased from several manufactures at a fraction of the cost of finished crossbows. One such supplier is:

**[Alchem Incorporated](#)**  
 314 East 195th St.  
 Euclid, Ohio 44119  
 (216) 313-8674



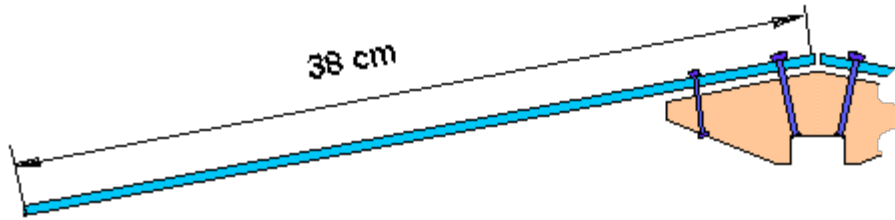

Offered by [Brian](#).



# Troubled Times



## Assembling

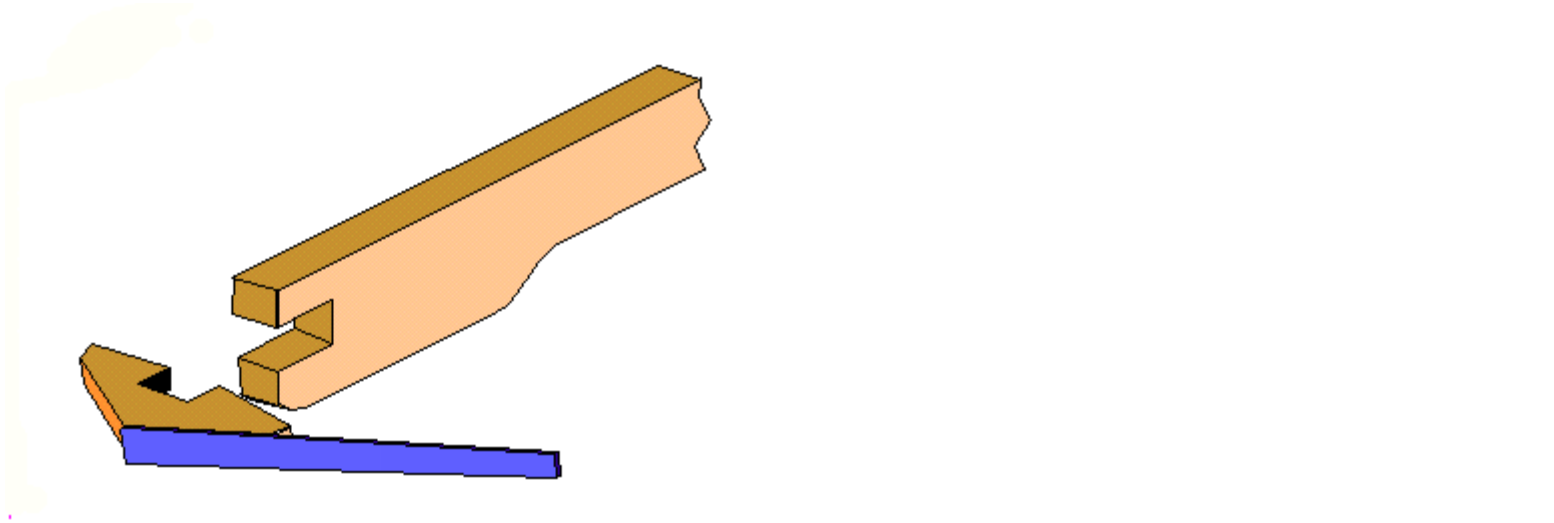

Of course, I wanted to make a prod removable. So, I took a catch from old-fashioned ski binding and used a resilient hook. When the catch is locked on the hook, the hook folds and clasps the prod to the stock. Notches on the stock and on the prod fit into each other and the prod is reliably fastened into place. Here is the general scheme of what it looks like:

And here is a more detailed drawing:

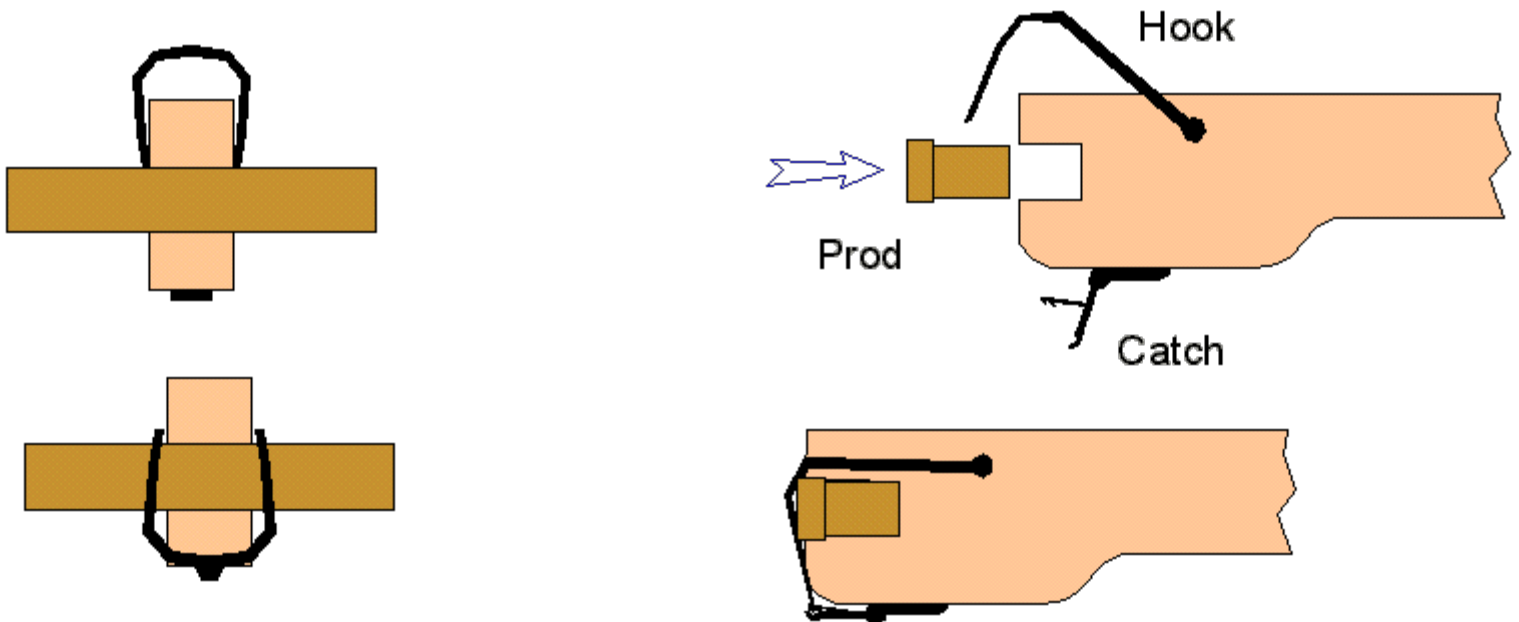

Offered by [Brian](#).



# Troubled Times

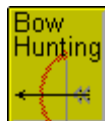

## Release

I made a simple mechanism, containing only two steel details, including a spring.

### Release mechanism action

Cocked

Released

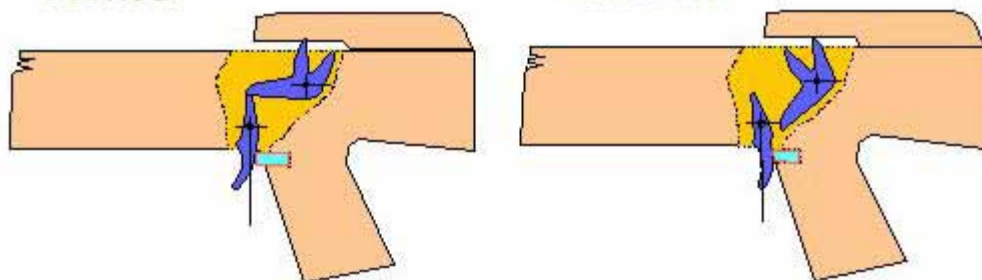

I hope pictures show how it works.

### Release Mechanism

millimeters

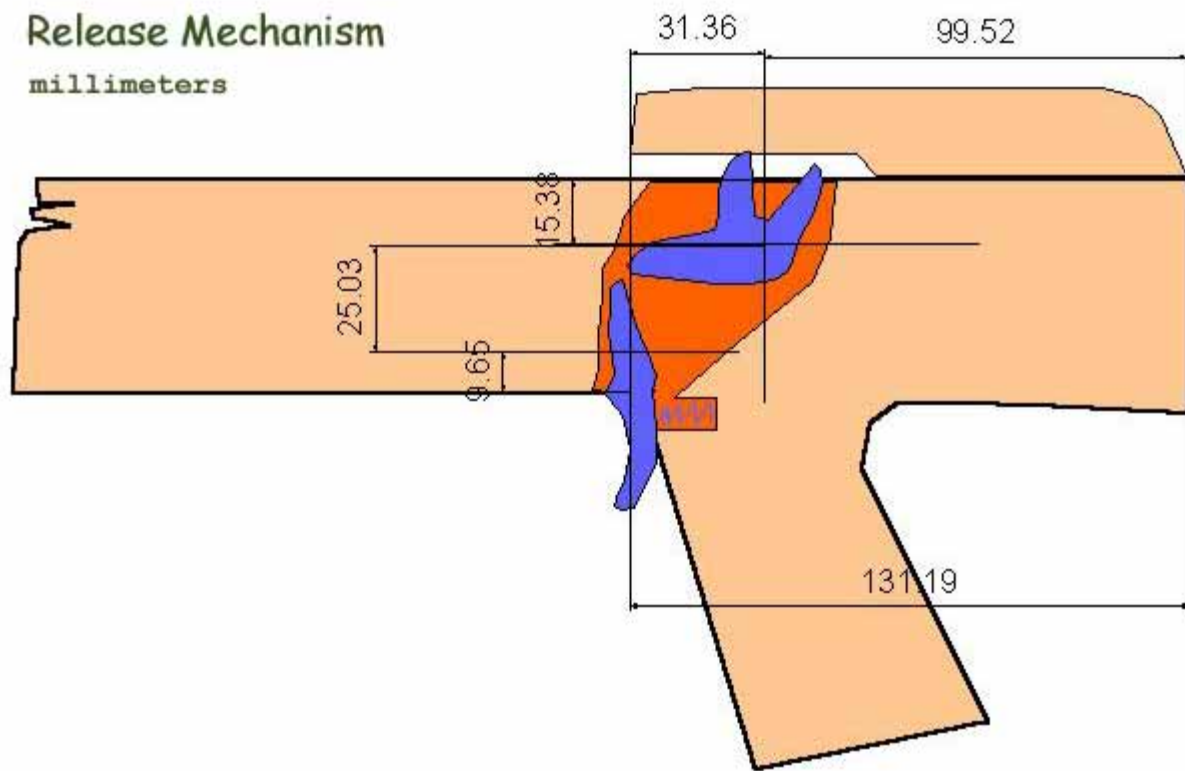

Here are the release mechanism dimensions:

# Release mechanism dimentions

millimeters

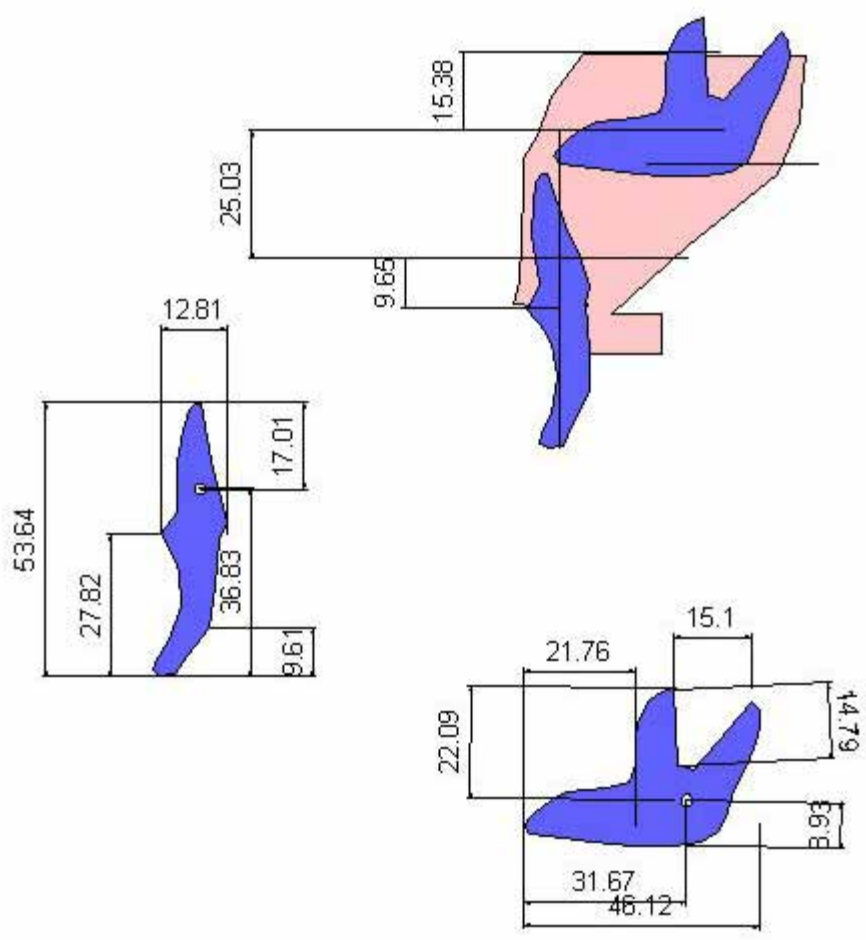

Offered by [Brian](#).



# Troubled Times

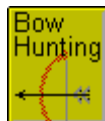

## Amtguard

These plans only cover the difficult parts of the design, the actual trigger bar up to you. OK, the design is inefficient, but it *can* be built with nothing more than a Dremel and only costs about \$15.

### Materials

- (2) solid fiberglass bicycle flagpoles from Wal-Mart (1/4" diameter)
- (1) Parson's leg, 2x2x28"
- (10) 1 1/8" washers with 3/16" center
- (3) small nails
- 25-1/2" crossbow string from Wal-Mart
- lots of 3/4" fiberglass strapping tape
- a large table spoon

1. Cut the fiberglass pole into (3) 26-1/2" segments and (2) 10" segments using an abrasive cutting wheel or by taping and cutting with a fine-tooth hacksaw.
2. Mark the center of each piece.
3. Arrange the cross section like this: (all the centers line up). These 2 are the short ones .

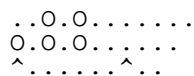

4. Tape together the 3 long ones first (but not in the area reinforced by the 2 shorter dowels). Use about a 10" piece of tape wound *very tight* as many times around as it will go over itself. Don't go down the line, just make a band. All the bands will be adjacent, but make every other one first and then fill in the spaces between. It is important not to work a twist into the bow.
5. Make the reinforced portion with all 5 pieces in its cross section by taping in a similar manner.
6. Do something to keep the bowstring from slipping down, I taped on little 1" chunks of dowel on the front side.
7. Put a drop of silicone oil down the ends of the 3-dowel set.

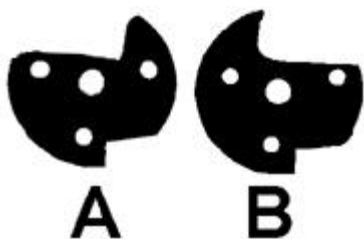

The nut is the other difficult portion. No foundry to cast it, I assume. So get out them washers.

1. Cut out 6 of "A" and 4 of "B" with a cutting wheel.
2. Drill out the holes, preferably using the first as a guide to be sure they line up.
3. Put 2 of "B" on either side of a stack of "A". The top jaw part faces the opposite direction. The notches on bottom of all 10 pieces should line up.
4. Get 3 nails that fit really tight in the holes and put them through. Cut off most of the excess and hammer down the stump flat like a rivet.

As for putting a lever on the trigger, it goes something like this: I made mine out of a chunk of



chain line fence "tension bar" that I bent into shape and put a little pivot on. Bow tips that curved forward would significantly improve this design, but I've got no idea how to make ones that would stay put, they take enormous force and the dowels shear past each other when pulled, changing the shape it would mount to. The Parson's leg is just a cheap convenient piece to use for a stock. The spoon can be bent and fixed as a trigger guard.

Offered by [Brian](#).



# Troubled Times

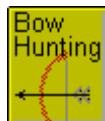

## Non-Wood

---

I have seen pistol crossbows in 80lb pull plastic fiber and aluminum body for \$20 to \$40. 120 lb. rifle crossbows in fiber, metal, wood stock between \$80 and \$130. One such source is **Dan Funk** 760-747-1666 P.O. Box 787 Vista, CA 92085. One could tape on a laser pointer to the sock and I expect one could get somewhat good at hunting small game. Use some of that florescent paint or tape on your arrows so you have a better chance of finding them in the dark. Along this line the 50 lb plastic (\$10) and the metal body (\$13) are the most common found pistol crossbows. These are junk or target practice only as you have described. The 80 lb I consider usable for some instances. Teaching a growing youngster to hunt very small game as an example. You wouldn't want to shoot a rat with a 120 lb or 150 lb crossbow. There are gradients to all things.

Offered by [Mike](#).

Spend a few bucks and go buy a compound fiberglass one that would last forever. Put in a supply of ommercial (straight) arrows and make it put of your pole shift supplies. Ash and elm not available everyplace and may be hard to find when you need it. Easy to find the commercial variety now!

Offered by [Michael](#).

I purchased on of these before, their quality makes them unreliable and their low poundage decreases usable range, and lethality. Also, aiming with any pistol configured weapon, crossbow or gun, is going to be less acurate than a rifle. If you were to go with crossbow hunting, I would pitch in for the more expensive, more powerful, more acurate rifle crossbow. Arrows are not always reusable (if the arrow breaks) or retrieval (if the animal gets away) so its better to be right on target - with a confirmed kill.

Offered by [Ted](#).





# Troubled Times



## Compound Bow

The composite bow handle can be constructed from wood or alloy.

For wooden composite bow handles, cut the stave in exactly the same method as for the flatbow and longbow, using the grain of the wood to strengthen the stress against the limbs.

I have chosen wide bow handle arms which allow different widths of bow limbs to be fitted, but they can be thinned to suit what ever width of bow limb you desire.

The fixing bolt can be drilled all the way through the bow arm to secure the limb or a countersunk female thread insert can be drilled and fitted.

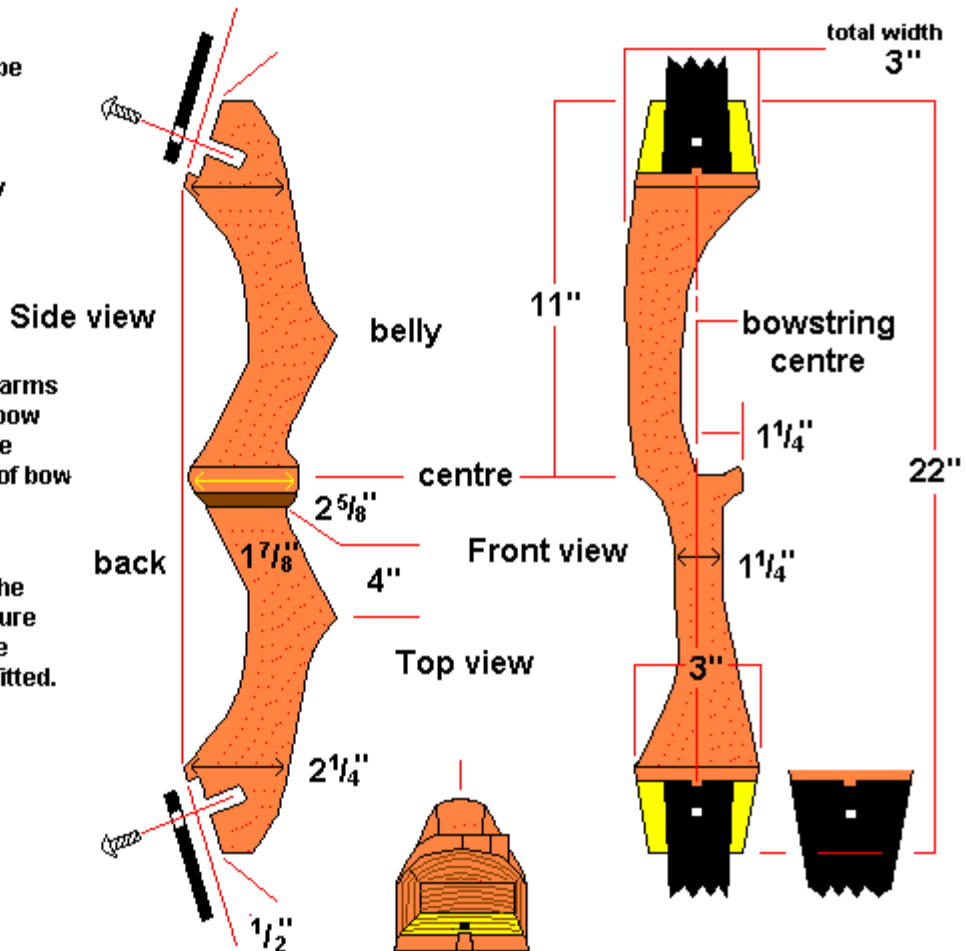

Offered by [Brian](#).



# Troubled Times



## Wood

This compound bow is of my own design and which I have been working on these past few months. I wanted a design that was simple for anyone to construct, yet strong enough for any range of pulling strengths. It is constructed from 3/4" white wood board lengths, glued and shaped into a compound arm. For added strength the pieces could be strengthened with screws, but most glues will surface. It cost me practically nothing to make as I constructed it from existing wood pieces and has now been stained and varnished into a very professional looking piece. (But remember if you are left hand predominant the arrow rest will fall on the left, not on the right as illustrated. So the bow will have to be constructed as a mirror image of the one below.) All that is needed now are two matching limbs. (Note: not all left handed people are left handed archers. You will need to find out which suits you best.)

**This construction is made up of 3/4" board lengths cut and glued together to achieve the same result as a solid carved piece.**

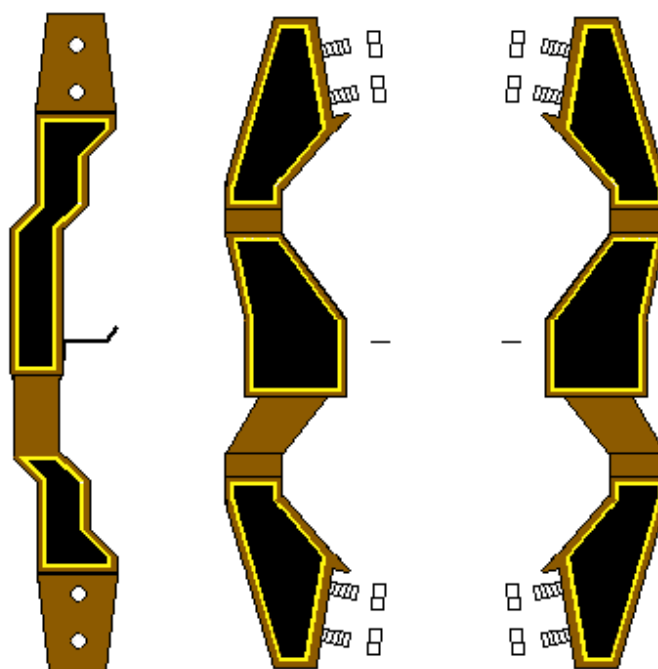

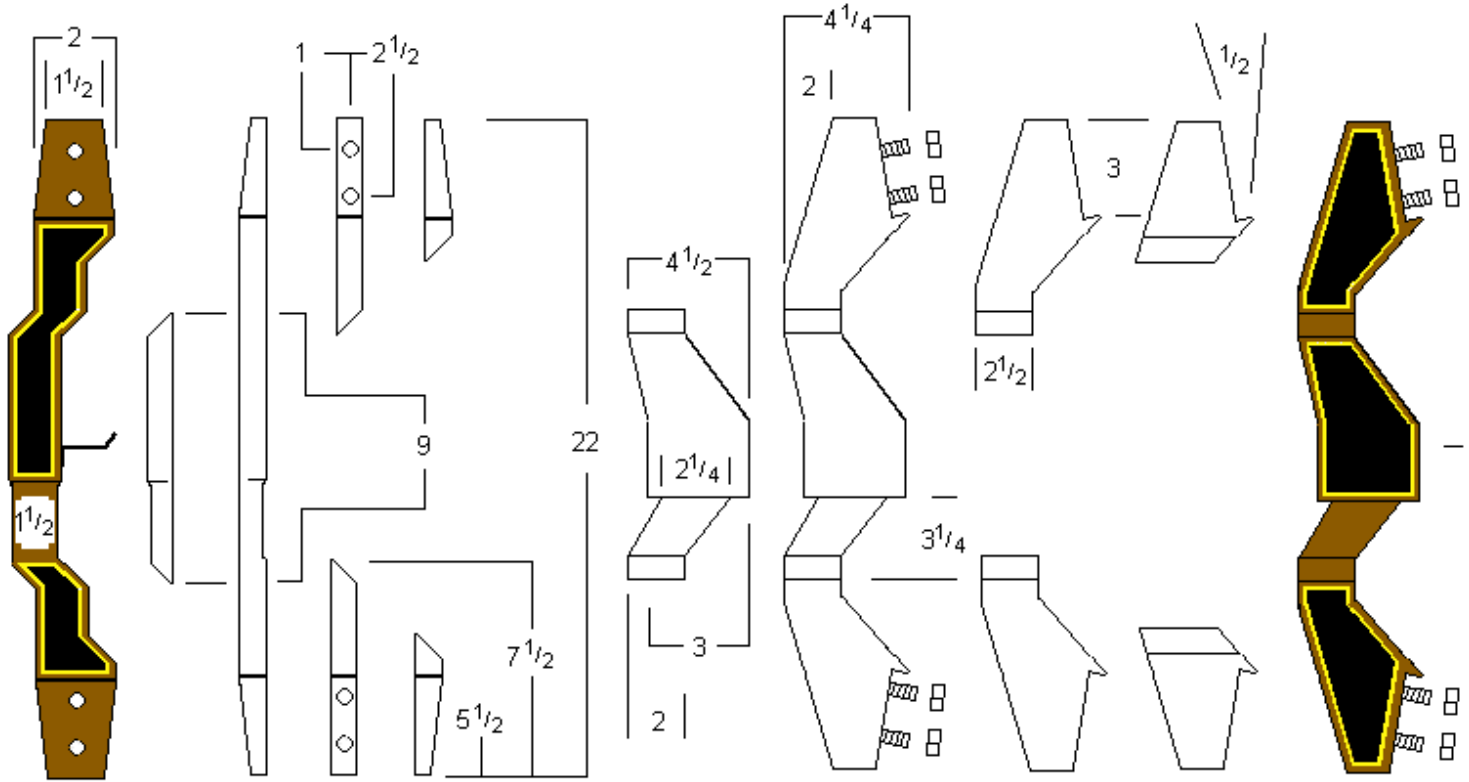

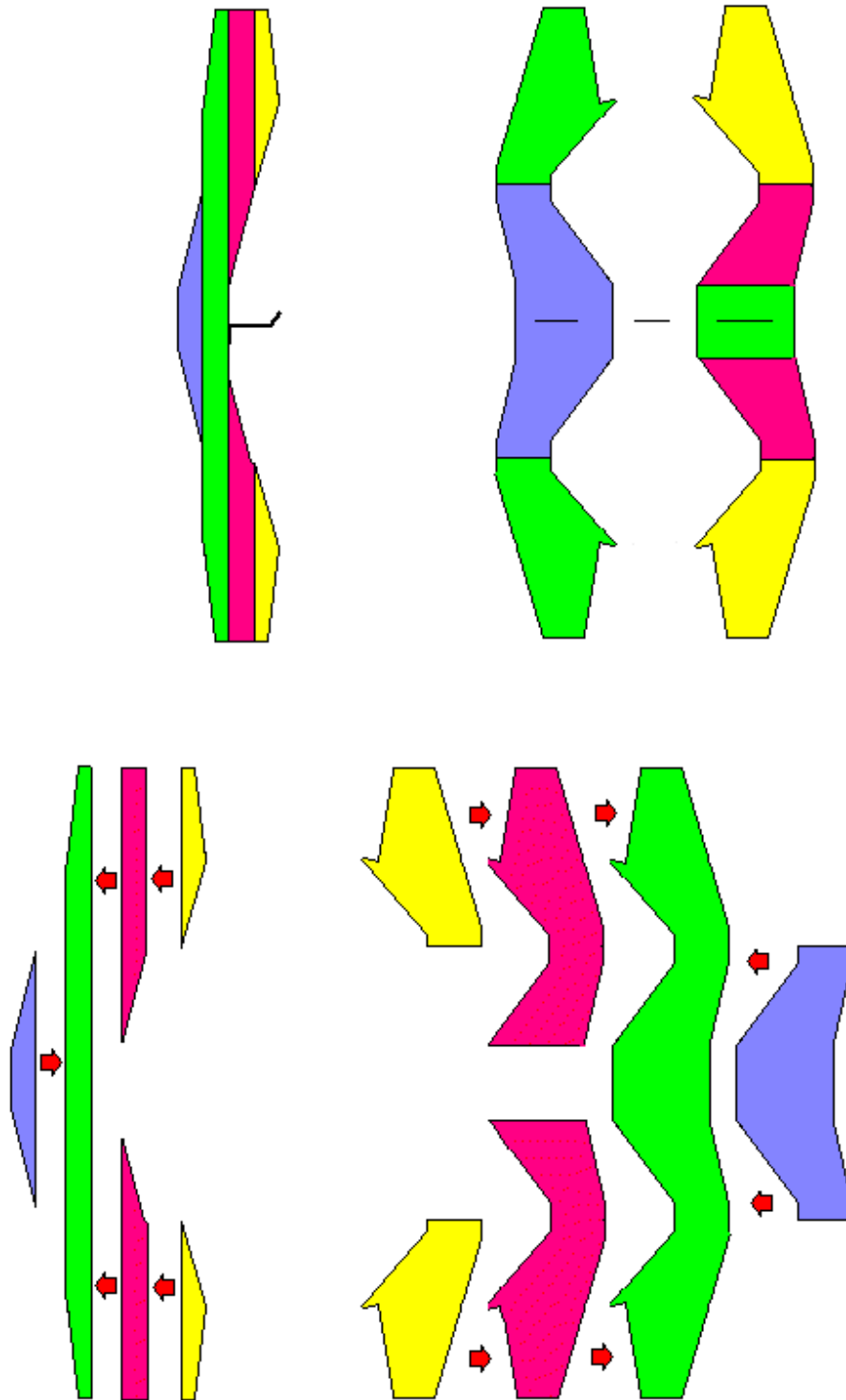

Offered by [Brian](#).



# Troubled Times



## Composite

The composite bow handle can be constructed from wood or alloy.

Even a simple compound design can be used and will serve the same purpose as any complex design.

### Simple composite bow arm

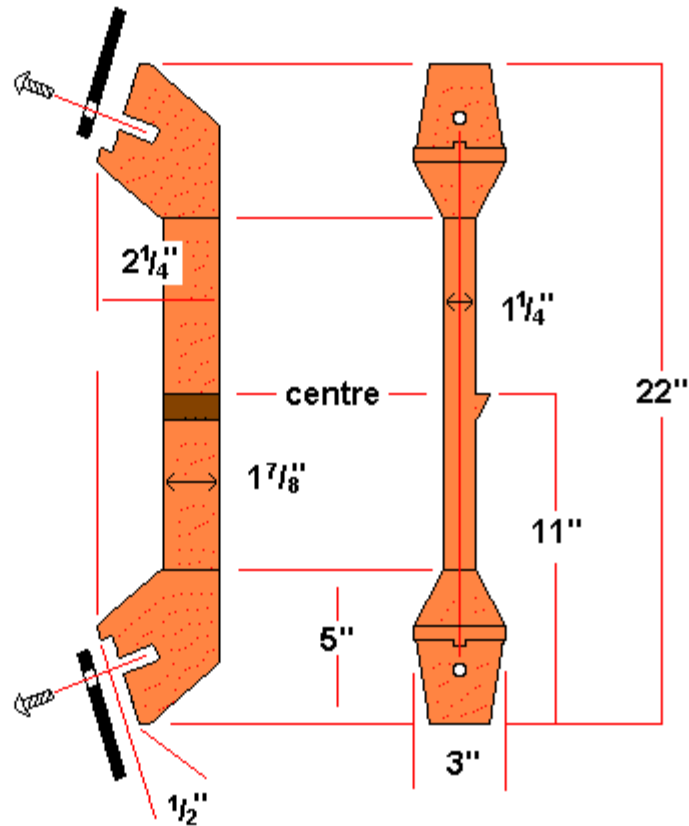

Offered by [Brian](#).



# Troubled Times



## Steel Arm

### Simple composite bow arm

Side view

Front view

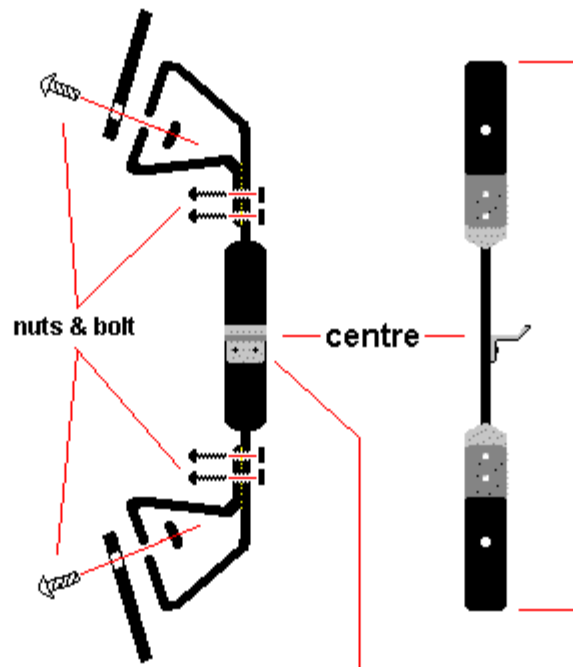

Steel bar bent drilled and screwed together for added strength. The middle section can be twisted sideways to provide a better handle and a near to true bowstring center.

Arrow rest bent and bolted onto center frame

Offered by [Brian](#).



# Troubled Times



## Steel Pipe

### Simple composite bow arm

Even a simple compound design can be used from metal pipe and will serve the same purpose as any complex design.

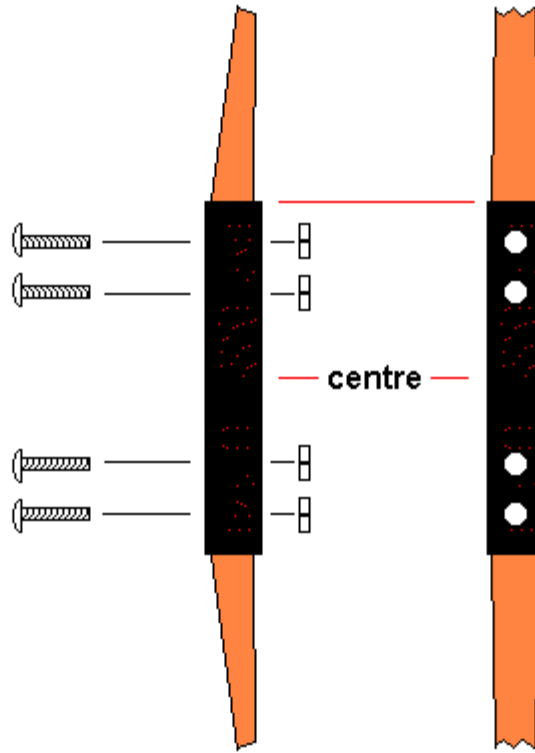

Offered by [Brian](#).



# Troubled Times



## Bowstrings

---

These were normally made of hemp, gut or silk and either twisted or plaited with beeswax (for waterproofing) to the desired length. I have heard that steel strings were sometimes used for some of the middle eastern bows, but have not found references for this (and would hate to be using one if it snapped during use. The thought of steel wire under stress snapping close to the check and eye with 50+ pounds of tension on it doesn't inspire me). Often a loop is placed in one end, and the other end left hanging. When the bow is strung, this end was tied using a bowyers knot (now called a bowline knot).

Other methods allowed the maker to plait or twist a loop into either end during construction (e.g the Flemish twist method). Turkish strings were made with separate end loops (tundj) tied to the string with a special knot (same with Chinese, Mongolian, Persian and Tatar, probably others as well too) allowing it to be shortened or made longer to fit a particular bow/archer, the loop added stability to these short recurves. Recently I was informed that the researchers on the Tudor ship "Mary Rose" have found their first complete bowstring of the period. It was preserved intact under the cap of it's unfortunate owner. The string itself is a very strong variant of English linen, although whether plaited, woven or endless string I am unsure.

Offered by [Brian](#).





# Troubled Times



## Spun

At its basic, thread can be spun from an ordinary, easily constructed drop spindle or spinning wheel.

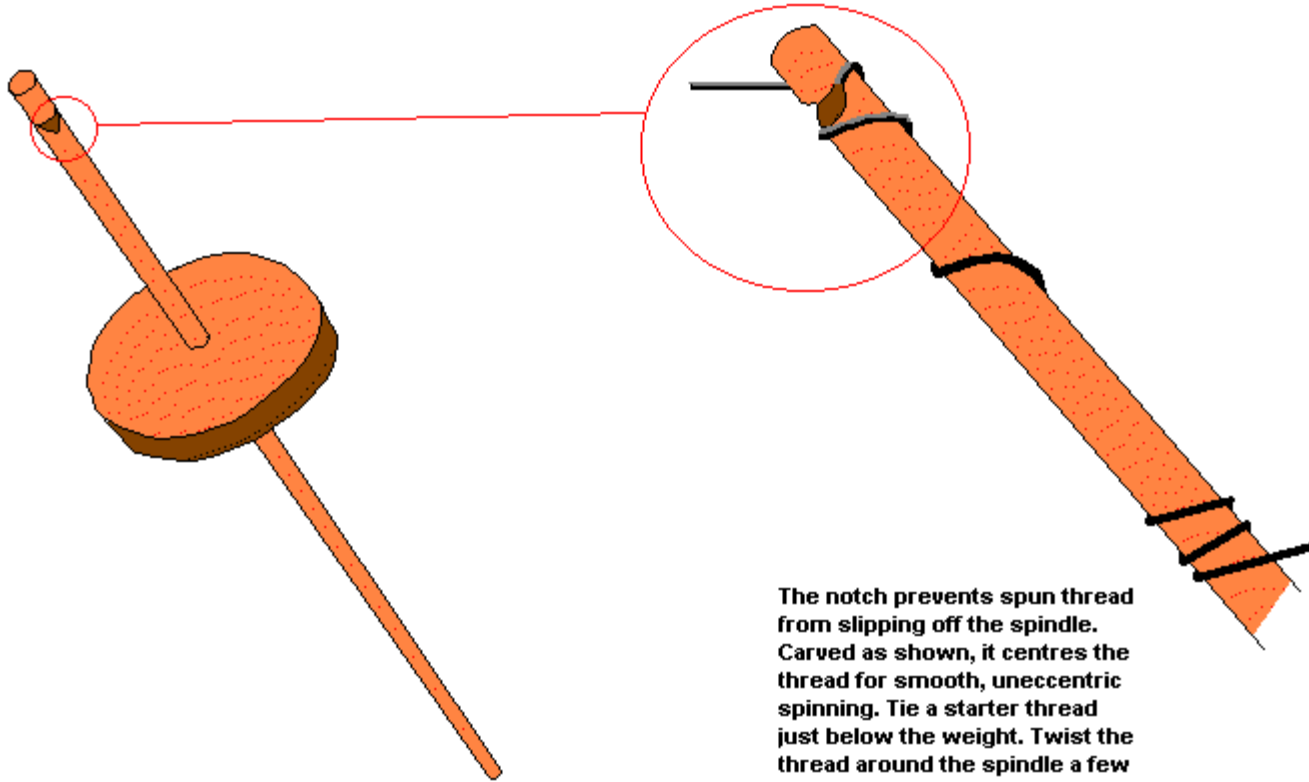

drop spindle

The notch prevents spun thread from slipping off the spindle. Carved as shown, it centres the thread for smooth, uneccentric spinning. Tie a starter thread just below the weight. Twist the thread around the spindle a few turns, then run it through the notch, leaving about eight inches free.

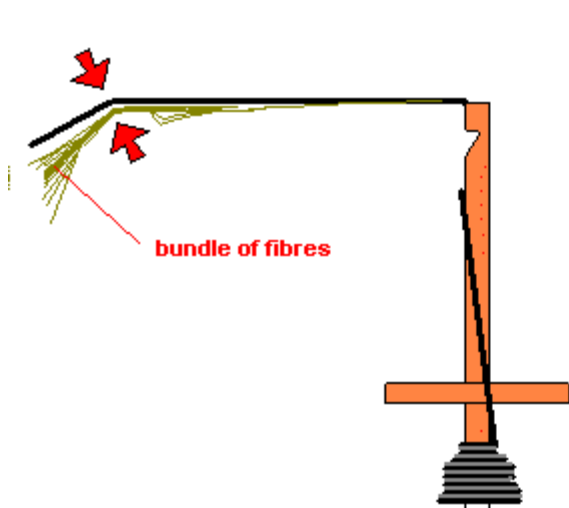

bundle of fibres

From a bundle of combined fibers, draw out sufficient fiber to lay over the starter thread. Twist both together. Pinch and hold end of thread.

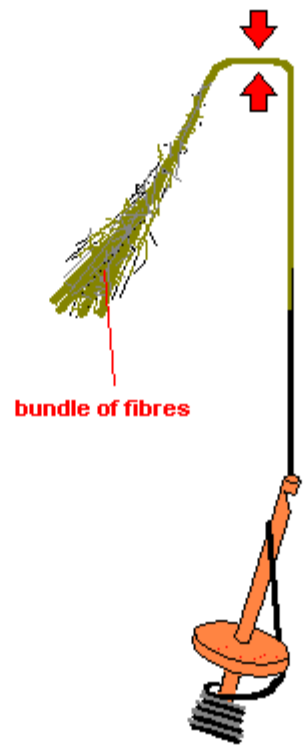

bundle of fibres

arrows indicate where to hold thread.

Let the spindle hang free. Twirl the spindle until the starter thread and the fiber are twisted so tightly they try to kink. Do not let any of the twist escape up into the spun fiber.

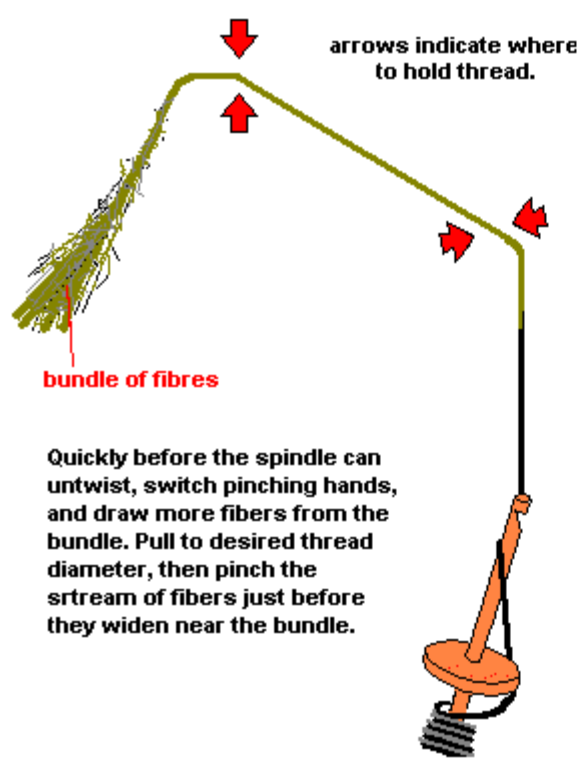

bundle of fibres

arrows indicate where to hold thread.

Quickly before the spindle can untwist, switch pinching hands, and draw more fibers from the bundle. Pull to desired thread diameter, then pinch the stream of fibers just before they widen near the bundle.

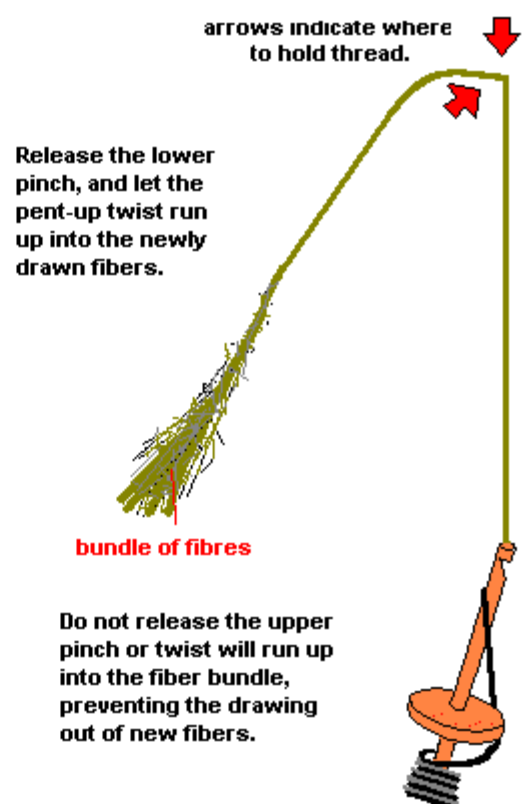

bundle of fibres

arrows indicate where to hold thread.

Release the lower pinch, and let the pent-up twist run up into the newly drawn fibers.

Do not release the upper pinch or twist will run up into the fiber bundle, preventing the drawing out of new fibers.

Offered by [Brian](#).



# Troubled Times



## Rawhide

I have found a good source of rawhide for backing bows in the local pet shop. They sell rawhide doggy chews that are about 18 inches long, composed of a tube with a knot in each end, looking rather like a shabby femur bone. Other pet shops I have asked knew about these large chews and were prepared to order them for me. The first task is to choose good material. These chews are a sort of dirty buff color. Reject those with obvious flaws, such as splits, and try and get hold of those with an even coloration. They are translucent, so surface blemishes show through, but I haven't experienced problems, even with quite thin areas in the material. In order to un-knot them, you have to soak the whole chew in cold water for about 2 days. The knots in the ends then come undone quite easily. My chews consisted of one single piece of rawhide about 36 inches long, 6 inches wide, rolled into a tube and packed with other bits of rawhide about 6 by 11 inches.

Once the pieces of hide have been separated and while they are still soaking wet (they are now white and sort of blubbery), you can smooth the surface. The hair side is usually OK, but the inner surface can be a bit rough. I clamp a steel straight edge in a vise and just draw the surface over the steel edge a few times. This scrapes off a lot of loose-hanging bits. Next put the rawhide you will be using into a bath containing cold water with about 2 ounces (a scant handful) of washing soda per gallon dissolved in it. Leave for 24 hours to degrease the hide. Take the hide out of the bath, rinse it quite well under running water and then roll it up in damp sacking for 24 hours. This renders it damp enough to work with, but not wringing wet. I have backed both board bows and stave bows with rawhide. Stave bows are easier due to their lightly rounded back, so I shall deal with them first.

The best glue to use is hide glue. It works like a charm. Put a handful of hide glue granules in an old tin can and allow it to soak overnight in just enough cold water to cover it. If you don't have a glue pot, cover the bottom of a saucepan with marbles or pebbles so as to support the tin can free of the bottom during heating. Fill the space between tin can and saucepan with water and heat the whole contraption until the glue is fluid. Thin with water to get a syrupy consistency. Stir well. Take the stirring stick out of the glue and watch the glue dribbling off it. If it drips in splashes, the glue's too thin. If it doesn't flow easily - too thick. A thin, consistent stream is about right.

Take your bow and clean up the back with fine sandpaper to give a clean, grease free surface. I usually wipe it over a couple of times with a cloth soaked in acetone to ensure really grease-free conditions. It helps if the bow is mildly reflexed before backing. Tie a stout cord to the nock ends, take a loop over a screwdriver or other lever in the middle of the cord, and twist the lever to cinch up the bow into about 2 inches of reflex. Tie off the lever to the cord. Mount the bow in a bench vise with the reflexed back uppermost. As soon as the bow is clean and grease free, paint a thin layer of hot glue over the back surface to seal and prime it. Allow the priming coat to cool and set (overnight). Meanwhile, you can cut the rawhide to shape using a hobby knife. Do this on a clean surface because you don't want dust and grit on your wet rawhide. Allow plenty of overlap over the sides of the bow as the hide shrinks as it dries. The hide will have to be jointed, preferably under the hand grip. I use a skiving joint, where the overlap is about 0.3 to 0.4 inch. I've done it in two ways: the proper way, where you bevel the mating edges of the damp hide using a sharp hobby knife before you apply the backing. And the lazy way: Back half the bow. After about a day, bevel the glued down backing at the joint and back the other half of the bow, using a generous (1 inch) overlap. When the backing is dry, you can grind / sand / rasp off the excess, leaving a neat surface.

Backing the bow is a simple operation. Get everything ready before you start. Make sure the glue's nice and warm and running like table syrup. Paint a thin layer on the back of the bow, running down over the sides. Place the backing strips in place on the bow, starting at the center and smoothing towards the limb tips. Glue the joint. Don't worry that the glue gels almost immediately: the dampness in the hide causes the glue to swell and form a bond. Now take a

bandage, minimum 2 inches wide (as used for first aid) and, starting at the handle, bandage the bow and backing tightly. Overlap the turns of the bandage by about an inch. Fasten off the limb tips tightly with a string whipping. Just to make sure, I now usually use a second layer of bandage over the first. Restrain your impatience. Remove the bandage layers after 48 hours. Re-whip the joints and the nock ends with string.

Allow the bow to dry out for at least a week. A month might be better. Then remove the whippings and the cord used to strain the bow into reflex. The rawhide is now as hard as finger nail. Carefully trim off the excess using a hook knife (as used by carpet / lino fitters). Rough edges can be trimmed with a Surform, and final trimming is done with a spokeshave, set for a fine cut. Allow the bow to cure for about another month before finishing it. I sand off the rawhide surface with fine-grit paper, giving a very smooth surface, before decorating and varnishing the bow. I use yacht varnish. Several coats, sanding between coats. Pay particular attention to the sides and the joints, where rain can seep in.

You can also use the same technique with other parts of the bow. Since my last bow was only 3 millimeters wide at the nock ends, I fashioned nocks from a thin strip of wet rawhide, folded over a thin piece of wooden dowel, then glued and whipped on. Nock-shoes and arrow plates can also be made. Backing a flat-backed (de-crowned or board) bow is similar, but I have found it useful to use a pressure distributor in the form of a strip of aluminum with a T-shaped cross section. I place this with the wide flat area in contact with the bandaged back, then tie up the whole works tightly with cord. Be aware that, when varnished, the rawhide backing goes almost transparent. So you can see the wood grain through the backing. You can also see any air bubbles and imperfections in your gluing technique! I have found a rawhide backing to be immensely strong. It also recovers fast: when just unstrung, you can see the bow visibly creeping back to its normal conformation. If it has a drawback, it's that it is relatively heavy and doesn't add to the bow's cast. Set against that, it's like armor plate, and protects the bow against dings and scrapes, as well as other archers who may want to have a go with one's pride and joy.

Offered by [Brian](#).



# Troubled Times



## Cord

Although you wouldn't think it string is relatively easy to make. At its simplest they are but two parallel fibers twisted together into a single ply cylinder or cord. A crude bowstring can be made from such a simple, single-ply cord. Its main body will hold together surprisingly well, but at the nocks it quickly frays and weakens. Another problem is that if single-ply cordage is not kept permanently twisted, it tends to untwist into its original useless disconnected fibers. To make durable, practical cordage we need to prevent the untwisting and this is an almost natural process. If we twist up a cylinder of fibers and continue twisting until the cord begins to kink, then let go the cord will instantly wrap around itself creating a two ply cord, now having neutral twist. Some of the original twist will be used up in the process but enough will remain to supply necessary friction within each ply. A stable durable practical cord results.

This principle is therefore applied in the making of all traditional and modern day string making, although there are many techniques for making cordage. Most are difficult to master through text and illustrations alone. But they are all based on twisted-fibers-will-make-themselves-into-cordage principles. Once you twist the fibers tightly all you have to do is get out of the way and string happens.

### Single Ply Cord

a cylinder of parallel fibers twisted tightly enough to function as cordage.

### Simple Ply

a single ply cord used as the primary building block of reverse-twist cordage. It can be thin or thick, an entire ply, or one of many in a simple parallel ply.

### Simple Parallel Ply

many small, simple plies, the sole purpose being to give uniformity; they are used in parallel lines as if a simple ply.

### Primary Ply

one ply in a simple cord, when this simple cord is one ply in a complex cord.

### Complex Cord

where each ply is itself a finished simple cord

Also crafting a superior bowstring requires more than simply selecting the strongest fibers. It matters very much how the fibers are assembled. Finer fibers have more surface area, therefore more points of contact, therefore greater internal friction. When given a choice, select or shred fiber as thinly as possible without damaging the fiber. Smooth-surfaced fibers slip past each other more easily, and therefore must be twisted tighter. This weakens the finished cord. Short fibers must be twisted tighter than longer fibers, also weakening the finished cord. (Excess twisting also shortens the length of the string. This means a longer string is needed, which increases mass.) Excess twisting makes a string more coil-spring-like, causing a bowstring to stretch and absorb energy as it slams home after release. Energy absorbed by an elastic string is unavailable to the arrow, thereby reducing its poundage and speed.

Offered by [Brian](#).



# Troubled Times



## Many Ply

Strings made up of many small-diameter plies, properly twisted together, are stronger than those made of fewer larger plies. The outer layers of a thicker cord have a larger diameter than the inner layers. When twisted, its outer fibers are asked to stretch and travel a longer, more spiraled path than the inner fibers. These outer fibers try to relieve the strain by shortening their path. They accomplish this by:

1. Squeezing and contracting the cord's diameter.
2. Shortening the cord - central fibers are actually telescoped into negative tension.

When such a cord is strained in tension, its pre-strained outer fibers must necessarily break first, leaving fewer and fewer near-surface fibers to resist the load. Also inner fibers of thicker cords have not been twisted as severely as the outer fibers, relying on compression from the more-strained outer fibers to create their cordage-making friction. Once these outer fibers break, inner fibers are able to pull apart more freely. Thread thin cords, on the other hand, have smaller inner cores for outer fiber to wrap around. When twisted, outer and inner fibers therefore feel nearly equal strain, and near equal cordage-making friction. As a result, outer fibers do not break more quickly than inner fibers. Thinner cords therefore have a lower percentage of central dead weight. They are stronger per mass.

For maximum efficiency do not use more than seven parallel plies in a ply. No more than seven plies in a simple cord and no more than seven cords in a complex cord. If more than seven the cylinder becomes too thick, causing some plies to remain internal. Equally important is mass/strength is the uniformity of the simple plies. For example, a spool of high quality, wet spun, single ply line linen had an average breaking strength of 5lb., but when a 50-inch long strand was tested, breaking strength dropped to 3lb., and when a series of 5-inch long sections of a long thread were tested breaking strength varied from 3 to 7lbs. If seven such plies are kept separate and parallel they will each break at their weakest point of 3lb. Their collective breaking strength being 21lb. (7x3) But if these seven plies are twisted tightly into cordage, with weakest points placed next to strongest, weak and strong will average out, and combined strength will be 35lb.

Thread Count	Breaking Strength	Breaking Strength per Thread
40	150 lb.	3.75 lb.
20	75 lb.	3.75 lb.
10	40 lb.	4 lb.
7	35 lb.	5 lb.
5	23 lb.	4.6 lb.

What we conclude from all this is that cordage made up of several, very small diameter simple plies will be considerably stronger per mass.

Offered by [Brian](#).



# Troubled Times

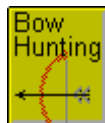

## Strength

---

To test cord strength, stretch and set, secure a thread or string to be tested around a smooth, round surface. Take a couple of turns before tying off. If secured properly breaks will occur randomly along a strings length. If secured improperly, breaks will occur near the fastened ends. If a string is to be used by itself, or in parallel with others test a section several feet long. This will reveal the strength of its weakest point. If a string is to be twisted together with others in a cord, determine its average breaking strength: first break long sections to find its weak-link strength as above. Then break several three to five inch sections to find its strongest-link strength. Take several readings, then average them out.

To measure stretch and set - the amount a string will remain stretched when tension is released - lay out fifty inches of thread or cord. Wrap one end of cord twice around a smooth, round dowel before tying off at a nail or such. Attach the other end similarly to a scale. Place a ruler beside the scale. Pull the scale, applying tension slowly and repeatedly, building up to point of breaking. Note the amount of stretch, and the amount of set as you proceed, as well as the point of failure.

Offered by [Brian](#).





# Troubled Times

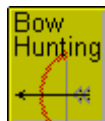

## Flemish Twist

### Making a Flemish Twist Bowstring

by Ron Harris

The techniques I use to make a Flemish Twist bowstring are not necessarily the only way to do it, but it works for me. Making a Flemish Twist string is relatively simple. It's sort of like tying your shoes - easy to do, but difficult to describe and a whole lot easier if someone shows you how. The first thing you will need is a string making jig. For this you will need the following materials:

- A 1x6 pine board 28 inches long. It should be fairly straight and free of knots.
- About 2 dozen 1 inch long finishing nails.
- One 10 penny common nail.

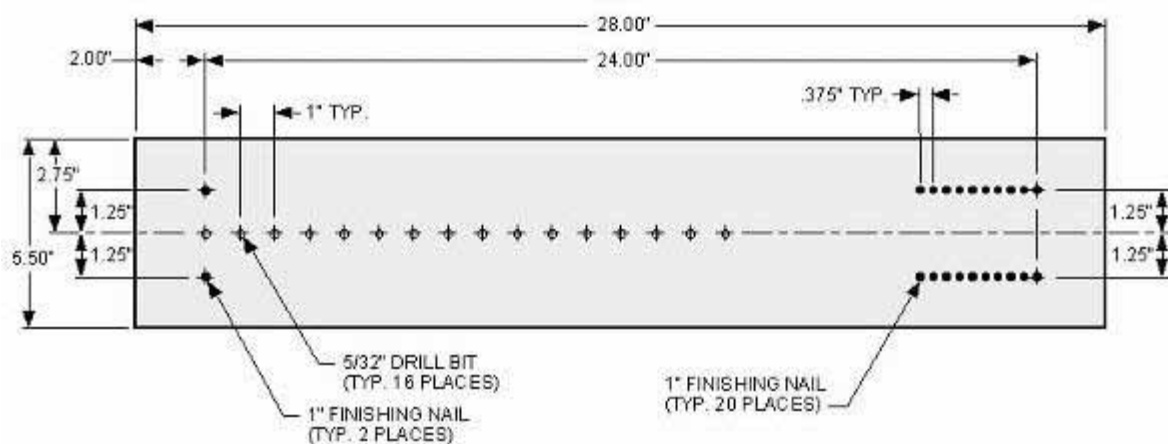

Lay out the board dimensions as shown above. Your measurements don't have to be precise, but try to follow them as closely as possible. When you have all the nail locations marked and the holes marked for the movable peg, go ahead and drill the holes for the peg. I use the 10 penny nail with the head cut off to a length of about 1 1/2 in. The 10 penny nail takes a 5/32 inch drill bit. You can substitute whatever you want for the peg, but make sure you drill the hole big enough so the peg can be easily removed. After you have drilled the holes for the peg, go ahead and drive a finishing nail about halfway into the board at each nail location shown. Next, use a permanent marker or ball point pen and mark the board as shown below. You don't have to mark the string path I've shown, but I do just in case I forget which way to wind the strands on the jig.



# Troubled Times



## 2 or 3 Ply

### 2 or 3 Ply String

by Ron Harris

Next, you'll need to decide if you want to make a two ply or three ply string. A two ply string is made from two bundles of twisted strands while a three ply string uses three bundles. A two ply string is easier to make and for this article I have chosen to illustrate the two ply process.

#### how many strands do you need for your bowstring

40 to 50 lb range	12 strands
50 to 70 lb range	14 strands
70 to 80 lb range	18 strands

OK, lets say you have a 50 lb longbow, so we're going to make a 12 strand string. For a two ply string we'll need two bundles of 6 strands each or three bundles of 4 strands each for a three ply string. Grab you string jig and tie the end of the B-50 dacron string to the top left-hand nail. If your bow is 64 inches long, put the movable peg in the hole marked 64 and start winding the strands onto the jig until you have 6 strands of string on the jig. Cut the strands with a sharp knife or razor blade right down the center line between the top nails. Carefully pull the bundle off the jig making sure that the ends of the strings don't move. You'll notice that the ends of each strand is slightly shorter than the others as illustrated in Figure 3. Staggering the string ends helps to lock each strand in place as you make the bowstring loops. Set this bundle aside and repeat the process using a different color of B-50 dacron string.

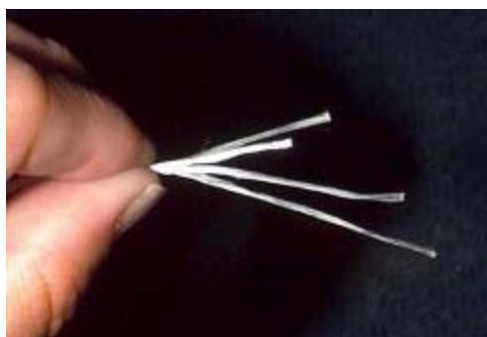

Wax both ends of each string bundle for about 10 inches. You may have to warm the wax so that it will stick to the strings. Use a candle or alcohol burner. Thoroughly work the wax into the bundles. Lay both bundles side by side so that the longest strand in each bundle is aligned with the other then lay the two bundles on the ruler you marked on your jig. Grasp both bundles about 7 inches back from the ends. Hold the bundles between your thumb and forefinger as shown below.

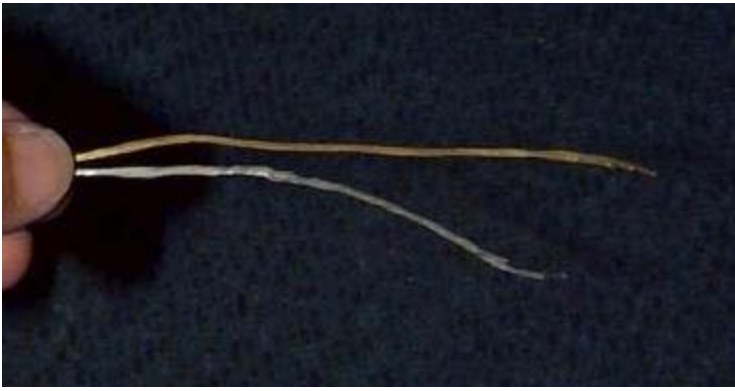

Using your other hand, twist the top bundle six or seven times in a counterclockwise direction (twist away from your body). Now take the twisted bundle and rotate it over the top of the bottom bundle (towards your body). The bottom bundle is now on top and vice versa. Keep repeating this twisting and rotating process until you have braided enough to form the loop for the top limb on your bow. The width of this loop will vary as does width of different bow limbs. The loop should be wide enough so that it will slide down the bow limb 5 or 6 inches when the bow is unstrung.



Form the loop as shown here. Make sure you align the bundles as shown (same color over same color). Grasp the bundles at the bottom of the loop and twist the two bundles of same color together. Here we show white twisted onto white forming one large white bundle and yellow twisted onto yellow forming one large yellow bundle.



Holding these two bundles between the thumb and forefinger, perform the same twisting and rotating process until the last tag end of the strings have been braided into the bow- string. Your finished loop should look like that shown below.



After finishing the top loop, separate both bundles all the way down to the bottom. Take your 7 inch measurement at the bottom of the bundles and repeat the whole process again just as you did when forming the top loop. When braiding the bottom loop you may have to stop occasionally to separate the bundles. The bottom loop has to be just wide enough to fit over the nocks on your bottom bow limb. Rather than forming a permanent braided bottom loop you can also choose to just braid about the last 8 to 10 inches of the bottom bundles and tie a timber hitch for your bottom loop.

Now that you have completed the loops you will need to put a twist into the bowstring. Make sure you twist the bowstring in the same direction as your braids otherwise you will untwist the loops. Put the string on your bow and adjust for proper brace height. Allow the string to stretch for a day or two or go out and shoot the bow. Remember to keep adjusting the brace height by twisting or untwisting the string until all the stretch has been worked out of the string. With your bow strung, mark the string about where you think your nocking point will be. Mark the string again about 2 inches above the nock point and 6 inches below the nock point. This 8 inch area of the string is where you will apply the monofilament serving. Put your spool of monofilament on the serving tool and pull a few inches of line out. Now is a good time to adjust the tension of the serving tool. You want the line to come off the server with some tension so that you get a tight wrap around the bowstring. Don't use too much tension or your serving could cut through the bowstring.

Separate the bowstring at either end of the serving area and insert about 1 inch of the monofilament line through the bowstring. Begin wrapping the monofilament around the bowstring while keeping the loose end under the serving wrap. Keep wrapping the monofilament around the bowstring until you are about 1/4 inch from the end of the serving area. Cut a 10 to 12 inch strand of the B-50 string. Fold the string back to form a loop at one end. Lay the string on the bowstring with the loop facing towards the end of the limb. Wrap the monofilament line over the dacron string about 6 to 8 more times. Keep these last few wraps a little loose. When you get to the end of the serving area pull a couple of inches of monofilament off the spool and cut the line. Cut the line and insert the end of the monofilament through the loop in the dacron string. Grasp the loose ends of the dacron string and pull them back under the last few wraps of monofilament. This will lock the end of the monofilament under those last wraps.

Now that the bowstring is finished give it a good waxing with a quality bowstring wax. Rub the wax in thoroughly using a piece of scrap leather. Rub it hard and fast so that the wax gets hot from friction and flows into the strands of the bowstring. Now, go out and enjoy shooting your bow, equipped with a string created by your own hands.



# Troubled Times



## Endless String

Drive two nails into a table or board, the distance between nails equaling intended string length. Determine the number of strands needed: breaking strength of one strand, divided into four times the bow draw weight. Wind the string back and forth around the nails until desired strand number is reached. Be careful to apply equal tension on each strand.

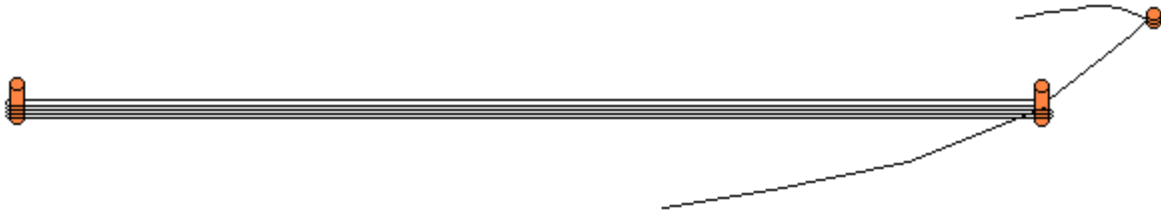

Tie the two loose ends together.



Slide the string around the nails a few inches so the knot can be covered by serving



Serve for about three inches. (Use medium-fine soft cotton, silk or linen for serving.) Serve similarly at other end.



Slide the string back to its original position. Form loops by pulling the strings together and serving.



Serve about three or four inches in the centre of the bow for the arrow nock.

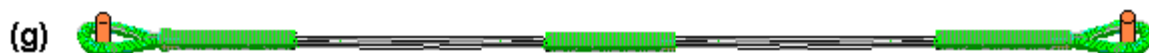

Offered by [Brian](#).





# Troubled Times



## Serving

For serving any relatively fine, soft fiber will do, such as cotton etc. Make the turns as close together as possible so that none of the bowstring is seen underneath. Below is a simple method of tying the serving without the use of knots, as these tend to undue due to any vibration in the string.

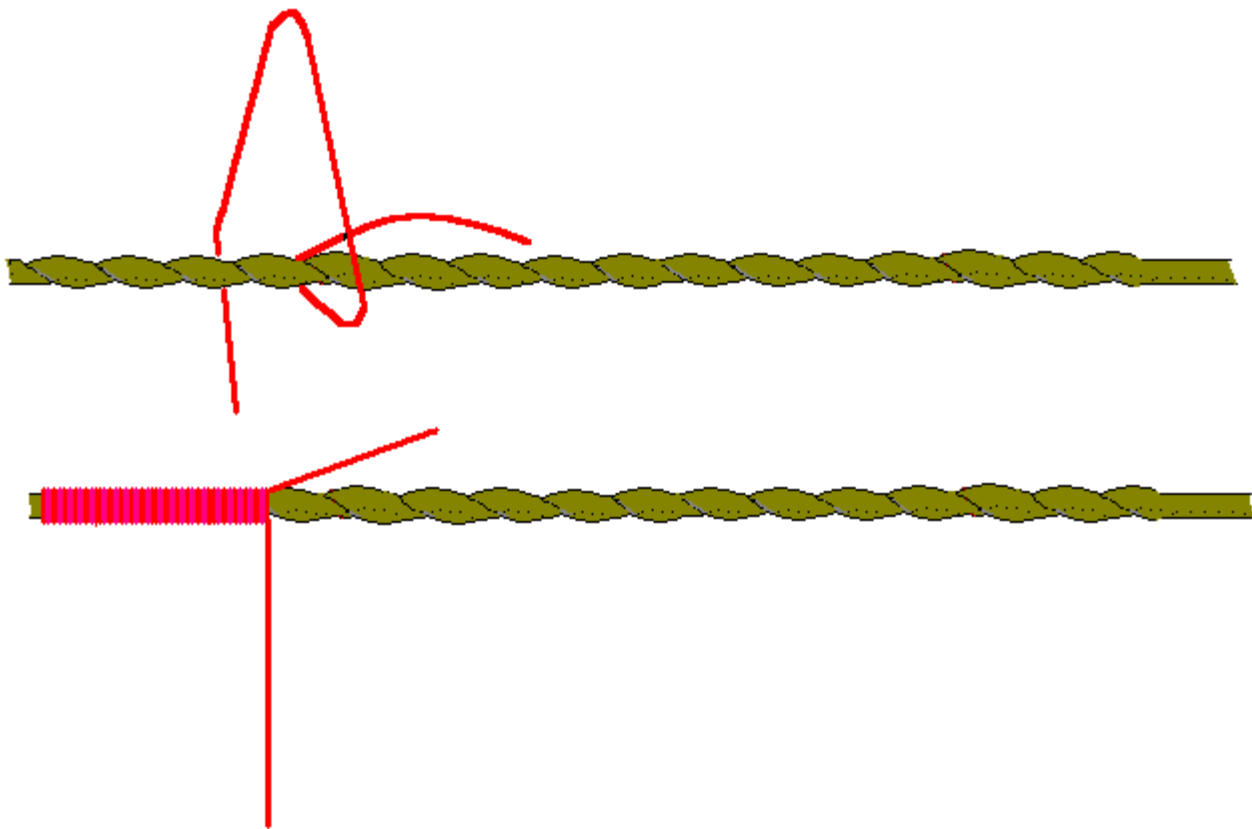

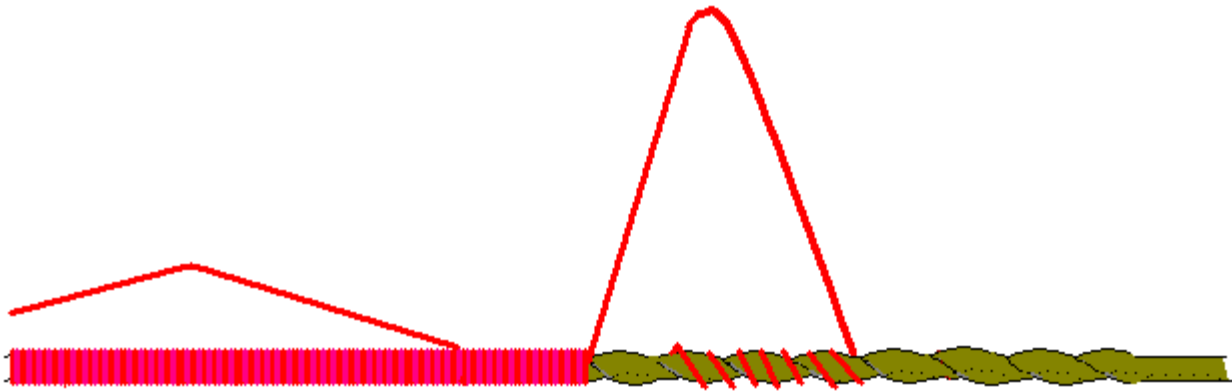
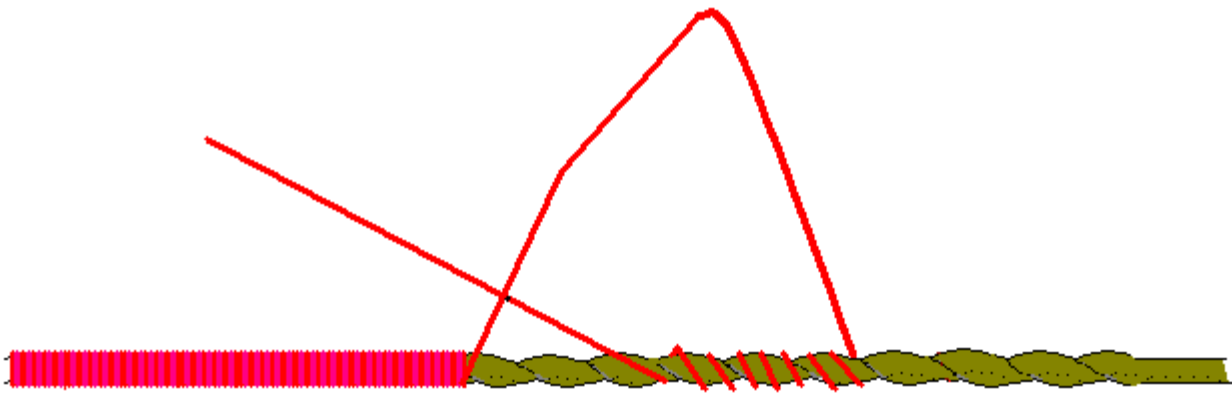
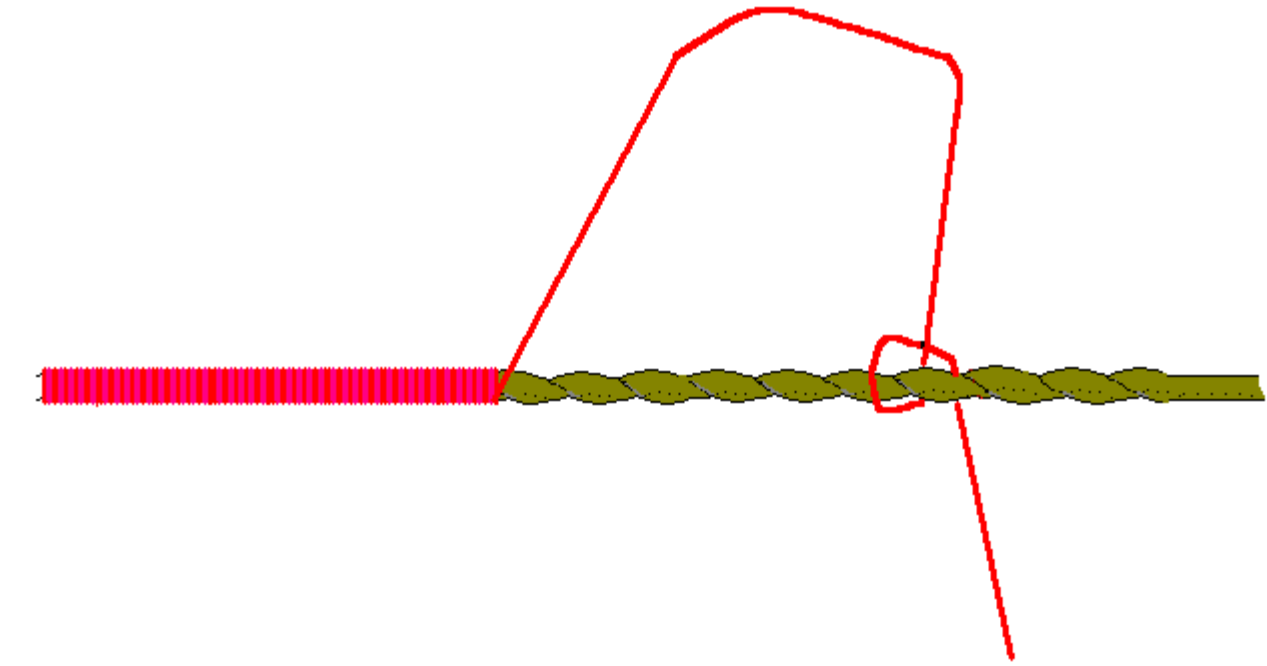

Pull back the excess and cut as close to the serving as possible with a sharp knife.

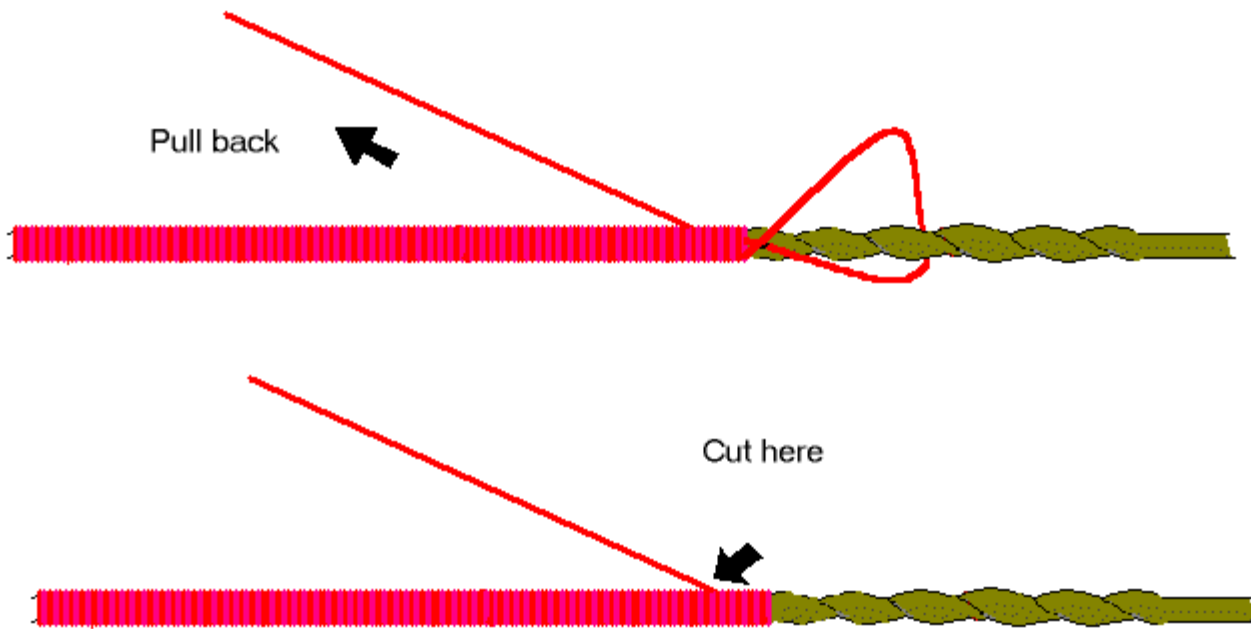

Offered by [Brian](#).



# Troubled Times



## Heat Shrink

---

I learned today from a cross bow vendor that cross bow strings last about 100 shots and that if one takes some heat shrink tubing and shrinks it over the section of the string that rubs on the bow (3"-5" long) that it can last up to 5 times longer. Choose a flexible thin tubing so that the mechanism will still cock and hold the string back. Also, putting wax on the string after or before each intended use is recommended. This is also recommended if one uses heat shrink tubing to make the string last longer. I believe that 1/16" or bigger wire rope (small cable with 120 lb. working strength) would also work for a string and last even longer. This can be purchased for about \$.10 per foot at Home Depot and other hardware sources.

Offered by [Mike](#).



# Troubled Times



## Arrows

By Rob McNeur

The English didn't tend to use Cedar for war arrow shafts as much as things like oak etc., as they needed a very heavy and strong timber that would stand the strains of being fired from 100+ lb. warbows and impacting steel plate without shattering. Of course, this wasn't a problem with hunting bows/arrows, which could be made of lighter timbers. Basically, I choose a 4x2 stick with as straight a grain following the cut of the wood as possible. Saw the length of timber to about 3" longer than the arrows you want i.e. if you are making 28" shafts, saw the wood to about 31". This allows a little free wood on both ends. Because I want the grain running exactly the length of the arrow blanks, rather than across it at an angle, I use a sharp, heavy knife, ax etc., and split the length down one side, following the grain, until you have that side exactly following the grain and hopefully straight. If you are lucky enough to get a length of wood where the grain exactly follows the line of the sawn timber, then this is unnecessary, but usually the saw cut will run off at some slight angle from the grain. Plane out any mounds or hollows on that edge. This doesn't have to be exact, just fairly close. Then I use that as my straight edge to mark the batch of arrows from.

My first batch of arrows was made to be 7/16 diameter, but they were badly overspined for a 40# bow, my current batch is 5/16. I am currently still experimenting to find the exact required diameter to get the spining close to what I need. This will be dependent on the individual timber stock used. Over here, our timber grows faster than the same species in the US or UK (or so I've been reliably told) and hence the grain is slightly coarser and slightly weaker, therefore I started out a bit thicker shafts than normally recommended. \par To cut the blanks, I prefer to saw them. Some books and fletchers recommend just splitting them, I found sawing to be easier and more accurate although probably slower. Mark the length of timber in slices of 1/2" (for 5/16 arrows) or about 5/8" (for 7/16 arrows):

length of 4x2

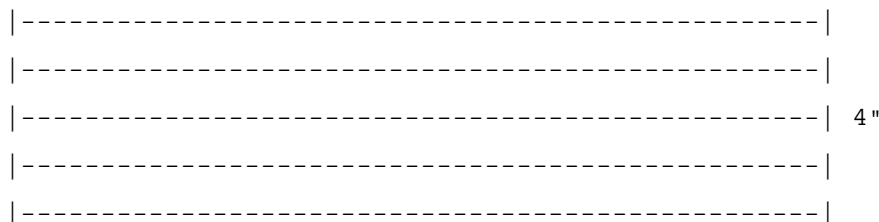

Each line will give multiple arrow blanks. I saw each line, giving multiple slices, each 1/2" x 2" wide (or 5/8" x 2" for 7/16 shafts). Again, mark the 2" width to the same size and again saw the lengths. This should produce multiple 1/2" x 1/2" square blanks, all with the grain running completely along in line with the cut blanks. \par For measuring the shafts as I work them down I have a 3' length of 3x1 wood to act as a shaft 'template' which has a corner cut out, a hole in one side, and a groove chiseled down the length of it.

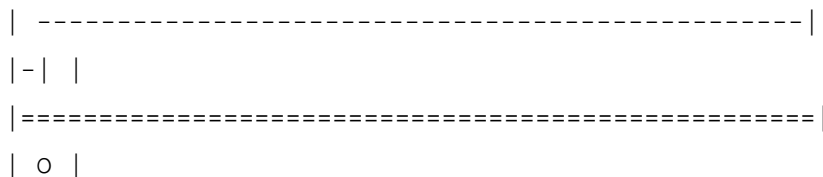

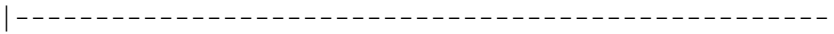

The corner cut out is  $11/32$ " x  $11/32$ " (i.e. fractionally larger than the required size of  $5/16$ "") and is used to measure the width of the blank as it is planed down to the required size. The drilled hole is  $5/16$ " and is used to slide the shaft through as it is sanded to size and shape, allowing you to locate areas which are fractionally larger than the rest, to get a uniform diameter. The groove is straight and cut in a 'V' shape, (just chiseled out) used to rest the arrow blank in while planing off it's edges and stop it turning or rolling.

Once I have all the sawn blanks, I work on one at a time until each one is down to smooth dowels. Basically, one edge is planed straight and smooth, pausing regularly to sight along it and ensure that there are no mounds or hollows. I use a 4" long, about  $3/4$ " wide, plane which fits in the palm of one hand, allowing the other to grip the wood. Once one side is dead straight, turn the blank and repeat the process on the other 3 sides, pausing periodically to slide the planed blank along the cut out corner in the template to ensure that it's dimensions have not got too thin. Continue planing until you have a smooth square cross-section which exactly fits the template all the way along it's length, i.e. it is now exactly  $11/32$  square. At this point, lay the blank with one edge in the groove and carefully plane off the opposite edge  
 \par Rotate the blank 180 degrees and repeat the process . Then rotate the blank 90 degrees and again take off one edge, rotate 180 degrees and take off the last corner. You should now have the blank planed down to a cross section which is an octagon in shape with 8 equal sides.

At this point, start again turning and planing off the remaining edges until you have effectively 16 sides, although at this point the shaft is getting very close to round. Using medium/fine sandpaper, wrap the sandpaper around the shaft and slide it up and down to smooth off the remaining edges and tidy up the last of the shaft. Try and slide it through the hole drilled in the template. (If it doesn't fit, don't force it, otherwise you can scour, break, bend, etc. your shaft.) Anywhere that jams should be marked, the shaft removed and the sanding continued around that area and then tried again. Slowly the shaft will be sanded down, testing for size and sanded again until it slides smoothly through the template hole, just touching on all sides along it's full length giving a smooth shaft of a constant diameter.

I find that what usually happens (with my shafts) is that the  $1/2$ " of wood at either end finishes up slightly narrower than I require (from the planing/sanding process), which is why I allow for an extra 2-3" of length on the shafts for adjustment. I cut back one end a fraction to the even diameter shaft and cut mynock in. If I really mess the nock up, I still have just enough spare shaft to allow me to saw the nock off and recut it. Once the completed nock is cut in, I saw the other end of the shaft off to fit my required length.



# Troubled Times



## Components

---

### Spine

The measure of stiffness in an arrow. Of less importance with 'centre-shot' bows (ie those firing through the centre of the handle), but of major importance with arrows fired past the side of the bow. Although originally made of a single length of wood, many archers used to splice different types of wood together to enhance the properties of the arrow. Hardwoods were often spliced into the head and/or heel (fletching end) of the arrow and softwoods used for the central shaft. Such spliced hardwoods are known as a footing. The softwoods allow the arrow to retain its flex and lowers the weight of the arrow. The hardwoods in the head and/or heel allow these areas of the arrow to withstand the major stresses in the arrow namely the splitting stress of the string thrusting against the centre of the arrow (if separate nocks aren't used), pushing it forward and possibly splitting the wood, and also the compressive stress of the arrow hitting it's target. \par Often nocks would be reinforced by cutting a slot at right angles to the nock and inserting a short section of horn or bone. Hence the stress of the released string is spread across the horn and thence across the whole end of the shaft, rather than being concentrated in the grain directly below the string.

### Arrow Straightening

Wooden arrows will often warp slightly in normal usage. This warpage can be removed by gentle heating (usually with steam from a kettle or similar) and carefully bent back to straightness. Fastening the arrow to a straightedge during the process will help to ensure straightness. The ancients used to do this by heating over a fire and then sliding the arrow backwards and forward through a small hole in a piece of bone. Arrow flights were nearly always made of feather. The stronger and heavier the feather, the better for a flight. Goose and turkey feathers were often used, although many of the middle eastern archers preferred hawk or eagle feathers when available. And wing (pinon) feathers are always preferred over any others although Turkish arrow flights were also made from tail feathers.

### Archer's Paradox

This is not as significant with modern bows, many of which have a shaped handle allowing the arrow to pass through the middle of the handle. It is much more significant in older bows where the arrow is fired past the side of the handle, yet the string actually moves towards the centre of the bow, rather than the edge where the arrow rests. The arrow still manages to fly to the point of aim. In actual fact, the string moves directly towards the centre of the bow which causes the arrow to curve around the side of the bow and continues to curve and oscillate from side to side in flight. This results in a wavering arrow flight which smooths out as the arrow travels until this sideways movement has been fully damped out. During this flight, the arrow is actually flexing. Because of this, it is most important to get the correct amount of stiffness (spine) in arrows intended for a non centre-shot bow. If the spine is too high, the arrows cannot flex correctly in flight and hence are less able to correct for the travel of the string. If they are too low, then the arrow is less able to dampen the flex in flight, and hence the flexing continues too long. The arrow 'spine' must be closely matched to the bow weight, as a heavier bow will induce greater flexion. The shaft of the arrow needs to be thicker (to take the extra stresses) and also stiffer (to dampen out the added flex) for a heavy bow, and thinner and lighter for a light bow.

### Arrowheads

Primitive man started with a arrowhead that was hardened by burning the end of the shaft slightly, then sharpened by shaping the burned end. A 2- blade broadhead (2 cutting edges) was used as the primary hunting and war arrowhead for centuries, either cast from bronze, chipped from flint, or forged in iron/steel. The arrival of plate steel armour meant that the arrowhead had to change to allow it to punch through rather than cut, so

bodkin points were developed in a variety of sizes and shapes. They tend to be very narrow and longer than a hunting broadhead, with little or no cutting edges, in a square or triangular cross-sectional shape to enable it to place the maximum stress on the smallest area of steel plate armour as possible, so as to penetrate as deeply as possible. Japanese and Chinese arrowheads, on the other hand, have a wide assortment of warheads, each of which have specific effects and intended uses. Amongst these are specially designed heads with hollow channels through them to enable the air to flow through them, giving different sounds in flight. These can be used to scare men and horses in combat. They also have armour piercing alternatives etc. Turkish flight arrows often had horn tips, thus reducing weight as much as possible.

### **Armguards**

Simple leather forearm-guards (bracers) with leather thongs were most common, although the more advanced craft of archery amongst some of the middle eastern groups used to make bracers from thin strips of wood, bone or ivory and held in or glued to a leather or cloth body and strapped on. Formal English archers were also known to have worn a large glove which extended as far as the elbow, and had pockets fitted for spare strings, wax etc.

Offered by [Brian](#).





# Troubled Times



## Arrowheads

---

Today there is a wide choice of steel for use on broadhead points, such as 1040 to 1095 annealed spring steel. What is the difference? The last two numbers denote the carbon content of the steel: ie, the 1095 has over twice the carbon content of 1040 and should hold a sharper edge. Alternatively blades can be made from old saw blades, large bad saw blades, spring steel, annealed steel, stainless steel, copper, brass, aluminium - anything that can hold a sharpened edge, but at the same time is strong enough not to fold or bend on impact.

Cutting the material is the next problem. Commercial broadheads are cut on machine/hand operated shears. Some materials can be cut with metal cutters but will tend to make the edge concave on one side convex on the other. For this reason the 2.5 inch layout will allow up to twenty percent loss of the blade during straightening, heat treating, and sharpening, the broadhead to a point. A standard bench grinder and file will shape the blank and bevel the edge.

When making steel blades, be sure all shaping and beveling is totally finished before heat treatment. Heat the blade to an orange colour, applying heat to both sides to help prevent warping. Quench the blade immediately in heat-treating oil such as motor oil. (If the carbon steel sparks, you are over heating the material. Once treated, the steel will be very hard. Use a file to cut across the edge of the point and gauge the temper of the steel. If the file will not cut, the edge of the point may be too hard and brittle. The broadhead can be re-heated until an orange colour again, but this time air cooled. Which will soften the steel.

Offered by [Brian](#).



# Troubled Times



## Construction

By Rob McNeur

### Cutting in Nocks

Size of these is dependent on your string thickness. I start by marking the centre of the end of the shaft and marking at right angles to the line of the grain or growth rings across the end of the shaft. This must be at right angles, otherwise the strain of firing the arrow will all come down in line with a single growth ring and the shaft is likely to split along the grain down this growth ring. Then, using a fine saw or hacksaw (or 2 hacksaw blades taped together), saw the slot down for about 3/8" - 1/2". Carefully sand the inside of the slot and using a fine rats-tail file or fine sandpaper wrapped around a small nail etc, widen the base of the nock so that the bowstring just slides down the slot but sits comfortably in the wider hollow at the base.

This is exactly the same principle as modern snap-on nocks, and several of the races of early archers used this technique. If you want, you can reinforce the nock by cutting a narrow slice in the end of the shaft at right angles to this slot and gluing a sliver of horn, ivory etc in this such that the nock is cut through this as well, and the harder material of the horn helps to spread the impact of the bowstring against the inside of the nock on firing. Many of the English fletchers used this, as they needed to use everything they could to make shafts that could take the stresses of war use.

### Finishing

Once the arrows are completed to having nocks cut in and being cut to length, a suitable finish can be applied in the form of a polyurethane, varnish etc. (Polyurethane is not 'period', many of the varnishes are more appropriate if this is required.) If these arrows are to be used for hunting a matt finish is recommended so that they will not reflect at all. To ensure an even coating, they can be sprayed or just dipped into a narrow tube of whatever you want to use i.e take a 3' length of 3/4" pipe, cap one end, fill with varnish etc, lower arrow in until it has been completely covered, then hang somewhere to dry such that it has the air circulating but is not likely to be covered in dust etc before drying. And extra rings of colour applied (usually just below the fletchings) to indicate ownership, and (if you want to get technical) the intended drawweight of the shafts using some form of colour code.

### Fletching

Fletching is up to the individual. I am currently using turkey feathers to fletch with, after spending half a day on a commercial turkey farm plucking wing feathers as the birds went into the slaughter house. Admittedly the other workers thought I was nuts but hey, thats life. And I've now got a sack of feathers in the garage which should last me several years. Although some of them need to be dyed to cover up the bloodstains.

### Arrowheads

Arrowheads are up to the individual. Although I have handmade the shafts, I have fitted modern target points over the tips and glued these in place. This is not authentic as far as traditional styles of arrows goes, but target shooting with authentic hunting broadheads or bodkin points will rapidly destroy your targets and annoy everyone else who wants to use the targets. If fitting 'traditional' arrowheads, either steel, flint, obsidian, etc, saw a slot in the head of the shaft, again sawing at right

angles to the growth rings so that the stresses are spread across them all, rather than concentrated on a single ring. Then fill the slot with glue and slide the shaft of the arrowhead down the slot, binding it tightly into position and onto the main shaft with thread or sinew, well glued into place, and wipe off the excess glue.



# Troubled Times



## Blade Design

---

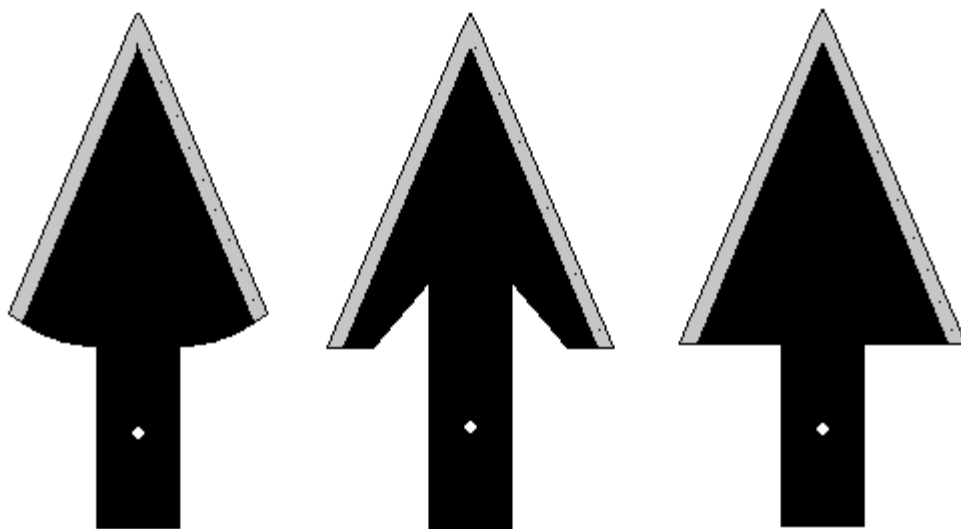

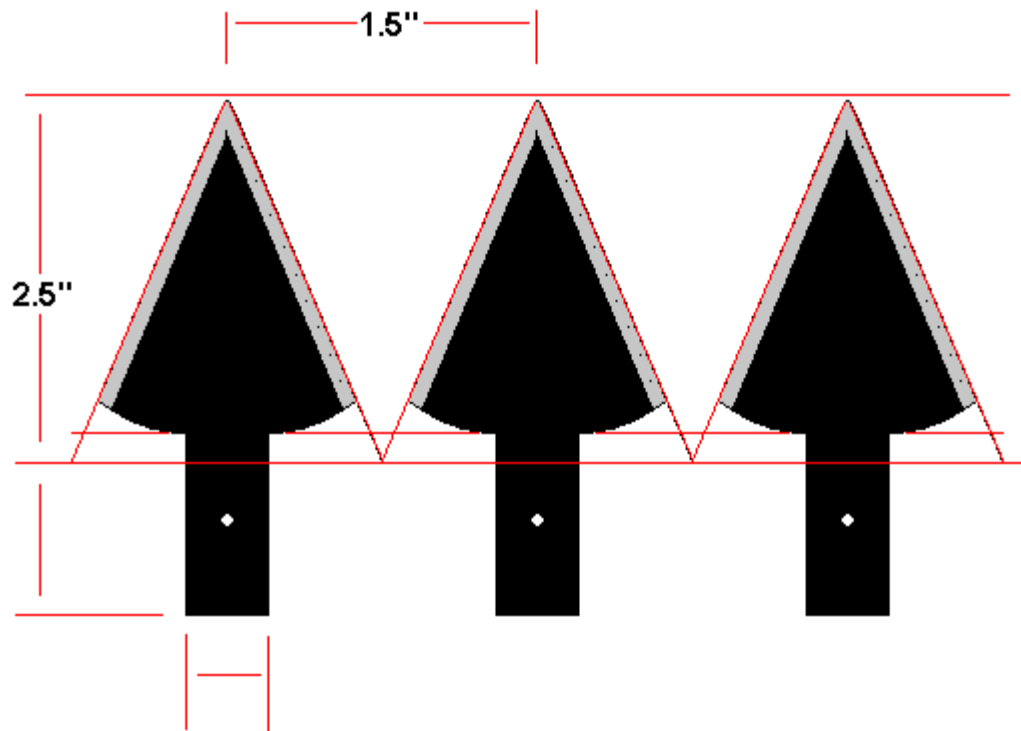

Offered by [Brian](#).



# Troubled Times



## Broadhead

Below two methods for securing broadheads to the arrow shaft. A metal ferrule (left) supports the shaft and prevents splitting upon impact. Wrapping the point's tang with wire or strong cord (right) serves the same purpose.

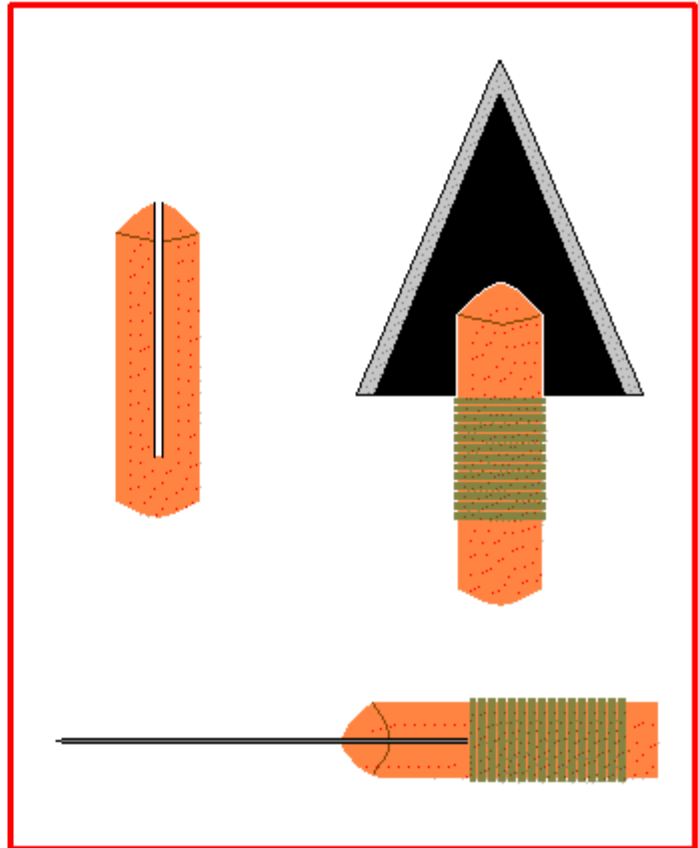
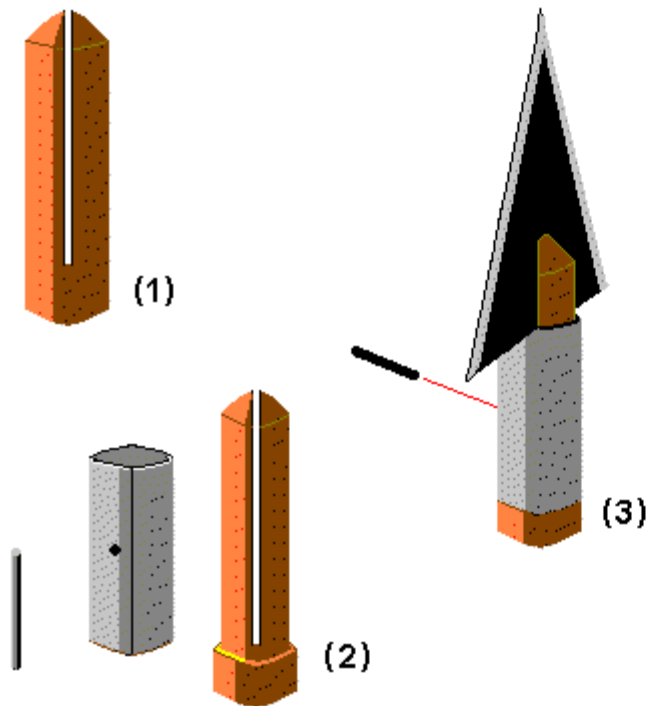

Offered by [Brian](#).



# Troubled Times



## Drinking Water Treatment

---

### Why Not Just Drink the Water?

Excerpts of an article from rec.backcountry's Panel 9, by Alan Dove (ad52@columbia.edu), Bill Tuthill (tut@netcom.com), and edited by Eugene Miya (eugene@amelia.nas.nasa.gov)

In the Great Outdoors, there are potentially four dangers of drinking water straight from a source (assuming it's freshwater): chemical pollutants, protozoa and larger parasites, bacteria, and viruses. The oldest (and cheapest) method of purifying water is to boil it. Boiling for five minutes will kill any biological hazards you could expect to find. Most pathogens are actually long dead by the time the water boils, but the five minute boil will get them all (remember to add to this time at higher altitudes). Boiling will *not* neutralize chemical pollutants.

A carbon filter will remove chemical toxins. Chemicals in water could include inorganic contaminants (arsenic and other heavy metals) or organic toxins (fertilizers and pesticides, for example). In general, it is a bad idea to trust any purification system to remove these, as even small quantities could ruin your day in a hurry. The good news is that water sources in the backcountry are seldom contaminated with appreciable levels of toxic chemicals. Take a good look at the stream you're about to get water from. Are there fish in it? Is there algae on the rocks? Crawdads on the bottom? Insects skimming the surface? Plants growing along the banks? If yes, the water is probably non-toxic, chemically speaking. If you're hiking in the desert, though, and a trickle of water etching a groove in the rock is bubbling sulfur from its barren depths, you should probably avoid it.

There are a number of parasites, both multicellular and unicellular, which live in water. The most common ones in North America are **Giardia lamblia** and **Cryptosporidium**. Boiling will kill them. In third-world countries, the number of parasites in the water is staggering, hence the hackneyed advice, "Don't drink the water." Amoebae can cause dysentery ("Montezuma's Revenge"), whipworm causes diarrhea and possible complications if not treated, and roundworms (**Ascaris lumbricoides**) can be unpleasant, to name a few. In some areas, such as the Philippines and Africa, you should try to avoid *any* contact with river water, including swimming or washing in unpurified water, as **Schistosoma** sp. is prevalent in these areas. These tiny parasites bore directly into the skin, entering the bloodstream and eventually setting up shop in either the intestine or the bladder. If left untreated or incorrectly diagnosed (a common problem, as symptoms only become manifest weeks or months after contact), the complications can be severe. As with Giardia, though, all of these parasites are killed by boiling.

Bacteria are the second smallest pathogens in water. One frequently hears about water being tested for **Escherichia coli**. While strains of this bacterium can be pathogenic, the vast majority are not, and it is, in fact, one of the species required in the intestine for digestion to occur (without bacteria, we would all die). Since it is present in large quantities in sewage, it is a good indicator strain to show when water has been contaminated with sludge. There are plenty of other bacteria which are happy in the intestine, to the detriment of the host. All are killed by boiling.

The smallest parasites are viruses. In true wilderness areas, pathogenic viruses are seldom found in water, but the odds increase with population density and poor sanitation practices. Boiling is the most reliable way to do away with viruses, though, and is strongly suggested in third-world countries. The specific viruses you should worry about in water are **Hepatitis A**, **Rotaviruses**, **Polioviruses**, and **Echoviruses**.

All of these will cause diarrhea, intestinal cramps, and discomfort about 48-72 hours after contact, and complications could range from liver damage (for hepatitis) to aseptic meningitis and encephalitis (for echoviruses), and paralysis or death (for polio).

Chemical purification involves the use of iodine or chlorine to kill the nasties in the water. This method is lightweight and relatively inexpensive, but will not neutralize chemical toxins. In addition, you must make sure that water at 25 deg. C (75deg. F) sits for 20-30 minutes with iodine in it for purification to take place. If the water is colder (as it usually is), you will need to let it sit longer - possibly overnight for cold stream water. Warm the water against your body or even on your stove if you want it to be purified faster. Once the appropriate time has elapsed, the "band-aid" taste of iodine can be neutralized with a small amount of ascorbic acid (vitamin C). Used properly, iodine will kill most protozoa and all bacteria and viruses in water. After prolonged use, some people develop thyroid problems, so be aware of this potential side effect.

The latest rage in water purification is the use of filters, and a large number of them are available (see the review later in this panel). There are a couple of things to bear in mind when shopping for filters. First, only a system which includes an iodine matrix will kill viruses (see below). Second, a filter with pores larger than 0.2 microns - note the location of the decimal point, as it is important - will let bacteria through. The advantages of a filter are quick processing time (don't have to wait for the pot to boil or the iodine to do its work) and clean- tasting water (no iodine or vitamin C flavor). Some systems also contain a carbon filter which will remove chemical toxins.

Boiling your water is cheap and easy, and kills all known pathogens.





# Troubled Times



## Pollutants

---

More importantly benzene and some other chemicals are not filterable so you can't drink nor can you cook with water contaminated by benzene. Near where I live some 14 miles away is an area that is a super fund site. The feds say no filter can be used so people are having water trucked in for consumption.

Offered by [Lou](#).

Benzene and some other chemicals are not filterable, but in an open container will boil off below water boiling temperature so that it is only necessary to heat it up to boiling and let it cool.

Offered by [Mike](#).



# Troubled Times



## Waterborn Diseases

---

### Clinton Touts Water Purifying Rules

by Sandra Sobrieraj, *Associated Press*

The federal government is tightening water purification standards and giving states and municipalities nearly \$870 million to bring their filtration plants up to snuff. For about 90 percent of American households the new regulations, which President Clinton was highlighting today in a visit to Rhode Island, will add less than \$2 to the average monthly water bill, according to administration forecasts. The Environmental Protection Agency estimates that the changes could prevent up to 460,000 cases of waterborne illness a year and improve overall drinking water quality for 140 million Americans who are not already served by top-of-the-line filtration systems.

By requiring municipal plants to use higher-performance filters and to monitor filters more frequently, the higher standards are primarily aimed at eliminating the threat of cryptosporidium, a parasite spread through human or animal feces. More than 100 Milwaukee residents were killed, and another 400,000 sickened, when cryptosporidium contaminated the city's water supply in 1993. "This is a very complex subject with the health of the American public hanging in the balance," said Sen. John Chafee, R-R.I., chairman of the Senate Environment and Public Works Committee.

Chafee, who co-authored the 1996 legislation requiring both tighter standards plus the federal money to help implement them, was accompanying Clinton on a morning tour of the Newport, R.I., water treatment plant before the president's public address at the oceanfront Fort Adams State Park. "The proposals the president is announcing will simultaneously reduce health threats both from the bacteria and viruses that may be in our drinking water and the disinfectants that are used to remove them," Chafee said. The new regulations also toughen standards for allowable concentrations of chlorine byproducts in drinking water and reduce an individual's exposure to such byproducts by an estimated 25 percent. Used to disinfect water, chlorine can combine with natural organic materials and form trihalomethanes, which are suspected of causing cancer or birth defects in tests on lab animals.

The federal government is providing states with \$775 million in fiscal 1999 for low-interest loans to municipalities that must upgrade facilities to bring them into compliance. Another \$93.8 million is being released to state drinking-water monitoring and enforcement programs. Most water treatment facilities must comply by December 2001. Smaller systems serving under 10,000 people have two more years to meet the higher standards. All told, the improvements are expected to cost federal, state and local governments some \$2.5 billion over five years.



# Troubled Times



## Emergencies

---

### **N.J. Residents Still Boiling Water**

*Associated Press, September 20, 1999*

More than 1 million people in New Jersey were under orders Monday to boil their tap water because the flooding from Hurricane Floyd may have contaminated it. Thousands of residents of Edison and nearby towns lined up for bottled water, offered free to the elderly and families with children under 2. Police delivered water to hundreds of elderly unable to leave their homes. "It's amazing how you take it for granted. You run the tap and that's it, and now it's like an emergency," said Christina Hussein, who brought her 5-month-old son, Tamir, on her arm as she picked up bottled water. Herman Prosk and his wife, Arlene, both retired and dependent on prescription medications, said they had come for free bottled water every day since Thursday. "How you miss simple things. You can't eat decently because you can't clean a dish," Prosk said.

In Edison and neighboring Middlesex County communities, tens of thousands of residents were getting nothing more than a rude cough as they turned on their faucets. A regional water supply plant in Bridgewater remained crippled after floodwaters damaged pumping equipment. The plant is on low ground near the confluence of the Millstone and Raritan rivers, which flooded when Floyd dumped nearly a foot of rain Thursday. In other areas, drinking water was contaminated by the muddy runoff pouring into reservoirs.



# Troubled Times



## Filters

---

Water purification is a real issue. I was a door to door water purification salesman for my first job a long time ago. A few things I did learned **Carbon attracts Carbon**. The premise of the filter was to run the water through a charcoal lined tube. A whole host of nasty chemicals would then be removed from the water. If coal is at all available in your area that may be one solution.

Offered by [Brand](#).

Filtering is a very economical choice, but the filter *must* be replaced according to the manufacturer's instructions. If it is not replaced in a timely manner, greater quantities of bacteria may be introduced into your water than exist in the tap water itself.

Offered by [Michael](#).

There are magnetic water filters (both home sized units as well as a trailer mounted unit for emergency water to small cities/towns). (Water filters are under the "purion" and "city-water" links.)

Offered by [Thomas](#).

The **Country Store** has a water distiller as well as many other items for being on foot. Cost for the distiller is \$169.00, not cheap, but portable.

Offered by [Tim](#)



# Troubled Times



## Katadyn

---

The best water filtration system is the large capacity gravity fed ceramic filter **Katadyn**. Swiss-made, field tested, expensive. It will produce enough water for 10 adults if constantly supplied with water to filter. Rate of filtration depends upon the amount of mud, etc., in the water being filtered. Smaller models are available. The big Katadyn's have been widely used in Third World countries and are very highly regarded.

Offered by [George E.](#)

The Katadyns are nice, it just takes more effort than you would imagine to fill a water bottle. I have a pocket filter for my BOB and I'm looking at a drip filter for the house. Water filters are nice, but I recommend having an extra filter and a backup system. I'm a firm believer in having several redundant systems for each area.

Offered by [Mike.](#)



# Troubled Times



## AquaPure

---

There are some folks near us who are using a "military" filtration system. The military bids on filtration systems. [AquaPure](#) water systems is probably the best known. The small stuff is in your local WalMart. You can contact them directly for the big stuff. They can do any size filtration system. My biggest concern would be replacement filters/parts. The military types of systems are probably the best to look at just because they are expected to work in times of great duress.

Offered by [John](#).



# Troubled Times



## PUR Plus

---

Sipper straw units such as **PUR**'s are good for a bug-out kit.

Offered by [George E.](#)

Bottled water that has been filtered of cryptosporidium, giardia, lead, chlorine, lindane, atrazine, mercury, asbestos, general sediment, etc will have a long shelf life. **PUR Plus** promises to filter all these impurities. **PUR** is sold at any Target, Walmart, or other shopping centers similar to these. (800) 787-5463 or (800) PUR-LINE. **PUR Plus** filter that offers filtration of lead, chlorine, lindane, atrazine, mercury, asbestor, sediment, cryptosporidium, giardia, etc., has an automatic shut-off when the filter is used up.

Offered by [Leila.](#)



# Troubled Times



## Brittas

---

My understanding regarding **Brittas** is that they get out the inorganics, but still leave you at risk re: parasites and viruses. It takes some homework to find filters that get out the organic stuff, too. To be really sure to get out the viruses, you need to have UV filtration. I know that Colloidal silver is supposed to take care of viruses and parasites, and that Oil of Oregano is, too, but so far I have not seen any scientific studies that prove that to my satisfaction, although I use both items.

Offered by [Martha](#).





# Troubled Times



**Amway**

---

This water filter is manufactured by the **Amway Corporation** and was rated number 1 above counter filter by *Consumer Reports* (July 1997). It also has an adapter kit for installing under the counter. It's NSF certified standard 53. This year they are adding a UV mechanism to the filter to allow the filter to zap any of the really teeny parasites and provide extra protection against viruses. I have not checked lately to see whether that one is available yet, but I will, and let you know. They claim to reduce these contaminants, and the testing done by *Consumer Reports* and NSF concur:

Alachlor; asbestos; Atrazine; Chlordane; Chlorine taste and odor (I'm not sure how much of the chlorine it is actually able to remove); class 1 listing for particulate contaminants; Ethylene dibromide; Dibromochloropropane; Heptachlorepoxyde; Lead; Lindane; Mercury; Methoxychlor; PCB; Toxaphene; Trihalomethanes; Turbidity; Numerous Volatile Organic Chemicals, Zylene; Waterborne parasites (cysts), including cryptosporidium; 2,4-D, 2,3,5-TP; more than 100 pollutants listed as "priority" by the U.S. EPA; Hydrocarbons; particles as small as 1/3000 the diameter of a human hair (0.2 microns); Dioxin; Radon and radon-decay products; other industrial chemicals such as PCB.

Offered by [Martha](#).



# Troubled Times



## PentaPure

---

### PentaPure Purification Technology

Every WTC/ECOMASTER water purifier utilizes PentaPure Purification Resin to make your water microbiologically pure. NASA has used iodinated resin technology since 1981 to purify water for the U.S. astronauts during each space shuttle mission. With the help of this revolutionary technology, the astronauts recycle the water created by condensation from the shuttle's energy cells, allowing them to conserve both time and space.

This same technology is the basis of WTC/ECOMASTER's unique water purification systems. PentaPure resin has become the most effective, practical, and adaptable means yet of destroying harmful, waterborne bacteria and viruses, providing safe, purified drinking water! PentaPure resin is a unique purification technology based on the natural phenomenon of electrostatic attraction.

PentaPure is manufactured through a complex proprietary process. In short, polyiodide ions are bound to an anion exchange resin, creating a positively charged structure. Waterborne Pathogenic bacteria and viruses are negatively charged, so the positive charge of PentaPure resin attracts the negatively charged contaminants found in water. When the contaminant comes into contact with the PentaPure resin bead, sufficient iodine is released to penetrate and kill the microorganism.

There are several distinct advantages to this demand-release technology. First, sufficient iodine is released when negatively charged contaminants are present in the water to neutralize those microorganisms. PentaPure resin leaves only a slight residual, which can be removed with a carbon filtration stage after purification. PentaPure resin is more effective than constant-release disinfectants like chlorine and iodine tablets (I2) due to electrostatic attraction. Negatively charged microorganisms and positively charged resin are naturally drawn to each other -- ensuring contact and devitalization of the contaminants. With constant-release disinfectants like chlorine and iodine tablets, contact is random. This is why a holding time of 20 to 30 minutes is typically required, and the concentration of disinfectant attacking an individual organism may not be high enough to ensure a complete kill.

The configuration of WTC/ECOMASTER purification products typically consists of three phases. Phase one, sediment filtration, removes suspended solids from the water. Phase two, PentaPure Purification Resin, kills waterborne microorganisms including bacteria and viruses too small to be filtered. Phase three, carbon filtration, absorbs organic contaminants from the water. Our three-stage process not only creates water with improved taste, odor and appearance, it also destroys dangerous, disease-causing microorganisms, leaving you Purified Water ... Anytime, Anywhere!



# Troubled Times



## Pre-Filter

---

In southern California we get a lot of rust and mud for several days coming through the pipes after every good sized earth quake we get. When choosing your water filter supplies, take into account the following: After a lot of earth quakes, any water source will have more mud, and other contaminates in it. Not to mention that when the shaking stops, all the sources of water (stream, well, rain, ..) will inherently have more contaminates than normal water piped into houses today. The lifetime of any filter could go down by a factor of 10-100 or more of what it normally would be expected of today's city water. What this means is that a ceramic filters that would normally filter 60,000 gallons, may only filter 600 gallons or less after the pole shift.

Multistage filtering becomes recommended. Pre-filters made of sand, swimming pool filters, or other commercial particle filters could be used to get the big particles out before going to the next stage. Occasional back-washing would cut down on overall cost.

Offered by [Mike](#).

A pre filter is necessary. Simple coffee filters will work. You can make a multiple coffee filter system very cheaply that will remove all particulate matter easily. Take a large diamet PVC pipe and put a series of circular filters inside of it. works great.

Offered by [Eric](#).



# Troubled Times



## Lead Trap

---

We had a solution for lead as well. If I am not mistaken we passed the water from the water main on a road through a filter that had **2 magnets** on either side with a baffel type device that would trap the metal.

Offered by [Brand](#).



# Troubled Times



## Systematic

---

The more I look at this situation, it looks like we need to:

1. Determine what contaminates will be getting into rain water as a result of volcanic activity and possibly earthquakes. This could be done by researching studies done on existing volcanoes and eruptions and what they cause.
2. Estimate levels (or range of level i.e. + or -) of hazardous contaminants that needs to be filtered. Done mostly from studies on existing volcanic activity.
3. Determine what contaminants are most harmful that will need to be filtered.
4. Investigate - research each filter type to determine what amount it will filter out for each of the hazardous contaminants.
5. Then, recommend the chosen filter technologies - companies.

In this way we can get workability and practical solutions.

Offered by [Mike](#).



# Troubled Times



## Home-Made

---

There is a do-it-yourself water filter system for under \$100 Parts can be purchased at Wal-Mart, or home depot. Plans cost \$5 to download, or you can get a CD, plans by mail for \$10.

Offered by [Jim](#).



# Troubled Times



## Ultraviolet

---

Source: adapted from *Manual of Individual Water Supply Systems*, EPA-430/9-74-007, **U.S. Environmental Protection Agency**

This method uses an ultraviolet light tube sealed in a quartz sleeve inside a stainless steel cylinder, which is connected to the water supply line. The untreated water from the source comes in at one end of the cylinder, passes around the ultraviolet tube, and exits through the opposite end into the safe water line. Ultraviolet light emanating from the tube kills the bacteria. Unlike chlorination, the ultraviolet light process does not leave a residual disinfectant in the water and the possibility exists for water to be recontaminated. For this reason the ultraviolet light unit should be installed at the end of all underground piping.

There is no simple test to determine whether the ultraviolet light is operating effectively. Ultraviolet rays must reach bacteria to kill them. To ensure proper operation, the ultraviolet light bulb should be replaced when it weakens. If the manufacturer does not supply an ultraviolet intensity indicator on the unit, the bulb should be replaced once a year. Some units are equipped with a photocell that indicates whether the light is on or off. This does not provide sufficient protection against light failure, because the light may be intense enough to indicate that it is operating, yet ultraviolet light output could be diminished to the point of ineffectiveness.



# Troubled Times



## Sunlight

---

Here is a way to sterilize water (micro-organisms only). Fill a large *glass* bottle with water (I use a wine flagon), make sure to dry the outside of bottle, wrap with blue (*must be true blue*) cellophane paper, secure at the neck of the bottle with a rubber band and place bottle in the sun for several hours, this destroys the bacteria and viruses by ultra violet light. This method will destroy bacteria and living organisms only, so another method to eliminate heavy metals etc. is necessary. I use a reverse osmosis, but there is a lot of waste water by this method. At present we use the waste water on the garden, but after the pole shift another method will have to be used as you don't want the excess lead in your vegetables. For the dark years after the pole shift an ultra violet sterilizing pen could be used. It's battery operated and easy to carry in a pocket by hikers, campers etc.

Offered by [Jan](#).





# Troubled Times



## Ozone

---

I found information on Ozone purification. **Walton Feed** also talks about purifying water with ionised oxygen. I am now going to see if we can get this product in Australia. You don't realise how lucky you are in America.

Offered by [Jan](#).

A company called **ALAB**, a research and development company in Pittsford has developed a generator that can miniaturize ozone purification, the detoxification process used by most municipal water treatment facilities. **ALAB's** device has shrunk the process from the size of railroad boxcar to the size of a food processor. The generator has a 15 year life span and will retail from \$80 to \$300... best of all no filters required.... coming in 2000 to a store near you. This information is from *Business Week* (11-22-99).

Offered by [John](#).

[Delzone](#) has for years produced a variety of ozone purification units for pools and spas. The principal is to pull air past a quartz ultraviolet tube, which produces ozone air this is then mixed with the water. A simple venturi, a narrow opening with fast moving water, pulls in the air past the UV light and mixes it with the water. What you found may or may not use the same principle. Depending on the volume flow the price of what you found could be much cheaper. We should keep an eye open for more information on this.

Offered by [Mike](#).

The nice thing about an Ozonator is that it can also be used for your hydroponics to not only oxygenate the nutrient solution but also kill algae growth. For about the same price, you can get ozonators for hydroponics use now, that are of pretty good quality for ozone purification. Keep in mind ozone only kills living organisms but does not filter out impurities. It will be interesting to see if **ALAB** combines theirs with some pre or post filtering for impurities, but at that price, it sounds like it could be a good buy.

Offered by [Steve](#).



# Troubled Times



## Oxygen

---

[Water Tanks](#), Inc. also sells a product called Aerobic Oxygen to stabilize the water and eliminate bacteria.

Offered by [Tony](#)



# Troubled Times



## Electricity

---

Would bacteria and viri in water can be killed by running a certain voltage through the water? Cells get destroyed by high voltage.

Offered by [Michel](#).

That would be akin to Dr. Royal Rife's work. By running current at very low voltage and specific frequencies, one can rid the body of all sorts of viri, bacteria, parasites, and so forth. The body is mostly water. I don't think it would be the voltage that would be important but the frequency.

Offered by [Martha](#).

Running a current through water causes the molecule to split into hydrogen and oxygen gas. It's called electrolisys, but there wouldn't be any contaminated water left. And if the two gases are collected and burned they recombine, the water vaper could be condensed and you would have uncontaminated water. So I guess it would work.

Offered by [Travis](#).

The name of the book about Rife is: *The Cancer Cure that Worked* by Barry Lyons. Try it sometimes. See how much oxygen, hydrodgen, and water vapor you can collect. Not much I'm afraid. In any event, this isn't the way to go about sterilizing water. It's a little like draining the lake to collect some fish. The rationale behind Rife is that every species of bacteria and viri has a specific resonant frequency. If you expose that bug to its specific resonant frequency, you will cause it to go into resonance and vibrate itself to pieces (literally explode). The key to killing bugs is not the size of the voltage, but rather the correct frequency. This is exactly what Royal Raymond Rife was doing in the 1930's and knockng out bugs and their associated disease conditions left and right (that is before Morris Fishbein and the AMA found out about his success and put him out of business-as they have consistently done with any innovator who discovers a cheap and easy cure.)

Offered by [Ed](#)



# Troubled Times



## Chlorine

---

I do have a book here that says it's good for emergency treatment of unsafe water. *Making the Best of the Basics* by James T. Stevens. It's called the **Basic Bleach Method**. Household bleach containing Sodium Hypochlorite 5.25% solution without soap additives or phosphates and the Sodium Hypochlorite should be the only active ingredient!

1 gal of clear water	8 drops
1 gal of cloudy water	16 drops
5 gals of clear water	1/2 teaspoon
5 gals of cloudy water	1 teaspoon

As you can see it's only a very very small amount of bleach, and as I said this is for emergency treatment.

Offered by [Jon](#).

In Woodbadge training for *Boy Scout Leadership*, we learned that 4 drops of chlorine bleach per qt. of drinking water will kill all bacteria and virus.

Offered by [Laura](#).

Below is a reprint of a [Sightings Article](#).

Offered by [Steve](#).

### **Water Purification Using Clorox Bleach - New Information**

Red Cross, July 17, 2000

The Red Cross National Headquarters has received inquiries from the public about the fact that the Clorox Company is introducing a new product, "Clorox Ultra", which increases the concentration of Sodium Hypochlorite from 5-1/4% to 6%, and adds Sodium Hydroxide to the mix, which has not been in Clorox before. They are doing this to reduce the size of the containers and in response to market research. They are introducing "Clorox Ultra" slowly across the country, starting in the West and Midwest. It will be on the East Coast by fall. They will completely eliminate offering the "old" Clorox bleach upon introduction of the "new" Clorox Ultra.

However, a Clorox representative stated that the new formula has been tested and is safe to use to treat water at home. The only reason why it has not been approved by the EPA for use is simply that the company has not completed that process yet. (It takes a long, long time for all that paperwork.)

The recommendation to use for water treatment remains the same:

1. Filter out/remove any solid impurities.
2. Add 16 drops of the bleach per gallon of water and stir. This is the same recommendation for either the 5-1/4% or 6% concentration.

3. Let stand 30 minutes.
4. If it smells slightly of chlorine, you can use it.
5. If it does not smell of chlorine, add another 16 drops and wait another 30 minutes.
6. If it still does not smell of chlorine after two doses, discard it and find other water.



# Troubled Times



## Cons

---

Chlorinated water is *very bad* for living creatures.

Offered by [Leila](#).

Chlorine is a solution if you can run to the grocery store and buy some chlorine, but I suspect I won't have that opportunity after the pole shift. I prefer a solution where I don't need to rely on stockpiles, but instead rely on things that I can produce myself. Undoubtedly I will stock some supplies just in case things get rough, but eventually my supply of chlorine would run out. Maybe it would run out in 10 years, but it would still eventually run out. And, no matter how safe the boy scouts say it is, I still don't like the idea of drinking even minute amounts of chlorine. Who can say for sure what long term affects it has.

Offered by [Ryan](#).

Carrying around a little chlorine sure beats lugging around a still!

Offered by [Woodie](#).

Chlorine will kill bacteria, yes that is true, but Chlorine will not kill a virus! A bacteria is a living thing, but a virus is not. Our biologists are having problems defining a virus. Is it a living thing, or is it a non living thing? Both answers are correct, because a virus in its dormant state consists only of a shell of protein and RNA inside it and that is all a virus is until it finds a host like a living cell and injects its RNA into the host cell to propagate. It then multiplies after the host cell DNA is destroyed/modified and replaced by the virus RNA.

Offered by [Tian](#).



# Troubled Times



## Standing

---

Make sure you let it sit for 30 minutes after adding the bleach before you drink it, preferably longer. The longer it sits, the lower the bleach concentration will be, but the first 30 minutes are to let it do its disinfecting work.

Offered by [Toni](#).

Chlorine is a gas in its natural state. Chlorine tablets will dissolve the chlorine in water, but the chlorine will eventually evaporate from the water, especially in the sun as any pool owner can tell you. I'm not sure of the rate at which evaporation occurs, but the drops to test chlorine in water can be purchased at any pool supply place for just a couple of dollars.

Offered by [Steve](#).



# Troubled Times



## Wine Treated

---

I ran across this short article about purifying water (against bacteria only).

Offered by [Steve](#).

**Wine Treated Water** - Since ancient times, in countries like Israel, Rome and (more recently) France, water was too polluted to drink untreated. By mixing 1 part red wine to 3 parts water, sufficient purification was achieved. For killing bacteria in laboratory conditions, red wine ranked 3 to 4 times more effective than pure alcohol or tequila. The effective ingredient is believed to be phenol compounds enhanced from charred wood of the wine-aging casks. This is important because the phenol compounds appear to be related to sulfur drugs previously used in basic antibiotics.

(Source: Dr. Trichopolou, *British Medical Journal* discussing the Greek Villager's Diet.)





# Troubled Times



## Wooden Barrels

---

The immune system of wood while alive has the chemicals necessary to resist and kill bacteria and other things like worms, and mold. This will readily dissolve into water with the help of alcohol as a solvent. All this explains why water keeps well in wood barrels. Water alone will dissolve these chemicals out to a lesser but sufficient extent. So after the pole shift, it's back to the old ways. Any one know how to make wooden barrels that don't leak?

Offered by [Mike](#).

Sounds like a job for a Cooper, whose trade this is.

Offered by [Jon](#).



# Troubled Times



## Containers

---

I know it can leach whatever metals/materials are used in the construction of the drum. If the bottom is attached by lead solder for example, you will have **lead leaching** into your water.

Offered by [Martha](#).

As far as storage is concerned, glass is best but not very practical. If you are going to store in plastic bottles, use **hard plastic** rather than the soft "poly" bottles. Hard plastic leeches less chemicals into the water.

Offered by [Michael](#).

Use an activated charcoal filter to get the **dissolved hydrocarbons** that may have come from the plastic.

Offered by [Mike](#).

You can also do what the old sailors did with their water storage, use a torch or fire to scorch the inside of a wooden container, i.e. your own **built-in carbon filter**.

Offered by [Steve](#).



# Troubled Times



## Storing Water

---

Water is one of the most important items to store. The amount often recommended is seven gallons per person for drinking and food preparation and another seven gallons per person for other limited uses such as hand washing, teeth brushing and dish washing (total fourteen gallons per person for two weeks). Both glass and plastic containers are commonly used for water storage at home. Containers should be clean and sanitary. Glass containers are breakable and somewhat heavy compared to plastic, but they are not permeable to vapors and gases, the amount of leaching (dissolving) of chemicals from glass into water is insignificant. Plastic containers are lightweight and substantially more resistant to breakage than glass. If plastic containers are used, care should be taken to assure that they are made of plastic approved for food contact by the Federal Food and Drug Administration. Polyethylene plastic is approved for food contact and is commonly used for containers of various sizes, including 55 gallon drums. Certain types of plastic containers are not intended for food contact (such as vinyl plastic waterbeds, or trash containers) and may leach undesirable chemicals into stored water.

For long-term storage, water should be sterilized or disinfected. Water stored in thoroughly cleaned plastic or glass containers can be chemically disinfected for long-term storage by treating each gallon with sixteen drops of liquid chlorine bleach (Clorox or Purex type bleaches, containing 4% to 6% sodium hypochlorite). One teaspoon of bleach disinfects five gallons of water. This level of treatment will prevent growth of microorganisms during storage. Water stored in plastic containers should not be stored near gasoline, kerosene, pesticides or similar substances. Vapors from these substances could permeate the plastic and affect the water. Thick-walled polyethylene containers are significantly less permeable to vapors than are thin walled containers. Be certain, when selecting a storage container for water, that it has a tight fitting cap or lid to prevent entrance of contaminants and evaporation of water. Because sunlight has an adverse affect on plastic, water should be stored away from direct exposure to sunlight.

Sterilized or disinfected water, stored in clean, food approved containers with secure lids or caps, should be safe for use even after many years of storage. Replacement of stored water with fresh water should be necessary only if the stored water becomes contaminated in some way or if the container should begin to leak. Be certain to label each container so there will be no question about its contents. Include the date and information on the method of disinfection used.



# Troubled Times



## Bulk

---

I think one should concentrate on how to purify water, and not store much of it. One could not practically store enough for any length of time. We will need 30 plus years or more before the rain washes the toxins out of the air and the sun can be seen again. Much more than this before the ground and lakes are clean, I expect. Constant volcanic activity will be the cause. One could store the thin plastic containers empty and then after the pole shift fill them with purified water. One could store a small amount in small well supported sturdy containers (1-5 gallon) to get one by until one could get the purification process started.

If one really wants to store lots of water one way would be to build an underground culvert storage space, then find a big thick plastic garbage bag. A water bed would work. Put the bag in the empty culvert, run a short filler hose through the top of the storage container. Fill with water, being sure to fill it completely. The bag will take the shape of the container. Put some Colloidal silver in it to kill bacteria growth. With little to no air in the top it will not slosh around, thus no extra forces trying to tear it apart when the shaking starts. You could also take a typical plastic water barrel, say 55 gal, dig a hole and place sand around it and fill it completely with water. In fact any of the so called weak containers could work if sand were packed around them. This would be true whether placed underground or placed in a strong crate.

Offered by [Mike](#).



# Troubled Times



## Hard Plastic

---

30-gallon or 55-gallon water storage barrels are the best. I prefer the 55-gallon barrels, but the 30-gallon are probably more mobile. The 55-gallon drums can be purchased new from [Water Tanks](#) for about \$50 each, including shipping (this is about the best price I have been able to find on the web). They are brand new, HDPE (high density polyethylene) plastic, and never used, so you don't have to worry about possible contamination from previous food materials. The HDPE is thick, food-grade material, and would have to reach temperatures of over 185 degrees Fahrenheit before it started to leach even a little. With the thickness of the plastic, the inside reaching 185 degrees is very unlikely. Additionally, the barrels can be used for other storage purposes as well. They are extremely strong.

Offered by [Tony](#).



# Troubled Times



## Soft Plastic

---

It's been three years now storing store bought distilled water in plastic gallon containers. Some have begun to leak but about 95% still holding their water. I believe this will be long enough a period of time. I moved and shook them several times in the last two years. I also bought a 500 gallon plastic water container that I put underground to store more. They are cheap this time of year at Farmer Supply Stores. I have also stored water (tap water) in 2 liter plastic pop bottles with a few drops of bleach with 5.25% Sodium Hypochloride (which is regular household bleach). I store them in the 8 pack plastic cases they come in when delivered to the stores. You can get them in the back of any large grocery store. They are usually stacked there by the hundreds. After two years of this type storage I found the water a little stale. If you aerate the water by pouring it back and forth into another container this will make it taste better. I had it tested and it was fine. My tap water is in a small farming community so It might be better than that of a large city. If you filter the water before long term storage it would be better No leakage problems with the 2 Liter containers so far.

Offered by [Carissa](#).



# Troubled Times



## Copper

---

I would like to point out that copper tubing cannot be used to distill water, its fine for alcohol, but not water, too many heavy metals will leech out into your water. Its best to use a food grade stainless steel tubing. Maybe for very short duration the copper will work. I brought this to your attention so that while we have the time to prepare we can at least prepare with items that have a longer term use and present no health hazards. Even though the price is a little high, the design of the distiller may help others come up with a distiller of their own. Food grade stainless steel (type 316L) tubing would be the best.

Today's alloys contain many impurities, this list is a few impurities found in copper used today, keep in mind these are maximum amounts but their there never the less: Antimony .01%, Arsenic 5ppm, Iron .005%, Lead .005%, Manganese .001%, Phosphorus .001%, Silver .002%. As the tubing heats up these elements are released. In certain concentrations can be lethal, heavy metals accumulate in our bodies and have very little way to be expunged from our systems, unlike colloidal silver and other colloids. The temperatures used in the home (especially the cold water side) do not leech much into the drinking water. The hot water on the other hand does have considerable more minerals and elements in the water than does the cold side. Long term use would deny you what you seek - survival. Besides you have no idea how long you may be ON FOOT. Its best to prepare for the long haul rather than trying to figure it out in the aftertime.

Offered by [Tim](#)



# Troubled Times



## Reverse Osmosis

---

Osmosis is a natural process, known for over 200 years, on which reverse osmosis systems are based. The walls of living cells are natural membranes. This means that the membrane is selective, some materials can pass through, it cannot.

[About Reverse Osmosis](#)

This page explains pretty well what reverse osmosis is for treating water. I had no idea either (still don't) but the illustrations help. (Not endorsing any product here. But they have great info.)

Offered by [Clipper](#).

I looked at that page and you are correct in that its description of reverse osmosis is not a very understandable explanation. I have always heard it explained like this: *Reverse osmosis filtering of water is done by forcing the water under high pressure through a porous membrane. The holes in the membrane are large enough for the water to get through but trap larger particles which would be impurities.* The "high pressure" part is the key as the holes in the membrane are so small that nothing would get through without it.

Offered by [Michael](#).

That's as good a definition of Reverse Osmosis as I have heard. I've used them for years, they give you great water but they also waste a lot. I'm not sure how effective they will be after the pole shift. If you can hook up a hand pump they could be very handy.

Offered by [Stan](#).





# Troubled Times



## Salt Water

---

From *The book of Survival* by Anthony Greenbank, pages 51-52.

Whatever is advised her, the temptation will grow and grow and grow. The castaway, anguished with thirst, thinks that perhaps he is different and will be able to take salt water without harm. That perhaps there is some loophole and he'll be all right. Then vague recollections of people who survived by drinking taboo fluids come pounding in. Then what the hell ...

And he drinks (perhaps pretending it to be accidental). And at first seems the winner. The saline refreshes, revives, assuages. It seems to last, too, until he presently is called on to sip again. And again. And again. And againandagainandagainandagainandagain. His thirst, whatever before, will balloon into fiendish proportions. And quite soon, with racing pulse, sickness, enlarged tongue, blue skin, glassy eyes, deluded and deaf, he will die in delirium.

Sea water can be used: for cooling hot body; chilling eye compresses when you are sunblind; swilling off salt encrusted tarpaulins/containers/decks when rain shower is due and you don't want solid salt in supply. But never drink it!

Offered by [Clipper](#).



# Troubled Times



## Bad Options

---

From *The book of Survival* by Anthony Greenbank, pages 51-52.

### Urine

Don't drink, as salt content too high. You become thirstier. Use to make damp cooling pad in burning heat. Or to warm chilled skin in cold

### Alcohol

Consumption not advised. Could precipitate rash actions in survival situations.

### Battery water

It might contain toxic amounts of lead.

### Fish fluids

Don't drink---even if you have the chance. Many have been found harmful, though there are exceptions.

### Glacier water

Rushing melted water from snow areas in mountains contains pounded/powdered/crushed rock. However, alternative clear-water supplies are usually available in the hills.

### Anything milky, salty, soapy

The exceptions (like coconut milk)

Offered by [Clipper](#).



# Troubled Times



## Urine

---

Could one use a still to recycle urine into a drinkable form and does drinking distilled water essentially rob your body of minerals through osmosis? If it does rob your body are there natural ingredients you could put in the water that would make it drinkable again?

Offered by [Ryan](#).

Urine is already drinkable. It is common among certain yogis and essential in extreme conditions such as when parched in the desert. You may not have heard of drinking camel piss, but that doesn't mean it doesn't happen.

Offered by [Jeff](#).

I know people have done this in extreme circumstances, but I'm talking about living healthy for a sustained period. Aren't there any contaminants in urine, things your body was trying to eject?

Offered by [Ryan](#).



# Troubled Times



## Volcanic Ash

---

The Aug 24, 1996 **Earth Week** column in the *San Francisco Chronicle* reported that:

Three dairy cows in New Zealand's Atiamuri area **died from a toxic level of fluorine after grazing on pasture covered in volcanic ash** from recent eruptions of Mount Ruapehu. Another animal had to be destroyed after it was discovered that it too had ingested ash-laden fodder. Ruapehu has remained relatively quiet in recent weeks.

Excerpts from a December 15, 1997 *Associated Press* article called **Volcanic Eruption in Sierra would Jeopardize LA Water**

LOS ANGELES (AP) - After recent swarms of earthquake tremors in Los Angeles' main watershed, authorities are worried about what would happen to the city water supply if a volcano were to erupt. A magnitude-4.9 earthquake struck the Mammoth Lakes area Nov. 30 - the strongest of thousands of quakes since the summer ...

However, Department of Water and Power geologists recommended last week that the agency update its plan for dealing with a possible eruption in the Mammoth Lakes area. Two-thirds of all water used in Los Angeles comes from a network of streams, reservoirs and aqueducts that stretches for hundreds of miles down the eastern Sierra Nevada through the remote Mammoth Lakes area. The earthquakes are believed to be caused by moving magma, or molten rock, fracturing rock or pressurizing liquid roughly four miles beneath the surface, which has risen more than 2 feet in places over the past 18 years. ...

**Seismic activity in the area already causes water quality problems, introducing arsenic and other chemicals into the water supply. Extensive treatment is required to reduce the level of the toxic element in the city's drinking water.**



# Troubled Times



## Forest Fire

---

### Fires caused blue rain in Argentina - scientists

*Reuters*, October, 1998

Blue rain that astonished residents of a northern Argentine town in September was caused by ash from forest fires, government scientists said Saturday. Ash from huge fires to the north in Bolivia and Brazil blew over Argentina and mixed with the rain, giving it a bluish tint, scientists from the Corrientes province health ministry said, according to the state-run *Telam* news agency. Baffled locals from the town of Perugorria collected samples of the strange rain when it fell Sept. 2, and handed it over to the government for analysis. A health ministry lab found ash in the rain water that it linked to the forest fires after studying meteorological records.



# Troubled Times



## DoE Dump Sites

---

Not that we did not believe there were problems with groundwater stability, now we have something even more frightening to ponder.

Offered by [Brian](#).

[The Scientist](#), University of Pennsylvania  
Issue Volume 12, No. 20, October 12, 1998

### **Superbug Resists Radiation**

Bioremediation pairs microbes with tastes for toxins with a contaminated site in the hope that the organism will metabolize away the problem. But the radionuclides in these dumps often harm the bioremediators. A solution: transfer detox genes to *Deinococcus radiodurans*, a bacterium so radiation-resistant that it's been found in nuclear reactors. ...The superbug withstands continuous radiation and oxidizes toluene, chlorobenzene, 3,4-dichloro-1-butene and indole. Such boosted bioremediators might someday help clean up the 3,000 dump sites that are the Department of Energy's legacy of the cold war. "From 1946 through the late 1960s, thousands of open pits, each the size of an Olympic swimming pool, were dug and lined with concrete. But the concrete has broken down, and solid and liquid organic wastes have leaked. In 50 percent of these pits, the leaks threaten groundwater supplies," Daly says.



# Troubled Times



## Distilling Drinking Water

Lead is fairly easy to remove using nothing more than a quality Granulated Activated Compressed Carbon block. However, distillation really takes care of everything and is a simple technology, an after filter of carbon on a distiller takes care of any contaminates that might co-distill. If electricity is available then at least a 600 watt element is needed to slow boil approximately 15-20 liters of water, otherwise fossil fuel or perhaps producer gas and a simple coil condenser run through cold water is all that is needed - the whole thing could be built for no more than \$10.00. I once designed and built a prototype distiller that had a large lid with an oversize heat sink with fins like those seen on radio transmitters, it worked as well as a condenser coil type. This is a simple drawing of the condenser distiller I built.

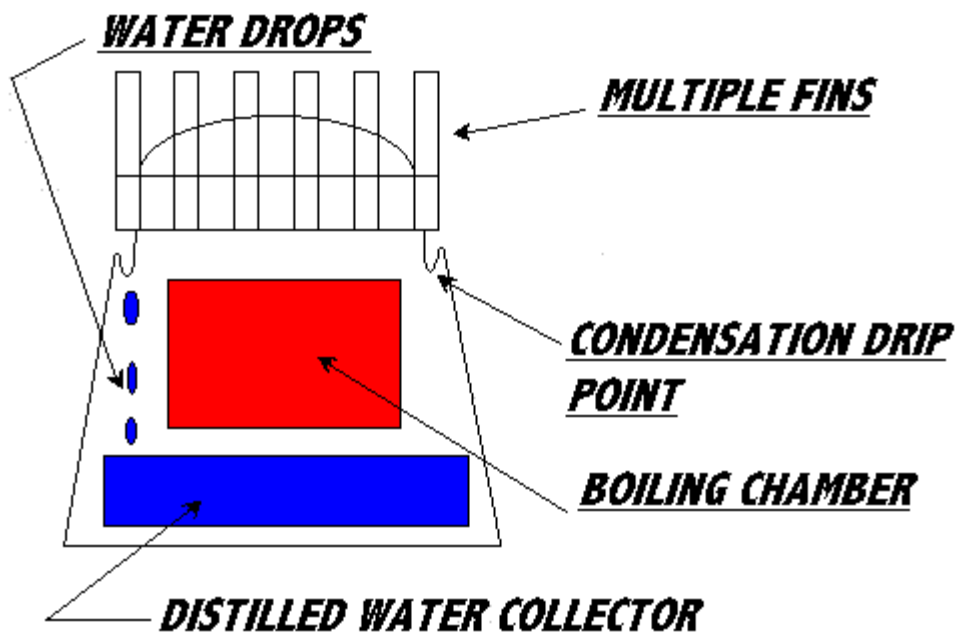

Offered by [Darryl](#).



# Troubled Times



## Arsenic

### **Arsenic standards too lax, Federal advisory group says some drinking water is unsafe**

*Medical Tribune News Service, by Dan Vergano*

Citing cancer risks, a government advisory committee recommended Tuesday that the Environmental Protection Agency tighten its standards on the amount of arsenic allowed in drinking water. The EPA established the current maximum level of arsenic in drinking water, 50 micrograms per liter, in 1975, based on then-current knowledge of skin-cancer risk from the chemical. Long known as a poison, arsenic occurs naturally in the soil, where it can contaminate water, plants and animals. “The risk of cancer at presently allowed levels is alarming, and the standard should be lower,” said Dr. Robert Goyer, an emeritus professor of pathology with the University of Western Ontario in London, Ontario. He chaired the National Research Council committee that released a new report which found “a combined cancer risk of one in 100” from drinking water with the currently allowed maximum level of arsenic. Two of the 16 committee members dissented from that finding.

Goyer noted that very few water supplies nationwide contain the chemical in dangerous concentrations. Well owners who do have concerns might want to test their water, said Brian Folk, owner of Fresh Water Systems in San Diego. **While carbon filters will not take help, distillation effectively removes the chemical**, and some reverse-osmosis filters are also effective, he said. The NRC is a branch of the National Academy of Sciences, a non-profit group that provides independent advice on scientific issues to Congress.

New data from Bangladesh and the Bengal region of India linking arsenic to lung and bladder cancers led the EPA to request the report. In those areas, residents have dug wells deep into the ground, where arsenic levels are higher, according to Goyer. There, men who consume the EPA’s maximum-allowed levels of arsenic in drinking water face a bladder cancer risk of one in 1,000, far above the EPA goal of limiting risk to one in 10,000. In the United States, some residents of Western regions with little rainfall have used very deep, or “artesian,” wells for decades, but arsenic levels are not thought to be excessive there, said Goyer.

Less than 1 percent of all public water systems contain even 20 micrograms of arsenic per liter, according to the EPA. “It’s not a widespread problem but certainly a serious one where it occurs,” said Robin Woods, an agency spokesperson. Combining the risk for skin cancer, bladder cancer and lung cancer suggested by various studies led to the one in 100 cancer risk assessment, said R. Julian Preston, director of the Environmental Carcinogen division at EPA in Research Triangle Park, N.C., who served as a committee member prior to joining the agency. One problem the committee faced was a lack of data on the effects of low levels of arsenic on people. Some studies indicate that humans handle toxins like arsenic very well in small amounts, according to the report. At high levels, the chemical causes skin lesions and rashes, as well as possibly promoting cancer.





# Troubled Times



## Lead

---

I finally found a reasonably priced do-it-yourself lead water test kit from [American Water Service](#) for \$12.99. They also have other water testing kits. I actually bought my overpriced kit from **Precise Radon Testing, Inc** for \$35, where I found **American Water Testing** in the enclosed brochure when I received the test in the mail.

Offered by [Steve](#).



# Troubled Times



## Distillation Process

Every substance can exist in three states: as liquid, as solid state and as vapor, which mostly depend on it's temperature. This applies to water, too. So, water can be found as ice, water and steam. If water is cooled down below 0 degrees Celsius (32 Fahrenheit), it becomes ice, and if heated above 100 degrees Celsius (212 Fahrenheit), it becomes steam. The temperature, at which a substance changes it state from liquid to vapor is called a boiling point, and is different for different substances. This difference can be used to separate substances, and as such can be used for water purification.

The process is relatively simple: the dirty water

- a) is heated
- b) to the boiling point and thus vaporizes
- c) (becomes steam), while other substances remain in solid state, in boiler. Steam is directed into a cooler
- d) where it cools down and returns to a liquid water
- e) and the end result is a water, purified of additional substances found in it before distillation.

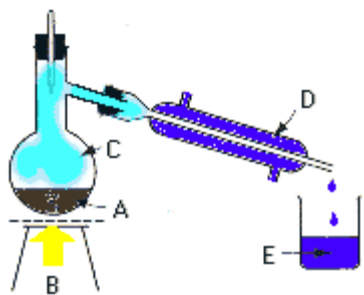

Distillation is an effective process and, what's more important, it can be done with a lot of improvisation. You can heat water with whatever is at hand: fire, electricity, or whatever. You can use almost anything that holds water for a boiler, as long as you can direct steam into cooler, which can also be anything from a long enough pipeline to a real cooler, just that steam cools down in it. In worst case, you can distill water with an ordinary household pot and two potlids. Boil water in a pot covered with first potlid. After a while, you'll see that water in a pot vaporizes, and condenses on a potlid (this is distilled water). Just replace potlid with a second one, and turn the first one vertically, so that all condensed water collects at one point, and pour over to a cup. Meanwhile, distilled water condenses on a second potlid, so just repeat the above steps again... until you have a full cup.

Distillation will remove from water almost anything, even heavy metals, poisons, bacteria and viruses etc. However, it does not remove substances, that have boiling points at lower temperatures than water. Those are some oils, petroleum, alcohol and similar substances, which in most cases don't mix with water, and can be removed with filtering. Also, remember that substances removed from water remain in boiler, so you'll need to clean it up, every once a while.

Distilled water can be directly used, and does not need to be boiled again. As it is already hot, you can use it to prepare tea, or similar drinks. Drinking bottled distilled water alone is not recommended by official medicine as it is intended for car radiators rather than human consumption, although some alternative doctors recommend drinking clean distilled water. Try and/or decide for yourself.

Offered by [Kiko](#).



# Troubled Times



## Simple Process

---

*Every element can exist in three states: as a liquid, as a solid and as a vapor, mostly depending on its temperature. This applies to water, too. So, water can be found as ice, water and steam. If water is cooled down below 0 degrees Celsius (32 Fahrenheit), it becomes ice, and if heated above 100 degrees Celsius (212 Fahrenheit), it becomes steam. The temperature, at which a substance changes its state from liquid to vapor is called a boiling point, and it is different for different substances. This difference can be used to separate substances, and as such can be used for water purification.*

You can easily come up with your own solution for distilling water once you understand what distilling involves. There are three major steps to distilling water. Also some minor ones like cleanliness of equipment and having connections as airtight as possible, but I think that most of them are common sense. All distilling consists of evaporating water then cooling the evaporated water and collecting the clean, pure water. Almost anything will work in a pinch. Distillation is a simple process. Don't forget that dew is essentially distilled water. If you can recreate the dewing process and collect the water from it then you are also on your way to clean water.

I have read survival books that say that a clean piece of cloth over a boiling pot can be sucked on or wrung out in the most desperate situations. Not very effective, but you get the point. I have seen something that takes a curved glass lid oversized for its container that allows light in and catches the water as it evaporates and drops it over the edge of the original water container. I've seen a diagram for a campfire distiller that uses the campfire to heat the water, runs a tube underground to cool and condense the water and then collects it in a half buried container to minimize evaporation from the secondary container.

Offered by [John](#).



# Troubled Times



## Make Steam

A **pressure cooker** or some **whistle type tea pots** can be used to make a crude distiller. The old fashion pressure cooker with a pipe sticking up on the lid will work good without modification, otherwise an outlet pipe may need to be epoxied, screwed (taped and threaded), or otherwise secured onto the lid. Use rubber tubing to connect the pressure cooker to the top of a **spring shaped coil** of 1/4" or bigger copper (or steel car gasoline line) tubing. The copper spring shaped coil is vertical with the top end positioned below the top of the pot so that condensing water runs down hill from the pressure cooker to the spring coil. Water then runs down hill coil by coil on the inside of the spring coil of the tubing to another pot or reservoir that catches the condensed water. The tubing is positioned so as to stay cool with air circulating around it. The tubing can be made longer if steam is still coming out instead of water.

Thermally insulate the top and sides of the pressure cooker with several layers of loose fitting **aluminum foil** to improve the efficiency and heat loss. Make a cap that fits over the top and sides of the pot. Keep it away from open flames it may melt the aluminum foil. This will help reflect the heat back to the pot. Make this foil cover with many air pockets between the layers - helps cut down on the thermal conduction from one layer to the next. Now at this point you can produce distilled water. The only disadvantage is you need to stop and fill the pot every so often.

One way to get around this and keep the pressure cooker filled all the time is to tap threads into the side of the pot near the bottom and connect a small **copper tubing** (using an appropriate fitting) to a separate container that can be kept full to a mark at regular intervals. This water mark may need to be higher than the intended water level in the pressure cooker. This would be dependent on the amount of back pressure or how small the outlet tubing is compared to the amount of steam being produced. A little experimentation will determine the correct water line to use. Note: The tubing between the pressure cooker and the supply needs to be small or can be slightly kinked to cut down on oscillations of water from the pot flowing back to the source water. Oscillations will cut down on efficiency and heat up the source water. A one-way-valve or **needle-valve** can be used also if available.

How to get around someone needing to fill up the source container every so often: A cheap **float valve** like the type used in evaporation water coolers or toilet tanks can be used to keep the water level up to a given mark in the source container. Water could be supplied under pressure by a battery operated water pump from a remote source of water. **Copper tubing and fittings** after the pole shift can be found in under the counter water filters, dishwashers, refrigeration ice makers, and evaporation type water coolers. The above solution has three different levels of complexity depending on what one is capable of building. Each level is workable to produce distilled water if one stopped at that level.

Additional thoughts on condensers: If one can make steam in a big way, consider using the **radiator or heater coils out of a car** as a condenser. Note: Any condenser whether the copper spring coil or the radiator out of a car, if not efficient enough, use water cooling on the outside.

Offered by [Mike](#).



# Troubled Times



## Open Tea Pot Distillation

Can sheet metal or large surfaces be used to distill water evaporated from an open pan etc? Answer: Technically Yes, but practically No. If one needs a practical way to produce drinking water before one dies of thirst this method becomes very problematic. This method will produce a small energy inefficient amount. I was able to get about one or two drops every 10 sec by using this method, shown at right with an open aluminum duct. It is easy to produce way too much steam and overwhelm the cooling area, which needs to be as large as possible. If one produces too much steam it keeps the condensation area hot all the time and thus no condensation takes place. One will not be able to regulate the source of heat in a primitive environment thus this method could be a problem.

Another big disadvantage is if the relative humidity is too low (say below 40-50%) then condensation will evaporate before it runs off. This method then will not then work. The source of heat whether burning wood, gas, or electrical has a tendency to produce hot dry air above the fire that will rapidly evaporate the condensed steam. In other words one needs to transport the steam a bit away from directly above the fire area before trying to condense it.

Sometimes it helps to slightly cap off the ends to reduce the flow, as shown below. If there are contaminants in the surrounding air that are settling out (like volcanic ash) then this open process will allow the distilled water to become contaminated again. Bottom line: The open-air process is the problem in this method it introduces too many variables. After a PS in a primitive environment one needs a controllable process that can be repeated under widely varying weather conditions.





Offered by [Mike](#).



# Troubled Times



## Closed Tea Pot Distillation

What about using a nearly closed area for condensing steam? This works better than the above open sheet method but is still not that practical in a primitive environment due to the need to carefully control steam flow, and the size of the cooling area needs to be large. Again too much flow easily overwhelms the surface area and will



produce no or a small amount of distilled water. The heat from the fire producing hot air needs to be directed away from the condensing area. For this method one can use 10 foot galvanized steel roof rain down tubes, air-conditioning duct piping without insulation, or sheet metal vent pipes.

The tests with this scheme were done using only one section of aluminum 3" vent flexible pipe 7 ft long. The open upper end needs to be nearly closed off so that it limits the steam flow. When properly adjusted, I was able to get 1 cup of water every 1.5 hour using this 3" by 7-foot method. If one had enough of these pipes and a way of directing the steam flow into each then one could produce sufficient water for drinking. One advantage of is this method is it can be made to limit the contaminants in the air from entering into the distilled output.

Speculating now, if one had the space to do it, probably outdoors; one could build a porcupine looking half circle made out of 5-10 rain down spouts. One would take a bunch of these 8-10 foot rectangular tubes made out of galvanized steel, and join the open end (down ward direction) in a hemisphere shape. The upper closed end would have a small hole that could be adjusted by partly closing it off to maximize water output. I am thinking the ones that are nearly vertical would work best with a small air escape hole, and the ones that are more diagonal would work best with a slightly bigger hole. The water would collect on the inside as the outside cools off. As the water runs down the pipe and gets close to the end there could be smaller catching tubing that could be positioned to allow the water to run off into a collection point. The fire would be built off to one side and the steam diverted by use of air ducting into this hemisphere. Heat from the fire would be directed away from entering the tubes.

Another idea: I bet one could take 2 garbage cans or two 55 gallon tanks or any 2 large metal containers and make a water distillation unit. Visualize two garbage cans lying horizontally on something that blocks it about 4 or 5 ft off the ground. Set the bottoms facing each other and flush with each other. In the center off to one side (not under the cans) visualize a fire built with water in a pan above it. Run an air ducting vent pipe from over the boiling water to divert the steam into a cut hole in each can. This would be big enough to allow the steam to enter near the bottom of each

can (right over the steam). The cans have their lids in place and taped shut. A small hole (let the air out) may be needed in the lid to tune it up to producing maximum distilled output water. Because of the tapered shape of a garbage can the water would run toward the lid of the can and out into a small catching container. All of the above methods use air to take away enough heat to allow the steam to condense as water this takes a lot of surface area if no movement of the air is present. It would be much more efficient to use a fan on the outside of the cooling surface. However, in a primitive environment this will not be likely due to then need for electrical power, thus I did not do any testing in this direction.

If one had available a car radiator or car heater unit turned diagonal and allowed steam into the top in a slow controlled way so that no steam came out the bottom then one could collect the distilled water as it ran out the bottom. This would take some cleaning and purging of used radiators to get all the foreign chemicals out.

Offered by [Mike](#).





# Troubled Times



## Coil Exchange Distillation

What about using a bucket of cold water and coils of copper tubing to condense the steam? This approach is basically building a simplistic water-cooled heat exchanger. The input reservoir can be a commonly available pressure cooker of any size. Alternatively the input reservoir can be made from any able to be closed container. Not much pressure is involved so theoretically it could even be made from a paint can in a pinch. I used a 4.2-quart aluminum pressure cooker that took about 15 min to start producing output once it is turned on from a cold start. Using the attached test set up shown at right, with coil detail below, I was able to produce about 6.5 cups/hour of distilled water. The input source was an electric stove 240 volt x 7.3 amps = 1750 watts. Note that water is replenished from the upper reservoir at the same rate it is turned to steam by adjusting the needle valve on the supply bucket and keeping track of the level by use of the site gauge (silicon rubber hose) on the side of the pressure cooker.

I found the water in the heat exchanger bucket gets extremely hot (from top down) and needs completely changing approximately every 35 min. This is a messy process in that when the tank is drained the copper coils get extra hot and the output hose and rubber seals get very hot. For good tasting water it is not good do to this extra heat on vinyl or rubber parts and it also tends to introduce leaks in the bottom of the exchanger tank where the copper tubing makes its seal with the stainless steel bucket. After a couple of hours of running I didn't consider this design to be good enough for day-to-day production unit worthy of a primitive environment. One could defiantly not walk away from it and leave it unattended. It would take constant maintenance and attention.



Also the resulting water had a strong vinyl taste to it. As a result, I don't recommend using vinyl on any output part of the distillation system. Along the same line, any hydrocarbons (oils) that are in the water before distillation will end up in the output having been evaporated and then condensed back into the output water. Thus taste will be a problem using this method because of the estimated large amount of hydrocarbons (oils) found in the after PS available water.

Also the method of measuring the water level in the pressure cooker needed some redesigning. Silicon rubber fish tank air hose will soften and swell up and eventually split open or leak at the ends. I initially tried to use this for a water

level indicator and rapidly found it was not practical. Vinyl is worse it will swell, turn white, stretch and becomes very soft so it is not very usable on the hot output side. Glass tubing would work but is not available or practical in a primitive environment.



Offered by [Mike](#).



# Troubled Times



## Full Exchange Distillation

What about using continuous but controlled flow of cold water in a closed heat exchanger to condense the steam? What about, in order to improve taste, evaporating the dissolved hydrocarbons before introducing the water into the boiler? This approach is basically building a water-cooled heat exchanger by using copper pipes and fittings. See the linked test set up example at right. This approach also has incorporated lessons learned about heating and evaporating the hydrocarbons in the incoming water to the boiler. Note by dripping hot waste heat exchanger water into a small copper cup, it loses its hydrocarbons into the air. An efficient heat exchanger can be made out of .5" and 1" copper pipe and T-fittings for the end. Using the same electric stove producing 1750 watts and no insulation on the hot spots, after one hour I measure 2.8 Gal of 140 deg F waste hot water and 6 cups of output distilled water at about 16 degrees above room temperature or 86 deg F in my case. This is about 1.5 quarts/hr or 9 Gallons/day. More heat or more insulation and it would produce more output water. More units or a bigger pressure cooker and several heat exchangers running off the same pot in parallel would also produce more output.

### General Construction and Adjustment notes:

Be sure to remove the burr off the inside of the 1/4" copper pipe that solders to the open-air-replenish-cup. With the small hole the inside burr leaves after pipe cutting it will sometimes cause the cup to overflow (depending on surface tension of the water at the time).

The saddle clamp needle valve was about 2.6 turns open for operation. The water valve to the bottom of the heat exchanger was open about 1/8 to 1/4 turn. I used a typical stop valve that has a rubber washer in it. This changes dimensions while in operation depending on temperature. The result is a need to constantly adjust the flow rate. I would recommend using a 1/2" gate valve instead. This has no rubber parts and the flow once adjusted will not change with temperature. See below.

Rubber hoses work much better than vinyl but one cannot see through it. 5/8-inch car heater hose was used for sealing the 1/2 inch tubing (outside diameter) that was slipped into the 1/2 inch copper pipe (inside diameter) of the heat exchanger. This same hose was used for the output wastewater. I don't recommend using hose on the output of the heat exchanger for the good distilled water. If one gets steam coming out

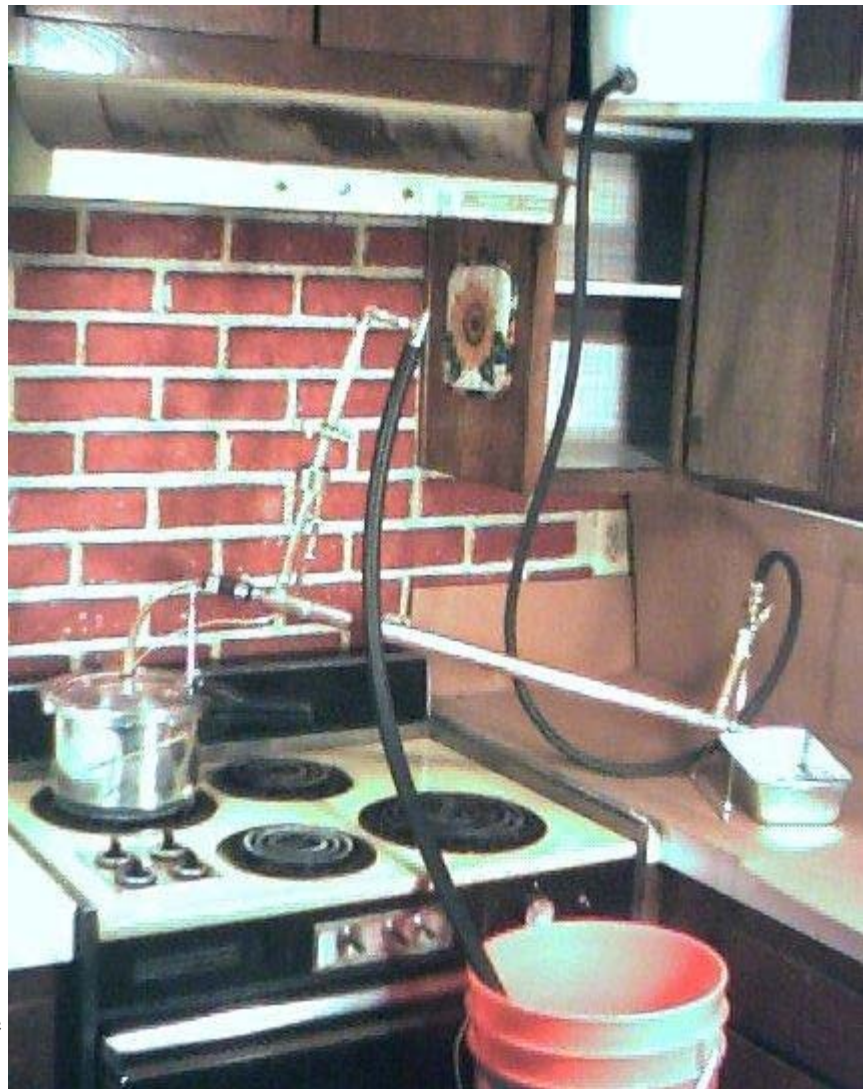

(too little water flow in the exchanger) then the taste of the hose will get into the distilled output water.

The flow of cooling water in the heat exchanger can be adjusted by measuring how hot outside 1 inch pipe gets along it's length. If one is careful one can use ones hand. Start at the cold end and gently move along the pipe to the point of needing to take ones hand off the unit. One wants to adjust the water flow so that it never gets hot at the cold end and is hot to no less than the center of the length. This is all depending on how much water you want to heat to what temperature. Generally one can do 130 to 180 degrees F for wastewater out of the heat exchanger without insulation.



Offered by [Mike](#).



# Troubled Times



## Hyrdocarbon Residue

Measuring about 140 degrees at the boiler replenish cup is about typical. See example at right. If one has a lot of taste (hydrocarbon) in the result then one wants to get the replenish cup up to as high a temperature as possible by slowing down the cooling water in the heat exchanger. This will cause the hydrocarbons to boil out of the water as it drips though the open air between the needle valve and the open copper replenish cup. The cup has a baffled barer in it that blocks the surface of the input from reaching the output side. This keeps the lighter hydrocarbons (oils) on the input side until they evaporate. The output .25" tubing is positioned a bit off the bottom of the cup.

Insolate to keep the heat in the cup on down to about 1/3 of the heat exchanger and the full length of the exposed 1/4 pipe that goes to the pressure cooker. See example below. Insolate to keep the heat in the top of the pressure cooker and the pipe leading to the exchanger. This will make the operation more efficient.

One can always make some charcoal by heating wood in a closed chamber and burning the gasses that come off to help produce the heat necessary. The charcoal can then be used to take the hydrocarbons out of the distilled water by filtering it though a container full of crushed charcoal. Hopefully this will be un-necessary if one can pre-heat the water enough to drive off the bad tastes.





Offered by [Mike](#).



# Troubled Times



## Pressure Cooker

Silicon rubber II sealer seems to hold up well in the steam environment and can be used to seal the pipe going through the top of the pressure cooker if a rubber grommet is not available. See example at right.

<http://home1.gte.net/mikelob/Exch-Lid.JPG>. A rubber grommet from the firewall or from the PVC valve from a junk after PS car may be able to be used. The grommet used for the safety valve in the pressure cooker may be able to be used. By the way I found the new "step drill bits" to be quite usefully in drilling the hole in the lid of the pressure cooker and when needed in the side near the bottom for supply 5 gallon buckets.

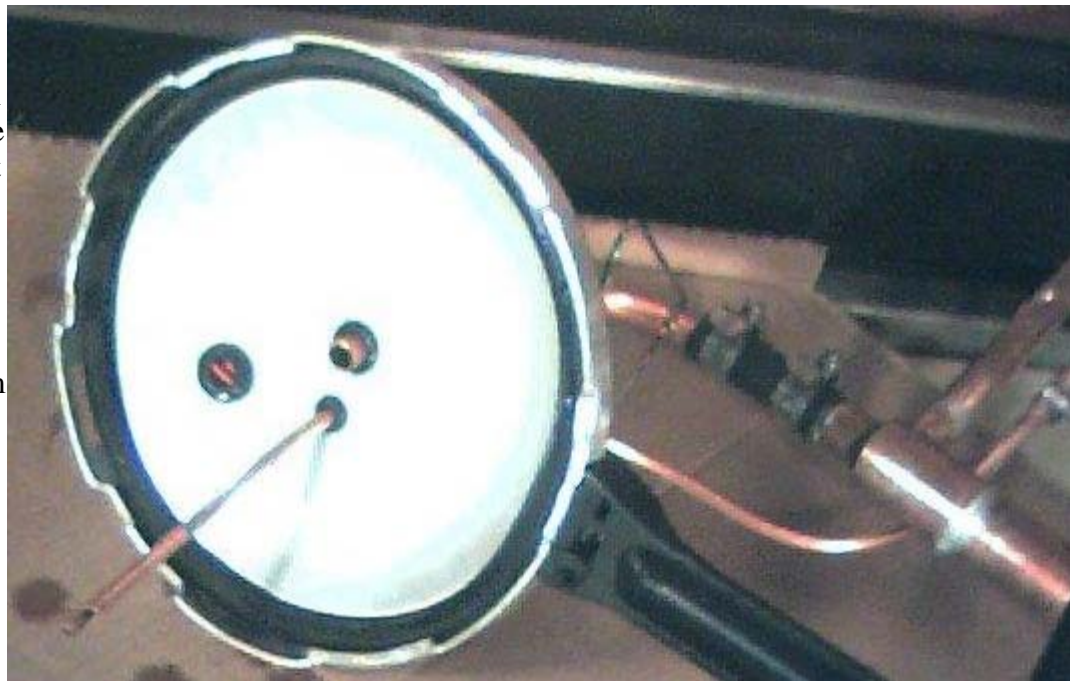

A float was used to measure water level inside the pressure cooker. See example below. It was made out of a large inline disposable gas filter with the ends cut off and soldered up to make it air tight. 3/32" Brass brazing rod was used for the float hinge mechanism. Any other type of wire would also have worked including coat hanger wire. Small copper pipe about 3/16 inch was used for the outer hinge and was epoxied to the aluminum pot by use of copper epoxy. The copper epoxy is designed to replace solder and is sold at home improvement stores like Home Depot.

The 1/2 inch pipe that comes out of the top of the pressure cooker and the inside pipe of the heat exchanger needs to be just big enough in diameter so as to not build up a back pressure in the cooker. Bigger pots and hotter fires may need a bigger pipe or more than one heat exchanger may be needed..

Occasionally the pressure cooker will need to be shutdown and the contents emptied out to dispose of the salts that build up. The frequency will depend on the dissolved mineral content of the water.

Water taste: Using the copper coil approach the output had a strong vinyl hose taste. Using the last approach with the heat exchanger and the hot water dropped through open air to remove hydrocarbons before entering the boiler chamber resulted in very little taste.

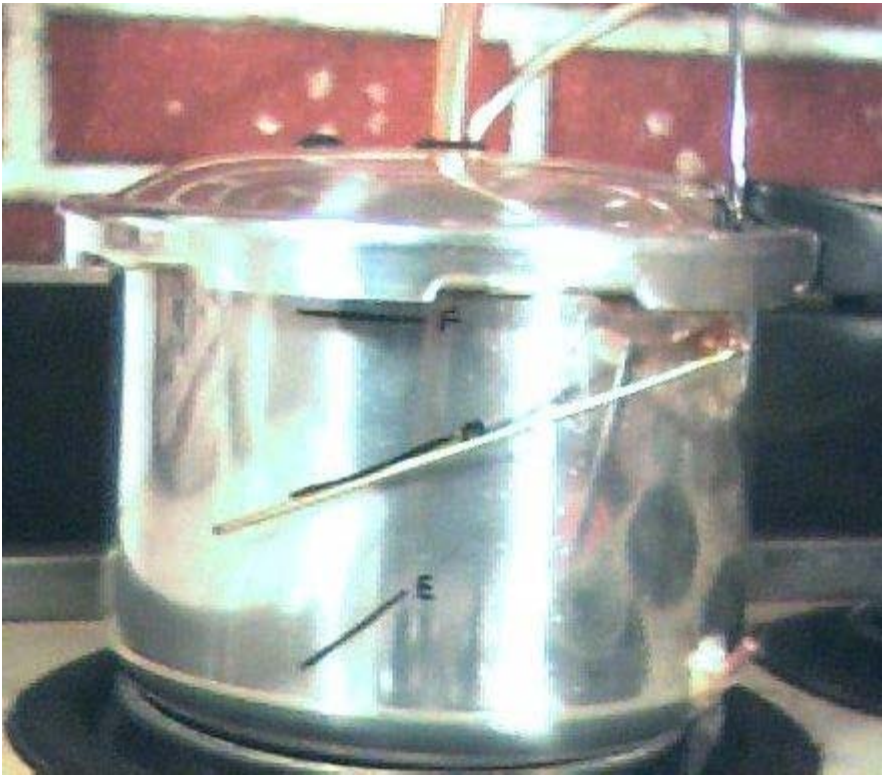

Offered by [Mike](#).





# Troubled Times



## Parts List

The unit was built to be broken apart and shipped in a standard home Depot box no bigger then 18" by 18" by 25". Recommend using only lead free solder. Your prices might a bit different I included my current cost.

### Quantity Description

- 2 coat hangers (used to make the support for each end of the exchanger). See photos below.
- 1 29" by .5" copper pipe (about \$1.10)
- 1 23.5" by 1" copper pipe (about \$3.00)
- 2 1" by .5" by .5" copper Ts (about \$4.50 each). This was the hardest item to find. I needed to go to a pipe supply place. I in a pinch believe you can use .75" x .5" x .5" pipe and fittings from local home improvement stores if you can not find this 1" T. The 1" versions are better and worth looking for. See detail photo below.
- 1 14.5" by .5" copper pipe (about \$ .60)
- 1 4" by .5" copper pipe (about \$.20)
- 1 2" by .5" copper pipe (about \$.10)
- 1 .5" copper T (about \$2.00)
- 1 .5" copper 90 degree elbow (about \$1.98)
- 1 10.5" of soft copper tubing .5" OD (about \$.80)
- 1 .5"solder by .75" garden hose water valve (\$4.25)
- 1 20" by .25" copper tubing (\$.30/ft)
- 1 25" Self – Tapping Saddle Valve or Gate Valve if you can find it (\$4.92)
- 1 1.5" copper end cap (\$2.00)
- 1 6 ft washing machine input rubber hose (3/8" ID) one end cut off (\$6.00)
- 1 6 ft of 5/8" car heater hose (\$4.79)
- 5 hose clamps (\$.69/each)
- 1 Barb 3/8 by 1/4 pipe tread for bucket feed though to hose. (\$1.29)
- 2 1/2" washers for bucket feed though (one inside, one outside, silicon rubber seal in-between) (\$.13/each)
- 1 1/4 inch pipe coupling for bucket feed through (for inside bucket) (\$.69)
- 1 Purolator (F20030) fuel filter (pep boys) for float in pressure cooker (\$3.99)
- 1 4.2 Qt Aluminum pressure cooker (Mirro brand \$17.57 from Wal-Mart)
- 1 3/32 inch Bronze welding rod. (\$.25)
- 1 3/16 small length section of copper tubing was used for float hinge (\$.40)
- 1 5 Gallon paint bucket for supply water (\$3.00)
- 1 9/16" id rubber grommet (\$1.54/3)
- 1 1/4" ID rubber grommet (\$1.54/6)
- 1 pipe insulation (\$1.19)

**Total is about \$74 for parts**

Assembly instructions after shipping to your destination:

1. With the pressure cooker lid in you lap slide in the output pipe down from the top.
2. Put the insulation on the top of the lid sliding it around the pipe if you are using it.
3. Insert the .25" pipe into the lid from top down.
4. Put the lid on the pot.
5. Install coat hanger support on faucet end of exchanger
6. Marry up the exchanger with the .5" pipe on the pot.
7. Tighten all hose clamps.
8. Hook up hoses to the supply bucket.
9. Put a container under the end of the exchanger to catch the distilled output.
10. Put water in the pressure cooker.
11. Fire up the heat.
12. Adjust the flow of water through the heat exchanger once producing output.

Offered by [Mike](#).





# Troubled Times



## Bucket Collection

A bucket feed through for water outlet can be made using a barbed hose fitting with pipe threads or a needle valve. See example at right and below. Metal washers are used on both sides of the bucket. A coupling or another pipe fitting is used on the other side to tighten the washers down on the bucket side wall. Silicon rubber type II is used to seal the connection. Amazingly enough standard washer sizes work fine. For example for .25" pipe thread one uses two .5" metal washers.



Offered by [Mike](#).



# Troubled Times



## Steam Cautions

---

Summary: Open air-cooled steam distillation introduces enough variables that practical day-to-day distillation is not likely. Heat exchangers that make hot water as a by-product look the most promising for primitive water distillation.

All of the above methods assume some sort of heat source that can produce steam. This assumption could be a problem for many areas due to the near constant rain and lack of firewood, coal, tar or other burnable resource. Some areas will be able to use hot earths crust to great advantage.

Warning: Hot Steam, hot water and hot metal will cause server burns as it transfers it heat to the skin of the body rapidly.

The amount of heat given off when steam changes back to water is 540 calorie/gram (called heat of vaporization). The amount of heat it takes to raise one gram of water one degree C is 1 calorie. Thus one can see a lot of heat is capable of being transferred to the skin for very little amount of steam.

Using these numbers it is easy to show that one can expect to produce hot waste water of about 7 (above 190 degree F) to 14 (above 140 degree F) times more volume of output water than the input water that was converted to steam in the first place. This assumes a room temperature of about 70 degree F as the starting temperature for the water.

Offered by [Mike](#).



# Troubled Times



## Umbrella Tent

---

Would it be possible, for those primitive sites that do get a fire going, to just put a clear plastic sheeting up over the cooking pot and catch the drip at the sides. Even an umbrella with cans tied to the tips might do. Boil the eggs, boil the potatoes, some of that moisture might end up in the cans. Umbrellas are designed to shed water, so the *underside* would do so too, and roll down into the tips holding the cloth taut, where tin cans could be wired to collect the drip. The handle is often metal, so would resist the fire when propped. If it were close to the pot it would be most efficient.

Offered by [Nancy](#).

Might work - depending on conditions. If raining on the top side of a plastic sheet or umbrella then could be tricky to keep the good water separated from the rain water. Hot fires produce hot dry air and this will tend to melt plastic or at least dry out the under side. However, if the plastic or umbrella is far enough away then the air will begin to cool before it gets to it. So under the right conditions it could work. Just as a tarp or plastic sheets made into a TP shape put over hot ground should cause water to condense on the inside and run down.

Offered by [Mike](#).



# Troubled Times



## Cotton Cloth

---

Another way to distill water - dimply put a pot of water to boil and cover it with clean cloths. The water vapor will condense along the fibers of the cloth. Simply wring the cloth out to get the water. Not efficient but very effective. You can test it for yourself by making up a salt water solution and then boiling it to collect the water. You'll find that the salt has been left behind. Note: the cloths do get very hot and can burn your fingers if you're not careful. Also the cloths must be as clean as you can get them as anything in the cloth that can be dissolved by warm water will be dissolved into your collected water.

Offered by [Ray](#).

Good idea. I am now wondering what cloths would work the best. Something that absorbs water like a sponge but adds little taste and doesn't melt and is not harmed by the 212 degree F temperature. Cotton is what I am thinking as a starter but there might be something much better. Do we have any one knowable in this direction on this list? Once this material is found one could mount the cloth on metal hoops made of coat hanger wire or similar. If the hoop was just a bit bigger than the pot then it would rest on top. Once saturated, one would take it off the pot and stand it up vertical to drip into another pot and to allow the surface to cool. During this time another hoop has been put onto the boiling pot. At regular intervals they get swapped out. May need three or more of them to be efficient. If the material is chosen carefully it should drain off when tipped. I can see with some thought one might be able to automate this process. A sort of paddle wheel result with the weight of the collected water moving the wheel from horizontal to vertical.

Offered by [Mike](#).

I suspect that the downside for the cloth method is that the large surface will also speed up evaporation. In a time when possibly water resources are limited we would want something more efficient at converting unsuitable water to good drinking water. I still do not see anything more efficient than a still of sorts; be that glass or copper. People would have to put the moonshine manufacture on hold for a while whilst they purify drinking water. Geez!

Offered by [Stephen](#).





# Troubled Times



## Stacked Pot

Using light weight aluminum pots this can be made to weigh only about 2 lbs 5 oz for all three parts. A heavier more durable unit can be made that weighs 4 lb 14 oz. The unit can be constructed with minimal labor out of commonly available cheap pots and pans for around \$20-\$30. When in operation depending on the heat source it produces about .9 oz/min or a glass of water every 10 Minutes (1.25 cups/10 min). These instructions are also on a [convenient Adobe file](#).

Designed for batch production, the water in the top and bottom pots will need to be changed approximately every 40 min. This time would depend on the amount of heat supplied to the bottom boiler pot. The water in the top cooling pot increases about 30 degrees F for each 10 minutes and after 40 min is up to about 180 degrees F. One should end off when steam starts to come out around the bottom of the top pot. This occurs around or above 180 degrees F. From start to finish the water level in the bottom or boiler pot should have changed about 1.75" depending on the size of the pot used. Don't let the bottom run dry. Use an output collection container that is marked to indicate when the boiler pot would be low on water.



At end of the cycle after about 40 minutes if one uses some of the hot water from the top to replace and refill the bottom water then one can get back into operation in minimal time. At this rate one could produce a gallon on the average of every 2.5 hours. This is taking into account the time for refilling with hot water and heating back up to boil.

Offered by [Mike](#).



# Troubled Times



## Two Pots

Notes on construction out of commonly available parts: In general make the bottom boiler pot about 3 times smaller in capacity than the top pot. This will insure the top heats up to max before the bottom runs out of water. This assumes one fills the bottom about 2/3 or more of it's height with water before starting. It is important that the bottom boiler pot have a lid that fits snugly (doesn't let steam out easily). The lid should be rounded such that it is higher in the center than the edges. The lid should not be made out of glass but be made of some metal that allows for ease of making a large hole in the center.



I found between 4 and 4.6 quarts to work well for the bottom pot. The diameter of the bottom pot is not too important as long as it is stable when in use (won't easily tip over). Typically it is 8" to 10" in diameter. If you use much bigger than that it tends to interfere with the output pipe coming out the side of the pie pan.

The diameter of the upper pot is constrained by the choice of the pie pan and turns out to be about 10" to 10.75". The top pot needs to end up stable and held into place so will not easily slide off. Height of each pot is not too important. I found between 12 and 16 quarts capacity to work well for this pot. I used it without a lid. Don't plan on anything much bigger than this it is too dangerous to move when emptying. It is heavy and the water will slosh if you move rapidly. **Warning: Scalding hot water accumulates in the top pot during use. Empty it with extreme care. I used leather gloves and moved extremely slow. This pot is heavy. If you have it -- wear water repellent heat protective clothing possibly an apron in case this accidentally spills in the process.** The choice of the pie pan is important in that one needs to solder to it and the extra extended lips on the Pie Pan helps to hold the upper pot in place. The sides being tapered help point the output pipe in the right direction See the photo at top. With added soldered on flanges I believe in a pinch any pie pan would work.

Light weight Construction: (for back packing use. Total weight is 2 lb 5 oz. see photos on [previous page](#)). Note: Being light and portable these pots above are very soft and will bend easily. One should take care to insure this does not happen. I then found some pots made out of SS and thicker aluminum. It end up being a little

more than twice the weight but is defiantly more durable.

1. Top pot: Aluminum Covered Saucepot diameter 10.75" by 7.5" high (12 Qt/11.4 L) from MIRRO Co. P.O. Box 1330. Manitowoc, WI, 54221-1330 (mfg. No. C-7962) Cost was \$7.99 (from Big Lots a local store). Weight without lid is 14.5 oz.
2. Bottom pot: Aluminum Covered Saucepot diameter 7.75" by 4.8" high (4 Qt/3.8 L) from MIRRO Co. P.O. Box 1330. Manitowoc, WI, 54221-1330 (mfg. No. C-7974) Cost was \$7.99 (from Big Lots a local store). If needed the side handles can be unscrewed and taken off for use with a camp fire. Weight without lid is 8 oz.

Heaver duty construction: (for stable location or back pack use. Weight about 4 lb 14 oz.). See photo at right.



1. Top pot: Retail Sales Link, Inc. Agora Hills Ca 91301 item number 104-16 QT. A Stainless Steel 16 Qt. Stockpot for \$5.99 (from Big Lots a local store). Weight without lid is 2 lbs. This is the best of what I tried, if you can find it.
2. Alternative Top Pot: Kirby & Allen 12 Qt (11.4L) Stainless steel steamer pot with steamer plate. Cost \$9.99 from Big Lots # 103902. 1332 Livingston, Avenue, North Brunswick, NJ 08902. Weight 1lb 14 oz.
3. Bottom pot: Bene Casa Coldero no. 7 model: BC-17280 4.6 Qt/ 4.5 Ltr Made from Sheeted Aluminum with Mirror Coated Finish. Cost \$11.99. This pot measure .1" thick aluminum. Weight is 1 lb for lid and 1lb 15 Oz for pot. This is the best so far, if you can find it.

Offered by [Mike](#).



# Troubled Times



## Pie Pan

The Pie Pan of choice used for constructing with both light weight or heavy weight pots. One Non-Stick Pie Pan 8.75" by 1.25" Style #92684 Lifetime Hoan Corporation Westbury, NY. The pan actually measures on the top outside diameter of 9.75" by 11.25" and the bottom is 7.25". Its weight is 9 oz. I chose steel so that one can sand off the non-stick layer and then solder to it. Cost was \$1.99 from Big Lots a local store.

In one rendition the lips around the edges were bent up to hold the top pot into the same position each time it was set on it. Another way was to solder a .25" copper tubing, making a circle, to the pie pan. This keeps the top pot from sliding off. See photo at top.

Turn this pan upside down and take a hammer and gently pound the bottom into a dome to match the curvature of the lid on the bottom pot. I used an old lid from a CD-ROM 100 dispenser to support it while gently pounding on the pie pan with a hammer. See photo below. Move the CD dispenser or large pipe support around to near the side as you work your way around from center to edge, then from center to edge. Small dents from each hammer stroke gradually make a budge that will eventually fit the curvature of the lid for the bottom pot.

The center section when fully constructed will weight between 12 oz and 1 lb 13 oz depending on the lid used for the lower pot. See photo at bottom.

Offered by [Mike](#).





# Troubled Times



## Small Parts

Notes on Small parts:

1. I used a Meat/Poultry Thermometer for measuring the temperature of the water in the top pot. It cost \$1.99 from Big lots. Weight is 1.5 oz. One can bend a paper clip to hold it on the side of the bucket. See photo #1.
2. The 5/16" distilled water output copper tube is about 4.5" long. Flare one end just a little bit and ream the ridge on the other end. Solder this in the side at a downward angle near the bottom of the pie pan. See photo #2.
3. Center support tube: Cut a .75" in diameter by .25" to .375" long end from a copper pipe. This pipe solders slightly sticking up though the bottom of the pie plate. It could also solder to the aluminum lid instead if you have an aluminum welding rods. One could also hold it in place with silicon rubber sealer. In a pinch this part is optional depending on the following test. Check the amount of cone up in the center by adding water and seeing if it runs out the side tube or whether more height is needed. In my case I did it just for insurance. See photo #3.
4. Use two 8-32 x .75" Machine round slotted head SS or brass bolts and nuts to hold the top lid of the bottom pot to the pie pan. Two holes are drilled near the center. See photo #4. A small washer is put between the lid and pie pan as a spacer to keep the fiber glass insulation from squashing completely flat. This step of bolting it together is optional and is not vital to it's operation, but at least one bolt is necessary for holding the splash guard in the next step. It also makes the center unit easier to handle so that it can be removed as a unit each time the water is changed. One can purchase these parts at Home Depot.
5. A 3.25" by 3.25" sheet metal plate with rounded corners is placed under the bottom lid to deflect the splatter of boiling water and keep it from going through the .75" hole in the lid. It is positioned to be at least a 1/4" from the top to allow the steam to pass around it and out the hole in the top of the lid. Can use a piece cut out of a tin can. See photo #5.
6. A small amount of thin fiber glass insulation was used to fill about .1" space between the lid of the bottom pot and the bottom of the pie pan. One can purchase this from Home Depot. This is used to minimize heat transfer from the bottom pot lid to the water that has condensed and is ready to run out of the Pie pan. This is an optional part that is not vital to operation.

Offered by [Mike](#).







# Troubled Times



## Simple Assembly

Assembly sequence:

1. Take knob off bottom pots lid.
2. Pound bottom of pie pan until it fits the lid of the pot being used for the boiler bottom pot.
3. Mark center of pie pan and drill a small hole, then larger and larger until it is 7/8". If .75" is as close as you can drill then use a file or rotary rasp to make it bigger until the copper pipe just fits. See use of step drill bit in in photo at right. Do the same for the pot lid. The step drill bit can be purchased from Harbor Freight tools.
4. Drill a side hole near the bottom of the pie plate for the 5/16" copper pipe. Sand off nonstick layer on the outside.
5. Cut about 4.5" to 4.75" length of 5/16" copper pipe and flare a bit of one end. Ream the inner ridge on the other end. Run the pipe through the hole and solder the pipe on the outside to the Pie pan.
6. Cut off a 3/8 inch length of .75" diameter copper pipe.
7. Solder the pipe to the pie pan or the top of the bottom pots lid.
8. Bend up holding tabs on the pie pan or solder .25" tubing circle to pie pan to hold top pot.
9. Mate the pie pan with the lid and drill holes for 8-32 SS bolts.
10. Cut a peace of fiber glass material to fit the size of the pie plate.
11. Put a bit of silicon sealer between the pie plate and the lid where the .75" pipe goes through, then assemble and tighten bolts.
12. Cut a 3.25" by 3.25" sheet metal peace can use an old caned food can lid. Drill a hole and put 2 or 3 washers under it and a nut on top.
13. Bend a paper clip and mount the meat thermometer on the side of the top pot.



Offered by [Mike](#).



# Troubled Times



## Sustainable Village

The idea for building this originally came from the Sustainable Village website, as described below for the E-Still. The E-Still is made from SS and the idea of using a pot of water to do the cooling of steam is a good and practical approach. Unfortunately the E-Still described below is no longer available. I recommend you build your own using [these instructions](#) from commonly available pots and pans. If you still wish to purchase a similar product, check out the "Non Electric Water Distiller" from [Distiller Warehouse](#) in Canada.

Offered by [Mike](#).

### E-Still (Non Electric Water Distiller)

*Great for camping, remote living, emergency preparedness, easing y2k concerns - a stainless steel distiller with no moving parts! Use with any type of stove - gas, electric, wood, a propane burner or camping cook stove, in a home fireplace or outdoor camp fire, on a charcoal grill. All it needs is a source of heat to boil water, steam condenses into 99.9% pure distilled water. You get 24 ounces in just 34 minutes, one gallon in 40-45 minutes. Includes a Boiling Pan, Patent-Pending Disks, an Upper Condensing Pan, Stainless Steel Discharge Extension Tube, and a length of High Temperature Medical-Grade Silicon Tubing to provide further distance of the Receiving Vessel from the heat source. The Pure Survival e-Still is a Manual-Fill, Batch-Type Distiller. With a Propane Camp Stove used as the Heat Source, the e-Still produces 24 ounces of Pure Sterile Distilled Water in 34 minutes as follows: 12 minutes to reach the Boiling Point and Produce Steam, 12 minutes to produce the First 12 Ounces of Distilled Water, 10 minutes to produce the Second 12 Ounces of Distilled Water, One 16.5 Oz Propane Bottle lasts for 8 batches ? producing 192 Oz [1.5 gallons] of Pure Sterile Distilled Water. The Production Batch Time varies with the Heat Source ? but, in general, the Pure Survival e-Still will produce 1 gallon of Pure Sterile Distilled Water in 40-45 minutes. With a Pure Survival e-Still in the house, you will never have to worry again about storing bottled water for an emergency. Create your own Pure Sterile Distilled Emergency Drinking Water when you need it the most ? in an emergency!*



# Troubled Times



## Water Quality

How does one make rough measurements of water quality or purity in a primitive environment? We talked about making a number of different types of water distillers. But then how does one measure how good the result is? Taste it is one simple test, but how about coming up with a more objective approach. The challenge then is to put together a meter from commonly available parts that will do a reasonably well job of measuring in relative terms water purity with distilled being the top of the scale.

The first thought is to measure water resistance with a digital volt-ohm meter. One would take and connect the Volt-Ohm meter directly across two electrodes of the same type of metal. Put this in solution and read the resistances from the meter.

After doing some careful testing with several types of electrodes I came to the following conclusion. This is not the way to go. It is way too many variables and the reading are all over the place. You take a measurement on one scale and it is totally different on another scale of the same meter. Distilled water measures close to the same resistance as tap water with sometime only twice the reading some times 8 times the reading. Next time you come back for a reading it is total different. The longer it is connected the more it drifts to higher resistance. To make matters worse if one then interchanges the clip leads and tests again one finds a negative resistance that goes to zero and starts climbing. This means the electrodes are acting like a battery and being charged up. Both electrodes were made from the same type metal.



The main problem is the voltage that the meter supplies is variable and very low when compared to electronegative of the metals used. So with lessons learned I found that if one uses a 4-cell AA battery pack producing between 5 and 6 volts and a current meter in series with the electrodes that workable measurements can be done. Actually I think anything over about 3-4 volts to 12 volts DC would also work. The battery and the current meter (digital Volt-Ohm meter used on the current scale) and the electrodes are all wired in series.

As you can see in the picture I finally found a good use for Stainless Steel butter knives. One puts a strip of molding 3/8" thick wood molding between two SS butter knives and then wraps electrical tape around the handle. The bare wires are taped to the outside of the handles making contact by pressure from the tape. The full length of the handle is taped so that the conductivity of the hand holding the electrodes does not interfere with the readings. The upper half of the knife blades are taped so that when one puts it into solution up to the back tape the same amount of surface area will be exposed to the water. Surface area is proportional to current flow. The more the surface area, the more the current flow.

Typical measurements give a current of about 15 to 20 ma for tap water where I live with store bought distilled water at less than .1 ma. The measurements made from this approach are relative to your local input water, with the lower the ma the better the water. By use of this meter one can tune up ones filtering or distillation processes to minimize current flow and maximize water purity. This approach measure the conductive ions and may be misleading when used with some types of filtering but in general the lower the current the better the water.

The digital meter was purchased from [Harbor Freight](#) tools for less than \$10. See ITEM 90899-2VGA for \$4.99 and ITEM 30756-3VGA for \$9.99. The battery case was purchased from radio shack. The stainless steel butter knives have been setting in my kitchen drawer awaiting a good use.

Offered by [Mike](#).



# Troubled Times



## Myths

---

### Blowing The Lid Off Distilled Water [Myths](#)

by Joe Letorney, Jr.

Controversy always seems to shroud distilled water through the years. The same old myths and fallacies that were once heard ten to fifteen years ago still continue today. All the misconceptions about distillation and distilled water are grossly misrepresented. All the myths listed below have no basis in fact. The purpose of this article is to set the record straight and lay these false perceptions to rest. Helping clear up these misconceptions about distilled water will greatly benefit both the dealer and the general public.



# Troubled Times



## Vacuum Assist

---

Speaking of this I had an idea. You know those hand pumps people use to pump air out of wine bottles and those freezer bags? Could I hook one of these up to a container of water and pump out all the air, making a vacuum and then cause the water to evaporate at room temp? What I'm thinking is, once I pumped out the air, water vapor would fill the space left by the exiting air. Then as I continued to pump I would pump the water vapor out, and into the condenser. Eventually if I keep pumping, all the water will have been distilled. Questions:

1. Will this work?
2. Will I still have to worry about viruses and bacteria? Will they evaporate with the water or be left behind?

Offered by [Ryan](#).

1. Yes, theoretically it should work.
2. No, they will be left behind (unless the bottle is shaken and water gets into the pump)

What you should be concerned with is:

1. The amount of labor involved/gal. I recommend you try it out and report your results.
2. Recommend supplying heat to the water being evaporated. The water left in the container being evaporated will get cold and be harder and harder to pump-evaporate. One could put a larger container of water around the original container to supply the heat needed to keep bringing it up to room temperature.
3. The contaminants of the pump (oil, rubber, etc.) can get into the distilled water.
4. The life time or durability of these pumps is in question. These things were designed to be operated for short time periods and not much at all over their life time. I expect they would wear out quickly. Just a thought though, one would need to check this out.

Offered by [Mike](#).

Those hand pumps are pretty basic. The seal is nothing more than a piece of rubber or leather cut just a little bigger than the tube they are in. Easily replaced with a piece of tanned deer hide and lubed with vegetable oil.

Offered by [Clipper](#).



# Troubled Times



## Heat Sources

---

The Epicenter has some nice water storage and purification products. Especially noteworthy is the [E-Still](#) that will distill water using a variety of heat sources.

Offered by [Stan](#).



# Troubled Times



## Solar Distiller

---

*Solar Stills operate on the same principles that produce rainfall. The sun is allowed into and trapped in the Still. The high temperatures produced destroy all pathogens. The water evaporates, and in this process, only pure water vapor rises in the Still, only to condense on the glass. The glass is sloped to the south, and the condensed water runs down the glass and is collected in a trough. The water is allowed out of the collector through silicone tubing, and is collected in 5 gallon glass jugs. There are no moving parts in the solar still, and only the sun's energy is required for operation.*





# Troubled Times



## Boiling Point

---

I was thinking tonight about how to get absolutely pure water. The best place to start is to distill water. Boil it, then condense it. Leave the chunks and higher temp boiling liquids behind for distilled water. Someone pointed out before that you can't be sure that distilled water is absolutely pure. Some liquid may boil at a lower point than the water and get distilled right along with the water. Then condense right back in with the water. This can be avoided by boiling the distilled water. If the original water had any liquid in it that boiled hotter than water it would not boil until the water was all gone. If the original had liquid in it that boiled lower than water it would end up in the container with the distilled water. All we have left in the second container is water and liquids that boil at a point lower than water. If we bring the water to a boil we must have removed all of the liquid that would boil at a lower temperature than water because boiling is a constant temperature process. If we have 100C achieved to boil the water then no liquid could be remaining in the water that boiled at lower than 100C. Pure water.

Offered by [John](#).

Which liquids might be contaminating drinking water after the pole shift *that boil at a lower temperature than water*, and so might still remain in distilled water? I wonder if there are common liquids with low boiling points so that we need to worry about this. If this is true, then we have to be aware of this fact. If the liquids are rare contaminants, then it's less of a concern.

Offered by [Craig](#).

The only liquid I can think of, because I distill it to separate it from water, is alcohol with a boiling point of 180F (if I remember correctly). The easy way to separate lower boiling point liquids from water is to heat the water to just below the boiling point, say, 98C and let it sit at this temp for 10 or 20 minutes open to the air (not connected to the condenser). After 20 minutes or so it should be all gone and the condenser can be connected and the temp raised to 100C. Remember that the boiling point of water (and everything else) decreases with barometric pressure. There are actually a number of liquids that have a lower boiling point than water but I would need a chemistry book to look them up.

Offered by [Ron](#).



# Troubled Times



## Hydrocarbons

---

After the pole shift I think we can all expect more hydrocarbons in the water, these being in the tail of the 12th Planet as it passes over earth. Also, some volcanic activity would be expected to spew out hydrocarbon vapor to mix with rain water. I believe most of this to have a vapor pressure below water boiling temperature 100C. If one is using the batch distillation method: One could simply bring a new batch of water on line, purge the system by boiling and condensing some. Throw away the first few ounces that come out. This will contain the hydrocarbons and lighter boiling temperature liquids.

On second thought save this in a separate container and once you get enough of this, process it again. You may find that after processing for a while, you can separate out the hydrocarbons as burnable fuel. At some point the hydrocarbons will begin to separate out and float to the surface where one can skim them off. This second part in some cases may take more energy than it's worth. So judge the worth of it. Now in like manner don't plan on boiling your water dry. Stop with some liquid left which could contain higher temperature hydrocarbons. This again could be thrown away or saved. This may have the higher temperature oils, paraffin's and tars in it.

If one is using the continuous distillation method: Provide for a way that water that is fed into the process is preheated to boiling before it enters the capturing process. This would allow the lower temperature hydrocarbons to escape and not be condensed. One may need to modify the design of a commercial unit to accomplish this. What you want is a leak to the air, during the first part of the process. It might be a good idea to design the length of the condensing tube so that not all of the gasses condense by the time the condensing tube ends. This would then allow the lower temperature gases (most likely to be hydrocarbons) to be expelled harmlessly to the atmosphere on a continuous basis.

Offered by [Mike](#).



# Troubled Times



## Distillers

### Reeves Glass RG4330 Distilling Apparatus

A general purpose batch distillation assembly. Ideally suited for the production of high purity distilled water. The flask has a flat bottom with a side delivery tube, terminating in an S joint.

Capacity	Condenser	Stopper	S Joint
500ml	200mm	#22	19/38
1000ml	200mm	#27	19/38
2000ml	300mm	#32	24/40
Stopper/Flask only	500ml	#22 stopper	
Stopper/Flask only	1000ml	#27 stopper	
Stopper/Flask only	2000ml	#32 stopper	

### SunWater Solar Distillers

Portable, affordable, no power required. Use for battery water in remote places without stores. Pure, delicious drinking water—normally more pure than any bottled water. Eliminates salts, minerals, bacteria and radioactive minerals. Greatly reduces chlorine, pesticides, THM's and chemical fertilizers but in rare cases of extreme contamination may also require carbon filtration. Great for replacing battery water for alternative energy systems in remote areas.

1-person	2 liters/day	(WC360)	\$432
2-person	5 liters/day	(WC361)	\$570
3/4-person	8 liters/day	(WC362)	\$790

### Solar Pasteurizers

Portable, affordable, no power required. Use the free energy of the sun to disinfect water. Kill harmful microbes by raising the water temperature to 170 degrees Fahrenheit. Most of the danger in remote water sources comes from water borne diseases. Great for water that is basically free from salts and industrial pollutants. Distillation produces chemically pure water in limited quantity; pasteurization can disinfect a larger amount of contaminated water per day using less energy.

In just 2-3 hours of direct sunlight the Family Sol\*Saver produces 3.5 gallons (13 liters) of purified water and on an average sunny day, the Sol Saver produces 200 gallons (757 liters). A \$400 add on to the Sol Saver lets you burn wood on days without sun and produce up to 30 gallons per hour. The Wood Saver only uses wood (it doesn't have a solar collector) and makes 30 gallons per hour).

### [Waterwise](#)

I own a commercial distiller and distill all of my cooking and drinking water. I researched the market for about 2 months, reading all the literature and talking to various people in the industry. I chose a distiller from Waterwise. I use the model 7000 which costs over \$1000. They do have countertop models for a few

hundred dollars. They are just as good, they just produce smaller quantities of water.

Offered by [Michael](#).



# Troubled Times



## Separators

---

I recently bought a WaterWise 9000 water distiller after much research into low-end water distilling. It does use power though, but the water in Louisville, Ky recently has gotten real bad supposedly from algae blooms in the Ohio river from the drought here. One of the features talks about the elimination of low boiling light gases that are [Discharged](#) through the gaseous vent. Apparently, condensation of the "dry" steam from the "wet" steam to separate the low boiling light gases occurs.

There are distillers that don't require power, but my immediate need was for something of good quality that was quick, simple, and easy to use, as well as being able to fit on the kitchen counter. This one fit the bill, though it was a bit pricey you can find them for just under \$400.

Offered by [Steve](#).



# Troubled Times



## Ancients

---

**Ceramic Sculpture** made by Clayton Bailey, 1960-1998

### **Distillation Apparatus**

*I was looking at 15th Century technology, and it led me to this. The jugs and alchemical ideas began with Leonardo and the ceramics and technology of his time.*

Clayton Bailey - 1987

These ceramic stills actually work by solar energy; producing distilled water daily as they stand in the California sunshine. They look like they could be used to manufacture the collection of rare and unusual chemicals and products that Bailey presents in his large tobacco spit glazed stoneware jugs and bottles.



# Troubled Times



## Distill Seawater

---

Excerpts of an article on misc.survivalism titled *Can you turn seawater into drinking water?*, dated 8 Aug 1996, by John L. Freiler (tempcrow@io.com).

The term is distilled and yes, it is possible. The simplest systems feature a closed area with sea water in it. The top is made from clear plastic. The sunshines in and causes fresh water to evaporate off the saltwater. Since the air inside the still is now warmer than the surrounding air, the fresh-water vapor will condense on the sides of the apparatus. These parts of the apparatus are designed to let the condensate run down into a separate holding area for collection and consumption.

This sounds complicated, but can be fashioned simply: Suppose you find yourself washed up on an island without a fresh water supply. simply dig a hole in the beach until you reach wet sand (but not actually water, that will cause your hole to collapse). Put a bowl in the center of the pit. Cover with clear plastic (of course, you have to be able to find some...) Seal the edges with more sand and place a small weight in the middle of the plastic right over the bowl. You'll get fresh water as long as there's daylight. Keep the system set up overnight though: It's also a great rain catcher.

You can get much more sophisticated than this; Reverse osmosis systems and active distilling. Both have their advantages and drawbacks; the primary one being cost and maintenance.



# Troubled Times



## Brackish Water

How does one set up an emergency water purification system that uses minimum power to work with brackish water after a PS? What does one need to know? What strategy does one use to pull together the components in a short period of time? How can it all be made cost effective so the common man can afford it? How much preparation is needed? These and more questions will be attempted to be addressed in the detailed [PDF File](#). Distillation is an excellent method of producing good water and is highly recommended. It is very expensive in terms of the amount of energy used. Distillation was well covered earlier. Separation by freezing will not be covered in this report. Portable hand operated methods to the extent they are usefully have been previously covered. What will be covered now are ways of filtering and purifying water using about 200 to 400 times less energy than distillation for use at a base site. Many may not have the energy available for doing distillation. So alternatives become appropriate. A good energy efficient brackish water purification system will have the following minimum components.

- Container(s) to collect and hold rain or run off water (plastic garbage cans, hole in ground lined with plastic, 55 gallon tanks, etc)
- Strong magnet to attract iron and other ferromagnetic metals and pull them out of solution.
- Ozone bubbled through the water to kill pathogens and reduce heavy metals.
- Settling tank to separate oil and dirt. Oil floats to top and runs out an over flow. Dirt and heavy particles settle on the bottom of the tank. Good water is drawn out from in-between.
- Gradient particle filters down to about .5 micron. Gradient mesh cloths could be stuffed into a 4" pipe as one example. A sand filter or a commercial filter element could be used.
- Method of moving water (gravity, electric pump or hand pump)
- Way to precipitate small or dissolved unwanted heavy metals. (water softeners, ion exchange, Ozone, and Magnets)
- Way to bring the pH back in range if very different from neutral especially if acid. (if acid add ashes, or use Ozone)
- Way to remove very-very small particles out of the water. (ceramic filters, reverse osmosis, DI demineralization resins filters, and distillation)
- Way to remove hydro carbons (oil etc) and bad smells. A Carbon filter elements, or could be as simple as a plastic garbage can full of crushed charcoal that the water is run slowly though. Ozone bubbled through water will also remove smells.
- Sterilization or killing of parasitic organisms like bacteria, viruses, etc (passed by UV-light source, or add an item like chlorine, iodine, colloidal silver, Grape fruit seed extract or bubbling ozone gas through the water).
- Container to collect the output, so the process can be done slowly or at its own best most efficient rate yet water can be easily obtained from it.

### Functional Flow of Needed Water Purification Items

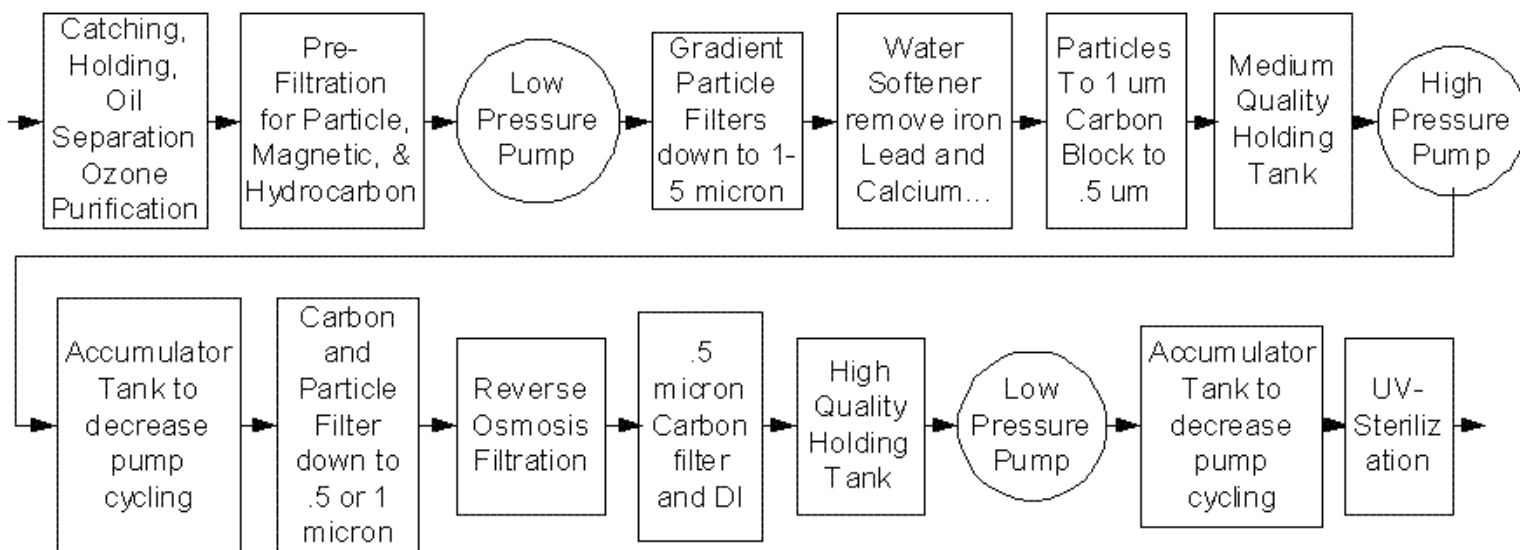

A block diagram of the major functional components would look like:



Offered by [Mike](#).



# Brackish Water Purification Systems

(7/4/2007)

How does one set up an emergency water purification system that uses minimum power to work with brackish water after a PS? What does one need to know? What strategy does one use to pull together the components in a short period of time? How can it all be made cost effective so the common man can afford it? How much preparation is needed? These and more questions will be attempted to be addressed in the following write-up.

Distillation is an excellent method of producing good water and is highly recommended. It is very expensive in terms of the amount of energy used. Distillation was well covered earlier. Separation by freezing will not be covered in this report. Portable hand operated methods to the extent they are usefully have been previously covered. What will be covered now are ways of filtering and purifying water using about 200 to 400 times less energy than distillation for use at a base site.

Many may not have the energy available for doing distillation. So alternatives become appropriate. A good energy efficient brackish water purification system will have the following minimum components.

- Container(s) to collect and hold rain or run off water (plastic garbage cans, hole in ground lined with plastic, 55 gallon tanks, etc)
- Strong magnet to attract iron and other ferromagnetic metals and pull them out of solution.
- Ozone bubbled through the water to kill pathogens and reduce heavy metals.
- Settling tank to separate oil and dirt. Oil floats to top and runs out an over flow. Dirt and heavy particles settle on the bottom of the tank. Good water is drawn out from in-between.
- Gradient particle filters down to about .5 micron. Gradient mesh cloths could be stuffed into a 4" pipe as one example. A sand filter or a commercial filter element could be used.
- Method of moving water (gravity, electric pump or hand pump)
- Way to precipitate small or dissolved unwanted heavy metals. (water softeners, ion exchange, Ozone, and Magnets)
- Way to bring the pH back in range if very different from neutral especially if acid. (if acid add ashes, or use Ozone)
- Way to remove very-very small particles out of the water. (ceramic filters, reverse osmosis, DI demineralization resins filters, and distillation)
- Way to remove hydro carbons (oil etc) and bad smells. A Carbon filter elements, or could be as simple as a plastic garbage can full of crushed charcoal that the water is run slowly through. Ozone bubbled through water will also remove smells.
- Sterilization or killing of parasitic organisms like bacteria, viruses, etc (passed by UV-light source, or add an item like chlorine, iodine, colloidal silver, Grape fruit seed extract or bubbling ozone gas through the water).
- Container to collect the output, so the process can be done slowly or at its own best most efficient rate yet water can be easily obtained from it.

# Brackish Water Purification Systems

(7/4/2007)

A block diagram of the major functional components would look like:

Functional Flow of Needed Water Purification Items

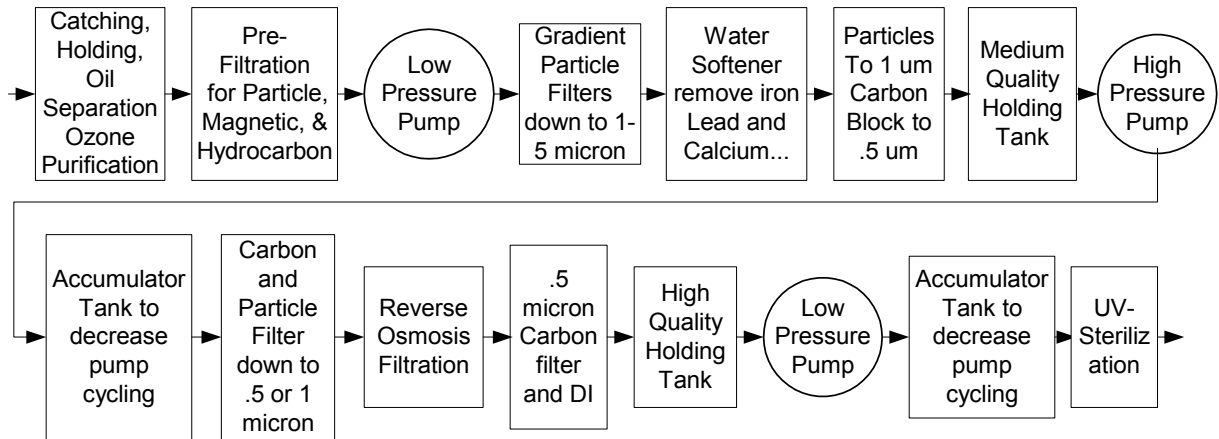

In more detail it might look like the following:

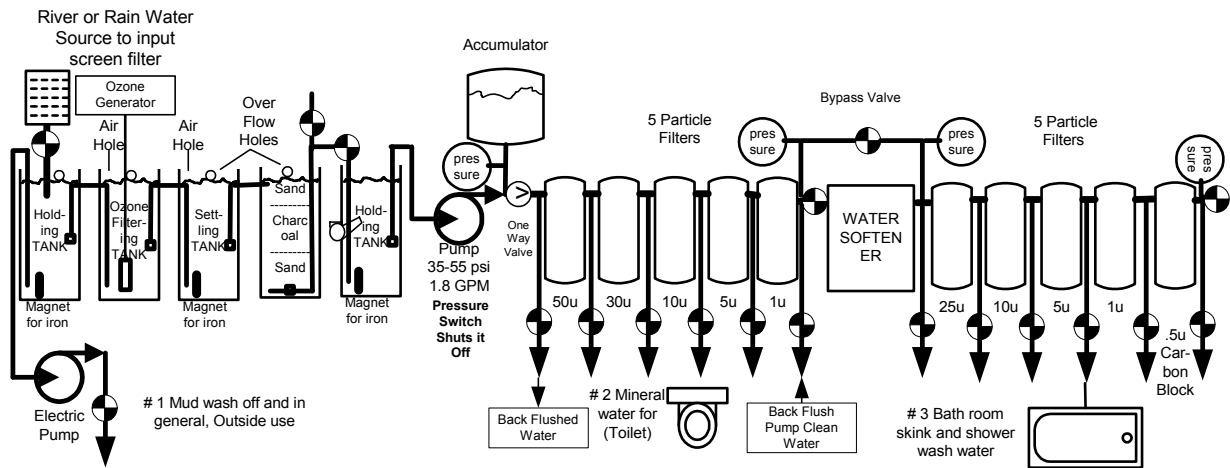

Water flows in from an up hill source and is controlled by a ball valve. The planned near continuous over flowing of the settling tank allows for the removal of floating oil and debris. Magnets are used to help remove Iron. Ozone is bubbled as needed to kill pathogens and remove heavy metals. An alternative to this would be to run the water through a UV-light filter to kill pathogens between tank one and two.

Sand and ground charcoal is used to remove small partials and hydrocarbons (oils). Commercial 10" filter elements are used to remove small partials and more hydrocarbons and some lead. The water softener removes more Iron, and hardness (calcium). This is to make the RO process more efficient. Three types or qualities of water can be taped off as needed.

The pressure gauges are used to tell when the filters need to be back washed. The many valves or water faucet tap off points allow for bypassing (skipping filters or components not needed)

# Brackish Water Purification Systems

(7/4/2007)

and allow for backwashing of each filter element independently without removing it from the cartridge. It also allows for many different qualities of water to be used as needed.

For the holding tanks use 55 gallon containers, trash cans, or 5 gallon buckets depending on scale of operation. Grind or pound up raw wood barbeque charcoal to small chunks. Don't get brickets (they have a non-charcoal binder) or any charcoal that is presoaked with hydrocarbons to make it easy to light. Put a separating cloth between the sand and ground charcoal. Put some sand under and then on top to hold the carbon down from floating. This is set up so it can be backwashed as needed.

## Electrical diagram for the first pump is:

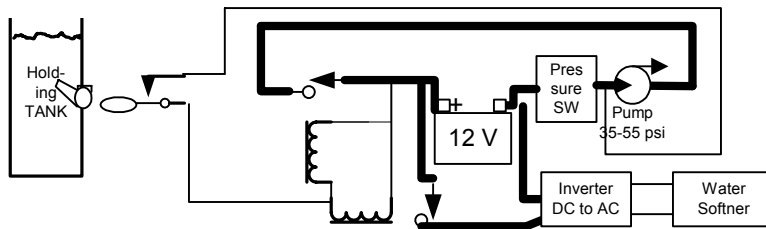

The Ozone generator is hooked up to a separate inverter and is turned on by hand. As power permits it is run nearly consciously. The 12 Volt Relay is normal open with no power applied and typically is a DPDT (double pole/double throw). The tank float switches were boat bilge pump switches (15 amp max). The pressure switch comes with the pump.

## Plumbing diagram for the Reverse Osmosis (RO) or second half is:

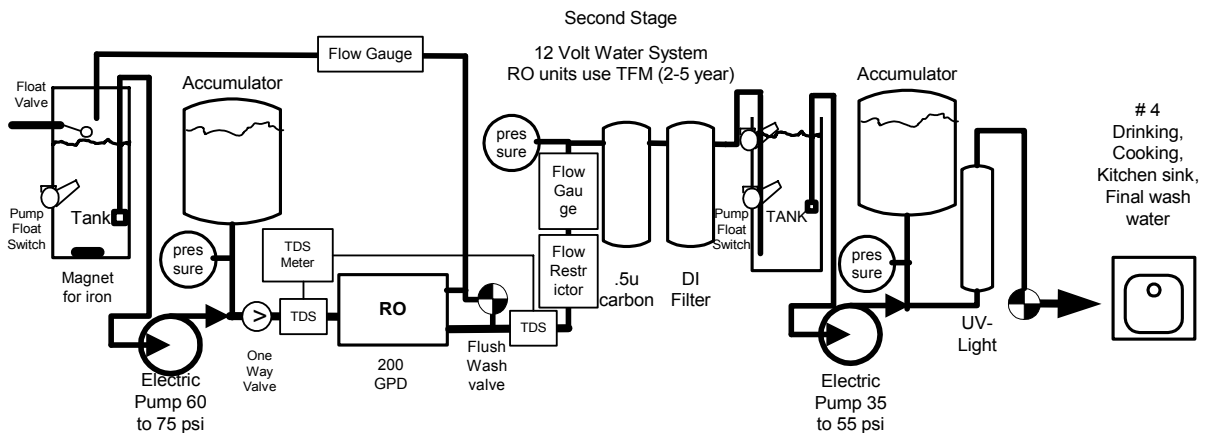

Multiple RO membranes can be put in parallel to get the desired GPD. The "flush wash" valve is used to flush buildup on the membrane to waste. It is used as often as needed to keep the membrane from clogging up. The flow restrictor size is matched to the GPD rating for the membrane (see below for more explanation). A flow restrictor and flow volume measurement gauges help keep the ratio of good water to waste water at about 22% or 1:3.5. The total dissolved solids (TDS) meter helps keep track of the efficiency of the process.

# Brackish Water Purification Systems

(7/4/2007)

The carbon filter removes any hydrocarbons that have made it to this point. The DI or demineralization resin bead filter takes out any remaining dissolved minerals and takes the PPM to zero. The result is stored in a tank and pumped on demand for drinking and food preparation. The UV-Light does a final sterilization of pathogens.

The good news is that off the shelf house hold RO units have gone down in price and up in GPD over the last number of years. In many cases one can get a replacement membrane that brings the old 10-15 GPD unit up to 75 or 100 GPD rate. The price of the membrane is about \$30-\$40. Household RO systems that produce 100 to 200 GPD now cost about the same as the 10-15 GPD units of 5 years ago. Searching on eBay is a good way to find these. Start with a good basic RO unit and add up front more items as described in this report. If one wants to venture into new territory's there is even a 700 GPD tankless Merlin Reverse Osmosis Water Filter that sells for about \$375.

## Electrical for the RO Pump:

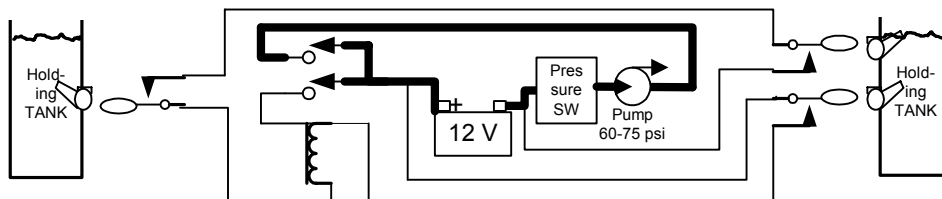

The 12 Volt Relay is normal open with no power applied and typically is a SPST (single pole/single throw). Once turned off the water has to go down to the lower tank float switch (tank on the right) to turn on the unit. Then it won't turn off until the tank is full or the source tank (one on left) is down to its switch.

## Pump wiring for the last or delivery pump:

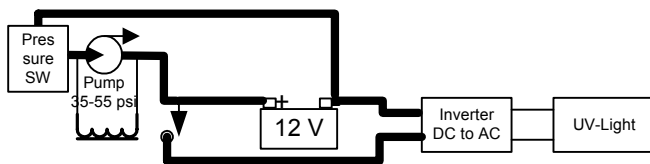

The pressure is adjusted on all of the pumps to be as big a range as possible to minimize on/off cycling. The Accumulator tanks are as big as possible considering cost. Bladder tanks are preferred however one can use the typical 2-5 gallon water pressure tanks supplied with some RO units. I suggest one use several in parallel to compensate for the slow flow through the small inlet tank fittings.

For water delivery and all but to drive RO we ended up choosing Shurflo 12 volt Industrial pump part number 8000-443-236 about \$60/each. Flow rate of 1.25 GPM at 60 psi and 7.2 amps or 1.4 GPM at 35 psi and 5.2 amps. [http://www.shurflo.com/pages/gen/site\\_map.htm](http://www.shurflo.com/pages/gen/site_map.htm)

For water delivery to the membrane one can use Aquatec 5800 (at .25 to 1.5 GPM, 25W to 100W, Up to 130 psi) or equivalent depending on intended GPD flow rate.

# Brackish Water Purification Systems

(7/4/2007)

For various RO piece parts or components check out:

<http://airwaterice.com/>

<http://www.waterfiltersonline.com/parts-department.asp>

<http://stores.ebay.com/H20-Science>

For a source of cost effective filter elements to include .5 um Carbon Block at about \$6.00/each in quality including the price of shipping and sediment filters for about \$1.20/each down to 1 um see: <http://stores.ebay.com/H2O-SPLASH>

BILGE PUMP FLOAT SWITCH see

<http://stores.ebay.com/Stuff4boats>

## Water Softener

The water softener can be as simple as a holding tank where the water flows through the resin beads (like for charcoal filter only smaller). One can buy the resin on-line eBay for about \$100/1cuft or 50 lbs. One could take the container off-line and back flush with salt once in a while to regenerate it. One would fill the container with a high concentration of salt and let it sit for about 30-40 min while stirring it up occasionally. Then one would wash the salt off the resin beads and put the filter back on-line. From time to time testing the TDS of the input and output would determine how often regeneration would be needed. When the TDS starts to go up on the output one would know it's time to regenerate.

A small version of a rebuildable cartridge that fits within a 10" cartridge filter can be purchased. It is a plastic container that one can replace the beads in and put it back in the filter cartridge. See <http://stores.ebay.com/H20-Science> for where to get this rebuildable removable cartridge. They are made primary for DI and Carbon replacement particles. However there is no reason why one couldn't use water softener resin beads. These beads can last up to 10 years of regeneration as long as you have salt available. Non-reusable cartridges can be purchased at <http://www.filterwater.com/showproduct.aspx?productid=101&affiliateid=10050>

Water Hardness: Calcium and magnesium are two minerals which make water "hard." Both of these minerals are classed as "contaminants," but that's a poor choice in terminology, for calcium is essential in our diet! A softener merely exchanges one group of non-toxic elements for another group of non-toxic elements. Water hardness is measured either in grains per gallon (GPG) or as calcium hardness in milligrams per liter (mg/l) or parts per million (ppm). GPG is based on calcium hardness. To convert from calcium hardness ppm, just divide by a factor of 17.2 and this gives you hardness in GPG. A soft or slightly hard water has up to 3.5 GPG; moderately hard water runs from 3.5 to 10.5 GPG; and very hard water is greater than 10.5 GPG. Metro water is on the low side of moderately hard at 4.1 GPG (that is 70 mg/l of calcium hardness. Purchase a TDS hand held meter to measure your Hardness.

Water softeners resin beads use about 1 lb of salt to regenerate for about 3,800 gal of good water produced. This is depending on hardness of the water. Non-electric water softeners do not have the problem electric ones have. When the electricity goes off, the electric softeners loose track

## Brackish Water Purification Systems

(7/4/2007)

of the amount of water volume that has flowed since the last regeneration cycle. When the electricity comes back on they do an automatic regeneration cycle. The bottom line is to make your own or purchase a non-electric type of water softener.

### Sea Water RO

A RO unit that works for making fresh water out of salt water operates at a much higher pressure (600 to 1000 psi) and might look like the following. These are usually rather pricy.

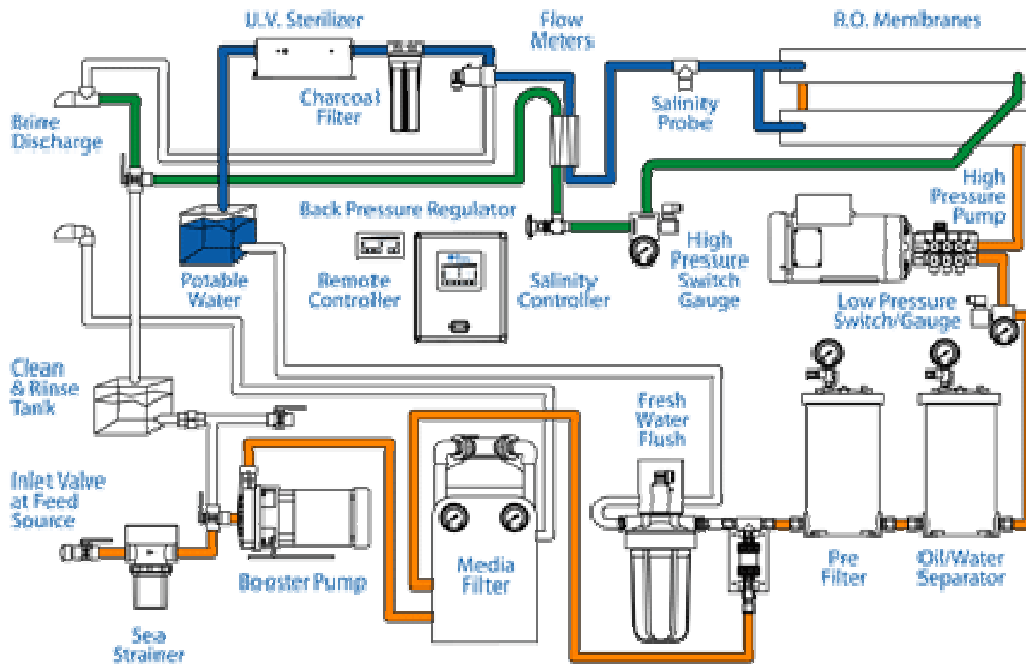

For the type of salt water systems available and how they work see:

<http://www.cruisingworld.com/article.jsp?ID=44957&typeID=397&catID=572>

Ventura 150 is a very efficient fresh water maker and produces 150 gal/day at 17 watt-hr/gal running off 12 Volt DC. Also check out the Aquifer 150. It is a portable rugged water maker engineered for the mobile conditions in remote areas where good water is essential. The Aquifer 150 system makes 150 gallons of purified fresh drinking water every day in almost any climate. Both of these have a much lower cost than most marine RO units.

<http://www.spectrawatermakers.com/>

### Ozone Water Treatment

This is done by bubbling Ozone Gas made from air passing over a strong UV light source through water. This is not to be confused with passing water over a UV light source to kill water born pathogens. Both have their place in water purification. Ozone Gas bubbled through water will kill pathogens and also it will take out heavy metals and bad smells.

# Brackish Water Purification Systems

(7/4/2007)

Municipal water companies have used ozone technology to treat large quantities of water for many years because of its effectiveness in purifying and conditioning water. California state law now requires ozonation as the final step before bottled drinking water is packaged. The International Bottled Water Association also requires ozonation prior to bottling.

The Benefits of bubbling Ozone through water are:

- Kill bacteria on contact thousands of times faster than chlorine or bromine.
- Kill virus on contact.
- Kill algae spores, fungus, mold and yeast spores.
- Precipitate heavy metals.
- Remove excess iron, manganese, and sulfur by a process known as micro-flocculation, thus conditioning the water naturally without chemical additives.
- Remove color and odor, leaving a fresh, healthy bouquet.
- Reduce scale build-up on equipment such as pipes

The level of contaminants that can be removed by use of Ozone in a single tank is typically: Iron to ~10ppm, Manganese to ~1ppm, Hydrogen Sulfide up to ~25ppm. Twin tanks in service have successfully removed Iron to ~55ppm, Manganese to ~16ppm, H<sub>2</sub>S to over ~100ppm. It will also raise the PH of your water if it is in the acidic range (below a PH of 7.0) and stabilize the PH in the 7.5 range.

Ozone is made up of 3 atoms of oxygen and is unstable soon to become O<sub>2</sub>. This makes it one of nature's very powerful disinfecting and deodorizing agents. The Half life of Ozone in air is on the order of hours and the order of minutes when dissolved in water. Ozone Dissolves over 12 times more readily into water than pure oxygen. The result of this decay is much higher than normal concentrations of pure Oxygen dissolved in water.

Use a holding tank size such that as a rule, the maximum usage per day will never exceed 25% of the tank capacity. Ozone gas is heavier than air and will accumulate around the holding tank. Do not breathe the accumulated Ozone gas for an extended period of time.

Ozone will not remove nitrates (typical when water is contaminated by fertilizer run off), sodium, sulfates, total dissolved solids, chlorides, and fluoride. These contaminants can be removed by reverse osmosis or distillation. Pre-treating the water with the Ozone will dramatically reduce the maintenance required on the reverse osmosis.

A typical unit that performs this function can be found at <http://www.tripleo.com/default.htm>. Once one understands how it works. It can be made simply by passing air over a UV-light germicidal lamp light source. A small fish tank pulse pump can be used to supply the air.

## Things to be aware of

Maximum PSI for Filmtec RO Membrane 50, 75, or 100 GPD is about 90 PSI. Optimal PSI is 65 to 72 PSI and a temperature of 70 degrees. Ozone and chlorine will harm and degrade the RO Membrane.



# Brackish Water Purification Systems

(7/4/2007)

DI stands for Demineralization by Ion Exchange. It is a mixed bed of beads of Anion and Cation resins. Ions, salts or minerals can be entirely removed from water to near 0 PPM. Typical capacity of a Vertical 10" filter cartridge is 6,800 ppm. If TDS (total dissolved solids) out of the membrane measure 20 ppm then  $6,800 \div 20 \text{ ppm} = 340$  gallons before it runs out of capacity to take minerals out of water. A DI can be used stand alone without a RO unit in front of it; however, it will not last very long depending on the TDS PPM. As far as I know this resin can not be recharged like water softener beads. However water softener beads can be used in the same rebuildable cartridge to make a rechargeable reusable water softener filter.

## Choosing Tubing Size

How to determine the size tubing to use based on expected flow rate: As an example say one is building a 200 GPD RO unit. Can .25 inch OD (outside dimensions) tubing be used? We can see from the chart below that for every 10 ft of tubing used the pressure will drop by 12 PSI. So the answer is yes we can as long as one keeps the over all length of this size tubing short. We can also compensate for tubing pressure drop by boosting the pump pressure by 1.2 psi/ft of length used. Any flow greater than this and one should use the next size bigger tubing or 3/8" OD.

### Amount of Lost Pressure Due to Plastic Tubing Friction

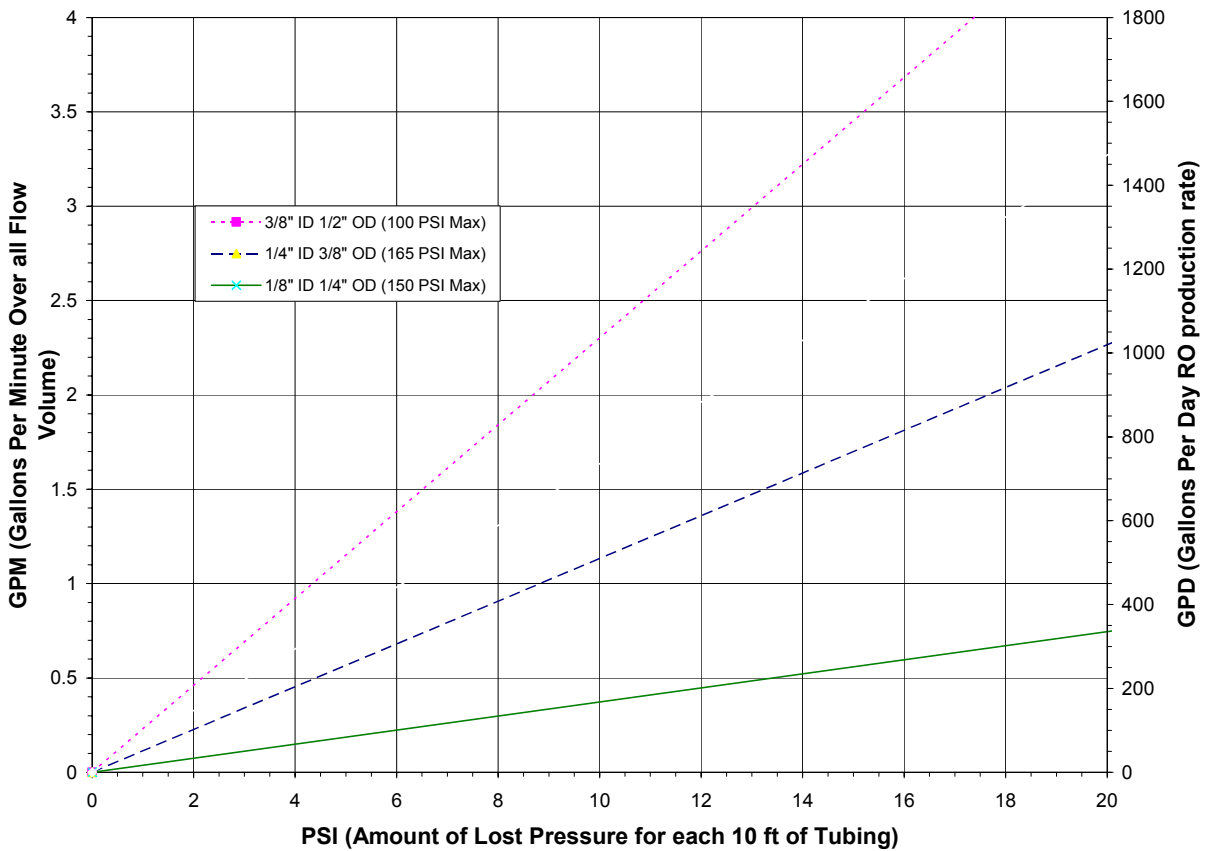

# Brackish Water Purification Systems

(7/4/2007)

The following illustrates where reverse osmosis membranes (.0001 to .0015 micron) fits in the relative size of common materials. From [http://www.hfpurewater.com/reverse\\_osmosis.htm](http://www.hfpurewater.com/reverse_osmosis.htm) Don't get thrown off by the word "reverse" in the name of "reverse osmosis". The bottom line is it is a material that has very small holes and one needs to use a high pressure to get the water separated from the dissolved larger particles. The holes are just a bit bigger than water molecules. RO is just like any other particle filter only with smaller holes.

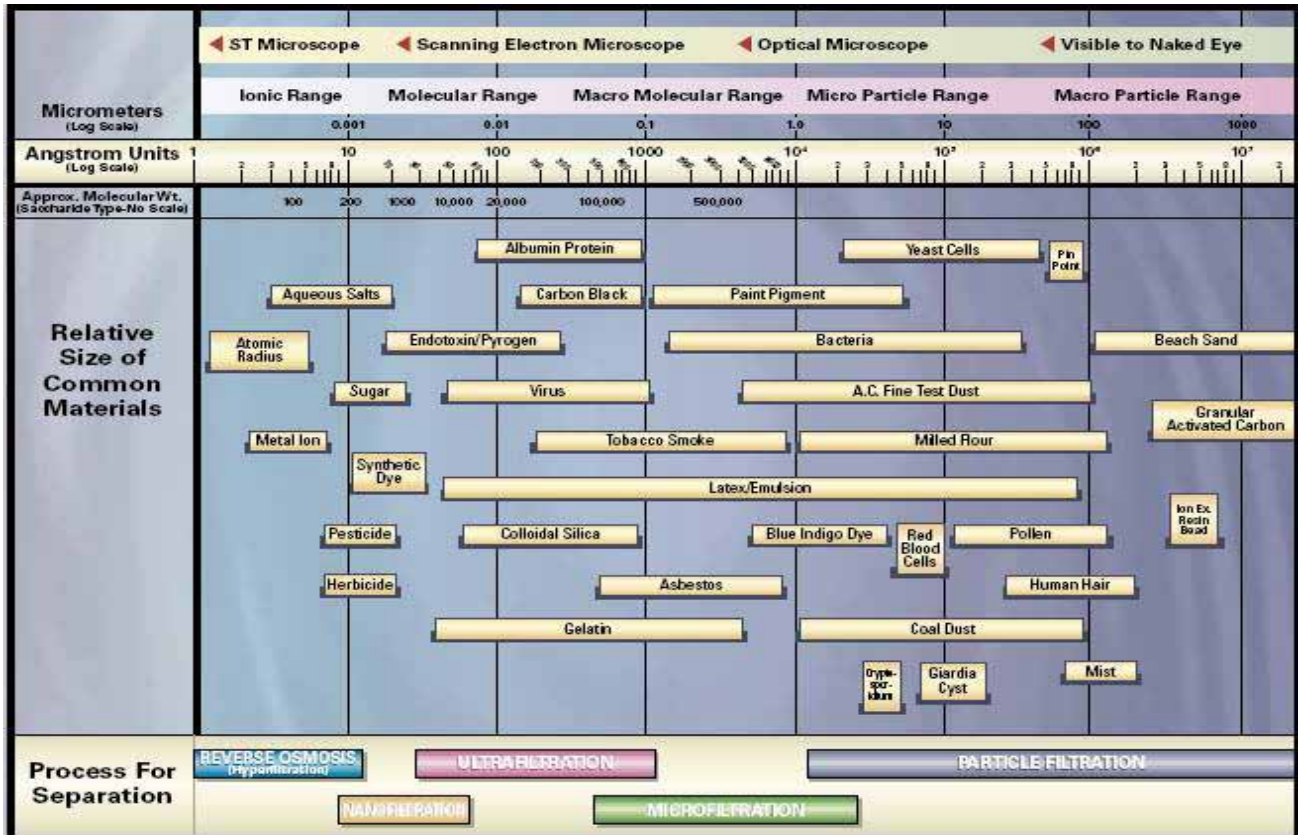

In practice, a fraction of the living bacteria can and do pass through RO membranes through minor imperfections, or bypass the membrane entirely through tiny leaks in surrounding seals. Thus, complete RO systems should include additional water treatment stages that use ultraviolet light or ozone to prevent microbiological contamination. For more info see [http://en.wikipedia.org/wiki/Reverse\\_osmosis](http://en.wikipedia.org/wiki/Reverse_osmosis)

## Tribal knowledge

Chlorine and Ozone gas will degrade membranes and a lot of both is not good for water softener resin. Remove them if present in water before the RO membranes, water softeners and carbon filters. Carbon filters and/or "UV-Light with water passing by it" will take ozone and chlorine out of water solution. The carbon get hot as the Ozone reacts with it. Letting the water with Ozone sit while going from one holding take to another will allow the Ozone to change to normal oxygen due to its short half life of minutes. If needed passing Ozone water through a

# Brackish Water Purification Systems

(7/4/2007)

UV-Light filter will remove chlorine and ozone from the water rendering it harmless. For more info see [http://www.daytonwatersystems.com/productsHTML/L1\\_TechInfo.htm](http://www.daytonwatersystems.com/productsHTML/L1_TechInfo.htm) near the end of the page.

The reason for doing sterilization up front is to avoid growth in down stream filters and tanks. In general if possible use the UV-Light or ozone sterilization again at the end of the process. Light in the range of 200nm to 300nm (nanometer) is used for UV-Light germicidal sterilization disrupting metabolism and reproduction by altering the DNA.

Very high or very low pH can degrade the membrane. Low or acid pH will bring the water softening process to a halt. Bring the pH of the water close to between normal 7 or a bit basic before filtering. Ozone bubbling through the water will help do this.

Iron Bacteria (not to be confused with dissolved iron) causes water softeners problem. Kill it up front with Ozone or UV-Light before it gets to the water softener.

For a simple description of how reverse osmosis filters work see:

<http://www.aquamarineinc.net/content/ROtheory.html> or [http://www.fresh-water-filters.com/reverse\\_osmosis.html](http://www.fresh-water-filters.com/reverse_osmosis.html)

All RO systems use some type of flow restricting device to apply pressure to the membrane. By restricting the flow rate to the drain the system applies proper pressure to the membrane. RO process doesn't work below about 40 PSI. In this case all the water is dumped to waste water. Storage of RO filter elements should be done in a sealed air free bag. There are solutions that can be purchased from marine manufactures that will put it into storage while wet.

Flow restrictor size list:

<b>Reverse Osmosis Membrane Size</b>	<b>ML Per Minute</b>	<b>Approximate Ratio- Waste/Product (Home Use)</b>
8 - 20 GPD	150	4:1
25 GPD	250	3.5:1
36 GPD	350	3.5:1
50 GPD	500	3.5:1
75 GPD	750	3.5:1
100 GPD	1000	3.5:1
150 GPD	1,200	3.5:1

An adjustable flow restrictor can be made by using a T-valve and adjusting the flow through to get approximately 3.5 to 1 water flow ratio for waste water to good water.

Water Well Problems and their Cure:

[http://www.water-treatment.org.uk/well\\_water.html](http://www.water-treatment.org.uk/well_water.html)

Water Treatment Processes:

# Brackish Water Purification Systems

(7/4/2007)

[http://www.water-treatment.org.uk/swimming\\_treatment\\_processes.html](http://www.water-treatment.org.uk/swimming_treatment_processes.html)

The following are useful Conversions when working with water purification:

<b>General:</b>	
<b>Conversions</b>	<b>Abbreviations</b>
ppm = mg/L	ppm = parts per million
1mg/L = 1,000 microgram/L	mg/L = milligrams per liter
1ppm = 1,000ppb	ppb = parts per billion
cc = ml	cc = cubic centimeters
1ml = 1g water	g = gram
1% = 10,000ppm	ml = milliliters
1% = g/100mL	ppt or 0/00 = parts per thousand
1ppt = 1,000ppm	ppb = parts per billion
1% = 10ppt	ug/g = microgram/gram
0.1% = 1g/L	1ug/g = 1ppm
1000ppb = 1ppm	g/L = gram per liter

<b>Hardness:</b>	
<b>Conversions</b>	<b>Abbreviations</b>
1gpg = 17.1ppm CaCO <sub>3</sub>	gpg = grains per gallon
	CaCO <sub>3</sub> = calcium carbonate

<b>Alkalinity:</b>	
<b>Conversions</b>	<b>Abbreviations</b>
1dKh = 17.9ppm CaCO <sub>3</sub>	dKh = German degrees of hardness (also shown as Kh)
1 meq/L = 50ppm CaCO <sub>3</sub>	meq/L = milli equivalents per liter

<b>Conductivity/TDS (total dissolved solids):</b>	
<b>Conductivity Units:</b>	
uS = microSiemens = mhos/cm = micromhos per centimeter	
mS = milliSiemens = mmhos/cm = millimhos per centimeter	
(mhos and Siemens are the same)	
<b>TDS Units:</b>	
ppm = parts per million	
ppt = parts per thousand	

<b>Weight:</b>	
<b>Conversions</b>	<b>Abbreviations</b>
16oz = 1lb	7000 grains = 1lb
0.454kg = 1lb	kg = kilograms
454g = 1lb	mg = milligrams
1kg = 1000g	g = grams
1g = 1000mg	28.349g = 1oz

<b>Conductivity/TDS Conversions:</b>	
1mS = 1,000uS	
1ppt = 1,000ppm	
uSiemens x 0.7 = ppm	

# Brackish Water Purification Systems

(7/4/2007)

## Temperature:

$$(1.8 \times ^\circ\text{C}) + 32 = ^\circ\text{F}$$

$$(^{\circ}\text{F} - 32) \times 0.56 = ^\circ\text{C}$$

## Volume:

$$15\text{ml} = 1/2\text{oz}$$

$$250\text{ml} = 8\text{oz}$$

$$3800\text{ml} = 1 \text{ gallon}$$

$$30\text{ml} = 1\text{oz}$$

$$500\text{ml} = 1\text{pint}$$

$$60\text{ml} = 2\text{oz}$$

$$1000\text{ml} = 1\text{quart}$$

$$120\text{ml} = 4\text{oz}$$

$$2000/2500\text{ml} = 1/2 \text{ gallon}$$

$$3.78\text{L} = 1\text{gal}$$

$$128\text{oz} = 1\text{gal}$$

$$2\text{pt} = 1\text{qt}$$

$$4\text{qt} = 1\text{gal}$$

$$\text{qt} = \text{quart}$$

$$\text{pt} = \text{pint}$$

# Troubled Times



## Underestimated

---

75% of Americans are chronically dehydrated. (Likely applies to half the world population.) In 37% of Americans, the thirst mechanism is so weak that it is often mistaken for hunger. Even *mild* dehydration will slow down one's metabolism as much as 3%. One glass of water shuts down midnight hunger pangs for almost 100% of the dieters studied in a U-Washington study. Lack of water, is the #1 trigger of daytime fatigue. Preliminary research indicates that 8-10 glasses of water a day could significantly ease back and joint pain for up to 80% of sufferers. A mere 2% drop in body water can trigger fuzzy short-term memory, trouble with basic math, and difficulty focusing on the computer screen or on a printed page. Drinking 5 glasses of water daily decreases the risk of colon cancer by 45%, plus it can slash the risk of breast cancer by 79%, and one is 50% less likely to develop bladder cancer.



# Troubled Times



## Springs

---

Source: *Manual of Individual Water Supply Systems*,  
PA-430/9-74-007, **U.S. Environmental Protection Agency**

In rural areas springs often are used for water supplies. Springs occur where groundwater discharges to the land surface. Depending on the geology of an area, the discharge may bubble from a fairly distinct point, (e.g., from fractured bedrock) or may surface as seepage areas with no well-defined discharge point, as when an impervious layer of soil channels groundwater to the surface.

Although springs can be a good source of water, they may not provide enough water throughout the year to be a reliable supply. Many springs are fed by water that is fairly close to the soil surface so that during periods of drought there may not be enough water in these areas to keep the spring flowing at a sufficient rate.

Another problem with springs fed by shallow groundwater is that they are contaminated easily by microorganisms and other pollutants from the land surface. For this reason it is important that no contamination sources be located upslope from the spring and that any surface runoff be diverted away from the spring development. Fencing to keep livestock out of the catchment area is advisable. Because springs are so easily contaminated, installation of disinfection equipment usually is necessary.

Springs that become muddy shortly after a rain shower probably should not be developed as water supplies because surface water provides much of their flow. These springs are likely to be highly unreliable and may be contaminated.

Before proceeding with development, the total daily flow from the spring should be estimated to ensure that it at least equals the daily water need. (Provisions for peak water use can be met by using a storage tank.) To make a crude estimate of the spring's flow, the flow rate should be measured during the lowest flow period (usually in the late summer or fall) by constructing a temporary clay dam below the spring to channel the water. A pipe is placed through the dam and the time required to fill a container of known volume is recorded. Then the flow rate is calculated.



# Troubled Times



## Wells

---

Source: adapted from *Manual of Individual Water Supply Systems*, EPA-430/9-74-007, **U.S. Environmental Protection Agency**

Any well provides a conduit from the land surface directly to groundwater. Polluted surface water may enter the well and move rapidly to the underlying aquifer, contaminating groundwater. Because the well borehole may penetrate several aquifers, if a polluted aquifer lies above an unpolluted one, water from the polluted aquifer may drain through the well and contaminate the aquifer that lies below. Abandoned wells should be filled (with cement grout or clay) in such a way as to prevent water movement within the borehole and groundwater pollution. Active wells should be properly located and grouted. (See well construction section. Procedures vary with specific site conditions.)





# Troubled Times



## DeepRock

I recently sent off for information regarding the **Hydra-Drill 2000**. It is offered by **DeepRock** out of Opelika, AL (address: P.O. Box 1, Opelika, AL 36803-0001). The Hydra-Drill is a one-person water well drilling unit. The end result is a 2 inch diameter well that can be up to 200 feet deep and will easily supply the water needs of a small group of neighbors. It is completely portable and can be hand carried (several trips I would imagine) into remote areas. I have the brochures and ordering information.

The drilling rig alone costs	\$997
Drill stems (10 5-foot sections)	\$188
Well casing (10 5-foot sections)	\$55
Well screen	\$75
Drill bits (complete package of 5)	\$199
Well drilling pump* (for areas where a pressurized water source is unavailable)	\$458
Drilling additive* (for drilling through sand or gravel)	\$69

\* optional items

Of course you will need a deep well pump to draw the water once the well it drilled. You can buy one from DeepRock (they didn't include prices) or locally. With purchase of the drilling rig, you receive a handbook with complete instructions on how to locate water and how to drill the well. They also have a toll-free consultant line and will give advice on drilling your well or any other information you may need. They have a limited warranty of 6 months for free replacement of defective parts. If you order more drill stems, bits or casings than needed, you can return the unused quantities for a refund within 90 days! They also have a bit sharpening and/or trade-in program. Sounds great! Their phone number for ordering or questions is **1-800-633-8774**

Offered by [Roger](#).

I have personally used this rig to help drill 3 wells; all of which were good producers. It IS a lot of work and it really does help to have a couple people to help out. Just how much work depends on how much rock you have to drill through. A friend in Biloxi MS just drilled a well with it this summer with very little help. He hit good water a little over a hundred feet in about 2 days. That is the exception though as he had nothing to drill through but sand. the drill bit ended up with hardly any wear at all. On the other hand, the two wells I helped with in Oklahoma took weeks each (working weekends) and required rebuilding the bit 3 or 4 times.

Offered by [Ron](#).



# Troubled Times



## Dowsing

---

I've done this a bunch when I was in high school. Found it very easy. I did not know it was any kind of special talent. I used a Y shaped stick. I was in an area with woods, streams and rivers. When you get near water the stick just dives down. If it is a large body of water the stick will even shake a bit in your hands.

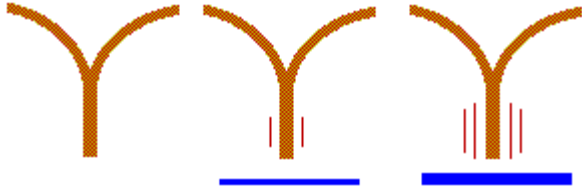

Offered by [Brand](#).



# Troubled Times



## Coat Hangers

Finding water or metal objects in the ground can be very useful in the backwoods. Here is the procedure:

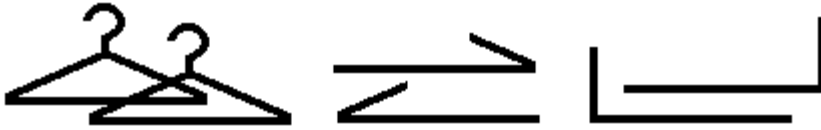

1. Equipment: two *steel* coat hangers
2. Cut off the rack hook and one shoulder from each hanger leaving 18 inches from the straight bottom and one shoulder of the hanger.
3. Take each 18 inch section and bend it L-shaped with one segment six inches long and the other 12 inches long.
4. Cup each into a fist with the hole in the center about pencil size and place the six inch portion of each hanger through the hole in the fist with the 12 inch portion of the hanger resting lightly on top of the fist. *Do not squeeze or grip the wire.* Your hands should both be positioned as if you were holding two pistols. Remember the western gunfighter!
5. Tilt your fists *slightly* forward so the wires point straight in front of you.
6. Now walk very slowly across a known buried wire, cable, or pipe and as you cross it, the two wires (hanger) should turn inwards, and if one fist is slightly high than the other, cross each other when you pass over your target.



# Troubled Times



## Limitations

---

Where I currently live, we drilled for water, found it at 80 meters (approx. 260 feet). We used a professional drilling company with a mobile rig. They were starting to feel uncomfortable when we passed 70 meters (approx. 225 feet). I got a clear understanding that about 100 meters (or 325 feet) would be their maximum. They also said that in certain kinds of rock, it was harder to drill, so that the depth would be reduced. In fact, they tried to persuade me to stop at 30 meters (100 feet) and use dynamite in the bottom of the hole to get the water flowing.

To be on the safe side (if you have the money to burn), I would drill for water *before* buying the property, or find another area. Or maybe the locals can help - after I had drilled, the local farmer told me that if we had drilled at an angle of approx. 30 degrees to the North, we would have gotten water much faster, since that is the direction of the rock layers, drilling down between two layers. A good plan would be to drill two different deep rock wells. I believe I can only have one kind of pump per well, so one could be fitted with an electric pump (plus store spares) and the other with a manual pump (also storing spares).

Offered by [Jan](#).

If you have the well professionally drilled, the driller will be able to inform you of the specifications for pumping the water. If wind power is strong enough, you should strongly consider it as this will be the most abundant resource we will have in the future. Generating electricity to run a pump would be very wasteful, unless that is the only way to gain enough power to bring the water up.

Offered by [Roger](#).

There is an excellent article in the current issue of [Home Power](#) magazine (800) 707-6585 about a 900 foot solar powered deep well pump, though a wind turbine could be used as well. There are many sources listed in the article. Authors: [Mark and Ellen Coleman](#), (505) 751-5946; **Golden Genesis, Inc.** (800) 544-6466, are the first two references listed.

Offered by [Steve](#).



# Troubled Times



## Windmill Wells

---

In drawing water from a well, the ground water aquifer water will, at least, be filtered by the sand and gravel enroute to the well bottom. Most wells today require an electric pump for a six inch well pipe. Large diameter concrete pipe sections which could be used to line such a well would be useful to either store for later or to make such a well now in anticipation of future use. One needs at least a 3000 watt windmill to pump water. This is the minimum size to run water pumping. The **Whisper 3000** put out by World Power Technologies, Inc. and sold by

Lake Michigan Wind & Sun  
E3971 Bluebird Rd.  
Forestville, WI 54213  
414-837-2267 Phone  
414-837-7523 Fax

is about \$4,000 not including an energy retention system (batteries). You need a lot of open space for this kind of a rig.

Provided by [John](#).



# Troubled Times



## Recycled

NASA [Science News](#)

November 2, 2000

Rationing and recycling will be an essential part of life on the newly-populated International Space Station. In this article, the first of a series about the challenges of living in orbit, Science@NASA explores where the crew will get their water and how they will (re)use it.

Interesting quote from the attached reference: *Without such careful recycling 40,000 pounds per year of water from Earth would be required to resupply a minimum of four crew members for the life of the station.* Interesting data. Using the fact that there is 8.33 lb. of water/gallon then the 40,000 lb/year for 4 crew members becomes  $40,000/(8.33*4) = 1200$  gal/year per person or  $1200/365 = 3.4$  gal/person per day. Other interesting and applicable statements: *Once on board the ISS, spacefarers are in for a steady diet of sponge baths using water distilled from -- among other places -- their crewmates breath!... If you're an astronaut, you'll wet the wash cloth with a spray nozzle and then use the cloth to wash your hands. On the space station, people will wash their hands with less than one-tenth the water that people typically use on Earth. Instead of consuming 50 liters to take a shower, which is typical on Earth, denizens of the ISS will use less than 4 liters to bathe.*

Comments on the data presented: Using the conversion factor 1 liter = .264 gal, then on earth about 13.2 gal is used for a shower. In space about 1 gallon is used to bathe. Now to try and get a minimum usage of quality water/day per person after the pole shift, lets look at a what-if scenario. Lets say most people drink less than a gallon/day. Lets also say we use one more gallon for washing vegetable and cooking. Lets take a sponge bath once a week this is 1/7 gal/day. Now suppose we wash our hands using a wash cloth 3 times/day say this takes about 3/7 gal/day. This gives a total of about 2.5 gal/day of quality water needed. This assumes we wash our cloth and boots in lower quality of water.

Bottom line: We will need about 2.5 to 3.5 gallons per day for each person of quality water to live safely yet comfortably. If we assume we use a lower quality of water for pre-washing vegetables and washing cloths then I think as a bare minimum if absolutely necessary the water one drank would need to be of quality, and all else could be a lower quality of water. For example the lower quality water could be filtered for small particles, Ozone purified, and carbon filtered. The quality water could include the above but also be run through a reverse osmosis filter or distillation process. Distilled water could come from dehumidifiers, refrigerator drip pan, still tents, or commercially available distillation units. A third type of water would be unfiltered and could be used for washing some things like boots etc. What we feed to our plants would depend on how much of what type water we have. I see three or more grades of water in common use.

Offered by [Mike](#).



# Troubled Times



## Precious Water

---

Water is necessary for life, because it replaces the fluids which we secrete when we urinate, defecate, or excrete through our sweat or breath. Therefore we need, in normal human and weather conditions, about 1.0 to 1.5 liters daily. We can drink this as water directly, or as tea, coffee, or other drinks. Water can also be partly replaced with juicy vegetables or fruits.

If we can't replace lost fluids on time, we become thirsty and uncomfortable, and later we lose our appetites and become sleepy and lazy. In the end, we become sick and dizzy, and finally fall into delirium and die. Without water we can live at best a week, though without food we can live 3 to 4 week, if we have water.

When we don't have enough water, we must use it as carefully as possible. That means:

1. don't use water for non-necessary things, such as washing and cleaning, or use it as little as possible
2. eat as much as possible raw or baked food; if you cook food, don't throw water away
3. drink water in small portions, drinking slowly taking a sip only after a certain amount of time; also keep water in your mouth as long as possible
4. minimize your body's requirements for water and minimize loss of water through secretion such as sweating

Many times when we want to drink it is not necessary as we are not really thirsty. Many times we only think we are thirsty, as our mouth are dry. In these cases it is sufficient if we only wash out our mouths.

As already mentioned, thirst is a result of loss of water through secreting a number of fluids. We can minimize secretion, and this also minimizes our body's need of water. If your water supplies are low, then:

1. avoid sun during the day and be in shadow as much as possible
2. if you must work and move about and be active, then do this during the night or during the cooler hours of the day, and rest when it is hot
3. avoid overly sweet foods or foods that are too spicy, and eat plenty of carbohydrates, fruits and vegetables
4. avoid getting your mouth dry by breathing through nose, speaking only when necessary and avoiding smoking if we are smokers

If our mouths get dry anyway we should chew some juicy vegetable or, if this is not possible, mouth some object like a button so that we salivate.

Based on the Slovenian book, *Living in Nature*. For information contact [Kiko](#).



# Troubled Times



## Where and How to Get Water

---

There are 3 types of water (according to where we get it):

1. underground water, which is available in springs and wells,
2. surface water in brooks, rivers, lakes and swamps
3. atmospheric water, which falls from the sky as rain, snow, dew, etc.

All 3 types depend on atmospheric water. When atmospheric water falls on the surface it sinks through cession layers until it gets to an uncession layer. There it collects and then decants into various directions depending on the of slope of the layer. Where this layer crosses a surface, it is a spring. Therefore springs are usually located on inclines, on the sides of a hill (specially on cuttings), in gorges, on the periphery of valleys, and usually where snow melts fast.

Some signs usually show where we can find a spring, such as vegetables that need more water (willow trees, reeds), places where the green color of plants is more intense, wet ground or areas, where midges fly around and places where we find numerous footprints of animals. If we see such a place, but there is no water, then it is underground. In such a case, dig a hole and wait until water strains in. If such a place is on a slopes, dig on the lowest edge.

In mountain areas we can find water as snow, that stays in some holes or gorges or other low lying places, or that stays in dry river beds where we should dig on the outer edge where the river turns.

Water can also be collected when it rains. Take a large piece of dense textile and spread it. Water collects in the middle of the cloth. A cloth dragged across the grass at dawn can also collect the morning dew. Drag the cloth and squeeze the water into a container, repeatedly.

If we're thirsty and can't find water with any of above ways, we can eat some juicy vegetables, fruits or collect juices from trees.

Based on the Slovenian book, *Living in Nature*. For information contact [Kiko](#).





# Troubled Times



## Water Collectors

The easiest form of a collector is a dam. We can make a dam by putting some stones, branches, soil, or similar material into a brook and making an outflow which serves as a pipe. We can also make a collector in or near the brook: Making a collector in a stream is done by putting a barrel without a bottom into a brook, and fixing it. Water penetrates through gravel and sand into the barrel and cleans itself in this way.

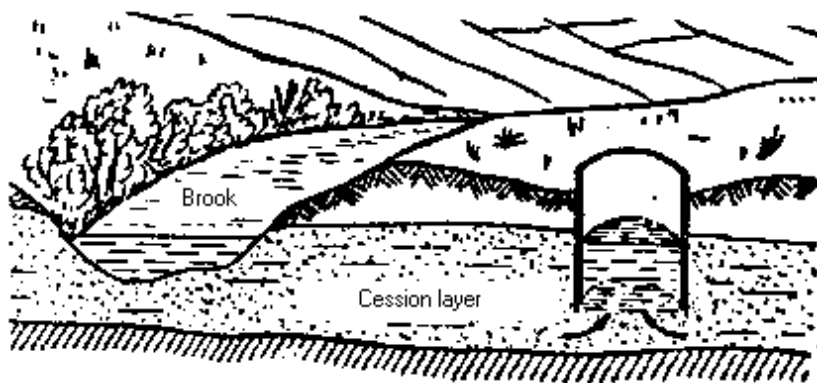
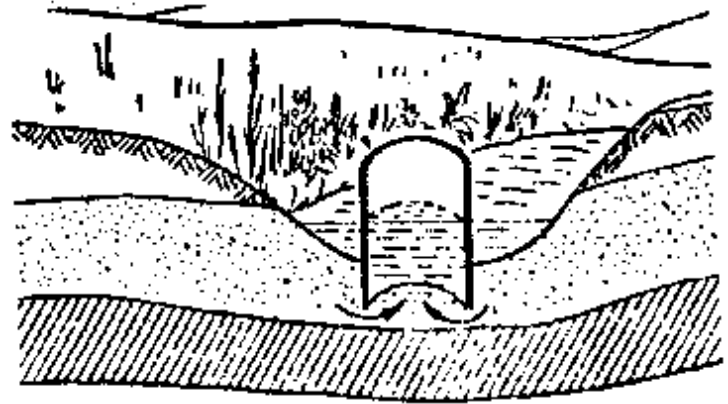

A similar collector can be built near a brook. About half a meter from a brook, river or lake dig a hole and coat it with stones, branches and/or planks. This way we make something similar to a fountain. Water in a brook, river or lake penetrates through gravel and sand into our fountain and cleans itself this way. It is also wise to cover the fountain.

Based on the Slovenian book, *Living in Nature*. For information contact [Kiko](#).



# Troubled Times



## Hill Catch

---

A little bit up hill you make a large 30 X 30 sand box and fill with poly plastic (about \$20). Drain this into a big plastic holding tank every time it rains. These tanks cost about \$100 at a farm supply store, the piping about \$20. Remember to bleach or boil the water. You could simply dig a hold or use pressure treated lumber to make an actual sand box. If it gets cold enough to freeze, you can allow the water to collect and then unfreeze chunks when you need them. Be sure to put dividers in or you may never get it apart.



# Troubled Times



## Rainwater Tanks

---

Quality Farm and Fleet, a chain of farming stores in the midwest sells 500 to 1500 gallon plastic type circular tanks for rainwater, or any other liquid (other than toxic chemicals). A little big to put in the van, but good to know!

Offered by [John](#).



# Basic Survival Rain Water Filter System

by J Galante

## Basic Survival Rain Water Filter System

J. GALANTE - 97



You will need two clean containers such as buckets or wastebaskets, preferably of flexible white plastic. We used new 4 gal. paint buckets.



Cut bottom out of container "A" and discard.

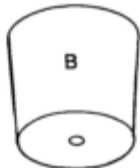

Cut a hole in center of "B" the size of the vinyl tube you have purchased. We used 1/2" diameter non-toxic vinyl, 12" long.

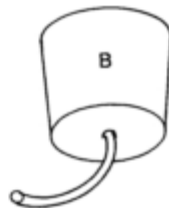

Attach and seal hose into hole in bottom of "B" with silicone sealant.

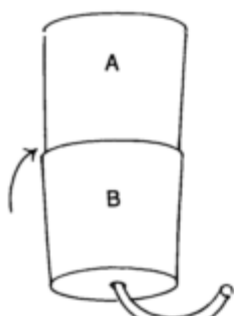

Container "A" should fit into "B" at about this level. You can glue wedges on sides of "A" to hold at desired level if needed.

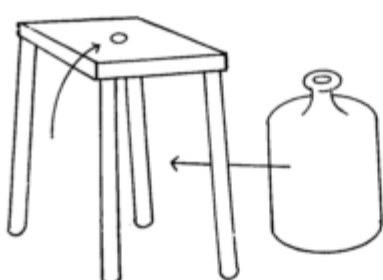

Use a table high enough to allow water bottle to fit underneath. Cut hole for tube to pass through.

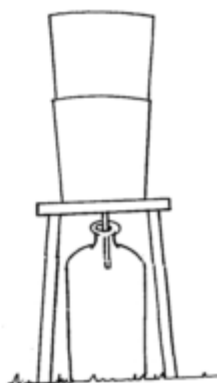

Finished rain water filter system will look like this.

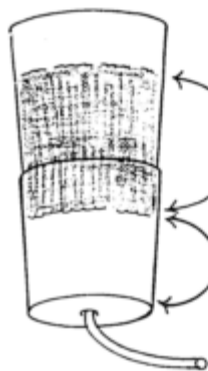

This layer is carbon. Use a layer thick enough to allow an adequate filter depth.

This is the polyester quilt batting. Use a thick layer to strain out small bits of carbon or debris in rain water.

You must add 10 drops of household bleach, (chlorine) to each gallon of filtered water, to kill bacteria and deter bacteria growth during storage.

### Filtering Material

1. You will need at least 15 to 20 lbs of granulated activated carbon (charcoal, but NOT the barbecue pit type), which we found at an aquarium supply store. Be sure there is *no chemical additives!* This *must* be *thoroughly* flushed and rinsed before use, until water runs clear, to remove carbon dust. This must be changed after a while (after 1 month with constant use) because it becomes saturated with contaminants and can release them back into water. We estimate that we can probably change it after 2 to 3 months since we anticipate filtering rain water as we catch it, and this probably won't be very day. Our 18 lbs should last us (3 adults and six small pets) 5 to 6 months with God's mercy and a little luck!

2. You will also need a large package of 100% pure polyester quilt batting (padding), which can be found at most fabric stores. Don't compromise with cotton, it can mildew and rot!

per J Galante

Option: in step 2 of the diagram above you can leave the bottom of bucket A in place (not cut it out) and poke holes in the bottom with a hot nail. This allows the activated carbon and quilt batting to be kept separated.

The information shown above was furnished by J Galante and made available by B&A Products. However, B&A takes no responsibility for the

accuracy of the information or the ability of the above shown filter to thoroughly filter or purify rain water. Please note that this is for *rain water only*, and this *does not include any form of ground water* (creeks, lakes, etc). This is provided for information only.

---

**Related information:**

Newsletter article: [Storing Water](#)

Newsletter article: [Portable Water Filters](#)

Catalog/product information on Katadyn Portable [Water Filters](#)

Questions and Answers about the [Aerobic 07](#) water purification drops

---

[[B&A Page](#)] [[Catalog](#)] [[Preparedness](#)] [[New Products](#)]  
[[BA-Industrial.com](#)] [[FirstResponderSupplies.com](#)] [[BA-Electronics.com](#)]

Use the **BACK button** on your browser to return.



Original date: August 24, 1997

Last updated: August 24, 1997

[Copyright](#) 1997-2002

# Troubled Times



## Rainwater

By [David Knapp](#)

For every inch of rain you will collect 600 gallons of water for every 1,000 square feet of horizontal collection surface. Example: Central Texas - Average rainfall of 31 inches per year. To be safe, let's assume 25 inches per year.

**Yearly collection:** 25 inches  
**Roof size:** 2,000 sq ft.  
**25 inches x 600 x 2 (2,000 sq. ft. roof) = 30,000 gallons**

That allows for an average monthly use of 2,500 gallons. You will want several months worth of storage to account for the dry season. This is certainly not enough for an average home, but more than enough for an Earthship with adequate storage.

### Average Rainfall Yield

Roof Sq Ft	-----Inches of Rainfall-----				
	20"	25"	30"	35"	40"
1,000	12K	15K	18K	21K	24K
1,500	18K	22K	27K	31K	36K
2,000	24K	30K	36K	42K	48K
2,500	30K	37K	45K	52K	60K
3,000	36K	45K	54K	63K	72K
3,500	42K	52K	63K	73K	84K
4,000	48K	60K	72K	84K	96K

**K = Gallons in Thousands**

The above information was extracted from *Rainwater Collection Systems* booklet, distributed by **Morris Media Associates, Inc.**, Austin, Texas. There is additional information on tanks, pumps, plumbing, insulation, etc. There is also a companion video which I purchased through **Real Goods** a few years back.



# Troubled Times



## Cloth

---

Yesterday on *National Public Radio*, there was an interview with a Canadian scientist who has successfully put together "fog machines" that condense fog into usable rainwater. I know we reference Chile, but I don't think we talk about how it's done. It's a tough, water soluble cloth or cloth mesh 20' x 40' with high tensile strength poles because of the potential for wind damage. These are mounted with the cloth enough off the ground that gutter like trays or tubs are put underneath. The cloth collects the droplets, and the droplets collect in enough mass to drop into the gutters as water. No electricity needed. I can't remember the name of the scientist. Since it was on NPR yesterday, there may be reference to this on their website.

Offered by [John](#).



# Troubled Times



## Air Well

---

Another interesting invention that has never been implemented on a large scale was designed in 1931 by M. Achille Knapen. He succeeded in condensing and extracting water from warm air to irrigate fields and vineyards in southern France with what he called, an "air well" (**See U.S. patent no. 1,816,592**). Looking like a 40-foot concrete beehive, it was possible to produce as much as 6,000 gallons of water daily for every 1,000 square feet of condensing surface. An airwell can be built on practically any scale, and the wall materials can be concrete blocks, bricks or concentric hollow shells filled with sand or earth.

A small airwell 12 feet high and 12 feet across with walls 2 feet thick can supply a generous output of daily water. It can be fitted with top and bottom air pipes, and a multitude of condensing plates on the inside. Warm air circulates and gives up moisture on the cool inside condensing plates angled downward toward a catch basin at the bottom where it is collected. Using scrap and local materials, makeshift air wells could help solve many water problems in drought ridden areas of the world, especially in Third World countries.

As mentioned in **Creative Alternatives For A Changing World**

**Creative Alternatives**  
1463 Berger St.  
Odenton, MD 21113 USA





# Troubled Times



## Dew

---

Any natural or created temperature gradient can produce the dewing process. This process is based on the fact that cold air does not hold as much water as warm air. Cool the air and the water falls out. The larger the temperature gradient the faster the process. It also helps if the cooler area is higher than the hotter. For example if you have warm ground and cool air then just put up a distilling tent. This could be as simple as a clear plastic tarp in a tent shape over some wet ground.

Best shape is an A shape where the sides have roughly about 45 degree angle. PVC pipe with joints could be slipped together to form a tent shape with the plastic over the outside. Ropes over the top staked down on each side hold it down. The bottom of the plastic folded under a PVC pipe at the base of the perimeter. The plastic would be wrapped around the base perimeter made up of PVC pipe. The distilled water will form as droplets on the inside of the tent and run down into a trough made by wrapping the plastic around the base PVC pipe. This is the space between the plastic and the pipe.

Don't let air in, keep the tent closed on all sides. Fold the ends like wrapping a package. Wrap the bottom of the ends around the PVC pipe. Wait until the water begins to puddle in the plastic wrap around the edge. Dig a hole at the lowest point or points and put one or more containers to capture the distilled water. Put a small hole in the plastic to let the water drip into the container.

Offered by [Mike](#).



# Troubled Times



## Tent

---

I made a quick drawing of the basic principles for distillation using a plastic tent. I have it about half built but it has not been tested yet. It is very simple in its construction. One needs PVC-Pipe, PVC- fittings, and plastic tarps. A flex tube and container to collect the distilled water. A little silicon rubber to make the seal where the hose goes through the plastic. A funnel to fill it. A source of heat and coolness is need in close proximity to each other. The greater the difference in temperature the faster water can be distilled. Now that this principle is understood. Lets take it to the next step. Suppose one uses clear plastic for the walls and grows plants in the ground where the gray water is shown. Suppose after the pole shift there is enough light for some very low light plants to grow. Now this setup would allow one to distill water for human use and at the same time protect the plants from toxins from outside rain. Nutrients could be fed to the plants from worm beds etc. The small amount of light coming through the dense clouds could be supplemented with additional light if power is available.

## STILL-TENT DISTILLATION PRINCIPALS

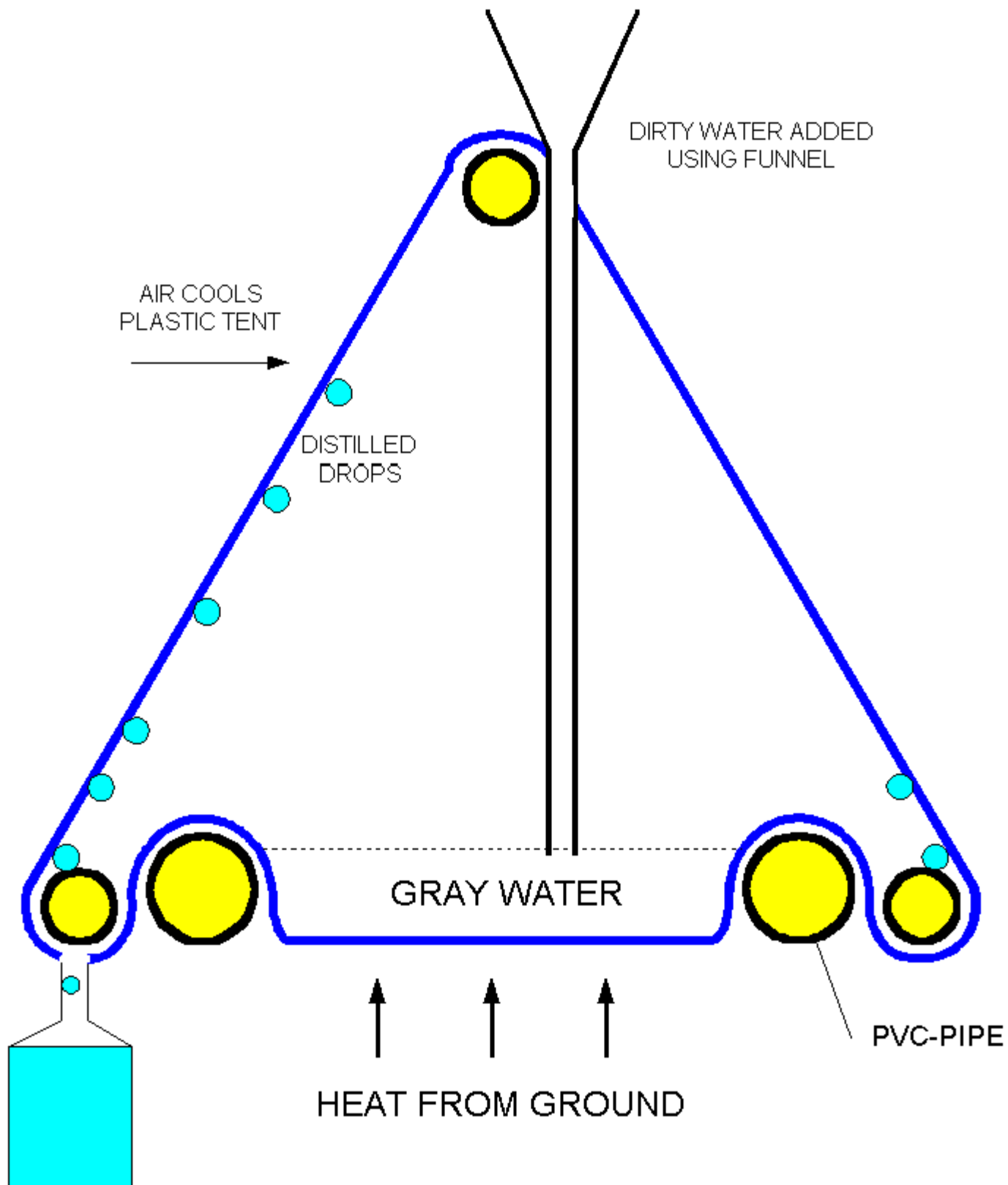

The disadvantage to this is animals can easily tear their way in and get our food. Probably would need to fence this off to protect it. Another disadvantage is plastic tarps have a limited life to them. Clear thick vinyl might be the longest lasting. Any plastic may leach out some toxins (pesticides) into the distilled water. This would become less with usage. I am currently thinking lead, etc. poisoning to be worse than the pesticides.

Offered by [Mike](#).



# Troubled Times



## Filtered

---

*I saw a Mr. Wizard type guy on TV and he showed the wick action of cleaning up muddy water. He said to put the muddy water in a container and place a clean towel from one container to another empty one that is at a little lower elevation. The clean water is sucked up by the towel and deposited into the empty container with out all the junk. If you boiled it or treated it for germs afterwards it would be perfectly safe. Chemical contamination is another thing entirely. So if the water has chemical pollution you couldn't do this. But if its just dirty or has leaves or debris in it, this would work.*

### **Water Filter**

*Here is a camping tip - never send muddy water through your water purifier - it clogs it and doesn't work as well and won't last as long. Pour the water through a bucket of sand (hole punched out at bottom) or even "duff" from a forest floor. Fill a 5 gallon bucket with the stuff under the trees in a fir forest and see how clean the water runs out (we did this at outdoor school). Then send it through a purifier to get out microbes. Paper coffee filters work good too.... or let the water settle in a container, then skim off the top clear stuff.*

### **Water Cleaning Tip**



# Troubled Times



## Old Fashioned

---

From *Lees Priceless Recipes* (originally published in 1895 and now re printed in 1998)

*A cheap filter is made by taking an ordinary, large-sized flower pot; plug the hole with a piece of sponge; then put a layer of powdered charcoal about 1" thick, the same of silver sand; then a layer of small stones and gravel about 2" thick. This makes an excellent filter for impure water.*

also

*Another method of purifying water is by placing in a tank of impure water a vessel so arranged that a sponge which it contains shall lap over the edge and dip into the water of the tank. The sponge gradually sucks up and purifies the water in the reservoir and allows it to drop into the smaller vessel or receiver, from which it can be drawn off by a tube. By placing a few lumps of charcoal in the receiver, filtration of the most perfect kind is affected.*

This book is a real gem. Its truncated subtitle is, "A valuable collection of tried formulas and simple methods for farmers, housekeepers, mechanics, manufacturers, druggists, chemists (etc., etc.), for people in every department of human endeavor", and you can get it for about \$10. Highly recommended.

Offered by [Kraige](#).

The first filter sounds good but I don't quite understand the second. I am wondering if the following would create pure water. Based on the way you derive water when without in an emergency. Normally you dig a hole and place green plants or non pure water in the hole. You put a container with a long tube in it , in the center and cover with a plastic cover with a small rock in the middle to cause the water to condense and drip from the low area to the container. So I am wondering if you could do this with impure water in a tub to get pure water? And if you could, why couldn't you do it on a larger scale. I know this kind of system (plastic and hole) needs some warmth but not a lot as it is not much different than the terrarium I used to have that always collected drips no matter what time of the year. Caves which stay a cool temp even drip without a water source.

Offered by [Cynthia](#).

You're talking about a distillation process that normally relies on the sun to evaporate the water under the plastic, but if you had the sun or just warm temperatures, (which will exist, I assume, for places that end up being closer to the new equatorial climes) it could be done on a larger scale.

Offered by [Kraige](#).



# Troubled Times



## Cactus

---

If you live in a desert, then start planting cactus in the wild. Ones like the barrel cactus are a great source of water.

Offered by [Steve](#).



# Troubled Times



## Water Atlas

---

The atlas described in the following article might be useful for those outside the U.S. who have little access to local climate data. Could be useful for choosing a place to start up subsistence farming in the next few years.

Offered by [Euan](#).

### **Study cites water shortages in parts of world**

by Randolph E. Schmid, *Associated Press* writer

Water shortages in parts of the world in the next 25 years will pose the single greatest threat to food production and human health, according to a study financed by the United States and Japan. At a time when 1.3 billion people worldwide have no access to clean water, it also could become a key issue in conflicts, warns the report's author, World Bank vice president and agriculture expert Ismail Serageldin. "New ways must be developed to take advantage of this diminishing resource if humanity is to feed itself in the 21st century," said Serageldin, who heads the Consultative Group of International Agricultural Research.

In an effort to improve water management, the group has compiled a massive electronic world water and climate atlas, a high-tech undertaking designed to assist local farmers, their bankers, government planners and even international financial groups. Work on the atlas was financed by the Japanese government and the U.S. Agency for International Development. Few Third World farmers have the knowledge or equipment to download the atlas from the Internet or read it from compact discs, Serageldin acknowledged. But the data will be available to government agriculture agents who work with farmers. Indeed, the project has already identified a region in Bangladesh where farmers can plant a type of chickpea on land that previously was left idle during the dry season - thus adding a second crop to their annual food production, he said.

The atlas provides maps of every country on earth, with the user able to call up a variety of information. For example, farmers can examine rainfall and hours of sunshine, temperature averages and soil types in their home area. Worldwide, about 80 percent of water use goes for agriculture, and demand is increasing. Most new food output comes from land that requires irrigation - meaning that water scarcity, not shortage of land, is likely to be the biggest impediment to food production in developing countries. The atlas, Serageldin said, can help identify "areas which today do not produce food but could without destroying forest." It can tell planners where new or different crops might be grown without irrigation, or with supplemental irrigation rather than costly full-time irrigation.

In all, a quarter of the world's population is expected to face severe water scarcity in the next 25 years, even during years of average rainfall, the group estimates. And as surface water increasingly is used up fully in semiarid regions of Asia, the Middle East and Africa, groundwater tables are falling. The group also hopes to add more local information to the atlas. That effort is now complete for the Indian Ocean country of Sri Lanka, and other parts of Asia are being added. "Down on the small scale is where the investment decisions come in," Serageldin said. In the past, the data in the atlas has not easily been available to local farmers and planners, but was usually scattered among several government or international agencies. Now it is accessible on a set of compact discs and is scheduled to be available in December on the group's *Water Management Institute* Internet page.



Until it is put on the Internet, the atlas can be obtained from

James Lenahan  
**International Water Management Institute**  
P.O. Box 2075  
Colombo, Sri Lanka



# Troubled Times



## Prototype

---

*We are requesting \$6 million USD for the construction of several models of the Skywell Production Models. 4 each of the R45 model and one each of the A4000 and C200. In return, we will offer \$60 million in return within 3 years or less. One million will be required the first four months for the construction of several production models of Water Units as described below. \$5 million additional will be required within 4 months for the manufacturing and production costs. In addition, 3 models of Remote Power Units ( which are classified as "Free Energy " electrical power generators) will be developed and readied for production to run several different models of the Skywell Atmospheric Water Units.*

*We have prior commitments from 2 Middle Eastern nations of 1,000 R4000 models yearly. These sell for \$300,000 each. This standing order hinges on the R4000 performing to standard in low humidity regions of approximately 300,000 gallons of clean water from the air per day. Once we are able to demonstrate to the nations embassies as requested, the product orders may be sufficient to grease the wheels of production and only 2 or 3 million may actually be necessary to borrow up front. At any rate we will return 10 to 20 times what is initially required in the first year.*

*Objectives as of spring 1999, our short term objective is to use all we have learned from our scientific prototype water machine and build the production prototype 300,000 gallon per day model A4000 as well as 4 each R45 2,000 gallon per day models. The 8x8x40' and will cost about \$2 million with related building and supporting facilities. About \$600,000 itself because of tooling and special orders required. We intend to market the A4000 at \$300,000 . We have divided the global market into 12 major divisions and those into sub- regional areas. Our objective, at this time, is to propel the company into a prominent market position, create jobs, help our environment and provide quality low cost water for agriculture, industry and human consumption.*

## Skywell



# Troubled Times



## Skywell Water Systems

---

Skywell Water Systems is under reorganization and does not currently have any atmospheric water units for sale. Further information will be available within 6 months if all goes well. Currently a contact point is [John Dahlen](#). Thank you for your prayers and support in this vital project of bringing clean cheap water to the thirsty people and crops of the world.

Sincerely,

[John Dahlen](#), Public Relations, **Skywell Water Systems**



# Troubled Times



## Synthesis

---

### Skywell Atmospheric Water Systems, Information Update:

H<sub>2</sub>O Synthesizer: Skywell Atmospheric Water Unit chemically converts Hydrogen Oxide compounds (HO) to H<sub>2</sub>O through a catalytic Chemical process. Our current scientific studies with this process have shown that we can convert the hydrogen compounds found in 180 cubic foot of air to one gallon of very clean, distilled quality water. ( chemical reaction  $2\text{HO}+2\text{HO}=2\text{H}_2\text{O}+\text{O}_2$ ) Our scientific model proves this process is possible and very economic. Projecting these statistics to our production models, we will be able to produce very large volumes of water at very low prices like 1/2 cent per 1,000 gallons. Models from 500 gallons per day, 2,000 gallons per day, 30,000 gallons per day and 300,000 gallons per day. Most of these large units will function on less than 5 kilowatts an hour or about \$7.68 a day.

The significant fact is that the Hydrogen compound conversion is independent of local relative humidity, temperature or proximity to other sources of water. The same process can be done in the middle of a hot desert or cold tundra, remote Pacific Island or cattle ranch in Texas. The Atmospheric Water Units will range in cost from \$3,000 to \$300,000. They are designed to be low maintenance, reliable and rugged. Fishing boats and ships at sea would find these ideal, much cheaper than reverse osmosis or other desalination technologies with less cost per gallon, higher quality water output and lowest energy costs. They can be configured to run on AC or DC. On large orders, please specify energy requirements. We will have the capability in the future of powering these units with alternative energy systems such as solar power with little or no fuel costs.

