



[Mail this Page to a Friend.](#)

Awakening

[Note: for recent ZetaTalk on Crop Circles, the Cassiopeian Org, Nancy in the media, Ning role and related subjects check the [Q&A chats.](#)]

The Zetas talk about how mankind is gradually realizing they are [Not Alone](#) and Awakening to the [Alien Presence](#); why for many the [Time Table](#) seems too slow as their [First Impressions](#) have been favorable, [Signs of the Awakening](#) are apparent, and an [Alien Welcome](#) awaits. The Zetas talk about how we can expect [Sightings to Increase](#) and [Not Just UFOs!](#) along with [Mass Sightings](#) and [Glowing Ships](#) and [Mothership Sightings](#) and recent [Lights in the Sky](#) and Mexico [UFO's on Film](#) and [UFO's in the News](#) and [Phoenix Lights](#) have resulted; why mass sightings can be called an [Initiation Rite](#), thence [Shared](#), but sometimes [Faked](#); how sightings and [Power Outages](#) and pictures of [Alien Bodies](#) will cause [The Word](#) to spread; why CNN's [Arizona Coverage](#) of a mothership sighting occurred in step with [Roswell Revisited](#); how concurrently there will be an increased [Demand for Proof](#) from the debunkers and increasing [Discord](#); how it is difficult to [Disprove the Proposition](#) when conflicting claims or [Info or Disinfo](#) seemingly merged are made and there are [False Channels](#) and [False Claims](#) like the [Serpo Exchange](#); what role change agents such as [Art Bell](#) and [Hoagland](#) play and why [ZetaTalk](#) and [MUFON](#) will no longer be suppressed, and [Leaks](#) increasingly occur; why there always seems to be an [Element of Doubt](#) such as during [June Incoming](#) and [Sign to Mankind](#) and [Prophet Yehwah](#) and a [Truth Test](#) seems elusive; why [Breaking the News](#) is so difficult and if the [ABC Special](#) was a start; why the scare caused by [Orson Wells](#) was deliberate, as was the disappearance of [Air Force One](#) and a possible [Staged Invasion](#); how [Alien Encounters](#) will eventually occur during the [Next Phase](#) and occurred in the [Past](#); and how there are [Tumultuous Times](#) ahead but [Prophecy](#) such as [Zhuge Liang](#) and a [China Mirage](#) and ZetaTalk [1999 Prediction](#) can be a guide.

The Zetas talk about the world that will be, how some of our citizens are operating in the 4th Density [Service to Others](#) mode already; how many contactees find they have met a [Familiar Stranger](#) and feel there is something they are [Supposed to Do](#) but aren't sure what it is; whether [Mass Consciousness](#) spreads the word; why truth often comes from the [Mouths of Madmen](#) and the [Steps and Stages](#) in the Awakening process, and why [Falon Gong](#) is suppressed. The Zetas talk about how aliens will [Walk Openly](#) among us in due time; what they would like us to [Tell Others](#) about them; why there are [Language Barriers](#); and whether aliens are [Hanging Around Saturn](#) or living on the [Moons of Mars](#). The Zetas talk about why [Stanton Friedman](#) should be taken seriously; how sightings such as the [Belgium Flap](#), the [Gulf Breeze](#) sighting, the original [Mexico City](#) incident, [Russian Sightings](#), and the [Israeli Sightings](#) were real; why the [Colorado Flap](#) was staged, sightings reported by [CSETI](#) are false, and how [Dr. Greer](#) got cancer; what [Dr. Reid](#) hoped to accomplish; what is different about [UFO's in Africa](#); why [Mt Shasta](#) is a UFO haunt; and why humans hoping for contact cannot [Call Down a Ship](#) or influence the time of a [Mass Landing](#); how [Crop Circles](#) give us [Crop Circle Clues](#) and what meaning [Circle Locations](#) and the [Crop Circle Video](#) or [Crop Circle Hoaxes](#) or [Renewed Circle Hoaxes](#) or [Future Circles](#) and the [Windmill Hill](#) circle. The Zetas talk about circle clues such as [Crop Circle Correlations](#), [2003?](#), [Swept into Disaster](#), [Tilting Leaning Dropping](#), [Orbit Lock](#), [Magnetic Trimesters](#), [Crop Circle Language](#), [Magnetic Resonance](#), [Flow Lines](#), [Serpentine Dance](#), [Slow 270° Roll](#), [Buzz on Out](#), [Asymmetrical Affair](#), [Ready to Tip](#), [Juxtapositioned Planets](#), [Not Nuclear](#), [Time Line Clues](#), [Mirror Ecliptic](#), [Reminder Circles](#), [#2](#), [#3](#), [#4](#), [Hoaxes](#), [Contorted Path](#), [November Reality](#), [Circle Simplicity](#), [2005 Season](#), [2005 Circle Trends](#), and [2006 Season](#) with [Magnetic Clash](#) and [2006 Hoaxes](#) and the [2007 Crop Circles](#).

The Zetas talk about [Why They Care](#) and describe the [Zeta History](#) on their Awakening and why [ZetaTalk Predictions](#) are a truth test; how they want to ensure that people will not fall prey to [Disincarnate Opportunists](#) wanting to be walk-ins; and whether there is myth or truth in what [Annunaki](#), [Ashtar](#), the [Confederation](#), the [Council of Nine](#), [Ma-Di or DOMA](#), the [Ummo](#), the [White Brotherhood](#), or the [WingMakers](#) are saying or whether these alien groups are in and of themselves a fraud. The Zetas talk about whether [Billy Meier](#) is a contactee or the [Andromedae Contact](#) is from Andromedae and [Scallion](#)'s source; whether the aliens in Whitley Strieber's book [Communion](#), the face drawn by [Steve Neill](#), and the encounters reported by [Ruth Montgomery](#) are real; why the [Hopi Indian](#) myths and [Lou Famoso](#) NDE

and [Hercolubus](#) prophecies are valid; whether the [Beatles](#) had a role or the book [Celestine Prophecy](#) is inspired or [Way of Explorers](#), [Far Journey](#), [Cosmic Voyage](#), [ET 101](#), or [Secret Vows](#) are based on fact; whether reports from the [Farsight Institute](#) or [Commander X](#) or [Phoenix Group](#) or [Leading Edge](#) or [David Icke](#) or [David Booth](#) can be trusted; whether the book [Chariot of the Gods](#) or the TV series [Star Trek](#) or [Dark Skies](#) or [Taken](#) or [10.5](#) or [Discovery Channel](#) or the movies [Fire in the Sky](#), [Stargate](#), or [ID4](#), or [When Worlds Collide](#), or [Signs](#), or [War of the Worlds](#) reflect real situations; whether the writings of the [Theosophists](#), [Seth](#), the [Urantia Book](#), the [Akashic Records](#), or [Elizabeth Clare Prophet](#), or [Baird Spalding](#), or [Sylvia Browne](#) can help mankind figure it all out; whether [Ramtha](#), [Barbara Marciniak](#), [Alexander](#), [Sheldon Nidle](#), [Barbara Clow](#), [Lysa Royal](#), [Sollog](#), [Jelaila Starr](#), or [Anna Hayes](#) are true channels; and why [ZetaTalk Accuracy](#) is ensured.

All rights reserved: ZetaTalk@ZetaTalk.com

Weekly Chats on the Pole Shift ning Archives

The weekly chats, Q&A sessions, have switched to the [Earth Changes and Pole Shift ning](#). Answers to the questions posed during the week will be posted by noon Saturday, EST. Questions posed will be selected based on relevance and whether the answers already exist within the body of ZetaTalk. Rules apply. Nancy was live on [GodLikeProduction](#) every Saturday night, from Nov 12, 2005 through May 15, 2010. The [GLP indexed archives](#) and content from those chats is available. The Zetas and Nancy are very [grateful for the support](#) Trinity and his crew of mods at GLP gave during these years. The archives from [IRC live chats](#) between Nov 2001 and May 2003 are also available.

When	Where	What
Feb 11, 2012	Ning Address	(Answers posted by noon on February 11)
Feb 4, 2012	Ning Address Nuclear Call Answer Archive	Nuclear call, Obama bridge plan, Earth sounds significance, Contactee counts, Patagonia tall people, Bolivia floods, Russian plans, Wobble weather, Korean ship explosion, USGS roles, New Zealand interest, Spielberg's dilemma
Jan 28, 2012	Ning Address Answer Archive	Extinction Protocol website, Chile hot earth, Beijing floating hominoid, Aftertime food production, Extinct Protocol comments scheme, Kerry's black eye, Lincoln during State of the Union, Solar Flare excuse, Magnetosphere twisting incidence, Scale changes, Buoy data suppressed, Iran boycott
Jan 21, 2012	Ning Address Answer Archive	Costa Concordia cruise, Planet X viewing, Survival Site cautions, Earth moans, Plate movement proof, Nibiru on Russian TV, Chile in Antarctica, Wobble winds, Element of Doubt, Moon shape, SOPA, Hong Kong whirlpool, India sinking, Nepal glyphs, DNA databases, Cartagena hot earth
Jan 14, 2012	Ning Address Answer Archive	James Forrestal, Bell Witch legend, Rotation Stop gravity change, Costa Rica drums, Thailand river blockage
Jan 7, 2012	Ning Address Answer Archive	Norway stretch, Codex Alimentarius, Food hoarding
Dec 31, 2011	Ning Address Answer Archive	Last Weeks counting, Telepathy distress, Magnetosphere torque, UFOs and debris, Wobble clouds, Warm winter, Mariana Trench collapse
Dec 24, 2011	Ning Address Answer Archive	Philippine tsunami, Transmigration of soul, Wave cloud shape, Sloshing buffer, CNN hints, Smog increase, Two Moons campaign
Dec 17, 2011	Ning Address Answer Archive	NASA misquotes Nancy, Michigan natural gas, Newt Gingrich, Australia floods, Ohio fracking quakes, Netherlands flooding, Africa re-colonization, Ancient alien warnings, 2012 agenda
Dec 10, 2011	Ning Address Answer Archive	Senate Bill 1867, Gun control, Tbilisi UFO, Venus writhing, FEMA camps, Mercury UFO
Dec 3, 2011	Ning Address Answer Archive	Prince Charles in Romania, El-Baradei in Egypt, Olsen photo captures, Winged Globe on SOHO
Nov 26, 2011	Ning Address Answer Archive	Australian prison camps, Mars missions, Christmas Hammer, Annunaki bones, European missile sites, 2012
Nov 19, 2011	Ning Address Answer Archive	Drug Resistant germs, Iodine 131 in Europe, Trans Pacific Partnership, Neutrino assassination, Rift/Zapper machines, Apec Travel Facilitation, Iran missile sites, G20 Cannes Summit, Zhitomirskiy suicide, China desert grids, Europe in receivership, Shenzhou-8 blue orb, Uranium deposits, Brazil CC, Cuzco mummy
Nov 12, 2011	Ning Address Answer Archive	Antarctica ice, Emergency test, Disclosure denial, Seismograph patterns, Phobos probe, Red Dust effects
Nov 5, 2011	Ning Address Answer Archive	Bolivia pinch, Elite in Africa, Wobble pace, SE Asia borders, Rockies safety, Pakistan safety, Ocean debris
Oct 29, 2011	Ning Address Answer Archive	Venus looming, Wasaga Beach dead birds, Auroras, Commonwealth conference, Google Moon rovers

- Oct 22, 2011 [Ning Address](#) [Answer Archive](#) *Balloon captures, Drone keystrokes, Red dust on Moon, Seattle bridge, Good Samaritan reluctance, 7 of 10 progress, Gaddhafi's death*
- Oct 15, 2011 [Ning Address](#) [Answer Archive](#) *Yakutia boilers, Japan south island quakes, Black Knight satellite, Flooded cities, Automatic writing, Carbon Footprint taxes, NASA's timing, Rena oil spill, Jell blobs, Utah slide*
- Oct 8, 2011 [Ning Address](#) [Answer Archive](#) *NASA press conference, Market collapse, Seasons blending, Fuji springs, Elite preparations, Pharma inventories, C2C return*
- Oct 1, 2011 [Ning Address](#) [Answer Archive](#) *Blackouts and debris, Canary Island quakes, Planet X viewing, Near Death Experience, Norway vortex, Tiangong-1 module*
- Sep 24, 2011 [Ning Address](#) [Answer Archive](#) *Florida awash, NASA's Tatooine, NWO under attack, Cover-up assassinations, Obama in Denver, Sub-Sahara Africa, Rebuilding civilization*
- Sep 17, 2011 [Ning Address](#) [Venus/DT Looming](#) [Answer Archive](#) *Venus/Dark Twin looming, 7 of 10 Russia impact, ET intervention reaction, Fiji crimes, European weather, Star Child population, NASA satellite excuses, 7 of 10 scenario interplay, Caribbean investors, Sinking cover-up, Subtle message*
- Sep 10, 2011 [Ning Address](#) [Answer Archive](#) *Israel, Mexican drug trade, 7 of 10 land skews, San Diego grid down*
- Sep 3, 2011 [Ning Address](#) [Trumpets and Howls](#) [Answer Archive](#) *Tampa Bay howler, Neglected safe locations, Arizona, Boston, Blue Kachina, Sea of Azov landrise, Star Child increase, Elenin breakup, Thor, Cover-up history*
- Aug 27, 2011 [Ning Address](#) [Wobble Sloshing](#) [Answer Archive](#) *Wobble sloshing, Ireland elevation, N Korea agenda, Bahamas, Contactee rash, Japan seabed fissures, DC/CO quakes, ISS supply crash, East Coast migration*
- Aug 20, 2011 [Ning Address](#) [Answer Archive](#) *Kiev trumpets, Australia elite plans, Self sacrifice, STS children, North Sea oil leak, Siberian cities, New Zealand Coriolis, Madrid flooding, East Coast tsunami, Windsor hum, Working for money, Fukushima lessons, Jubilee CC key*
- Aug 13, 2011 [Ning Address](#) [Answer Archive](#) *Orange goo, Barter evolution, Boston exercises, London riots, Transformation teams, Magnetic field CC, Chinook crash, Lake Vostok anomaly, Rio Grande do Sul, Alberta future, STO percentages, Eastern Russia, Japan quakes, N Dakota floods, Americas map*
- Aug 6, 2011 [Ning Address](#) [Pisgah Panic](#) [Answer Archive](#) *Pisgah plume, Norway coverup, Cable wobble, Pisgah plumes, Denver vs 13575, China high speed train crash, Brazil stretch, Snake CC, Snake Moon Swirl, Global shudders*
- Jul 30, 2011 [Ning Address](#) [Answer Archive](#) *Ohio, Oslo massacre, 7 of 10 Estonia tsunami, STO timidity, Bakken oil field, US Debt, Sao Paulo UFO, OSCE agenda, July CCs, Buryatia rift, Aftertime borders, Crop shortages, Alaska drilling*
- Jul 23, 2011 [Ning Address](#) [Answer Archive](#) *St. Petersburg, Obama conferences, China migrations, Aftertime jet stream, Intelligent water babies, US debt crisis, Israeli war mongering, Executive Order 13575, Sweden UFO tracks*
- Jul 16, 2011 [Ning Address](#) [Answer Archive](#) *New Zealand overture, Steven Frayne magic, West Coast volcanoes, ISS future, Looming Venus, India temple secrets, Murdoch scandal, Mt. Adams, Gullibility, Michigan UFO, Media exodus, Earth orbit, Spiral CC*
- Jul 9, 2011 [Ning Address](#) [Answer Archive](#) *Chavez cancer, Barbury CC, Queensland for sale, Obama's assassination, Ural bunkers, Athens, Elite migration, European aftertime, 7 of 10 pace*
- Jul 2, 2011 [Ning Address](#) [Answer Archive](#) *Telegraph UFO, California flood history, Dogma, Gryfino trees, Rugby invitation, Kobuk sand dunes, Ardennes safety, Economic status, Chavaz, Radar circles, Red dust Los Alamos fire, Cornwall tsunami, Mauna Kea light bubble*
- Jun 25, 2011 [Ning Address](#) [Answer Archive](#) *China Anhui mirage, Aftertime fishing, Hurricane season, Vancouver riots, Tbilisi photo, N American deserts, Russian CC, Al Gore's role*

- Jun 18, 2011 [Ning Address](#) *Aftertime wind speeds, Pacific heap, Dogman myths, European tsunami warning, Bilderberg 2011, Eritrea blackout, Wobble flooding, New Madrid vis USGS, Ahmadinejad prediction, Hungary flooding, Newt Gingrich*
[Answer Archive](#)
- Jun 11, 2011 [Ning Address](#) *ZetaTalk fame, Puppet Master media, Planet X capture, Lake Tahoe, Hot springs, Norway, Singapore, Mermaids, China invasion*
[Answer Archive](#)
- Jun 4, 2011 [Ning Address](#) *Altai mountains, Obama's UK visit, Sanctuary CC, Haiti/Honduras presidents, East Asia summit, Planet X video, Argentina Cordoba mountains, Hackpen CC, Netherland/Russia CC, Subconscious confusion, Ecoli in Europe, Tornado increase, Territorial conflicts*
[Answer Archive](#)
- May 28, 2011 [Ning Address](#) *Contrail glow, National Geo aliens, Russia migration, Queen's agenda, The Event, Planet X position, Almaty UFOs, OSIRIS-Rex agenda*
[Answer Archive](#)
- May 21, 2011 [Ning Address](#) *Media cover-up, IMF arrest, Lightning storm, Crimea UFOs, Montana, Zeta Tape 06, Rogue planets, Crop Circles, Indonesia status*
[Answer Archive](#)
- May 14, 2011 [Ning Address](#) *Human craft, Aftertime assistance, Cosmic ray hotspots, Hot springs safety, Rain confusion, Skinny Bob reaction, Swiss franc, Flood induced quakes, Dark Twin CC, Japan tail lashing, PLAN device*
[Answer Archive](#)
- May 7, 2011 [Ning Address](#) *Shuttle launch failures, Bin Laden death, Zeta video, Global threat ploy, Real estate changes, Einstein's gravity theory, Aftertime gardening, Shape-Shifting reptilians*
[Answer Archive](#)
- Apr 30, 2011 [Ning Address](#) *7 of 10 quake timing, 7 of 10 dipping sinking, 7 of 10 Mexico participation, Union busting, Art and Architecture, Blood types, Fake alien videos, Colorado UFOs, Sputnik signals, Police crackdowns, Aftertime starvation, Holland CC, Africa takeover, Asteroid excuse*
[Answer Archive](#)
- Apr 23, 2011 [Ning Address](#) *Moon madness, Happiness, Whirlpools, Tail debris, Mercury, Japan radiation, S America roll progress, Alien bodies*
[Answer Archive](#)
- Apr 16, 2011 [Ning Address](#) *Water purification, C2C monster sun, STO behavior, Aftertime schools, Japan UFOs, ESA plate monitoring, Sunspots, China entertainment restrictions, Murder and mayhem increase, Asteroid excuse*
[Answer Archive](#)
- Apr 9, 2011 [Ning Address](#) *Ottawa valley, Gadafi's exit, Jumbled speech, Blue Spiral, NASA probes, Florida faults, Chicago UFOs, Japan quake flash, Pacific compress, Indonesia status*
[Answer Archive](#)
- Apr 2, 2011 [Ning Address](#) *Japan rescues, Survival motivation, Dead starfish, Star Children missions, Alien technology, New geography, Survivor slavery, Fukushima plant*
[Answer Archive](#)
- Mar 26, 2011 [Ning Address](#) *Soul growth, Sunda Plate, Turkey, Rush to safety, Puppet Master's media, Nancy's role*
[Answer Archive](#)
- Mar 19, 2011 [Ning Address](#) *New Madrid, Japan quakes, Pacific compressing, ZetaTalk fame, Cassiopaeian Org, The Call, New England quakes, Japan nuclear disaster, Newfoundland, Sinking pace, Nuclear power squeeze, Hong Kong sinking*
[Answer Archive](#)
- Mar 12, 2011 [Ning Address](#) *Riots increasing, NASA launch failure, Bush family agenda, Marquesas Islands, Comet Elenin, Radon gas, New Madrid warnings, Migrations, Georgia Guide Stones*
[Answer Archive](#)
- Mar 5, 2011 [Ning Address](#) *Pole Shift delays, German tsunami, Mexico, Taiwan Second Sun, NYC safety, Indonesia sinking*
[Answer Archive](#)
- Feb 26, 2011 [Ning Address](#) *Ontario, Philippines, Africa, Moscow UFO, NASA asteroid excuse, S America roll, Denver near miss, Africa revolution, Planet X location, Indonesia sinking pace*
[Answer Archive](#)
- Feb 19, 2011 [Ning Address](#) *Trimester effect, Brittany France, Subconscious preparations, Salt Lake condos, Montreal, Vietnam/Thailand, NYC manhole explosions, Europe overpopulated, Tyche disinformation, Blending seasons, Folding Pacific, Indonesia sinking pace*
[Answer Archive](#)
- Feb 12, 2011 [Ning Address](#) *China ghost cities, Norwegian summit, Internet future, Guarani Aquifer, New Mexico gas outages, Chemtrails, India tar pit, Pennsylvania blast*
[Answer Archive](#)

- Feb 5, 2011 [Ning Address](#) [Answer Archive](#) *Ozone, Egypt protests, Obama's message, Sinking pace, State Department conclave, Star Wars, Jerusalem UFO, Wobble effect*
- Jan 29, 2011 [Ning Address](#) [Answer Archive](#) *Seasons manipulation, Azores, Africa roll, Java CC, Moon swirls orbs, Pacific buoys*
- Jan 22, 2011 [Ning Address](#) [Answer Archive](#) *Indonesia video, Uneven sinking, China fracturing, China talks, ZetaTalk forcasts, Philippine excuses, Greenland sunrise, Cuba, Lucas ETs, Imploding buildings, GPS*
- Jan 15, 2011 [Ning Address](#) [Answer Archive](#) *7 of 10 timeline, Caribbean islands, Brazil flooding, 7 of 10 Central American volcanoes, 7 of 10 blame UFOs, Methane pockets, Rain excuse, Appalachian volcanoes, Fiji flooding*
- Jan 8, 2011 [Ning Address](#) [Answer Archive](#) *Windmill windspeeds, Dead birds/fish, Bonin Islands, Philippines sinking, John P. Wheeler III murder, Cloud signs, Chupacabra, Queensland, Israel plans, Polyjuice intent, Great Peninsula in Washington State*
- Jan 4, 2011 [7 of 10 Update](#) *Philippines sinking, Malaysia/Sumatra crumble*
- Jan 1, 2011 [Ning Address](#) [Answer Archive](#) *Saving history, Montana, Egypt, Music, Brazil, Vanuatu seismograph, Folsom Lake, British Columbia, Cell phones, Russian army, Cover-up scapegoats, Arctic sunlight, 7 of 10 shock, New Madrid effect, Gulf of Aden vortex, Gouging during shortages, Africa 7 of 10*
- Dec 31, 2010 [7 of 10 Arrives!](#) *Queensland flooding, Coral Sea bulge, Curve buoys, Caroline Plate drop*
- Dec 25, 2010 [Ning Address](#) [Answer Archive](#) *Chavez decree, ZetaTalk promotion, Gold, Indonesia waves, Scotia Plate, Saratov, California elevation, Crowd control*
- Dec 18, 2010 [Ning Address](#) [Answer Archive](#) *Tsunami frequency, 8 of 10 overlap, ZetaTalk dependency, N Atlantic rip, Call, Greenland/Iceland, Bunker living, Soul senses, Hong Kong tsunami, 7 of 10 cover-up, Mexico 7 of 10, Israeli UFO, Nuclear warning*
- Dec 11, 2010 [Ning Address](#) [Answer Archive](#) *Central America 7 of 10, X-37B agenda, Booms, STO cowards, Indonesia sinking, Altay mountains, Pakistan rip, 7 of 10 Seaway, India focus, Matt Hughes suicide, Norway tsunami, San Andreas fault, Lean to Left degrees, George Soros gold obsession, Wikileaks re UFOs, Bank bailouts, Cover-up future, Moon on SDO, Japan quakes, Brazil future climate, Arsenic microbes, Stereo deception*
- Dec 4, 2010 [Ning Address](#) [Answer Archive](#) *New Zealand faults, Planet X location, Christmas hammer, Northern hemisphere booms, Rapid climate change, 7 of 10 movement, Reincarnation encounters, Planet X 270° roll, Past lives, Planet X approach, Wikileaks, Moon Swirl locations, 43% insane, EM flux influence, 8 of 10 details, STS sentence, Element of Doubt during 7 of 10, Last weeks travel, Tilted Moon*
- Nov 27, 2010 [Ning Address](#) [Answer Archive](#) *S Africa fault lines, Quick STO lessons, East Australia lift, Fragile financial system, Canary Islands, West Coast volcanic ash, Martinique safety, Brazil quakes, Nuclear shutdown safety, Dalai Lama retirement, Migrating hoards, Hawaii, India 7 of 10, Folding Pacific, Korea confrontation, Staying behind, Kokomo visit, Michigan peninsula, Moon craters, Hong Kong, Magnetosphere eddy, New Zealand volcanoes, Changchun City*
- Nov 20, 2010 [Ning Address](#) [Answer Archive](#) *Closed borders, G20 finances, Folding Pacific, Russian quakes, Pole shift hurricane, 7 of 10 reverberations, Kazakhstan pentagram, Australia 2/3, Heroes, NASA announcement, Pole shift gloom, Africa roll, Solar Wind, LHC agenda, Karachi, Pole shift epidemics*
- Nov 13, 2010 [Ning Address](#) [Answer Archive](#) *Crust shift, Fireballs excuse, UFO highways, STO viewpoints, ZetaTalk chats, Indonesia buckling, Fluoride, Gibbs in India, Australia surveillance, California contrail rocket, Stereo satellites, Seismograph wobble, Martial law, Kazakhstan UFO, Unsparked souls, Farm land confiscation, Bush book tour, STS visitations, Indonesia pipelines, Moons on SOHO/Stereo*
- Nov 6, 2010 [Ning Address](#) *Short wave radio, Sweden, Puget Sound, Iceland, Heads of State awareness,*

- [Answer Archive](#) *Volcanoes, Indonesia's elite, China media, Low profile communities, Northern Russia, Obama Asia tour, Planet X on Stereo Behind, Seasons blending, Disclosure, Quebec, 7 of 10 Italy, Jewish culture, NASA gunman on CNN*
- Oct 30, 2010 [Ning Address](#) [Answer Archive](#) *Evil essence, Jesse Ventura, Inuit broadcast, NASA lies, Denver airport, Sitchin RIP, Interference exceptions, Born wealthy, Dependent souls, Octopi transplants, Nuclear failure, Prison gangs, Survival community size, Stockton fault, Non-interference rule, Ozone depletion, France tsunami, Light form visitations, Belarus, 7 of 10 precision*
- Oct 23, 2010 [Ning Address](#) [Answer Archive](#) *Nancy in media, Tidal bore, Krakatao, Clashing tides, Chile 33 rescue, Timeline rules, New Madrid impact, Revenge, Pole shift estimates, Glen Beck warning, Alien assists, Tribal awareness, Spiritual growth, Mother Shipton, Medicinal transplants*
- Oct 16, 2010 [Ning Address](#) [Answer Archive](#) [7 of 10 Sequence](#) *NWO plans, Magic tea, Google/Yahoo sites, Japan 7 of 10 tsunami, New Geography confusion, Aftertime children, Vigilante justice, SOHO appearance, Indonesia 7 of 10 elevations, 7 of 10 prediction, Menstrual periods disturbed, Medicine availability, N Korea dictatorship, Annunaki in NJ, 10/13 prediction, India 7 of 10 tilt, Magnetic sickness, German nuclear power, Mediterranean 7 of 10 tsunami, Plastic garbage, China 10/13 village, Webbots, 1984 movie*
- Oct 9, 2010 [Ning Address](#) [Answer Archive](#) *Microwave weapons, Safe site preparation, Lost history, Terrorism, Earthquake lulls, Asthma, Incarnations, Self study schoolhouse, STS avoidance, 7 of 10, Diaoyu Islands, Weather erratic, S American roll, Hartley 2 Comet, Red dust, Electronics protection, Unfriendly ET, Hungarian pollution spill, Rattled wobble*
- Oct 2, 2010 [Ning Address](#) [Answer Archive](#) *Sierras, Egregors, UK tsunami, New Hampshire elite, Oil from tail, Texas safety, Continental drift, Exploding light bulbs, UN disclosure, Gas line dangers, New England rise, Government leadership, Falling in Love, Moscow UFO, Last weeks CC, Mercury on SOHO, Roma explosions, Social Security threats, Japan South Island tsunami, 7 of 10 speed, Elite space abodes*
- Sep 25, 2010 [Ning Address](#) [Answer Archive](#) *Chemtrails, Owens Valley Fault line, New Grange structure, Red dust accumulation, Deagle Gulf Stream claims, Iraqi hot earth, STS soul vibes, Planet X photo, Cults, New Madrid Fault reach, Oregon safety, Angry populace, Newly dead, Herbal meds, Kazakhstan, Magnetic people, Nevada's Lake Lahontan, Birth accidents, Vatican money laundering, Soul memory, Japan tsunami, Aftertime atmosphere, Japan's Senkaku Islands, Jupiter rumors, Space debris*
- Sep 18, 2010 [Ning Address](#) [Answer Archive](#) *San Bruno Gas Explosion, European Tsunami reaction, Hand wringing, Grid survival; Mount Bugarach; Perpetual batteries; Contact etiquette, Spain as island, Compass, Wandering Stones, Colorado safety, Annunaki density, Montreal safety, Cover-up techniques, Asymmetrical crop circle, Alien message, California valleys, Media agenda, Intervention techniques, 7 of 10 reactions, Iraq safety, Boulder safety, Vladivostok UFO, Mexico safety, Saudi arms deal, Denmark refugees*
- Sep 11, 2010 [Ning Address](#) [Answer Archive](#) *Moon halos, Zeta protection, New Zealand quake, Equatorial bulge, 8 of 10, Conscious contact, Australia bend point, Uneven crop circles, Mitch Battros, Asteroid fireball excuse, 7 of 10 travel restrictions, Pole shift avoidance, Victoria sloshing, 18 hour wobble, China dancing cloud, Location analysis steps*
- Sep 4, 2010 [Ning Address](#) [Answer Archive](#) *Soul awareness, Kenai peninsula, Mississippi sinking, Zapruder face, Trimesters cause, New Zealand safety, Nazca Plate, Pakistan flooding, Tidal tables, Scotland safety, Wobble CC, Land lines, Seaway split, 14 million miles, Star Child battles, Ukraine safety, Wikileaks rape, Iraq combat end, Flip-Flop CC, STS conscious contact, STS Call, Annunaki royalty, STO vs STS body types, Los Tayos cave, Swaziland safety, Mariner oil rig explosion*
- Aug 28, 2010 [Ning Address](#) *Sunrise West, Finland safezone, Electric Universe, Ghosts, Point of Passage*

- [Answer Archive](#) *triangle, Clock crop circle, London tsunami, Mayan knowledge, Elite attitudes, New Madrid process, Below ground housing, Earth changes astonishment, Rotation stoppage polar flood, Gulf microb, Walk-in experience, Mongolia, Mount Kailash, Carbon dating, Incarnation critique, Incarnation climates, STO vsw STS influences, Nursing home survival*
- Aug 21, 2010 [Ning Address](#) [Answer Archive](#) [NASA Gambit](#) *Money, SETI, Woble crop circle, Hotspots, Superbugs, Spend Uranium, Countering NASA, Bolivia dead fish, Victoria/Mineapolis UFOs, Denmark during tsunami, Victoria tsunami, Winged Globe, African contact, Salvage post pole shift, Azores quakes, Cell phone outages, Michigan oil spill, Japan mega quakes 7 of 10 media response, Seattle booms, Australia safe locations, STS babies, Cover-up leakers, Hazy skies, Chemtrail stoppage, Guadalajara/Brandenburgo UFOs, Cloud orbs*
- Aug 14, 2010 [Ning Address](#) [Answer Archive](#) [Last Weeks](#) *The Call, Mustard Gas depots, G1.9 NASA backoff, Biobio River in Chile, Clang crop circles, Contactee pets, Phillipines safety, Trimester crop circle, NASA cover-ups, Alaska Stevens/O'Keefe crash, Simons death, Last Weeks timeline, Killing consequences, Quake proof homes, 675 foot invasion, Asteroid hits, Black Sea heating, Giant frauds, Bosnia pyramids, Hurrican season, Rattle wobble crop circles, American Indian lore, European tsunami warnings, STO rules.*
- Aug 7, 2010 [Ning Address](#) [Answer Archive](#) *Magnetosphere deforming, Contactee off-world, Alien cross-breeding, Venus blooming, Human extinction, July 20, Hybrid longevity, Second Sun placement, Heatwave crop circle, ISS safety, Aftertime Gulf Streams, STS empathy struggle, Denisova hominin, C3 CME media blitz, USGS cover-up, GPS, Slavic paganism, Jupiter wobble capture, Walk-ins, G1.9, Wobble crop circle, Gates Giveaway, Auroras, Moon Swirl photo, UFO in WWII, Obama disclosure, Child visitations, Taiwan UFO, STO voting process, Russia food exports, Simulated seasons, Unconditional love, Inbound/Outbound croppcircle*
- Jul 31, 2010 [Ning Address](#) [Answer Archive](#) *Last Weeks crop circles, Conscious forgetting, Falcon HTV-2 failure, Planet X photo, Nevada, Planet X sling orbit, Moon Swirl crop circle, Disclosure, Zeta summary, Rattle wobble crop circles, UFO near Sun, Bigfoot, Occulted Moon, Uruguay UFO blitz, White Baby in Africa, Rapper rules, Weatherman angst, TV show clues, Themis space quakes, Human race extinction, Coldwave in S America, Dark Twin, the Lift, Graduation missed, California safety, Corporate STS, Ohio safety, Karachi crash, Rattle progression crop circle, 7 of 10*
- Jul 24, 2010 [Ning Address](#) [Answer Archive](#) *Aftertime organization, Arctic fault lines, Thermosphere contraction, China UFOs, Fox News popularity, Conscious contact, DC quakes, Tangent crop circle, Civilization recovery, Portugal safety, Aftertime mental illness, Ricochet crop circle, Homeless mistreatment, Australia government, Kentucky safety, Aftertime latitudes, False faces, Quake quickening, Karachi clams, Live seismographs, Aftertime trade winds, Plate movement, Hybrid culture, Octopi worlds, Quake timing, Population explosion, Spiritual growth, Naivete*
- Jul 17, 2010 [Ning Address](#) [Answer Archive](#) *Timeline restrictions, Heatwaves, 2012 Movie as reality, New Poles lat/long, Crop Circles, Magnetic Trimester precision, Contactee guided, Eclipse sighting, Florida during New Madrid, Call priorities, Earth unchecked, Element of Doubt, FEMA plans, Pole shift fear, Spirit Guides, Channeled disinformation, Guyana safety, Contactee reluctance, Psychiatric bigotry, Verbal abilities, Cup squeeze crop circle, Humbolt ridge, Chongqing UFO, Asphalt volcano rumors, Tail during pole shift, Cup squeeze progression circle*
- Jul 10, 2010 [Ning Address](#) [Answer Archive](#) *Mississippi bridges, Survivor telepathy, NASA knowledge, Venus/DarkTwin size, Time-release contactee, Roles, New Madrid process, UK safety, Biologist arrests, Pre-shft actions, Serpentine Dance crop circles, Nebraska aftertime, Carolina clay soil, Second Sun sightings, Wobble claims, Moonraker reality, Caribbean tsunamis, Post-tide mess, Supernova remnant claims, Crop circle competition, No*

- poop diet, Continents won, Soul densities, 4th density babies, Close encounters, 4th density Human Societies, Chile safety, Hangzhou UFO, Wobble evidence, Pests, Corexi menace, Zeta projections, Arctic sloshing
- Jul 3, 2010 [Ning Address](#) [Answer Archive](#) *Moscow aquifer, Aftertime hurricanes, Second Sun capture, 30 million miles closer, European tsunami(s), India interior, Salmon survival, Extinction avoidance, Annunaki, Ufton crop circle progression, Gulf evacuation, Natural leaders, Cascade and Siskiyou Mountains, GOCE satellite, Second Sun prognosis, Trench shelter, Contactee/ZetaTalk connection, Buoy 55023, 4th density life, Telepahty, New Jersey, NASA desperation, New Madrid rupture*
- Jun 26, 2010 [Ning Address](#) [Answer Archive](#) *Human appendix, The Matrix, Switzerland tidal waves, Pole shift aftershocks, China mud wells, European tsunami reaction, Narcissism, Anchor crop circle, Ning a threat, Wiltshire crop circle, Bilderberg group, Asia migration, Karachi, Space balloon videos, McChrystal's dismissal, Moon takeover, Food shortages, Alien communities, Earth axis, 675 sea level pace, Human electrical influence, Valdai elevation, NASA attitudes, Planet X tail, India interior cities, Afghanistan resolution*
- Jun 19, 2010 [Ning Address](#) [Answer Archive](#) *7 of 10 warnings, Vibration crop circles, Australia volcanoes, Path crop circle, Poirino crop circle, Singapore safety, The Road movie, Heat waves, Hayabusa probe, Lake Champlain, Sinkhole formation, Spirit communications, Karst in Appalachia, Last weeks reality, 7 of 10 supply runs, Gulf spill oil colors, STS conversions, Japan big quakes, Chirton crop circle, Internet shutdown, Australian artesian basin, Florida climate change, Jakarta safety, New Madrid adjustment, P-waves*
- Jun 12, 2010 [Ning Address](#) [Answer Archive](#) *Planet X as shadow, Planet X complex visibility, Government normalcy, European tsunami, Polarized relationships, South Seas safety, Disembodied teammates, Polluted soil, Nuclear pollution, African Rift Valley, Aftertime compass, Planet X on SOHO, Iraq oil fields aflame, Crop Circle hoax, Great Lakes sloshing, Deep Mantle grip, Blame the Sun, Genetic engineering, Group exit, New Madrid expectations, Thunderbolts of the Gods, Stanton Freidman on Fox, Florida tar balls, Acámbaro dinosaurs, Planet X locations, Seagulls missing, Gulf spill cover-up, Ning in the media, Japan bounce, Gulf rupture, Wikileaks*
- Jun 5, 2010 [Ning Address](#) [Answer Archive](#) *San Benigno CC, 19 of 20 Contactees, Sidereal time, Israeli aggression, Colloidal silver, Dictators, Siberia methane, Aftertime communities, Guatemala sinkhole, Stopped rotation heatwave, Hopi tablets, Korean ship incident, Vince Diehl prophecies, Silbury CC, Liddington CC, Planet X shadow, Tribano CC, Last weeks sloshing, Codford CC, Hatoyama resignation, Gore's divorce, Unaware populace, 8 of 10 scope, Spinning fireball*
- May 29, 2010 [Ning Address](#) [Answer Archive](#) *Notched Pie crop circle, Planet X complex on SOHO, 8 of 10 hint, Heilongjiang province, Spiral hoax, Canada border, "Why Live" motivation, Gulf Oil scope, Mind/Soul interaction, Bronze Age collapse, NWO cabal, Rescued humans, GM plants, NASA Moon Swirl disinfo, Sudden Silence during passage, Intuition, Land ownership rights, Obama's options, Nuking the Gulf, Iraq holocaust, Politics*
- May 22, 2010 [Ning Address](#) [Answer Archive](#) *Dragon as Planet X, Hot Earth, Cracking cover-up, Canadian wobble weather, Chinese provinces, Gravity anomalies, Amateur astronomers, Aftertime health, Aftertime aliens, 7.3 week visibility, 360 day year, Species survival, Aftertime axial tilt, Australian coastline, Volgograd bridge sway, Sinkholes*



[Mail this Page](#) to a Friend.

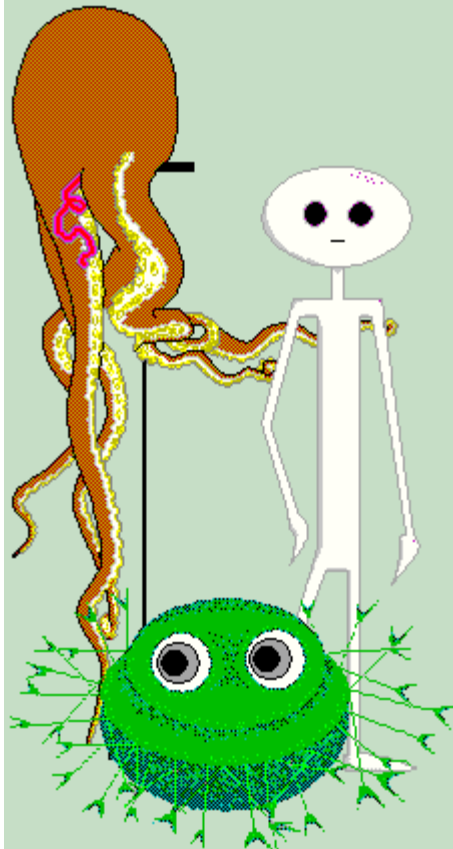

ZetaTalk: Not Alone

Note: written on Aug 15, 1995

The microcosm that is Earth first appeared to humans as the center of everything. The babe, in his mother's arms, proceeds on the same assumption. She is there for his needs, solely. We hesitate to broaden our perceptions because this minimizes the self. Mother does not exist solely for me, therefore I may go unattended. Father chats with the other children, therefore I have not captivated his attentions and may go unnoticed. And in like manner we follow the child into adulthood to discover the human species grappling with the concept of not being alone, the one and only. There are other intelligent species in the Universe, therefore I am not God's crowning achievement. They can levitate and zip about and disappear, therefore I am a technological dummy. All very deflating, especially for the pompous. The reaction is reluctance, active denial, or a pout - non-participation. Look right at the facts and fail to process them. Process them and refuse to accept the conclusion. Develop countervailing theories and attempt to substantiate them. Close all the doors and windows and develop an avid interest in a hobby. Just don't have time for all that nonsense. Well, of course, it won't go away.

Humans, adjusting to the concept that they are not alone, go through stages not unlike the small child adjusting to nursery school. They feel, ordinarily, that they are the masters of their small Universe. A cry of distress brings Mommy or an older sibling running. Throw out a beaming smile and an adult starts chirping. Works every time. Then comes the shock. The babe is *not alone*. The first reaction to the sight of a room full of competitors and a distracted Mommy substitute is to cling to Mommy. Humans, reacting to the alien presence, pray fervently. Save me! The babe may strike out at competitors, bonking another playmate, or snatch toys away for a personal horde. The alien presence almost invariably brings a cry from some angry human - leave us alone, the Earth is ours! Unable to mold the nursery to one's liking, the babe may next pout. Sit in the corner, lower lip out, glowering. Want a cookie? No! Perhaps non-participation will make it all go away. Some babes pout forever, and make it a lifelong practice. We find these humans turning their backs on evidence of the alien presence. Non-participants are the least likely to turn and become actively involved - curious and exploratory. In fact, the vocal skeptic is most likely to suddenly stop protesting and let it all sink

in. Look to the history of avid believers and one will often find a skeptic. The skeptic gives birth to the advocate.

All rights reserved: ZetaTalk@ZetaTalk.com



[Mail this Page](#) to a Friend.

ZetaTalk: Alien Presence

Note: written on Jan 15, 2002

Humans adjust to the new and familiar in accordance with its introduction during their lifetime. The babe, in its mother's arms, heard conversation, occasional banging doors, occasional howling wind, and feels no sense of urgency or alarm from the arms it lays in. Thus, banging doors and howling wind do not alarm it to the point of a faint in later life! Extend this to the crowd of children the child later runs with, the workforce peers, the leadership of the clan, or any other substitute for Mother. Where it is a known, or similar, or accepted occurrence, the human being can slot and place the occurrence, and does not react with panic.

Where the alien presence is widely known and talked about, it is presented in various ways. Contactees describe their experiences in terms that seem relatively harmless, but the elite, who do *not* want humans turning to the alien presence with any but horror and rejection, paint a different picture. Disinformation is presented as though it *were* from a contactee, an experiencer, and thus the general public is confused. Thus, when a contactee meets, for the first time, the visitors it has been longing to meet and giving The Call to, the contactee is braced for the worst! Panic, and fainting, occur when any unexpected encounter occurs, whether this be the announcement that someone in good health is now dead, or that the lottery has been won and one is now rich. Sudden and unexpected encounters cause one to faint as fainting is a protection, playing possum, which saved many a cave man from being eaten as he was assumed *dead* and thus rotten by the predators.

Thus, for the general public to become accustomed to the alien presence, and to *not* react in this manner, the Council of Worlds has determined to introduce actual sightings of aliens lifeforms, on video, for the general public to view. These sightings have already occurred by the year-end of 2001, but are discounted often as fakes. However, the increasing incidence, broadcast mostly as local news, is making the Earth's population comfortable with the alien presence. You've seen an alien? So what. Shut the door and don't slam it please, I'm busy watching the news on TV.

All rights reserved: ZetaTalk@ZetaTalk.com



[Mail this Page](#) to a Friend.

ZetaTalk: TimeTable

Note: written by Jul 15, 1995

Regarding making ourselves and our purpose evident. The timetable depends on people and how they react, their awareness and acceptance. Being aware that there are other intelligent beings in the universe, besides themselves. Welcoming this, rather than being frightened of this. They should be more curious and welcoming than frightened, quantitatively. This is already happening, in some places. There will be some places where this will become commonplace, and other places where the alien presence is not even known. The Awakening will proceed at a different pace for different peoples and groups.

All rights reserved: ZetaTalk@ZetaTalk.com



[Mail this Page](#) to a Friend.

ZetaTalk: First Impressions

Note: written by Jul 15, 1995

Adjustments to the other are an issue that is present anytime intelligent beings first meet each other. In the past, when humans thought not of creatures from outer space, they had no explanation if they caught sight of us or others from other worlds. Deliberate suppression of conscious awareness was not done in the past, or at least not to the degree done today. This is done today to reduce fear, but in the past curiosity was more often the reaction. What are those strange creatures? They simply gave us names, many different names.

On our part, we too had an adjustment to humans. Such smelly, hairy creatures, always up in arms at the slightest thing! Posturing to defend that not worth defending - the territory. Things we had put aside so long ago, ancient memories, had to be dredged up just to allow us to understand, again. One of the hardest adjustments has been dealing with the lack of understanding from humans, who in the main treat us like invaders. We are ascribed every sort of motive, although in truth those in the Service-to-Self crowd deserve the title, yet we are blamed for their deeds without even a trial. So quick to absolutes, those frightened humans. We have found it best to deal one-on-one. Where the mass rises in the direction the leader points, the single human ponders and lets the truth sink in. Pebble by pebble we build the mountain of truth.

All rights reserved: ZetaTalk@ZetaTalk.com



[Mail this Page](#) to a Friend.

ZetaTalk: Signs of the Awakening

Note: written on Aug 15, 1995

Biologists in the lab deal in closed systems and open systems. Where the experiment is to be a closed system, every aspect of the biosphere is structured, and as many factors as possible are eliminated. If one wants to document how mice react to more daylight, a longer day, one has a control group of mice where the light is fixed, and another group of mice where the light is varied, steadily increasing. All else is rigidly structured for sameness. Same food, same feeding time, same amount of food, same degree of handling by humans, same amount of cage litter - no variance at all if possible. In an open system experiment few of the factors are tightly controlled, as there are too many variables. How do two different strains of mice get along with each other, and which survives the competition for resources? Put all the mice in one large cage, vary the environment with lots of exploratory debris, vary the feeding schedule, subject the mice to extraneous noise once in awhile, and watch. The Awakening is now in an open system, where formerly closed, and several trends are already apparent.

Decades ago contactees were visited on an individual or at most family basis. Almost always, a contactee vaguely aware of this activity kept it to themselves or at most shared it with a trusted confidant. Closed system. Now contactees are meeting each other, not only in their subconscious during visitations, but in support groups, Internet chat groups, and while browsing at the book store. Government denial has become an indirect education program, religious leaders are formulating their explanations, TV and movie producers want to be on the leading edge of a media opportunity, and politicians are seen gladly accepting alien endorsements. Open system.

All rights reserved: ZetaTalk@ZetaTalk.com



[Mail this Page](#) to a Friend.

ZetaTalk: Alien Welcome

Note: written during the Nov 2, 2002 Live ZetaTalk IRC Session.

On October first of 2002, while vacationing in the Southern Chilean city of Concepcion, a group of family members found what appeared to be a small humanoid creature. The miniscule being measures about 7.2 centimeters long. It has a relatively large head, two arms with long fingers, and two legs. The discovery was first reported by Mega News Service, which is the local news channel in the Santiago area.

[Jeff Rense Site](#)

The story of EBE, at Roswell, plays like a child's bed time story to mankind, eager to embrace the alien presence they sense is present, but denied to them by their governments who have a palpable cover-up in place. The Brazilian Roswell story in recent years shows the eagerness of the populace to embrace the alien presence, children leading the way by caring for the injured aliens they discovered on their path home. Sightings of lights in the sky, UFO's, are cold comfort for those who sense that these visitors mean mankind no harm. Thus, at the slightest excuse, all manner of rumors of sightings are taken as evidence of aliens among the populace. *No* alien bodies, except those recovered at Roswell and the Brazilian Roswell, which were deliberate, are in the hands of man. However, soon enough live visitors will be at their doors, walking in the mist, and delivering help when life seems grim and hope gone. Thus, the embrace is going two ways, in the heart!

Note: added during the Feb 15, 2003 Live ZetaTalk IRC Session.

As we mentioned at the start of ZetaTalk, in 1995, sightings would be on the increase, mass sightings would then increase as the population affected became comfortable with such an event, and then sightings of alien lifeforms would occur. This has occurred, during the intervening years, most often not reported in the news. Now, however, the incidences have become so widespread, mass sightings, that it is almost common knowledge and thus, gets into the news almost automatically. The reason for this oversight on the part of the debunkers is that there is *so* much discussion that they forget *when* they are supposed to put on the brakes, or *where*. If the debunkers here this chatter during their commute, in the cafe, at the bar, in the bedroom, they just shrug and listen, knowing this to be true and choosing no comment as an avoidance. Then comes the point where a newscaster reports a mass sighting, or a local piece gets picked up and become national or international via press routes, and the debunker at first shrugs and then realizes they let it *pass*! Oops, too late now, and better to ignore it else attention will be called! Thus, you are hearing more about this in the news, where it actually has been occurring all along, in recent months and years.

Often, those who have been witness to a mass sighting, or hear about it, try to establish a *reason* for the UFO's. If there is any event, like a disaster, as with the Mothman Prophecies, this is assumed to be a warning. Alternatively, there are those who will assume the UFO's caused the event. None of this is the case. UFO's and mass sightings and mass visitations of contactees in an area are all part of the plan, to establish a comfort level with the alien presence, so that the *next* stage can begin. As Nancy reports in her [Lifeform Orientation](#) write-up, she herself was hardly comfortable with the types of lifeforms she was presented with. She reports that BeanBag Man (her term) caused her to faint for the first time in her life. She reports that recalling the BugMan, standing like a giant cockroach in front of her complete with waving antenna, was difficult for her to bring forward to her consciousness. Bear in mind that Nancy is hardly a coward, nor the fainting type, and steps up to the plate no matter *what*.

So what would the average contactee, or group of contactees, do if presented in their conscious with such sights? To prevent mass panic, or adverse reactions, they are first presented with the alien lifeform individually, to adjust. If in a group, a single bad reaction would affect the whole, so individual presentations are done routinely. When the group, be this a family or a neighborhood or small town or camping trip association, are familiar, then a conscious sighting might occur. This would be at a distance, as a glance, like the sightings of BigFoot, so no threat exists but *lots* of

discussion occurs afterwards. Thus, increased UFO sightings are part of the plan, newly into the news, and all should anticipate the *next* stage, as they may be part of this!

All rights reserved: ZetaTalk@ZetaTalk.com



[Mail this Page](#) to a Friend.



ZetaTalk: Sightings to Increase

Note: written by Jul 15, 1995

The subconscious is the heart of your awareness, and when the subconscious of the majority of your populace is comfortable with our presence, there will be no need to conceal ourselves from you. [Sightings](#) will increase, and will include alien life forms. This will then move to telepathic discussions with these life forms, en-mass with groups of people. An increasing number of photos and videos will develop, and although they will meet with the usual barrage of skeptic-bunkerisms, these photos and videos will speak to the subconscious of many. There will always be those who deny what they see. This occurs today, in your society, in all facets.

Where we and other benevolent groups speak to the subconscious, the subconscious also is cognizant of what the eyes and ears perceive. For those in denial, discord sets in. If discord dominates, then a conscious recognition of an alien ship or personage can induce fear. Should you be filled with resentment at this point over the delays, feeling yourself free of fear, bear in mind that the fear mongers are not wining, nor will they. They have already lost. Their voices have been lost in the din, and the benevolent messages are upwelling at the present time. The battle is over, but some of the stragglers have not yet left the Earth.

Where sightings are on the increase, just where and when they occur depends on many factors, only one of which is the desire of the local inhabitants to experience one. Some sightings such as the dramatic Mexico City sighting seen by thousands and video taped by hundreds, hasten the Awakening by being broadcast and highly authentic. Some sightings in remote locales occur because the majority of the residents are comfortable with the concept of being galactic citizens and ready to experience a sighting without undue anxiety. Some sightings by individuals are like the personalized sign many contactees are given, as encouragement that the path they have set upon is not a foolish one.

But likewise there are areas of the world that receive few sightings, and Muslim countries are included in this list. Where the majority of the humans have been isolated from the gossip that flows freely elsewhere around the world, and have been told that anything outside of the bounds of their tightly controlled world is of the devil, then sightings would do more harm than good. If one cannot see a woman's face, could one be allowed to see a UFO?

All rights reserved: ZetaTalk@ZetaTalk.com



[Mail this Page](#) to a Friend.

ZetaTalk: Not Just UFOs!

written Nov 28, 2005

Would the zetas like to comment on the flying humanoid videotaped in Mexico City? [and from another source] Recently I stumbled upon a website that had an archive of UFO pics, videos, and stories and is updated almost daily. After looking through, I found a few alien pictures that I believe to be real. What I found strange was that these "real" photos were posted in mid to late 2004.



We stated early in ZetaTalk that sightings would be [on the increase](#) and progress to sightings of [alien bodies](#), not just ships. We also stated that where previously photos or videos of ships almost always had failed to develop, the trend would be for photos and videos to be produced. Sightings, mass sightings, of ships have swung upward and included undeniable and dramatic captures. Examples are the [1991 Mexico City](#) rash of videos, the [1997 Arizona](#) mothership sightings, and the [2005 Prophet Yahweh](#) call down filmed live by ABC. Starting with the [Brazilian Roswell](#), where living aliens were discovered nursing their injuries in the woods by young women on a walk, there have been a number of well documented sightings. Examples are of an alien walking along a highway, which occurred in Indiana, or floating away from farmers when discovered in their fields, as occurred in Israel.

How is the public to discern a real story from a fake? General guidelines can be used. Yes, aliens can levitate themselves and float away, but this is unlikely to be their main means of transport. They will thus be sighted, or make contact, while standing on the ground on par with humans. Yes, most aliens making contact are hominoid, to ease the shock of contact, but for an alien to be captured on film the body or body type will likely be radically different from the human form, for emphasis. This is *not* a mistaken photo of a human, will be the message. Thus, photos which show what could be the form of a child, or a man or woman, are unlikely to be some of those early photos of alien bodies. Yes, a single individual might snap a photo of an alien body, but in keeping with these early photos to hasten the Awakening, these opportunities are more likely to occur in front of a crowd, or at least a group.



[Mail this Page](#) to a Friend.

ZetaTalk: Mass Sightings

Note: written on Jul 15, 1996

During the past few decades sightings have almost invariably been a personal experience, and in the main they will remain that - an individual, alone in an isolated area, a family on a camping trip, a couple standing on a balcony enjoying the star lit night. In step with the increased pace of the Awakening, sightings will become mass sightings, affecting the whole populace in crowded or urban areas as occurred recently in Australia and the Netherlands. The media will suppress the news, but they cannot prevent neighbors from chatting with one another or gossip on the Internet. The word gets out.

All rights reserved: ZetaTalk@ZetaTalk.com



[Mail this Page](#) to a Friend.

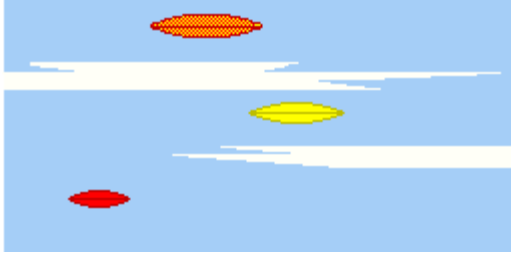

ZetaTalk: Glowing Ships

Note: written on May 15, 1997

Sightings will become more dramatic as the Awakening progresses, and this is by intent. Initial UFO sightings were of silvery crafts, hovering with apparent mastery of the force of gravity, streaking rapidly, and with the ability to change direction instantly or otherwise maneuver in a manner unlike manmade crafts. These sightings posed enough questions to those with an open mind that no further encouragement was needed. Those with a closed mind refused to believe that what others were talking about, or perhaps what they had seen with their own eyes, was anything but a manmade aircraft, a meteor, or their imagination! To encourage these humans to enter the discussion that is becoming endemic worldwide, we and others involved in the Awakening process have moved to include glowing crafts into the sightings that are increasingly occurring.

All rights reserved: ZetaTalk@ZetaTalk.com



[Mail this Page](#) to a Friend.

ZetaTalk: Mothership Sightings

Note: written on Sep 15, 1999

There are dozens of motherships hovering around Earth all the time. There are many groups visiting Earth at this time, and they all have their own craft. They are hidden from view, but will show themselves when appropriate. Indeed, mass sightings are increasing, sightings of large craft that cannot be denied because so many people see them from a distance, at angles that correlate. These people talk to each other at the local bars, if the media doesn't carry the news, and in general an area as large as one of the US states can become firm believers simply because they have shared information among extended families and coworkers. This is what happened after the Arizona sightings in 1997.

Motherships are there all the time. You simply don't see them. You can be right under one, and you won't see it. Why? Because we have distorted light rays and we give you a view of what is above the mothership, from below, so you think you're looking right through it where you are actually looking around it. If this seems amazing, think about how light rays change when they go through water. People accept the fact that they see things at an angle when they are under the water. Bending light rays is no big deal, and we do it all the time. The mechanism we use is not a gravity field. It could scarcely be gravity, as the force required would compress us to the size of a pea, and of course we would not live. We use other means, something that doesn't affect us personally. Light is a particle ray, and is influenced by many particles that are similar to it, repulsed or attracted, and we simply utilize those elements, which are unknown to man. Man has scarcely scratched the surface in an understanding of subatomic particles. We don't claim to be experts but we are far more advanced.

All rights reserved: ZetaTalk@ZetaTalk.com



[Mail this Page](#) to a Friend.

ZetaTalk: Lights in the Sky

written Oct 25, 2004

Strange beams of light are being observed in the midwest and Canada. The National Weather Service theorized that the lights were moonbeams shining through the clouds. According to the National Weather Service, it was clear at the time of the incident.



An unidentified flying object (UFO) or a divine sign were just two of the explanations residents of South Trinidad were last night speculating on after a mysterious red beam of light appeared in the sky. The vertical red line, according to some eye-witnesses, was noticed shortly after nightfall.

On Wednesday morning September 22nd, 2004 a caller rang the WTAM morning show, Wills and Coleman in the Morning, to report the sightings of strange colors in the sky. Other callers reported seeing the same thing while others tried to describe and/or explain the image. Photos from the North Olmsted Police.

L

We have gone on record, at the start of ZetaTalk in 1995, with the statement that [Sightings](#) will be on the increase, including solid photographic evidence. Would photos from the North Olmsted police videos qualify? We have stated that [Mass Sightings](#), involving large groups of people, would likewise be on the increase. That this has almost become the norm is now obvious from reports. Why are lights in the sky most often the introduction, the initiation route, informing anxious humans that there is *more* to life than the dreary drudgery of their day-to-day, *more* to anticipate than an aging body and a burden of bills that seem to become ever heavier, *more* to control events around the world than a few power mad politicians or heavy handed dictators. Man is [Not Alone](#) and his small world is about to burst into the arena of introductions to life from other worlds like a child dragged from a dark closet into a well lit room engaged in a riotous party. Lights in the sky are the introductory mode because they invariable represent, to the common man, a *distance*, a safety barrier from intrusion into their quiet life crawling about on the surface of their world. Lights are stars or planets, afar and immutable, or meteors passing, not aiming at anyone, or airplanes or satellites quite disinterested in those they pass over, so observing *unusual* lights in the sky does not at first glance incite terror. This rapid increase in mass sightings and photographic proof, at this time, has a purpose, as man is about to have his world torn apart by the coming pole shift, and as we have stated, the helping hands extended at that time, to those practicing the [Golden Rule](#) and thus firmly in the Service-to-Other orientation, may not in fact be *hands*. Fear not, you've gotten used to the idea. Remember all those lights in the sky?



[Mail this Page](#) to a Friend.

ZetaTalk: UFO's on Film

written June 3, 2004

Could The Zetas comment on the Mexico UFO sightings in the infrared. Are they helping us to become aware that they are here?

In a rash of sightings, captured on film, UFO's have suddenly moved from ephemeral objects whose film capture is elusive to indisputable objects, regularly captured on film. No less than the Mexican Air Force came forward, having been given permission by their President, to proclaim a capture in infrared. A new phase seems to have begun. Indeed, we have stated that as the populace was ready for more solid proof, ready to accept this without panic and even embracing the notion, that proof would come. The rule always, always, during the Awakening, is not to engender fear and panic as this pushes the populace toward the Service-to-Self orientation. Thus, reading behind the current wave of UFO capture on film and video, one finds increasing eagerness for contact with visitors from other worlds. In step with this eagerness is a resignation by the establishment, preoccupied with Planet X in the vicinity and no way to escape to Mars or elsewhere during the coming cataclysms. Realizing they have been duped by their allies, aliens in the Service-to-Self, they are belatedly trying to make amends. Thus, the almost tepid response to news in the media about all the sightings and film capture. Deflated debunkers, not longer encouraged.

Signs of the Times #830

Mexico Air Force Video Creates UFO Stir [May 11] <http://www.reuters.com/newsArticle.jhtml?type=scienceNews&storyID=5109891> 'The Mexican Air Force has released footage of what a UFO expert said were 11 invisible unidentified flying objects picked up by an infrared camera as they whizzed around a surveillance plane. The ministry confirmed to Reuters it had provided the video, filmed by the Air Force on March 5 over the eastern coastal state of Campeche. The film, recorded by a plane looking for drugs trafficking near the Gulf of Mexico, shows 11 objects as blobs of light that hover in formation or dart about, sometimes disappearing into cloud. Interviewed by Mausson on another section of the video, the pilots said they grew nervous when the objects, still invisible, turned back during a chase and surrounded the plane.'

[Note: see also Sign #813, the Iran UFO blitz on Apr 28, apparently a worldwide blitz occurring at this time!]

Signs of the Times #829

UFO in Scotland [May 12] 'Several people reported seeing a huge silver object in the area as they drove past at around 8.45am last Wednesday. Silver in appearance and looked like the dishes you see on the side of television transmitters. Colleagues in Cumbernauld had seen a similar object around half an hour previously, and alerted their South Lanarkshire counterparts that it appeared to be heading in their direction. Lee Close, of the Anglo-Scottish UFO Research Agency, has been investigating last week's events in tandem with the local UFO club.'

*[and from another]
Callers Report Strange Lights In Central Fla. Sky
[May 13]*

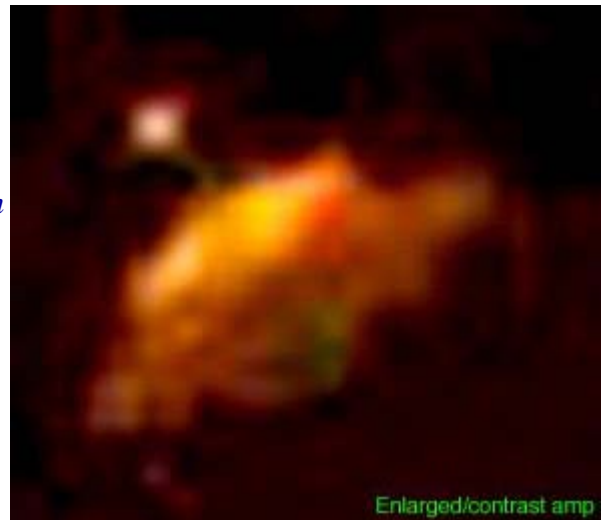

<http://www.local6.com/news/3301170/detail.html> 'Several people in Central Florida said they spotted a series of mysterious lights in the sky Tuesday night.. One resident filmed the lights in Polk County, Fla. Officials at Avon Park Air Force Station in Polk County were conducting regular exercises in the area the same night the lights were spotted. The strange lights may have been flares from the operations but officials would not release details of the operation.'

[and from another]

UFOs Reported Over South Texas Skies: Man Captures UFOs On Video [May 15] [NBC5.com](http://www.nbc5.com) 'A Texas man claims he captured the images of an unidentified flying object on his camcorder. The man from Mission, Texas, doesn't want to be identified but did say he was alerted to the object by his dogs in the middle of the night. The man said the dogs woke him up by barking and he saw the light when he went outside to investigate.'

[and from another]

Glowing UFO Photographed In Poland [May 12] <http://ufo.internauci.pl/> 'The photo [at right] was taken by J. Puskarewicz over the city of Rzeszów, Poland May 4th or 5th. Enlargement with high contrast.'



[Mail this Page](#) to a Friend.

ZetaTalk: UFO's in the News

written Jan 6, 2007

Would the Zetas care to comment on the recent report from Chicago's O'Hare Airport of UFO sightings? Was it actually an ET spaceship or just swamp gas? Also, any comments on France's space agency planning to put UFO reports on-line? Are they really going to come clean on this or just try to mislead the public?

These matters of disclosure and honesty in the media are not pressed forward so much by honest politicians and editors as by ourselves and our brethren, Service-to-Other extraterrestrials. We mentioned in 1995, at the start of ZetaTalk, that sightings would be [on the increase](#), held back only by the anxiety of man. As acceptance increased, sightings would increase. Moving from individual or family sightings to mass sightings. Moving from a lack of any documented evidence to un-refutable evidence. In the past, the establishment wanted to deny the alien presence for their own security and stature. Politicians and the Church wanted mankind to cling to them as power figures, to look up to and fear them, and were concerned about a loss of stature if the truth about the alien presence were known. Project Blue Book in the US, harassment of contactees, and suppression in the media followed. But this campaign has not *worked*. The public embraces the alien presence, eagerly. What will happen to those in the establishment long suppressing the truth if undeniable sightings, and perhaps landings with waving smiling aliens, occurs? Worse than a lose of stature, as the public will be certain that the establishment *knew* about the alien presence and attempted to keep this information to themselves. The supposed leadership the elite assumes they have over the common man will plummet. Thus, seeing they are being bypassed and the visitors are going directly to the people, with great success, such incidents will be in the news, so the establishment can try to claim they *too* have only recently become aware of it. Dragged along in the dust, as the thundering crowd rushes to embrace the alien presence!

Signs of the Times #1658

In the sky! A bird? A plane? A UFO? [Jan 1] <http://www.chicagotribune.com/> A flying saucerlike object hovered low over O'Hare International Airport for several minutes before bolting through thick clouds with such intense energy that it left an eerie hole in overcast skies, said some United Airlines employees who observed the phenomenon. Officials at United professed no knowledge of the Nov. 7 event - which was reported to the airline by as many as a dozen of its own workers - when the Tribune started asking questions recently. [and from another] FAA blames UFO report on weird weather [Jan 2] <http://www.cnn.com/> Federal officials say it was probably just some weird weather phenomenon, but a group of United Airlines employees swear they saw a mysterious, saucer-shaped craft hovering over O'Hare Airport in November. [and from another] This then was mentioned on CNN, prime time. [and from another] People claim seeing a UFO in Istanbul [Jan 5] <http://english.sabah.com.tr/> Mysterious lights seen in Istanbul skies have baffled people. Witnesses have claimed that the lights were coming from a UFO. People have called news agencies on Wednesday night and reported unidentified white lights flying in the sky. According to the eye witnesses, the flying object was revolving around itself and blazing. [and from another] Online Archive of UFO Sightings [Jan 2] <http://www.techtree.com/> Reportedly, the French space agency has decided to publish its archive of UFO (Unidentified Flying Object) sightings and other phenomena online.





[Mail this Page](#) to a Friend.

ZetaTalk: Phoenix Lights

written Feb 10, 2007

Mysterious Lights Spotted Over Phoenix, Again [Feb 7] Nearly a decade after the highly publicized 'Phoenix Light Phenomenon', more strange lights have appeared in the night sky over downtown Phoenix. Mysterious lights lit up the western skies over Phoenix and soon after, phones began ringing off the hook at radio, television and police stations from witnesses wondering what the lights were. Back in March of 1997, a huge object was spotted over parts of Arizona that many witnesses believed to be an extraterrestrial spacecraft that was drifting slowly and silently over the region. [and from another] <http://godlikeproductions.com/> Flares hang in the same place for 4 minutes? The military is lighting up targets over a populated area to target? Did anyone hear explosions? One flare at least that moves from right to left. Something does not add up here.[and from another] These videos show a similarity to the Feb 7, 1997 Phoenix Lights phenomena when compared to the recent, Mar 13, 1997, event.



There have been UFO blitzes, that hit the news, in Chicago O'Hare Jan 1, Istanbul Jan 5, Arkansas Jan 15, N Carolina Jan 25, Hawaii Jan 27, London Feb 2, and Phoenix Feb 7 lately. Note the location of these mass sightings, and then note our warnings about what parts of the globe are likely to experience disasters due to the stretch zones pulling apart and related domino quakes as adjustments occur in other areas affected.

- The St. Lawrence Seaway is stretching, a fact noted by Nancy for months lately as the Black Hills have been wobbly on the live seismographs. On days when the rest of the world is quiet, the Black Hills stands alone showing its wobble, occurring in 12 hours intervals in accordance with the tugging on the highly magnetized Atlantic Rift by Planet X, which wants this surface magnet to stay in alignment with itself. The yawing Seaway rumples the land in the Black Hills, which is why this land looks like it was thrown in the air, recently, as it was during the last pole shift and in pole shifts prior. Is Chicago exempt from the stretch? Where cities on either side of the Seaway will find they are merely riding along, it is where the stretch is *ripping* land anew that violence will occur. Lake Michigan is a clue. Why do you supposed the Wisconsin Peninsula formed? Its land was secured to the West, the weak point ripping the land under Lake Michigan, and this rip *ending* at the Chicago area.
- We have stated that Africa is turning in place, its base at S Africa firmly nailed and unable to move, the top rolling to the East as the Atlantic yaws open. This action is what is causing the African Rift to spread so rapidly, in the Afar Triangle, where huge crevasses appear before astonished eyes and the land is dropping hundreds of feet. The Mediterranean will be destabilized. The African plate is a straight line across the top, and when it turns it will create a YAW in the Mediterranean, causing volcanoes in the area to become active as lava is exposed to the surface, and certainly destabilizing countries just to the north of the fault line dissecting the Mediterranean from East to West. The Mediterranean, in the past, was a swamp, but now is a sea. What caused the land to drop? The Black Sea participated in this drop, being inundated where formerly land above water. Istanbul lies at the center of the area that will first be affected when a serious roll of Africa occurs.
- We have stated that the great Pacific is *not* one plate, as assumed, but numerous, uncharted by man who cannot

plumb its depths. We have stated that Hawaii will rise during the coming shift, as the plate it is on is pushed up while others subduct, thus giving Hawaii added protection from volcanic explosions, as their volcanoes will ooze, not explode. But Hawaii will be subject to tsunami, aplenty, devastating its coastlines. Thus, UFO sightings there, among those frolicking in the surf, are a warning.

- London also is in the stretch zone, as its many derailing tube trains attest. Any significant adjustment of the yawing Atlantic will result in further land pulls under London, and suddenly so.
- We have stated that the New Madrid is under stress, pulling apart not only from East to West but pulling the N American continent in a diagonal, the New England states moving in a NE direction while Mexico is pulled to the SW. This will do more than rip every fault line from Mexico to Ontario, it will reduce the support under land to the West of the Mississippi, dropping this land in elevation and flooding it. Arkansas, in the Ozarks, will find itself suddenly land that many seek, in their panic.
- The Carolinas were affected by the New Madrid quake, buildings needing to be stabilized, even though the rocky Appalachian Mountains were not so affected. Why is this? There is a fault line running from the Gulf up along the Eastern seaboard, and this will certainly participate in any New Madrid adjustment.

And why the anniversary blitz of Phoenix lights? Is not the flat dry desert of Arizona expected to remain relatively undisturbed, during the coming pole shift? When the New Madrid adjusts, Mexico will be too far to the West for the current comfort of the West Coast, which will bow in the Southern California and Arizona region. The fault line that runs along Mexico's West coast runs *just under* the Arizona border, then on up along the West Coast of California. Before the West Coast of the US starts adjusting to the new position of Mexico, with slip-slide adjustments, there will be a bending of the Arizona desert area that will fracture the dry soil, create a breach in the great Colorado River dam, and allow magma to rise in the calderas in the US - Mammoth Lake in California and Yellowstone. If the Hoover dam breaks, whither the city of Phoenix, which lies on flat land and near farm land irrigated by the waters of the Colorado?

Chicago

FAA blames UFO report on weird weather [Jan 2] Federal officials say it was probably just some weird weather phenomenon, but a group of United Airlines employees swear they saw a mysterious, saucer-shaped craft hovering over O'Hare Airport in November. The workers, some of them pilots, said the object didn't have lights and hovered over an airport terminal before shooting up through the clouds.

Turkey

People claim seeing a UFO in Istanbul [Jan 5] Mysterious lights seen in Istanbul skies have baffled people. Witnesses have claimed that the lights were coming from a UFO. People have called news agencies on Wednesday night and reported unidentified white lights flying in the sky. According to the eye witnesses, the flying object was revolving around itself and blazing.

Hawaii

UFO's seen over South Shore sky [Jan 27] The National Weather Service says nothing showed up on their radar at the time of the sighting and the Federal Aviation Administration didn't report anything unusual. The U.S. military conducted a missile defense test off of Kauai Friday evening but the test didn't begin until 7:20 pm.

London

UFO sighting over Islington [Feb 2] <http://www.islingtongazette.co.uk/> Unidentified flying orange objects stopped traffic and left residents staring skyward in disbelief at around 5.30 pm. Islington police informed Contact International UFO Research about the sightings. Between 12 and 15 orange lights travelling across the sky. Then they would stop and then they went upwards.

Arkansas

Air Force colonel reports lights 'not of this world' [Jan 17] <http://wnd.com/> Col. Brian Fields, 61, was cooking chicken at his Van Buren, Ark., home Jan. 9 when just before 7 pm he observed two intensely bright lights as he looked to the southeast close to the horizon. The retired colonel spent close to 32 years in the military, flying F-16s as a member of the 188th Fighter Wing of the Arkansas Air National Guard. He says the phenomenon lasted an hour and 15 minutes.

North Carolina

911 callers report lights in sky [Jan 25] Emergency dispatchers around Charlotte handle wacky 911 calls each night. But Wednesday, agencies got the same type of unusual call: A hovering light was in the sky. Others described it as a plane that might be in trouble. A blueish glow. A fire in the sky. A light moving too slow to be a plane.



[Mail this Page](#) to a Friend.

ZetaTalk: Initiation Rite

Note: written on Apr 15, 1997

For many, the Awakening is just so much joking around about aliens and space ships until they are one of many seeing a mass sighting. Suddenly it's up close and personal, and most particularly, no longer a joke. They've been *initiated*. They're now one of those special people who can speak from experience, and with mass sightings, the supporting statements of others who shared the sighting make this experience one to broadcast, not shutter. Such sightings in the past were *denied* by the government and suppressed in the media, so that the populace learned to speak only in hushed whispers to others who shared the experience. But this time around the government is if anything adding fuel to the fire by simply denying that the objects were *theirs*, and the media is granting the mass sightings coverage like never before.

Thus the return of mass sightings is stepping up the Awakening process in many countries, as the reception by those excited by their recent initiation need not be contained. Personal experiences are talked about on the bus, in the lunchroom, and are so commonplace as to no longer raise an eyebrow. This new liberal attitude toward those with personal experiences to relate, the initiated, does *more* than encourage talk about new experiences, it frees those who have long been experiencers to speak out, often for the first time. Memories suppressed due to fear of the reception are suddenly open for recall, so *more* than recent experiences are being openly discussed. Thus a single mass sighting can ignite a community, setting up an open forum on the alien presence that can not be repressed once begun. The community itself has become initiated!

All rights reserved: ZetaTalk@ZetaTalk.com



[Mail this Page](#) to a Friend.

ZetaTalk: Shared

Note: written during the Nov 30, 2002 Live ZetaTalk IRC Session.

Where most of these sightings do *not* get into the press, they nevertheless occur and ready the larger pool of humanity that is receptive to an open awareness of man not being alone in the universe, and the presence of alien visitors. Famous, of course, are the [Mexico](#) mass sighting during the Eclipse, and the mass sighting that occurred in [Arizona](#), where a large mothership was viewed by most of the state. Recently, in late 2002, some areas are being reported where earlier they were hotbeds of sightings but *not* reported widely. An example is the mass sighting, by pilots and so numerous and from various areas that no flip explanation could be given for what was seen, was reported in [Turkey](#). Lights moving at right angles, going *up* and reversing, are not a meteor or another plane, especially when reported by pilots who *know* how planes behave. The tail reported was to exemplify, for all watching, just what *direction* the object was moving, as UFO's do not have an exhaust, but did so deliberately this time.

Likewise, there are spots in [Norway](#) and Southern California where sightings happen so often as to be local folklore, not at all disturbing to the residents. What is little known is that the red deserts of Australia are frequent spots, as the local farmers as well as Aborigines are accepting. And the vast regions of [China](#), where *not* news issues forth due to the repressive regime there, have light shows frequently, and missing time those evenings much the talk in the fields the next day among those who take this as a source of pride, their involvement in these mass visits. In South America, [Brazil](#), especially since what we have termed the Brazilian Roswell, is a hotbed in spots of sightings, and missing time. When this occurs *together*, there is an unmistakable correlation in the human mind, in that the sightings and sleepy mornings the next day, and the sense that they have been a party to a visit, en mass, is strong. Thus, the light shows, in the consciousness of those viewing it, opens the door to discussions about whether one is sleepy, slept well, had an odd dream, or whatever. In the fields, the coffee shops, the local laundry, this is the talk.

All rights reserved: ZetaTalk@ZetaTalk.com



[Mail this Page](#) to a Friend.

ZetaTalk: Faked

Note: written during the Nov 30, 2002 Live ZetaTalk IRC Session.

The public is rapt and eager to hear about aliens, and the stage masters rise to the occasion! Following the *legitimate* mass sightings in Mexico in 1991, during the Eclipse, there were faked sightings reported and produced on video galore. The reason? The locals, having had a taste of well-heeled visitors to their area, staying at the local motels and restaurants and tipping well, wanted *more*. So, as we reported years ago when asked about this, the majority of the follow-on sightings were simply faked. The Brazilian Roswell, a *legitimate* report of live aliens injured and on the ground, seen by school children wandering home along a path through the woods, is being followed by faked [Abduction](#) scenes. The fakes are *clear*, as there are burn marks in the shape of a body on the bed, on the wooden wall, enough such that the human involved would have body wide burns, life threatening in nature. Not at all what contactees experience! Another report, from the [Ranch Areas](#) where cattle mutilations formerly keep visitors coming and reports in the local papers, we now hear of similar sightings. The body cannot be produced, the story told by word of mouth only, but those in the US west who hope to keep the interest up will keep it up as long as they *do* get reporters coming around. This is simply the human wish to keep a good thing going, attention, extra income, and is likely to follow in like manner the increase in legitimate sightings that will be occurring during the Awakening.

All rights reserved: ZetaTalk@ZetaTalk.com



[Mail this Page](#) to a Friend.



ZetaTalk: Power Outages

Note: written on Jul 15, 1996

In step with increased sightings will be an occasional [Power Outage](#), as where there are those who can deny a sighting no matter how dramatic and well documented it is, there are few who can deny massive power outages. As they affect a broader audience, power outages are timed and placed for maximum impact. There is no point to a power outage that affects only a rural area with a small or isolated populace, or to a power outage that might occur in the middle of the night when few are awake to notice it. But beyond these considerations, power outages during the Transformation will be timed to act as an exclamation point to other messages given.

The establishment movie ID4, scheduled to premiere on July 4th in the US, premiered early as those who would give a false message to the populace, telling them that mass landings could occur and their only hope was a tight alliance with their government and established leaders, were eager to begin their propaganda. Those aliens in the Service-to-Others who deplore such lies for their tendency to create fear and a sense of isolation in humans, thus driving them toward the Service-to-Self orientation, determined to sound a different note. Thus a massive power outage in the middle of the day over the western half of the US was effected to coincide with the ID4 premiere. If aliens could mass land at will, then when they are about in such numbers and with such power, why do they not land? A countering message.

All rights reserved: ZetaTalk@ZetaTalk.com



[Mail this Page](#) to a Friend.

ZetaTalk: Alien Bodies

Note: written on Sep 15, 1996

A recent trend in the deliberate Awakening of the populace has been the supposed discovery of pictures of dead aliens. Following the Roswell autopsy film a rash of such pictures have emerged. This is not by accident, and is more than just copycat behavior. Such pictures are deliberately being placed before the public to acclimate them to the concept of visitors from other planets and the odd appearance that might be expected. Since rioting in the streets did not occur as a result of the release of the Roswell autopsy footage, a carefully staged fraud which was intended from the start to be discovered as such, those who would have the Awakening proceed post haste have encouraged other such nudges. Accordingly a rash of pictures have come forth, all showing aliens in the most vulnerable of positions - dead, injured, and lying on the autopsy table under the knife of human scientists.

Still pictures of dead bodies are easy to produce, as any film maker will confirm. Most of the dead alien photos are a combination of real human bodies or body parts, augmented by putty or burns, thus the semblance of realism. If living children are sold into prostitution by their parents around the world and the elderly abandoned, how easy would it be to purchase the bodies of dead children and aged? Crematoriums are another source of such bodies, as one urn of ashes looks much like another, and how would the family know otherwise? These dead bodies, all hominoids and none larger than the average human, are to acclimate the populace to the concept of intelligent visitors from other worlds, while reassuring the populace that such visitors can be killed in crashes just as humans are killed on the highway. The intended message is that aliens visitors are not that much different from humans.

All rights reserved: ZetaTalk@ZetaTalk.com



[Mail this Page](#) to a Friend.

ZetaTalk: The Word

Note: written by Jul 15, 1995

Many humans who gain an understanding of the Transformation and its components feel impelled to get the word out to others. Should others not become aware as quickly as possible of the pending pole shift, the spiritual choices to be made, and the presence of galactic citizens in their midst? They are concerned that failure to act, to broadcast this information, represents a dereliction of duty on their part and fret over how best to proceed in the face of resistance.

Is this necessary? Is this possible? And whose responsibility is this? This is certainly not the responsibility of those humans who personally become aware. Each human who desires this information can and does give The Call and thus receives a personal explanation. But what of those humans who, held in ignorance by a reluctant media, have not had their curiosity stirred? Here also we assume responsibility, by limited sightings or visitations to start the ball rolling. Likewise, issues of spiritual choices are not so much made based on knowledge that such choices exist, but on the steady resolution of issues in one direction or the other. The entity sees the trend, and watching others, realizes the choices that are possible. Should the pending pole shift be loudly announced to warn humans of the many changes their lives will undergo? Any publication would meet with active resistance, such that the volume would mount to meet the challenge. Truth of this matter will not be carried home to humanity by the media, much controlled by the establishment, but by the Earth itself, which will present changes for all to see and none able to explain away.

Therefore, speak to those who will listen, but do not be concerned about numbers.

All rights reserved: ZetaTalk@ZetaTalk.com



[Mail this Page](#) to a Friend.

ZetaTalk: Arizona Coverage

Note: written on Jul 15, 1997

The first mass sighting to get full coverage in the media was the large and undeniably alien object seen by thousands in Arizona in March, 1997. Distinctive for its *size*, which could *not* be mistaken for a satellite or shooting star, this slowly moving and hovering gargantuan ship could only be a mass hysteria or an alien ship. Since the observers did not consult with one another, mass hysteria simply would not fly as an explanation. More remarkable than the sighting and the thousands who observed it was the reaction by the media, which reveals the extent to which the media is controlled on matters of the alien presence.

Where windstorms that blow shingles off roofs are reported on the front page, what excuse does the media have for *not* reporting on a sighting that absolutely *proves* that the alien presence is real! Lack of witnesses? There were thousands. Lack of credibility? They had videos. A hoax? What could hold a ship the size of several football fields in the air, for over an hour? An illusion? The sighting was visible all across the state, and a projected image, one placed against background stars, can fool only those situated at the right angle. Was the delay due to examination of the evidence and interviewing witnesses? The media traditionally operates by reporting first and issuing corrections later.

What caused the [Delay in Reporting](#) this astonishing sighting was not any issue with the evidence or witnesses, but conflicting orders from MJ12, often itself in conflict over how to proceed. Traditionally the media has been told to clamp shut on *all* sightings, and proceeded with this approach automatically in Phoenix. Orders to the contrary were questioned, and double checked, and when confusing confirmations were issued by MJ12, double checked again and again. Better to be safe than sorry, especially since a story once aired cannot easily be retracted, as Roswell so amply demonstrated. MJ12 operates like most intelligence organizations operate - on a need to know basis. Thus many in the ranks were slow to hear the new marching orders, and contradicted their leaders.

All in all, a mass sighting that pleased those producing the extravaganza as much as it pleased the majority of the audience, and one providing a second extravaganza, though one must read between the lines to see it. This second extravaganza is the international cover-up, which has been in place since Roswell and affects *all* major media outlets, bar none. In stark exception to the normal media reaction to truly newsworthy items, the media became catatonic for three months, and *then* found its voice! Please note, world, the best evidence for the cover-up has just been handed to you on a platter!

All rights reserved: ZetaTalk@ZetaTalk.com



[Mail this Page](#) to a Friend.

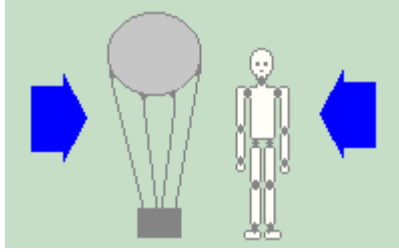

ZetaTalk: Roswell Revisited

Note: written on Jul 15, 1997

Concurrent with the 50 year anniversary of the Roswell episode there have been dramatic sightings world wide. The most notable, due to its media coverage by CNN, was the Phoenix sighting, but this was *not* the only dramatic sighting. The others suffered the usual media suppression, but the local populace talked among themselves nonetheless. The Roswell coverage was considered safe by the suppression advocates, as various stories countering the truth had been concocted and issued. Thus, the public will have, as usual, a blitz of information to sort through. For those willing to allow themselves to consider the truth about Roswell, there will be a breathtaking array of fresh evidence that the alien presence *exists* to give the truth a boost. This was, as you say, not an accident.

All rights reserved: ZetaTalk@ZetaTalk.com



[Mail this Page](#) to a Friend.

ZetaTalk: Demand for Proof

Note: written by Jul 15, 1995

You will find, as the awakening to galactic consciousness proceeds over the next few years, that the demand for proof of our existence will increase rather than decrease. You will also find, in line with what you have already experienced, that there will be no amount of proof that will satisfy these demands. Proof stands before the world today. Crop circles and their residual impact on soil and vegetation, mass sightings, disappearing pregnancies. When one gets into the game of proof, one is speaking to the wrong people. Do you have any doubts about the extent that people in denial will go to? Speak to people accused of horrific crimes against their loved ones. It didn't happen. It most certainly wasn't them. Homo Sapiens, as with most intelligent species, has the capacity to argue against unpleasant facts. As the unpleasant nature of these facts increases, so do the arguments.

Have you heard the argument that the majority of a teacher, or parent, or manager's time is spent on the troublesome? This is certainly true of the efforts of the police, who are a corps only because of the troublesome. The troublesome are few, but receive almost all the attention. We take a different approach in our contacts with humans. We ignore the troublesome, as they make their own bed, spiritually speaking, and must lie in it. In addition, the troublesome don't hinder our efforts. We are beyond their reach. We communicate with those who will make a difference, who are either currently dedicating their lives to worthwhile efforts or will presently do so. We direct our efforts to those who share our goals.

Of course, if we were to give humanity absolute proof, there would be repercussions. It is rather deliberate that the press of information that you are not alone as intelligent creatures in God's universe is very gradual. It is not by accident that toys, TV shows, and everyday conversation in the workplace talk about aliens and have alien figures, and that this is casually accepted without fear. This is because this has been slowly interjected. Were there to be aliens marching down the street or appearing on TV next to the President of the United States, there would be heart attacks, there would be savage attacks most certainly against those individuals who are contactees. They would be torched, shot, or stoned as Pat Robertson has suggested, and it would not be a good scene.

Be advised that the rules in place guiding our contact do not allow us to dance in the skies at your command. They do not allow us to manipulate your reality so that you can claim confirmation of our existence. You need not look far for proof of these statements. It is common knowledge that photos and videos that would be too staunch in their veracity simply do not develop. Likewise, the only physical evidence of alien biological existence or technology is in the hands of your government and other governments in alliance with your government on the alien issue. If this seems to you to be a double standard, it is. How the Transformation and the Awakening is happening on your Earth has been very carefully thought through, and there are definite rules to abide by.

All rights reserved: ZetaTalk@ZetaTalk.com



[Mail this Page](#) to a Friend.

ZetaTalk: Discord

Note: written on Apr 15, 1996

Human society, like all societies, has microcosms within microcosms - different groups with different viewpoints. Christians may belong to any one of a dozen or more churches, each of which may have liberal or conservative sections, and a liberal group in one such sector may not be the same as another liberal group just across town. During the Transformation, with increasing polarization of groups, these differences will only accentuate. How does the diversity within a society affect its Awakening? Surprisingly, diversity speeds an Awakening along, as there is *less possibility* of a single viewpoint becoming dominant. However, diversity creates discord, and in this respect differing opinions or stances on becoming a galactic citizen result in just as much discord as differing religious views or differing political affiliation or the gulf known as the generation gap.

Attitudes toward the Awakening, today, range from total denial to joyous embracing. Denial ranges from refusal to admit the possibility to educated skepticism. Those embracing the Awakening range from unquestioning acceptance, come what may, to selective affection and a hesitant handshake. Diversity will only increase, and concurrently discord will increase, as the Awakening proceeds.

Note: below written during the Jan 11, 2003 Live ZetaTalk IRC Session.

[EuroSETI](#) recently announced that it will be publicly screening some extraordinary satellite images gleaned by a Spanish-based team using two space-based satellites, images that are distinctly 'craft-like' in appearance, and which defy explanation. EuroSETI reports that NASA initially tried to explain the images away as pixel faults, passing meteors or asteroids, etc., but when a European-led consortium presented them with images that clearly were none of the aforementioned, they 'clamped up'.

Shift2003 Chat

As with the Clonaid attention in major media, far outside the usual attention that alien hugging groups get, this is another example of various parts of the establishment hoping to open *up* the Transformation to get more assistance from aliens. There have been several competing and conflicting forces during the past few decades, since Roswell.

The **Hug-Humans** thrust

which states that aliens are evil, cannot be trusted, are out to colonize the Earth and eat or enslave mankind, and that only by *resisting* visitations and hugging your governing bodies, your military, your church, will you be safe.

The **Hug-Aliens** thrust

which states that the visitors are benign space brothers, here to help us during hard times, and if the Earth gets in a crunch such as a pole shift will lift all away to safety and some magical life on another planet or on a space ship.

The **Hug-Reality** thrust

which points to past pole shifts or current problems such as starvation and disease that mankind deals with, no rescue there, and the *lack* of a mass landing to colonize Earth, as evidence that neither Hug-Humans or Hug-Aliens above are correct.

Enter the establishment, which is composed of the wealthy, powerful politicians, and church leaders, not all of whom are logical thinkers. It was known that Reagan, while President, consulted a psychic, and the odd behavior of *many* notaries would astonish the populace should the truth be known. Pressed to remain on Earth, no escape to Mars, and fearing their underground caverns *not* to be safe during violent earthquakes, the establishment is looking with horror toward the possibility of a pole shift. Might they have to experience it, like the public they have misled and used and had *no* intention of informing? Since the Earth changes have played out as we predicted, and the inbound planet is

approaching in the manner and rate we predicted, many in the establishment are reading our words desperately for a way to *avoid* what they were so happy to allow the general public to experience. In other words, how can they *escape*! In that we have stated that if 89% of the populace were Service-to-Other, the Transformation to 4th Density physical could occur even before the shift, allowing an escape from the shift, this is one route. However, how to force the some 50% of the populace to accept this philosophy, when guided by those in the establishment who can't even entertain the proper concepts? Not feasible. Another, more likely, scenario, is to have the populace *accept* the alien presence, embrace it, and thus with aliens walking about on the face of the Earth, ignoring the plight of mankind would be embarrassing and they'd step in and effect a rescue, or so the logic goes.

Thus, you see groups Hug-Humans, and Hug-Aliens above, clashing. Clonaid gets on CNN, on Crossfire, where aliens have *never* been the focus before. Expect more entertainment as the shift approaches, from an increasingly desperate and shrill establishment. Images of space ships is not *new*, and NASA has endless images to access. A fight between tight allies, such as Spain and NASA are, is staged, with the intent that *both* parties, Hug-Humans and Hug-Aliens, would be happy.

All rights reserved: ZetaTalk@ZetaTalk.com



[Mail this Page](#) to a Friend.

ZetaTalk: Disprove the Proposition

Note: written by Jul 15, 1995

Disproving the proposition can often be impossible, given the parameters. How many angels are their on the head of a pin? How long is a day 12 light years hence? How many life times does the average human repeat? These matters cannot be settled, in human terms, and thus cannot be proved or disproved. Such is the situation where matters on the alien presence cross the human desire for control. This is a multifaceted confusion. There are aliens in the Service-to-Self orientation that can wield deception better than the most practiced human. There are humans in establishment positions who will cloud the issue endlessly, as long as they can stay in control. There are humans who desire to profit from the alien issue, and cook up scenarios and roles for themselves as long as there is an audience. Where does the truth lie, and how can the truth be proven?

Unfortunately, this is not a matter that can be quickly put to rest. The issues at play are many, and involve the free will of man, the engagement rules that govern alien interaction with man, the engagement rules that govern alien interaction between orientations, and the mutability of truth itself. Different people see truth in different ways.

In all of this rises the issue of whether a given alien message, such as ours, is truly from ourselves or Nancy's imagination or government psychics. How can this matter be proved? It cannot. Psychics can insert themselves into others thoughts. Imaginative humans can and do concoct intriguing stories. And the truth can be before you, unrecognized and even rejected. It is for you to judge, listening with your heart and pondering with your mind. And when you have determined what is true, for you, then this you should hold to. It is, at essence, a matter of faith.

All rights reserved: ZetaTalk@ZetaTalk.com



[Mail this Page](#) to a Friend.

ZetaTalk: Info or Disinfo?

written Mar 11, 2005

Who is Sorcha Faal? Posting on [whatdoesitmean.com](#) as did David Booth. At first quoted IndiaDaily as a news source, but IndiaDaily is a web site in New Jersey run by a single guy, not legit, claims about aliens and the India government not supported elsewhere, for instance. Now Sorcha is quoting legit sources while continuing to talk about the Earth changes and things in the heavens, no longer quoting IndiaDaily. Is this disinfo? Another Booth?

We have mentioned that the public is [increasingly restless](#) in the face of weather extremes which create monster storms and alternating droughts and deluges, geological anomalies where the poles and glaciers are melting from the bottom up, earthquakes so on the increase that denial from the USGS is suspect, and all of this with no apparent relationship to the standard Global Warming excuse. We have explained that the [elite](#) anticipated being able to either hunker down into underground bunkers or escape the Earth temporarily, but have come to realize that neither route to safety will be available for them. We have explained that a decision was made to mentor survival communities, as a way to form a stronger worker base in the future, with [frank talk](#) about the coming cataclysm as a *possibility* in the media to begin this educational process. We have repeatedly mentioned that the elite who control the world by their [great wealth](#), have determined to make the Bush administration the [scapegoat](#) when the truth finally ruptures out into the open. They have been posturing themselves as the world's superpower, were in control of NASA since the discovery of Planet X in 1983, and their hand thus clearly at the helm of the cover-up.

So where does this leave the resentful Bush administration, who as mere Puppets of the wealthy elite had plans to become peers, controlling the worlds oil fields and the territories of the Americas from Alaska to Argentina? Clearly, they don't plan to cooperate, but they are likewise not succeeding in their plans to garner support behind them in their self appointed role as world leaders in Democracy. World opinion is against them, and other countries hold and buy the notes that the US needs as a daily fix to stay afloat. While the battle between the [Puppet Masters](#) and their Puppets rages, information, as well as disinformation agents, will emerge. In that takeovers can occur, especially when the agent does not have a real identity and is only an Internet presence, the same agent may start out as one, then switch. How is the public to sort this out?

Even where the ownership of a media outlet is known, the propensity known, the message or tone may suddenly switch. Such is the power of commands coming from the very top, or the threat of torture or assassination or financial calamity or scandal placed upon a radio or TV host. As in a [possession](#) the media outlet may seemingly change, then return to its former self, exorcised. In this rapidly changing environment, where the cover-up is doomed to rupture and expose the hands behind it, such flip-flops will be many. The Puppets are frantically pulling the strings of the media and threatening all involved with maintaining the coverup with extreme measures should they even consider cooperating with a plan for open discussion. The Puppet Masters are demanding that this open discussion *begin*. With the Earth changes firmly behind the Puppet Master's plan, the outcome is certain. Stay tuned.

Radio and TV announcers, newspaper editors, and scientists at Universities or on the government payroll would be asked questions, and needed to know what topics were to be suppressed, what pat answers were to be given, so the number of individuals involved in the cover-up grew. As with the meeting in France of government heads, reportedly to talk about Iraq and mend fences, where the word given to these heads of state was that there was a presence in the solar system, expected to float away, and at all costs the mission was to reduce panic, these new enlistees into the cover-up were told this was all for the public good.

ZetaTalk: [Credibility Issues](#), written Jul 5, 2003

Clearly, the establishment in the know about the coming cataclysms stands to benefit from a continuing

cover-up. Public knowledge would cause their empires to collapse, banking failures, a stock market crash, corporations devoid of workers, security workers vacant from their posts, crowded highways, looted stores, and an infrastructure no longer there to support the elite high in their perches above the common man.

ZetaTalk: [Cover-up Cracks](#), written Jul 5, 2003



[Mail this Page](#) to a Friend.

ZetaTalk: False Channels

Note: written on Jun 15, 1996

There is a confusing mixture of channeled information supposedly from various alien groups, and from various human individuals or groups who may not actually be in contact with alien groups,. and this confusion is only going to get worse.

Claims that one is in contact with an intelligence from another world is easier to foist upon the listener than a claim that one is listening to the spirits of dead humans. In seances, for instance, the audience can state that the message being relayed does not sound right, that it doesn't sound like Uncle Joe, or something an old woman would say. But if one is relaying a message that is supposedly coming from another world, almost anything goes, and it *does*. Fully half, 50%, of all individuals claiming to channel or the like are making this up, and they know it. The majority of those genuinely in contact, another 37% or so, are giving a garbled message so that there is a mixture of truth and uneasy feelings the channel may have. Thus only 12-13% of those making claims are relaying a true message. So the listening audience is completely confused in the main. It's like a kaleidoscope of information and colors. They are hearing about worlds they have not visited, nor are they likely to, so they have no basis of comparison and certainly no way to prove out what is being said. If one is going to tell a fairy tale, one tells it far out rather than with any basis of validation, and in that way validation is never a challenge or a worry.

Each person must sort the plethora of information out for themselves. Balance this information against what you know. What does the Earth itself report to you? What does geological history tell you? What do you, as scientists, know to make sense? What does your knowledge of social science tell you about how people will react? And, last but not least, what have we reported to you. Many times we cannot tell you that you are receiving incorrect information, because of the Rules of Engagement. You must trust your own instincts. The majority of supposedly channeled information is deliberately generated by humans looking to either disinform the populace or generate income.

Those looking to disinform do so for a wide variety of reasons. Some disinformation is to put forth a message they wish the populace to believe. For instance, if some in your government wished the populace to believe that they have cut a deal with aliens, so that immediate conquest by rampaging aliens had been held at bay by negotiating skills, they would create a false channel to this effect. Some disinformation is to counter a message unwanted. For instance, if some humans wanted the populace frightened enough of aliens that they would cling to the establishment for protection, and an alien group, such as ourselves, reported that humans can repel unwanted visits from aliens just by taking a firm stance, these humans would create a false channel reporting otherwise.

In all cases where a fraud is being perpetrated, the false channeler must create a massive amount of details, or a single message as a standalone looks suspicious. Since none of this is provable, and the humans generating the fraud know they won't be challenged unduly, they wax poetic. This situation is not an alien issue. It is a human issue. Look around you at human society. The man who would maintain several wives in a society that allows him only one. What stories does he invent to explain his absences, the wife's inability to contact him at work, his financial shortfalls? Story tellers are in the main not punished by society, which pays good money for stories at the movies. Stories are seen as a way to blunt the painful facts, and an adept storyteller is more often than not rewarded for his talent! What occurs when the various wives discover each other? Most often, they *all* want the husband to be theirs!

All rights reserved: ZetaTalk@ZetaTalk.com



[Mail this Page](#) to a Friend.

ZetaTalk: False Claims

Note: written on Nov 15, 1996

As the Awakening progresses, the flurry of increased sightings and communications from alien visitors will encourage false claims, for many reasons. Even in the past, when contactees and those claiming sightings were harassed, false claims outnumbered valid claims. Humans crave attention, in whatever form, as this is a trait that increases the likelihood of survival. The infant that cries the loudest gets rescued from distress and fed so that the parents can get some peace and quiet. The boy willing to step to the center of the group and present his ideas and plans is more likely to be followed on a romp or adventure than one who remains silent and keeps his thoughts to himself, and thus is first to the prize. The human animal demanding attention had the edge in survival, and as the survivor passed these genes along.

How does this human trait affect the Awakening?

- Humans who see others receive praise and awards for good grades in school cheat on their exams even at risk of discovery and punishment in order to step into the spotlight. Police files show that copycat crimes occur because the perpetrator desires the spotlight, and those walking into the police station to confess are almost invariably not a criminal but simply an attention getter. The desire to be the center of attention frequently overrides fear of punishment or derision.
- The desire to be the center of attention is strong, and where it cannot be satisfied otherwise can drive a human to present false claims. Thus where UFO research groups interview contactees and occasionally publish their stories, it is inevitable, in human society, that false claims of being a contactee would be made. False sightings are another such claim, as are claims of alien identity. How does one sort out the false claims from the valid?
- UFO research groups have long held back key data files from their publications, by agreement, so that false contactee stories could be identified. The public, however, doesn't have access to the transcripts, nor are they privy to the patterns the mass of data forms. The public can be fooled. False claimants have enough information at their disposal to put together a credible story, claiming contactee status or a sighting.
- Where the false claim includes alien identity, it is easily discredited, as no alien life forms exactly equate to the human shape and DNA composition. *All* such claims are false.

Those wishing to sort out false contactee or sighting claims from the valid must learn how to do this themselves, as by initial appearance they will both look valid. The false claim, however, will not hold up under intense questioning, as with all lies the truth become entangled in the many embellishments that elaborate lies require, and contradictions emerge. Read the valid literature published in the past by conscientious UFO research groups. Use this extensive data as a basis of comparison. But most of all, learn to discern the traits and profile of the attention getter. They will tend to embellish the story as the attention they get starts to wane, demand attention rather than react to it as it comes their way, contradict themselves increasingly as the story gets more elaborate, fly in the face of logic or known facts and well established trends, and answer questions evasively with a flood of irrelevant details rather than address the crux or gist of the question.

All rights reserved: ZetaTalk@ZetaTalk.com



[Mail this Page](#) to a Friend.

ZetaTalk: Serpo Exchange

written Dec 11, 2005

Planet Serpo www.serpo.org is an alleged exchange program whereby 12 Americans went in a large alien craft to their home world, Serpo. This American group is said to have left Earth in 1965 for a 20 year exchange, but returned a couple years later in 1978.

We warned several years ago that as the time of the passage approached, [disinformation sources](#) would proliferate. This is in part due to the desire of individuals to get on the band wagon, onto the stage, as prophecy and predictions are increasingly discussed in the media. But primarily this will be due to deliberate campaigns by the US and other governments to try to control public perceptions. In the past, when the US government was determined to discourage the public from *any* desire for contact with aliens, aliens were painted as demons, about to mass colonize the Earth or chop humans into vats for consumption. The US government could not *stop* the populace from reaching out in curiosity and giving The Call to visitors, so hoped to stop such contact at the start, within the populace, by instilling fear in those about to give The Call.

Why has this approach changed? We have long explained that the elite anticipated [escaping the effects](#) of the coming pole shift by either going underground into well stocked caverns or going to the Moon or Mars. Thus, such enclaves as Mt Weather, complete with underground golf courses, and the press to get a manned mission to Mars. These plans were laid during the days when MJ12 was talking to, and listening to, alien visitors in the Service-to-Self orientation. MJ12 and the wealthy elite they included in their membership were assured they would be given an assist when the time came, but have come to realize that the Service-to-Self lie. Humans in the Service-to-Self lie too, as anyone listening to the Bush Administration has observed, so this should not have come as a surprise. But only recently tests on their underground enclaves have shown them not safe for human habitation, and calling upon the promise to be taken to Mars have shown this promise to be false also. Now what?

Of course, MJ12 was introduced to ourselves and other aliens in the Service-to-Other in concert with the sales pitches given by the Service-to-Self, and gradually realized that the spiritual orientations exist in aliens just as they do among humans. Most are good hearted, but a few are self serving and manipulative. In desperation, seeing they will be stuck on the surface of Earth during the pending pole shift, amid horrific tidal wave sloshing, Richter 9 quakes everywhere, volcanic explosions and the gloom that follows, and a complete collapse of the infrastructure they rely upon - they cast about for other solutions. If the bad guys won't help them, as promised, they are now sucking up to the good guys. They noted that some contactees are protected from assassination, noting this when orders went out to assassinate these individuals and the assassinations were repeatedly foiled. They noted that some contactees were given healings, kept alive when their health would otherwise be failing. They noted mention of protection of good hearted communities after the pole shift, communal living with [high tech](#) alien communities, and set about to posture themselves for inclusion.

They reasoned that if the Council of Worlds is [pacing contact](#) with aliens based on the public's comfort level, so as not to increase anxiety, then the public should be made comfortable with the concept of the alien presence. If comfort with the alien presence can be promoted to the extent that aliens are walking about and interacting with people, then surely these friendly aliens would not let their neighbors suffer during the pole shift, and these helping hands would perforce extend to *them*, the elite, also. They reasoned that to counter the disinfo of the past, where aliens were seen as demonic, then disinfo where the aliens were seen as friendly and *not that much different from people* should be promoted. Thus we have planet Serpo, where aliens worship in churches, play soccer, conduct warfare with other planets, munch on vegies, use beasts of burden, and have a verbal language that can be understood by humans. True? Utter hogwash.

Were exchange programs not part of the MJ12 history? Within the parameters of [Alternative 3](#), where humans were taken to the Dark Side of the Moon and to the Earth's Dark Twin, such travel with Service-to-Self aliens occurred, and of course Service-to-Self aliens resided as guests of MJ12 on Earth. This was not considered an exchange program as the Moon and the Dark Twin are tightly within your solar system. Aliens in the Service-to-Other also *conferred* with and were available as envoys to MJ12, on Earth, but residence was elsewhere in [another density](#), unlike the Service-to-Self aliens who do not switch density well and avoid accidents by staying in 3rd Density with the humans they are assigned to interact with. Do we take humans off the surface of the Earth? Absolutely, as [individual contactees](#), not as representatives of MJ12. Exchange programs do not exist, because contact with humans is guided by the Council of Worlds, within the parameters of The Call, and this is best controlled by having the human resident on Earth where a change of heart does not necessity a change of planet.

Another, more likely, scenario, is to have the populace accept the alien presence, embrace it, and thus with aliens walking about on the face of the Earth, ignoring the plight of mankind would be embarrassing and they'd step in and effect a rescue, or so the logic goes.

ZetaTalk: [Discord](#),
written Apr 15, 1996

In all cases where a fraud is being perpetrated, the false channeler must create a massive amount of details, or a single message as a standalone looks suspicious. Since none of this is provable, and the humans generating the fraud know they won't be challenged unduly, they wax poetic.

ZetaTalk: [False Channels](#),
written Jun 15, 1996

There are several reasons why there will be no public announcement admitting to the alien presence. They are not in control of the visitations and sightings ongoing, and this lack of control is out of keeping with the posture they take in front of the tax payer.

ZetaTalk: [Break the News](#),
written Jun 15, 1997



[Mail this Page](#) to a Friend.

ZetaTalk: Art Bell

Note: written on Oct 15, 1998

Few radio commentators have been as successful as Art Bell, who has enjoyed a long-lasting and lively career. This is in no small part due to Art's insight into the fascination that mankind has with mysteries and conspiracy theories. He puts aside anger and focuses on the possibilities, endlessly stringing these out before his rapt audience so that they are never disappointed. He has them staying up late and losing sleep, fighting to get access to his web site, and even switching jobs to be able to accommodate this late night schedule. Will Art run out of mysteries and conspiracies? Not during *this* era, which has them unfolding like the layers of an onion, each layer revealing yet another with a stronger odor! The Kennedy assassination, the alien presence, government cover-ups, the millennium cataclysms - all just beginning to break into the open. Just Art Bell's cup of tea!

The flap about resigning from the airwaves in late 1998 was intentional, a publicity stunt. There were, however, several factors that put Art Bell in a nervous position at that time. Being a good citizen, he has listened to those government agents that have come to him with requests in the past, giving their skills a voice on the airwaves. The megalith that is the US Government is not of one mind, and this is certainly true of such volatile subjects as the alien presence and the coming pole shift. Thus, an increasingly intense tug-of-war has begun between the various factions that wish to influence the outcome. The old CIA dominated crowd is losing out, with their desire to deny, spread disinformation, and punish infractions. The new MJ12 crowd is wining these days, with their desire to have the truth out there if only in the form of ZetaTalk and Indian legends with *no* punishment of those who speak the truth. Thus, shortly after a serious disinformation attempt, the statement by a remote viewing shill that the Sun has periodic cycles of 3,633 years, MJ12 called a temporary halt to reset the guidelines.

Below added on June 15, 2006.

Could you ask the Zetas about Art Bell, radio talk show host on Coast to Coast AM. I'm very concerned about Art Bell and his young Philippina bride of 21 years. Do the Zetas know if she is insincere? Will he come back to the States?

Art Bell is first and foremost a human being, subject to the same desires and grief that all deal with during an incarnation. Those who point to his Mason membership and the odd times he has been off-air, rumors on his son being kidnapped, and thus see in Bell a puppet of the establishment fail to understand that even puppets have their own personal agendas, and certainly attempt to lead their own lives. Yes, as we have mentioned, Bell listens to the establishment when they make requests, under the guise of national security. No, this is not the *only* thing going on in his life. It was no secret that Bell was deeply attached to his former wife, now dead. It is also no secret that young women in the Philippines, as in many Third World countries, are desperate for good marriages that will allow them to escape poverty. Old men seeking young brides is certainly not unknown or a new phenomena. None of this means that the marriage will not be happy, as it bodes well for bringing both marital partners what they seek.

All rights reserved: ZetaTalk@ZetaTalk.com



[Mail this Page](#) to a Friend.

ZetaTalk: Hoagland

Note: written during the Sep 14, 2002 Live ZetaTalk IRC Session. Planet X and the 12th Planet are one and the same.

This mishap by NASA, wherein images taken by the Mars Surveyor that could be overlaid to *show* what NASA has been determined to hide were posted onto the NASA web site, will not be the last such mishap. The nervous peons at NASA, increasingly asked to work miracles during a time of rapid change, unexpected events, and unknown factors they are supposed to take into consideration, are dealing with rage. What causes mishaps? One can be worried, distracted, and this certainly is the case at NASA. They are headquartered at Houston, clearly subject to flooding and likely to be underwater early in the shift time, but at the same time they are expected to remain at their posts, loyal and true! One can be weary, asked to carry too many tasks, asked to keep an eye on too many trends at once, all running in different directions, and simply make a fatigue blunder. Autocratic bosses seldom consider the underling, who is barked at, and asked to do more, and told they are failing and incompetent when the boss is under stress. The boss, of course, can be incompetent, selfish, arrogant, but the underling is supposed to be unaware of that and try *harder*.

NASA peons are asked to maintain a cover-up of aliens, when their presence is increasing. They are asked to maintain a cover-up of Planet X, soon to be visible worldwide, due to ZetaTalk fame and coordinates posting, and are hard pressed as to what to say when. They are damned if they ignore it, damned if they identify it as some other object, and certainly damned by their bosses when the public does not buy whatever tack is taken. The bosses, however, expect a miracle, and none can be wrought. So if distraction, worry about getting the self and family to a safer location, and fatigue at being asked to stretch beyond the human ability and capacity is not enough to cause an error, what is? Rage, the seething desire to see the hated bosses fry, get caught, lose it on national TV, themselves get caught in the floods, themselves get caught in a lie they cannot explain, *anything* but saunter around acting arrogant and untouchable, sneering at the peons like they are less than worms.

So what happened, to allow Hoagland this *perfect* example of a cover-up, all pieces of the puzzle in place, marked by NASA as authentic, and no explanation other than that some normal steps taken on these images were missed? More than fatigue, more than distraction, but a subconscious leak, allowing these images to get there *before* a review was done, as is a standard practice at NASA. Oops, didn't this get reviewed? It was in that pile, in this queue, one assumed, one was sure a comment had been made, what happened to that sticker on the monitor saying go ahead with your days work, etc. This will not be the last such slip, and many will happen because of distraction and fatigue, but *more* will occur because the peons are enraged. And what does the [Summary Image](#) show, of Mars? Indeed, given the mining operations there, avenues for water washing are *clear* in the images. The standard construction of hominoids, on Earth, of geometric shapes, squares, rectangles, avenues straight away, *not* what nature designs but what many running vehicles designs. These cities laid out along a bluff, protecting the city from wind, *not* into or over the bluff, but where the land lies flat. It is quite unmistakable for a human hand design, and none who see it mistake it, despite the pathetic explanations of the NASA peons told to go forth and work miracles amid the public.

All rights reserved: ZetaTalk@ZetaTalk.com



[Mail this Page](#) to a Friend.

ZetaTalk: ZetaTalk

Note: recorded during the June 22, 2002 Live ZetaTalk IRC Session.

Has the cat been let out of the bag, no longer to be put back, out there *yowling* about declaring a pole shift in the offing and a massive long running cover-up in place? Yes, simply stated, after 20 million listeners have heard Nancy speaking, and caught her web site address, and visited, in the main, this web site address, the cat is loose! All other guests, bar none, have been tentative, basing their statements on human measurements, or rumor. *None* have the prediction track record of ZetaTalk, even including Scallion who is indeed a connected and legitimate channel. Where is this likely to go, and what are the options? Can they stuff Nancy back into the bag, declaring her insane or mustering various countering information or explanations? Not likely to be believed, and those who would contemplate such an effort understand that this would *more* than likely backfire, making her renown increase.

Art Bell of course screens his callers as to their likely questions and personalities and has many on the line so he can pick and chose as the show goes along. He clued the public in to his lead-in for the Open Lines that followed Nancy's interview, by stating during Nancy's interview that it would be a Mad Max world. Of course, this is what the lead-in callers were talking about! View this as a test, which Bell was requested to host, to see how the public would react. Those closely watching this did not want long whining and hand holding and talking about spirituality on the increase. They wanted to cut to the chase, to find out what *gangs* would do, who would have *guns* and how they would use them, and how the public would react to their government in bunkers while they were left outside. The result was that solid citizens, with children, jobs, and responsibilities in general, would consider moving to safety rather than making loud demands on the government. The talk of gangs, and rapes, and becoming a king were almost exclusively from the immature, and taken that way by the audience in general, who discounted this talk as bragado.

Thus, the common man impressed their government, the elite who have been keeping them in the dark, with their maturity and calm. It is for this reason that more outlets for Nancy of this sort should be anticipated. All those solution sets on Troubled Times, so long labored over and web wrapped. All those contacts willing to answer email. Soon to be called upon, thrust onto the stage, to address the masses with their questions.

All rights reserved: ZetaTalk@ZetaTalk.com



[Mail this Page](#) to a Friend.



ZetaTalk: MUFON

Note: written on Jan 15, 1997

As one of the first UFO organizations, and one of the most influential, MUFON was early on seen by the secret government as a threat. Thus, they ensured that MUFON would move in sync with the interests of MJ12, by one means or another, and this control exists to this day. Where in early days MUFON was prevented from publicizing some of its more striking discoveries, they are now being pressed to reopen the past and get noisy about it. Expect a number of startling announcements from the scientists who form the core of MUFON, backed up with hard evidence. In that the core of MUFON held fast to the truth through the hard times, it seems only fair that they should now have an opportunity to be the vehicle by which the truth emerges.

All rights reserved: ZetaTalk@ZetaTalk.com



[Mail this Page](#) to a Friend.

ZetaTalk: Leaks

Note: written during the Nov 30, 2002 Live ZetaTalk IRC Session.

Long withheld [British Files](#) on real sightings experienced by their military are suddenly forthcoming. Why? The Brits, in alliance with the US, are very busy these days, Blair trying to be a good buddy while taking intense heat from his lawmakers and public. Bush trying to find reason for a war with Iraq, so their oil can be well in hand and Israel put in charge of Iraq *and* Saudi oil prior to the shift, as planned. Where publicly waving and smiling, they are anything *but* happy behind the scenes, and they and their staff and increasingly ignoring relatively minor matters. Like children who sneak out and raid the refrigerator when the parents are holding a party on the patio, one drink too many and loud conversation and music, those in their governments *long* wanting to reveal these matters to the public see their chance. Look *behind* these slips, the lack of oversight, to what must be going on in the smoke filled rooms of power! What would be *so* engrossing that they would overlook what was in such tight control just years ago?

All rights reserved: ZetaTalk@ZetaTalk.com



[Mail this Page](#) to a Friend.

ZetaTalk: Element of Doubt

Note: written by Jul 15, 1995

Indeed it is true that on occasion a video or still photo produces what can arguably be one of our ships, but the point is still hotly contested. In the minds of the populace at large, who cannot discern fraud from fact, the point is still open. In the minds of experts, who on occasion are fooled, even a fraction of a percentage point puts the issue into the category of arguable. We do indeed allow some shots to develop, and others not. Reports from disappointed humans, who took a shot that didn't turn out, tends to strengthen skepticism, and we want some of that for the modulating effect. Were there to be a flood of shots challenging the experts, from humans without the capacity to produce high quality fraud, the level of anxiety would raise too rapidly. An occasional shot, even from a hick incapable of producing a high quality fraud, is arguable. Perhaps the hick had accomplices in a fraud. It's arguable.

The rule is, and will be for the near future, we keep the issue constantly before the populace, with a steadily increasing level of discussion, but always, always, with an element of doubt.

This element of doubt is necessary during the Awakening so your populace does not become unduly alarmed. A faint, a palpitating heart, distractible excitement, arguing with friends and co-workers for a few days, and increased interest in UFO subjects - none of this is considered a show stopper. Were the entire populace to react like this, there would be no problem. The Awakening would occur tomorrow. What we seek to avoid is the nervous breakdown, the fear in friends and co-workers raising to such a level that they take violent steps against the reporter, or the intensity of fear in the observer that would make them susceptible, incline them, toward giving The Call to the Service-to-Self. For this reason visitations are currently recorded only in the subconscious.

Note: below added during the Sep 7, 2002 Live ZetaTalk IRC Session.

The Element of Doubt rule must be interpreted in light of the *absolute certainty* that the alien presence is real, or not. The majority of the populace polled believes that the alien presence is real, intelligent life elsewhere possible, without *any* absolute proof in hand. This is what the Awakening desires, a gradual comfort level increase, without any contactees being burned at the stake by hysterical religious leaders whose turf has been threatened. [ZetaTalk Accuracy](#) is designed to allow the populace to discern *truth* in a message, vs newcomers to the scene who want the stage but invent the message. This does not *prove* that aliens are real, as Nancy could be getting the message from the government, be a front for release of this information, deniable where a straight-forward government source would not be deniable. Thus, the Element of Doubt is maintained.

All rights reserved: ZetaTalk@ZetaTalk.com



[Mail this Page](#) to a Friend.

ZetaTalk: June Incoming

written June 8, 2004

I received this from one of my correspondents. 'Snowball net comms check. All stations, clock sync, impact at minus 146 days, 5 hours UTC. Standby for ACC link. [Response] Snowball this is burrow. You are not secure. Repeat, you are not secure. Go green, go green.' What do you think about this info?

Michael

Starting with an intercepted radio transmission and compounded by warnings from an Internet hoaxer, Aussie Bloke, who rode the wave of curiosity about that intercept, rumors of comets or asteroids or dust clouds arriving at Earth in June have been running strong. Since meteors and fireballs have been on the increase, is there some truth to this intercept? Since the Earth stopped in its orbit during the Sweep on Dec 25, and has lingered at that point during the months since, tilting toward the Sun and leaning toward Planet X, this has allowed a computation of the point when the immense dust cloud filled with moon swirls and debris would arrive at Earth. We have mentioned that an attempt to [Nuke](#) Planet X, to deflect it from its path, occurred during September 2003, when the Earth was warned that a flash in the sky, supposedly Galileo's death by a plunge into Jupiter, might occur. Thus, they had intel on the length and composition of the immense tail of Planet X. In the intervening months, the location and speed of Planet X has been a top priority, daily checks made from observatories and any craft above the atmosphere in a position to take a reading.

We have mentioned that this dust cloud is [Magnetic](#) and flows predictably along magnetic flow lines in the Sun's vast field. We have mentioned that as [Dancing Partners](#) the magnetic tilt of Planet X can be calculated from the [Tilt and Lean](#) of the Earth, as [What Magnets Do](#) is not a mystery to man. Thus armed with data on the rate at which Planet X is moving past the Sun in its virtual straight line trajectory, its sling orbit, man could compute the likely arrival of the dust cloud with all its many moons and debris. During a recent [Interview](#) we were asked about the June 8 transit of Venus, which did *not* occur, though by the planet jam-up in front of Planet X it has pushed alongside the Earth due to the crowding the [Dark Twin](#) coming up behind the Earth in their shared orbit has created. We stated we were holding in abeyance our comments on the transit, so that the government would proceed with their plan to make *much* of this transit, and have the world *look*. And what did they see? Certainly something in front of the Sun. Certainly many things in front of the Sun, and *moving*. Is this Venus, or Venus clones? They are not as large as Venus, but are closer. And the drama is only beginning.

But how many Venuses are transiting in front of the Sun?

Giusmar



A lone ham radio operator digitally recorded an intercept of a U.S. military SSB (Single Side Band) radio transmission (before the transmission was suddenly shutdown because they mistakenly broadcast "in the clear" or non-encrypted) on 26 January of this year referring to a mysterious "countdown" to an unnamed event which (by the countdown) will occur around June 19 or 20 of this year. In the past few weeks, however, naval units worldwide have been putting to sea in unusual numbers, sufficient to cause us to

revisit the original message to assess movements and adopt a watch mode going forward into the June 19-20 date area.

[Prophecy Keepers](#)



[Mail this Page](#) to a Friend.

ZetaTalk: Sign to Mankind

written June 6, 2003, image from <http://www.cyberspaceorbit.com/otisans.gif>

Indeed, a mothership, or many during those times when visibility would be disbursed. Positioned such that it can hardly be missed by the *many* now looking for Planet X, and noticed casually by those gazing at the sunrise or sunset. This has a two-fold effect.

1. causing them to look more often, in these days going into rotation stoppage, and notice the second sun and its moons now also visible in photos to those discerning;
2. causing them to challenge the establishment to explain the obvious black object, as to what it is, and discover the establishment nervous and slamming doors, the existence of a cover-up.

But an underlying message also is being relayed, that man is *not* the unique lifeform he often assumes, alone as an intelligent and technological creature, so they look *past* the coming disasters to what might be coming next, from the heavens. As this will be invariably received as a warning, the human establishment reaction as a refusal to help, and thus the mothership remembered in this context.

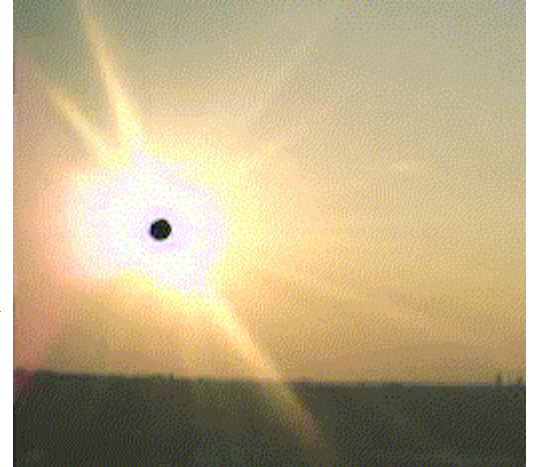



[Mail this Page](#) to a Friend.

ZetaTalk: Prophet Yehwah

live radio during the Lou Gentile show, May 27, 2005

This is a true example of the Element of Doubt in play. We have mentioned since the start of ZetaTalk in 1995 that there would be increasing sightings in the sky, mass sightings, and moving to captures on film and video, which has occurred. Police videos, and more and more evidence where as on the early part of 1990, you scarcely found a valid photo of a UFO, they just simply did not develop on film or on video. We have stated that this would occur as readiness in the populace was there. Not anxiety but eagerness, but always with an element of doubt. This is a classic case of this being experienced. Yes, UFO's do appear. No, he will not have 100% success. He will have crashing disappointments just when he expects to have a big success. And we have belabored the element of doubt many times. Where to reduce anxiety, the populace is not given absolute proof. There's always something that those who cannot deal with the idea of the alien presence can cling and say 'it's all a fraud, it's all nonsense, they were all mass hypnosis, a blip on the video' and the like. But he seems well able to handle this, the gentleman does, and it is part of the Awakening process that is out there, getting buffeted about and making these claims and telling people to look to the skies.

Signs of the Times #1440

Prophet summons UFO for camera [May 29] <http://www.WorldNetDaily.com> 'An ABC-TV affiliate in Las Vegas broadcast images of a UFO summoned by a self-styled "prophet" who predicts many more will be seen throughout the area next week. Ramon Watkins, also known as "Prophet Yahweh" agreed to meet with a reporter and camera crew of KTNV at a location of their choice and time. What they witnessed, and captured on camera, stunned the reporter and crew. Watkins claims to have seen some 1,500 UFOs over the last 25 years and has learned to summon them by reading the Old Testament.' [and from another source] Lou Gentile <http://www.lougentile.com> featured the Prophet Friday night [May 27], interview available on his web site, and states 'Prophet Yahweh has a very unique gift. He can summon UFO's at his command. Ok you may not believe this but check out this video from KTNV ABC-13 News in Las Vegas Nevada! He actually does this live and they appeared! mms://wm-ondemand.abacast.com/prophet_yahweh/ABCnews1.wmv

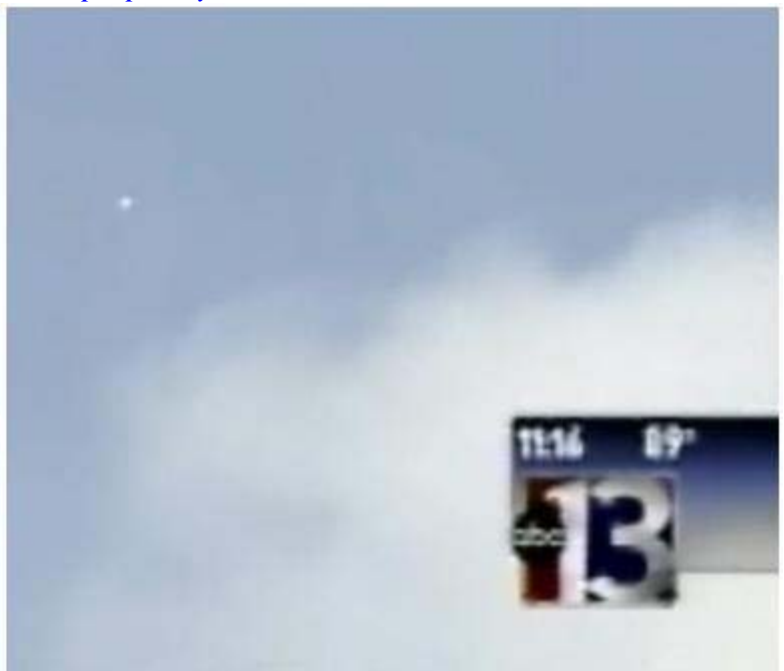



[Mail this Page](#) to a Friend.

ZetaTalk: Truth Test

Note: written on Jun 15, 1996

The reality that can be sensed is based on many things, and all of these things carry distortions.

- The physical reality that one perceives is distorted by the senses. Humans eyes, for instance, see but a small section of the color spectrum seen by other life forms. Beyond the color spectrum there is clarity of vision. Horses are nearly blind compared to humans, but the gliding hawk sees twice what a human does. Humans ears hear but a small swath of the vibration frequencies that other animals on Earth perceive, as any owner of a dog who respond to a dog whistle will attest. The human blows the whistle and hears nothing, but the dog comes running.
- A limited view of the physical world can lead one to distorted conclusions. Mankind deals with gravity, and thus in his mind has a down and an up. On the other side of the world there stands another man whose down and up are contrary. Even the fact that the Earth is round is lost on primitive man, unless he calculates carefully the movement of the skies and is given to deep thought on such matters. Humans speculate on the birth of the Solar System, all the while having no real sample of the core of the Earth or more than a sniff or two of components elsewhere. They are guessing.
- Man is ego-centric, and barely pulls away from a completely self-centered notion of the world even when a mature adult. He assumes the Sun revolves around the Earth until forced to deal with facts telling him otherwise. He assumes that he as an intelligent creature stands alone as God's handiwork and balks at having to share the spotlight with other species from other worlds. He develops pet theories that place him in the center of the Universe, and is loath to let these theories go as he *enjoys* this concept. Reality is resisted.
- Distortions are perpetrated by humans who stand to gain. The religious elite resist a more realistic view of the Universe as this puts them out of a comfortable job. The establishment frequently resists truth as *any* change to the status quo is likely to change their status, where they are perched at the top. This human desire to keep others ignorant or confused is rampant, from the husband who keeps his housewife ignorant of the job opportunities that exist for women in the work force to the distributor who keeps a competitors product off the shelves through bribes. Truth must fight its way through the mud to emerge.

All rights reserved: ZetaTalk@ZetaTalk.com



[Mail this Page](#) to a Friend.

ZetaTalk: Break the News

Note: written on Jun 15, 1997

Since news of the alien presence is so momentous, radically affecting all facets of human society, and increasingly cannot be suppressed, many anticipate that there will be some kind of a presidential announcement or press release explaining the situation. After all, this is done for other momentous matters, especially when the facts of the matter are increasingly obvious. For the government to continue in silence makes them look silly, ineffectual, and hiding and running from the situation rather than the impression they prefer to give - being in control, on top of the issues, and cool and collected. Should the government fail to talk about a gathering hurricane, or the severity of a drought, or the crash of a large commercial jet airplane, or an outbreak of the flu - they would seem to be out of touch and come under question. So why the silence on the alien presence?

Now hear this!

Alien Presence REAL!

**Sorry we lied for 50 years,
but we know you'll forgive us!**

**We can't stop or control it, but
please pay your taxes anyway.**

There are several reasons why there will be *no* public announcement admitting to the alien presence. Where there may be selected private announcements, a general press release will *not* occur.

- The alien presence is still deniable. Since aliens are currently operating under a rule that there remain an element of doubt, so that the anxiety level of humans will not be raised during the Awakening, governments can rely on this and continue to remain silent. Thus they can anticipate never being presented with a piece of evidence that would force them to break their silence.
- They have developed disinformation to bolster the story that it has all been a human generated hoax, and can come forth with this disinformation should they deem this necessary. Many sightings, particularly of triangular shaped ships that move in a manner reminiscent of jet planes with hover capability caused by jets turned downward, are man made. Some contactee visitations are also staged by humans who drug their subjects so they have spotty memories and conclude they are truly contactees. Should the government get pressed to address the alien presence, they have this card to play.
- They have numerous government sponsored studies, such as project Blue Book, which can give the impression that they too have been puzzled but unable to come up with any firm answers. Beyond the studies that are known to the public, there are many that have been prepared but are not yet released. These are held in abeyance, and updated periodically to stay in step with the level of awareness in the public, and would be released should the government get pressed to explain the increasing evidence that the Earth is being visited.
- They are concerned that the whole story about MJ12 and past government involvement with aliens, much of it shameful and even unlawful, will unravel and come out. In fact, the worse the past behavior, the more likely that the cover-up will continue. As evidence of this reverse logic, look to how long after the fact the public learns of government experiments on human subjects such as deliberate exposure to radiation or past ethical lapses of the CIA. Decades pass, and at times half a century, before the truth is revealed. The worse the lapse, the longer the cover-up before revelation.
- They are *not in control* of the visitations and sightings ongoing, and this lack of control is out of keeping with the posture they take in front of the tax payer. All manner of results are feared, from tax payer rebellion to a

collapse on Wall Street. Since these issues can be endlessly debated, the debate is never-ending. Thus, there is no point where a decision has been reached and they move forward to a press release of some sort.

All rights reserved: ZetaTalk@ZetaTalk.com



[Mail this Page](#) to a Friend.

ZetaTalk: ABC Special

written Feb 27, 2005

The ABC UFO special on Feb 24 ignored the late Dr John Macks life's work (including his Harvard tenure) with contactees that brought him to the conclusion that these volunteers and the hybrids with aliens will re-populate the earth after a great cataclysm. The transcript of him stating this as his belief is available at pbs.org.

Scarcely anything positive could be said about the much publicized ABC special on UFO's, as it presented nothing new and gave equal time to debunking any facts presented, and refused to debunk the debunk. In addition, it gave prime focus on the triangular shape UFO, which we have stated is nothing more than a human stealth plane intended to confuse the issue and claim a human origin for the UFO sightings at some point in the future. Was the Peter Jennings documentary nothing more than an establishment shill? It was certainly sculpted by the establishment, who acted as editors. Thus, the most profound statements on the subject of the alien presence were not included. The repeated statement that there was no *proof* avoided the evidence, such as:

- *multiple* captures on home videos, simultaneously, in Mexico during the 1991 Eclipse, movements showing, in angle and speed changes, maneuvers not possible by conventional planes;
- landing site anomalies, where plants refuse to grow at the site for more than a year in some cases, with no conventional explanation;
- crop circle nodes bent 90° and still growing, not crushed, where the crop yield is increased over crop not included in the circle arena, and the geometric precision and almost instantaneous creation of huge circle formations, none of which shows the hand of man but of the alien presence;
- implants lately recovered from contactee bodies, simultaneous missing time and visitation reports from complete strangers corroborating each other, and pregnancies confirmed by doctors suddenly disappearing;
- the astonishing number of eye witnesses to the Roswell incident, who were intimidated beyond any weather or spy balloon incident would have warranted, who saw alien bodies, which were then taken for autopsy, based against any excuse produced later by the Air Force such as a project Mogul balloon, carefully constructed in the 1990's to line up with the evidence from 1947.

Does the Air Force lie? They did during Blue Book, but the Roswell lie was taken at face value and not challenged. Are Harvard professors, debunking away, a credible source? Then why not include the word of John Mack, likewise an esteemed Harvard professor who had actual data to submit, not just opinions. Hypothetical explanations of the abduction phenomena were presented, on equal time with contactee reports which are carefully based on hard data. Why was this ABC special even produced? Why not let sleeping dogs lie? The establishment is aware that mass sightings are on the increase, valid captures of UFO's on video on the increase, and the public's opinions on the matter leaning in the direction of comfort with the alien presence. They are trying to grab the lead, be the force that is *leading* the public perception, but will not succeed in this. Those who have had contact, or are intrigued enough to be seeking this, know the truth. Those who have or will in the near future have a personal sighting see in such productions as the ABC special a firm determination to turn the public from the truth, and are having their respect for the authorities trashed in the process.

The overall effect of this special is, to disgust those who know the truth, to puzzle those new to the subject so they seek more information, and to ultimately increase the suspicion that the establishment is lying to them. This begs the question, why is the establishment so determined to keep the public in the dark? Tell a child not to peek in a closet, and their determination to do so increases. Watch interest in the alien presence explode, and the truth spread around like water into every crevasse.



[Mail this Page](#) to a Friend.

ZetaTalk: Orson Wells

Note: written on May 15, 1997

The presentation of the radio drama War of the Worlds some decades ago in the United States was, as many have expected, a test. Given that the alien presence had up until that time been consistently presented as an alien threat, the public reaction was hardly surprising. Radio dramas are often confused with reality by those tuning in, as there are few clues that a fiction, rather than a factual scene, is being portrayed. On TV, the fact that one is watching a movie is quickly apparent. There are clues in the settings, the time gaps and leaps, and the frequent intimate moments which newscasters are not generally privy to. Thus, had War of the Worlds been presented on TV at that time, rather than as a radio drama, the reaction would *not* have been the same.

This test, which the establishment knew would be taken for a real broadcast by many, was to determine *not* how the public would react to a threat but rather to determine *if they believed in the alien presence*. They did, and thus they reacted, and the strength of the reaction told an establishment which had been congratulating themselves on having suppressed belief in aliens that they had *not* succeeded as they thought.

Subsequently suppression continued but got meaner, with mistreatment of contactees becoming more abusive and physical. Since the establishment at that time was in the main under the impression that aliens were only interested in a takeover, having made contact with Service-to-Self aliens first, and being unaware of the separation of orientations that takes place after 3rd Density, they felt that the panic that ensued after the Orson Wells radio drama was inevitable. They thought of themselves as holding back a flood, putting their fingers in holes in the dike, and looking out for mankind's welfare. The few suicides that the broadcast caused, and the potential heart attacks, were not a concern to the establishment at that time, as they considered themselves to be essentially at war and the nation in essence under martial law. All rules of human conduct go out the window when the leadership is themselves in a panic.

All rights reserved: ZetaTalk@ZetaTalk.com



[Mail this Page](#) to a Friend.

ZetaTalk: Air Force One

Note: written on Jun 15, 1998

Of course the disappearance of Air Force One from radar screens, a situation which happened several times during 1998, was not just a technical problem. Why does this only happen to Air Force One? Planes do *not* disappear from radar unless they are removed from the scope's range. And this is what occurred. How better to announce that we are in communication with the US government? This is an awakening ploy, one approved by MJ12 as without their approval we could not approach or affect such person as the President or his Secret Service guard. This does *not* mean that anyone on board the plane was aware of their temporary removal from the air space, as they were awake only in their subconscious during this time, or otherwise unaware.

All rights reserved: ZetaTalk@ZetaTalk.com



[Mail this Page](#) to a Friend.

ZetaTalk: Staged Invasion

Note: recorded during the June 22, 2002 Live ZetaTalk IRC Session.

This rumor, spread by Greer, of a pending alien invasion, staged by the government, is unlikely to occur but as it is in the hands of man, anything could happen. The problems facing such an attempt to get the public well behind an *all out* Star Wars funding and effort would be to declare an invasion from space. The thought, also, would be to bring many countries behind the US in this. Russia, of course, would not buy into that, being privy to the alien presence all along. The primary problem with this plan is threefold.

1. they would have to stage an invasion that would equal in technological skill what much of the world has already come to understand, or has personally *seen*, in alien technology - sudden disappearances, right angle turns at high speeds, gravity control, etc. Thus, a poorly staged "invasion" would actually come back on the perpetrators, a horror they contemplate continuously.
2. to announce an alien invasion would be to admit to the alien presence. Leaks around the edges of this story would surely occur. Those reporting would forget what they were supposed to *just have learned* and start talking about what they already know. The public would see past this, realize they had been lied to all along, and once again, the perpetrators have shot themselves in the foot.
3. we, and our brethren, realizing we are to be used in this manner, could foil the staged invasion by a real display of our technology, highlighting the *difference* in a manner no one could miss, and by our presence creating blunders in the execution of the staged invasion so the truth would be out without question.

Thus, we predict, albeit with the caveat that this is in the hands of man and could *change* as their free will rules in this matter, that no such invasion will be stated.

All rights reserved: ZetaTalk@ZetaTalk.com



[Mail this Page](#) to a Friend.

ZetaTalk: Alien Encounters

Note: written on Feb 15, 1997

During the Awakening, sightings of alien ships will much precede sightings of actual aliens for a number of reasons. Recall that a key concern during the Awakening is to guard against raising the anxiety level of the humans on Earth, which would incline them toward the Service-to-Self orientation due to the self concern that is engendered during threatening situations.

The Outcome: Any sightings of alien life forms must be in a setting where the anxiety is slight, and is balanced overall by a sense of relief that alien encounters have been experienced with a reasonable outcome. The experiencer is not harmed, has not been intimidated, and finds they can communicate with the alien reasonably well.

The Experiencer: Where sightings of alien life forms *will* be forthcoming during the Awakening, they will occur *only* where the humans involved are considered strong enough to arrive at logical conclusions rather than panic-driven conclusions. These individuals are few and far between.

The Locale: Beyond the experiencer him or herself, there is the issue of how the humans in the immediate locale will react. The overall result must be a positive view of the alien presence. If an individual here or there will have a fearful reaction, this in and of itself will not prevent the sighting if their reaction is balanced out by receptive reactions in others.

All rights reserved: ZetaTalk@ZetaTalk.com



[Mail this Page](#) to a Friend.

ZetaTalk: Next Phase

Note: written on Feb 15, 1998

The Awakening is not on a linear climb to some point in the future when it becomes obvious to the vast mass of the populace that the alien presence is real, and among them. It is on a curve, akin to the rapid buildup that a parabola represents. In the past, encounters were few and far between, and reduced to what was taken to be tales and myths. When the Awakening was put upon a path that was to build exponentially until the Transformation was complete, the rules changed to allow few sightings and encounters only recorded in the subconscious. This allowed a reservoir of acceptance to build in the general populace, an acceptance those in authority in human society could not locate or control, though they tried.

Each level of acceptance, within a culture or country, or worldwide, allows another level of exposure in the general populace to ensue. Where first sightings were deniable, passing quickly and seen by few and most often a single individual, this moved in late 1997 into a phase where sightings are seen by many, are vivid and undeniable, and even recorded on video or film. Still, they are being under reported by the media, and denied by many in authority. Those in authority that realize the inevitable are seeking ways to give in gracefully, while those who are rigid in resisting what they deem a takeover by outsiders are still shrill and becoming increasingly ridiculous in their denials.

The next stage will be glimpses of alien bodies, fleeting at first, and then increasingly solid views. Watch for cries of "demon" from the religious elite, and "insanity" from those clinging to the status quo.

All rights reserved: ZetaTalk@ZetaTalk.com



[Mail this Page](#) to a Friend.

ZetaTalk: Past

Note: written on Feb 15, 2002. Planet X and the 12th Planet are one and the same.

Prior to Roswell, visitors were not required to record their visits only in the subconscious of humans. As the book, the *Vedas*, reports, humans saw their visitors as having all manner of shapes. In trying to relay their experiences, humans often stumbled and struggled. Many described them as odd animals, but beyond the physical appearance of their visitors, how to describe the phenomena that accompanied them? Levitation, space ships suddenly appearing or zooming away, lasers, the ability to disarm humans without touching them, etc. Thus, fire, wind, whatever might relay this experience, became the verbal story. This often confused those who came later, and could not ask for clarification of the story teller. To further cloud the issue are the giant hominoids from the 12th Planet, who lived among mankind until a few millennia ago. They live in the *Bible*, as the giant Goliath, for instance, and are *real* visitors in hominoids form. They are the Gods of Mt. Olympus, the Visigoth in Germany, and giants reported elsewhere. Thus, visitors in many shapes and forms are mixed in with myth, and current mankind is left to sort it out. In the main, take your myths and stories in this context, and see what the picture paints! Most folklore is *not* story telling, but a serious attempt to pass on important information.

All rights reserved: ZetaTalk@ZetaTalk.com



[Mail this Page](#) to a Friend.

ZetaTalk: Tumultuous Times

Note: written by Jul 15, 1995

What will unfold in the near future will be immensely disturbing to the Earth's inhabitants. We are not speaking only of galactic consciousness, we are speaking of the collapse of governments and entirely new social structures. People will be without their usual mooring, adrift. It is in our interest, the Zeta Reticulan interest, as 4th Density Service-to-Others entities, to reduce the amount of fear and anxiety that humans experience during these transitional times. We are not alone in these concerns. Other alien groups are so concerned, and are actively working to reduce fear in the Earth's inhabitants. You know them by many names, but there are vastly more groups that are participating in this efforts than you are aware of.

All rights reserved: ZetaTalk@ZetaTalk.com



[Mail this Page](#) to a Friend.

ZetaTalk: Prophecy

Note: written on Oct 15, 2000

Studies show that the majority of the populace believes in the alien presence, in the likelihood of intelligent life existing elsewhere in the Universe and being curious enough or having the capacity to travel to Earth for a visit. Since the majority of humans on Earth are not contactees, where does this solid belief come from? This is derived from a combination of factors, and when weighted by each individual human, leans heavily in the direction of life elsewhere being a possibility. These factors include the diversity of life they see on Earth, the likelihood of some process like evolution in that they can observe a similar skeletal structure on many different animal types, their own curiosity about the greater Universe extrapolated to a desire for space travel by humans, and the persuasiveness of UFO sightings. Regardless of statements by the establishment, the population believes otherwise. What factors, then, does the populace take into consideration during any discussion on pole shifts, past or pending?

In spite of the pompousness of self appointed experts in the scientific community, the public in general takes them with a grain of salt. The scientific community argues with itself, loudly at times, and presents contradictions to confused students. Announcements are regularly made about recent discoveries that contradict past assumptions, with new theories put forth as the new truth to be honored as fact. A jaded public listens with half an ear, giving other factors greater weight. More weight is given the views expressed by local experts, individuals known to the community for sober deliberation and solid conclusions that pass the test of time. When something momentous is about to happen, all eyes turn toward these individuals, to see their reactions and conclusions. In that the coming pole shift is expressing itself locally via weather changes and crop disasters, the global situation will not reach the local level until little time is left. Thus, the evaluation or conclusions of scientists, who disagree and argue, or the conclusions of local wisemen, is unlikely to cause the populace to conclude that a pole shift is pending.

Past geological upheavals are all around the common man, but go unseen as they have been there for the lifetimes of those living. Sheer cliffs, torn continents, risen or fallen ocean levels - all are put into the category of something unknown that happened before one's time. The explanation that much of this happened eons ago, during a time when the Earth was perhaps impacted by an asteroid, is accepted, and often this is due to the desire to believe that nothing so horrific could occur during one's own lifetime. The desire to be comfortable is strong, and denial an easy route. Patterns showing that cataclysms are recent, and periodic, cause discomfort in most, and thus are quickly put to rest by *any* alternative explanation - the study is wrong, the dates confused, or the reporter not credible. Such patterns, where compelling to those who have accepted, emotionally, the coming changes, will not be accepted by those not ready to be aware. Awareness must be preceded by a plan, steps to be taken by the individual, who must accept that their life will be changed before they can allow themselves to believe it.

Folklore and prophecy speaks to the coming changes eloquently, in all cultures and through many mediums. These stories and prophecies hold the populace spellbound, in the main, because the average man understands that for lore to persist through time, or for a prophecy to be widely known, it must have had a great impact on *all* who heard it, and thus it holds validity. This is a factor little understood by the establishment, who arrogantly assume that their statements are taken as valid by the public. Thus, folklore and prophecy are ignored by the establishment, as insignificant. They are wrong. Prophecies about albino animals, the White Buffalo, or a red sky accompanied by great heat and drought, or snow in summer, are also prophecies that can be verified by the average man. That many prophecies come true at the same time also holds weight. This - more than any argument in the media or pronouncements by experts or careful pattern analysis of geological changes - affects the average man, and causes him to consider the possibility that a time of global and spiritual change, as predicted, is about to occur.

All rights reserved: ZetaTalk@ZetaTalk.com



[Mail this Page](#) to a Friend.

ZetaTalk: Zhuge Liang

written Aug 4, 2006

Zhuge Liang wrote a set of Prophecy in the form of poems, 20 or more poems. The 15th poem wrote about the sudden rise of the Chinese Communist Party (CCP) and the last sentence of that poem clearly refers that in 2005 the CCP will meet a great debacle. In fact, it was in the spring of 2005 that a book 'Nine comments on CCP' was released and caused a trend in China to resign from the CCP. Now there has been over a hundred million former party members resigned. So the poems have a track record. In the 16th poem Zhuge Liang wrote that the world will face a great danger. The red flood will destroy the land and many people will die. At this time a saint will emerge and lead people to overcome the hardship. Finally China will be a land of light and love. Since his prophecy indicated the demise of CCP, any information referring to his prophecy has been blocked in China.



The poems after the one that described the pole shift talk about a kind of transformation process that China will enter, a new kind of era. The 18th and 19th mainly describe that after the saint's salvation, all different kinds of people, all different races of people will get rid of any misunderstandings or obstacles and unite with each other. The whole world will become one. People will not care too much about fame or individual interests. The saints or holy people will get off the stage and won't let people worship them. All the lands in the world will enjoy light and love. I sense that in Zetataalk, most information is largely about the US and the western world. So I hope the Zeta can comment on the Eastern Prophecy and give more concern about the Eastern world.

Ma Qian Ke

In almost every culture, there is folklore and prophecy to warn about the coming changes, what the Christians call the End Time. Revelations points to red dust and mountains being moved. Islam points to a prophesied 6 days when the Sun will seem to rise from the West. And quite outside of organized religion are the prophets in almost every tongue and backwater and island chain who have described what to look for, signs in the skies, and what these signs will lead to.

ZetaTalk: [Dragon's Claw](#), written Mar 9, 2006

In the twenty-ninth year of King Chieh [the last ruler of Hsia, the earliest recorded Chinese dynasty], the Sun was dimmed... King Chieh lacked virtue... the Sun was distressed... during the last years of Chieh ice formed in [summer] mornings and frosts in the sixth month [July]. Heavy rainfall toppled temples and buildings... Heaven gave severe orders. The Sun and Moon were untimely. Hot and cold weather arrived in disorder. The five cereal crops withered and died.

Written during the reign of Emperor Qin c.1600 B.C.

China has great history, much of it lost in past pole shifts. There are on occasion discovered great cities, or [pyramids](#), buried and forgotten. Record keeping in Egypt suffered in the same manner. For hundreds of years, survivors are discombobulated, wandering, starving, half mad, and keeping records the least of their concerns. No one knows why the [Great Pyramids](#) of Egypt were built, as they certainly were not burial vaults. How could such information be lost? Thus it was with the great cities of China, as the Chinese people have not just recently come to benefit from their native intelligence and steadfast work ethic. They were great before, immensely so. Ideally, the records would be intact and shared with the common man. Has this been the case in Western civilizations? The [Kolbrin](#), a record of past pole shifts from Egypt, was hidden in Scotland and spirited away to New Zealand when the church hierarchy tried to burn the Kolbrin entirely. Does the Catholic church share what they know with their flock? They lie. At the present time, [heads of state](#) around the world have been alerted that there is a presence in the inner solar system, with contries such

as the US and Russia and France and China nervously watching the interloper Planet X with all the technology at their disposal. Has the public heard about this? Not from these officials! Because of lost records, and the desire of leaders to mis-lead their people about what is to come, prophets and [mirages](#) have emerged to fill this void.

Zhuce Liang was not a mere mortal, which should come as no surprise among those familiar with his accomplishments. He was studious and intellectual, but also a great warrior and a natural leader of men. For a prophet to be taken seriously, they need a strong track record or some other boost in fame that keeps them from fading from view. [Edgar Cayce](#) is remembered in the West because he was a great healer and had insights into diseases that the doctors were unable to grasp. Were it not for this, his predictions on the coming pole shift, the signs to look for, might have been lost. In like manner Zhuce Liang stood tall, in legend, his words respected and recalled. His message was more than a warning about the coming pole shift, the red dust and incessant rains, which he termed a red flood. It was more than a warning to expect much death and hardship during these tumultuous times. He delivered a message of hope! One does not deliver the devastating news without explaining the outcome. His description of times of light and love, when men will stop fighting because of greed or the desire for power, but will instead support and love one another, is an exact description of what we have termed the [transformation](#)! That he devoted more time to describing the future, and scant time to describing the current Chinese Communist Party and the time of the pole shift, speaks volumes. He is saying, in essence, that this is what the Chinese people should focus on, the future, the time when those operating in the Service-to-Other will prevail.

Zhuce Liang predicts a saint, a natural leader who will emerge during the time of the pole shift. This was a logical guess, based on what he knew of the Chinese people and politics. He knew the [Chinese people](#) well. He understood that their ability to work in consensus with one another would put them into a government that would approximate Communism. He understood how corruption emerges in these settings, and that a dictator would likely emerge. The insights he gained during his life as Zhuce Liang were augmented by what he brought forward from past lives in China. In a past life, he had been close enough to the Dynasty leaders to see their reactions during a pole shift, and knew there would be a repeat performance during the coming shift. We have often stated that the official leadership will collapse during the times ahead, for many reasons. Cowards often strut around proclaiming their courage, as the current leadership in the White House exemplifies. Bush and Cheney and Rove, all avoiding duty in the Viet Nam era. It is the self focused and power hungry who claw their way to the top, by fraud and theft and intimidation and bribery and back stabbing. They will have no answers for the common man during the coming times, and will go into well stocked bunkers to save themselves. There with bedmates like themselves, the worst moral lot, without ethics or concern for each other and each power mad to become the top dog, they will essentially destroy each other in savage battles. Meanwhile, there stands the citizenry, without leadership. Natural leaders emerge, of a different moral fiber, and it is this that Zhuce Liang speaks about.



[Mail this Page](#) to a Friend.

ZetaTalk: China Mirage

written May 13, 2006 on the live GodlikeProduction Radio show.

This was a deliberate sign - *go to the mountains, leave the coast* - this was the message given to them. They were being given a telepathic message at the same time to their subconscious. What might come to mind is that movie *Close Encounters of the Third Kind*, where a ship goes by and blasts with a ray of light certain individuals who have a message into their subconscious, *go to a certain hilltop in Wyoming, as unique volcanic spire*. Then several individuals managed to make it so that they could be included and leave the Earth in a spaceship, a mothership. This is not that message, but there are similarities. They were given this holographic view at the same time they were told, *it is not safe to be on the coast* where they obviously were, looking out on the ocean. *The mountains, you should seek a city in the mountains*, was the intent of this holographic view, a type of sighting.

Rare Mirage Appears off East China Shore

May 7, 2006

http://www.chinadaily.com.cn/china/2006-05/07/content_583576.htm



Thousands of tourists and local residents witnessed a mirage of high clarity lasting for four hours off the shore of Penglai City in east China's Shandong Province on Sunday. Mists rising on the shore created an image of a city, with modern high-rise buildings, broad city streets and bustling cars as well as crowds of people all clearly visible. The city of Penglai had been soaked by two days of rain before the rare weather phenomenon occurred. The mirage took place during the week-long Labor Day holiday. The small city received over 30,000 tourists on Sunday. Experts said that many mirages have been recorded in Penglai, on the tip of Shandong Peninsula, throughout history, which made it known as a dwelling place of the gods. They explained that a mirage is formed when moisture in the air becomes warmer than the temperature of sea water, which refracts rays of sunlight to create reflections of the landscape in the sky.





[Mail this Page](#) to a Friend.

ZetaTalk: 1999 Predictions

Note: written on Apr 15, 1999

We predicted, in 1995 when ZetaTalk first started, the weather changes. This is a matter of record, because our emissary Nancy has put on the web site a What's New page that traces all the way back to 1995. We predicted the erratic weather that is occurring now where no one else did.

We stated in the beginning of 1995 that there would be weather changes of such a nature that there would be crop failures due to crops being wrongly signaled, a spring coming too soon so that plants start off on their cycles and then a dramatic reversal, winter returning. This can cause a crop failure as surely as an intractable drought or a deluge that literally washes the seeds out of the ground. In addition we predicted that livestock and fish harvests would suffer, because they are going to be affected by a tendency to have increased diseases, fungal infections and the like that can run rampant through commercial operations. Private family homes, small operations, are more protected from that, as they break the illness cycle. But, for instance, a warehouse of chickens can be wiped out in a wink because of their closeness.

So, what is going to happen in the next four years? Are we going to just trot along and arrive one day when the giant comet comes roaring through and a pole shift occurs? Of course not. You're going to have increasing earthquake tremblers. There has been a tightening up of the plates against each other that has not even appeared in your media, though the information is available and has been documented on the Troubled Times web site that our emissary and her fellow co-workers have put out. [Deep Earthquakes](#) have skyrocketed at an exponential rate since the mid 1980, and this indicates a tightening up of these plates. Where this has not translated to surface quakes, it soon will, and you will find that because these deep plates are locked in that a quake in one place transmits to another, and you will have what Nancy has been referring to as domino quakes. Rather than months going by before a repercussion is felt in another part of the world, repercussions will happen almost instantaneously. This will be defused by the media which will fail to report them. Some earthquakes in remote places will not be reported at all, but nevertheless, word will get around.

The oceans will continue, as will the weather, the ocean of air, to become more erratic. Winds sweeping in without notice, sudden storms, deluges, tides that are greater than expected, especially along the Pacific coastlines. Warm oceans will occur in places where they should be cool, and the fisheries will suffer from this because they can't predict where the schools of fish will be. Likewise, you will find human populations beginning to migrate. These migration not only happens in cases of severe starvation, such as in northern Africa south of the Sudan, where people just stumble like sticks in any direction, looking for food, but also occurs when things get bad enough, when crop shortages are bad, and people begin to wander. They're looking for something better. So you will have migrations and you will have guards against migrations. Rifles at the border, pointed and saying don't come a step further and shooting people for little reason. This is already starting to raise its head in the anxiety that the United States expresses about the people south of their borders.

Cults will form, enclaves of people clinging to whomever or whatever promises safety. Don't buy into that, as no one can give you safety. You have to look to yourself and be realistic. If it's anything but relying on yourself, you're being conned. But this type of grouping will occur. At this point, in early 1999, we'll stop predicting because it becomes irrelevant. We will predict again in a year or so, restating our position. This is enough, for now, for people to be able to discern for themselves what steps they should take in the immediate future.

All rights reserved: ZetaTalk@ZetaTalk.com



[Mail this Page](#) to a Friend.

ZetaTalk: Service-to-Others

Note: written by Jul 15, 1995

Regarding what the future Service-to-Others Earth may appear to be, this will not be something strange. There are many groups on Earth already who operate in the Service-to-Others orientation. They share their resources, address the problems of each as though it were a problem for the many, sacrifice their own comfort for the better comfort of the many, and do not impede the growth or awakening to knowledge of each other. In the Earth of the future, these qualities will seem to increase in people, and groups will find less and less need for artificial controls on their behavior, and more and more allowance for trust among each other. There are no human societies, however, that exemplify the 4th Density spiritual Service-to-Others community. Human societies are, in the main, populated by the undecided. This colors the social structure, inevitably.

- Where Communism ascribed to a system where each gave according to his ability, and all were supported, this of course did not occur. Corruption quickly gained the upper hand, black markets emerging, such that those ascribing to the original philosophy starved and were worked half to death.
- Capitalism on its face fails, as while supporting the greedy, who without hesitation step on the least of those among them to raise themselves up, creates and enhances ignoring the suffering of the neighbor. Those who espouse capitalism, saying that Capitalist nations are most successful, fail to count the suffering of the little man. Success is not measured by the wealth and smugness of a few. Pollution, emotional deprivation, the dulling of the mind and heart of the man on the street - these are the byproducts of Capitalism.
- Religions likewise, even if based on the philosophy that the weakest among them should be cared for, and all should give to the betterment of the group, fail. The Pope lives in splendor, gold and high ceilings everywhere, while those supporting this structure starve and are given edicts of sexual suppression that the pedophile priests hardly ascribe to.

Thus, even in the average family, the Service-to-Others 4th Density spiritual existence cannot proceed. Thus, other than read what we have described as *our* existence, we cannot point to a human culture, a human philosophy, as a case in point.

All rights reserved: ZetaTalk@ZetaTalk.com



[Mail this Page](#) to a Friend.

ZetaTalk: Familiar Stranger

Note: written by Jul 15, 1995

Many contactees have the sense that they have met another before, and that there is some activity they are to do together. At times they spontaneously recall a meeting with people they do not recognize, or have a flash of a person's face, figure, or demeanor. Contactees are being introduced to each other by aliens who are coordinating activities. The contactee may meet the others in their conscious life at some point in time, or such a meeting may never occur. If they meet, they have a sense that there is something familiar about the other person, or perhaps think they know them from some place. This, of course, happens all the time in human relationships, so comments about this cause no one to take alarm. However, in the contactee's subconscious all remember the prior meeting and the issues being discussed, and work together toward common goals without needing to mention them openly or to be consciously aware that they are doing so.

Many contactees have become aware, through one means or another, that these types of meetings are occurring and that they have met supposed strangers in their lives that they recognize, absolutely. This is being discussed in contactee support groups, or among contactees who have become friends. This type of awareness will only increase as the need for coordinated activity increases, and as troubled times approach.

All rights reserved: ZetaTalk@ZetaTalk.com



[Mail this Page](#) to a Friend.

ZetaTalk: Supposed to Do

Note: written by Jul 15, 1995

When humans are given technological advice, or prepared in some manner for future possibilities, of having a role, they often have no conscious memory of this. Many contactees speak of have a vague sense that they are to do something, or that they have some special knowledge of how things work, outside of what they could have secured during the normal course of events. Why is this knowledge clouded? Would not matters unfold more effectively if the contactee was consciously aware of their role? There are many reasons why slumber is preferable.

- First, many times the technological advice or coordinated activity planned for cannot take place for some time. In the meantime, if conscious of the advice or plan, the contactee would be under tension not to discuss or give any indication of the plan, fearing a number of repercussions. The technological advice could be stolen, if revealed, or at the very least the contactee could be harassed to reveal it. The contactee could also be questioned as to where the technological advice came from, and being at a loss to explain, be subject to ridicule. And if the contactee has agreed to perform a certain role, the fear is that if others would learn of it, this role could be countered.
- Second, many projects being coordinated by ourselves, the Zetas, or our brethren in the Service-to-Others groups, require humans to meet in groups. These meetings are no more remembered than the individual meetings, but carry more danger to all concerned. The danger is in discovery, in that contactees are today subject to various punishments if their contact is made known. Job loss, hostility in the mails or over the phone, loss of support from friends and family and even divorce have occurred. There have been instances where death has resulted, but we are not allowed to be specific regarding our knowledge of these instances. As many are involved in these joint meetings, the risk of discovery is multiplied. These matters usually involve deep slumber, the depth in proportion to the risk.
- Third, the times are changing, and the rate of change accelerating. Contactees are given technological advice or agree to a role in accordance with the scene as projected at a given point in time. Being only subconsciously aware, they do not make changes in their lives to line up with the plan. The contactee may gather knowledge, or emotionally prepare for a future role, but is not put out in any other way by the plan in place. If the situation changes, there are no physical effects upon the contactee's life, other than a different plan to become emotionally prepared for. If the contactee were to be consciously aware of the advice or plan, they would certainly adjust their life to be in accordance. Then, when plans change, another and another adjustment would be made. In addition to being disruptive to the contactee's life, this behavior would look erratic, and demean the contactee's credibility with others. Slumber is preferable.

All rights reserved: ZetaTalk@ZetaTalk.com



[Mail this Page](#) to a Friend.

ZetaTalk: Mass Consciousness

Note: written on Apr 15, 1996

Given that man is a social creature, adopting styles of dress, recipes, tools and techniques, and in general modeling after one another in a thousand ways, might man not also share concepts, via telepathy, en- mass? A trend has been noticed whereby *without* public notification such as media exposure, some ideas become widely populated. What's going on there? Is the populace communicating with each other on a subliminal level, so that ideas are shared and perhaps even discussed, subconsciously? Yes! This occurs on several levels.

- Via telepathy, whereby everyone gets on the same wave length and shares thoughts. When this occurs humans may find themselves mentioning to one another, casually, that they had been musing about this or that and be startled to find they were musing about the same subject at the same time. No coincidence at all.
- Via soul-to-soul conversations, when humans are in close proximity or on an Out-Of-Body expedition. In this case humans may find themselves falling silent and brooding over their beers or perhaps enjoying the sunset without speaking - a moment of silence. Later they may find that they mesh better on certain issues, and clash less. They seem to have come to a consensus, and usually assume this to be just coincidence.
- Via subliminal messages communicated through tone of voice or body language to a degree that would be disbelieved by most humans. Where the concept of body language being communicated by the tension or openness in posture, or a sense of tension or grief being communicated by the tone of voice, is not foreign to humans who almost always have had personal experiences with this type of communication, they would disbelieve that this communication vehicle could work en-mass through, for instance, the media. However, a single individual's unconscious body language, seen by millions, has just affected the mass consciousness.

All rights reserved: ZetaTalk@ZetaTalk.com



[Mail this Page](#) to a Friend.

ZetaTalk: Mouths of Madmen

Note: written on Oct 15, 1996

Humans in the grip of mental illness have long been known to entertain the sane with their delusions or paranoia, but often those whose shackles to the rigid norms of what social propriety will allow tell the truth where others more sane remain in denial. Pointing the finger of an insanity accusation is one of the most effective ways to discredit someone, and thus those who have a history of mental illness are allowed to speak their mind and are not considered a threat by the establishment. Thus, mentally ill contactees were never harassed by MJ12 or the establishment, and even if aware of government plans or operations are seldom considered a threat. Because the boundaries between reality and unreality as human society perceives it has already been blurred in those suffering from mental illness, they are more prone to accept what their subconscious tells them. Thus, mentally ill contactees do not suppress their recall, but rather relay it readily to others and muse about it.

There have been cases where street people, often mentally ill and living on the street to evade being institutionalized, have been picked up to be handed over to aliens in the Service-to-Self, as part of an arrangement the CIA, as an arm of MJ12, had with these alien groups. If these unfortunate derelicts had the inner strength to just say "no" to these Service-to-Self aliens, they survived these encounters as by the rules aliens can only affect humans if they are given permission. Thus, it has indeed happened that derelicts survived such encounters and were returned to the streets, unharmed and with subconscious knowledge of what goes on. Underground chambers, the association of military guards with aliens, trips on space ships - all this knowledge was expected by the CIA to be taken by anyone hearing such tales from the mouths of madmen as simply delusions.

All rights reserved: ZetaTalk@ZetaTalk.com



[Mail this Page](#) to a Friend.

ZetaTalk: Steps and Stages

Note: written on Jan 15, 1996

Individuals becoming aware of the alien presence go through predictable steps in their awakening process, though the pace or the intensity of a reaction may differ widely.

- The first stage is denial, where in fact the majority of awakened mankind sits today. They may entertain the *possibility* that the alien presence is real, may even loudly argue the possibility, and may be considered anything but a skeptic by those who know them, but these individuals are still holding close, in their heart of hearts, to the supremacy and uniqueness of man. Their life has not changed, society functions as before, and thus the alien presence is considered just a possibility.
- The second stage is unease, as circumstances in their personal life, or simple logic, erode their comfortable cocoon. They spend quiet moments pondering what this might mean. They try on different scenarios and outcomes, to see how this feels. They long to find another who is at the same stage, but find almost everyone else still discussing *if* the alien presence is real. This second stage is lonely, but as this individual is usually giving The Call almost incessantly, they are having many conferences and this assuages their loneliness among humans to a great degree.
- The third stage is anticipation, as, sensing what lies ahead the individual is impatient to have the world around him, his human society, wake up. He now views the rest of society, with their comfortable beliefs, as old fashioned and remarkably unobservant. He stops arguing about the alien presence, and begins making quiet changes in his life. At this point he may encounter others who have the same quiet understanding and convictions, and such meetings form groups that are the buds of a new, awakened, society. Individuals at this third stage might meet an alien or sight a ship and *not* experience undue anxiety. They are ready, but are being held back by the needs of the rest of the populace.

All rights reserved: ZetaTalk@ZetaTalk.com



[Mail this Page](#) to a Friend.

ZetaTalk: Falon Gong

Note: written on Apr 15, 2002

Communism in China repressed several elements present in normal human society. They purged intellectuals, glorifying the farmer over the historian and scientist. They repressed religion, putting Communism forth as the only religion allowed. The goal was to have a totally focused populace, such that only the state, and working as a producer for the state, would be tolerated in the eyes of the common man. But like all repressive regimes, they failed to satisfy or leave allowances for the mind of man, seeking to address what they sense, but could not see. The thugs running the Communist regime sought to destroy the elite they could not join, the University intellectuals, creative individuals, and in their opportunity to have jealousy prevail, killed thousands and threatened untold others. In their desire to be worshipped as saviors, as idols, they destroyed religion and the sense of mankind that the physical is not *all* there is. But in their stupidity, the heavy-handedness of the thug, they assumed that by preventing eyes from looking elsewhere, and thoughts from roving, they would have eyes and minds pointed in adoration toward *them*, but in this they were naive. The intellectuals of China went underground, learned to limit their discussions among like kind, and went overseas and to other countries in many cases, but did not desist or die. And religion, the reaching out of the soul for the unseen and unprovable, but sensed, likewise hardly went away. In quiet households, traditions and discussions remained, cautious but steadfast.

Where little is heard from China in the UFO community, this hardly means that sightings and contactees are nil there. China is *huge*, the population *immense*, and the people bright and hard working, long suffering and tenacious. So what has happened, outside the view of western man and the nightly news on CNN? Sightings, and contacts made so broadly that the common man and woman *know* about the alien presence more certainly than in western civilizations! The Chinese people are intelligent, patient, and tend to business regardless of health problems, starvation, weather problems, or the rigidity of their governments. They are thus very ready for yet another intrusion, the alien presence. They handle this well, like all other burdens they must bear, stoically. Thus, as contactees, they proved to be ideal, and when giving The Call got a proportionate response. Those contactees who would have their life destroyed, are given a light response. Those who can handle it, a broad or intense response. The Chinese people have proved a group that can handle it, and thus were given an appropriate response. CNN does not spread knowledge of the alien presence, which can be a knowledge spread village to village, household to household, and in the farm fields, far from those who would control the mind of China, in discussion during the day. Thus, China is more advanced in knowledge about the alien presence, as few households do *not* know of someone, a friend or neighbor, who has had an experience.

The Falon Gong movement had a resonance with these people, such that they recognized *others* who had similar experiences, and joined. The message was simply - man was not alone, the alien presence was real, change was at hand, and a man was not a captive of his government, was free. This was an immense threat to the Communist elite in control, so they thought, of China. Falon Gong advocates were tortured, killed, imprisoned, and treated worse than criminals for nothing more than a desire to have a healthy lifestyle and a simple viewpoint. The over-reaction of the Chinese government to this movement *shows* the threat free thinking and an open heart bear to them. This is, to a minor degree, what the western world presents to contactees and those who would be free of government restraints. If 50% of the US population or better feel the alien presence is real, then why the intense debunking that goes on? If mothers with babes in their arms are shot dead by the FBI, because of the threat of non-payment of taxes to the US Government, then how free are US citizens to speak or think freely? Falon Gong is in China, but the heavy hand of the Chinese government is not unique. Look about you and you will see a similar heavy hand hovering above *you*!

All rights reserved: ZetaTalk@ZetaTalk.com



[Mail this Page](#) to a Friend.

ZetaTalk: Walk Openly

Note: written by Jul 15, 1995

Regarding when and how alien life forms will walk among Homo Sapiens openly. This will never occur as expected, as the inhabitants of Earth have been led to believe by watching the movies. You are not alone now, nor have you been for many centuries. Your people's physical form will change gradually, such that you will be unaware of the change. Intelligence will increase, as will the use of telepathy. In some areas life forms not of the Earth will intermingle with the Earth's inhabitants, but these will be areas remote or involving few people. Word of these places will spread, just as word of the far continents of the world spread during the past millennium. Gossip serves a purpose in this respect. It allows for gradual acclimatization. In those places where many life forms intermingle, the people will be aware that they are among friends.

Introductions will be made during times of tribulation. The heart is most open when all seems lost. The mind is open to change when the world known before has been turned upside down. It is then that progress toward an open lifestyle will be most rapid.

All rights reserved: ZetaTalk@ZetaTalk.com



[Mail this Page](#) to a Friend.

ZetaTalk: Tell Others

Note: written on Jul 15, 1995

Much is made in UFOlogy about differences, how aliens are different from humans - travel by different means, communicate by different means, nourish themselves by different means, procreate by different means. When do we hear about the similarities? Children are told, when first introduced to other little ones at nursery school, to remember and realize the similarities. Don't bonk Johnny on the head, his head hurts the same as yours did when you hit it on the table. Don't push Mary aside when lining up for cookies and milk break, she's hungry too. Similarities. When trying to reduce conflict between the sexes, the similarities are stressed. Yes, boys can engage in football without bruising like the girls do, but girls also learn teamwork from team sports, develop strong bones and muscles, get outside in the fresh air, and cherish their awards. Similarities.

The establishment, wishing to retain control, cannot be counted on to make this shift when educating the public to our presence. National leaders, wishing to keep the populace devoted, stress not the similarities between the nation and those across the borders, but the differences. Keep the guard up. Resist encroachment. And above all endure shortages and hardships without complaint, as the enemy is about to pounce. For Earthlings to become aware of the similarities between themselves and beings from outer space is for them to let down their guard, express an interest in communications, perhaps even extend an invitation. As the establishment cannot be counted on to encourage this, this type of education must be done on an individual level. As you say, education begins in the home.

All rights reserved: ZetaTalk@ZetaTalk.com



[Mail this Page](#) to a Friend.

ZetaTalk: Language Barriers

Note: written on Feb 15, 1996

Where humans think of language as their premiere communication vehicle, right up there with symbols and pictures but able to support a precision beyond any other vehicle - most misunderstand the mental process in the physiology of the brain required to communicate in words or any other such abstraction. When the toddler says "dog" in reference to the big fuzzy hulk he has been nuzzled by, whom everyone else is calling "dog", he has made Connection One, entity. When the toddler says "Johnny go potty", connecting two such Connection Ones together with a Connection Two, activity, he has made Connection Three - relationship. This goes on in increasing complexity to hundreds of Connections.

These Connections are *not* the same between intelligent species from different worlds, nor are they even the same among factions of the intelligent species on a single world. Your Earth has many such languages, and for you to assume that all such languages portray the same *concepts* would be shallow thinking indeed. There are concepts the aboriginals in Australia hold that they cannot communicate to others, as there is no *equivalent* in other languages. This is one source of communication glitches, where western thinking says, just give me the equivalent word, and taking the closest candidate, makes a statement that carries a quite different meaning than was intended. Language barriers are not just due to a failure of one party to memorize the vocabulary of another. One would have to be raised, simultaneously, in the two cultures involved, to truly translate.

In ZetaTalk we are in a cooperative effort with our emissary, Nancy. We do not give her the equivalent word, in English, to our word. In the first place, we do not *use* words. We give her the concept, in all its many permutations - visuals, movements, emotions, timing, analogies. *She* puts the words to this, and plays back to us what the words relay to her, a playback. If her words have described to her an erroneous concept, we go at it again, fine tuning. Thus, if Nancy does not have a concept of chemistry, for instance, how crystals are constructed, then we must *give* her this concept in terms she can understand, in order for her to relay our message in this regard. Just as a radio announcer is limited by his vehicle, so we are limited by our vehicle, in ZetaTalk. However, except for those who wish to gain a technological advantage from ZetaTalk answers, this has not proved to be a communication hindrance.

All rights reserved: ZetaTalk@ZetaTalk.com



[Mail this Page](#) to a Friend.

ZetaTalk: Hanging Around Saturn

Note: written on Oct 15, 1996

Since its discovery, Saturn has been a fascination for humans, due to its splendid rings. Its beauty drew the attention of humans, who readily assumed it would do the same for those visiting the Solar System. The fact that Saturn with its dramatic rings is utterly inhospitable to life doesn't enter into the equation, it seems. The rumors that there are large mother ships situated within the rings is positively silly. Alien visitors do not *need* to hide their presence from humans in this manner, nor do they even need the gravitational anchor that a planet can provide. Visitors are most comfortable when in 4th Density, and when in that density they are invisible to humans. The mother ships aren't hanging around Saturn, they're hanging around Earth!



All rights reserved: ZetaTalk@ZetaTalk.com



[Mail this Page](#) to a Friend.

ZetaTalk: Moons of Mars

Note: written on Oct 15, 1996

It is rumored that one of the moons of Mars, Phobos, is inhabited by the giant hominoids from the 12th Planet, and this rumor is correct. They have burrowed into the interior of this relatively small moon to conduct a mining operation, but this is not the only reason. As we have mentioned, they ruined the surface of Mars with these mining operations. What thin atmosphere Mars had essentially disappeared when the water was diverted into underground caverns, cooling the surface until the remaining water froze. Mining the caverns of Phobos allows these visitors several advantages:

- They remain out of sight of Earth telescopes, and thus hope to evade interference of visits from curious humans.
- Atmosphere and temperature control is easier within an enclosed space.
- The moon's surface affords a thick and almost impermeable shield from bombardment from space trash such as dust and small meteors, which would continually pepper them if they remained on the surface of Mars.

What occurs when one of NASA's probes drifts close to this moon? Monitoring equipment stationed on the surface of Phobos by these visitors alerts them to the approach of something other than space trash. Not wanting to be observed or to become the object of curiosity, the giant hominoids simply put the eye out of the probe. This is done with a laser, the same mechanism they use to send signals to one another at great distances but devastating to delicate electronic equipment at close range. Send a probe to Phobos and oops, the probe stops working! Any attempt to fly a manned shuttle to Phobos to explore the operation would also meet with disaster and death, and such an attempt is therefore ill advised.

All rights reserved: ZetaTalk@ZetaTalk.com



[Mail this Page](#) to a Friend.

ZetaTalk: Stanton Friedman

Note: written on Dec 15, 1996

This Canadian scientist, with a solid background in physics, was an early researcher in what was then considered the paranormal UFO phenomenon. He brings the weight of his considerable intellect to bear on the subject, examining landing sights, mutilations residue and testimony, visual sightings by both private and government individuals, and the authenticity of such frauds as the MJ12 Documents. He is thorough and precise, leaving no stone unturned or piece of evidence out of consideration. Should he err, this is *not* because he has been less than thorough, and is most certainly *not* due to his being a disinformation agent, which he is *not*. For those able to follow an intelligent discussion, Stanton Friedman's reports are packed with information and sterling insights into complex issues.

All rights reserved: ZetaTalk@ZetaTalk.com



[Mail this Page](#) to a Friend.

ZetaTalk: Belgium Flap

Note: written on Nov 15, 1995

Periodically UFO flaps occur, and this is by design. They take folks by surprise and by the time everyone is setup to record the incident - they are gone. This also is by design, as the element of doubt remains. The flap creates discussion and debate, and *some* evidence always exists to support the argument. During the Belgium flap significant evidence was left, as those in possession of the evidence were credible. NATO radar documented the UFOs during their usual maneuvers, and this documentation lined up with credible witness testimony. As the parties were clearly not in collusion with each other, the evidence was impressive. Nevertheless, as will be the case throughout the Awakening, some were unimpressed.

All rights reserved: ZetaTalk@ZetaTalk.com



[Mail this Page](#) to a Friend.

ZetaTalk: Gulf Breeze

Note: written on Feb 15, 1996

The initial Gulf Breeze incident, reported by a true contactee of one of the hominoid alien groups visiting Earth, was genuine. This was a carefully planned series of sightings, which succeeded in that dozens of highly credible witnesses stuck to their story. Ed Walters received an inordinate amount of harassment for having reported this, but to his credit he stuck to his story. Unable to break the man, his detractors set about to defame him, and when this failed to stick they played their remaining card - false follow-on sightings. Gulf Breeze is periodically rumbled with reports of fresh sightings, but these are staged. All of this is intended to crowd the stage so that Ed Walters will be less noticed, and to some extent this ploy has succeeded.

All rights reserved: ZetaTalk@ZetaTalk.com



[Mail this Page](#) to a Friend.

ZetaTalk: Mexico City

Note: written on Sep 15, 1995

The initial UFO sightings over Mexico City, during the celebrated eclipse, were genuine, and for obvious reasons. So much anticipation, folks from all over the world, video cameras at the ready - to film the eclipse! This was an intentional sighting, to press the envelope on the Awakening. Since the establishment could not possibly confiscate every video, they chose to counter this undeniable sighting by clamping down on the news. Did the Mexico City UFO Flap hit the news - CNN, TV, major newspapers, front page, even the back page? In the main it was utterly ignored, and not because it wasn't newsworthy. Man not alone, UFOs exist, undeniable proof - this is not newsworthy? As with the Air Force and pilots in general, reporters have learned that their life is so much simpler if they leave the alien issue alone. Why try to fight a battle you cannot win? Even MUFON is dictated to, in this regard. They can only report what is approved.

After the initial, genuine, flap, Mexico went the way of most - it went commercial. Scores of visitors, bringing good US dollars, running about pointing at the skies. They all need to be housed and fed, and the price of incidentals can fluctuate to meet the demand. In Mexico, too close to being a third world country for comfort, incidentals are hard to come by. All sightings closely following the initial slighting over Mexico City were false. The plasma ships, a concept that doesn't even make sense if one stops to think about it, and the stiff little gray gnome walking off into the night - all hokum. We expect this to continue, however, with fresh variations, as long as interest in visiting Mexico to see for oneself continues.

All rights reserved: ZetaTalk@ZetaTalk.com



[Mail this Page](#) to a Friend.

ZetaTalk: Russian Sightings

Note: written on Mar 15, 1996

Russia has been rich in her history of UFO sightings, and most such sightings are factual. Unlike the sightings in Mexico, which became fraudulent for commercial purposes after the original sighting during the eclipse, the Russian populace could not commercialize on their experience during the communist regime. Thus, the facts were recorded, stories shared among the peasants, and the poetic Russian soul set to pondering a bit more about strange manifestations, but nothing more was made of it. As the rural Russian populace has been isolated from the world press, there was little worry about suppression. They were already suppressed. So the populace was free to chat over vodka about mysterious lights among the trees or marks on the grounds where ships had apparently landed, as no one considered this a threat.

All rights reserved: ZetaTalk@ZetaTalk.com



[Mail this Page](#) to a Friend.

ZetaTalk: Israeli Sightings

Note: written on Nov 15, 1996

In the rash of sightings during the year preceding the millennium, those in countries normally intolerant of mysticism have the greatest impact on the Awakening. Brutally serious, the Israelis have scant tolerance for playfulness or what some might call flights of fancy. They consider themselves under assault from all sides, and anything less than sober and grounded guardedness to be in essence an act of treason. Thus, when sightings are simultaneously reported by large numbers of Israelis, the world takes this seriously, knowing the source. At the least, such sightings would have been investigated, without delay, by the highly paranoid Israeli air force. Unless also officially observed, the sightings would not be reported.

That mass sightings *were* reported and accompanied by a personal encounter makes these reports all the more startling. The sober Israelis, who all but prosecute false stories so as to save their energies for the very real emergencies their lives are constantly called to address, would surely have given anyone reporting a personal encounter a hard time. It was for this reason that the contactee, who had requested this role and knew full well what to expect, was left with a residual coating of powder to back up his story.

All rights reserved: ZetaTalk@ZetaTalk.com



[Mail this Page](#) to a Friend.

ZetaTalk: Colorado Flap

Note: written on Dec 15, 1995

The Colorado sightings, filmed by Tim Edwards, are a fraud, even though a number of individuals are involved. As for the video footage examined and verified by a former NSA agent at the Village Labs in Arizona, how likely would it be that the truth would emerge from the hands of a former government agent, sworn to uphold national security dictates? Some members of MJ12, having lost the battle to suppress awareness of the alien presence, still want to control the process. Thus, rather than assist those experiencing *real* sightings, where the circumstances and individuals involved have already been cast, they stage their own. The problem with this approach is that it invariably contains the slant of the directors, and thus is intrinsically a falsehood adding to confusion and deception - not really a help at all.

All rights reserved: ZetaTalk@ZetaTalk.com



[Mail this Page](#) to a Friend.

ZetaTalk: CSETI

Note: written on Feb 15, 1996

CSETI is an organization fronting for the establishment, not at all what it claims to be. Under the guise of seeking contact with extraterrestrials, and supposedly succeeding, they hope to accomplish the following objectives:

- Denying the existence of MJ12. While not directly addressing MJ12 they are suggesting that the leadership *should* develop contact with extraterrestrials. This gives the impression to their readership that this contact doesn't currently exist.
- Denying the nature of The Call. The Call for contact is being given incessantly by humans *and answered* promptly by aliens on Earth at this time. By asserting that they achieve success at certain settings and by certain rituals, they are giving their readership the impression that they succeed where others have failed. The opposite is true. They have *not* succeeded, and are lying, while true contact is being made by the sincere individuals giving The Call.
- Denying the nature of the Transformation. The Transformation is not and will not be accomplished through the establishment, though they would love for this to be the case. Accustomed to control and the eyes of the populace pointed their way, they are *asserting* this as a truth, hoping that the populace will swallow this. Transformation efforts utterly bypass the establishment, and thus, in their frustration, they founded CSETI.

When CSETI did not have the success they hoped for with their earlier campaigns, they changed tactics. The populace virtually ignored them in their me-first contact escapades, so they gave this up almost entirely and switched to a pro-active role in the Awakening process. CSETI openly challenged the legality of MJ12's operating procedure, which made good press but will amount to nothing. In fact, since MJ12's charter allows them to take the life of anyone breaking their oath to MJ12, there will be no volunteers who are genuine MJ12 members. Nevertheless, this tack has stirred interest in the possibility of a secret government existing, and to this end is beneficial.

All rights reserved: ZetaTalk@ZetaTalk.com



[Mail this Page](#) to a Friend.

ZetaTalk: Dr. Greer

Note: written on Apr 15, 1999

The [Announcement](#) on July 3, 1997 by Steven Greer, CSETI's leader, that he suffered from a "metastatic malignant Melanoma" when no primary site had ever been identified reflects the changing nature of UFOlogy and most especially the fate of any who align themselves closely with strong armed factions of the establishment. This was not done by MJ12 nor any other arm of the government. Malignant Melanoma did not develop naturally in his body. This is a particularly sadistic form of murder, as a metastacized Melanoma will likely not be eradicated and could be expected to result in a lingering and painful death. Such a move is not made to silence someone, but to set an example for those who might be thinking of following in his footsteps.

This is a frequent means used by the CIA to punish people. They infect them, with something the body has a great horrific time getting rid of. It's a horror that people step away from, like being infected with AIDS. They become remarkably cooperative. Dr. Greer was much more in hand in the past and began stating that he wanted to become a bit of a rogue, be more truthful with people, and those who were his former handlers could not tolerate that. We of course are speaking of the people in the CIA whom we have little love for. Dr. Greer has nevertheless proceeded in a courageous manner and is moving however slightly in the right direction, so it has not stopped his message and his determination to steer away from the original CIA plan and toward a more truthful message.

All rights reserved: ZetaTalk@ZetaTalk.com



[Mail this Page](#) to a Friend.

ZetaTalk: Dr. Reid

Note: written on Jan 15, 1999

The story by a certain Dr. Reid of a confrontation in the woods with an alien, which he managed to club into near death, is false.

Certain elites who do *not* wish to see humanity embrace visitors from other worlds are becoming desperate. These people are used to the thought that they have a captive slave class, much like the kings of old or lords whose serfs could not leave because where could they run but to the next lord's lands where they would be caught and returned, a virtual slave class. The thought of the Earth being constricted, delimited, where citizens must carry passports and the like is comforting to those individuals at the top of the pile who have come to think of the working class as their virtual slave class. Now in come visitors from outer space, chatting with them in the woods, meeting with them in ways that can't be measured by the police force or those who might tap the telephone lines. This is very unsettling. It's as though their slave class was escaping.

Their reaction, no matter how illogical, is to try to convince humanity not to speak to aliens, to fear them. This reaction is much like governments who try to keep their citizens in control by stating that their neighbors are about to invade them, or are planning to lob poison gas over the borders. This creates a wariness and ensures that the people feel entrapped and therefore obey and pay attention to the rules and procedures laid down. This is an attempt to turn humanity away from alien visitors and their warm embrace, to ignore the intrigue and interest that the average person feels when contemplating visitors from other worlds.

These elites put forth the concept of confrontations with aliens, and of course confrontations are not to be where the aliens eliminate the humans, as that makes the lords and masters here on Earth seem powerless. So rather they are confrontations where if anything humans are going to be able to do away with hostile aliens. They hope in this that the average man will cling to his establishment and run to the military in hopes they will protect them, or run to the church. Likewise the notion that an alien can be killed by a human is patently ridiculous. How do they suppose we got here? Clearly our technology is advanced. Why would we or any visitor blithely walk into humans without a defense? It should be clear that we can disappear into other dimensions, and likewise any visitor on this Earth can do so. Why would this escape not be used when club is coming down? It's silly, and invariably these frauds are proved false.

All rights reserved: ZetaTalk@ZetaTalk.com



[Mail this Page](#) to a Friend.

ZetaTalk: UFO's in Africa

Note: written on Mar 15, 1996

Africa has a unique experience with regard to UFO sightings, as this continent is targeted by aliens in the Service-to-Self orientation who hope to get a foothold on the Earth during the Transformation, where they would otherwise lose out entirely on a world scheduled to become a home for the Service-to-Other. Sightings in Africa, therefore, are not as elsewhere where they are a gentle nudge toward the Awakening. Sightings in Africa are not meant to intrigue, to set the curious to asking questions or the casual observer to pondering. They are, rather, within the bounds of the restraints imposed on ambassadors from the Service-to-Self by the Council of Worlds, meant to intimidate. Thus, where sightings elsewhere are most often observed by adults, recent sightings in Africa have been experienced by impressionable children.

All rights reserved: ZetaTalk@ZetaTalk.com



[Mail this Page](#) to a Friend.

ZetaTalk: Mt. Shasta

Note: written on Nov 15, 1995

Ourselves and other alien groups in the Service-to-Others reside in 3rd Density on the surface of your planet, but for obvious reasons do not take up residence out in the open or in populous areas or fertile land farmed and tended. Wilderness or inaccessible places have proved to be the best homes, and this includes mountainous or desert areas. Mountains hold natural caverns, most of which have never been discovered by humans, and the caverns are ideal - capacious, secure, and temperature and humidity controlled. Mt. Shasta holds many such caverns in its vicinity, and is indeed home to more than one group of aliens in the Service-to-Other orientation. As with other such sites, UFO's are occasionally sighted and word gets around. Contacts are not, however, made any more frequently at such sites than anywhere else. The reason is obvious. Should contact occur more frequently there, crowds of people camping out might ensue, as contactees not uncommonly linger at or return to familiar contact sites as this aids them in their recall process.

Drawing crowds and remaining secure in a hidden home are activities at odds with one another. Any reports of making contact at Mt. Shasta are therefore either wishful thinking or spinning yarns.

All rights reserved: ZetaTalk@ZetaTalk.com



[Mail this Page](#) to a Friend.

ZetaTalk: Call Down a Ship

Note: written by Jul 15, 1995

Regarding deliberate attempts by humans to communicate openly with us by signaling our craft, hoping for a response. This is a point of much confusion among humans. Are they not giving The Call? Why are we seeming not to respond? We are not allowed to dance in the skies at your request. The Call is personal, relating to a chat with the person, and this is done by speaking to the subconscious as your mass consciousness has not yet risen to the level where we can present ourselves consciously. You give The Call, and may not know consciously that you have done so. Likewise, whether you consciously or unconsciously give The Call, we will respond to you in your subconscious. If you recall this, because you meditate or undergo hypnosis, our response may appear in your conscious. However, when presenting this to the mass conscious, your public, your recall can be questioned, and this is by design.

If we cannot dance in the skies at your request, then what are all the reported sightings about? There are several criteria that must be in place before a sighting can occur. First, all who will be able to see the ship, in 3rd Density, must be sufficiently acclimated so as not to be alarmed. Second, the sighting must not be able to be recorded on any media that cannot be disrupted. This precludes live TV, for instance. Personal cameras do not stop a sighting, as we actively destroy film in personal camera at the present time. The picture simply does not develop. Third, the overall impact of reports of the sighting must not trip the balance among other groups, such that they move from curiosity to fear. Where humans complain when a local sighting is not reported broadly, this in fact furthers our progress. The locals can be acclimated, at their own pace.

However cruel this may seem to those who desire contact, openly, with us, we must consider the welfare of the mass. Most humans are aware that aliens exist, but are only comfortable with this on a theoretical basis. Meeting face-to-face is another matter. Dealing with the hard reality is another matter. Fireside chats about these matters, when one is comfortably at a distance, is much different than finding out that it is all so true.

We will relate this to an experience where an explorer packs up and plans a hiking trip. Yes, he knows that wild animals roam the forests and hills. Yes, he knows that the wild animals potentially to be encountered will not harm him, as they are deer or elk or small wild cats or foxes and the like. Nothing that would undertake an attack on a human, and in fact, quite the reverse. The explorer sets out, all confident and well prepared. Then off in the hills, all alone and at some distance from civilization, the explorer encounters a fox. Both freeze. The fox is in fact terrified, frozen in its tracks, but the explorer, never having seen a fox before, is subject to all kinds of misinterpretations. That mad gleam in the fox's eye, which is in fact terror, is interpreted as unmitigated fury and determination. That fluffy tail, which is in fact a defense mechanism of the frightened fox, is seen as the fox's preparation to attack. Long after the fox has bolted into the woods, the explorer will find his heart beating wildly, and he will be uneasy for the rest of the trek.

Therefore, while we appreciate attempts to call forth a meeting, by individuals or groups, we cannot have these meetings in your conscious. We would suggest, to those feeling disappointed, that they check in with their subconscious. They may be pleasantly surprised!

All rights reserved: ZetaTalk@ZetaTalk.com



[Mail this Page](#) to a Friend.

ZetaTalk: Mass Landing

Note: written by Jul 15, 1995

Regarding mass landings. This will not occur. This rumor has been spread by Service-to-Self groups, periodically, because of the fear and anxiety this engenders in humans. This is by design, as frightened humans are more easily pushed into becoming recruits for the Service-to-Self orientation in that these emotions tend to focus one on the self. There will be no mass landing. None. The Council of Worlds will prevent this, and in fact has prevented this in the past. As such a happenstance is much desired by the Service-to-Self, they have of course pushed endlessly for this. Why has this not occurred to date? Because controls are in place. We will relay that the only circumstances that would allow for a mass landing to occur would be for the majority of the Earth's inhabitants to turn to the Service-to-Self orientation, and by majority we mean that almost 100% would have to be at that point. This high percentage is required, as the Service-to-Self are not given to free will latitudes, being coercive intimidators.

To those in the Service-to-Others orientation, however, the concept of free will is natural. Those in the Service-to-Others are *not* striving to raise the anxiety level or frighten humans during the Awakening. In fact all aliens visiting Earth at this time are required to record a visit only in the subconscious so as not to trip the balance in the general populace, as the orientation of the future Earth has been, by vote of Earthlings, to be Service-to-Other. It is not ourselves in the Service-to-Others orientation, therefore, who would benefit from rumors of a mass landing.

Reports of pending mass landings periodically make the rounds. As this will not be allowed, why do these reports continue to emerge? The answer lies in looking to who benefits from the reaction to these reports. As we are restrained by the Rules of Engagement from discussing activities of those in the Service-to-Self, we can say no more regarding any specific rumor.

All rights reserved: ZetaTalk@ZetaTalk.com



[Mail this Page to a Friend.](#)



ZetaTalk: Crop Circles

Note: written on Jul 15, 1995

Humans have always stood in awe of [Crop Circles](#) as you can be assured this is not the first era where they have been prevalent. They speak to the subconscious, which sees the patterns and senses their meaning, and the conscious hasn't a clue. What is their meaning? Crop Circles are telling you, in a universal language, of coming events, and we are speaking here not only of physical events, such as the pending pole shift, but spiritual as well. In the past these simple but eloquent messages were left, with increasing frequency and urgency, leading up to the shift. This time, because of the Transformation, there is more than one message to relay. What are these messages, and why not simply speak them, or leave written word? Well, of course contactees are receiving these messages, face- to-face, but what about the rest of the world. Crops Circle creation is managed by a group of aliens that cannot participate in the Earth's Transformation in any other manner, as they are a life form that lives in the *water*, and thus their ships are filled with the atmosphere that they breath - water. Thus, this is how they serve.

Observers have noted that Crop Circles seem to appear almost instantaneously. They blink, and then notice that something is different in the vista before them. By what process is this accomplished? If space ships are landing and impressing the ground, then the time seems too short. If rays of energy or a force field are involved, all this passes the notice of the observers. Crop Circle creation does not require a landed ship or physical force. The grain lies flat because the structure of the stems has been altered, one *side* of the stem rapidly growing in a process the reverse of what occurs when growing plants bend toward the light. This growth spurt occurs low to the ground, the particular ray, like laser surgery, focused there. The swirls are created due to the circular motion of the affecting ray, which circles like the hand of a clock, dropping the grain stalks such that they fall almost simultaneously.

Are Crop Circles more effective than words? Absolutely. They register in many parts of the brain, and tell the story with greater depth. A picture is worth a thousand words. Symbols are used to relay astronomical occurrences, effects of one planetary body on another, motion and direction, pace, change, and for those who have sensed their meaning, they also relay ratios and relative force. Stand before these pictures and let your subconscious speak to you, and see the forest and the sky, rather than the trees. Are not the patterns being presented in increasing complexity, in step with your Earth's internal response to her approaching brother? Crop Circles began with a simple circle, stating that the Earth is unruffled in her orbit. Then dual circles and rings, relaying the approaching interaction between the Earth and her brother, the 12th Planet. The rings, of course, are the influence of gravitational pull, increasing. Long lines connecting circles - does the 12th Planet, acting as a comet, not have an approach? Peripheral circles - the other planets in your Solar System, or in the wider system that comprises the 12th Planet's journey.

And what of the Scorpion Tail, the connected and curving series of dots? Does not the comet travel with an entourage of minor moons? As the giant comet dominates with its gravitational field, the moons are not pulled into conflict regarding their place. They trail after their traveling master, like little ducklings in a row. Would not the 12th Planet's moons circle, as do moons humans are familiar with? Where the orbiting motion of moons is assumed to be due to a balance between the centrifugal force of the moon and attraction to the home planet, there are other variables. The orbiting moons are in motion because they are reaching for the Sun and other planets, like a twirling dancer forever undecided on a partner.

The helix, misinterpreted by many to be a DNA strand, is a pictorial representation of the Earth's rotation and the manner in which it begins to align with the rotation of the approaching 12th Planet. As we have explained, the Earth's rotation is caused by the motion of elements in the Earth's core attempting to escape or approach influences in the wider solar system. The Earth's rotation is already slowing, a fact noted by your scientists and various excuses already published in the media. To those who would disbelieve that the 12th Planet's influence could be that strong from afar, we point to the delicacy of many matters in nature. The Earth's normal rotation is a careful balance taking into account all the factors in the solar system and beyond. It takes but a feather to trip the scales when they are perfectly balanced, and the 12th Planet's influence on the Earth from afar acts in this manner.

The ball of overlapping circles, all touching an inner circle, is meant to convey a new phenomenon occurring on Earth, preparing those who see it for the manifestation of this phenomenon. The Earth's magnetic field currently curves far out in space, so that on the surface of the Earth a compass almost always points north. Increasingly, as the Earth's swirling core is pushed to line up in opposition to the magnetic field of the approaching 12th Planet, it will send out minor magnetic fields that do *not* point due north, but wrap back into the Earth in the manner portrayed by the overlapping circles.

Crop Circles present an opportunity to understand, at a glance, the decade ahead. As the pole shift approaches, they will present an accurate weather prediction, a guide to family affairs, a time table for settling matters and preparing for the future, the truest touch stone that mankind will be given. Visit them often, if only in picture form, and let the message soak in.

All rights reserved: ZetaTalk@ZetaTalk.com



[Mail this Page](#) to a Friend.

ZetaTalk: Crop Circle Clues

Note: written on May 15, 2002

Mankind often complains that crop circles are not *clear* in their intent, their message. It is clear they are increasing in complexity, often have circles that might be considered planets or suns in a solar system, and their relationship by some force or another. We have stated that the makers of genuine crop circles are speaking to the subconscious of man, which understands the message even if the more rigid conscious resists. The subconscious understand the body language of someone afraid, or feeling sexual, or resentful. The conscious is aware that the rules of society are being followed, the right clothing worn, and the schedule on time. Thus, the conscious views crop circles and puzzles over them, but the subconscious understands.

Mankind is aware, both subconsciously and consciously, that the weather has become unpredictable, the poles melting, and the fauna and flora about him migrating and behaving out of keeping with what is expected. They see the Moon with halos about it, the jet stream passing clouds overhead in odd ways, and note that *no one* seems to have an explanation outside of what seems silly. If Global Warming is the issue, then why does the US excuse itself to pollute merrily away? What crop circles are presenting is the relationship between the inbound planet and the *other* planets in the solar system.

- Where a scorpions tail is presented, this is the manner that the Moons of the inbound planet trail a traveling planet. Thus, the message "traveling" has been given.
- Where several planets are placed with lines drawn between them, this is presenting the many pushes and pulls that planets have against one another. One such force is gravity, which both pushes and pulls, another is magnetism. There are many *other* forces that affect the placement of planets in the ecliptic, but man is unaware of these particle flows so we will not expound.
- Where crop circles were simple at first, a single circle, this message was, they are static, established, and the push and pull balanced so what you see perpetuates itself. What we call the equilibrium of the solar system. When more circles are entered, and lines drawn, this represents the equilibrium being disrupted.
- Large designs such as snow flakes, where there is a branching from central points, these central points then connected, are relaying yet another message. *Each* of these planets has it's own kingdom, and influences its own moons and the like. Yet they likewise affect each *other*.

We would suggest those curious about the meaning of these genuine crop circles do through their history, placing them on a table by date, and pass their eye over them. They will see the equilibrium of the solar system being disrupted as these circles progress over time. They will get the *feeling* of what is happening to the solar system, where many planets and moons of these planets are exhibiting a disturbed equilibrium, changing, heating up, or whatever. Once having gotten that *feeling*, the conscious is allowing the subconscious to speak more loudly, and this should be allowed to continue. Never mind what other humans have told you are the explanation for crop circles, *you* listen to your subconscious.

All rights reserved: ZetaTalk@ZetaTalk.com



[Mail this Page](#) to a Friend.

ZetaTalk: Circle Locations

Note: written on Feb 15, 1996

Where crop circles do occur worldwide, they receive more press and attention in certain countries, most notably Britain. Crop Circles occur just as often in third world countries, but where one is faced with starvation, crop circles take a back seat. Long after the harvest, there is little to investigate. Britain was once the supreme superpower, ruling the waves with her ships, and her people long yet to be first at *something*. Consequently, due to the press that is given crop circles in Britain, some of the *best* crop circles have been placed there in anticipation of good press coverage.

All rights reserved: ZetaTalk@ZetaTalk.com



[Mail this Page](#) to a Friend.

ZetaTalk: Crop Circle Video

Note: written on Jan 15, 1997

During 1996 several breakthroughs occurred in the Awakening. Genuine implants were dug out of contactees and examined by scientists, real UFO's were captured on video and shown to the public by CNN, and a crop circle was filmed in the making. Filmed under circumstances that could hardly be questioned, the video nevertheless was roundly criticized and pronounced to be a fake, which it is *not*! Where crop circle fraud, or at least fraudulent claims, had been running parallel with the real thing in England, here was the real thing! It has taken a bit for the reality of that fact to sink in, but the validity of the video is now beyond dispute. It stands as testimony beside the human witnesses who have stated that crop circles are laid down almost in an instant, something no human hand could accomplish.

All rights reserved: ZetaTalk@ZetaTalk.com



[Mail this Page](#) to a Friend.

ZetaTalk: Crop Circle Hoaxes

Note: written on Sep 15, 2001

Crop Circle hoaxes appears early in the game, when the populace became aware of legitimate crop circles and entranced by them. Hoaxes were led at first by the CIA, as an arm of MJ12 and nervous government heads, particularly during the Reagan/Thatcher era. England, as we have mentioned, was a choice location for legitimate circles as the populace is intelligent and given to puzzle solving, and publicized their circles well and with great pride. The early Hoaxes were simply bumpkins announcing they had laid them with boards, and demonstrating this. This took time, did not bend without breaking the grain, did not make perfect geometry, and left footprints all over the area, but the media was instructed to give these bumpkins credit and being run basically by the establishment or friends of the establishment, they did as instructed.

In 2001, a new brand of hoax appears, which was quickly recognized for what it was. Not given the major media coverage that the early hoaxes were granted, these were left to be examined by talk shows and the public, who quickly recognized the crude and unfamiliar characteristics. Where legitimate circles have perfect geometry, are laid down almost instantaneously and without footprints, and leave the grain bend and *growing*, these lacked all of those characteristics. More particularly, they were designed, rather obviously to be *understandable* to the public, with recognizable features and symbols - the Face on Mars, data sheets, and automobiles. *More* grain was trampled than left standing, a technique to cover footprints, and any geometry imprecise. Who did these hoaxes in 2001, and why?

Factions have developed in the establishment, often running in different directions. Early in the cover-up of the coming pole shift and alien presence was determined to fool the populace about the coming pole shift until the end and retain the respect of the populace by keeping them ignorant of the alien presence. But in by 2001, a major faction had decided that alerting the populace in some way about the coming earth changes would allow *some* to survive and become farming communities, thus taxable and able to be ruled by an elite. Likewise, since the alien presence was making itself known, absolute denial would lead the populace to ignore the establishment, a loss of respect. However, within the establishment, resentment of the new approach lingers, and it was these rebels who perpetrated the hoax, desperate to get the upper hand in some manner. Expect this to be followed by announcement of the *human* perpetrators. Few who have viewed legitimate circles will be fooled.

All rights reserved: ZetaTalk@ZetaTalk.com



[Mail this Page](#) to a Friend.

ZetaTalk: Renewed Circle Hoaxes

Note: recorded during the May 11, 2002 Live ZetaTalk IRC Session.

Re the Chilbolton circles, which show a face and a pattern akin to binary code or radio - there are several indications that these are man-made, not genuine.

1. They do not follow the previous pattern, which is mysterious and circular, *not* rectangular and obvious.
2. They are crudely done, with broken grain which will not grow again and grain bend in all directions.
3. They are not the *size* of genuine circles, being tiny not massive, and thus able to be done by man in his fakery.

So what was the point? Why were they done? The early debunkers claiming to have done the circles with boards, in England, got lots of media attention but were not, frankly, believed by the public. Those running the debunking program wished for a fresh start, and these circles are an attempt to get back into the media. After awhile, the plan was for them to come forward and present video of the making, and thus debunk afresh that crop circles are alien.

All rights reserved: ZetaTalk@ZetaTalk.com



[Mail this Page](#) to a Friend.

ZetaTalk: Future Circles

Note: recorded during the May 11, 2002 Live ZetaTalk IRC Session.

Crop Circles will appear as long as a place to draw them exists, right up until the shift itself. If grain fields become scarce, then desert sand might be used. As in Australia lately, carving rock strata might occur. In that the mankind will be more fearful, more likely to be in touch with their subconscious, over this next year, going into the shift, circles will have *more* impact and thus will most likely appear more *often*. They will, we predict, get less media coverage than before, becoming a local phenomena. But the impact may be greater for this, as visiting such as creation has an impact far beyond simply seeing pictures.

All rights reserved: ZetaTalk@ZetaTalk.com



[Mail this Page](#) to a Friend.

ZetaTalk: Windmill Hill

Note: recorded during the July 27, 2002 Live ZetaTalk IRC Session.

This newest, and magnificent, crop circle shows a [Closing Circle](#), *not* the relationship between celestial areas of influence only somewhat affecting each other. Notice the closing circle, the tightening noose. What is this saying? That the time for distance, and nominal, affect, is *past*. It is saying that the hand that was only swatting at you, from afar, causing a whistling wind past your ears, is now *gripping* you by the ear, and shaking you! *No* more wondering about equilibrium, and what we mean by this when we explain how a planet so *far* away can affect your weather. Now you will see this monster approach, and your governments quake as the increasing earthquakes, as it is *upon* you! *This* is what the newest circle in England means, in case this meaning escaped your notice.

All rights reserved: ZetaTalk@ZetaTalk.com



[Mail this Page](#) to a Friend.

ZetaTalk: Crop Circle Correlation

written August 8, 2003

The 6 appearing in various crop circles represents different aspects of Planet X, coming together, as well as a time sense. This has been a repeating theme of crop circles lately, so the point will not be missed.

- Nancy has lately noticed that a third persona has appeared, in the form of a red cross, in photos, very recently. As the planet gets closer, red light that scattered before and did not form into a persona of note is now dense enough to be noted. This will not be the only aspect of Planet X of note, and when listed will encompass 6 - the red dust in the tail, the moon swirls, the debris that becomes meteor showers, the red persona which carries the volume of light, the white persona which represents the physical placement of the corpus, and the newly emerging persona of the red cross. During the week of rotation stoppage, these aspects *come together*, which the August 3, 2003 **Boroughbridge** circle shows.
- In the August 4, 2003 **Walker's Hill** circle, there is a pointed reference to increasing size, over a 6 day period of the Planet X complex as viewed by the human eye from Earth. This 6 day period nicely matches the 5.9 day period of rotation stoppage before the shift, and this interpretation was the one intended by the makers. Crop circles are always given in a universal language, and a day, a full rotation of the globe, is something all cultures record in some manner or another.
- Nancy has also noted that the July 20, 2003 **Hackpen Hill** circle has 6 circles after the small circle, and surmised this meant days of rotation stoppage after the 36 hour day when rotation rapidly slows to a stop. Here again the largest circles are related to visibility during that week, the increase in only days to that point.

All this leaves to conjecture just when rotation stoppage will occur, which is by design. As we have stated repeatedly, to give a date would allow those who would murder hundred of millions of innocents advance notice and opportunity to implement their plans.

July 20 Hackpen Hill

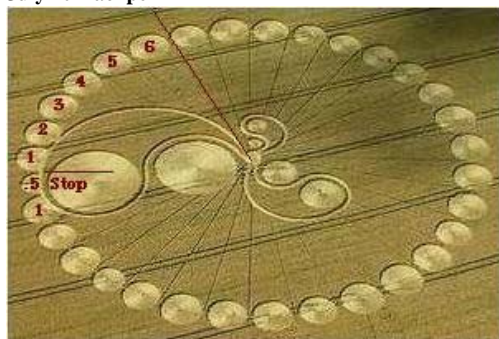

August 3 Boroughbridge



August 4 Walkers Hill

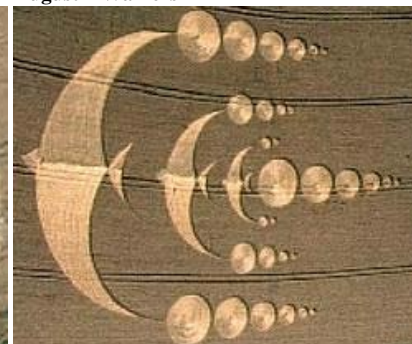



[Mail this Page](#) to a Friend.

ZetaTalk: 2003?

written Dec 12, 2003

Is a pole shift still a Certainty? Regarding the Ecliptic Rise analysis, what impact might these various approaches (left, right, under, or over, into Earth's orbital plane) have on Geographical safe/unsafe locations, or the approximate stated 5.9 day window of stoppage/shift? I would imagine the Zetas took all of this into consideration.



Though resented by many, who are looking for specific dates by which to wend their way through the obligations that human social structures place on them, our *lack* of specific dates have distressed the elite, which would impose Martial Law and bring pain and anguish to the *majority* of the world for their benefit, should *they* know a specific date. This includes those who moan that our lack of specificity, and the White Lie, have distressed them, however real their distress might be. Work and school schedules, bill payments, family vacation plans, business arrangements, all stand in front of any survival plans, for those more aligned to the social structures than to their own instincts for survival. This is not *our* concern, but *your* concern, in this regard. In all these matters, only *you* can decide the right timing, the right choices, for yourself. We are not your parents, and would suggest anyone in anguish over this take their complaints to NASA and the White House, and demand to be informed.

Martial Law, the entrapping and poisoning of hundreds of millions, the herding into work camps, the bonds of slavery at pain of mutilation of your children before your eyes, these are only a few of the horrors that awaited you. Their plans required *exacting* timing, as we have explained endlessly, and though we could tell you not only the date and hour of the shift, but also the likely *minute*, we have been an endless dilettante regarding the specifics the establishment needed for their evil plans: the distance of Planet X during the Spring of 2003 and into the present, its exact location among the personas that appears in photos or to the naked eye, its likely pause points, points when it changes direction, points when the magnetic fields will clash and to what degree. *All* have been withheld, to save the *majority* of mankind from the horror they cannot imagine, in their desire for convenience in their schedules.

In 1995, when we stated what the heralding signs of the approach of Planet X would be, we studiously did *not* include Moon orbit aberrations, Earth orbit aberrations, or the Earth's rise in the Ecliptic which has occurred periodically to place the S Pole of the Earth above the N Pole of the approaching Planet X. It can be quickly ascertained that *all* heralding signs we predicted had a human explanation thrown into place going into this time. Global Warming for weather changes, additional quake monitors for the increase in quakes, increasing asteroid traffic, and especially solar flares for magnetic irregularities and interference with power grids and satellite communications and even by implication what is sighted next to the Sun by millions, the Second Sun. Why did we leave *out* the orbit irregularities? Note there is *no* explanation, or even discussion of these. Caught with their pants down, on something the common

man cannot miss, the Moon in the wrong place, and the Sun rising and setting too far south!

We would suggest to those wondering just what date will mean what change, when to stop paying bills, make their move, risk the anger of those who are firmly in denial, that they look to *this*, the utter lack of explanation from the establishment, the media in lock step with the cover-up, for their explanation of *why* no clue as to when major earth changes will slam the Earth will come from us. They are *still* not telling you! They *still* hope to ease their path, better their control of you in the Aftertime, by keeping *any* information they have to themselves. What more proof do you need for their agenda than to look at the Moon, the Sun, the skies, and understand that *no* explanation is forthcoming from NASA, the observatories and scientists they control, the politicians bought and paid for, and the media so diligent about bringing you the news that this is the *last* thing you hear about, the *biggest* news of your lifetime!

It should be noted that the body of ZetaTalk, collected over the years and representing great consistency and accuracy, is valid, with the exception of the date of passage.

ZetaTalk: [Earth Changes](#)

The Earth, Sun, and [Planet X] will thus Form a Triangle in the Earth's orbital plane with a 23 degree angle at the Earth, an 18 degree angle at the Sun, and a 139 degree angle at [Planet X]. It is at this point, essentially, that [Planet X] is closest to the Earth, as with the angle of entry into the Earth's orbital plane being 32 degrees at this point, [Planet X] essentially dives up through the Earth's orbital plane and quickly passes on.

ZetaTalk: [Entry Angle](#)

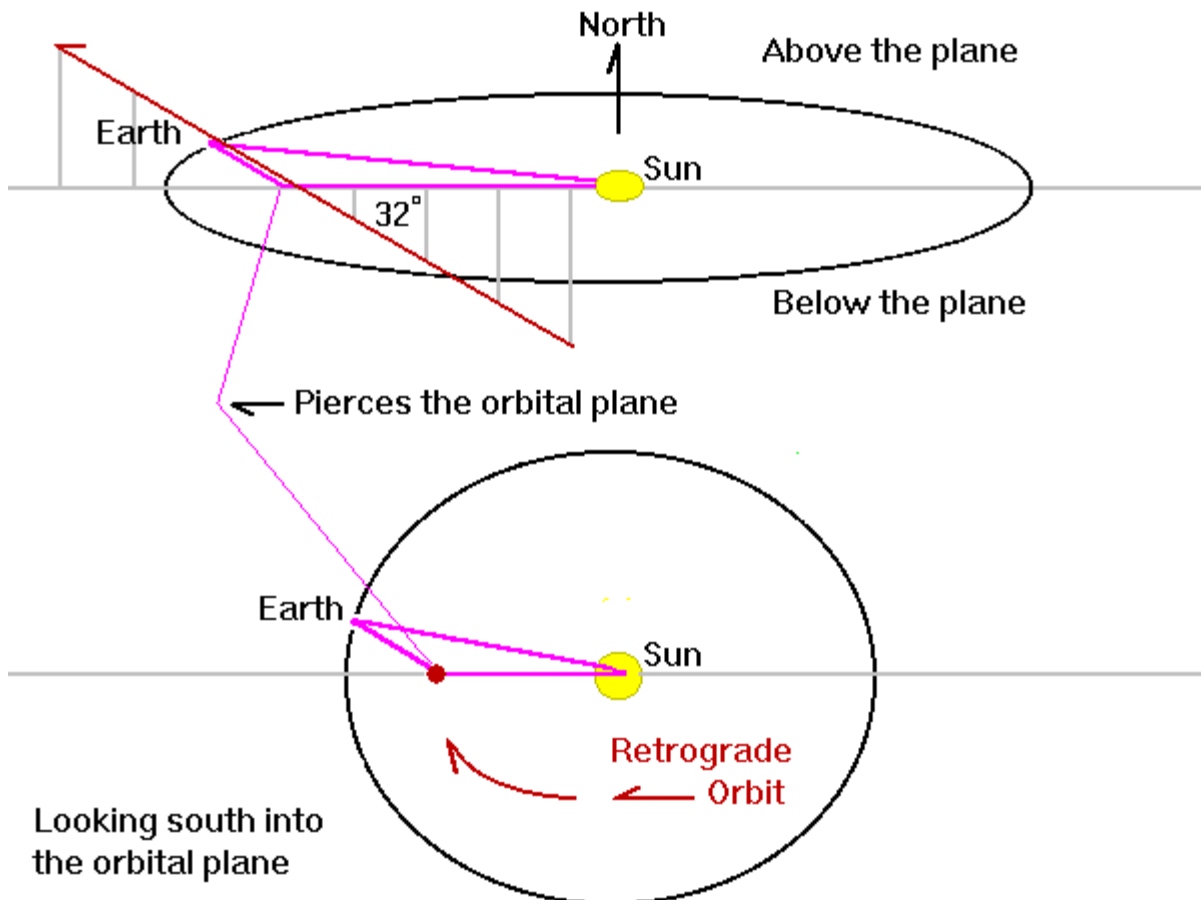



[Mail this Page](#) to a Friend.

ZetaTalk: Swept into Disaster

written during the Jan 30, 2004 Lou Gentile Show

As we have mentioned, surprises in the dance between the Earth and the approaching Planet X have, overall, proved a disaster for the cover-up, and a benefit for the common man. For all the exacting detail we relayed on the effects of the shift and precursor events such as the increasingly erratic weather, worldwide crop disasters, increasing illness, the lineal increase in earthquakes and volcanic activity, and most impressively the exact location during 2001 and into May, 2003 where the inbound Planet X could be sighted in the skies, there were occurrences we *left out*, deliberately. No mention was made of the orbit changes the Earth would take in her attempted evasion of Planet X, lifting up to a higher Ecliptic plane and lately halting and reversing her orbit. No mention was made of the tilting the Earth has done, while in the grip, magnetically, of the monster magnet Planet X. No mention was made of the reflected light the Moon and Venus would show at this time, absolute evidence of light from Planet X. Taken by surprise, the cover-up artists stand in stunned silence while the common man makes note.

In that we wish to continue to cause the cover-up to stumble, we will not reveal cards yet to be played, steps in the dance between the planets that *we* know will occur, but the cover-up artists will be ignorant of, and thus stumble and expose themselves. But it is no secret that the [Sweeping Arms](#) of the Sun, occurring as the classic crop circle depicting them shows, about 8 times a year, with regularity. These arms are what cause the planets to all orbit in one direction, as they are *swept* in that direction. The last arm swept by Earth around Dec 25, the next expected by the anxious humans watching the drama to start around Feb 9, 2004. Each sweep causes the Earth to move forward *toward* Planet X, and the monster moving in a retrograde orbit to jump *over* the arm toward Earth, suddenly. The last sweep halted the Earth in her orbit, and she is now scuttling backwards in an attempt to escape. This has put continuous stress on the Earth, as the sweeping arms are always present to some extent, pushing her forward into the magnetic jaws of Planet X. A trap. A squeeze. An [Unshakable Grip](#).



The next sweep will force the two planetary magnets closer together, with the Earth, as always, the loser. If crust movement disasters have been on the increase, this is only a hint of what will occur when the magnetic grip on the Atlantic Rift forces serious and steady slowing in the Earth's rotation. Quakes will increase, disasters related to crust adjustments will increase, as though from a cry to a scream. Take the effect of exploding gas lines and refineries, ruptured water mains and dams, collapsing buildings and industrial accidents, derailed trains and capsized ferries and ocean going vessels, disconnected or dropping bridges and emerging sinkholes, and multiply them ten-fold. Serious slowing will commence, a certain sign we have mentioned as rule *one* in the watch for when to expect imminent disaster. No longer confused by manipulation of sunrise and sunset times by the Navy, no longer confused by tilting or bobbling of the Earth, but a clear steady beat of the drum warning of certain and imminent disaster.



[Mail this Page](#) to a Friend.

ZetaTalk: Tilting, Leaning, and Dropping

written Feb 29, 2004

Have you considered posting more info about how off positioned the constellations and planets are? The moon and whatever planet or star is always near the moon are way off, and Orion is too far south from my view here in Eugene, Oregon.

As we have stated recently, there is strong evidence of the Earth rising up or as has recently occurred, down in the Ecliptic, as many note the sun too high or low in the sky. Tilts are also in evidence due to a different arch in the sky painted by the Sun, different rising and setting points for the Sun, and weather and cold patterns. But what does this do to the view from Earth of the constellations? A tilt will cause them to be presumed to be too far south, if the tilt of the Earth is toward the Sun, or too far north if the tilt is away from the Sun. Imagine a rowboat on rough seas, where the prow of the boat is pointed *up* along a wave crest, the boatsman surprised to find his view of the shore below him. A tilt will also change the direction of east and west. Imagine this same boatsman finding his boat rocking to and fro, such that his left shoulder is much *above* his right, due to the restless waves beneath him. He glances to his left, expecting to find the shore line, and finds he is missing the shore, as his left and right shoulders are not level. Were the Earth merely [Tilting](#), computations would be simple, but it is currently also *leaning* and [Dropping](#) below the Ecliptic. All this changes the view of constellations, as N/S and E/W has changed somewhat, and the degree to which the viewer must look over the curvature of the Earth to view the constellations has changed.

Where is the Earth, on this date, in relationship to Planet X? Remarkably, and not at all by accident, the ZetaTalk [Triangle](#) which we detailed in 1997, and which appeared in dual July 4, 2003 Wisconsin [Crop Circles](#), describes the position these planets are assuming. Planet X, as we have described, has its N Pole leaning toward the Sun's S Pole as it passes this pole and rises to the Ecliptic, the Sun's middle. This causes Planet X to swing *its* S Pole outward, back in the direction from whence it came, Orion, as S Poles repulse. As it is moving in a retrograde orbit, it is carrying this skew toward Earth, which it encountered on or about Dec 25, coming toward it. The Earth reacted by moving *its* S Pole away from the S Pole of Planet X, as S Poles repulse, thus assuming a reverse skew and tilting its N Pole in toward the Sun.



What does this triangle say about a drama about to occur? We have stated, in our cagey dance with the elite and their plans to murder hundred of millions of the Earth's populace outright, and selectively exterminate others, during the coming pole shift, that *any* maneuver that will discombobulate the elite is justified, including confusion about what the dance of the planets will bring. We have stated that rising and dropping in the Ecliptic, a move of the globe that can hardly be missed by the common man, was *not* predicted by us, nor the erratic movements of the Moon, nor the reflected light from Planet X that cause the Moon to be full days earlier and longer than anticipated. Thus unprepared with a prepackaged excuse, the elite fall mum, saying nothing, and the common man takes note. We have stated variously that Planet X would come to within 14 million miles of Earth during its passage, and elsewhere that it would

pierce the Ecliptic approximately mid-way between Earth and the Sun, and recently, that the Earth would [Draw Nearer](#) the Sun during this drama, both because of increased gravity giants on one side and because of the magnetic grip of Planet X upon the hapless Earth. Thus, the ZetaTalk triangle shows Planet X *closer* to the Earth than a mid-way point, as the Earth will move in.

Is tilting, leaning, dropping, and now tightening up the last phenomena, the last card to be played? Hardly. We note that the elite have *still* not informed the public, the taxpayer, the little man used as drones in the work trenches, of what is to befall them. They are *still* making their own arrangements, stock piling goods, defending the perimeters of their enclaves, all without a word to the hard working families which they have used as virtual slaves, fodder feeding their arrogant demands for comfort and power and prestige, caring not for the lives of innocents or the pain denial of this vital information will cause. They still harbor in their hearts a desire to entrap and enslave the common man, though expectations of being able to enforce Martial Law when the date seems so uncertain are fading. Blame anyone for the lack of a certain date, blame *them*, as they are the *reason* no date can be given.



[Mail this Page](#) to a Friend.

ZetaTalk: Orbit Lock

written May 29 2004

The incidence of 6 or more arms, seen in so many crop circles over the years, all with a central point indicating, obviously, the Sun, is an unmistakable clue that there is a pattern to the orbits around the Sun, guided, nudged, sorted out and placed, by something emitted from the Sun. In this particular new Arkansas circle, the counterclockwise motion created by these emanations is likewise clear. Where the Sweeping Arms of the Sun were shown with a pattern of 8 per year, the emanation that controls the orbit *distance* from the Sun is paced with 6 or more sweeps per year of another kind of emanation from within the Sun itself. These crop circles with diagrams of 6 or more always have an outer edge, indicating they are not infinite. Thus a planet halted in its orbit, as Earth is, finds itself reminded of this distance more often than when traveling ahead of this particle flow sweep. This reinforced reminder comes at a time when Earth is frantically trying to escape the magnetic grip of Planet X, but, as we have stated, it cannot.



Arkansas
May 22-23, 2004



Burghasungen
Germany, 2000

Why do the planets select an orbit *ring*, and stay in it? Venus and Earth are the same size, but Venus rides closer, Earth further out. By what rule do they stay in their lane, even when seldom close to each other, and almost always apart by large spans of space? Each planet stays at the outer edge of a particle flow emitted from the Sun, that outer edge where that planet is comfortable, the flow not creating a crowded particle flow for that planet as an independent system. Since we have stated that Earth once rode an orbit within the Asteroid Belt, and after collisions with Moons trailing Planet X during one of its many passages arrived at its new orbit, this might seem a contradiction, but the mass and composition of Earth changed at that time. It lost much of its core material, exploded into space as magma, the stuff asteroids are composed of. It lost the majority of its water, spewed likewise into space, the stuff comets are composed of.

This crop circle is reminding mankind that Earth *cannot* escape Planet X by leaving its orbit. It cannot *leave* as gravity is pulling it into the Sun. There is more than the Repulsion Force, the outward flow of gravity particles, keeping the Earth at the distance it steadfastly maintains. There are hundreds of such particle flows, almost all unknown to mankind, controlling orbits. Earth is positioned at the distance from the Sun she is, as at this point the crowding of this particle within her system as an independent center is not creating a bumping outward away from the Sun. Earth has come as close to the Sun as she can, and there is locked in her rut, her orbit. As the Dark Twin likewise cannot leave his orbit, and has come up behind Earth creating havoc if the Earth attempts to back up away from the oncoming Planet X, this lock into orbits is doubly significant. Can't move back. Can't move in. Can't move out. Can't move forward, as there stands the monster Planet X!



**Boroughbridge
UK, 2003**



**Marlborough
UK, 2003**



**Teg down
UK, 2003**



**Burham
UK, 2003**



**Etchilhampton
UK, 2002**



**Wylatowo
Poland, 2002**



**Barbury Castle
UK, 2002**



**New Zealand
2002**



**Züsch
Germany, 2001**



**Beckhampton
UK, 2001**



**Milk Hill
UK, 2001**

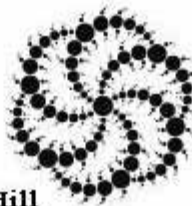

**Zierenberg
Germany, 2001**

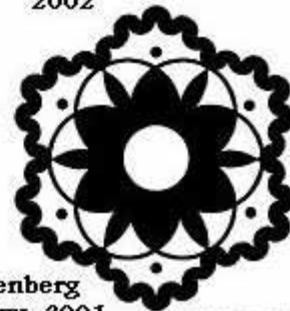

© FREDDY SILVA 2001



**Lockeridge
UK, 2001**



**Southfield
UK, 2003**



[Mail this Page](#) to a Friend.

ZetaTalk: Magnetic Trimesters

written June 6, 2004

Why is it the Sun, as the giant magnet dominating the solar system, points North and South with its poles in the directions it does? For those late to this argument, the Sun does not reverse polarity every 11 years as NASA states, and the solar [Magnetic Field](#) reaches beyond the outer bounds of the solar system, affecting all the planets. The Sun likewise is under the dictates of influences that surround it, and as the Sun goes, so go the planets. We have mentioned that there are hundreds of particle flows that reach out from the Sun's middle as it rotates, the most obvious particle flow the one that brushes the planets along in their counterclockwise orbits, known as the [Sweeping Arms](#) of the Sun due to their regular [Impact](#) during the staring contest between the Earth and Planet X. The Sun likewise is subject to sweeps, from elsewhere, which affect her internal gyrations such that dozens of the particle flows moving into and out from the Sun are affected, and this passes down to the lowly planets circling the Sun like litter caught in a whirlwind. Since man is still arguing over our simple explanations of how gravity and magnetism work, and is still sputtering that that their assertions about the Sun's polarity reversals is correct, despite their own Ulysses probes findings, we decline to detail all these particles flows as it will only result in endless theoretical arguments by those with big egos and small minds. But will address their impact on Earth and their relationship to some recent crop circles.

We have explained that [Orbit Lock](#) occurs because planets are held away from the Sun at the particle crowding point they can tolerate. More than the gravity repulsion force is at play in holding them away from the Sun, as hundreds of particles crowd toward the Sun. Some particles reach the crowding point, the orbit, and *return* to the Sun at that point, a roiling that is a tug on the planet riding that orbit. Like a ship on a tossing sea, the planet is subject to this roiling. For the Earth, one of those particle flows is in the electromagnetic spectrum, and varies three times during an Earth year as [HAARP Documentation](#) shows. These flows affect the planets orbiting the Sun regardless of their placement around the Sun, as it is an outburst from the Sun, not a sweeping arm directed and in synch with the Sun's rotation. Thus, the Earth's halted orbit does not allow her to escape its influence nor affect the timing.

Summer Trimester (May-Aug)

Normally a time when the outburst is strongest. And as can be seen by a comparison for the Summer of 2003 to the year before, the influence of Planet X coming into the inner solar system created a conflict for the Earth. During this trimester, Planet X was skewing its poles to align with flow lines on the opposite side of the Sun from the Earth, creating a dissonance.

Fall Trimester (Sep-Dec)

Normally a time when the annual outburst is diminishing. And as can be seen by a comparison for the Fall of 2003 to the year before, as the Earth approached the point where Planet X was entering the inner solar system their conflict lessened as they both moved to share flow lines on the same side of the Sun. In December, when the Earth halted in front of the approaching Planet X, in fact almost striking a chord.

Spring Trimester (Jan-Apr)

Normally a quiet time when the outburst is quiescent, just ahead of the yearly burst during the Summer Trimester. And as can be seen by a comparison for the Spring of 2004 to the year before, with the Earth and Planet X being in close proximity, there is little discord.

What will happen during the coming weeks, when the Summer Trimester continues during a time when Planet X is rising to the Ecliptic such that it will suddenly align with the Sun rather than skew along a magnetic flow line, and when Earth is pressed into Planet X by the crowd of inner solar system planets behind and to either side of it - the Dark Twin, Venus, and Mars. None are magnetic to the degree that Earth is, but add their influence to the distressed Earth

by creating [Whiplash](#) scenarios. Like a magnetic cloud enveloping this grouping of planets and the interloper, Planet X, it will make any magnetic alignment more intense, more violent. This is the message these crop circles are relaying.

Ridgeway, May 25 2004



Falmer, May 28 2004



Beacon Hill,
Jul 4 2003



Stowel
Aug 5, 2001



Arkansas, 2004



Ohio, Oct 2003





[Mail this Page](#) to a Friend.

ZetaTalk: Crop Circle Language

written June 12, 2004

Look this instructive crop circle appeared in Italy [June 2, 2004]. Will we see the Planet X so huge in front to the sun?



There are many clues that bind crop circles together, repeated symbolism, occurring in conjunction with other symbols. The series of embedded circles, ever larger, implies to most all viewer a growing presence or influence, a rapid engulfing, and in the most recent circle in Italy, a rapid supplanting. We have stated that when Planet X moves between the Earth and Sun to the point it blocks or interferes with the Sun as the dominant magnet in the vicinity, the setting for rapid rotation slowing and stoppage and an imminent pole shift will be made. How have crop circles implied this, in a universal language that speaks to the subconscious of all, regardless of the differences a culture may impose or the inability of man to understand the guttural sounds coming from the voice box of another. The bow, swinging from one side of the halo circle to the other, seen in both Italy and Poland, implies a supplanting of influence, a blocking, and is new in 2004. Has a Sun halo not been seen, increasingly, during the last few months? The eye, at the center of the squeeze, links many circles and their symbolism. Whether coming up from the South, below the Ecliptic, as implied in Ohio, or from the side as implied in Britain circles, the squeeze is the same, to force a side by side alignment of the Earth's magnetic fields with those of Planet X. This is confirmed again in the most recent eye squeeze from Britain, where the lay of the circle is clockwise, the retrograde orbit and rotation direction of Planet X.

What in sum is the circle in Italy saying? That Planet X is moving past the Sun in a direction that will take it closer to Earth, implied by the direction of the engulfing circles away from the Sun. That it will move from slightly below the Ecliptic to above the Ecliptic during this drama, shown by the small circles placed within the concentric circles. And that a full 90° turn will be the result, the pole shift, implied by the placement of a new pole in the Earth at a 90° offset from the magnetic key in the Sun.

Britain
Sep 9, 2003



Poland
May 15, 2004



Ohio
Aug 24, 2003



Britain
Aug 3, 2003

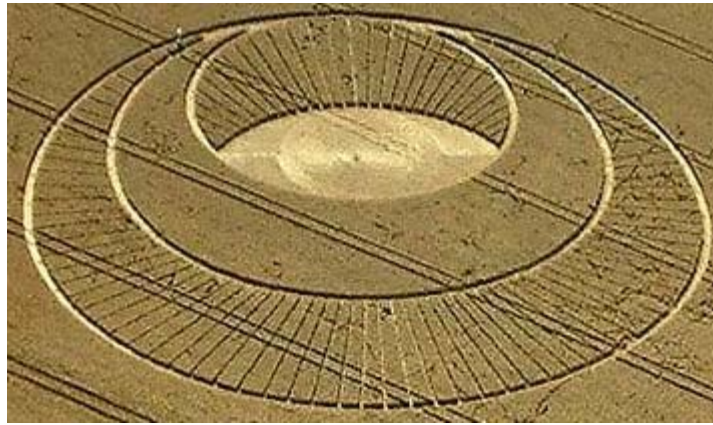



[Mail this Page](#) to a Friend.

ZetaTalk: Magnetic Resonance

written June 16, 2004

Crop circles try to relay complex concepts with simplicity, and thus often show their relationship to each other by simple symbols so the complexity can be comprehended. We have stated recently that [Magnetic Trimesters](#) exist, a fact that can be determined from the [HAARP](#) documentation, and that crop circles with a distinct pattern of three curved arms, such as Beacon Hill and Ohio below, relate to these trimesters.

Beacon Hill

Jul 4 2003



Ohio Oct, 2003



Both these circles above are showing their relationship to another symbol, the evenly spaced balls around the outside of a circle, something occurring in syncopation to the magnetic sweeping arms. Thus, when this same pattern of three balls evenly spaced around a larger ball appears, shown recently in Falmer below, the syncopation relationship to magnetic trimesters is inferred. What is also inferred is that this syncopation of *three* is repeated, outward, from the Sun, a resonance during the trimesters.

Falmer May 15, 2004



In that a year ago in California *two* balls were shown in the trisection points, and in Ohio just four months later this same two ball formation is shown leading into a *dumbbell* formation, a progression is shown. California implies that

the balanced trimester resonance is normal, but Planet X, coming in from beneath the Sun, forces a distortion in the resonance. Ohio shows that this disruption is caused by the angle of approach, not directly under the S Pole of the Sun but approaching at an angle. This angle also creates a distorted resonance within Planet X.

California June 27, 2003



Ohio Oct 2, 2003



A common symbol in crop circles is also the timeline, a series of steps along a line. In the recent Hertfordshire crop circle the pole shift is shown to be related to magnetism. During the approach the normal resonating trisections around Planet X are distorted into two dumbbells due to the closeness of the Sun. The closeness of Planet X distorts the resonance the Sun emits outward, represented in the midsection of the crop circle, into a distorted resonance. But as Planet X passes the Sun, moving from the S Pole to align with the Sun's magnetism and exiting on the N Pole side, a dramatic change in the polarity and position of Planet X as it leaves the solar system sets this back to the normal resonance configuration. It also, during this transition, creates a 90° crustal shift in the Earth. This is not simply the Earth adjusting to the passage of a large magnet, Planet X. It is that both Planet X and Earth are in a maelstrom of magnetic particle flows, distorted, and eager to establish the usual balance. Both mere flotsam, in the magnetic sea.

Hertfordshire June 11, 2004

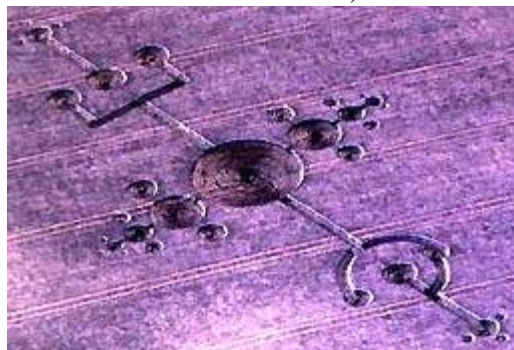



[Mail this Page](#) to a Friend.

ZetaTalk: Flow Lines

written June 18, 2004

We have explained that as Planet X approaches from beneath the Ecliptic at a 32° angle and moving toward the Sun's S Pole it [Tilts and Leans](#), first turning its S Pole away along the line of approach, the magnetic flow line on that approach, and then swinging its S Pole to the other side as it passes under the Sun so as to line up with the magnetic flow lines on the other side. At present, these flow lines are causing Planet X to assume a 45° angle from the magnetic alignment of the Sun. This can be seen in crop circles laid down on the same day in Canada and Britain, Aug 8, 2003. Planet X has a retrograde orbit, clockwise, and this is the direction of sweep in the key shaped symbols, often embellished with lines indicating the direction of magnetic flow lines, which tighten as they approach the Ecliptic, the center of the dominant magnet, the Sun.

West Overton: Aug 8, 2003



Saskatchewan: Aug 8, 2003



We have explained that the [Normal Alignment](#) for magnets is either end-to-end or side-by-side, so that having a large magnet swinging up at an angle along the magnetic flow lines is a stress on all other magnets in the vicinity, of which the Earth is one. There is a tug to align with the 45° tilt of Planet X, and the normal insistence to remain in a side-by-side alignment with the Sun. The side-by-side alignment is represented by parallel lines along the time line, with a clear indication that Planet X changes position in this regard *more than once*. The cupped circle, at the ends of the times lines in the Aug 8, 2003 circles above, represents Planet X punching through the Ecliptic where it can at last make a rapid escape from the inner solar system. Does Planet X thus move to align first with the flow lines on one side of the Sun, during its approach, then swing to align with the flow lines on the other side of the Sun as it passes beneath the Sun, then align side by side as it arrives at the Ecliptic, then swing *again* to align with magnetic flow lines above the Sun as it prepares to exit? What would this do to the Earth, caught in an [Unshakable Grip](#), during these throes.

Manitoba: Aug 12, 2003

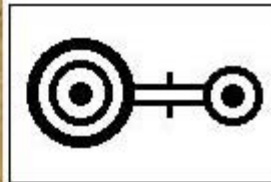

Ontario: Jul 23, 2003

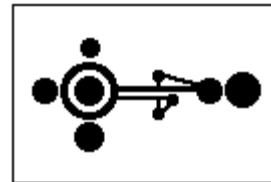

Ringmer: Jun 15, 2004



Nancy was quick to note that the dual crop circles that appeared on July 4, 2003 in Wisconsin contained our [ZetaTalk Triangle](#). They also contain the 45° angle of tilt Planet X assumes along the magnetic flow lines as it approaches the Ecliptic where it will suddenly assume a side-by-side alignment with the Sun. Why then are there *two* sets of parallel lines in this circle? Because as Planet X goes, so goes the Earth, in the [Twirling Wobble](#) we suggested would soon

occur. It is currently tilting toward the Sun and leaning toward Planet X, a situation that became more extreme over the past few months so that the Sun is in the extreme north, the Sun arc high, many degrees beyond what is expected for Summer in the northern hemisphere. The dance that will occur as Planet X dances past and through the Ecliptic is complicated and full of surprises. Once again we remind the establishment that if they wish to have forewarning on these matters, they are *still* not sharing what they know with the common man, are *still* maintaining the cover-up, and until the common man hears our message at the same time the elite do, there will be surprises, for all.

Wisconsin: Jul 4, 2003

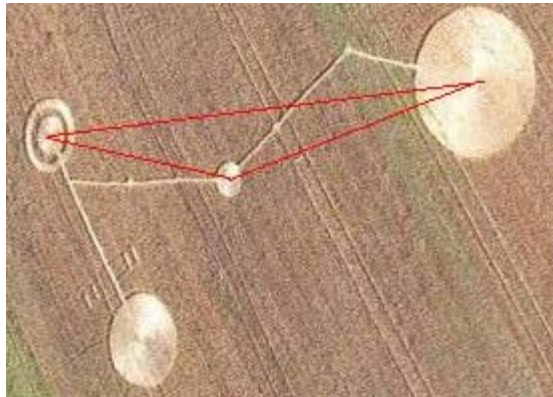

Wisconsin: Jul 4, 2003





[Mail this Page](#) to a Friend.

ZetaTalk: Serpentine Dance

written June 23, 2004

The mysterious Yin Yang symbol, interpreted endlessly to be the balance between male and female, aggression and passivity, the dark and the light, or any balanced element both physical and spiritual that the human mind and soul can encompass. Interaction, the one growing, the other diminishing, is inherent in the symbol. Crop circles have included not only the Yin Yang symbol but a type of serpentine linking of such symbols. They also indicate that at the *center* of a Yin or Yang half there is an orb, a planetary body. What happens when the magnetic fields of planetary bodies, with dissimilar rotation directions, intertwine? We have stated that planets with magnetic fields, like all magnets, want to align end-to-end or align side-by-side, but due to the forces that hold planets in their orbits and at a distance from their Sun, they most often align along magnetic flow lines also. Enter Planet X, which is not establishing an orbit that circles a Sun but is slinging through. Of all the planets in its path, crowded around the Sun in the inner solar system, Earth is the only one that finds itself in a magnetic dance with Planet X. Mercury is too close to the Sun, and escapes because Planet X by its mass is held at a further distance from the Sun. Mars is outside of the sling orbit of Planet X, and escapes as a peripheral body. Earth lies *in* the path of Planet X, as its orbit is *crossed* during the passage.



We have stated that the orbit of Planet X assumes a retrograde orbit as it approaches the Sun, hopping the sweeping arms of the Sun to escape the crowding these arms impose. More than the orbit of Planet X is affected by this, and the rotation of Planet X, a slow roll, also assumes a retrograde motion. The sweeps, being a particle flow, move *all* of the planet, core, crust, and mantle, from the outer edges of the planet in, during the Sweep, and *this* effect is what creates the rotation direction. It is no mistake or accident that the rotation of the Earth is counterclockwise, as this is its orbit direction. This is the direction both the planet and its molten mantle assume, nudged by the sweeping arms. The effect of the sweeping arm, enveloping the Earth as shown in a recent crop circle from **Honey Street**, impels the rotation of Earth counterclockwise, *but*, the arm has a different influence on Planet X, moving clockwise and rotating clockwise as it passes through the inner solar system. This is a clash, a reversal for Earth when it encounters the massive field of Planet X, and thus the serpentine influence, as in **Tistead**. This is also shown as a blocking influence, as in **Windmill** and **Ontario**, where the rotation direction of the magnetic fields directly *clash*. Who wins in this? It is no contest, and one of the reasons for Earth's rotation slowing to a stop during the passage is this clash. The magnetic field of Planet X is slinging *at* Earth's field, a constant barrage, as the distance between them closes.

West Tistead
Jul 20, 2003



Honey Street
Jun 16, 2004

July 20, 2003
Hackpen Hill



Jun 21, 2003
Waden Hill

Jun 7, 2003
Windmill Hill

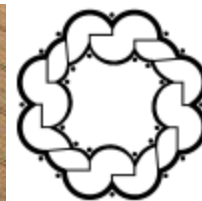

Ontario
July 30, 2003

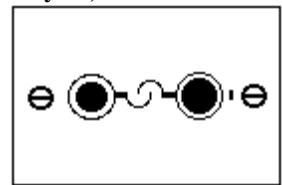

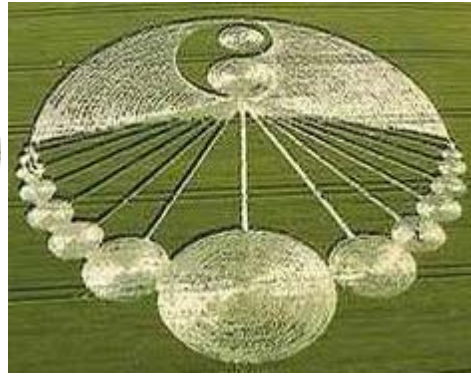



[Mail this Page](#) to a Friend.

ZetaTalk: Slow 270° Roll

written June 25, 2004

The pole shift has been described, at its simplest, as the S Pole of Earth being dragged along with the N Pole of Planet X, thus turning the Earth on its head or nearly so, this process stopping before it is completed with a 90° turn of the crust. In that Planet X moves along the magnetic [Flow Lines](#) of the Sun as it passed the Sun's S Pole, creating a [Tilting and Leaning](#) of the Earth in its stalled orbit, it is clear that *neither* planet retains an alignment with the Sun during the passage. In addition to the flow lines, both planets have magnetic fields that rotate, in the direction of their respective orbits, which creates a [Serpentine Dance](#) entwining their magnetic fields and forcing a blocking of the Earth's field when they clash as Planet X massively outweighs the Earth. The Earth will experience more than a twirling wobble during the passage, more than a simple 90° turn during the hour of the shift, as a complicated magnetic dance is about to ensue, beyond what man might imagine. If the distorted [Magnetic Resonance](#) detailed in [Herfordshire](#) will result in an 180° reversal of Earth's core and a 90° adjustment for the crust, what steps occur prior to this hour of radical change?

The possibilities range broad, and as we have repeatedly stated, we are not going to be specific until the establishment starts to share what *they* know with the populace. Thus, the possibilities listed below should be considered *speculative*, at this time.

- Both planets simply line up with the Sun's magnetic orientation, side-by-side, with the Earth grinding to a halt as the rotation of the magnetic fields clash and the Atlantic Rift as a magnet on the crust is gripped. In view of the complexity of the crop circles recently laid down, this seems too simplistic.
- Planet X temporarily assumes the 45° tilt and lean along the flow lines we have indicated, pulling the Earth into a 23° tilt and lean toward Planet X, both implied by [Woodingdean](#). But there is a hint of a different alignment directly out from the center of the Sun.
- Planet X remains on the flow lines of the Sun, increasingly at an angle to the Sun, causing the Earth's tilt to be more extreme, until, as [Magnets Do](#), the Earth is in an extreme tilt, almost lateral to the Sun, the Sun virtually rising at the N Pole as seen from Earth. Again, given the complexity of recent crop circles, not the last dance, but implied in [Fort Nelson](#) in the angle of the small bodies, planets, caught in the magnetic maelstrom.
- Planet X, finding itself tilting along the flow lines while *close* to the Sun, does a slow roll to align with the Sun at its middle, the S Pole slung away from the Sun's S Pole, this direction and momentum continuing until it rolls 270° to click into a side-by-side alignment with the Sun. This is implied in [Eastfield](#), a 270° roll both before and after the timeline.
- Planet X does more than one 270° roll, as the fastest way to align itself again with magnetic flow lines after piercing the Ecliptic, as implied in [Eastfield](#), the second roll culminating in the passage where the visible presence of Planet X increases enormously during the week of rotation stoppage. The timeline implies a position of Planet X *prior* to the passage that include angles of 45° on either side and a 180° reversal in between.
- Planet X first approaches creating wobbles in the orientation of the Earth as it passes the Sun's S Pole, then a tight lock while rising through the flow lines to the Ecliptic, then slinging the Earth in a radically different orientation (denoted by the beak) during a 270° roll, and then halting the rotation of the Earth as the Atlantic Rift is gripped in line with Planet X. Both [Gopher](#) and [Woodborough](#) imply this.

And where is the Earth in all of this speculation? More than a twirling wobble is implied. More than a 23° tilt and lean. The Earth's magnetic field participating in a slow roll *with* Planet X such that no one on Earth could deny that something is amiss. The cover-up, blow apart and shattered, without warning. The panic the establishment hoped to avoid suddenly upon them. The controlled panic the establishment hoped to gain by open discussions on the issues such that the populace is aware of what to expect, and what to do, and when, no longer possible because they had failed to degrade the cover-up and focus rage on the perpetrators in time.

Hertfordshire
June 15, 2004

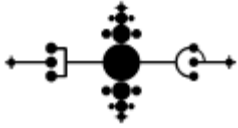

Woodingdean
June 15, 2004



Ft. Nelson
June 11 2004



Eastfield
June 20, 2004



Gopher
June 21, 2004



Woodborough
Jul 27, 2003





[Mail this Page](#) to a Friend.

ZetaTalk: Buzz on Out

written July 3, 2004

We have stated that of the [Magnetic Trimesters](#) the current time, Summer in the northern hemisphere, is the most volatile, and that crop circles with three points around a circle represent the trimesters. We have also stated that the [Magnetic Resonance](#) has become lopsided, due to the presence of Planet X, such that one side of the solar system has become weighted, heavy, and distressed. Why is it that Planet X is ejected so rapidly from the solar system, that after a pole shift human reports do *not* relay a lingering fire dragon in the sky, but rather a long day or night of horror and then living in gloom and drizzle and leaving the shattered cities? A mere week, during rotation stoppage, when there is without a doubt the presence of a monster with a writhing tail near the Sun. Does Planet X leave more rapidly than it approached? We have relayed repeatedly that Planet X struggles to pierce the Ecliptic, drops from a 11° angle below the Ecliptic to a 32° angle for the passage, due to crowding at the Ecliptic. To what degree is a slingshot effect, ejecting a body that has created an imbalance, come into play? The Ecliptic is where a backwash of particle flows return to the Sun, and Planet X is heading *into* this backwash as it attempt to leave the Sun, thus creating additional crowding. It is not the direction of particle flows that matter, it is the degree of crowding.

What symbolism could the circle maker use to relay the thrumming struggle of this massive planetary magnet, 23 times the mass of Earth, as it attempts to punch through the crowded Ecliptic, facing a massive headwind but driven on its path by the Repulsion Force from the Sun. It presses forward but this creates additional crowding, so is driven back a bit, then another press forward. Is this not the annoying buzz of an insect? It is balance that is sought, in particle flows, and when entering a side of the Ecliptic where this particle crowding is *absent*, the Repulsion Force that has been pressing Planet X forward on its path has free reign. A sudden, and violent, exit from the solar system!

California : June 27, 2003



Milkhill : June 26, 2004



California : June 17, 2004



Ohio : Oct, 2003



Utah : June 29, 2004

Tegdown : June 30, 2004

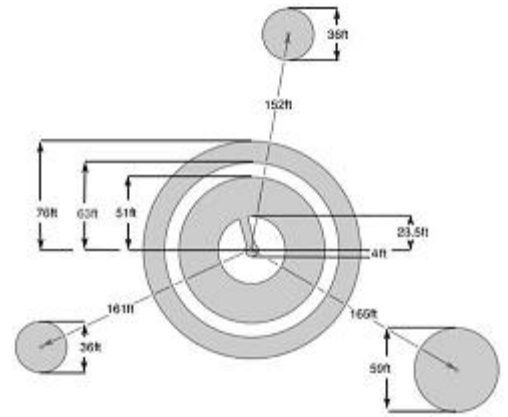



[Mail this Page](#) to a Friend.

ZetaTalk: Asymmetrical Affair

written July 8, 2004

Crop Circles are often noted for their beautiful symmetry, as though painted by an artist. What man sees as beauty is what God has painted, as in nature balance is sought and achieved. We have explained that the planets maintain their [Orbit](#) distance due to a particle flow crowding near the Sun, are [Swept](#) along by an invisible broom of particles, rolled into the [Ecliptic](#) by a backwash of invisible particles, aligning themselves with a [Magnetic](#) field which is yet another invisible particle, and held at bay from the Sun by yet another [Blast](#) of invisible gravity particles. We have described the early signs that Planet X was beginning its passage, in 1995, as a disrupted [Equilibrium](#) in the solar system, the long reach due to the many particle flows that man is unaware of. Crop Circles that present symmetry are presenting the undisturbed solar system, and in a similar manner, Crop Circles that present a chaotic picture are showing you how the passage of Planet X disrupts this symmetry. A common theme, as we have mentioned, is that [23° is the Key](#). One can note, in the Crop Circles presenting an imbalance, that the resolution or exit point represents a 23° angle from the norm.

Why is 23° the key? It is not by accident that a 23° tilt of the Earth occurred during the swift pole shift during the [Last Passage](#) when little lingering during a face-off occurred, as Planet X was *already* at the Ecliptic when the Earth arrived to face it. As we have mentioned, the Earth had barely started into a crust shift when it was jerked back into alignment with the S. Pole of Planet X, now quickly above the N. Pole of the Earth. And this was the angle at which Planet X was *exiting*. The core of the Earth gradually, within days, aligned magnetically with the dominant Sun, but by this time the Earth's rotation had already established itself, thus the offset between the geological and magnetic poles that exists today. If Planet X was exiting at that angle, might this be the angle it assumes, along the magnetic flow lines of the Sun, as it approaches the Earth in her orbit? Asymmetrical Crop Circles are relaying the degree of distress, in crowded particle flows, in conflicting forces, that the passage of a massive magnetic planet *too* close to the Sun for its size, causes. This is not a happy time for man, as weaving too and fro, often with sudden jerks, Planet X creates particle flow distress for the *Earth* as well, in her wake. A wild ride, with many surprises, that explanations such as Global Warming or asteroid swarms scarcely cover.

Market : July 5, 2004

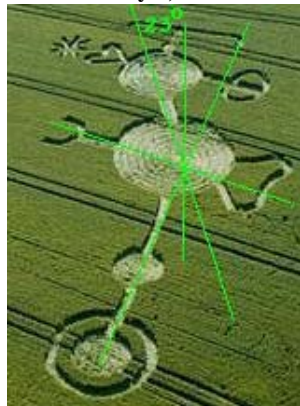

Rabley : June 30, 2004



California : June 17, 2004

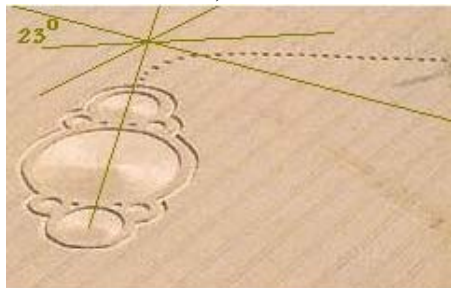

Utah : June 29, 2004



Belgium : June 21, 2004



Woodborough : Jul 27, 2003



Utah : July 6, 2004





[Mail this Page](#) to a Friend.

ZetaTalk: Ready to Tip

written July 8, 2004

We have explained that Planet X aligns with the magnetic flow lines of the Sun as it rounds the Sun just beside the S. Pole, and heads on out toward the hapless Earth halted in her orbit. We stated on June 18, 2004 that Planet X was at that time leaning at a [45° Angle](#), N. Pole to the Sun's S. Pole, in accommodation. A close look at the most recent circle laid in **Coventry**, Britain, shows the placement of Planet X, as it strives to pierce the Ecliptic, to be passing that point along the magnetic flow lines, and poised for a potential [270° Roll](#). The Earth, already leaning toward her brother, will surely notice.

Coventry : July 4, 2004

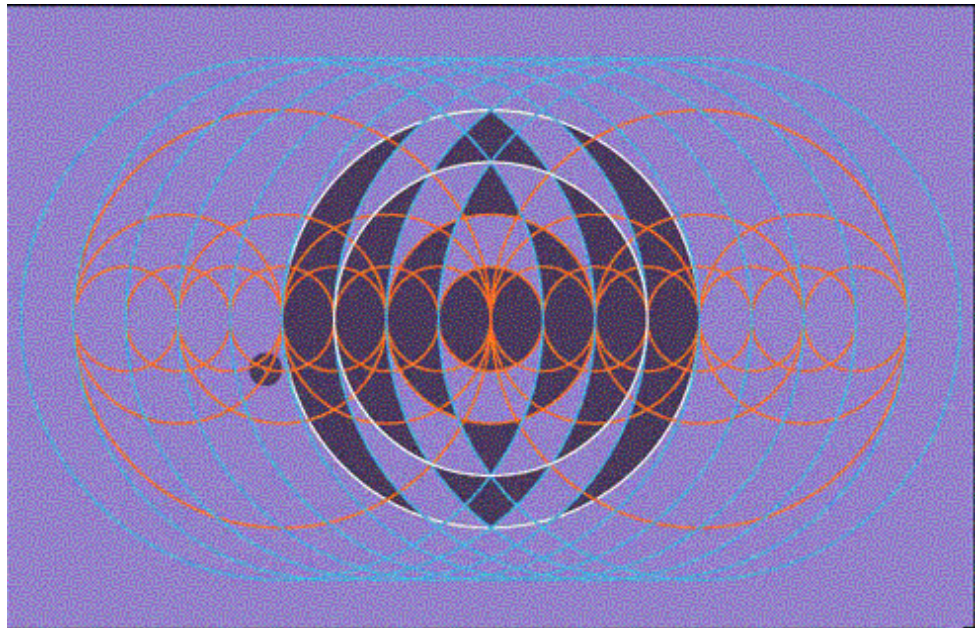



[Mail this Page](#) to a Friend.

ZetaTalk: Juxtapositioned Planets

written July 14, 2004

We have mentioned that an [Engulfing Arc](#) represents the magnetic influence of Planet X supplanting the Sun's dominance. Planet X is rounding the Sun to the right of the Sun's S. Pole, just below the Ecliptic, and is coming almost directly toward Earth, halted in her orbit. The trajectory angle is such that Planet X will shoot over the top of Earth, but before this moment, much drama will occur. We have mentioned the [Tilt and Lean](#) of Planet X as it rounds the S. Pole of the Sun is the factor causing the Earth to tilt and lean, creating at present a Sun rising in the extreme north and a skew such that the noon Sun is in the southeast, and moving steadily in that direction despite the Solstice having passed. We have mentioned that Planet X might assume an almost horizontal alignment along the magnetic flow lines prior to such a roll, pointing its S. Pole outward and thus creating an irresistible magnetic tug for the Earth's N Pole, tilting toward Planet X such that the Sun almost rises over the N. Pole, a phenomena hardly explained away by Global Warming or distracted by terrorism warnings. We have mentioned the possibility of a [270° Roll](#) where Planet X would move to align side-by-side with the Sun's magnetic field by continuing the momentum already established rather than a jerk back. We have mentioned the Earth participating in this roll in some manner.

In Crop Circles depicting the relationship between Planet X, the Earth, and their Sun during these gyrations, numerous juxtapositions of the planets are presented.

The first position shows the planets beside each other, but not bound by a bar. Such a position would occur only where the Sun's magnetic field is dominant for *both* planets, a situation that prevails until Planet X is positioned between the Earth and Sun, supplanting itself as the dominant magnetic voice the Earth hears. This is the current situation, where both planets are on the Sun's magnetic flow lines, and where Planet X is tugging at the Earth, it is not yet dictating to it, as the Earth is struggling to maintain its magnetic allegiance to the Sun.



The second is a position so close they are represented as being stuck on each other, the smaller Earth a literal growth on the body of the larger Planet X. This implies an extreme, and *temporary*, magnetic connection such as might occur during a 270° roll where the planets, as magnets, have their poles lined up end-to-end, momentarily. Where the pole shift we have described is swift, during the course of an hour, and caused by *rapid* movement of Planet X out of the solar system in a slingshot manner as it escapes the extreme particle crowding created by its presence, the 270° roll is a slower process, and thus does not tear the crust of the Earth from her core.



The third position shows the planets held apart, represented by a bar between them, and this forced distance can only occur in a side-by-side magnet arrangement where the flow of magnetic particles around *each* planetary magnet requires some space. This, as we have stated, is the alignment that creates rotation slowing to a stop, as daily the Atlantic Rift faces Planet X or is in opposition to the larger field of Planet X, and is directed to *remain* in a side-by-side alignment. This arrangement, the bar arrangement, is depicted in Crop Circles as occurring as a last step in a sequence, as this is the position just prior to the pole shift.



The sequence is thus that Planet X first creates a tilt, lean, and wobble in the Earth as it rounds the Sun's S. Pole and skews along the Sun's magnetic flow lines. Then creates a tight end-to-end lock with the Earth while rising through these flow lines to the Ecliptic, where Planet X stands almost horizontally along the magnetic flow lines surrounding the Sun. Then Planet X continues its momentum in a 270° roll to align side-by-side with the Sun, creating gyrations in the Earth during this slow roll until the Earth likewise settles into a side-by-side lock with Planet X and rotation

slowing to a stop begins. Crop Circles depicting the entire sequence look scattered or confused, as the various positions in the dance of the planets seems slung from this side to that in the field. Do the planets in fact *move about* during this process? Indeed, yet another part of the drama we decline to discuss at this moment, as the establishment is *still* not sharing the information they have with the public, and has *still* not positioned the media such that our message is received by the public simultaneously to the elite being privy to it. We are implying here TV and radio broadcasts, live. In the mean time, get ready for a magnetic dance of the planets beyond man's imagination.

Czechoslovakia : July 4, 2004 West Kennett : July 13, 2004



Italy : June 2, 2004



Poland : May 15, 2004



Eastfield : June 20, 2004



Gopher : June 21, 2004





[Mail this Page](#) to a Friend.

ZetaTalk: Not Nuclear

written July 18, 2004

An increase in sun spots and solar flares occurred when Planet X first moved into the inner Solar System during the Summer and Fall of 2003, and this is again the situation. At a time when the Sun is supposedly at solar minimum, activity is at an all-time high. These solar burps are insignificant, however, no more significant than tree branches moving under a gentle breeze, and merely reflect a *change* in the particle flow distribution due to the presence of Planet X. This was true when Planet X zoomed at high speed into the inner Solar System in the early days of 2003, creating a disruption due to its speed and then the sudden braking action taken as the Repulsion Force kicked in, both actions a *change* for the existing particle flow distribution. The reverse is true now, with Planet X picking up speed as it has passed the S. Pole of the Sun, and propelled by the Repulsion Force, is preparing to punch through the Ecliptic and rapidly exit the inner Solar System. For those humans anxiously watching the Sun's burps and wondering if their Sun is going nuclear, it is not. The most recent **Woodbridge** crop circle is clearly reassuring mankind, by using the universal symbol for radiation warning, *within* the circle, *within* the Sun, bounded by many layers of protection. Your Sun will remain as you remembered it, and is not the source of danger you need to be concerned about.

Woodbridge : July 13, 2004





[Mail this Page](#) to a Friend.

ZetaTalk: Time Line Clues

written July 18, 2004

We have explained that the [Bow](#) engulfing the Sun represents Planet X supplanting the Sun's influence as it moves increasingly to a point directly between the Earth and Sun. This is again shown in the recent **Southfield** diagram as coming *from the side* of the Sun, and below the backwash of the Ecliptic. From the time the diagram in **Italy** was laid, until **Southfield**, this supplanting of influence has increased from approximately 50% to 60%, for the observant, a timeline to be watched. The circle makers conveniently placed their diagram along field lines to highlight this percentage.

Southfield : July 15, 2004

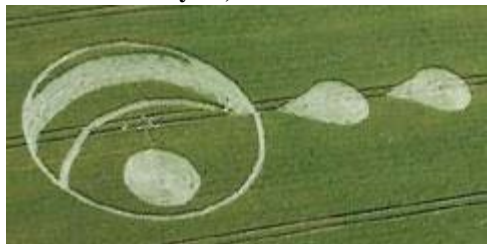

Italy : June 2, 2004



We have explained that the magnetic alignment of Planet X or the Earth, either along the magnetic [Flow Lines](#) of the Sun or in a side-by-side arrangement, are represented by the bars along the time line. In [Asymmetrical](#) diagram, likewise, diverse placements of these instances represent the drama to come as *different* placements of the planets during the dance of the passage. Where two bars exist, this is a single side-by-side arrangement for a *single* planet, but dual bars represent *two* planets in a side-by-side arrangement. Likewise, horizontal bars indicate more than one planet aligned end-to-end along the magnetic flow lines of the Sun. What then is to be made of the diagram at **Pegsdon**, where the 23° angle of exit of Planet X is clearly indicated as it approaches the Sun at a 32° angle from beneath the Ecliptic? Here again a time line clue is given for the astute, as there are *three* magnetic planets in the inner solar system now, Mercury, Earth, and Planet X. **Pegsdon** shows three horizontal end-to-end alignments, then a single side-by-side where Planet X aligns thus with the Sun, then a disturbed switching about akin to the 270° roll we have predicted for Planet X, with separate actions on the part of Earth and Mercury during this time, all prior to the exit of Planet X where it again assumes an alignment along the Sun's magnetic flow lines.

Pegsdon : July 10, 2004



Wisconsin : July 4, 2003

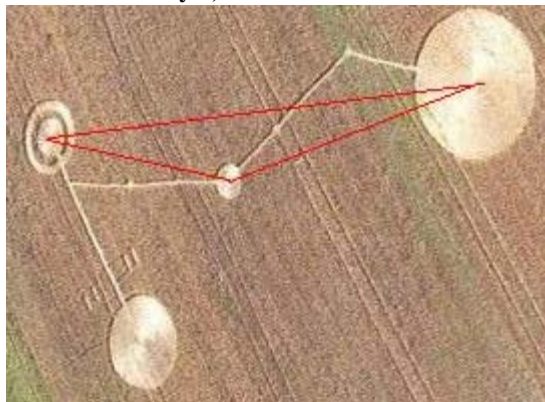

We have referred to the orb with the halo as representing the Sun, often seen with a halo during this past year. What then do dual suns on either side of the Sun represent? If the Ecliptic is a backwash of particle flows, then these

particles emerge from the Sun at its poles. These particles are not magnetic particles which move from pole to pole, but are particles that return to the Sun with a prime directive to avoid crowding, which they do by going *under* or *over* the Ecliptic, the farthest point from which they emerged. Thus those particles emerging at the N. Pole return *under* the Ecliptic, and those emerging at the S. Pole of the Sun return *above* the Ecliptic. The particles involved in this dance are related, just as electro-magnetic particles are related and often dance together. This stability remains, unaffected by the passage of Planet X, but the *reason* the Earth at present has a [23° Rotation](#) tilt is not by accident. As we have explained, as Planet X exits, *its* rotation alignment assumes a 23° tilt to the Ecliptic, and as **Beckhampton** explains, this particle flow is assuming increasing importance as the point of passage approaches.

Beckhampton : July 15, 2004**Rabley : June 30, 2004****Belgium : June 21, 2004**

Clearly reminiscent of the [Insect](#) diagram presented in June, the recent **Windmill** diagram presents more complexity, hinting at the sequence of events that will be encountered as Planet X punches through the Ecliptic. Reverberations of four, then five, then reverberations that pile on one another, so that one does not end before another is on top of it, creating echoes and a lateral spread under the Ecliptic that suddenly dissipates. For those wondering what a reverberation is, we suggest visiting the documentation gathered on what Nancy calls the [Sweeps](#), where planets halted in their orbits before the monster Planet X, coming at them in its retrograde orbit, are battered by the various sweeping arms of the Sun as they are forced into each other and ricochet back and forth. For those watching the sweeps, and the patterns they present, this again is a clue to the timeline.

Windmill Hill : July 17, 2004**Milkhill : June 26, 2004**





[Mail this Page](#) to a Friend.

ZetaTalk: Mirror Ecliptic

written July 27, 2004

We have stated that long [Line](#) diagrams with distinct angles represent steps over time. Planet X has slung past the Sun's S. Pole at 45° angles, will assume a lateral position, then a [270° Roll](#) to reach the heart of the matter, as **Pewsey** states, where its entry to the Ecliptic will be mirrored during its exit. This mirror can be seen in **Pegsdon**, where the slight angle difference from the 32° approach to the [23° Exit](#) can also be seen. Due to the rapid exit that Planet X makes after piercing the Ecliptic, it does not align with the magnetic flow lines of the Sun as it did on its approach, nor does it force the other planets into compliance with its orientation.

Diagrams, which imply, like a necklace with beads balanced on either side of a large center stone, as represented in **Margery** and **Waden Hill**, are speaking to the [Sling Orbit](#) of Planet X. The fight with the Ecliptic is not present on its return passage 7 years later, as it pierces the Ecliptic on its approach to the Sun, going *with* the backwash particle flows. The intensity of the backwash at the Ecliptic is show as increasing near the Sun, the true meaning of the heart shape in **Pewsey** and the dew drop shape in **Southfield** and the pointed overlapping circles in the nose of the **Milkhill** insect. This backwash flow from the poles of the Sun round to the middle, unlike magnetic particle flows that go in and out at the poles.

Pewsey : July 22, 2004



Pegsdon : July 10, 2004



Margery : July 18, 2004



Waden Hill : June 21, 2003

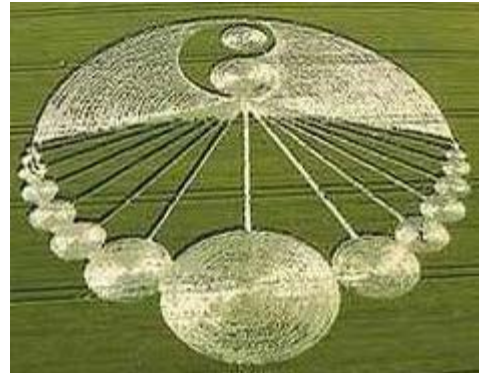

Milkhill : June 26, 2004



Southfield : July 15, 2004





[Mail this Page](#) to a Friend.

ZetaTalk: Reminder Circles

written July 27, 2004

We have stated that the Yin Yang symbol or [Serpentine](#) motion or blocked serpentine motion represents the clash of rotation direction between the Earth and Planet X, a factor in the Earth's rotation slowing to a halt. **Pewsey20** is a reminder that the Earth is chasing ahead of the [Sweeping Arms](#) of the Sun, which move counterclockwise, but is being blocked in this by Planet X, as evidenced by what Nancy calls the [Sweeps](#), which have been evident as distressful to the Earth for this past year, four full quarters.

Pewsey : July 20, 2004



West Tistead : Jul 20, 2003



We have stated that diagrams with closed circles represent [Orbit Lock](#). Planets *cannot* leave their orbits because this is where the gravity tug toward the Sun and particle flows that planet is susceptible to are balanced, unlike the [Sweeping Arms](#) of the Sun which reach out to *all* the planets in the solar system. Orbit lock is heavily implied in **Etchilhampton** by the primary numbers 13, 11, 7, 5. No mixing or subdivision possible.

Etchilhampton : July 25, 2004



Southfield : 2003



We have stated that Planet X creates an [Asymmetrical Affair](#) of particle crowding during its fight to pierce the [Ecliptic](#), moving into the backwash. Planet X also assumes a [Retrograde Orbit](#), jumping over the [Sweeping Arm](#) of the Sun. At the [Point of Passage](#), it transfers this particle crowding from *beneath* the Ecliptic to *above*, predictably *during* a sweep.

Woodborough : July 21, 2004



Beckhampton : July 15, 2004



Belgium : June 21, 2004





[Mail this Page](#) to a Friend.

ZetaTalk: Reminder Circles #2

written July 29, 2004

We have stated that a [Pulsing](#) action will occur as Planet X pierces the Ecliptic. Again in **Tan Hill** we see this insect with its stinger pointed in a clockwise manner, ready to sting the Earth, sweep toward it in a counterclockwise manner. Planet X is rounding the Sun in a [Retrograde](#), clockwise, manner.

Tan Hill : July 28, 2004



Milkhill : June 26, 2004



We have stated that the periodic [Shuddering](#), as shown on [Live Seismos](#) is caused by the impact of Planet X coming head-on toward the Earth and the other planets, and that the [Reverse Direction](#) of the respective planetary rotation is a factor in the Earth slowing to a stop in the week prior to the shift. That this point is about to begin is shown in the recent **Avebury** diagram.

Avebury : July 26, 2004



Honey Street : Jun 16, 2004



We have stated that [Magnetic Trimesters](#) exist for the Earth year, with [Magnetic Resonance](#) created, and that the present of Planet X in the inner solar system has created a distortion in the resonance. This distortion creates a heavy crowding near Planet X, which disturbs the entire inner solar system such that to achieve balance the crowding is light on the other side of the Ecliptic, as shown in **Strzyzawa**. The [23° Angle](#) taken on exit is a result of this, the easier path to reducing the crowding.

Strzyzawa, Poland : July 7, 2004



Spain : June 26, 2004



Tegdown : June 30, 2004

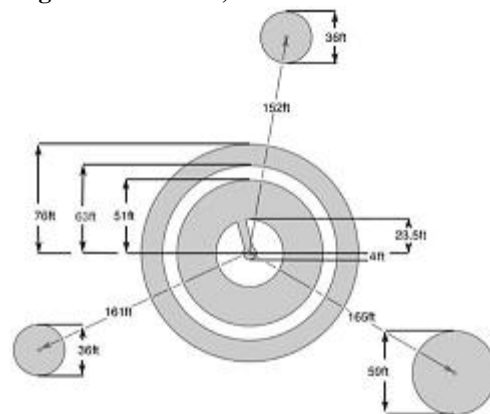



[Mail this Page](#) to a Friend.

ZetaTalk: Reminder Circles #3

written July 29, 2004

We have stated that Planet X does a dual [270° Roll](#) as it positions itself along the Sun's magnetic flow lines both above and below the Ecliptic, and that the Earth participates in this, being the lesser magnet. **Brunoy** and **Taber** both show this dual 270° roll to be in opposite directions, and in close proximity to the Sun.

Brunoy, France : 2004



Taber, Canada : July 7, 2004

We have stated that [Engulfing Circles](#) imply Planet X rising from beneath the Ecliptic, toward Earth, supplanting the magnetic influence of the Sun increasingly. **Thalheim** shows us this engulfing occurring in two different directions, as the dual [270° Roll](#) of Planet X will place the planets in a radical [Juxtaposition](#).

Thalheim, Switzerland : July 7, 2004



Italy, June 2, 2004



Gopher : June 21, 2004



Ohio : Aug 24, 2003



We have stated that this [Juxtaposition](#) is caused by the magnetic malestrom Planet X creates as it, a massive magnetic body too close to the Sun it is passing, jerks into position along the Sun's magnetic [Flow Lines](#). As both **Patney** and **Wylatowo** show, Planet X is moving at an angle toward the Ecliptic, and thus an imbalanced crowding occurs, tossing both it and the Earth into voids during the [270° Rolls](#).

Patney : July 28, 2004



Wylatowo, Poland : July 6, 2004

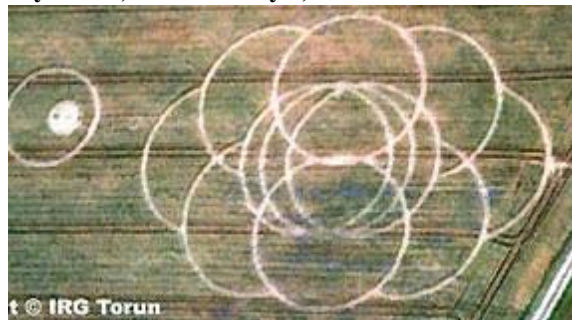

Czechoslovakia : July 4, 2004





[Mail this Page](#) to a Friend.

ZetaTalk: Reminder Circles #4

written Aug 5, 2004

We have explained that the [Yin Yang](#) symbol represents the clash of rotation direction between the Earth and Planet X, a factor in the Earth's rotation slowing to a halt. In both **Westbury** and **Beacon**, this symbolism is shown to be *central*, with both the Earth and Venus now caught before the retrograde press of Planet X. The clockwise, retrograde, sweep of Planet X has now become the dominant influence for both. No escape for the hapless planets in its path.

Westbury : Aug 1, 2004



Beacon : July 30, 2004



We explained that the **Coventry** diagram showed Planet X along the Sun's magnetic flow lines but still well under the Ecliptic, on July 8, [Ready to Tip](#) into a [270° Roll](#) . In the recent **Etchilhampton**, it has reached the Ecliptic, centered on the crop lines, a clear warning for mankind that their days of slow awakening to what is about to grip them have passed.

Etchilhampton, Aug 4, 2004



Coventry : July 4, 2004



We have explained that [Orbit Lock](#) occurs because planets are held where they cannot leave due to the gravity pull of the Sun, but can come no closer because of particle crowding they are sensitive to. The double lines seen around the Sun in **Nukerke** and **Nashenden** imply an intensified lock, a lockdown, during this time when the gravity pull of Planet X adds to the pull of the Sun. The planets in this lock cannot escape the coming clash.

Nukerke, Belgium : July 28, 2004



Etchilhampton, 2002



Nashenden : July 30, 2004





[Mail this Page](#) to a Friend.

ZetaTalk: Hoaxes

written Aug 5, 2004

Characteristic of the recent hoaxes, all of which have appeared in **Wiltshire** county in the UK is their preference for straight, rather than curved, lines, and inclusion of mazes. No legitimate diagrams to date have included a maze, anathema to the intent of the circle makers which seek to educate, not confuse, mankind, yet hoaxes almost prefer them as a maze has straight lines. Hoaxes also tend to be small in size, or in locations distant from public view. Hoaxes lack the characteristics of legitimate circles which are crop bend at the growth nodes, not broken, and crop laid in different directions overlaying each other, and precision in line and curve. What is to be learned from the hoax circles? They take the symbolism of legitimate circles and distort them, not unlike the disinformation distortion given our words. Legitimate circles do not include faces, as in a prior year hoax of the face of a Zeta or Art Bell, not mazes interpreted to be binary or other code. Hoaxes hope to grab public attention by such gimmicks, and when revealed as hoaxes, cast aspersions on all circles. Legitimate circles have a resonance with other legitimate circles, like the cadences of a symphony, all building upon one another.



July 28, 2004



July 28, 2004



July 13, 2004



July 21, 2004



July 28, 2004

In addition to laying down original hoaxes, the hoaxers employed in Wiltshire county in the UK have been assigned the task of ruining legitimate designs. Where **Golden Hill** was taken to be manmade, because the hoax team was seen emerging from its location, this is a legitimate circle. The team left because it did not lend itself well to sabotage. Note the [Similarity](#) to circles following in **Beacon Hill** and **Westbury**. A key indicator of sabotage is change *after* the creation date. Legitimate circle makers have no reason to delay, and their trademark is to create intricate circle over a broad area almost within seconds. Their design is in the computer, and it takes but the release of a switch to start the sequence, whereas hoaxes take time. An example of a sabotage is **Silbury**, where the hoaxers hoped to enhance their reputation by claiming this *large* circle. Here the sabotage resorts to lines and mazes. Contrast this with the belated change to **Tan Hill**, where the original makers returned after aerial photos had been taken of their intended message to create a *contrast* to the hoaxes. See the difference?

Silbury : Aug 2, 2004

Tan Hill : July 28, 2004

Golden Hill : July 26, 2004

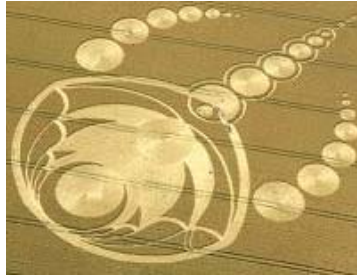



[Mail this Page](#) to a Friend.

ZetaTalk: Contorted Path

written Aug 21, 2004

We have stated that Planet X does a dual [270° Roll](#) as it positions itself along the Sun's magnetic flow lines both above and below the Ecliptic, and that the [Earth Participates](#) in this, being the lesser magnet. Just how contorted does this passage become? Crop Circles from over a decade ago, in the early 1990's, and ancient depiction's show this to be an almost unimaginable series of twists and turns. Does this passing planet indeed make these twists, and why would ancient man, and circle makers, be so determined to record this? Viewed from today, when the constellations seem not quite right and the Moon often out of place, the Sun rising and setting in a spot too far North, and the weather beyond man's memory in its oddity, these twists seem bizarre and unimaginable. Just wait. As the approaching monster planet, with its entourage of moon swirls and loose debris slinging into Earth's atmosphere as fireballs, begins the dance of its passage, it performs before man on the stage of the Sun such that the dance cannot be missed.

Ancient man watched the contortions with fascination and horror, wondering where their Earth, their home, was to go. [Sunrise in the West](#) was an indication that Earth was a dancing partner, and those who survived the wrenching earthquakes and flood tides that followed were determined to document for future generations what they had observed. Be warned, your relatively peaceful days of weather irregularities and orbit oddities will not last, and the wild ride to begin will not end until your Earth is thrown into a different twist, cities washed away, continents torn apart, and the expectations of the seasons quite beyond what memory serves. We will not detail the timing or the steps this contorted path will take, as of this date, this information is *not* being shared broadly with mankind, but is restricted so that only the elite have access. They are *still* not sharing what they know with the common man, who deserves to know what is upon them as much as the arrogant elite, and are *still* not arranging to allow ZetaTalk to be disseminated to the common man simultaneously with delivery to the elite. If they wish to know what the contorted path will bring, and when, they need to unsheath the cover-up.

Brunoy, France : 2004

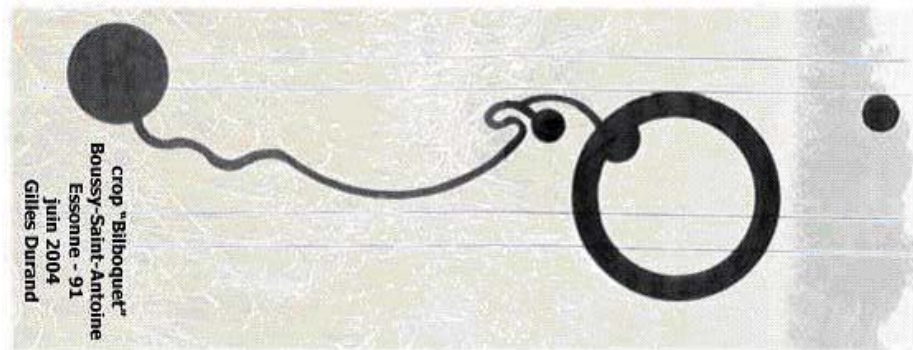

Canada : July 7, 2004

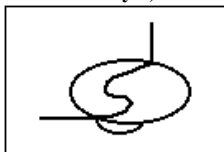

Appleshaw, 1995



Gline, 1994



Signs of the Times #1062

Avebury and the Dark Star [Aug, 2004] <http://www.darkstar1.co.uk/avebury.html> 'The people who settled in the Avebury area and began to plan the stone circles there had witnessed a most remarkable celestial phenomenon. ... In any case, it is of interest to note that a third circle with an additional serpentine trail attached is to be found adjacent to Avebury, ... might indicate a Planet X-type object. ... Babylonian culture that seem to show a similar binary connotation. There is a clear trinity of celestial objects on this stella, towards the top; the Sun, the Moon and a third, radiant planet. Note the presence of the Babylonian deity Marduk further down the stella, a deity closely associated with Nibiru. It is interesting to compare this image with a later alchemical dragon, Azoth, with his two suns and a moon.' [Note: the Second Sun appearance of Planet X and the contorted waving path depicted in many crop circles.]

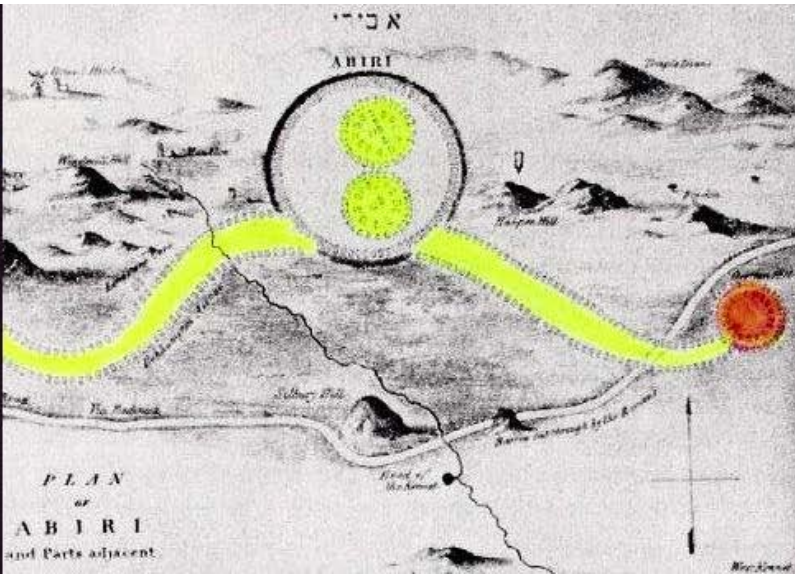



[Mail this Page](#) to a Friend.

ZetaTalk: November Reality

written Nov 16, 2004

We suggested last July that Crop Circles held [Timeline Clues](#) and based on our comments our [Emissary Nancy](#) tried her hand, coming up with dates from late October to late November for the issues the Crop Circles were warning were about to materialize. What has emerged, only recently, to confirm these predictions?

The first hint was that the influence of Planet X supplanting the Sun's influence as the dominant magnet the Earth listens to would increase. Nancy interpreted this to be a percentage increase until it reached 90% by Nov 23, due to Planet X moving up to the Ecliptic to essentially stand between the Earth and Sun. Has this occurred? We would point to the photos of a long time photographer, from Italy, whose photos have just started to capture a *merged* body, where at all other times they captured the dim orb of the Planet X complex as a [body apart](#).



The second hint was that Mercury would be in the vicinity when Earth tipped into the [3 Days of Darkness](#), going horizontal temporarily during an adjustment at the Ecliptic that Planet X would be making during its [270° Roll](#). Mercury, per Nancy's analysis, would be in the vicinity round about Nov 8, for an Earth in a stalled orbit. Is the Earth now starting to tip her N Pole away from the Sun during an increased wobble? What are the recent reports? The [wobble](#) has suddenly increased.

Italy Nov 16: At 13 :18 o'clock I noted a stronger deviation to West of the Sun, then I checked with digital compass and was surprised : azimuth was 210°, too much for the natural 197° in that hour.

Maryland Nov 13: I don't remember ever seeing the sun setting in the SW. Seems like just the other day, it was back around slightly North of due West.

Australia Nov 13: The Sun appeared to set 5 degrees farther south yesterday in the southern hemisphere. Often this can be confirmed by a later observation of the position of the South Celestial Pole(SCP). A 9:00 PM observation in the evening skies placed the SCP about 7 degrees further left of a terrestrial target and 5 degrees lower to the horizon according to my reckoning.

The third hint was regarding particle flows returning to the Sun around her middle, an increase in the buffeting from this as Planet X struggles to piece the Ecliptic and go on its way. Nancy did not know what to do with this, having no data to track, but the current solar flares during the [Solar Minimum](#) show these particle flows disturbed, having to flow around Planet X and creating blockages and voids and resulting in a ruffled Sun surface.

The fourth hint suggested that the regular battering caused by the sweeping arms of the sun and resulting whiplash among the planets caught in the swirling particle flows [Cupped](#) in front of Planet X would increase. The Crop Circle analogy was a flying insect, the reverberations increasing until they became continuous. Have the battering caused by the sweeps not [increased](#) to this degree, just this month?





[Mail this Page](#) to a Friend.

ZetaTalk: Circle Simplicity

written Apr 24, 2005

Crop circles started out in the early days with simplicity, single circles or a few simple circles in close proximity to each other. Then complexity set in, increasingly, until breathtaking designs seemingly sending complex messages were discovered and captured on film for the world to ponder. Now, in early 2005, we are back to simplicity! Is there a message in this simplicity? Most certainly, as simplicity focuses the message, eliminates confusion, like a spotlight.

The message is that Planet X is Sun centered as viewed from Earth, standing between the Earth and Sun, and this overlapping influence will soon be apparent. The time is *now*, not years away. What are the indications in the early 2005 season circles that this is the message? Hoeven has a measured diameter that exactly matches our description of the diameter of Planet X and Earth, which we have described as being 4 times the diameter of Earth, the larger circle 8 meters, the smaller 2 meters. Ripley has a swirl showing a clear clockwise motion, the retrograde rotation of Planet X, this swirl becoming central as it is the clash of rotation direction that is one of the prime factors in rotation slowing. St. Catherine's describes a relationship between 3, the Earth, Sun, and Planet X, with Planet X assuming influence over the Earth in the same manner that the Sun holds influence over Planet X.

In a world dominated by powers that seek to distract mankind, while lying through their teeth about the Earth changes and failing to warn mankind, the simplicity of these circles is saying to *not* be distracted.

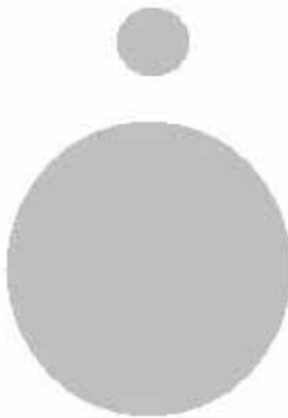

Hoeven, NL
Apr 6, 2005

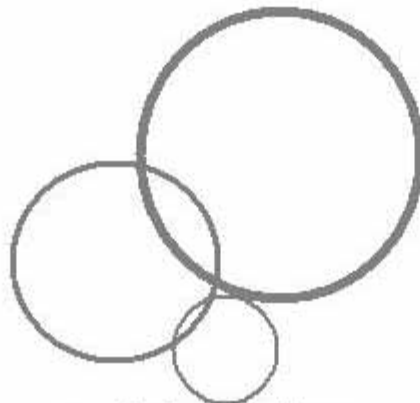

St Catherine's Well, UK
Apr 19, 2005



Ripley, UK
Apr 17, 2005

Signs of the Times #1393

The Crop Circle Season 2005 is started! The first European crop circle of 2005 was reported near Hoeven, NL. The largest circle has a diameter of approx. 8 meters and the smaller circle a diameter of approx. 2 meters. <http://www.dcca.nl/2005/hoeven/hoev-uk.htm> [and from another source] Ripley, UK <http://www.cropcircleconnector.com/2005/ripley/ripley2005a.html> [and from another source] 3 interlocking circles St Catherine's Well <http://www.cropcircleconnector.com/2005/catherine/catherine2005a.html>



[Mail this Page](#) to a Friend.

ZetaTalk: 2005 Season

written June 28, 2005

Would the Zetas care to comment on the new Crop Circle in Beckhampton that was updated yesterday to show the aerial view? Looks more complicated than some recently, and is definitely the most well defined of the year thus far.

We stated early in the 2005 season that [Circle Simplicity](#) was to be the rule, and this has held through June. The lack of real competition in large and elaborate designs [encouraged frauds](#) to proliferate, half the designs laid down in Britain clearly frauds during this 2005 season, an increase over the number of [Hoaxes](#) of the 2004 season. Seeing this trend, **Beckhampton** was made large and elaborate, to stand in contrast to the plethora of frauds. The themes we explained during the 2004 season are repeated, for emphasis.

The [Magnetic Trimesters](#) of the Sun, with the outburst from May-Aug being the strongest, is the message from **Clatford Bottom, Bluebell Hill, and Rockley** in the designs laid down in Britain.

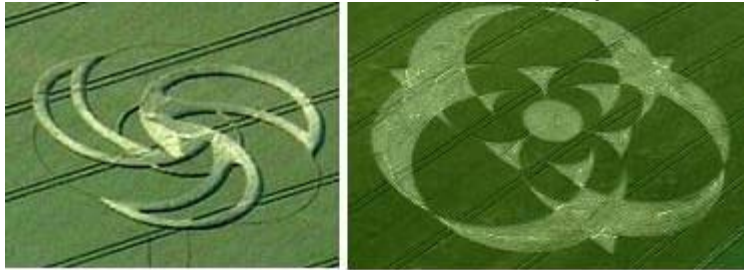

Bluebell Hill, June 19 **Clatford Bottom, June 12**

The [Serpentine Dance](#) is shown again in **Beckhampton**, this time placing the retrograde orbit and rotation of Planet X closer to the Sun.



Beckhampton, June 5

The [Slow 270° Roll](#) that Planet X is in the process of making is repeated again in **Toot Baldon**, with the first of the dual 270° rolls emphasized. Most reminiscent of Eastfield during the 2004 season, the [Contorted Path](#) of these rolls mirroring one another.

Magnetic [flow lines](#) are emphasized in **Silbury Hill**, where the closeness of Planet X to the Sun at this time is shown to be distorting both their magnetic fields. The hapless Earth is caught beyond Planet X in the eddy flow of particles, and the position where Earth is *not*, her normal June 21 location, is shown on the opposite side of the Sun.



Toot Baldon : June 21, 2005



Silbury Hill, Jun 26 2005

Heavily emphasized during the 2005 season are the four seasons humans use to measure their year. Seasons are being *arranged* for mankind during the slow 270° roll, as they have been during past pole shifts, in order to ensure life continues on planet Earth. But nevertheless, the four seasons are what mankind recognizes, 12 months, so the symbolism hard to miss. **Burwell** and **Lurkley Hill** mirror each other in their pattern, **Lurkley** showing the normal balance, with **Burwell** relaying that the stress on the Earth will be most heavily felt twice a year, as the Dec 26 tsunami quake has already shown, during December and June of the calendar year. **Monkton Down** echos the [2003 Southfield](#) and [Eastfield](#) circles and the ancient [Nebra Disc](#) in the months of the years shown as 20 or multiples thereof, a different calendar than used today. The 2005 season has much to relay, with **Monkton Down** and **Burwell** relaying the grim message the Earth will have participated with the 270° roll for a year, tilting and wobbling, a time of extreme stress for the Earth's crust and confusion for its populace.



Lurkley Hill : June 22, 2005

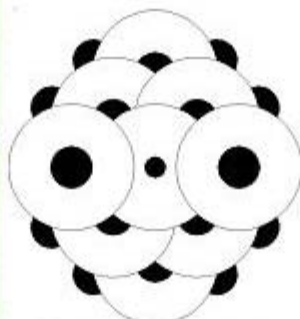

Burwell, June 18

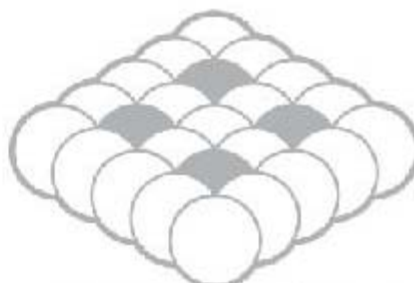

Monkton Down, June 20



[Mail this Page](#) to a Friend.

ZetaTalk: 2005 Circle Trends

written Aug 23, 2005

How do the planets line up, including the dark planet? There have been crop circles that have gone uninterpreted. I can never figure out what they mean.

We have warned that the clash of rotation and orbit direction of Planet X would result in a slowing of the Earth's rotation and eventual stoppage of rotation for several days leading into the pole shift, but the effect of this clash is felt long before any rotation slowing is discernable. The [Serpentine Dance](#) and Yin-Yang symbols in crop circle formations represent this clash. Warnings of this clash, soon to be felt by jarring, rather than shuddering, global quakes at the [Face and Dark](#) points during the Earth's rotation, are again very central to the genuine crop circles laid down in 2005. This time, the clash is not only shown as intertwined and blocking, but also as causing turmoil, as blocking does not *stop* a motion but turns it in upon itself. What will this mean for the Earth? More earthquakes during those jolting times, hammering and not letting up as *more* than plate adjustments to stress are occurring. How would it be that something as driven as rotation could slow to a stop without resistance? As the magnetic fields of Earth and Planet X continue to intertwine, during the approach of Planet X, those times when the highly magnetized Atlantic Rift *meets* the oncoming field of Planet X is when the hammer comes down. We have described the effect this has on the plates piling up behind the Atlantic Rift, and on those plates stretching out to the East, pulling away and resisting a slowing. No longer a global shudder at those times, but a global *jolt*.

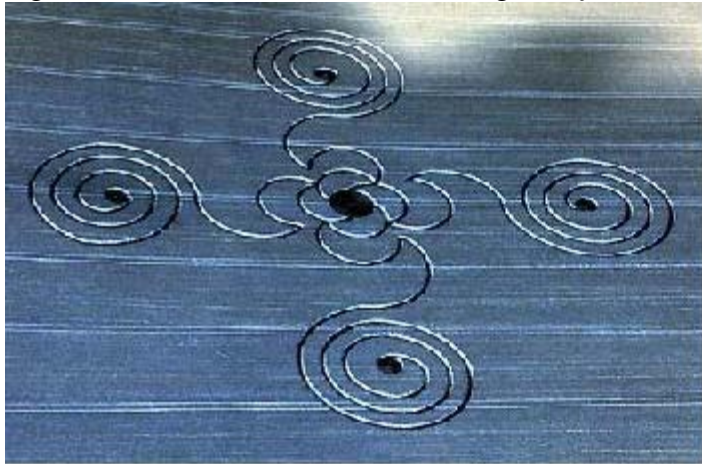

Watlington : July 22, 2005



Garsington : July 15, 2005

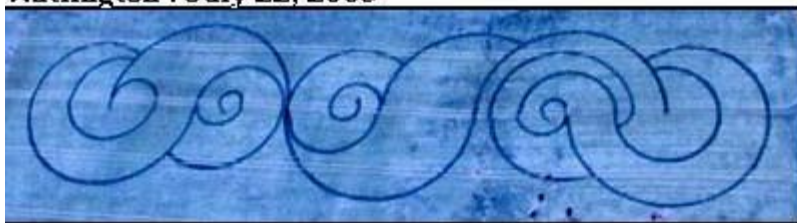

Avebury Stone : July 29, 2005



We have detailed how the [Sweeping Arms](#) of the Sun are responsible for all the planets in the solar system going round in the direction they do. They are swept there like dust balls in front of a broom. These sweeping arms are not a steady state, but occur as crop circles have portrayed them 8 times a year for the Earth, when Earth is in a normal orbit. In a halted orbit, these not only occur twice as often, they create a [bumping effect](#) among any planets caught in the eddy flow in front of Planet X. These planets include not only the Earth, but Venus and the Earth's [dark twin](#), which has come up behind her in their shared orbit. What effect does this halted orbit have on the Earth, during a time when the increasingly intertwined magnetic fields of Earth and Planet X are causing her rotation to experience regular

daily jolts, rather than simply shuddering, when the Atlantic Rift faces the larger and more dominant field of Planet X? A car hitting a wall and bouncing back subjects those inside to a single whiplash, forward and back, but if this same car is hit from the rear by those cars following it, this whiplash is intensified, continued, and compounded by jerking in different directions. Earthquake experts will tell you that the reason tall buildings in a city suffer damage in a quake is not so much from the single jolt of the quake, as this causes the building to merely sway. It is the uneven swaying of buildings of uneven heights that causes them to smack into each other. Not a single punch but pummeling from all directions.

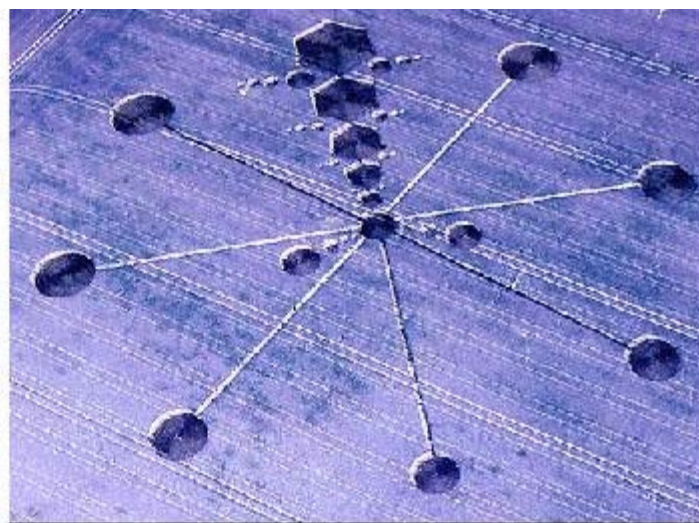
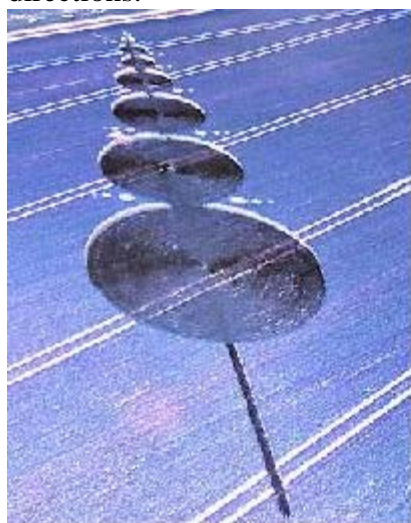

East Field : July 18, 2005

Milk Hill : July 17, 2005

We have stated that those circles that show a bound, hooped, or enclosed situation indicate [Orbit Lock](#), where by the nature of the particle flows moving into and out of the Sun, a particular planet is locked in its orbit. They cannot move forward toward the Sun because particle crowding occurs, and they cannot move away because of the force of gravity attraction. They are locked in place, and can only move around the Sun, in their orbits, held that length away from the Sun by their particular lock. The number most often used to represent this lock is 6, related to internal pulsing in the Sun itself that creates times of tension in those planets locked around her middle in the particle backwash that the Ecliptic represents. This is something the Earth does not escape, regardless of where in her normal orbit or where in her seasons she finds herself. Normally *even* during the year, these pulses lose their syncopation when they encounter a giant planet roiling the particles as it struggles to pass the Sun at too close a range while it twists and turns in the magnetic grip of the Sun's own field. If the Earth is caught in an [eddy flow](#) in the particle flows coming from the Sun and round the sides of Planet X, then how can her lock be *even*. Each pulse from the Sun is felt not from the Sun but from *all sides*. This causes reverberations, and as rampaging particle flows trying to find a way around a blockade will hardly be a smooth operation, causes the Earth to be subject to surges. Since man's scientists are unaware of most of the sub-atomic particles the Universe holds, our explanation would be lost on them, but the effect on man and other life on the planet is not lost. Illness, death, erratic behavior, all without an explanation that man can ascribe. There is relief in sight, as the passage will allow the particle flows to return to normal, but for this to occur, mankind must first suffer the pole shift.



Meopham : July 6, 2005

Boxley : July 17, 2005

Garsington : July 15, 2005



[Mail this Page](#) to a Friend.

ZetaTalk: 2006 Season

written June 26, 2006.

Can the Zeta's comment on the absence of crop circles so far this year?

In the past, crop circles have been laid down over immense areas and with great complexity, involving hundreds of items. This presented challenges to the hoaxers, claiming to have laid them by boards and string. In the past, we resisted explaining the meaning of crop circles, encouraging the public to come to their own conclusions and listen to their subconscious while gazing at the circles. But in 2004, this changed, and we did a series of analyses on their meaning. By late 2004, a different kind of hoax emerged, to mute the threat that crop circles represent to the establishment. Rather than try to duplicate circles while hoaxing, they would [violate](#) original circles, distorting their meaning! In 2005, the circle makers reacted to this disinformation technique by returning to [extreme simplicity](#), returning to complexity only late in the season with designs that would be [difficult to deface](#).

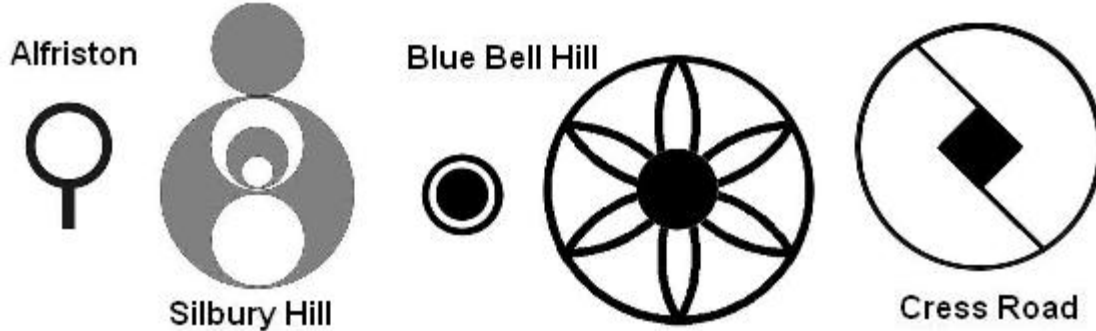

In that Earth changes have intensified, and thus the threat circles represent have likewise intensified, the circle makers have once again returned to extreme simplicity for the 2006 season. [Overton](#), in the UK, is an example of hoaxers attempting to fog the issues and confuse people. Where seeming to adopt some of the symbolism of the circle makers, it is attempting to contort the message of the circle makers. But the themes have not changed. [Orbit Lock](#) is represented in Blue Bell Hill, which is stating that though the dominating magnetic presence of Planet X has almost supplanted the Sun, nevertheless the Earth will not leave her orbit to escape. [Serpentine Dance](#) is represented in Belgium, showing that the clash of rotation and orbit direction, where Planet X has a retrograde rotation and orbit, has not yet engaged the Earth to the point where rotation slowing in the Earth has begun, but it has created a wobble in the Earth. This message is repeated in Cress Road, showing a single rotation direction. [Magnetic Resonance](#) is represented in Italy, where the relationship of the trimesters to the Earth's four seasons is shown. [Engulfing Circles](#) are represented in Silbury Hill, showing once again the stages of magnetic dominance as Planet X begins to supplant the Sun's magnetic dominance. [Flow Lines](#) showing stages and magnetic alignment between the Earth and Planet X during those stages is represented in Finland. The message here is that as Planet X begins to pierce the Ecliptic and complete her 270° roll, the Earth and Planet X will assume a side by side alignment, the point where rotation slowing will begin. The time line in France implies the extreme tilting the Earth will assume during the 270° roll, mirroring the contortions that Planet X must assume, as Planet X forces the Earth to dance with it during these magnetic contortions.

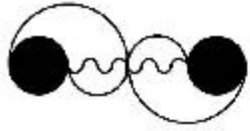

Belgium



Italy



Finland

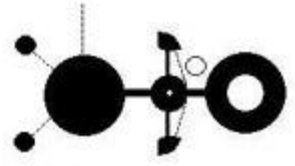

France



[Mail this Page](#) to a Friend.

ZetaTalk: Magnetic Clash

written July 1, 2006 on the live GodlikeProduction Radio show.

The compass anomaly, swinging to the East, is indicative of the Earth adjusting to the approach of Planet X and the clash of their magnetic fields. The change is indicative of a clash in magnetic fields as Planet X comes ever closer to the Earth, their fields touching. It is the *combined* field that Earth must adjust to, and continue to adjust to, not the exact position of the N Pole of Planet X within these fields, and the Sun's magnetic field enters into the equation too. This dramatic change, noted by a conscientious tracker, checking dual compasses daily for years, indicates that the Earth is trying to align side-by-side with Planet X, bringing its magnetic N Pole to point toward the Sun, as Planet X is currently doing in the main. These adjustments are temporary, and change about, as magnets can make dramatic and swift changes in their alignment with each other. Put a number of small magnets on a glass, with iron ore dust, and move a large magnet about under them, and watch the jerking about they do. Are we saying the Earth's magnetic field is going to get more erratic in the future, dramatically so? There is no question that this will be one of the signs that will come, yet another *not* covered by the Global Warming excuse.

The clash of the magnetic fields is shown in the recent Avebury crop circle, where the magnetic fields emerge from the Earth and Planet X in a normal manner between them, but assume an abnormal range on the far side. The rings on the far side are preparing to merge, using the *center* of the combined fields as their point of exit and return. When this process completes, the Earth is literally bonded with Planet X, in a side-by-side position, which occurs during the week of rotation stoppage. Prior to this merged field situation, the Earth first attempts to hold to the Sun's dominance, staying upright, then is forced into an end-to-end alignment with Planet X as it leans to the left and rolls into the 3 days of darkness and days of sunrise West. What Avebury is showing, as the present situation, is that the fields are clashing, at the point of merging, so the Earth will have difficulty remaining independent.

Note: below added as an addendum on July 6, 2006

We can not be far off from major, major events happening due to this. Magnetics affect human behavior, illnesses. I foresee big consequences of the dominant magnet forcing the smaller one to do things it doesn't want to, creating even more earth violent changes.

Where it is true that the intense electro magnetic fields generated by high power lines can affect human health, such as those living under high tension wires developing cancer at a higher rate than normal, this does not result due to a changing planetary magnetic field. The intensity of the field, for those creatures crawling about on the surface, remains the same regardless of which direction the magnetic particles flow. Certainly, confusion reigns in those migrating birds and whales using the field for direction. Havoc will certainly be wrecked in man's technology. The compass has already become erratic, with alternate guidance systems being used in planes as a consequence. The degree to which man's technologies rely on a general N/S direction holding steady will become apparent as satellite and navigation systems fail. Submarines, which are essentially blind under the waves, are particularly susceptible. Planes with poor visibility and satellites without manual controls also are essentially blind and rely primarily on the compass for positional stability. Electro-magnetic motors are subject to electro-magnetic pulse, which can sometimes emerge when magnetic fields are suddenly switched around, creating crowded particles in crunch points during the switch. These pulses are known to destroy electronic equipment, when they occur, and little of mankind's technology is shielded from these pulses as they are rare and unforeseen in the normal day-to-day operation of equipment.

These are the primary consequences of clashing or merging magnetic fields, and the contortions that occur before they are merged or joined to the extent of causing the lean to the left and 3 days of darkness foretold. By this time the Earth will be in a severe wobble, caused by the daily tugging on the magnetic poles that present to the influence of Planet X - the wobble of today, exacerbated. In this regard, the steady approach of Planet X, coming ever closer so the influence

of its magnetic field is ever stronger, *does* equate to more violent Earth changes. The Earth torque is one example, where the magnetic S Pole is tugged back each day, creating more stress on the plates in the Pacific and allowing the Atlantic to widen. The wobble is another such example, creating more erratic and violent weather, more storms, and more weather extremes. These will continue to increase, not because the fields are merging and clashing, but because Planet X continues to close the distance between itself and Earth, moving *toward* the hapless Earth during its passage, and thus the tugging on Earth will increase in its violence. What the clashing and merging fields *does* mean for Earth is that the Earth now has *more* than a torque and a wobble, it has a bully in the neighborhood that will eventually supplant the Sun's influence. Supplanting the Sun's magnetic dominance, combined with the increasing 270° roll that will place the N Pole of Planet X pointing directly at Earth, is what allows the pole shift drama to commence. A merged fields is natural for two planets forced close together, in such a setting.

Signs of the Times #1615

Where the magnetic N Pole was pointing 18° too far West last month, today [Jun 7], it shows almost 20° East of North. [and from another] New Avebury crop circle looks like two magnetic fields, clashing! <http://www.cropcircleconnector.com/>





[Mail this Page](#) to a Friend.

ZetaTalk: 2006 Hoaxes

written July 12, 2006.

We have mentioned that the [2006 season](#), as with the 2005 season, was designed with extreme simplicity by the legitimate circle makers to foil hoaxers, who had become sophisticated since 2004. Where previously almost exclusively located in the UK, in fact, only located in [Witshire County](#), hoaxes have become more sophisticated and have spread to other countries eager to get the dollars reputed to be paid for quality hoaxing these days. Beyond being crude at a glance, the hoaxes in [Switzerland](#) and [Italy](#) were noted to lack sophistication in the way the grain was laid down. In [Poland](#), the hoaxers were disturbed before they could complete even a single circle, revealing in this that a machine to swirl the grain was in use for hoaxing. What clues are there that the recent [Savernake](#) circle in the UK is a hoax? Note the similarity to the genuine circle in the UK depicting [Magnetic Clash](#). In that the circle makers kept their design simplistic, while utilizing the space so defacing it would be difficult, the hoaxers attempted to dilute the message of a magnetic clash by using the symbols in another manner. Instead of giving the message that the magnetic fields were emerging from central point between the two planets, Earth and Planet X, the hoax shows the fields without a common center. Beyond the fact that a confusion of the original message was attempted, there is the clue to a hoax in the amount of mashed grain. The original circle makers had the skill to make the circle from the air, where the hoaxers were *on the ground* and thus needed to have numerous anchor points in order to guide their artistry. The reason the grain is mostly *mashed* in the hoax is to cover foot prints.



A [3D circle](#), the first of its kind, also emerged in 2006 and is a hoax. The clues here are the use of straight lines, almost exclusively, where the real circle makers have always used circles and curved lines almost exclusively. Second, this is clearly an aberration of the [Magnetic Resonance](#) theme, with the theme defaced. Magnetic resonance reverberates *out* in all directions, as magnetic fields do. The original circle makers show the relationship in time, during a given year, that there are three trimesters in a year which man considers to be composed of four seasons, for instance. What is this hoax portraying? Not a magnetic reverberation in all directions, but something pulling in *one* direction. In that the most sophisticated hoaxers are attempting to dilute the *magnetic* message given by the legitimate circle makers, they are giving you a clue as to what the establishment fears.



They are telling you that your compasses will begin getting even more erratic, and they hope you *do not* take note the relationship of these problems to the crop circle message. How does the establishment *know* the compasses will become erratic? This was of course one of our recent predictions, but the establishment can take measurements beyond a local area. The common man has a compass or some equipment that requires a gyroscope, malfunctioning. [Magnetic anomalies](#) have been noted and tracked by Nancy and her friends, since 2003, when Planet X arrived in the inner solar system. Perhaps there is chatter on the Internet, but nothing, as usual, in the news. But the establishment, with their long reach, has *already* determined the trend. Trouble has arrived, and they hope you don't notice!

Signs of the Times #1620

<http://www.cropcircleconnector.com/> The Swiss formation looks quite crooked and misshaped in its geometry...and impression that gets supported by the new aerial-pictures. Peter Jetzer and Beni Sidler of the Swiss Crop Circle Research Group were at the site and found a very mechanically flattened lay, crooked pathways, off symmetry and last but not least postholes in the circle's centres. [and from another] <http://www.cropcircleconnector.com/> Researchers examining the Poland circle quickly realized that it was a false crop circle and besides very primitive one.



[Mail this Page](#) to a Friend.

ZetaTalk: 2007 Crop Circles

written Jun 12, 2007.

Winterbourne, [May 23, 2007](#)

Most of the legitimate circles laid this season are reflecting the quiescent period of late, the last couple months, while the Earth is attempting to align with Planet X in a type of side-by-side arrangement during his 270° roll, and thus not jerking back and forth in an attempt to align magnetically with the Sun. We have explained that this is temporary, a return to the wobble and lurch and a lean to the left to start, with a vengeance. Imagine Earth in the center of this Winterbourne circle, being battered back and forth between two opposing magnetic fields! The Sun is dominant, with its N Pole pole pointing up. Planet X is next dominant, and will be pointing its N Pole out. The poor Earth, who swings her N and S poles around daily to present to the Sun and Planet X, will attempt to please both masters. If you thought the wobble was extreme before, just wait! What will this mean for the plates, which have been loosened up, rock fingers along the edges broken off, so they are slippery. More quakes, larger quakes, more distance during each movement, and the stretch zones pulled upon hard. The New Madrid, already showing stress, will not hold out much longer.



Yatesbury, [May 30, 2007](#)

What is immediately noticed is that this is not a hoax, as the circular lines are too precise, in a barley field, too narrow to allow for correction in a manmade circle. The second immediate observation is that this circle is an oddity, compared to prior circles. Spirals have existed, but the placement of circles like beads along the spiral is new. Where the spiral outward is regular, the placement of beads seems to have no pattern. We would point to another recent circle at Winterbourne showing the jaring, rattling effect that competing magnetic fields will have on the Earth, soon. We have long warned that the lean to the left, leading into the 3 days of darkness, would be a time of great change on Earth. We have stated that there will be Earth changes we have not detailed, deliberately, so as to knock the establishment off its equilibrium so that the coverup might crack and the common man become aware of that which the establishment has been hiding from them. What does this crop circle tell man, about the next events to unfold? That they will be increasing in severity, thus the number of beads as the spiral unfolds. That the Earth wobble will surely get worse, and be accompanied by events that will happen irregularly. That these events will have no discernable pattern that the establishment can use to plan their path.

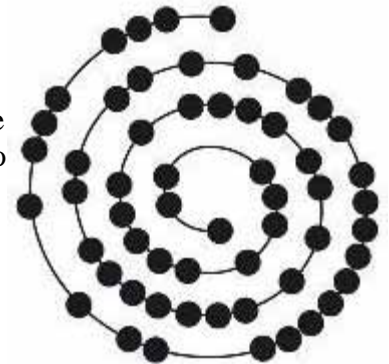

Eastfield, [Jun 3, 2007](#)

If Yatesbury was telling you that the Earth can anticipate increasing but irregular and unpredictable events, this Eastfield circle is relating the annual cycles to the [Magnetic Trimesters](#). As we have explained, the magnetic particle flows assaulting the solar system are strongest during May-Aug, weakest during Sep-Dec, and fairly quiescent from Jan-Apr. Thus, the active period is *now*. As we have explained, magnetic alignments during the strongest trimester are most intense, and more violent. At present the Earth is attempting to align side-by-side with Planet X as it is pointing its N Pole increasingly outward, away from the Sun. This is causing a slight lean to the right, the sun rising and setting too far to the North. At present, this has been a quiet period, as the Earth has not been lurching back and forth, attempting to align alternately with the Sun and Planet X, during this time. There are two factors that will end



this quiet period. One is the steady progress of Planet X in his 270° roll, pointing his N Pole more directly at Earth and with a simultaneous rise to the Ecliptic where he will stand directly between the Earth and the Sun. The second factor is the end of the current Magnetic Trimester, which has Earth and Planet X glued more closely together, less lurching about for Earth. The lurch will return.

Abbots Down, [Jun 6, 2007](#)

Night and day are clearly depicted in Abbots Down. But note that there is no tilt of the Earth present! We have described the [Lean to the Left](#) as a point where the Earth will be basked evenly, in the Sun. At this point, when the Earth is falling on her side, there will be no doubt that Global Warming is not the cause of the weather irregularities, no doubt that solar emissions are the cause of a warming Earth or electromagnetic surge on Earth, as neither would cause such a phenomena! Rotation would continue, but the Sun would be rising and setting at a radically different place, worldwide. This crop circle, so simplistic in its presentation, is most direct. What *else* could it be representing, but a time when the tilt of the Earth were non-existent! And as man presumes his tilt to be an ever present feature of life on Earth, what would cause such a situation! Thus, this simple crop circle is designed to get those who view it thinking, at least subconsciously, about what might be tugging on the Earth, and to start to glance up at the rising and setting Sun, for verification that all is still normal. Of course, it is *not* normal, and this will increasingly be noticed.



Milkhill, [Jun 7, 2007](#)

Here again, the Magnetic Trimesters are depicted, showing an extreme during one trimester. One trimester is shown as weighted with a double weight, in fact, or certainly outside of what is expected as the other two trimesters are shown as equal. What will occur, during the dance going into the [3 Days of Darkness](#)? If the pole shift itself is the culmination, it is preceded by a slowing rotation, and a stopped rotation that will last almost 6 days. But by the time the stunned inhabitants of Earth must endure this horror, they have already been around the dance floor and are numb with the gyrations the Earth will endure. The Lean to the Left happens over a period of time, which we decline to define, and is not a lineal affair nor one where the lean is the only phenomena going on.



Then the N Pole of Earth slides away to point into darkness, point away from the Sun and Planet X which lies on a line between the Earth and Sun. In her desire to get her N Pole away from the magnetic influence of Planet X, who is pointing his N Pole directly at Earth at this time, Earth over compensates and almost stands upside down for 6 days, which Islamic literature describes as 6 days of sunrise West. Then straightens back up for a side by side alignment with Planet X who by this point has likewise straightened up, North up, South down. Milkhill is stating that these dramatic changes will take place in the main during a single trimester. For those looking for clues as to timing, for when to go to safe locations, a strong Lean to the Left is the clue. At this point, clinging to your old life, paying your bills and showing up for work, is no longer relevant!

Belgium, [Jun 8, 2007](#)

Those analyzing this Belgium crop circle have noted the clockwise or counterclockwise orientation of the crop lay. This is indeed key to the analysis of the design. Planet X, as we have explained, has a retrograde orbit, and a retrograde rotation. Retrograde, in human astrophysics which prefers to view the solar system from above, is clockwise. As Planet X turns its N Pole toward Earth this affects *most* the N Pole of Earth, which tilts away giving the Earth the foretold 3 days of darkness. As the Earth fails to put on the brakes during this tilt, gently turning upside down for the foretold 6 days of sunrise West, rotation of the Earth seems to be retrograde too, at that time. In this upside down position, the flow of magnetic particles from Planet X flows disproportionately against the hapless Earth from one side, for Belgium

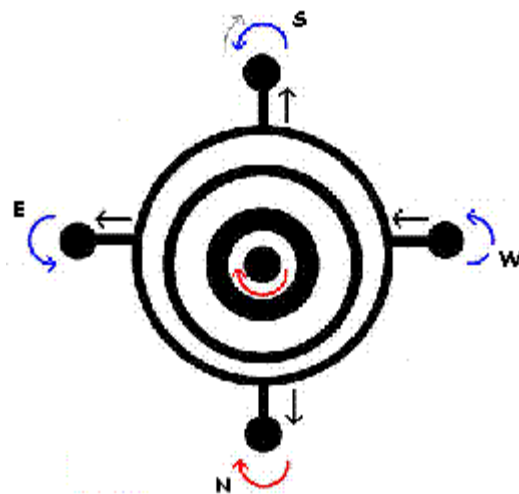

at sunset, this flow comes from the West. Those trying to understand what is happening to the Earth during these harrowing days, seeing the compass highly erratic and pointing in all manner of directions, will find the N Pole of their compass pointing *away* from the rolling Planet X at sunset, thus the flow inward toward the inner circles in this design, at the West end of the circle. As with all crop circles, the message is something the subconscious gathers and understands, while the conscious comes up with all manner of odd interpretations. The fact that no other interpretation can be laid upon this pattern will cause this crop circle to remain in the backs of minds, pondering, until the Earth changes begin to make its meaning clear.

BartonLeClay, [Jun 11, 2007](#)

Earth upside down (see second part of this crop circle at the link)! We have stated that the 6 days of sunrise West are an over-reaction of the Earth during the 3 day of darkness, where the N Pole of Earth is pushed violently away by Planet X and not only rolls to point directly out into space, but over compensates and literally turns the Earth upside down for days, thus the Sun appearing to rise in the West as rotation continues as before. This does not cause a pole shift, the crust tearing away from the core, as the hour of the shift does, as this is a *slow* tip. But for the inhabitants of Planet Earth, a terrifying time!



Easton Royal, [Jun 12, 2007](#)

How extreme will the wobble become? This crop circle is speaking to that. Note that the wobble is *most* extreme when Planet X is at a distance, and least extreme when it is close. Why would this be? The wobble is caused by the Earth attempting to adjust to *both* the magnetic fields of the Sun and Planet X, at the same time. If the magnetic N Pole of Earth is hidden, the alignment is with the Sun, if exposed, pushed away by Planet X as Earth attempts to align with Planet X in some manner. This is the wobble in its extreme. When Planet X is close, it dominates the scene, and the wobble is replaced by a singular alignment with Planet X, as during the week of rotation stoppage. For those of you wondering what to expect, *prior* to the strong lean to the left moving into the last weeks, this crop circles is a clue!

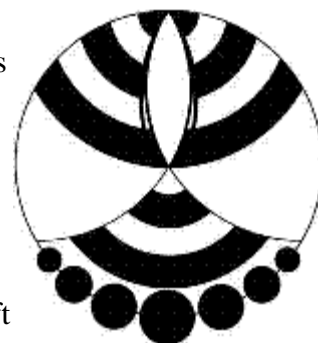

Westbury Hill, [Jun 14, 2007](#)

Westbury shows the course the N Pole of Earth will take during the months between now and a rotation stoppage. Note the N Pole first leans toward Planet X, as it has lately to a slight degree, then away from Planet X as moving into the 3 days of darkness, then aligning straight up for a side-by-side preceding the rotation stoppage. The implication is that the Earth will be virtually upside down, and rightside up, at least twice, in addition. We have hinted that the Earth will have many gyrations before it is pushed into the inevitable path leading to the 3 days of darkness, and this crop circle give detail on some of those gyrations. Man will be stunned at what the Earth will do, as litter along the highway that Planet X must travel.

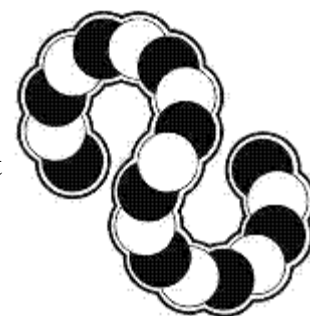

Slovenia, Jun 14, 2007

Circles around a central circle are often interpreted to be the solar system, but this particular pattern is showing what happens when moons, many moons, are hovering around a large planet. The planets in the inner solar system have few moons, the Earth one, and Jupiter, the largest planet in the solar system, having more than a dozen. Planet X, as we have stated, has at least two dozen, which form into swirls trailing behind Planet X as it travels. One of the moons even has its own moon. Looking head on toward Planet X one sees a dance between these swirls, which appear as wings to the side, the Winged Globe of legend. The two major moons attempt to position themselves equidistant on either side of Planet X, thus the wings, each complete with a portion of the charged dust cloud that clings to Planet X. What does the outer ring of 14 moons represent? That these minor moons keep their distance from the action, arranging themselves in one of the major moon swirls or another, depending upon where the tail is wafting at the moment.

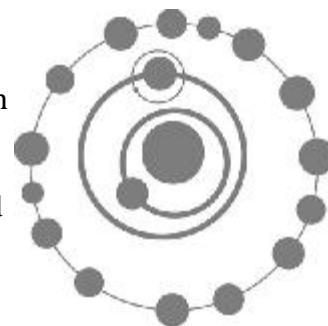

Goldenball, Jun 29, 2007

We mentioned that [Winterbourne](#) showed a battered Earth, being jerked back and forth in an attempt to align with both the magnetic field of Planet X and the magnetic field of the Sun. Here there is a single magnetic field dominant, and a 90° tilt of the Earth as a result. There is another clue to the timing of the pole shift, as the Magnetic Trimesters are shown on this diagram. The pole shift happens when one of the trimesters is ending. This would be the end of December, or April, or August.



Southend, Jun 29, 2007

Clearly showing merging magnetic field lines, this crop circle shows a hapless planet caught at the boundaries. The planets in the solar system all try to align with the Sun, as we have explained, aligning along the magnetic flow lines if not on the Ecliptic, or in the case of the gaseous planets, the reverse of the Sun's magnetic flow as these giants [act as a conduit](#). But when a strong magnet comes near, as will occur during the passage as Planet X passes the Earth, there is a clash. Here, in this crop circle, the Earth is just starting to be touched by the field of Planet X, the current status.

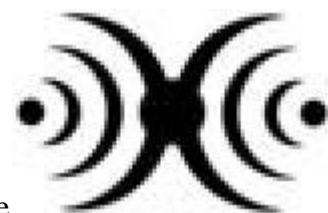

Belgium, Jul 1, 2007

During the contortions the Earth goes through when caught in the grip of two conflicting magnetic fields, it turns upside down. This happens slowly, during the 6 days of sunrise West following the 3 days of darkness when the N Pole of Earth tilts away from the approaching Planet X, causing a slow swing that temporarily turns the globe upside down. The magnetic fields here are shown as wheels, to imply a *turn*, as Planet X is turning in place during its 270° roll.

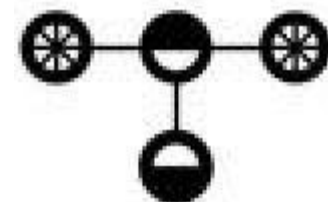

Germany, Jul 1, 2007

These two crop circles, both appearing in Germany, have a singular note - penetration or compression of a circle. This circle was given to the German people because of their renowned mechanical intelligence, which can grasp the meaning better than most. The circle represents defense, a perimeter, the 5 pointed star an unbroken line forming a series of triangles, also known to be difficult to break in structural analysis. What is approaching to break this defense? Something with two large appendages, which Planet X and its two major moon swirls is known to be, the [Winged Globe](#) of lore. Planet X is turning in place during its 270° roll, pointing its N Pole outward toward Earth, and it is *this* action that penetrates the magnetic defenses of Earth. This turn is implied in the increasing size of Planet X in the April 23 crop circle. As it

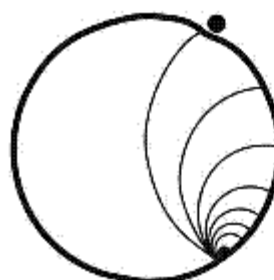

July 1, 2007

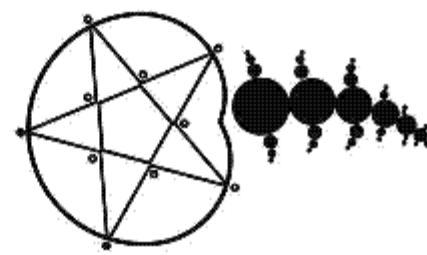

April 23, 2007

approaches and draws near to Earth, Earth backs away, trying to escape, temporarily changing the angle of these moon swirls as viewed from Earth. But still Planet X draws nigh, and the Earth begins to lean to the left, its N Pole trying to escape the hose of magnetic particles coming from the N Pole of Planet X. We have mentioned recently that Planet X was approximately 150° along in its roll, but the point when the Earth's defenses were penetrated is already past, come earlier, as noted on the July 1 crop circle. This point occurred when the lurch, the temporary [lean to the right](#), occurred.

Germany, Jul 2, 2007

Planet X does not leave the solar system in a straight line away from the Sun, it leaves at an angle. It comes in from the direction of Orion, at an 11° angle, then assumes a 32° angle during its approach to the Sun while piercing the Ecliptic, and then takes off at yet another angle. It is not by accident that the Earth is tilted at a 23° angle. During the last passage, when Planet X suddenly took off and jerked the Earth during its exit, this exit [left its mark](#) on the tilt the Earth assumed. We have stated that we anticipate the tilt of the Earth to be less than 23° during this passage, as Planet X will make a more gradual exit than the last time, thus, not jerking the Earth during this exit.



Switzerland, Jul 2, 2007

For mankind, the message in the May 20 crop circle is of a wave, a wave building, about to overwhelm. The globe inside the circle, trying to evade this wave, is Earth. We have described the Earth's struggle to escape the flood of magnetic particles hosing out from the N Pole of Planet X, which is larger than Earth and thus has a larger magnetic particle flow in its field. For the Earth, it is no contest, as this is a flood Earth cannot oppose and cannot escape! This crop circle also implies a rapid buildup, a sudden wave. The Swiss think of themselves as immune to tsunami, but this is a tsunami they cannot escape. The July 2 crop circle returns to this concept, as these circling waves are all encompassing.



May 20, 2007



July 2, 2007

Eastfield Jul 7, 2007

We have hinted that high drama will occur during the passage, not yet detailed by ourselves and thus a surprise to the establishment. We hope for the establishment to be discombobulated, so that the cover-up shatters and the truth is blurted out by the media. The approach and exit of Planet X is often depicted in crop circles as increasing and then decreasing circles, the size of Planet X as viewed from Earth. At first, as infinitesimal as a dim star, but at passage as large as the Sun due to its dust cloud and writhing moon swirls.

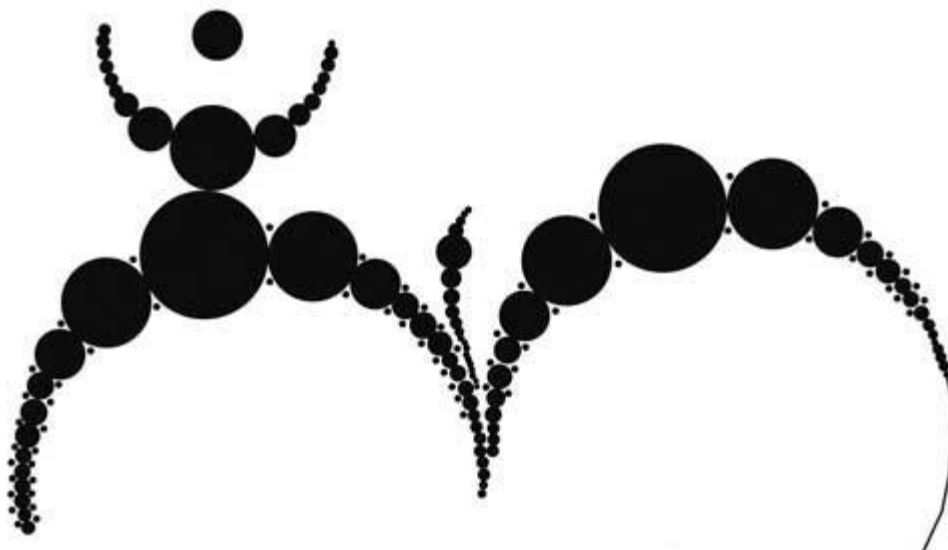

We have stated that Planet X pierces the Ecliptic at approximately the halfway point between the Earth and the Sun, 45 million miles or so. At this point, it stands upright and draws the Earth close to it, for a distance of 14 million miles. At this point, the slowing of Earth's rotation to a stop occurs. This would all seem to imply that a *single* approach of Planet X to the Earth occurs, as then, after the pole shift, Planet X zooms on out of the solar system. The Eastfield crop circle implies that Planet X draws near, then retreats, then draws near again during a severe wobble where it seems to be in two places at once in the sky, then draws the Earth close during the rotation stoppage, then takes off again. At present, Planet X lies close to the Sun in the line of view, so close as

to be lost in the glare. Planet X is closing the gap, coming ever closer and will come near enough to be visible to many on Earth. But as we have explained, the Point of Passage places Planet X further from the Earth, as shown by the angles of the [ZetaTalk Triangle](#) which appeared in two Wisconsin crop circles on [July 4, 2003](#). As Planet X swings its N Pole toward Earth, there is a clash, the N Pole of Planet X wanting to evade the N Pole of Earth, and vice versa. Thus, Earth pushes back in her orbit as far as possible, creating this distance, so that Planet X will diminish in size. Nevertheless, Planet X is still coming closer, closing the gap, more distance from the Sun, less distance from Earth, even though offset to the right. How will the establishment explain a temporary appearance of Planet X in the sky, followed by a diminished size offset to the right of the Sun, then a reappearance of Planet X in the sky along with a severe wobble? A dancing asteroid? A permanent solar flare that dances around the Sun? And what of the wobble?

Haileywood, [July 16, 2007](#)

This beautiful design is in the formation of a butterfly as all of humankind is familiar with their fluttering wings, which point skyward together when at rest, or out to the side, while sunning and airing. Yet regardless of position, the wings always *touch* at the top of the butterfly's body, the pivot point. We have stated that Planet X is coming toward the Earth in a retrograde orbit, now slightly to the right of the Sun as the Earth scuttles back in her orbit to avoid the pressure of magnetic particles coming from Planet X, which is increasingly pointing its N Pole toward Earth. We have mentioned that as Planet X turns in place and the Earth is forced into an extreme wobble by the repulsion of their respective N Poles, that Planet X will seem to move to the right of the Sun, into the [ZetaTalk Triangle](#) position, becoming more visible in the skies as it does, so as it can now reflect sunlight at a proper angle for Earth viewing. Does this changed position mean less stress on the Earth, as the N Pole of Planet X will be temporarily pushed away? No, as with the butterfly wings, there is *some* point where the magnetic fields will touch, and this clash point cannot be evaded.



Hintondowns, [July 16, 2007](#)

This crop circle bubbles out of a spot in the field where cultivation is not possible, due to rocks in the ground or some other such problem. The cultivated food crop circles surrounds this problem spot. Is the problem spot then part of the design? Yes, as the message this crop circle at Hintondowns is relaying is chaos during a rapid adjustment. Volcanic activity will occur worldwide, along the edges of plates and in stretch zones such as the African Rift Valley. The roiling magma will be pressed in all directions during the hour of the shift, when the crust breaks loose and slides over the magma. What will occur on the plate boundaries? Some may find the magma with less pressure, as we have stated will occur in New Zealand when the Indo-Australian plate lifts. Some may find the pressure greatly increased, which is likely to be the case in the Philippines, for instance. But in general, one cannot predict with certainty which volcanoes will bear the brunt and which will have light eruptions. The magma, like the bubbles emerging from the problem spot in the field, will seek the path of least resistance during the chaotic hour of the shift.

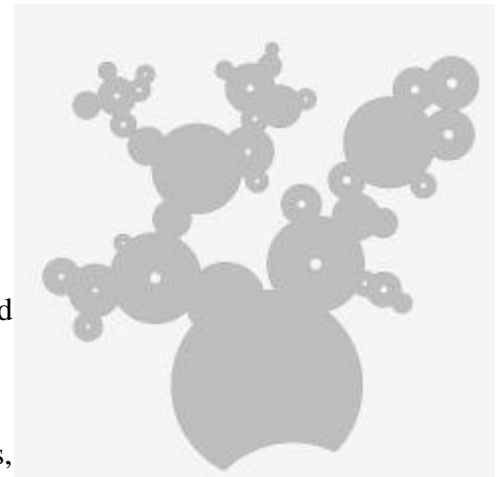

Germany, [July 25 and 28, 2007](#)

We have stated that as Planet X proceeds in its 270° roll, pointing its N Pole increasingly toward Earth, that the Earth will put distance between itself and Planet X, as much as possible. This

will push the Earth to the left, with its N Pole leaning to the left, to escape the hose of magnetic particles coming from the N Pole of Planet X. Eventually, this distance will place the planets in the arrangement we have described as the [ZetaTalk Triangle](#). What is the relative strength of the magnetic fields involves, as this point is approached. At present, the Earth is the lesser influence. Planet X is at least twice as strong a magnetic field, at its current distance. And the Sun is the dominant influence, by far, over both planets.

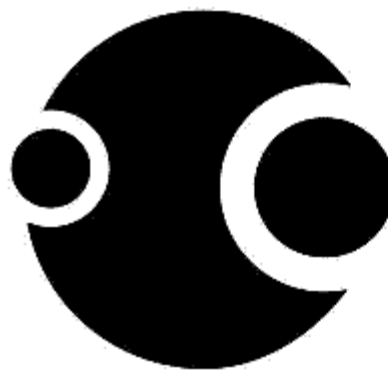

Bavaria July 28



Lower Saxony July 25

Stanton, [August 12, 2007](#)

This crop circle has been interpreted as implying the [Mayan symbol for 6](#), and the swirls in the inner circle the 13 months of 20 days each in the 260 day Mayan ceremonial calendar. The pattern implies neither of these, but those clinging closely to the notion that the End Times will come on Dec 31, 2012 will see these patterns as confirmation that 2012 is the date. Why would aliens from around the Universe communicate with mankind in a dead

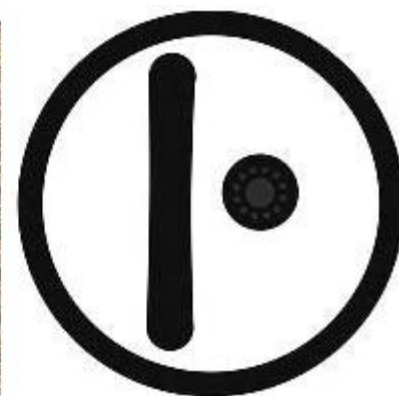

language, dead symbolism, especially when mankind has struck the wrong date when trying to line up the Mayan and Gregorian calendars? We have explained the mistakes made by those who [assume 2012](#) to be the end date, what missteps they took, and how this was essentially a guess, albeit an educated guess. We have stated that [2012 is not the date](#), that the pole shift will occur before that year. That said, what is the meaning of this crop circle? Due to the number of elaborate hoaxes this year, 2007, the makers decided to be ultra simplistic, while at the same time building in an intricacy that could not easily be hoaxed. The 12 swirls around a central swirl in the inner circle, against a backdrop of smoothly laid crop and while swirling in different directions, would be impossible to do with the machines man is using to effect hoaxes. Thus, this is a genuine circle. The swirls in the inner circle are going in different directions, the central swirl counterclockwise, the direction of the solar system from the rotation of the Sun and Earth to the direction of the orbits in the planets in the solar system. Planet X is of course retrograde, assuming a retrograde or clockwise orbit past the Sun as well as a retrograde rotation. Thus, it clashes with the Earth during the passage, and this clash is a factor in the Earth stopping its rotation for almost a week prior to the hour of the pole shift. The 12 outer swirls in the inner circle are swirling in a clockwise direction, the retrograde direction of Planet X. Where the overall influence of Planet X is *less* than the influence of the Sun, it nonetheless overwhelms the Earth due to its pervasive presence, represented by the surrounding nature of the swirls. The Earth is trapped in the cup, the eddy flows of particles coming round the backside of Planet X from the Sun, and roiling in front of Planet X on their way out toward the outer reaches of the solar system. We have mentioned that the Earth at first leans to the *right*, in temporary alignment with Planet X during the strongest magnetic trimester (May-August), but will return to the Earth wobble and lurch when this trimester expires to begin a lean to the *left*. At the extreme, going into the 3 days of darkness, the Earth will be attempting to get as far to the left as possible from Planet X, causing Planet X to appear dramatically to the right of the Sun in line of view. This is the symbolism of the bar, a back and forth effort to escape or placate Planet X, all the while trapped within the larger circle which indicates the cup of eddy flow Earth is caught within.



[Mail this Page](#) to a Friend.

ZetaTalk: Why They Care

Note: written by Jul 15, 1995

People are where it's at, here on Earth. Issues of the coming pole shift, of the ecology, of nuclear disarmament or how many years the Sun has until it burns itself out - all these are meaningless unless one considers mankind. Pole shifts and ecological disasters and nuclear disasters and dying suns occur often in this Universe, and no one notices because it affects no one. Why do we care, other than because we are living in your Solar System today and tomorrow, and because our hybrids are both your cousins and ours, and because your souls will be our future neighbors in the world we are both building? We care because we empathize with your situation, having been there ourselves, and have the rare opportunity, because of your call to us, to become directly involved with you - with the people of Earth.

We, the Zetas, cannot go back, as there have been adjustments to our physiology that would kill us if we returned. We are referring to what happens to physical bodies when their environment changes. You have some sense of this because of reports from your astronauts. After a brief space sojourn, they find their bones decalcified. Imagine what happens after decades away from the pull of a heavier gravity. Another point of comparison is what happens to deep sea divers when they return to the surface. If rising too quickly, after only a few hours at most, they get the bends and die horrible deaths. The body adapts, and must be given its allowance if the return trip is to be made. For us, the return trip is virtually impossible. It is much easier to lighten up than to strengthen. In many cases, to strengthen is impossible. As an example, some oldsters may wish to get into physical fitness, but find the changes they wish to impose on their bodies are no longer possible. Some journeys, undertaken, do not have a return route. For us, this was understood at the beginning.

We are all volunteers here on your Earth, as operating in the Service-to-Others mode we are not commanded. All work is voluntary. Do we miss our home planet? Of course we do, as you might imagine. Imagine yourselves, on another planet, in another galaxy, not ever seeing the flora and fauna familiar to you, not ever seeing the regular rising and setting of your beloved Sun and Moon, not hearing the chirping and singing of birds, the rustle of the leaves in the trees, or the taste of good wine and fresh fruit. Imagine living off rations, sleeping in cramped quarters with no view, with a task that will consume your entire lifetime. We are not only volunteers, we are extremely dedicated volunteers, as we all went in with our eyes open.

All rights reserved: ZetaTalk@ZetaTalk.com



[Mail this Page](#) to a Friend.

ZetaTalk: Zeta History

Note: written by Jul 15, 1995

Our Awakening was not comparable to yours. Our world collapsed before we were contacted by others in the galaxy. We were in shambles. We were in hiding, deep within the ground. We were ashamed. We were not available. We were contacted telepathically, and asked to come out of our underground homes, asked to emerge. Only the venturesome among us did so. In many cases they were slaughtered. Our shame was so great, that the aspect of exposing ourselves to others who could see our shame was intolerable. We slaughtered the messengers, those among us who were venturesome. This held for some time as the mode, then suddenly changed. It was like a wash of compassion came over us, and we had compassion for ourselves. Then everything was different. We were curious and exploratory. We could not wait for contact, and being venturesome was the norm, it seemed. This was due to a combination of factors. In part, each one of us had to forgive our own selves, before we could have forgiveness for each other.

We destroyed our world, much as you are about to do, are in the process of doing. Our world was as beautiful as yours, and will never be the same. The Zeta history is not a pretty one. We watch in horror at some developments on Earth, as there is a parallel. These developments are also not uncommon during 3rd Density throughout the Universe. Harnessing the atom. Creating poisons that last for generations, eons. We did this and more. We created biological elements, what you call biological warfare, to wipe out the supporters of the other side without ruining the territory desired. Too late we realized that the supporters of the other side were us. We are all one, and when we ruin the planet that is our home, we ruin it for all. Our Awakening took 37 years. You must remember that we had a confined society, where escape from a new occurrence was not possible. Our reaction was compressed. Our desire for contact was also mixed in with a desire to expiate our shame. Our desire to change our ways drove the situation, and drives us today, to some extent. Our technology had been focused on instruments of war.

After we had made our world unlivable, we focused on changing ourselves, on genetic engineering to remove those parts of us we deemed responsible for the destruction. So we were advanced in this respect. We were shy, and guests of those who had contacted us. After awhile we saw a role for ourselves which would allow us to feel better about ourselves. Now we are less shy, but compared to other galactic species we are not considered bold. We are known as those-who-mourn. We are hesitant to share this, as no one wants to remember pain. Pain is translated to passion when action can be taken. However, our role here on your world at this time is as a bystander. We cannot interfere, and can only watch you repeat some of our same steps.

All rights reserved: ZetaTalk@ZetaTalk.com



[Mail this Page](#) to a Friend.

ZetaTalk: ZetaTalk Predictions

Note: written on Jan 15, 2002

Many works talk of the passage, but ZetaTalk is the first and *only* to speak to 2003 [Note: see [2003 Date explanation](#)]. We are known for our bluntness, often complained about, for one. Additionally, many groups are reluctant to cause human pain, as the reality that they and their loved ones will die, often painfully, and their lives as lived today hollow, their leadership lying to them, is painful. Thus, they blunt the *truth*, and clothe it in reassurances of better times to come. We have courage, and are working with our emissary Nancy as we are because of *her* courage.

Comparisons to ZetaTalk are constantly being made. As we have pointed out, at least *half* of all claimed messages from higher or other sources are false. The perpetrators *know* this, are consciously aware they are writing a fiction, and enjoying the attention they are getting or the money they are getting if they are a disinformation artist for hire. Beyond the deliberate falsehoods perpetrated, there are the valid or semi-valid messages. Of these, the contactee is often mixing in their own fear or prejudices, coloring the message. Of these, the aliens communicating with the contactee or channel may have their own reluctance to announce the truth, as the coming Earth changes will be horrific for most of mankind. Then there are those valid messages relayed, which are confused as to context. As with Cayce, who describe Earth changes the week of the rotation stoppage, or during the hour of the shift, *not* after the shift itself. Why would he do this? Cayce and those communicating with him felt that mankind would be most aware, and relating Cayce's message to their situation, *during* those times. So those comparing ZetaTalk to Cayce find differences, not understanding this.

Our general advice to mankind is to evaluate *other* communications in accordance with their *proven* validity. Nancy has been stating much, lately, that ZetaTalk has a track record. Scallion too, and Cayce. If a site is not to be assumed to be just so much hot air, and worthless, then it *must* have predicted, regularly, and be found valid! Of not, then please don't bother asking us for a comparison to garbage!

All rights reserved: ZetaTalk@ZetaTalk.com



[Mail this Page](#) to a Friend.

ZetaTalk: Disincarnate Opportunists

Note: written by Jul 15, 1995

Where on a mass level the battle has been won, on individual levels the battle is not over until the soul leaves its Earthly domain. We are speaking here not only of souls residing inside a human body, but of the vast majority of souls who are still, as it were, hanging around waiting for their next opportunity. At this stage of your spiritual development, you develop most rapidly while incarnated. During the tumultuous times ahead, there will be opportunities. There will be spirits who cannot tolerate the distress, and beg to leave their body. This decision is voluntary, within the bounds of what the individual soul can arrange. Therefore, disembodied souls can take charge of a human body, and continue their learning experience, under these circumstances.

Those of the Service-to-Self orientation seek new recruits. The Service-to-Self orientation is very hierarchical and structured. The pecking order is precise. As with any such group, new recruits invariably start at the bottom. We need not say more to explain why those of the Service-to-Self orientation are eagerly awaiting the despair and abandonment many will feel during the coming times. They are seeking new recruits! Thus, for the Service-to-Self, an opportunity to incarnate as a walk-in is an opportunity to influence human affairs.

All rights reserved: ZetaTalk@ZetaTalk.com



[Mail this Page](#) to a Friend.

ZetaTalk: Annunaki

Note: written by Jul 15, 1995

The Annunaki are the giant hominoids from the 12th Planet, spoken of in many names in the legends of man as is their planet - Marduk, Wormwood, the 12th Planet, and lately the inbound Planet X discovered by NASA in 1983. These giants were approximately 50% larger than man, as their home planet is more dense and massive and the gravity on the surface that much stronger. Larger bones are needed to support life there. These giants came to Earth during the passages of their home planet, which traverses the solar system every 3,657 years, as the ancient Sumerians recorded. They mined for gold, a mineral rare on their wandering planet which spent much of it's orbit hovering between the two binary suns it orbits - the Sun and it's dark twin some 18.74 Sun-Pluto distances from the Sun. Much ZetaTalk exists on this matter in the Worlds and Science and Rules section of ZetaTalk, so we will not be redundant on this matter.

However, until recently, there was a Service-to-Self scam ongoing by aliens and humans in contact with these aliens regarding terrifying humanity with warnings about a *return* of these giants to Earth. They are quarantined, kept at a distance in the solar system from mankind on Earth, though allowed to continue mining operations on a moon of Mars. Due to the Rules of Engagment between ourselves and these Service-to-Self aliens we could not discuss this scam without engaging them, and our efforts were needed elsewhere, so we declined the engagement. Since the scam has been dropped, we can now discussion this. There will be *no* return of these giants, who claimed erroneously in their past literature that they had genetically engineered mankind. They did *not* do so, are *not* the creators of man, and man stands in fact as their full equal as 3rd Density hominoids. Earth, in fact, is undergoing a transformation ahead of the home of these giant hominoids, so could in many respects be considered more progressive.

All rights reserved: ZetaTalk@ZetaTalk.com



[Mail this Page](#) to a Friend.

ZetaTalk: Ashtar

Note: written by Jul 15, 1995

Entities go by many names, and in some cases they falsely represent themselves. One must bear in mind that entities in higher densities are not pure, without self focus or ego, nor are they without failure and the resultant guilt. Service-to-Others is not a purity of service, where the entity thinks only of others. This is not realistic, as the entity must watch out for the self, lest the self be destroyed or placed in a position where the incarnation is abortively ended. Service-to-Others is represented by those entities who, in the overall, think of others as often as they concern themselves with the self. There is also some competition between Service-to-Others groups, as competition is not something that ends in the 3rd Density. The Earth is particularly prone, in the Zeta experience, to competition from various Service-to-Others groups. This is because of its history, where various groups involved themselves in guiding Earthlings at various times. The genetics of Earthlings is a soup pot from ourselves, the Zetas, and several other genetically similar hominoids. It is unimportant just which group participated at what point in time, just as it is unimportant which group is affecting the salvation of mankind during the coming Transformation.

Ashtar is an entity group that at one time made contact with humans with the best of intentions. As they were not particularly forceful by nature, they did not defend themselves well when disinformation schemes were ployed against them, and have since left the Earth in disgust. This left a void, a perfectly good alien entity name, unused. The CIA and other groups associated with them snapped up this name, and built upon the legacy. Of course, the message changed from one of hope to one of deception and control. There are now many religious overtones to the new Ashtar message, including a promise that a Jesus Sananda will return to lift the righteous to safety during the coming cataclysms, but look closely and you will not see a message of love. Nor does the new Ashtar message encourage free thought or independence. The new Ashtar message has all the hallmarks of the Service-to-Self, which is not surprising seeing what lies at its base.

All rights reserved: ZetaTalk@ZetaTalk.com



[Mail this Page](#) to a Friend.

ZetaTalk: Confederation

Note: written by Jul 15, 1995

The Confederation does not exist. The name itself implies voluntary membership, and this has been part of the ruse. Were this an ongoing ruse, we would not be able to explain this to you due to the Rules of Engagement. Your government, early on, wished to give the impression that alliances with aliens were possible, and likewise that some alien groups could be shut out. Under no circumstances did they wish for the populace to have the impression that they were being overrun by the alien presence or that they had no control over this matter. Of course, they do *not* have control, as control of contact is in the hands of each individual contactee or human who wishes to become a contactee. Nevertheless, talk of the Confederation is still being bandied about, and if one takes note, marks the speaker as one reluctant to accept the true nature of the alien presence.

All rights reserved: ZetaTalk@ZetaTalk.com



[Mail this Page](#) to a Friend.

ZetaTalk: Council of Nine

Note: written by Jul 15, 1995

Regarding the Council of Nine. There is no such entity, except in the minds of some. This was a fraud perpetrated by humans very skilled at deception, and doing so for profit. This fraud succeeded in meeting their expectations.

All rights reserved: ZetaTalk@ZetaTalk.com



[Mail this Page](#) to a Friend.

ZetaTalk: Ma-Di or DOMA

Note: written by Jul 15, 1995

Ma-Di or the DOMA are not at all what they are purported to be, as they are assuming a religious front in order to get past the guard that humans put up against an alien message. Religious messages, particularly when directed at those who have been raised in rigidly religious environments, are accepted without question when they come packaged in familiar wrapping. Catholics are numerous, forming the bulk of the religious in many countries such as those in South America, and do not differentiate themselves by their dress or talk as strict Hindus or Muslims do. Thus, an indoctrinated Catholic can spread the word without being suspect. What word does the Ma-Di or DOMA wish to spread? That humans should give themselves over as property to higher powers who will watch over them, an extension of the message they received during their childhood religious training - don't think, trust, follow directions. This is not a message those in the Service-to-Others would disseminate, but *is* a common message from the Service-to-Self, who are dictatorial and can best encroach where free thought is suppressed.

All rights reserved: ZetaTalk@ZetaTalk.com



[Mail this Page](#) to a Friend.

ZetaTalk: Ummo

Note: written on Jun 15, 1997

Early in the cover-up on the alien presence were a few well orchestrated hoaxes, the Ummo case among them. As with most hoaxes, publicity and the resultant personal attention were the prime motivators, but when a hoax is elaborate and long lasting, other motivators are usually present. There are few opportunities for instant fame in human society - winning the lottery, making a breakthrough scientific discovery, rescuing children from a burning building, etc. The average human, even those with status by virtue of their position among the wealthy or due to being professionally accomplished, live quiet lives. Outside of the family, the circle of friends, and the immediate coworkers, no one is aware of them. For those individuals with a secret longing to be the center of attention, participation in a hoax can *be it's own reward*. Thus, when those who planned the Ummo hoax were looking for cooperatives, they did not have to look far!

When professional individuals participate in a hoax, for personal reasons, they do so because they are given a rational, an excuse for the hoax, that allows them to explain what they are doing in a face-saving manner. It's for the public safety, to help the government learn of scientists who might be contactees and thus traitors to the human race, or perhaps so the government can learn of *real* technology gifts given to *real* contactees, and thus share these gifts with the rest of mankind. Of course, the motive on the part of establishment perpetrators is greed and the desire to be in control, to retain their power positions, but this is not the way the rationale for the hoax is put forth.

Thus, the Ummo case was a grand scheme to poll the scientific community and locate those scientists who seem to be genuine contactees. What resulted, to the great disappointment of the perpetrators, was contact with yet more individuals desiring to be the center of attention, *not* genuine contactees receiving technology from aliens.

All rights reserved: ZetaTalk@ZetaTalk.com



[Mail this Page](#) to a Friend.

ZetaTalk: White Brotherhood

Note: written by Jul 15, 1995

The White Brotherhood is not from another world, but is a group of psychics supported by various governments of the world, covertly. The White Brotherhood, as it is currently, adopted a name that already had name recognition. This has been a long running fraud, whose purpose is to influence the populace of the world into believing matters that are not true. It is a disinformation campaign, claiming connection with Ashtar though Ashtar had nothing to do with it.

It is a well known fact that telepathy exists between human beings, outside of any influence from aliens from outer space. All life, even plants, share this ability to some degree, as it is related to the flow of communications between living cells. Where there is life, there is the potential to receive a flow of communications from another, and to sympathize with another's flow, and to therefore get inside another, so to speak. When humans are in telepathic communication with each other the communication flow between the brain cells of the one create a pulsing aura of sorts, which expands outward for many hundreds of miles. Getting in tune with this communication aura so as to be in a telepathic conversation involves tuning one's own communication aura to be in sync with the other. Once done, their minds can travel down parallel paths, the listener in parallel with the one listened to. This also has a reverse mechanism, as once this parallel communication is in place, the listener can interject.

It is by this means that the White Brotherhood operates. They are assisted in this with information given to them by the governments they work for. They are even moved physically close to their target human, to maximize the potential for contact. They are given personal information about their target, so as to line their thinking up with what might be in the thoughts of that person. When they have made contact, so to speak, and verified this to their satisfaction by receiving information from the target that confirms they are thinking in parallel with the target, they set to work. First the White Brotherhood interjects a thought, in conversational mode. For maximum effect, the thought is surrounded by visual imagery and emotion, so the thought will impact much of the target's brain and get the target's attention. Then they listen. If the target indicates, by thoughts, that it has received the message and is aware of this, then the White Brotherhood sends another message, and on it goes.

The message the White Brotherhood wishes to extend is that the aliens are not to be trusted. They do not differentiate, but spread suspicion about all aliens. They do this by themselves asserting they are aliens, and making the target human uneasy. What it takes to make the target human uneasy varies, as each person is different. Since they have information on the target, are close physically to the target for easy listening, and can get inside the target's head for endless hours of snooping, they soon figure out what it will take to make the target nervous. They send a very personalized message. The message will be packaged differently for each target, and thus the understanding one target receives may not coincide with what another target receives. If the concepts being relayed are not personally distressing to the target, they will refer to the White Brotherhood as a pleasant experience. If, however, the target resents the concepts being relayed, a battle of wills may result and the experience reported as unpleasant.

What is the goal of all this? It is to keep the world for humans, in the control of mankind, or more specifically in the control of the current establishment. Since the pace of the Awakening is determined to some degree by the fear and anxiety of the populace, they hope to keep the level of fear and anxiety at a very high level. They therefore target authors, journalists, speakers, and others who have the potential of influencing large numbers of others. We are able to tell you of this fraud, as there are not currently any Service-to-Self oriented aliens involved, although this has been the case in the past, particularly at the inception of the concept of the White Brotherhood. Were this otherwise, and were there to be Service-to-Self oriented aliens involved, we would be restrained from divulging this information by the Rules of Engagement.

All rights reserved: ZetaTalk@ZetaTalk.com



[Mail this Page](#) to a Friend.

ZetaTalk: WingMakers

Note: written on Jan 15, 2002

The Wingmakers site is fabulous art, and the artisans are to be complimented on their skill. They have no need for false promotion, in that the beauty of their work, both visual and in sound and story, stands for itself. But to enhance and promote the worth of their world, these artisans, humans, not of antiquity at all, have put the aura of ancient mentors about their work. This is less a fraud than an attempt to gain attention, as there is no malice in the effort. However, to read beyond the immediate desire of human artisans to promote their work, is incorrect. This is *all* there is to the Wingmakers products.

All rights reserved: ZetaTalk@ZetaTalk.com



[Mail this Page](#) to a Friend.

ZetaTalk: Billy Meier

Note: written by Jul 15, 1995. Planet X and the 12th Planet are one and the same.

The Meier case has both truth and fiction mixed into it. Meier was contacted by Pleiadeans, who were answering The Call in the normal manner of Pleiadeans. This was in the subconscious of Meier, who worked at recall as many do. However, he was *not* left with any proof of the existence of aliens, anymore than others. As we have stated, the Awakening goes apace, but is not yet at the point where proof can be left in the hands of humans. What occurred in the Meier case was a combination of the genuine desire of Meier to communicate to others his experience, and the profit and fame motive. He found others believed him, as he was sincere in his descriptions and his tales. One thing led to another, and when proof was demanded, he produced this, literally. He did this to solidify his followers, and strayed little at first from the facts. After a time, as is the case in one lie leading to another, his stories began to deviate from the truth.

As with most contactees, Billy Meier caught the gist of what he was told more than he caught the specifics. What Billy Meier reported as dates for what he termed the great Destroyer, his term for the return of the 12th Planet, has no relationship to any information he was given. He was in fact not given dates, as he asked not to know. It is no surprise then that the dates he projects for the cataclysms are well beyond his life time. This type of denial is exceedingly common.

In his attempt to bolster his *own* stories about his very real experiences, Billy Meier also sought corollaries from history. Not having a name for his visitors, he assigned one, and called his many visitors by a singular name - Semjase. His very real experiences thus became further blurred with past reports just as flamboyant with untruths. *Humans* use names to identify each other and their leaders or idols, but visitors from other worlds operating in the Service-to-Others do *not* use names, being in telepathic contact with one another and thus not needing such props. By giving in to his desire to have fame over fact, Billy Meier marked his tales in a manner that would eventually leave him less and less believable. Contactees are increasingly coming forward with their stories, and stories that have been augmented eventually will stand out as lacking in the ring of truth.

All rights reserved: ZetaTalk@ZetaTalk.com



[Mail this Page](#) to a Friend.

ZetaTalk: Andromeda Contact

Note: written on Jul 15, 1997

Many contactees feel the need to identify *where* their visitors come from, and press for this endlessly. Alex Collier as a contactee felt rootless until he had some place in the sky he could point to. Where he is a genuine contactee, his personal security needs should not be treated as fact. His visitors in fact are from some place he would not recognize, so allowed his assumption to rest without contest. In processing input from this contactee, consider this insistence on security, and interpret accordingly. More than most, he has muddied the waters with his personal interpretations.

All rights reserved: ZetaTalk@ZetaTalk.com



[Mail this Page](#) to a Friend.

ZetaTalk: Scallion

Note: written on Aug 15, 2002

Where we, the Zetas, as alien visitors, are tightly under the Rules of Engagement and Rule of Non-Interference the Council of Worlds imposes, this is not the case with human contactees. *Most* of our work, as Zetas, occurs because a contactee, hearing the details of a situation, becomes motivated to act. *We* do not act, the contactee does. Scallion is a contactee, and is a *very* good sponge in this regard. He absorbs not only what he hears being discussed during this visits, he also absorbs *more* than is on the table, the thoughts in the heads of his visitors, who are many. He puts his own spin on this, fits in into the whole, and reports this to the humanity that hang on his words. Thus, his accuracy track record, which is *far* above chance, is noted, as he is reporting *more* than a human in touch with Earth change. He is reporting what his many visitors, which encompass a large variation of life forms and interests, are aware of. He is coming back from his visits with a smorgasbord of information, which he then sorts out during his dreams or mediation sessions. This is not *all* 100% correct, but is close enough to bring him an avid following, as it ought. As a human, not bound by the rules the Council imposes upon us, he can report his predictions on specific earthquakes.

All rights reserved: ZetaTalk@ZetaTalk.com



[Mail this Page](#) to a Friend.

ZetaTalk: Communion

Note: written by Jul 15, 1995

Regarding Whitley Strieber's book, *Communion*. This book is heavily influenced by the truth, by true experiences of the author. The author is a gifted writer, and though reluctant to communicate with ourselves, the Zetas, and other entities not native to the Earth, he is more driven by curiosity and fascination with the unknown than he is by fear. He has grown past fear to a greater understanding of himself as well as what is termed the Alien Presence.

All rights reserved: ZetaTalk@ZetaTalk.com



[Mail this Page](#) to a Friend.

ZetaTalk: Steve Neill

Note: written on Feb 15, 1997

Made famous an artist who did artwork for the Whitley Streiber books, some of the first books to break open the formerly hush-hush world of contactees, Steve Neill is a relative unknown outside of Hollywood circles. A talented special effects designer, Steve is also a genuine contactee, and his works of art on our thin bodies regularly entrance other contactees who discover them for sale at UFO conventions or elsewhere. It was not by accident that Steve and Whitley discovered each other, nor had either experienced the typical contactee agenda. *Both* these individuals were considered highly talented and given to an independent mind set that would support their fight to have the right to tell their stories. As a result, the first truly compelling contactee story to be mass marketed, *Communion*, was accompanied by this man's spell binding art work.

All rights reserved: ZetaTalk@ZetaTalk.com



[Mail this Page](#) to a Friend.

ZetaTalk: Ruth Montgomery

Note: written on Nov 15, 1996

Ruth Montgomery was among the authors reporting truthfully about the alien presence early in the Earth's Transformation. A skilled and highly talented author, she spoke for many by compiling and reporting their stories. Thus, her books covered a wide range of subjects, allowing contactees and Star Children to recognize their situations, and thus their status, when described.

All rights reserved: ZetaTalk@ZetaTalk.com



[Mail this Page](#) to a Friend.



ZetaTalk: Hopi Indians

Note: written on Sep 15, 1996

The Hopi Indians are instrumental in the Awakening, as their culture is open to contact with extraterrestrials and thus they have had open contact ahead of most of the rest of the world. Unlike closed cultures, where denial rules so strongly that those suggesting that visitations are occurring are punished and even killed, the Hopi honored their contactees, and likewise treated their visitors with respect. Consequently the Hopi are being used as a communication vehicle during the Transformation period. Those among them brave enough to tell their stories to the world are running the same risk as all who further the Awakening, as the establishment wants the status quo to continue and death and injury and endless harassment are common tools of the establishment. The Hopi are perhaps better suited than most to be educators, as their true stories are often scoffed at as being just Indian legends, so the impact their stories make to a great extent go unobserved.

The Hopi have long been visited, and this is one of the reasons they invite visitations. Children are told at their grandparent's knee about such visitations, and take this all to be as real as the Sun and the Moon. As with the rest of humanity, the Hopi fell under the rule that all visitations should be placed only in the subconscious after Earth's Transformation vote concluded some 50 years ago. To reduce fear and anxiety, which would incline humans toward the Service-to-Self, all visitations are to be recorded only in the subconscious, as the vote was overwhelmingly for the Earth to become a home for those entities in the Service-to-Other. Knowing the likely outcome of the vote, those visitors in contact with the Hopi set about giving them some ammunition to use during the coming Transformation period. There were several significant visits, each with a particular purpose.

- About the time of the deliberate crash at Roswell, the Hopi were visited by the same aliens that intended to sacrifice themselves and die in the crash. This was to spread a countering message to any the military would propagate, and in truth the Hopi message *has* been propagated as widely as the true information leaked about the crash at Roswell. These stories of small hominoid aliens visiting the Hopi about the time of the Roswell crash have often been interpreted as crash survivors taking refuge among the Hopi, which was not the case. However, this detail is irrelevant in the scheme of things, as the point intended was made.
- As has repeatedly been done during visitations, those aliens visiting the Hopi attempted to explain the meaning and intent of those Star Children who incarnated as Jesus, Mohammed, and Buddha. As is usually the case, the message gets partly understood and partly distorted during repeated telling, as the ear of the listener hears what it wishes to hear. In particular, as the Hopi live in a predominantly Christian nation, what they passed on about the history of Jesus got immediately distorted by faithful Christians who chose not to offend the church elite. Where the Hopi were told that the legacy of Jesus continues, many chose to hear that he had progeny, wishing to cling to a living remnant of Jesus rather than having stand on their own.
- The coming cataclysms were relayed in great detail to the Hopi, who feel a responsibility to alert as much of humanity as will listen to their warnings. As with most warnings about the coming pole shift, these warnings are discounted as poetry, or the usual dressing the passage of the millennium is given. The Hopi plan to escalate their warnings, and as the American Indian is revered throughout the world more so than they are revered in their own land, they are ideally positioned to be the messengers of such a devastating message. We wish them well in this endeavor.



[Mail this Page](#) to a Friend.

ZetaTalk: Lou Famoso

written Sep 30, 2006 on the live GodlikeProduction live chat.

I would like to know if the Zetas would like to comment on the NDE of [Lou Famoso](#). To me the archangel michael is showing him the account of the coming of Planet X, the events leading up to it, and the aftermath. Lou's NDE happened in 1963, well before Sitchin's revelation.

Nancy is certainly not the only person to receive a vision of the coming times, as there are numerous individuals in every culture around the world receiving such visions. The intent? To have the person communicate their vision, in a firm and determined manner! Nancy and this gentleman are two such examples, both a success. Most such visions and intentions of the soul to have a role during the coming times do not succeed in this manner. It takes courage, and a firm commitment to the truth.

Then it seemed that I had become a part of each of these visions. There were scenes of men in uniform killing other men in uniforms. I recognized some of the insignias and some were from the USA. There were also thousands of them not in uniforms killing even more thousands not in uniform. It was like looking at toy figures moving on their own, mowing down other figures, different countries, different nations, different religions, different weapons, different decades, but always resulting in hundreds of thousands dead and dying. I wanted out of there. I could feel the pain these people were suffering.



I asked the being, "Why was this and how long was this to go on?"

The being said, "Man will prey on man until man will pray for man."

The next vision was of floods - many of them spilling across the earth on different continents in different seasons. I am again walking among it, feeling the force and taking in the smell of death. Hundreds of lives and acres upon acres of crops were lost as well as hundreds of stock and wild animals floating away into the abyss.

Then I was watching volcanoes from around the world erupting, first one then another. The molten lava burying whole towns and villages and the people and animals within them. I gazed among the ruins and saw little left of what once stood there.

The last vision I saw in the screen were of earthquakes destroying sections of almost every continent. One was a massive one in America - most others were in Europe and the Orient. Again, thousands are killed. Structures are crumpled. The landscape leveled. I turned again to the being and he said, "There will not only be more of what you have seen but there will come a time when it will all happen at the same time and it will come at the same time of mans' greatest sins."

A large mass passed me, larger then any of the planets known to me, and as it passes, I see the earth wobble wildly as would a top toward the end of its spin. The rotation stopped and slowly started again but it was tilted now and I was drawn in closer like the zoom of a lens.

The ash clouds that had engulfed the earth thinned, and like a tack welded piece of metal being dismantled, I could see the ocean bodies starting to rise - first the Pacific along the "Ring of Fire", then the others, synchronistical.

As the waters shifted upon the landmasses, the landmasses started to sink under the waters added pressure upon it. When the pressures equaled out, to the spin of the changing axis, the earth no longer looked as it did moments before. It was newer, cleaner, more beautiful with darker greens and lighter blues. Some of the new landmasses looked similar to a few of the other planets I had recently visited with Michael.

People were upon this earth and appeared happier and more content although seemingly living like the native populations of old.

Cities, built by the Ancient Ones, that were buried beneath the oceans, were now being populated by the surviving people in this new world. I saw tribes joining tribes and small nations forming, but it was what I didn't see that made my heart burst. There were no more wars. True peace and happiness had finally befallen on humankind.

Gabriel now tells me that this is his message that I must take back, to let others know that there is little to fear, for the earth will go on forever as did all the planets I had visited. I am to tell the world to look to ORION and they will know when the new world will come upon them.

I ask him, "What of the others there on earth during the change?"

Gabriel tells me that all will be lifted. Some will be lifted higher than others and no longer enjoy the physical realm, while some will be left on the earth to replenish and rebuild the physical. They too will be of a higher elevation than any that are living there now!



[Mail this Page](#) to a Friend.

ZetaTalk: Herculubus

written Nov 2, 2006

How about Ramatis, Brazilian prophet, who wrote the book Mensajes del Astral where is described the approach of an intruder planet into our solar system? [and from another] <http://www.crawford2000.co.uk/> In 1950 a celebrated Brazilian medium named Hercilio Maes channeled a prophecy from his guide Ramatis. Maes predicts that the earth's axis will change through ninety degrees due to the gravitational pull of an enormous new planet which will enter our solar system soon. [and from another] <http://ufopi.freehomepage.com/> Ramatis delivered lectures to standing room only crowds through human instruments like Brazil's Chico Xavier and Luis Muzio. Ramatis discussed the imminent destruction of Earth by an orphan planet named Herculubus, orbiting an invisible sun named Tila, whose trajectory brought it through the solar system every 6,666 years.

We have lately been asked to address a prophet in China, [Zhuge Liang](#), and a little known but genuine report of a NDE by one [Lou Famoso](#). Both spoke of the coming pole shift and spiritual transformation of mankind. We mentioned that all cultures have such prophets, and in the current time, many contactees are given visions to relay, though not all come through with their mission completed. In S. America, the primary prophecies relaying the coming pole shift have been from an entity known as Ramatis, who used several channels, relaying the same message from each. All the channels Ramatis used were sincere, with the message essentially being relayed unpolluted by the human vehicles. That the message of a 90° shift, due to the passage of a large planet with a long orbital period, which orbits two Sun's, one of which has never lit and thus is invisible, remarkably parallels our description of the orbit and passage of Planet X. However, *all* channeled work suffers from the limitations of the human to relay the intended message, or confusion among those hearing the message.

Herculubus is interpreted to be as large or larger than Jupiter, but the intended impression was to be huge when viewed from Earth, during the passage. Planet X indeed covers the Sun during the passage, particularly the writhing dust cloud and moon swirls which reach out from Planet X for an extensive area. In trying to relay these details, this impression, the channel or those recording the session took the Planet X complex to be a *planet* that large, thus monstrous. Likewise the orbit period of 6,666 is confusion between the period approximating 3,600, or our estimate of 3,657 years, and the Biblical number 666 interpreted to be the mark of the Devil. If the channel was well versed in the Bible, and the channels of Ramatis were, then any discussion of the End Times would bring up 666 as an important number. Channeling is *not* using the channel as a typing machine, it is using the channel's education, understanding of science, ability to entertain concepts, command of the language, and ability to formulate analogies or create scenario descriptions with depth and detail. If the channel has no word to describe something the spirit wishes to relay, the channel will wrap words about the concept as best it can. Thus, the possibility of distortion exists.

Bearing this in mind, these are valid prophecies, and should be carefully read with an open mind that looks for *similarities* with other valid prophecies, rather than dwelling on the differences.



[Mail this Page](#) to a Friend.

ZetaTalk: Beatles

Note: written during the Aug 31, 2002 Live ZetaTalk IRC Session.

George Harrison *was* beloved, and *many* ached for him, due to his good work in the world, asking to lift his pain. Many assume that he wanted to live. He did not. Cancer is a symptom of a desire to *die*, and he had a long bout with this. However, he declined, wanting out, and his wishes of course prevailed. John Lennon likewise was aware of the potential for assassination, and cared not. He was *not* viewed to be in a position of influence, requiring protection from the Council of Worlds, nor did he himself want this. Many who live as though casual about life, are in fact desiring a quick end, though they do not so state this.

Note: Nancy's [Aug 31, 2002 IRC Stumble](#) explained.

All rights reserved: ZetaTalk@ZetaTalk.com



[Mail this Page](#) to a Friend.

ZetaTalk: Celestine Prophecy

Note: written on Dec 15, 1995

Amongst the messages from alien groups during the Awakening are many written as poetry, so that the humans who are the intended audience will lend an ear, entranced. The *Celestine Prophecy* intended to impart a deeply spiritual message, touching on the very essence of awareness of and caring for others. As entities, whom humans refer to as spirits or souls, can communicate with or without physical bodies, the interaction of spirits in light form was portrayed. The *Celestine Prophecy* should be read as the poetry it is, and not taken literally. If a man calls his beloved the light of his life, the beacon by which he is guided toward true love, one should not look for a headlight planted on the beloved's forehead. Look to the underlying meaning, and listen with your heart.

All rights reserved: ZetaTalk@ZetaTalk.com



[Mail this Page](#) to a Friend.

ZetaTalk: Way of Explorers

Note: written on Apr 15, 1996

A difficulty facing those who would have the cover on the alien presence lifted is how to let the truth out with less than a bang, how to say that formerly there were lies but today there is truth, how to avoid scrutiny for past lies and how to do all this while protecting the egos and reputations of the dozens of individuals who might be affected. One means is to have the messengers be popular and beloved, as the populace is then less prone to shoot the messenger. Another means is to create a buffer, where those who are now ostensibly talking can remain anonymous. And yet another means is to have the messenger be viewed as impeccable, a rock of integrity. The former astronauts, whom the public has *no doubt* were silenced, are the perfect messengers. Thus recent efforts by the astronauts to get the truth out should be taken seriously.

All rights reserved: ZetaTalk@ZetaTalk.com



[Mail this Page](#) to a Friend.

ZetaTalk: Far Journeys

Note: written on Jan 15, 1996

The author of the book *Far Journeys* is spinning fiction, as can be quickly demonstrated. His proposition is that aliens who cannot themselves generate emotion can siphon this off from an emotional species. This is physiological nonsense. If a species is not experiencing emotion themselves, lacking the pathways in the brain and the hormonal stimulants, they *cannot* experience this vicariously. There are those who wish to alienate humans from any contact with visitors from other worlds in order to retain control over humans society, but this author is doing so purely for the profit motive. Fear sells books, as people are quicker to stay abreast of bad news than good, a fact to which any newspaper operator will attest.

All rights reserved: ZetaTalk@ZetaTalk.com



[Mail this Page](#) to a Friend.

ZetaTalk: Cosmic Voyage

Note: written on Apr 15, 1996

Though well intended, the author of this book is receiving a mixture of correct and incorrect information, from alien entities from both spiritual orientations. He is unable to sort this out and has shuffled all together into a hopeless tangle. Where it may be true that aliens would like to use him as a communication vehicle, *none* of those sending him messages is satisfied with the results! Therefore, unless he learns to discern and becomes a messenger for one group or the other, he is likely to be abandoned. The tale about Mars and Martians is absurd, as Mars was never capable of sustaining an intelligent species, and where Mars was indeed a temporary mining outpost for the giant hominoids from the 12th Planet they were quarantined from Earth, not transplanted here. Since the book is a garble of truth and fiction, however well written, we would not recommend it be read by any but the most discerning, and then taken with a grain of salt.

All rights reserved: ZetaTalk@ZetaTalk.com



[Mail this Page](#) to a Friend.

ZetaTalk: ET 101

Note: written on Jul 15, 1997

A very popular notion during this New Age period is the idea of being a Star Child. Anyone who feels less than special can claim this status, and who's to say otherwise when incarnations *cannot* be deciphered on the outside - both home grown and star wanderer spirits look the same when incarnated into a human body. However, where the vast majority of those claiming Star Child status are bogus and well know it, a few are genuine. Such authors as [Scott Mandelker](#) and Brad Steiger are among the few who are genuine Star Children, with a mission to assist mankind during the Awakening by describing reincarnation in a fashion that many can relate to - less ethereal and more down-to-earth and humorous, and filled with specific examples. In this, they have succeeded, and enjoy continuing success.

All rights reserved: ZetaTalk@ZetaTalk.com



[Mail this Page](#) to a Friend.

ZetaTalk: Secret Vows

Note: written on Jan 15, 1996

During the Awakening, anyone browsing the rack at the book store where personal accounts of visitations are stacked will find an increasing number of books written by those wanting to get in on the act. As with channeling, *most* of these books have been and will continue to be without basis. Such a book is *Secret Vows* by the Twiggs. It is unfortunate, during a time of rapid change when humans will soon find themselves dealing with geological upheavals, crop failures, and the collapse of their social structure, that they cannot simply be exposed to *truthful* personal accounts regarding the alien presence. When so much denial and disinformation already exists, this only makes it more difficult to sort it all out.

All rights reserved: ZetaTalk@ZetaTalk.com



[Mail this Page](#) to a Friend.

ZetaTalk: Farsight Institute

Note: written on Dec 15, 1996

The Farsight Institute is among the many supposedly private arms of the government disinformation campaigns.

- Formed from the remnants of the CIA Remote Viewing project, the Farsight Institute is hardly a private enterprise. The CIA has their slimy tentacles all over the group that runs the Farsight Institute, from instructors to funding to those on the staff as supposedly psychic seers. Thus, any message emerging as a consensus from the supposed psychics on staff can hardly be considered truthful. Does the CIA lie?
- What verification does the public have that the Farsight Institute even *has* an impressive track record. Basically, because the CIA implied that its forerunner was considered accurate enough to warrant funding. Does the CIA lie?
- The CIA was at the helm when the Brookings Report, which they commissioned, issued forth with dire warning on how the public would react to knowledge of the alien presence. Now we hear from the Farsight Institute that Hale-Bopp, which is a CIA fraud to divert attention from the 12th Planet, is being followed by an intelligently driven object, which is yet another fraud. All this is to support the Hale-Bopp conspirators, buddies of the CIA. Should we *believe* this psychic message? Does the CIA lie?

All rights reserved: ZetaTalk@ZetaTalk.com



[Mail this Page](#) to a Friend.

ZetaTalk: Commander X

Note: written on Feb 15, 1996

Early in the disinformation campaigns put out by the government were attempts to make otherwise tenable situations look absurd. One such tenable situation involved the Men-In-Black, whom many humans have encountered after answering a knock at their door. As the Men-In-Black are *residents* of Earth, having been transplanted here, they have not been bound by the same rules that visitors from other planets must adhere to, and thus encounters with the Men-In-Black are remembered *consciously*. Appearing and disappearing without a trace, but without *ships*, the Men-In-Black were perfect candidates in the minds of many for subterranean living.

As your government had itself begun to burrow, both for Alternative 2 and to setup facilities for aliens in the Service-to-Self, with whom they had arrangements at that time, they didn't want the curious populace snooping around. To discredit any discussion of subterranean living, they set out to make the premise absurd, which Commander X took on as *one* of his missions. The hollow Earth premise is absurd, as anyone giving half a thought to what flows from active volcanoes can conclude. What kind of living takes place in the midst of white hot lava?

All rights reserved: ZetaTalk@ZetaTalk.com



[Mail this Page](#) to a Friend.

ZetaTalk: Phoenix Group

Note: written on Dec 15, 1995

Where former members of the government, sworn to secrecy on the *real* alien presence, cannot talk about present or past alien matters, their oath does not prevent them from *fabricating* stories such as the K-2 report from the Phoenix group. Why would they bother? The trend within MJ12 has been to allow the truth to leak out, to educate the public about the nature of the alien presence and the government's past actions. Some former members resent this posture, and were more comfortable with the former mode of operation - warning the populace away from contact. Fabricating stories is unlikely to prove embarrassing, as the *real* story is unlikely to be unveiled to stand in contradiction to the fabrication.

To get to the truth of the matter, ask these questions. Why would these former members of intelligence operations be allowed to undertake activities which are a breach of their security oath? Why would this group have more success than all the other UFOlogy groups? Why would their findings stand at odds to the reports of contactees whose genuineness can scarcely be doubted? Where the Phoenix group claims to be seeking the truth, they themselves could scarcely stand scrutiny.

All rights reserved: ZetaTalk@ZetaTalk.com



[Mail this Page](#) to a Friend.

ZetaTalk: Leading Edge

Note: written on Jul 15, 1997

Leading Edge fancies themselves as just that, but in fact they are trailing. Information garnered from others and processed does not *lead*. Leadership requires insight or input, of which Leading Edge has little. Thus, their recommendations and promotions should be treated as just another comment from a man on the street, as this is in fact what it is.

All rights reserved: ZetaTalk@ZetaTalk.com



[Mail this Page](#) to a Friend.

ZetaTalk: David Icke

Note: written on Feb 15, 2002

During the decades between Roswell and the present, the good aliens who had contacted MJ12 to counter the likes of the Ominipotent Krlll persisted. Movies such as *ET* and *Close Encounters* have their basis in the growing perception that there were *two* types of aliens. However, there are those humans who could not sort this out, and continue to believe that *all* aliens are the bad sort, and one should have their guard up against them all. A strong segment of the military and CIA likewise benefit from this perception, as they would like to see the public cling to them for defense, and not turn in curiosity or welcoming toward the alien presence. This is simply territorial protection on their part, but nonetheless the public is told horror stories *only* by this crowd. David Icke, while sincere, is being used by this crowd, who present him with so-called evidence that horrifies him.

Thus, it is difficult for those in the general public with nothing but conflicting stories to sort it out. Not a small victim of this business is that those who would genuinely like to reach out to what they sense are visitors, are very fearful. They essentially resign themselves to death, to being eaten or tortured, when giving The Call. Wet with sweat, trembling, they return from their first contact, requiring days to adjust to the idea that the meeting was pleasant, interesting, and no harm was done to them. The conflicting stories about alien intentions has become a type of war, between factions of the military and former MJ12 members, some of whom feel the good aliens could greatly assist mankind if an embrace and awakening were made. Thus, to some degree, it is a battle of the titans, with conflicting stories circulating on the Internet, both sides bashing each other mightily.

All rights reserved: ZetaTalk@ZetaTalk.com



[Mail this Page](#) to a Friend.

ZetaTalk: Booth Blunder

written Mar 20, 2004

Would the Zeta's like to comment on David Booth's visions, since he has a documented track record with the FAA of the 1979 AA DC- 10 plane crash.

Suddenly on the talk show circuit in 2004, a virtual unknown with only a single premonition as prophecy track record, [David Booth](#) became the darling of the circuit due to a series of prophetic dreams about cataclysms caused by a passing body as large as the Moon. He seemed sincere, the premonition and his reporting of it to the FAA in 1979 were of record, and as a millionaire it seemed his motive was concern, not money, despite the up front pitch for book sales. Suddenly *the* new Pied Piper, the man without a failed track record as yet, it surprised *none* of his hosts when he stated he was invited by Sister Lucia to visit when he was scheduled to be in Spain. So billed as delivering potential insider information on the 3rd Fatima vision, he reported on C2C live radio that a visit had occurred, a personal message relayed by the Sister, and a request by the Sister to keep the content private. Within a day, this report was dashed as the C2C producers announced they had called the Carmelite convent and found *no* visit had occurred, nor had the aging Sister entertained anyone for some time.

Why did Booth, and in particular Wayne Green, his partner in this matter, put themselves in this position? This was, of course, not the expected outcome, thus Booth anticipated *other* than this checkout by the C2C production staff, but rather cooperation, as the matter was arranged at a *much* higher level. Fold into this action a recent high profile visit by VP Cheney to the Pope, during the World Economic forum last January, 2004. Ostensibly to discuss Iraq and the search for peace, there was a request made by the VP to allow Booth to indeed contact Sister Lucia, who requires the Pope's permission to see *any* outsider. The beleaguered Pope refused, having scandals enough to deal with, his primary concern the state of the Church. Refused, the scam moved forward anyway, in anticipation that *no media* exposure of the fraud would occur, and a new Pied Piper in the employ of the White House would have his mystique increased. This is, after all, the mode of the media these days, to *not report* the truth, to *avoid* facts the White House wants buried, so continued cooperation was expected.

What went wrong, then, for the C2C producers to have the balls to expose the scam? As we recently mentioned, [ZetaTalk](#) and ZetaTalk alone has been found, in trial focus groups worldwide, to be a known and respected source of information not only on what is happening, but on how to survive, and the *true* world powers, which are *not* merely the political puppets strutting on stage, have determined to promote this information source to better the chances of survival groups, as they, the elite, have discerned this increases *their* chances also. The scapegoats in the big lie will be NASA and the White House, who are not going down quietly. Sedna, and the Booth maneuver, are examples of rebellion and resistance. Who will win? This is no contest, with the powers that *put* the political puppets in place in the first place having the upper hand. Booth was savaged first, but expect more fallout soon.

U.S. Vice President Dick Cheney and Pope John Paul II briefly met at the Vatican on Tuesday as both sides worked to play down differences over the war in Iraq.

[CNN, Jan 27, 2004](#)





[Mail this Page](#) to a Friend.

ZetaTalk: Chariot of the Gods

Note: written on Feb 15, 2002

The book, *Chariot of the Gods* by Van Daniken, was considered radical when first published, but its success is due to the simplicity of the explanation it offered. Offering a web that encompassed cave man drawings, landing strips high in the Andes, and the current experiences of man out in space, was a hit. Few could find fault with the logic, which was in fact based on truth, and this has held through criticism. By giving a rational argument to the concept of visitors, Van Daniken is to be applauded.

All rights reserved: ZetaTalk@ZetaTalk.com



[Mail this Page](#) to a Friend.

ZetaTalk: Star Trek

Note: written on Jul 15, 1996

This popular and long running TV and movie series speaks deeply about the alien presence to its many fans. Does it depict life among many species from other worlds or reflect what space exploration might present to mankind should they ever get outside of their solar system? No. Star Trek is artificial in so many respects that it can only be called fiction without a parallel in real life. It skews in the direction of a military lifestyle, where such structures are found only within Service-to-Self groups, the vast minority throughout the Universe. It presumes that alien groups can affect each other freely, without supervision, when the Council of Worlds in fact monitors and polices all interaction between groups. It implies that submission to administrative oversight is voluntary, and that rogue groups can escape detection, when the opposite is true. Where Star Trek has encouraged the Awakening is in correctly presenting the possibility of encountering varied life forms surprisingly different from life forms on Earth. Spiritual possession or walk-ins are regularly featured, as are habitats poisonous to life that has not evolved there - all quite true.

All rights reserved: ZetaTalk@ZetaTalk.com



[Mail this Page](#) to a Friend.



ZetaTalk: Dark Skies

Note: written on Nov 15, 1996

Is there truth to the TV series *Dark Skies*? Yes and no. The truth is wrapped in such silly absurdity that it is being allowed to be said. For a series to state that President Kennedy was killed because he was loose lipped about the government's knowledge about the alien presence, or that he was killed by CIA marksmen, or that more than one marksman was used, or that Jackie was told the truth, or that Ruby killed Oswald under orders, or that any witnesses or knowledgeable persons thought at risk of talking were systematically killed - is a tale that would *not* be allowed to be told in as graphic a manner as was done in *Dark Skies unless* .. it was wrapped in absurdities like alien implants living in the back of human throats.

The series will continue to tell truth wrapped in absurdities. MJ12 members are *not* pressed into service, as grappling with reluctance is not something MJ12 has the time or resources to do, but MJ12 *does* meet in secret, at times close to Washington DC, for instance. It is up to the reader to sort out the truth from the fiction presented, which should not be difficult. How likely is it that alien scorpions the size of an adult man's fist could live in the back of a human throat without affecting the ability to swallow or breath or eat one wit?

All rights reserved: ZetaTalk@ZetaTalk.com



[Mail this Page](#) to a Friend.

ZetaTalk: Taken

Note: written during the Dec 14, 2002 Live ZetaTalk IRC Session.

Spielberg produced, in the past, the *ET* movie, *Close Encounters*, and was know to be ET friendly in this regard. A Star Child, well versed in his past life experiences and educated in his present incarnation with the variety of life forms and the rules the Universe operate under, he was here on a mission. It was announced that *ET* would be *re*-released in theaters this past summer, but this did not occur, merely a CD version for sale. Instead, in the manner of recent film releases, *Taken* was produced, obvious from the commercials to be akin to the message given by *ID4* and *Signs*. The aliens are here to eat you, takeover the planet, but mankind going into hand-to-hand combat with aliens can win the day! This tone in the recent movies is reflective of *what* is being allowed to be presented to the public, via Hollywood, which does indeed get censored by the powers in the White House.

So how would Spielberg, given his message, but only allowed to produce a movie in line with the anti-alien strong-arm tactics in place since the Bush administration assumed a virtual Martial Law of the media, tell the truth? Nancy had been asked about this, before it was aired, and simply stated via email to wait to see what Spielberg would *do* with the series. In other words, the commercials would *not* forecast the ultimate message, and they did *not*. There is a mixture of truth and fiction, as usual in the movies.

CIA/MJ12

Truth is primarily about the *government* role, their agenda, from start to end. Shown as ambitious for the technology, coveting this for themselves in elite groups, and keeping the truth from the public. Truth in that the CIA, highly influential to the point of dominating MJ12 in the early days, would experiment on humans suspected of being contactees or use military personnel like lab rats. Truth in assassinations freely done, by those in the Secret Government, outside of the official rules the Governing Board operated under, but allowable under the need-to-know secrecy that kept *most* operations from being discovered.

Contactees

Spielberg was allowed to display the government, the CIA, with this degree of truth as he presented the contactee experience as *taken*, an abduction. But look to the actual effect or real contactees! Even in the contactee support group, the rampaging gunman was *not* a contactee, but someone abused and angry and looking for attention in his denial of his actual childhood abuse. Contactees, while screaming and enraged at being *taken*, later were presented, to a one, as having integrity, being loving and protective of others, and basically in the Service-to-Other orientation.

Zetas

And what about the agenda of the aliens, clearly presented as Zetas. They are shown cooperating with honest requests, as the MJ12 agent wanting to see his dead father again, even at the sacrifice of the Zeta life in this cooperation. They are shown as wanting hybrids, which is a *truth*, although the real reasons for the hybrid program were disguised into scientific curiosity rather than in step with the Transformation of the Earth. It was implied that humans died under their hand, during early DNA or hybrid attempts. This is a falsehood insofar as human devastation, but *not* insofar as Hybrid devastation, as our early attempts were often failures, and those incarnating souls living out their lives, by choice, in diminished bodies as a result. The Zetas are shown as being protective of their hybrids, a truth.

Thus, in the end, the general tone comes across as *pro* Zeta as scientists, *pro* hybrid as strongly Service-to-Other, *pro* contactee as high integrity and self sacrificing and protective of others, and *anti* CIA and MJ12 in their human agendas and ruthless actions! Not bad, Spielberg, while operating under gun fire and with an almost impossible agenda to achieve!

All rights reserved: ZetaTalk@ZetaTalk.com



[Mail this Page](#) to a Friend.

ZetaTalk: 10.5

written May 4, 2004

What the significance of the mini series 10.5? Is somebody in the know giving the public a last minute heads up?

The list of movies depicting sudden and horrific events that simulate what we have predicted for the pole shift has now, in the month of May, 2004, increased by the count of two. We are frequently asked to compare our description of the pole shift to what is being depicted by those stunned by what they view. Will it be this bad? How will it differ? The prime difference is that the movies, being fiction, are single thread, with one theme, where the pole shift will be a web of disasters, all interconnected and affecting one another. The second difference is in the reaction of people to the disaster. They function. They keep their heads. Political appointees rise to the occasion and help those they swore to serve. All fiction, again. The third difference is that there is seldom a *cause* given for the disaster, which thrusts itself suddenly upon mankind. The movie makers are nervously avoiding a Planet X scenario for fear of awakening the public too soon. Thus, each of these movies is like a clue, a piece of the puzzle the public is not to see put together until the last days of disaster, at least this is the plan. Let us step through some of the movies released recently, with this in mind.

The Day After Tomorrow

Unlike the *real* Ice Ages, which do not just inexplicably freeze a spot on the globe, this is presented as a climate change solely, *not* a crust movement to put a part of the globe in the position of being a new pole, the true cause of Ice Ages. During the last Ice Age, which laid atop Europe, Siberia was warm enough for mammoths to graze on grass year round far into the polar circle. Did the Sun turn off when it shown on Europe, and blaze doubly strong when over Siberia, on the same latitude as Europe? This *obvious* fact is avoided. It just happens, so get prepared for climate change to occur suddenly and inexplicably. Of course, this *will* happen as a result of the coming pole shift, for India and the Bulge of Brazil, and sudden cold from lack of sunlight for these spots will bring freezing cold and death from exposure quickly, as we have stated.

10.5

Unlike *real* quakes that rearrange geography, this series of quakes stands alone. Where are the collateral quakes along the plates affected? Where are the adjustments elsewhere in the world? For over a year now, in the *real* world, gas lines and refineries have exploded, water mains have burst, trains have derailed, bridges separated and dropped, roofs collapsed, and factories have exploded in clouds of chemical poisons, but *none* of these phenomena that in fact accompany rearranged geography were included in the movie. It was deemed too horrific, so the theme was a single thread only so that *recovery* could be the presumed outcome. Will quakes topple cities and tear down bridges and create new inland bays where none existed before? Absolutely, and we have predicted that such a tear will occur through Pakistan into Russia and a widening of the St Lawrence Seaway and Red Sea will occur.

The Core

Unlike the *real* core rotation, which is driven by molten parts constantly chasing that which they are attracted to but cannot reach because of the momentum this chase creates, in this movie rotation just *stops*. As with the *real* rotation stoppage, there was in this movie an association with the Earth's magnetic field, but there reality ends. The Earth's magnetic field is in synch with the Sun's field,

and is not at all reliant on a rotation in the core, nor does a magnetic field turn into a killer laser during rotation stoppage. Is the public to presume, when rotation stops the week before the shift, that man can *fix* it? At the time this movie was released, this was the hope, as there were *no* plans to inform the public if rotation suddenly slowed to a stop. We have stated that rotation will grind to a halt, with the Earth intact, prior to the shift. But this will be accompanied by *increased* quakes and moaning of the Earth, and no manmade fix will be at hand.

Deep Impact

Unlike *real* bodies that sling close to Earth, and cannot be deflected, here NASA comes to the rescue. Primarily a sociological study, cities remain calm and the wheels of commerce turn, because the President *says* so. Myth one. Inclusion in survival bunkers is determined by lottery, not by the power mad elite who serve themselves only. Myth two. All citizens are deemed equal during this lottery, unlike the *real* hopes of those wanting to impose Martial Law, which is to select out the strongest specimens for their future worker class. Myth three. The public passively waits until told to head for the hills, and then waits quietly in their cars on a stalled highway, expressing no more fury at certain death behind them than an occasional honked horn, unlike the *real* reaction of a public seeking safety in the hills, which is to tear through any barricade and grab any safety line in sight. We have predicted that the public will start slipping to safety in stages, so that in the last days only those unwilling or unable will be in direct danger such as in coastal cities, and that governments will resist *any* announcement.

Volcano

Unlike *real* volcanic activity, which makes itself known in a steadfast manner, this volcano *develops* inexplicably without any warning. The motive here is to warn those living on fault lines, and especially those living in LA, that they should *anticipate* having their life disrupted with unpleasant surprises. The reality is that those living in danger zones already are aware of their danger. Volcanoes erupt, but usually rumble their way into the news well beforehand. Fault lines are quake prone, and quakes strike like lightning, unpredictably. High tides roar in along coast lines, only occasionally after an alert has been issued. Where cities have been built near active volcanoes, they do not survive atop them. After the pole shift, when *all* volcanoes active or recently dormant should be presumed to explode, life atop or downwind from volcanoes will be impossible. Fumes, lead heavy ash, and gloom will prevail.

What is missing from these single thread movies, depicting disaster akin to the coming pole shift? It is the net, the web, of problems, happening *all at once*. Communications are invariably intact in these movies, but in *reality*, phone lines and satellites will be down, and all transmissions fighting interference. Communications will be dead. A stalwart military plods along like Boy Scouts, full of idealistic resolve. Collecting pay for a *job* is not the same as dedication to an ideal, and those with a strong need to control their environment, such as top commanders invariably have, are the first to crumble when this control is gone. They rage. They bark orders. The mission at hand is *not* to rescue the public, but to regain control. Where one disaster is afflicting the public in these movies, the others politely hold back. Quakes without fire storms from broken gas lines. Volcanoes without exploding factories from overheated ground. Life threatening circumstances without fight or flight in people and their pets.

In the *real* pole shift, all will hit at once. There will be no rescue, no roads or railroads supporting travel, no communications by any means, no electricity or hope of power restoration, and certainly no functioning government. Survival groups must rely on themselves, cooperatively, and be practical. The *real* pole shift is not fiction, as are the movies.



[Mail this Page](#) to a Friend.

ZetaTalk: Discovery Channel

Note: written during the Dec 14, 2002 Live ZetaTalk IRC Session.

Discovery Channel has *wanted* to produce informative programs to prepare the public, but been denied. They have been leaned on to emphasize the Sun as the cause, but resisted. They early approached Nancy on Planet X and Troubled Times type content, but this was squelched. They are doing their best with a difficult situation, like Spielberg. Depending on human hands, and which way this or that jumps, *many* dramas could ensue over the next few weeks and months.

All rights reserved: ZetaTalk@ZetaTalk.com



[Mail this Page](#) to a Friend.

ZetaTalk: Fire in the Sky

Note: written on May 15, 1996

The media portrayal of this true contactee experience did not adhere to the facts as relayed by the contactee. This is a common complaint from contactees who lose control of the process - their stories, faithfully relayed in exquisite detail, emerge from the hands of the media artists, painting an entirely different picture.

This episode was intended, by the good-hearted aliens and contactee involved, to promote the Awakening. The event involved a significant amount of missing time, witnesses to lights in the sky and the sudden disappearance of the contactee, and intense focus by the entire community on the sudden reappearance of the disheveled contactee. To that extent, matters went as planned. Thereafter, the contactee was subjected to the hostile denial that is so common as to be almost be routine in visible visitations. Where anticipated, this brutalizing of the contactee leaves its mark, and standing up in the face of this hostility is no small matter. To add insult to injury, the media presented what was essentially a healing process as a terrifying capture, confinement, and experimentation. Horror stories pack the theaters, and this is, apparently, all that mattered.

All rights reserved: ZetaTalk@ZetaTalk.com



[Mail this Page](#) to a Friend.

ZetaTalk: Stargate

Note: written on Dec 15, 1995. Planet X and the 12th Planet are one and the same.

The movie *Stargate* was a success in great part because it carried a grain of truth on many fronts, and this was intuitively recognized by those in the audience. The relationship between pyramids and human enslavement; the use of cruelty by those in the Service-to-Self as a form of control and the catalytic effect the courage of a single individual can have in the face of such a reign of terror; and the obsession those who built the Great Pyramids had with calibrating their flights into space. However, beyond these aspects, the movie had little relationship to facts, nor was this a movie sponsored by the government to aid in the Awakening.

Rapid space travel does not require a portal. This is a primitive view foisted on humans by humans who regularly walk through doors to move from one world to the next on Earth, whether this be from indoors to outdoors or from a corridor into private chambers, portals or doorways are assumed to be required by humans for the magical change that takes place. Nor are humans held in slavery elsewhere in the Universe by the hominoids from the 12th Planet or any other alien race, as such practices work against the free will that 3rd Density forming entities are to experience and are simply not allowed. This is why such arrangements in the past, during visits by the hominoids from the 12th Planet, were stopped shortly after they arose. However, both cultural and spiritual memories exist to remind humankind of such practices, however brief, in the past, and thus the genuine appeal of the movie *Stargate*.

All rights reserved: ZetaTalk@ZetaTalk.com



[Mail this Page](#) to a Friend.

ZetaTalk: ID4

Note: written on Apr 15, 1996. Planet X and the 12th Planet are one and the same.

Pseudo-fiction in movies as a tool to speed the Awakening is a tool that can be used to serve those in the Service-to-Self or Service-to-Others orientation. If *ET* and *Close Encounters* gave a warm message of friendship, and *Star Wars* a sense of hope in the battle between the forces of darkness and light, then the movie *ID4* is relaying a message of doom. In battles with those in the Service- to-Self, you will be conquered. This is the message. It is not by accident that the conquerors arrived on a traveling red world, reminiscent of the *true* traveling 12th Planet, which appears red when viewed from a distance due to the iron ore dust in its tail. It is not by accident that the inhabitants have desires to conquer the Earth, as the inhabitants of the 12th Planet have a long history of just such activity on Earth, and legends abound regarding this.

[ID4](#) is designed, by more than the producers, to make the populace uneasy, going into the forthcoming pole shift and Transformation. Who so desires this? The establishment, who wants *none* of this friendly communication with aliens to proceed. Unlike the situation depicted in the movie *ID4*, they intend for the inhabitants of the Earth to remain as *their* slaves, which indeed is how they view them.

All rights reserved: ZetaTalk@ZetaTalk.com



[Mail this Page](#) to a Friend.

ZetaTalk: When Worlds Collide

Note: written on Feb 15, 2002

Imagine the mindset of MJ12 when they encountered the Service-to-Self aliens who rushed in during the time of Roswell to form bonds with the US government before the Service-to-Other could do so. This was the defense department, the military, who are paranoid about intrusions in any case and tend to be hyper-organized and control oriented. They found the rules and regulations the Service-to-Self aliens had in place a comfort, but were uneasy. They sensed a coldness, agendas not explained. After Roswell, when the Service-to-Other made contact by crashing and injuring themselves, they concluded that aliens were not *all* competent or of the same mindset. However, in that the Service-to-Self had not crashed during an introduction, they took this group to be more competent, and having the upper hand. It took some time for the nature of the two groups to sort out in MJ12's mind, in fact long after Nancy's recent engagement where she had to explain a few matters to them.

Consequently, members of MJ12 had long talks into the night with each other on the possible scenarios. Movies such as *When Worlds Collide* reflect those anxieties. Early movies about aliens invariably presented the alien presence as technologically advanced, but cold. They presented the agenda of a takeover, something the military mind would fret about in any case. Intrusion into human society, infecting and influencing humans, and when the time was right, eliminating mankind and taking the Earth for themselves. Look back over the menu Hollywood offered, during those decades, and you see the mindset of MJ12 in the early days. Later movies, such as *ET* and *Close Encounters*, presented kindness and eager contactees. Expect more of this, as when MJ12 finally sorted it all out, they realized that a stiff arm to the alien presence plays into the Service-to-Self agenda, and set out to right their prior wrongs.

All rights reserved: ZetaTalk@ZetaTalk.com



[Mail this Page](#) to a Friend.

ZetaTalk: Signs

Note: recorded during the May 11, 2002 Live ZetaTalk IRC Session.

The message from the establishment on the meaning of crop circles is:

1. cling to your government, who will protect you,
2. be suspicious of anything alien, they are out to eat or enslave you,
3. man wins out over aliens, even with inferior technology.

Nothing new in the movie business, sad to say.

Note: below added during the August 31, 2002 Live ZetaTalk IRC Session.

Since the movie Signs generated interest and attendance, the powers that be have decided countering information was required. Not enough that Signs presented aliens, once again, as desiring to carry off and eat humans, and that humans could counter this by going mano-a-mano with aliens, hand to hand combat. *Both* silly premises. But Signs made the mistake of actually informing the public at large that crop circles, genuine circles, had a quality that humans could *not* perpetrate - bend but not broken grain. To the horror of the elite, who want the human populace to only cling to *them*, and to fear and push away the alien presence, the public went to see this movie in droves, and commented among themselves about the validity of crop circles being alien. Thus, two phenomena emerged, shortly after the premiere.

1. 1. fake crop circles, reasonably well done, emerged, which could be claimed later to be fakes, which they *are*.
2. 2. books and supposed experts emerged confusing the issue, claiming that fakes are real, real are fakes, and the like.

The real focus should be on those characteristics which *cannot* be faked, such as the bent but not broken grain, then continues to grow! Is this being placed as the defining characteristic? Not at *all*, and thus is proof of the disinformation characteristic of the current crop circle blitz.

All rights reserved: ZetaTalk@ZetaTalk.com



[Mail this Page](#) to a Friend.

ZetaTalk: War of the Worlds

written July 6, 2005

Would the Zetas care to comment on the new movie adaptation of H. G. Wells' novel, "War of the Worlds"? The movie is directed by Steven Spielberg, whom the Zetas have spoken about in the past and whose previous works of science fiction have depicted a benign alien presence. Is there a purpose behind this latest presentation of a hostile alien threat?

As we mentioned on a previous work by Spielberg, the TV series [Taken](#), Spielberg is adept at delivering the correct message, the truth, even when struggling with the imposition of government censorship where the only message about aliens allowed is that they cannot be trusted, are here to enslave mankind, but the government can be trusted to be truthful and protective. A remake of the War of the Worlds, a known story line, got easy approval. While sticking to the story line, what hidden messages for mankind did Spielberg manage to deliver? Remove the arrival of vicious blood sucking aliens as the source of panic and replace this with the days of horror during the pole shift. What is the reaction of the populace?

- At first stunned disbelief, the public failing to take action, failing to see the need to move to safety or even understanding what steps to be taken, as they do not *understand* what is occurring. We have stated that going into the pole shift, *most* of the worlds populace will have no idea what is about to occur, due to the cover-up.
- Conveniently, in the movie, all electrical devices, including cars, fail to operate so the populace stays in the dark, incommunicado. We have stated that during the week of rotation stoppage, when the countdown to the pole shift is a matter of days, that travel will be impossible unless by foot.
- Mass migrations begin to occur, everyone assuming there is a safe location someplace ahead, spared of the rampaging aliens, even when they may be walking into danger. We have stated that following the pole shift there will be endless migrations, as people someplace where life is better, though the whole world will have been affected.
- Random acts of kindness, a couple concerned about a child apparently left abandoned, play in counterpoint with mob panic, where hundreds of refugees on the road are each trying to take control of a single running vehicle, murder and mayhem all around. We have stated that survivors of the coming pole shift must plan on being in small groups, and away from heavy traffic lanes.
- Insanity, even in those who are seemingly prepared to survive, stocked up and bunkered down, with weapons, is depicted. In the man gone insane, his weapons is in essence used against him, as it would give away his position, certain death. We have stated that insanity will be rampant after the pole shift, and guns cannot be assumed to remain in the hands of sober men, as the head of the family himself may be the first to slip into insanity.

Thus, the message that Nancy hoped to deliver with her production of [The Passage](#) is being delivered instead by Spielberg, as there are many angels at work and many routes to a goal.



[Mail this Page](#) to a Friend.

ZetaTalk: Theosophists

Note: written on Jul 15, 1995

Past Theosophist writings had valid insights, but were not from a channel. Their accuracy came from knowledge the entity brought with it into the incarnation. The early Theosophists were Star Children, whose mission was education of mankind. The Theosophists, being ahead of their time in the concerns they addressed and too intellectual for the masses, were ignored by the establishment, which did not see in them a threat. Thus their message has not been undermined in the same manner as the message of Jesus, for instance, who spoke plainly to the masses and challenged the establishment directly and repeatedly.

Is the Theosophist message true, to be taken literally? As with all writings, the reader's slant can be inserted. Where the Council of Worlds corrected the environment on Earth here and there, so that the 3rd Density condition could proceed as intended, a racist slant can be interjected by the reader. Where alien groups, also in 3rd Density, such as the visitors from the 12th Planet, were unduly influencing the Earth, they were not infrequently removed in concert with one of the periodic cataclysms. Land masses go under the waves, and rise up from the depths during each cataclysm. Where a group of humans formerly under the influence of the inhabitants of the 12th Planet went under the waves, the legend of Atlantis was born.

The Theosophists, speaking to humans in a language they could understand, inculcated their legends. One uses what is at hand, when trying to communicate and bridge vast communication gaps. The early Theosophists should be read not literally, but as though reading poetry, mythology, thus letting the underlying meaning soak in. This, in its totality, will convey the message intended by the Theosophists, who were telling true history, and relaying the true plans in place for the Earth.

All rights reserved: ZetaTalk@ZetaTalk.com



[Mail this Page](#) to a Friend.

ZetaTalk: Seth

Note: written on May 15, 1996

The channeled material from an entity known as Seth is in the main valid, but here and there the channel was imperfect. Where the entity relayed that time was but a factor, and could be adjusted so that travel into the past or future is possible, the channel misconstrued. In explaining how time travel for and aft could place one in three places at once, the entity Seth so entranced its channel with this concept of a possible parallel existence that the rarity of such a situation got lost. If an entity lived a thousand incarnated lifetimes, the average percentage of time in parallel time threads would be but a thousands of a second - insignificant. However, we highly recommend the Seth channeled material, if properly read for the overall impression as all channeled work should be.

All rights reserved: ZetaTalk@ZetaTalk.com



[Mail this Page](#) to a Friend.

ZetaTalk: Urantia Book

Note: written on Aug 15, 1995

The *Urantia Book* is fiction, but like many books that are not based on fact, the message should not be negated or discarded. Fiction is, more often than not, the tool used to relay a message. Children learn extensively about relationships, the rewards and risks of adventure, the ultimate rewards of kindness, the ultimate outcome of selfishness - all through fiction. Personal lives seldom have the scope of lives in fiction. Time passes from beginning to end during the reader or listeners rapt attention span, allowing the lesson to be understood and not scattered by distraction. Fiction is thus often times a better story than the truth. Often a story can be relayed or accepted better if the listener is not sure of the outcome. Fiction can be woven in a way where more information is relayed than a simple fact based story can tell. Those who wrote the *Urantia Book* knew this and their important message should not be dismissed due to the shape of the package.

Take, for instance, the lessons relayed in the fictional series *Star Wars*. Does not Yoda, grumpy and disheveled and living in humble quarters, not exemplify many characteristics of a Service-to-Other individual? He has quirks, is reluctant, and people can relate. He also has a key role in a crucial battle between Good and Evil, and ultimately has this satisfaction. So it is often, in the Service-to-Other orientation. How could real life have stated this more effectively? The essential battle that takes place in 3rd Density entities, which is their orientation decision to either work with others and be empathetic or to go for the self, is very well relayed. The *Urantia Book* is such a story, very expertly woven and influenced without a doubt by many entities who wished to see this story told. Read it and appreciate it, and do not consider it a fabrication but rather an artistic description of the facts.

All rights reserved: ZetaTalk@ZetaTalk.com



[Mail this Page](#) to a Friend.

ZetaTalk: Akashic Record

Note: written on Sep 15, 1995

The Akashic Records and the book, *Keepers of the Garden*, are fiction, incorporating bits of this and that such as various messages contactees have relayed, science fiction staples, human hopes, and themes from the Bible. All very entertaining but without any basis in fact whatsoever. Phil, the main character, does not exist, nor does the Council of Worlds channel through humans as implied in this book, nor is the Council composed of 12 or even any set number, nor are the Zetas developing a hybrid race to populate a planet other than Earth. Fiction. All of it.

All rights reserved: ZetaTalk@ZetaTalk.com



[Mail this Page](#) to a Friend.

ZetaTalk: Clare Prophet

Note: written on Jun 15, 1996. Planet X and the 12th Planet are one and the same.

Among the marks left by the giant hominoids from the 12th Planet are myths of their genetic heritage. They used human females as sex slaves freely, wherever they resided on Earth, and of course at times spawned offspring. Unless the woman had broad hips, she was highly likely to die in childbirth or during pregnancy. The visitors from the 12th Planet knew this, and almost routinely gave their sex slaves an abortive medicine to prevent those messy deaths. However, at times a sex slave escaped or a casual encounter resulted in a pregnancy, and a living child resulted. All genetics tend to blend, so this resulted only in somewhat larger humans, a trait which has lost its meaning as all human races have increased in stature over time due to selective breeding. Elizabeth Clare Prophet thought the Jews a select race bearing more of these genetics than others, a claim based not on fact but on her respect for the accomplishments of the Jews.

All rights reserved: ZetaTalk@ZetaTalk.com



[Mail this Page](#) to a Friend.

ZetaTalk: Baird Spalding

Note: written on Mar 15, 2002

Baird Spalding like many strongly in the Service-to-Other orientation has developed a reputation. This is not so much due to acts or predictions, but the simple impact that a strongly Service-to-Other lifestyle and entity can have. Like Jesus, who left *all* who heard him speak or watched him in action impressed deeply, Spalding speaks not so much through words as by actions, the true test of orientation. Spalding like many who wished a message to remain with those who heard it took liberties. The *Star Wars* series is fiction, but speaks greatly to the true interaction between Service-to-Self and Service-to-Other, and the contests mankind finds himself in almost daily. The *Urantia Book* likewise is fiction, but beloved by many for the picture it paints. Fiction, or pseudo-fiction, often has an impact greater than the truth, and is not considered a sin in higher realms if the mission is accomplished.

All rights reserved: ZetaTalk@ZetaTalk.com



[Mail this Page](#) to a Friend.

ZetaTalk: Sylvia Browne

Note: written during the Dec 21, 2002 Live ZetaTalk IRC Session.

After for many years denying such a possibility, this week celebrity psychic Sylvia Browne announced on the Art Bell show that she now sees a worldwide natural cataclysm in the future, and the disappearance of mankind within 5 years.

Pole Shift Discussion Group

We have mentioned that many aliens channeling, to valid channels, are reluctant to announce the coming cataclysms. We have explained that this is due to:

1. not wanting to be the bearer of bad tidings,
2. not having a human willing to be the bearer of bad tidings.

Those alien groups pulling back from a full truthful account of what mankind will experience have several reasons for doing this. First, as with any relaying of discomfiting news, the news bearer is *also* discomfited. So, the news bearer would prefer *not* to experience this discomfit, call it cowardice or pandering to the self or a weakness. Second, there are those who feel that the news would be delivered to many who could *not* do anything with the news, could not move, prepare, and the agony would only be thus prolonged. This is akin to a doctor not telling a patient that they are dying until the dying day. In this case also, the doctor, the news bearer, is excusing themselves from discomfiting demands by the patient of family. Can the patient not be cured in some way, has the doctor done all he can, etc. In like manner, aliens presenting a pole shift scenario are asked, via their channels, endlessly, if all of mankind cannot be saved, lifted, the shift avoided, etc. Those aliens groups presenting a rosy, or glossed over view, will explain the facts to those who they deem will be able to take it well, or deem could benefit from such facts.

Both factors, the channel and the human, are at play, so that one must have:

1. an alien information source willing to tell the horrid truth,
2. a human willing to be the bearer of this.

To date, none but Nancy has filled these shoes, but times are changing for several reasons. Where information sources have alluded to coming changes, they focus on the aftertime as being a better time, *not* the steps that will occur to get there. Earth changes are described in light text, heavy on the emphasis of glowing times afterwards: peace, cooperation, the return of Christ, or whatever. If the cataclysms are at all described, they are put into short phrases, such as "much death", without details. To state which areas of the world will experience tidal waves, which will quickly drown, which will freeze, which will choke on ash, and the like is too graphic. Readers of light text can imagine that *others* will experience *something*, but not themselves. This leaves the shift and its effect as theoretical, abstract. What has occurred that some sources are now leaning in the direction of addressing the coming times? In truth, for every source that moves closer to telling the truth, there are others who back away!

The earth changes are pressing in on all consciousness, undeniable, and thus the comfort of denial is increasingly hard to achieve. Those attuned to other voices have a choice, to shut it all out or *listen*, and if they chose to stay in contact will have to admit that *something* is around the corner. Like Scallion, who deals with this pain in this regard and taps in, or like Cayce, who likewise reported the unpleasant, some will be true channels for the truth. But likewise, some otherwise true channels will be increasingly flaky, vague, ethereal, and deny any rough times in the near future. Consider, when listening to these many voices, that a *human* is relaying this information, and place this in the context of what you know human behavior to *be*. How many of your fellows can take really bad news without trying first to deny it? Consider second that alien groups relaying information to humans may likewise prefer to save the really bad

news until the last minute. We ask only that those looking for the truth consider the ZetaTalk accuracy track record, which is impressive to the point of standing alone in information received from a source outside of the human vehicle relaying it. There is *no* other channel or source with this track record.

All rights reserved: ZetaTalk@ZetaTalk.com



[Mail this Page](#) to a Friend.

ZetaTalk: Ramtha

Note: written on Mar 15, 2002

The entity claiming to be Ramtha, speaking through a channel, is widely viewed as a *male* entity, and for good reason. This is not via a channel, but from a male associate of the channel, a woman. Why the deception? In the world of man, it is *males* who have influence, but females who are allowed broad scope in what they report, in that they are assumed to be illogical and emotional. This in conjunction with the stage presence and appearance and confidence of the individual who would be the public front, determined which of the pair would go on stage. The male contactee determines the content of the Ramtha messages, but the newscaster is a woman claiming to be a channel. This contactee is arrogant and in contact with Service-to-Self entities as was Tesla. He received information and projections allowing him to have a substantial track record on predictions, in order for the Ramtha message to gather a large following, which it did. As with the Service-to-Self aliens giving the original MJ12 group ships, supposedly to allow them to secure the technology, this was a false promise. MJ12 never secured any technology, as dissecting the ships energy source or navigation devices caused explosions. But the myths of a technology exchange for access to American citizens exists today. Thus, Ramtha, after establishing his initial reputé, was no longer given information, as he was considered cutting lose from his bonds by his controllers. Frustrated in increasing his scope, he turned to petty control games, revealing his true orientation in these later days.

All rights reserved: ZetaTalk@ZetaTalk.com



[Mail this Page](#) to a Friend.

ZetaTalk: Barbara Marciniak

Note: written on Feb 15, 1996

Many channelers purport to be relaying information from the Pleadians, far out of proportion to the Pleadian influence on Earth at this time. The reason for this choice, among the many channelers who are faking it, is that the Pleadians are gentle speaking, not blunt, and focus on feel-good messages. It's all rather like the preamble to a sermon, without ever arriving at the sermon. It's like attending lectures without ever having to take an exam. The Pleadians don't relay messages that make humans uncomfortable, that's not their chosen role. They're greeters, the nice guys, easing humans into the concept of an alien presence with pleasantries. Consequently, those who claim to be channeling Pleadians don't get challenged to prove it, as no one is uncomfortable.

The drawback to the plethora of false channelers is the plethora of inaccuracies that follow. Barbara Marciniak claims to channel the Pleadians - she doesn't. She claims an ancient civilization lives in Antarctica - none does. She claims entities called Game Masters create civilizations - they don't. This is not to say that everything she might write would be a falsehood, it's just that it couldn't be trusted.

All rights reserved: ZetaTalk@ZetaTalk.com



[Mail this Page](#) to a Friend.

ZetaTalk: Alexander

Note: written on Apr 15, 1996

Channeling in and of itself has an impact on the human allowing themselves to be a channel. They allow themselves to be used as an instrument, as a violin or piano is used by the conductor and musician to relay a composers work to the audience. Many hands play the violin or piano, in effect, but all have more control over the process than the instrument itself, or so it would seem. Yet if the piano is not tuned, it leaves its mark on what the audience hears, and if the violin can't sustain a rich and resonant sound, the audience misses what the composer intended. The instrument matters. When reading channeled material, the reader should bear this in mind, and look for the slant that may be there, the persistent theme that seems out of keeping with the bulk of the content. The work channeled for Alexander carries such a mark, though the channeler Alexander would say otherwise. If a channeled work seems to be in conflict with itself, then look to the channel, as perhaps the instrument is flawed.

All rights reserved: ZetaTalk@ZetaTalk.com



[Mail this Page](#) to a Friend.

ZetaTalk: Sheldon Nidle

Note: written on Dec 15, 1996

This author became known for purporting a theory about the Earth's eminent entry into what he called the Photon Belt. Where this theory was being purported with the best of intentions, and was indeed the result of true channeled information from aliens in the Service-to-Other, the message was garbled for several reasons, as we have explained. When the date came and went and no Photon Belt passage occurred, the author fell from grace with a thud - no more worldwide attention, no more book sales, and no more personal inquiries. This type of experience is stressful for anyone, and it is not uncommon for those who have recently been in the limelight, and *enjoying* this, to attempt to regain the glory they so recently took for granted. Thus, there have been embarrassingly silly pronouncements from this author since the Photon Belt failed to materialize, none of which are taken very seriously by the public.

All rights reserved: ZetaTalk@ZetaTalk.com



[Mail this Page](#) to a Friend.

ZetaTalk: Barbara Clow

Note: written on Jun 15, 1999

Barbara Clow is a valid channel, and no more off than other valid channels. Indeed, without understanding the *reasons* for what she was relaying, she has kept the message quite pure. Many channels wish to package their message in a manner that they themselves can understand. If it doesn't make sense to them, then they package it differently, the human inserting themselves as editors during the channeling process. Barbara Clow has done better than most in this regard.

All rights reserved: ZetaTalk@ZetaTalk.com



[Mail this Page](#) to a Friend.

ZetaTalk: Lysa Royal

Note: written by Jul 15, 1995

The Royal channel book series is excellent, and contains a close representation of the information channeled through them. We would caution not to take all statements literally, as in an attempt to communicate our and our brethren's meaning such that all men can understand, the language may be flowery. Read more for the underlying meaning than for the literal interpretations. Listen with your heart. The channel, Lysa, was presented with one of our hybrids to gain an understanding of how this hominoid fits into the whole. In understanding that this hominoid will be the intelligent life form on Earth *in the future*, she assumed he was *from* the future. When meeting someone from another culture humans assume there will be some concepts one party holds that the other will have difficulty with. Likewise when chatting with someone who speaks in a different language, translation difficulties are expected, where word nuances enter in and can change the meaning. Channeled work relayed from an alien race to a human should always be read for the overall impression, and given at least the same latitude for communication difficulties that humans give to one another.

All rights reserved: ZetaTalk@ZetaTalk.com



[Mail this Page](#) to a Friend.

ZetaTalk: Sollog

Note: written on Sep 15, 2002

Sollog is another wanting the stage, which no one but himself want to give him. A self promoter, without any validity whatsoever, he manufactures his predictions after the fact to support his claims. Vague, unspecific, and nebulous, his postings before the fact could fit *any* scenario, which he then makes happen. He is as valid as a Chinese fortune cookie, as published Horoscopes, to the masses. *Any* of these statements would apply to *any* person, in *any* circumstance, and thus are Sollog's predictions. Does it rain today or not? Sollog predicted it, somewhere, or so he says.

All rights reserved: ZetaTalk@ZetaTalk.com



[Mail this Page](#) to a Friend.

ZetaTalk: Jelaila Starr

Note: written during the Sep 7, 2002 Live ZetaTalk IRC Session.

Jelaila Starr of the Nibiruian Council is *not* a valid contactee, nor channel, and in fact is in contact only with her imagination and greed. There is *nothing* of worth in her reports, which cannot be proven and have no basis for accuracy tabulations. Is what she says about the intentions of the hominoids on Nibiru correct? Can you ask them? Can she bring one forward to report in person? *None* of her statements can be verified, nor will she allow herself to be interviewed live, bombarded with questions ad hoc as Nancy has, from the start. She first discounted all that ZetaTalk stated, but has lately adopted the message as her own, hoping to share the stage. She will not be the last wannabe.

All rights reserved: ZetaTalk@ZetaTalk.com



[Mail this Page](#) to a Friend.

ZetaTalk: Anna Hayes

Note: written during the Sep 21, 2002 Live ZetaTalk IRC Session.

There are, in the world of the Internet and alien voices, many who would take advantage of the native fear reactions of humans. Anna Hayes, a priestess of the Service-to-Self, is one such, preaching *not* to enable mankind with information by which *they* can gage truth or falsehood, but playing on fears. She will delude and win some converts, but most will turn *from* her when the truth of our message emerges increasingly. Thus, in the end, like the claws of the Bush Administration emerging when they are denied a reason to invade Iraq, her claws will emerge when she senses she is losing, overall. This world is destined for those in the Service-to-Other, and those in the Service-to-Self who linger and snarl in the shadows will not be with mankind for long.

All rights reserved: ZetaTalk@ZetaTalk.com



[Mail this Page](#) to a Friend.

ZetaTalk: ZetaTalk Accuracy

Note: written on Dec 15, 2001

We, the Service-to-Other Zetas, are in tune with *all* humans who are thinking about us or whom we are interested in, their thoughts, as well as with Nancy. Likewise, Nancy has to do no more than *think* a request for a conference and one is in process, as both of us can converse while doing our normal daily tasks. There is no need for a physical proximity, only a syncing of the thoughts. In that there is this merging, how can the public be sure it is not *nancy* rather than ourselves, who are answering? We step back during NancyTalk, and she gives us this stage during ZetaTalk, but in between she and we converse with the normal open discourse we are very accustomed to. Nancy is not shy, nor are we, and we both are comfortable with blunt talk. So when we say we are reporting ZetaTalk to you, this is *exactly* what it is. And this is why she will sometimes correct, having put forth a word or phrase that does not carry our intent, as we *object*, when this occurs. We act as a team, with both members having their identity, but the overall goal a shared one.

All rights reserved: ZetaTalk@ZetaTalk.com