

**AT** MICROFICHE  
REFERENCE  
LIBRARY

A project of Volunteers in Asia

Traditional Suspension Bridges in Taplejung District

by Jim Rutherford, Max Leisibach, and Herbert Rice

Published by:

SATA

Available from:

Swiss Center for Appropriate Technology (SKAT)  
Varnbuelstrasse 14  
CH-9000 St. Gall  
SWITZERLAND

Reproduced by permission.

Reproduction of this microfiche document in any form is subject to the same restrictions as those of the original document.

HIS MAJESTY'S GOVERNMENT , MINISTRY OF HOME AND PANCHAYAT  
LOCAL DEVELOPMENT DEPARTMENT

SATA , SWISS ASSOCIATION FOR TECHNICAL ASSISTANCE  
AMERICAN PEACE CORPS

TRADITIONAL SUSPENSION BRIDGES  
IN TAPLEJUNG DISTRICT

TECHNICAL REPORT BY : JIM RUTHERFORD  
MAX LEISIBACH  
HERBERT RICE

KATHMANDU , DECEMBER 1978

Kathmandu, Nepal  
August 1984

## REMARKS ON THE REPORT "TRADITIONAL SUSPENSION BRIDGES IN TAPLEJUNG DISTRICT"

Since the publication nearly six years ago of the technical report "Traditional Suspension Bridges in Taplejung in Taplejung District" a considerable amount of experience has been accumulated in development of a bridge type based on ideas inspired by the report. During most of those years I have been in the employ of SATA in the field of trail bridges. These remarks outline part of that experience.

The first bridge built with the ideas from the bridges found in Taplejung District but with improvements based on engineering analysis was Thumma Bridge on the Tamar River, Taplejung District, shown in the photo below. This bridge type utilizing stone masonry towers, upper main cables and no lower cables might fittingly be called a "Taplejung-type" bridge.

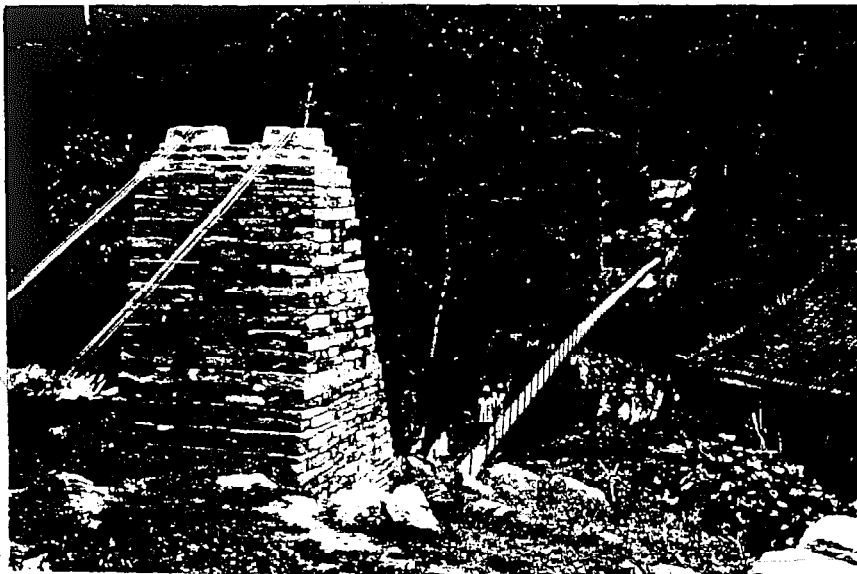

Photo 58:24

The span of the Thumma Bridge was 81 m, walkway length was 61 m and the bridge was completed in September 1979. The masonry tower shown above is 6.6 m tall measured from the base. A layer using cement was constructed every .9 m in which cement mortar was used between the cut stones forming the perimeter of the layer and concrete with very large plumbs was used to complete the rest of the layer within the cut stone perimeter. Otherwise cement was used between the cement layers. In order to cap the tower cement was used throughout the topmost layers.



Photo 58:20

The walkway of Thumma Bridge is shown at the left.

The experience of Thumma Bridge appeared to be a successful example of the application of existing local technique with engineering improvements. The construction cost was relatively low and construction time relatively short - relative, that is, to certain other centrally funded projects.

Thus, SATA was encouraged to sponsor a further program aimed at bridge building utilizing improved local technique and training local skilled workers. That program took place in Dhading District, a district partly adjacent to and west of Kathmandu Valley. Six bridges were built, two of which were of the "Taplejung-type". Three others used a short masonry tower, about 1 m height, to carry handrail cables, while the lower main cables were carried by a concrete block cast in all cases on rock. The remaining bridge used steel pipe sections for towers with walkway of the "Taplejung-type".

The first of those two "Taplejung-type" bridges in Dhading District was Kintang Bridge, shown below, with cable span of 108 m, walkway length of 82 m, and completion in June 1982. The height of the tower in the foreground was 6.5 m. However, since cement was not as expensive as in Taplejung District and the bridge budget was adequate, cement mortar was used between all the cut stones forming the outer perimeter of all layers of the masonry structure. Concreting within the outer perimeter of cut stones was at 9 m intervals, the same as at Thumma Bridge.



Photo  
88:14



The second of those two "Taplejung-type" bridges in Dhading District was Thopal Bridge, shown at the left, with cable span of 101 m, walkway length of 59 m and completion in June 1984. Due to scarcity of good stone and lower cement cost because of vehicular transport up to the site, a greater amount of cement was used in the masonry towers than at Kintang Bridge. The walkway landing in the foreground is built without cement.

Photo 101:37

During the bridge building experiences outlined above a standard profile for the masonry towers was established as shown below.

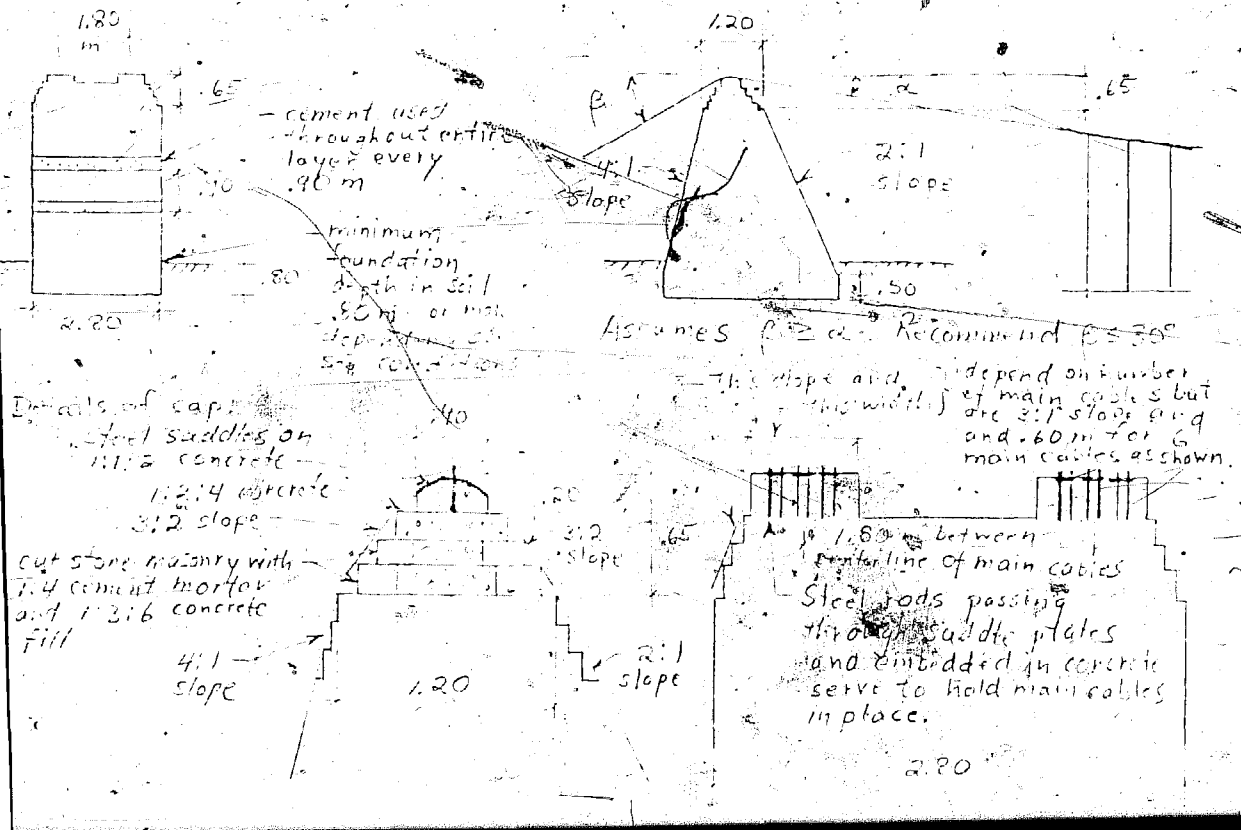

Although the highest tower built was 6.6 m, I would not hesitate to build towers 1-2 m higher if the site profile and/or size of building stones allows it. (Placement of the stones up until now has been accomplished by carrying them up a temporary ramp at the rear of the tower. Making the ramp and carrying the stones up it will become increasingly difficult depending on ground profile behind the tower and required tower height.)

Time and space do not allow detailing here of more of the various experiences of the past years. Nor is it possible here to undertake a review of the 1978 report "... Bridges in Taplejung ...", some ideas of which proved good and others of which proved not so good or remained untested.

In conclusion, I do recommend the "Taplejung-type" bridge as a desirable bridge type where site conditions are suitable. Suitability will depend on availability of stone, stone cutters and masons, site profile, transportation cost, etc.

Persons in Nepal or Switzerland really interested in the above subject might want to peruse periodic reports which I have been submitting since 1978 and which ought to be on file at SATA, Ekanta Kuna, Jawalakhel, Kathmandu, at Suspension Bridge Division, Kathmandu, at HELVETAS, Zürich, and at Direktion für Entwicklungszusammenarbeit and humanitäre Hilfe (DEH), Bern. A final report of experiences of the past years is currently in the outline stage.

In any event, I have included the above remarks here to indicate that the state of the art has progressed significantly since the 1978 Taplejung report. It would be like trying to reinvent the wheel for anyone to pick up that report and start to develop improved designs on the basis of that report alone.

*Herbert Rice*

Herbert Rice  
SATA, Nepal

## TABLE OF CONTENTS

### Report

1. Introduction
2. General Bridge Description and Technical Assessments
  - 2.1 Bridge Locations
  - 2.2 Cables
  - 2.3 Suspender Rods and Connection Details
  - 2.4 Walkway
  - 2.5 Towers and Anchors
  - 2.6 Other Components
3. Conclusion

### Glossary

### Appendix

- I Map Showing Investigated Bridge Locations
- II Basic Data for Bridges Studied
- III Calculations
  - A. Allowable Loading for Cable
  - B. Stress-Strain Incompatibility between Cable and Chain Links
  - C. Local Bulldog Grips
  - D. Walkway Design Calculations

IV Tower - Anchor Foundation Assessment

A. General Analytical Approach

B. Design Examples

C. Discussion

V Suggested Guidelines for Design Loading

A. Design Live Loads

B. Point Loads

C. Working Stress of Materials

D. Design Guidelines for Foundation

VI Method for Preparing Local Lime - "Chuna"

VII Photos and Drawings



## 1. Introduction

The Local Development Department with the assistance of the Suspension Bridge Division of Roads Department planned and executed a trip to Taplejung District in northeast Nepal to study local bridges. The trip was made by a member of SARTA and an American Peace Corps Volunteer in February, 1978. During the trip 27 bridges were studied, 24 in Taplejung and 3 in Ilam and Panchthar Districts. The bridges of Ilam and Panchthar represent a different tradition of bridge building and will not be discussed in this report. A drawing of an Ilam bridge is included in the Appendix, page B4. Another trip to study the local bridges of Ilam and Panchthar is suggested.

Interest in investigating Nepal's local style bridges was first stimulated by the bridges of Baglung District. Baglung District has a unique heritage in local bridge building different from Taplejung. The Baglung style bridge has been described in a report written during the summer of 1977. Although some technical improvements are needed in these bridges, people of Baglung District have shown much local initiative in bridge building. A "grass roots" organization has developed in the Baglung area to respond to bridge building needs. This loose organization includes local skilled workers, experienced bridge builders, and the District government. The ultimate goal in Taplejung is to establish this same local bridge building capability through technical assistance and training.

The purpose of this report is to present the general components of the Taplejung local bridges, to assess their technical merit and to discuss notable aspects of specific bridges. In the conclusion the findings of the report are summarized and recommendations for further work are presented. The Appendix gives a listing of the raw technical data, notes and photos of all the 24 bridges studied, and specific technical calculations. This report should be useful to engineers working in eastern Nepal as a guide for bridge design work and construction. Also the report will serve as the basis for a bridge manual to be used by local builders in the Taplejung area. It is proposed that a

preliminary manual be written for use in a training program in Taplejung.

Similar studies should be carried out in other areas where local bridge building technologies exist and related reports and manuals should be prepared. If technical improvements are needed they should be suggested in the report and presented in the local manual for the area studied. As in Taplejung, a training program for local builders should be executed in each area. The trained local builders hopefully will go on to build bridges in the districts in which they were trained.

The training of local builders and the writing of local manuals alone do not guarantee success for local bridge building programs. The districts involved should assess their bridge building needs and formulate a development plan. Some main trail, long span bridges should be built by SBO while at other sites a local style bridge might be appropriate. Once a district bridge building program has been developed the quantities of steel and cable required can be determined. Building of local bridges can be expedited by stock piling of steel parts and cables at the district center. Most of the steel work can be done in the field for local bridges and therefore bulk purchase of steel from suppliers such as National Trading would be advantageous. It is much easier to transport large quantities of steel and other materials one time for several bridges than to transport parts for each bridge separately.

## 2. General Bridge Description and Technical Assessments

The local approach to bridge building in Taplejung can be characterized by the following similarities found in the 23 bridges studied:

1. The main cables were above the walkway in all the bridges with a variety of sag ratios.
2. The walkways usually were built with steel flat cross members, three longitudinal stringers, and transverse planking.
3. The suspender rods were cut to length and bent by a Kami (local blacksmith) during bridge construction. Suspender rods were often secured to the cable by simply wrapping them around it.
4. The towers were of rough stone masonry construction often with wooden struts in front of the masonry.
5. The cable anchorages were generally of 2 types: hooked metal rods imbedded in bedrock or a large buried rock. The cable was wrapped around the hooked rods.

The walkway shape was often determined by the geometry of the bridge site. This flexible approach permitted the bridge to conform to the site conditions. For example the walkway might be cambered if the cables could be anchored sufficiently high above the walkway landing.

### Bridge Profile with Cambered Walkway

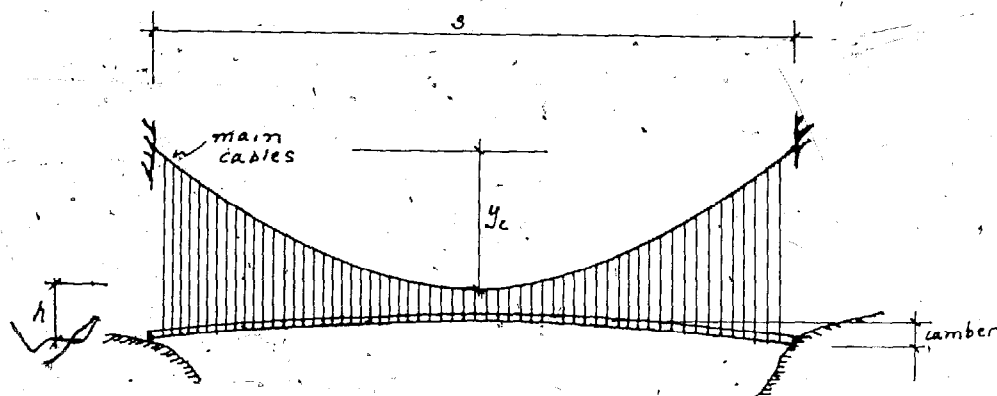

When  $h$  is large enough, a cambered walkway is possible. Often the cables cannot be easily anchored at sufficient height to permit a horizontal or cambered walkway, so a sagging walkway is necessary:

### Bridge Profile - Sagging Walkway

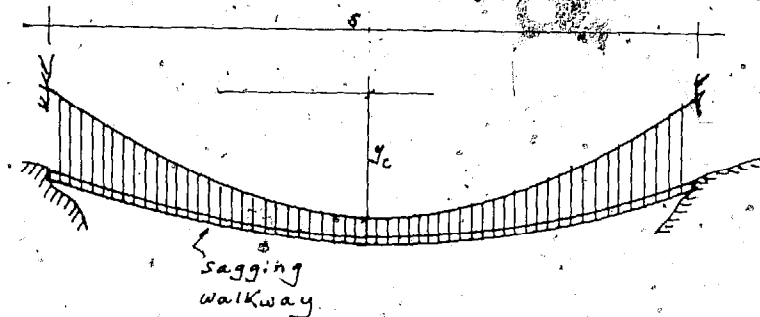

In this case the bridge has a profile similar to a suspended bridge but the cable and walkway sags are different.

In the following sub-sections the site locations, cables, suspender rods and connection details, walkways and tower anchorage are described and assessed technically.

#### 2.1 Bridge Site Locations

All of the bridges explored had rock on at least one side of the river. Rarely was the rock out for the foundation. The local builders usually selected sites with horizontal rock on one or both sides so steel rods in shear could be used to anchor the cable. In the bridge sketched below, it was not necessary to have the walkway come in below the rock ledge since a dry stone wall permitted the cable to be anchored at the same elevation as the walkway landing.

### Foundation - Walkway End Profile

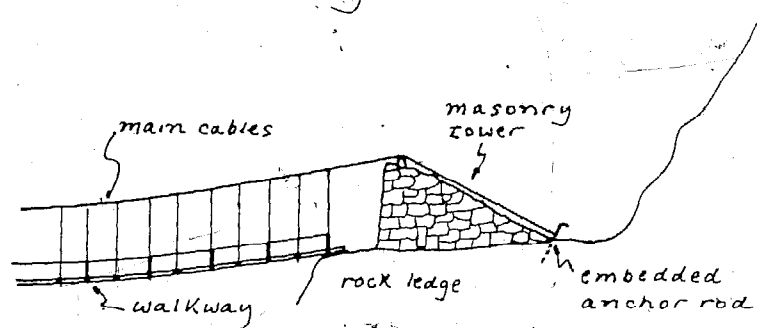

In some cases, such as the Nuwa Khola Bridge, I 5, the Foundation is located too close to an eroded bank. SBD recommends at least  $30^\circ$  from horizontal be maintained for the line between

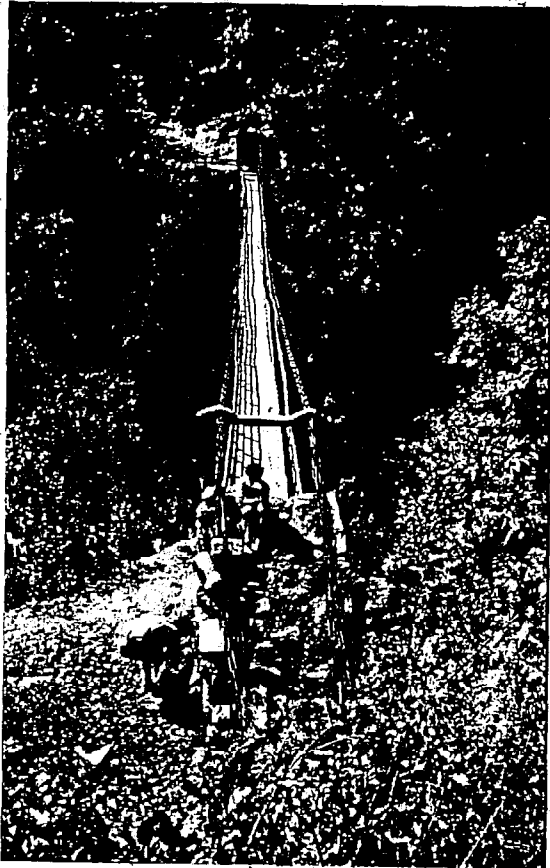

bottom of the eroded bank to the front of the Foundation. Nuwa Khola Bridge has an angle greater than  $45^\circ$ . By means of slope survey a local builder could correctly place a foundation from an eroded bank.

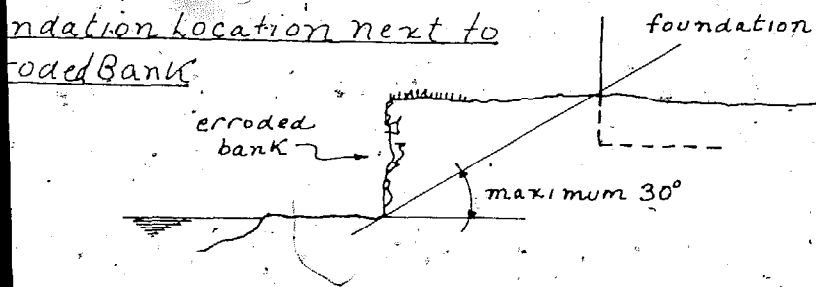

In only one case was inadequate freeboard observed and in that case the monsoon of 1977 destroyed the walkway. For the bridges.



investigated the average freeboard was 10 meters above the water level at the time of investigation in February 1978. In the 1977 monsoon at least 3 bridges were washed out along the Inwa Khola. SBO suggests maintaining 5 meters above the absolute high flood level. When a bridge spans a steep gorge more freeboard is necessary. Local builders could easily measure the freeboard before construction.

## 2.2 Cables

The average sag ratio of the bridges studied was 4.9 % and 8 out of 24 had ratios less than 4 %. In order to determine the ultimate and allowable load capacity of the bridges the span, sag ratio and

the cable area were tabulated. Then from this data the load capacity was calculated. The calculations and the results are in the Appendix, pages 42 - 45.

It was found that the allowable load capacity (the allowable load is defined as the loading at which the cable is at one third of its breaking strength) of the cables for 22 bridges was an average of 450 kg/meter\*. The allowable loading varied from 130 to 915 kg/meter. The Ampdanda Bridge, T 3, was the only bridge which is considered unsafe under heavy traffic due to high cable tension.

A higher allowable loading could be obtained for many of the bridges studied if the sag ratios were increased. The cable should be permitted to sag to the walkway handrail in order to maximize the sag ratio. The Sisne Kholā Bridge, T 6, could have



asily been built with more sag since the cable low point is over meter higher than the handrail high point. Local builders often pull cables as tight as they can regardless of the resulting small sag ratio. The sag ratio could be set by a local builder to within inches to a foot with an Abney Handlevel or similar instrument. As was pointed out above, the walkway shape is flexible and can usually accommodate a higher sag ratio while maintaining the same walkway landing points.

This load includes the dead load of the bridge.

In two of the bridges studied cables were used in parallel with chain links. This practice leads to stress and strain incompatibility since the cable is much more flexible than the steel chain in tension and the links fail at less strain than the cable. It was computed for bridge T 2 that, when the chain links fail, the cable stress is only 26 % of its ultimate. It is clear that if chain link bridges have additional parallel cables, the cables are only minimally effective. In the Appendix, pages 46 - 47, the stress - strain compatibility calculations are shown for bridge T 2.

Structural damage to cables was often observed. Local builders tend to treat cable as they would a flexible rope, tying it in knots and wrapping it around small diameter rods.





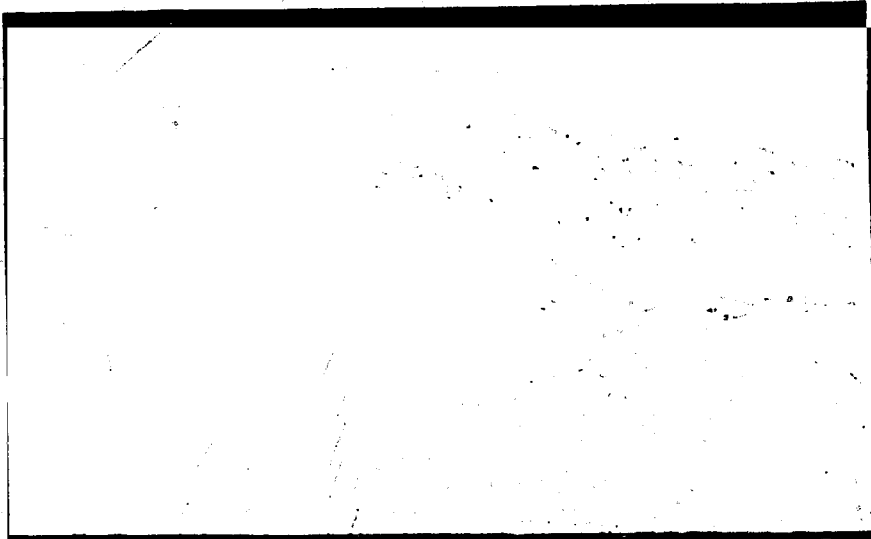
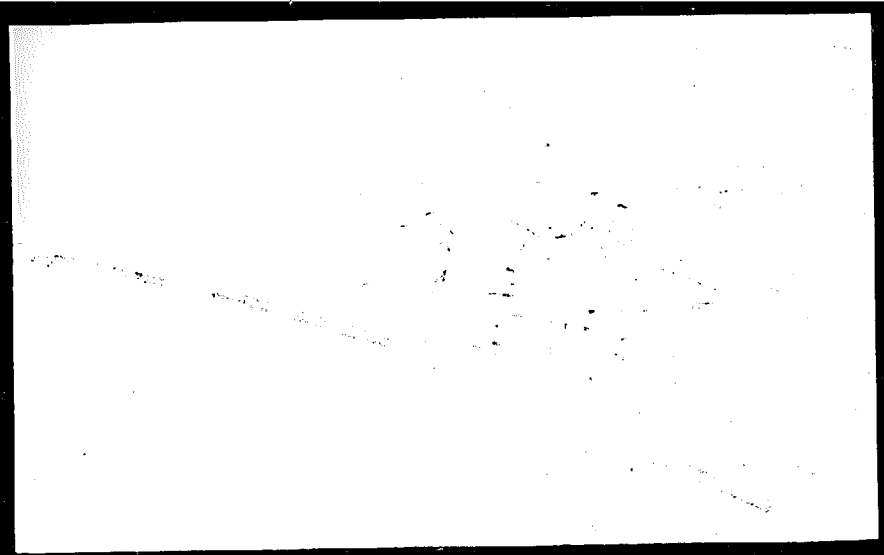
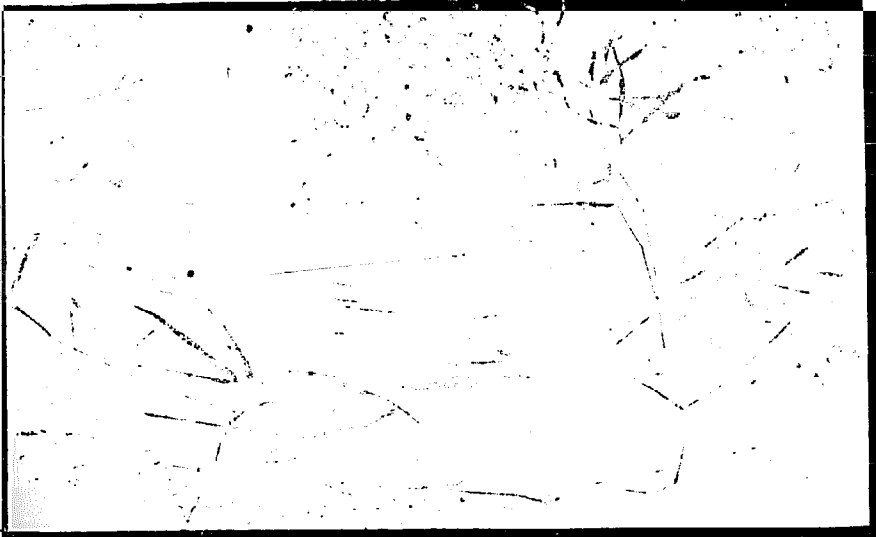

The reduction in strength for structurally damaged cables varies and is difficult to determine without testing. Common local methods for joining cables, such as a square knot with clamps on both sides of the knot, could conceivably develop full strength of the cable but a testing program must be carried out to determine this.

Local bulldog grips are neither well made nor used in sufficient numbers. There are basically 2 types of local grips in use in Taplejung. One type utilizes 2 plates bolted together. It was computed that, if four  $\frac{1}{2}$ " bolts were used and if a coefficient of friction of .1 is assumed, such a local grip can develop 302 kg resistance. To develop the full load capacity of a 19 mm haulage cable 54 grips would be necessary. If the plates were grooved the coefficient of friction could be increased. Mechanical interlock due to cable deformation may also contribute significantly to the capacity of a local grip. See Appendix, page 47.

Local cable grip:

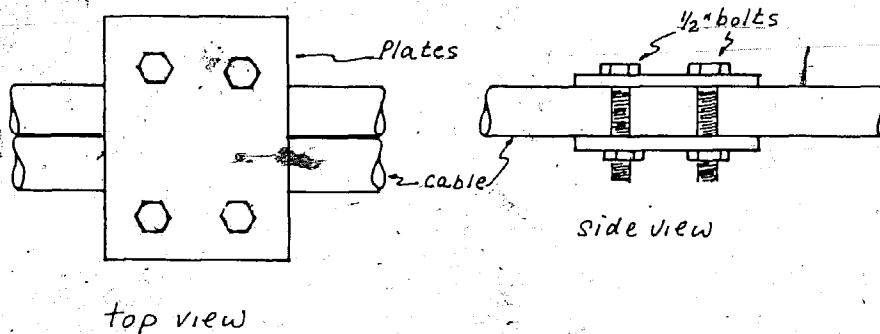

The other type of grip used locally is placed by a Kami while red hot. There are 2 variations which were observed: bent flats with holes and metal clips, and wire strand wrapped around the cables. Both variations are shown in the photos above. Only by conducting a test program with local grips can the resistance be accurately determined. A testing program should include the both types of grip since the coefficient of friction is uncertain.

It was noted that if fabricated bulldog grips were used they were usually backwards and/or too closely spaced. A policy of supplying standard bulldog grips with cables sent to the districts should be instituted and local builders should be shown how to use the grips properly.

### 2.3 Suspender Rods and Connection Details

The common approach found for connection of rods to the cable was simply to wrap the rod around the cable while hot. The rod diameters were normally 8 mm so that when heated they were highly malleable. When the main cables had a high sag ratio, suspender rod slippage was often observed. Three different approaches were observed to prevent sliding besides simply tightly wrapping the suspender rod initially. On several bridges slippage was prevented by inserting a nail into the strands of the cable. This method, although effective, could cause structural damage to the cable. Another approach was to wire suspender rods onto the steep part of the cable. This approach worked well as long as the wire



was carefully wrapped so as to develop good frictional resistance. On one of the bridges studied hose clamps were attached below the suspender rod connections. No slippage was observed on this bridge at suspender - cable connections. Hose clamps are a good

alternative, since they cause no structural damage to the cable and are easy to attach and adjust; although rust may be a problem after a few years.

A simple suspender rod - cable connector could be fabricated and provided to the district for local builders. This connector might consist of a flat with 3 holes spaced such that when bent around the cable, 2 holes align for a bolt, while the third is used to attach the suspender rod. A second cable could be attached simply with another U-shaped flat with bolt holes.

### Cable - Suspender Connector:

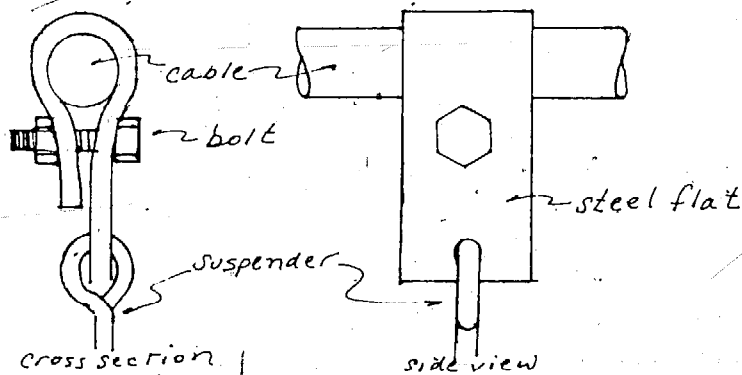

In the Mewa Khola Bridge, I 6 threaded eye hooks were used to connect the suspender rods to the angle supports, thus permitting suspender rod adjustment. For a bridge in Ilam District a similar scheme was used but in that case a long bolt was bent by Kami to permit connection of the suspender rod. This method eliminates the need for a fabricator to produce threaded eye hooks. Long bolts are available in a variety of lengths and diameters. Adjustability in suspender rods is desirable so that they can be tightened evenly as one of the final steps in erection of the bridge.

### Adjustable Suspender Connectors

Eye Hook:

Bent Carriage Bolt:

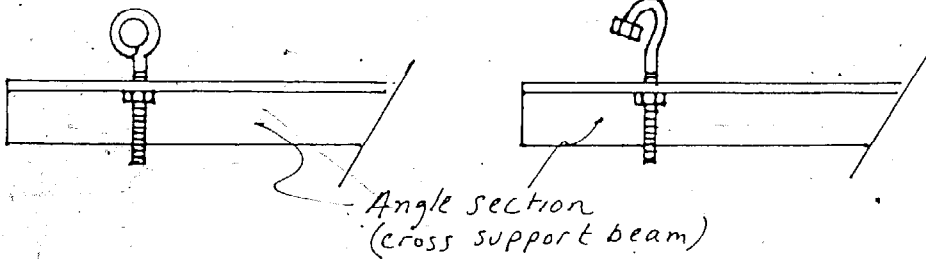

Most of the bridges studied used a standard walkway with flat cross supports which were often extended to the height of the handrail and then attached to the suspender rods. A variation on this scheme could be easily adopted for the suspended type bridge where the suspender rods are equal length. The flat, instead of being attached to the suspender could be directly attached to the cable. The flat could be hooked at the ends with holes so a bolt could clamp it to the cable. Other holes in the flat would permit fencing to be simply woven in and out the flats. Steel flats used as suspender rods would stiffen the walkway and provide a cheap alternative to fencing.

Suspended Bridge with Steel Flat Suspenders:

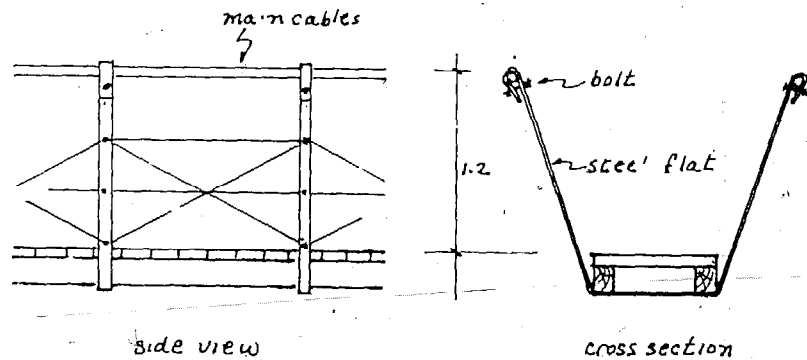

There are many alternatives for suspender rods and connections which have been observed on the local bridges studied. If builders are aware of these alternatives, they can creatively apply them to specific bridges.

2.4 Walkway

The bridges of Taplejung had a distinctive walkway system which incorporates steel flats, 2 or 3 longitudinal stringers and transverse planking. The steel flats were usually of 2 lengths with short and long one alternately attached down the walkway. The long flats served as a support for the fencing wires. The fencing usually consisted of wire and/or rod running longitudinally through holes in the flats.

Barudin Bridge Walkway

- 17 -

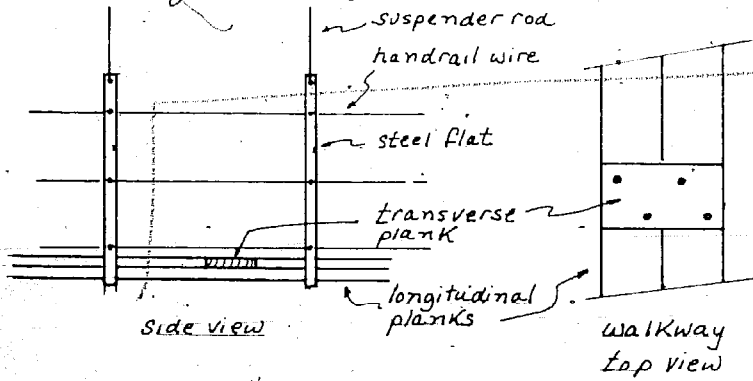

Lumbini Bridge Walkway

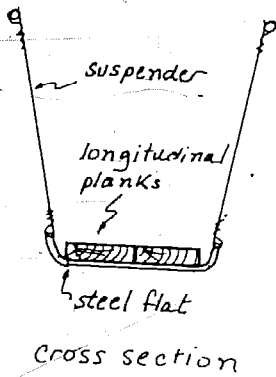

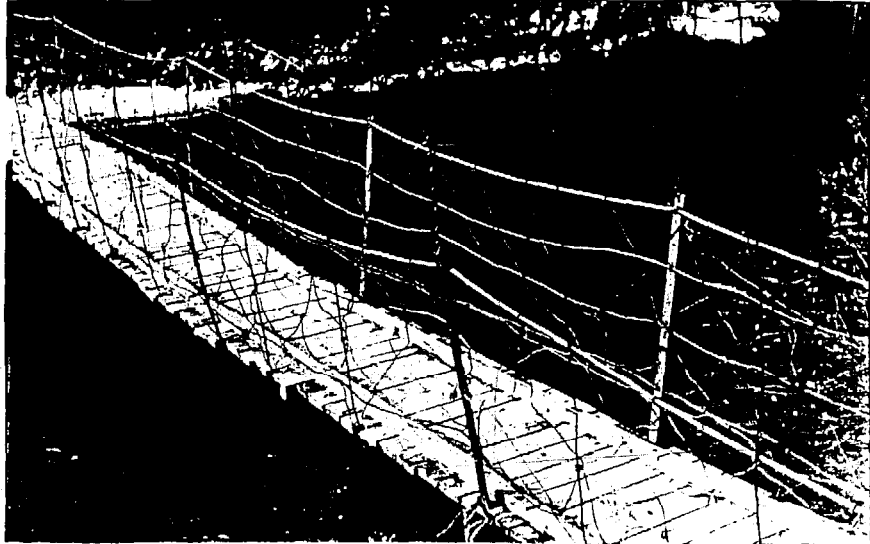

Good strength was observed when the stringers, flats and planking were tightly clamped together. A significant loss in strength occurred when these 3 components were not well clamped. The middle stringer, when used, caused bending in the flat and was ineffective in supporting the planking if the system was loosely clamped together.

Several bridges were studied that had a different walkway scheme. The Mewa Khola Bridge, I 6, had a walkway with angle cross beams, 3 longitudinal stringers and transverse planking. The good stiffness of the bridge was due to a well built wooden handrail system. A drawing of this walkway is shown in the Appendix VII.

It was noted that bridges with wooden handrails often were in poor condition since the wood was exposed and subject to rotting. Wooden handrails running the length of the bridge improved the stiffness of a walkway but often had poor durability. The standard metal handrail system is more durable.

The Barudin Bridge, K 3, had a narrow but stiff walkway composed of 2 layers of longitudinal planking with metal flat cross supports. Independent movement of the planks was prevented by transverse planks placed between the ends of the top layer of planking. Flats should have been secured with bolts through the planking but were

The Lumbini Bridge, T 2, with a span of 100 meters had a very unstable walkway. Two longitudinal planks were placed on steel flats with no fastening system. Although the longitudinal planking was joined with transverse planks, the walkway had very bad lateral stability and was dangerous. Also the flats were often bent since they had to take a high loading. This type of walkway should be avoided in future local bridges, especially over such long spans.

A good repair of the standard walkway was observed on the Phawa Khola Bridge in Dumriche Panchayat, Bridge P 1. The walkway was composed of flat cross supports, 3 longitudinal stringers, transverse beams at 30 cm and longitudinal planking. The transverse beams were actually the old planking before repair of the walkway. Although the bridge was in poor repair and the wood in the walkway was rotting, the bridge had good stability.

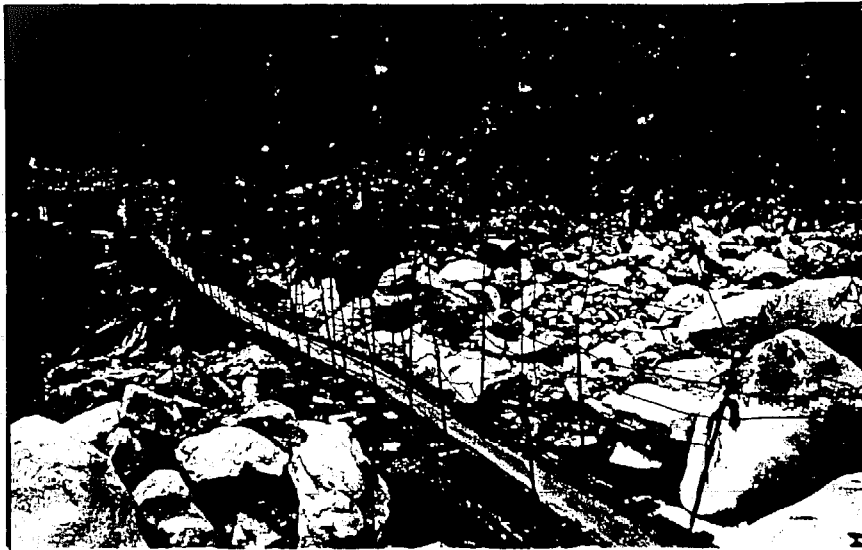

• The standard walkway system with flat cross supports and longitudinal stringers can have good structural integrity if the members are properly proportioned and the system acts as composite beam with the flats in tension and the plank above each flat in compression. This composite beam action only occurs if the system is securely clamped together with bolts. Two examples of Table-jung style walkways have been designed with properly proportioned components, one design with 2 longitudinal stringers and one with 3 longitudinal stringers. Preliminary calculations are shown in



### Three Stringer (Beam) Walkway Two Stringer Walkway

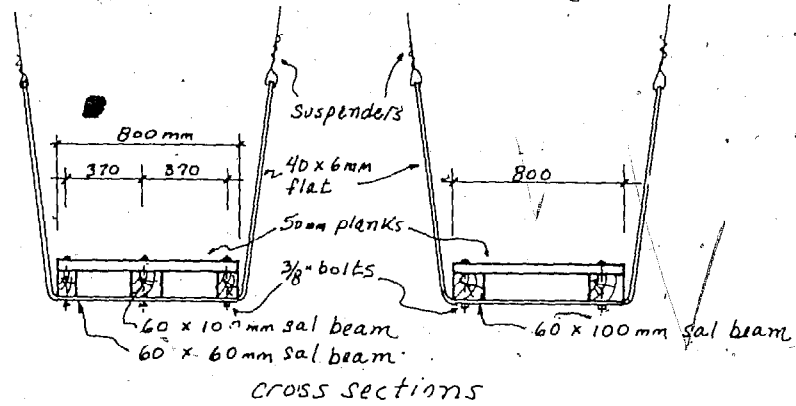

the Appendix, page 47. The advantage of the 3 stringer design is that, when the planking begins to wear or rot but, the bridge can be crossed more safely than with only 2 stringers. But this 'advantage' in the 3 stringer design is also a disadvantage in that, if the planking wears out or the clamping bolts come loose, the middle stringer produces a high moment in the steel flat, causing it to yield and perhaps break. This problem outweighs the advantages of the 3 stringer design. With 2 stringers at the edges of the flat the moment in the steel flat is minimized. It is advisable to place the stringers as close as possible to the bend in the flat. An example of 'hybrid' walkway has been designed incorporating components of several walkway systems seen in Taplejung, Ilam and Panchthar. This system utilizes angle cross supports, 2 or 3 longitudinal stringers and transverse planking. Steel flats are fastened to the ends of the angles with bolts and as in the standard local walkways the flats support the

### Hybrid Walkway

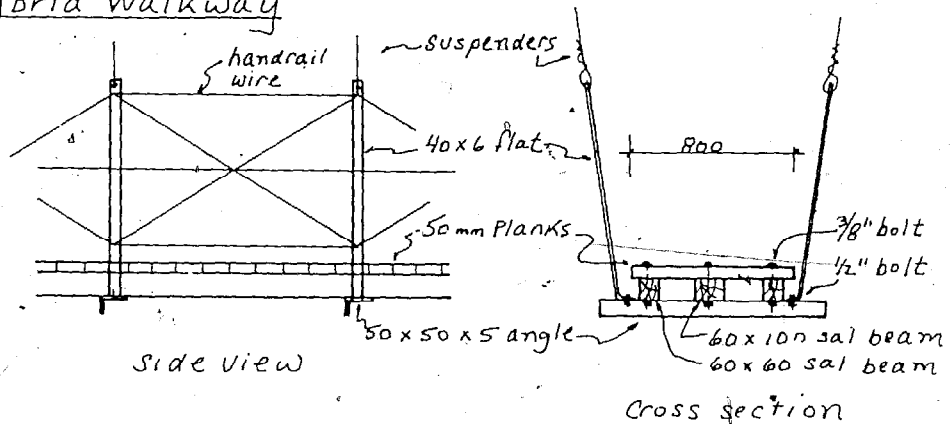

fencing wire and the handrail steel. Even if the bolts connecting the stringers loosen, the angles will not yield, since they are designed for the resulting load. Since the angle cross supports remain structurally sound, the walkway can be replaced without need to replace damaged cross supports. Although this walkway is more expensive initially, it should be cost effective because of its superior durability. The design calculations for the walkway are shown in the Appendix, pages 51 - 52.

A problem noted in most of the bridges studied was rotting of the longitudinal stringers at the walkway landings. Usually the stringers are extended beyond the end of the walkway and rocks and soil are placed on top of them to prevent vertical and torsional oscillations. Evidently moisture in the soil and under the rocks speed rotting of the wooden parts at the end of the walkway. If the end stringers rot out, the walkway loses much of its stability. There are many possible solutions which could prevent or retard this rotting. Three solutions are suggested here:

1. Increase the width of the stringers for the last 2 panels and paint them with bituminous paint or tar.
2. Use 75 x 40 channel sections on the last 2 panel sections and extend them under the rocks. Protection of the channels against rust with paint would be advisable.
3. Use 75 x 40 channels as above but imbed them in concrete at the ends. Thin metal sheeting could be loosely wrapped around the channels before placing the concrete so that, after the concrete set, the channels could move, permitting longitudinal expansion of the walkway. To minimize the concrete the channels should be independently imbedded. The connection of the channels to the wooden stringers could be accomplished in several ways. The stringers could be cut to fit inside the channel and then bolted through the flanges of the channel. Another simpler solution would be to have the channels run parallel inside the wood stringers which rest on the next to last cross support. The channels could be bolted to the cross support inside the wooden stringers. See drawing next page.

### Walkway Stringer End Connection

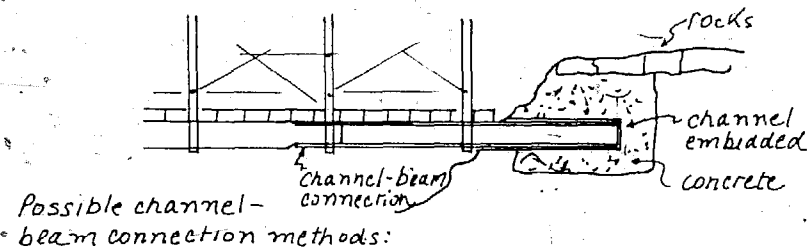

method 1. side view,  
beam inserted in channel



method 2. top view,  
beam bolted to channel web

An empirical rating system of 1 to 10 was devised to describe the condition of the walkways investigated in Taplejung:

- 1 to 3 Dangerous. Very little stability - little stiffness against vertical oscillations and laterally unstable. High priority for new walkway.
- 4 to 6 Intermediate condition. Walkway in need of repair but new walkway unnecessary.
- 7 to 10 Basically in good condition with good lateral and vertical stability.

The average condition of the 24 bridges investigated was a rating of 6. Five of the bridges needed new walkways and were dangerous in our opinion. Six of the bridges were badly in need of repair but did not require a new walkway. It was often noted that the stringers were in good condition while the planking needed replacement. Forty-five percent of the bridges are in need of repair or a new walkway. This is an indication of low priority attached to walkway repair and/or lack of effective organization for bridge maintenance. Training of local persons by actually repairing existing bridges in Taplejung is suggested. The rating given to each of the bridge walkways studied is listed in the Appendix, page 42.

2.5 Towers and Anchors

There were basically 4 different arrangements of towers and anchors for the bridges investigated. The first type consisted of a masonry tower separate from the anchor block. Although this arrangement was common in Ilam and Panchtar, only the Morem Limbu Panchayat Bridge, T 7, and Phawa Khola Bridge, P 1, in Taplejung District had masonry towers and separate cable anchors. The second type was the more common arrangement. It consisted of a combination tower - anchor, often with wooden struts in front taking some of the vertical load. The third basic type was a short masonry wall-like structure which supported the cables at handrail height. This type of short masonry tower was used for suspended type bridges where the handrail cables were the main cables. The fourth type of arrangement simply involved anchoring the cables in rock above the walkway landing point, eliminating the need for towers.

TYPE 1.

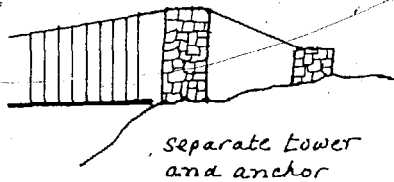

TYPE 2.

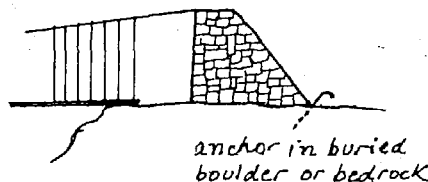

TYPE 3.

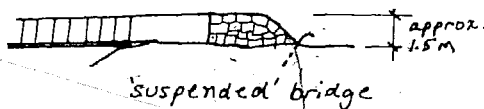

TYPE 4.

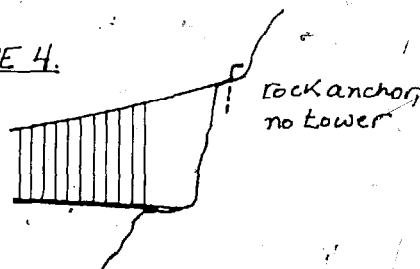

ty-eight bridge towers were seen during the study. Seventy-  
e percent, 33 in all, were of type 2 construction. Seven tower-  
hor arrangements of type 1, 4 of type 3 and 4 of type 4



were also seen. From these statistics it is apparent that the type 2 tower is the most common variety.

The type 1 tower-anchor arrangement is a good solution if the shear and moment is minimized in the tower. It is advantageous to build this type of bridge with roughly equal forestay and backstay angles but may not always be possible. The Phawa Khola Bridge of Dumricha Panchayat, P 1, was the only bridge which had approximately equal forestay and backstay angles on at least one side of the bridge.

All of the other towers investigated, including those in Ilam and Panchtar, had steep backstay angles. The tower on the opposite bank across from the tower shown in picture P 1 had steep and unequal backstay angles. The right bank tower of the Miwa Khola Bridge, I 6, also had a steep backstay angle with a design similar to that of Phawa Khola Bridge. At first inspection it



appeared that the masonry above the cable saddle points of Miwa Khola Bridge was unnecessary but under more careful analysis became evident that this sort of masonry cap adds dead weight which improves both the shear capacity and the moment resistance of the tower. It should be noted that the weight of the masonry

cap was in all cases transferred to the masonry below without reacting on the cables. This was usually accomplished by building a wooden frame at the level of the cables.

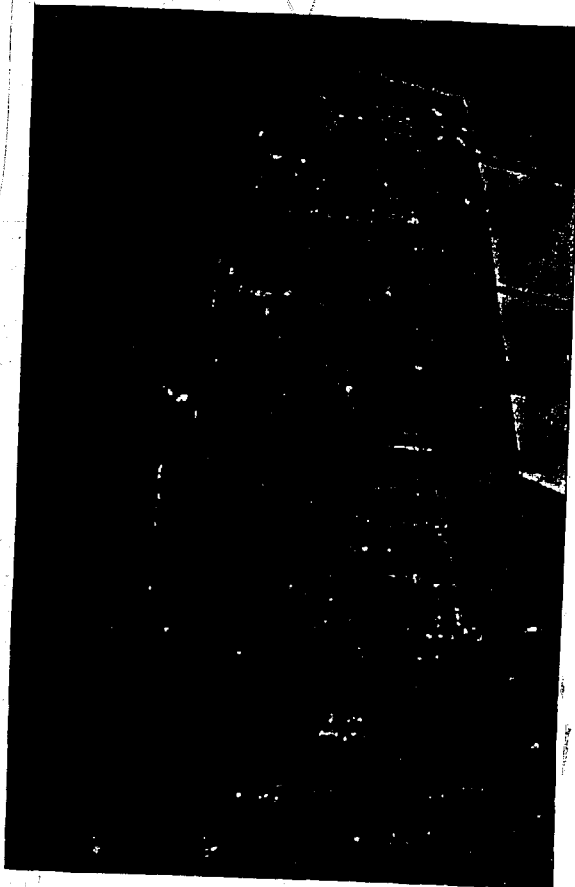
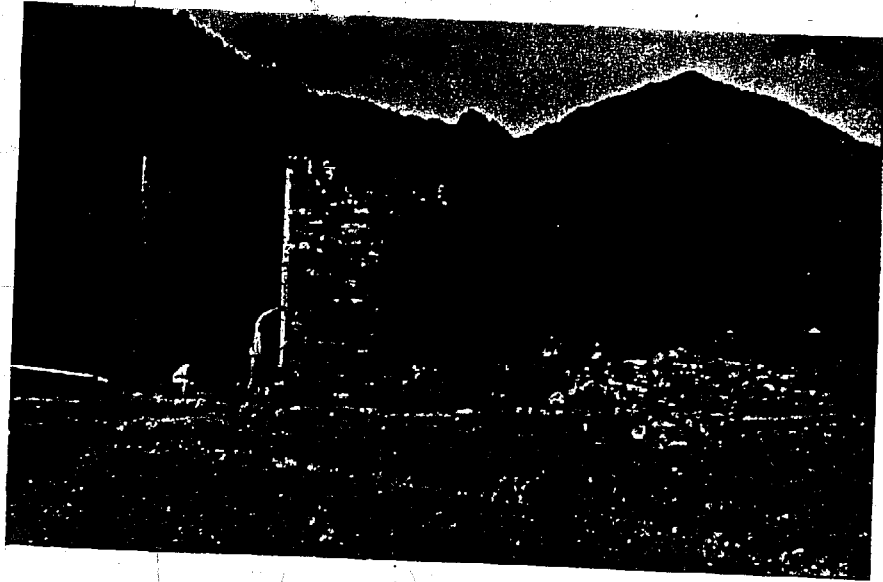

With Cap:

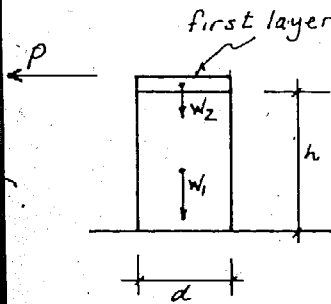

shear resistance =  $W_2 \cdot \mu$

moment resistance =  $(W_1 + W_2) \frac{d}{2}$

Without cap:

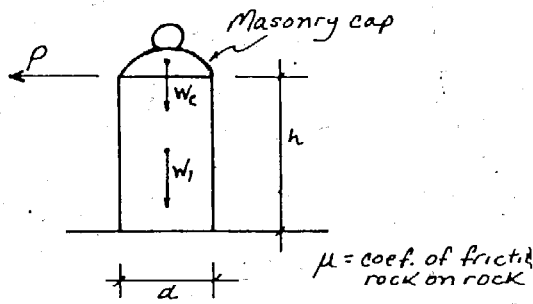

shear resistance =  $W_c \cdot \mu$

moment res. =  $(W_1 + W_c) \frac{d}{2}$

$\mu = \text{coef. of friction rock on rock}$

Since  $W_c \gg W_2$  both the shear and moment resistance is higher with a masonry cap. (vertical cable reaction neglected.)

Morem Limbu Bridge over the Tamur, T.7, had masonry towers without tower caps and had steep backstay angles. Both of the masonry towers had evidence of shear and moment induced cracking. In this case the shear failure appeared to be parallel to the resultant force of the 2 cable tensions. The moment induced cracking indicated that the unbalanced horizontal component of force at the top of the tower multiplied by the height of the tower was less than the resisting moment. The resisting moment was equal to the vertical cable force plus the tower dead weight times half the tower thickness. Also it should be noted that the masonry cable anchor block appeared to be of insufficient size, but the depth of the anchor could not be determined.

It is concluded that with this type of tower-anchor arrangement a masonry cap on the tower is helpful in resisting moment and shear. Also it is suggested that equal forestay and backstay cables be used when possible.

See variations of the second type of tower were seen and are discussed here as types 2A, 2B and 2C. The type 2A tower had a wooden 'tower' placed immediately in front of the masonry tower-anchor and usually secured against sway by a steel flat inserted in the masonry and wrapped around each wooden strut. The type 2B tower had a wooden tower several meters in front of the masonry



structure. The type 2C tower was entirely a masonry structure with no wooden supports. Of the towers investigated which were in the type 2 category, 3 fit in the type 2A subcategory, 16 in type 2B and 14 in type 2C. The quality of workmanship of the

Variations on Type 2 towers:

TYPE 2A:

TYPE 2B:

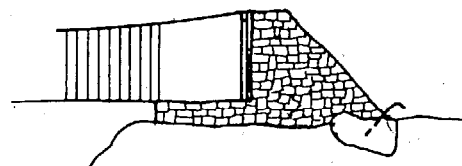

wood tower next to masonry

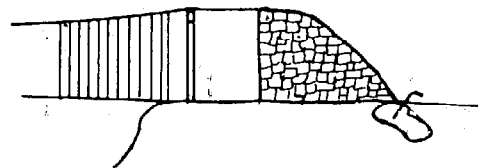

tower ahead of masonry

(Type 2C tower-anchor has no wood tower)

stone tower construction was an important factor in the stability of the structure. Some examples of good and bad masonry construction of the type 2 tower are discussed below.

The Sisung Khola Bridge, T 9, had a masonry tower-anchor with a wooden tower in front of the masonry. It was observed that there was a  $45^\circ$  crack located half a meter from the top of the tower which opened and closed when the bridge was lightly loaded. The movement appeared to be caused by the unbalanced resultant force at the top of the tower. The masonry work in the tower was poor and perhaps the crack would not have formed if the stones had been properly keyed. Besides the poor masonry, the placement of the cable support beam was too close to the front of the tower.

Sisung Bridge Foundation

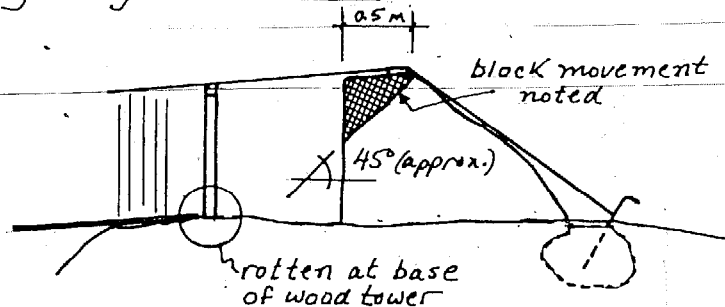

Analysis indicates that the wooden tower is detrimental to the strength of the masonry tower because the cable forestay angle is decreased. The result is a larger unbalanced force on the masonry tower. Also it should be noted that the wooden towers observed were often rotten at the base and not able to take a large vertical load.

The largest dry stone tower-anchor encountered was on the Nuwa Khola Bridge, I 5. The tower height was 5 meters. Despite unequal forestay and backstay angles,  $9^\circ$  and  $45^\circ$  respectively, the bridge was structurally sound under light dynamic loading. No evidence of moment or shear cracking could be found. It was



noted that the cable support beam was one and half meters back from the face of the tower. Having the support beam further back from the tower face increases the shear resistance. Although accurate analysis of the type 2 tower is difficult, some calculations are presented together with a discussion in the Appendix, page 53. The quality of workmanship is difficult to account for in design calculations.

The third type of tower-anchor system, consisting of a short, wall-like masonry structure, was used for suspended bridges. Similar problems are encountered with this type of masonry system as with the type 2 tower-anchor. If the cable backstay angle is too steep, cracks may develop due to high shear through the masonry. All of the type 3 towers seen in Taplejung had the rocks placed horizontally. Superior stability might be achieved if the rocks were placed at a slight angle. Also, if the back of the wall is slightly curved, the cable more uniformly distributes the force to the masonry.

### TYPE 3. TOWER-ANCHOR

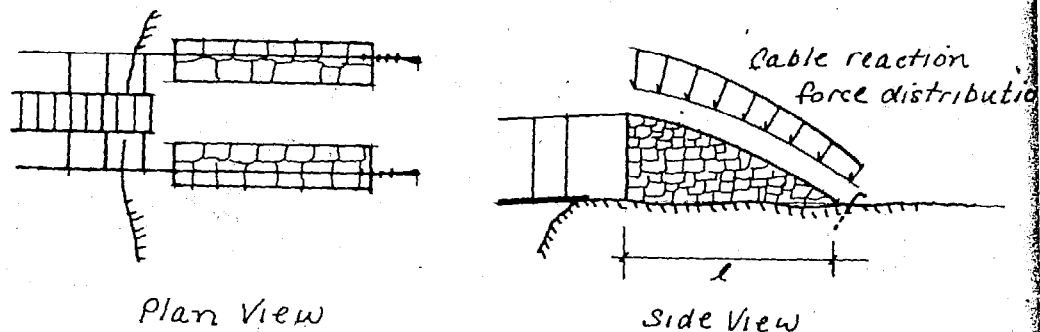

The fourth and last type of tower-anchor system, consisting of a direct anchorage without towers, utilized steel rods in shear to anchor the cables and had no masonry or wood structures. In all of the bridges seen the cables were anchored to a large boulder or bedrock by means of hooked steel rods. With this type of anchor there are 3 modes of failure possible: shear of the steel rods, pullout of a buried boulder or crushing of rock in front of the rods. Direct pullout of the steel rods was not a problem, since in all the bridges studied the anchor rods had very little vertical force on them. The shear strength of the anchor rods reduced the overall load capacity of the bridge in some cases. For 5 of the bridges the sizes of the anchor rods are shown next page.

The allowable and ultimate shear force for the anchor rods on each bridge was computed. As a comparison the allowable cable tension, taken as one third breaking strength, is also listed.

Bridge No	No and size Anchor rods	Total Area	Allowable* Rod Force	Ultimate* Rod Force	Cable Allowable
1	2, 32 mm	16.1 cm <sup>2</sup>	17.7 tonne	32.2 tonne	34.0 tonne
3	2, 35	9.82	10.8	19.6	32.2
5	2, 32	16.1	17.7	32.2	34.0
2	32 & 25	12.95	14.2	25.9	11.2
33	2, 32	16.1	17.7	32.2	34.0

Allowable shear stress = 1.1 tonne/cm<sup>2</sup>. Ultimate shear stress = 2.0 tonne/cm<sup>2</sup> [Indian Civil Engineering Handbook]

In 3 cases out of 5 the rods would shear before the allowable cable tension is reached. In 4 out of 5 the allowable rod force is less than the allowable cable force. These findings indicate local builders should be assisted in the selection of the number and size of shear rods. A simple chart might be developed listing cable sizes and the corresponding number and size of rods required.

The problem of boulder pull out is not easily attacked analytically. When used with a type 2 tower the boulder should be partially under the rocks in the tower. This way the weight of the masonry tower resists the pullout. The steeper the back angle the greater the vertical force on the anchor boulder. This is another reason to minimize the steepness of the backstay angle.

Buried Boulder Anchor:

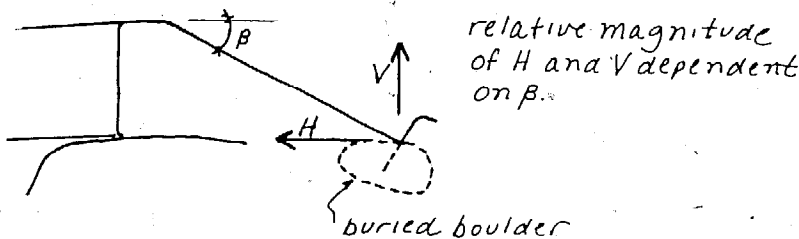

The crushing of rock ahead of the steel rods was not observed but, if the anchor rods are placed in poor quality rock, crushing is possible. Local people might be instructed in how to identify good rock.

An alternative type of deadman anchor might be introduced in Taplejung. The cable could be wrapped around steel pipes or, as in Baglung District, around a boulder and then bulldog gripped together. This anchor would eliminate the need for imbedding steel rods in boulders. Also the cable would not have to be wrapped around small diameter rods which might damage the cable. All buried steel and cable should be protected against rusting by imbedding it in concrete or applying some other protective coating such as coal tar or bituminous paint.

It is suggested that simple guidelines should be developed for masonry towers. The guidelines could establish several types of towers and indicate for specific site condition, span and rough bridge profile which tower can be used. Charts could be developed to show tower and anchor proportions for different bridge types and initial geometry. For example, it might be concluded that the type 2 tower-anchor arrangement is uneconomical for very long spans, since a great volume of stone masonry is required. The type 1 tower-anchor arrangement might be found more economical for long spans.

In many of the masonry towers studied the forestay and backstay cable forces produce a reaction which intersects the front wall of the tower. This reaction should be at least within the base of the tower. Towers can and have been built that take a high shear force through the tower face but the resistance of the tower against such force is highly dependent on the quality of the stone work and such towers are therefore not recommended.

A superior design for a masonry tower could be introduced in Taplejung. This tower would have a wider base than top so that the reaction force would intersect inside the base. Since the tower would be tapered, the required dry stone volume would be

## Force Diagrams - Masonry Towers

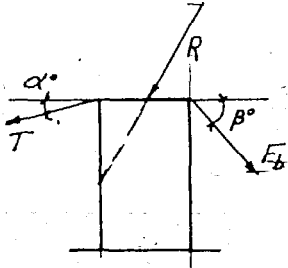

Typical local tower  
(type 1) - reaction  
intersects front  
of tower

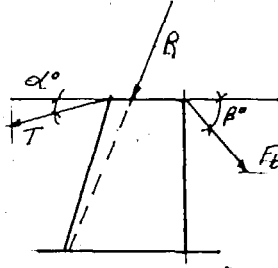

Modified tower shape -  
reaction intersects  
within tower base.

less or the same as is now used in the rectangular towers. Calculations indicate that the masonry tower could be greatly improved if the cable rested on a steel saddle at the top of the tower instead of directly on rock or on wood. The cable on steel friction coefficient is only about .1, while the cable on stone coefficient is about four times that. By reducing the coefficient of friction the unbalanced force on the tower is significantly reduced. A general analytical approach to tower design and design examples are given in the Appendix, pages 53-63. These calculations and results are intended as a starting point for the development of guidelines for stone masonry tower design and construction.

### 2.6 Other Components

Wind guy cables were seldom seen and, if they were used, they were ineffective. On one of the bridges studied a small diameter wire was nailed to a wooden member of the bridge walkway and on shore the wire was wrapped around a tree. Of course this type of wind bracing is non functional. It was noted that bridges which had 2 or 3 longitudinal stringers running the length of the walkway had good lateral stability and should be able to withstand high wind loading.

In order to secure anchor rod steel in rock local people used a locally made lime cement (called chuna in Nepali). Portland cement, if available, was also used for anchor steel. The procedure used in making chuna is described in the Appendix, pages 68-69. Unfortunately the process is lengthy and often the necessary limestone rocks are hard to find. For these reasons it appears that this local cement can have only limited use in local bridge construction in Taplejung.

Steel parts for bridges often were purchased in Darjeeling and transported by local persons. The cost of steel parts was sometimes paid by a single wealthy family near the bridge site and sometimes partly or in whole financed by the District. It appeared that it was usually the initiative of a single individual which kindled the necessary local enthusiasm to build a bridge.

### 3. Conclusion

Basically the local approach to bridge construction in Taplejung is structurally sound. Ideas for inexpensive improvement in local bridges have been given in this report. Some of these are listed below:

1. Standardized suspender rod - cable connectors should be provided to the district
2. Standardized angle sections for walkway crossbeams instead of steel flats should be provided to the District
3. Improved dry stone masonry tower designs without wooden towers should be adopted
4. Three ways to improve the durability of stringers at the ends of the bridge are suggested
5. More and/or larger diameter steel rods should be used to anchor the cables
6. Bulldog grips should be proved with cables to the District. Local grips are not always dependable and should be avoided

A training program in Taplejung for local bridge builders is currently planned and will be a good opportunity to introduce some of the technical innovations suggested in this report. The engineer-trainer of the program will have the responsibility of developing guidelines for local bridge construction in Taplejung. These guidelines should be tentatively set down in a preliminary manual, which can be refined during and after the training program. This manual should, besides establishing guidelines, present technical information in a simplified manner for use by local persons with practical experience but little or no formal technical training. The training program should be followed up by supervision of each of the new overseers as he builds or repairs his first bridge. This could be accomplished by having an experienced engineer assigned to several projects to act as an advisor. If a new overseer successfully completes his first project, it is likely he will continue to be involved in local bridge projects.

Besides the manual for the local bridge builders another manual written for engineers would be useful. The need for an engineer's manual has been observed in the Local Development Department and in many districts. Peace Corps, SBO and other organizations also would benefit from such a manual. The engineer's manual should include the following:

1. Guidelines for the selection and survey of bridge sites
2. Design loadings listed in chart form for different kinds of anticipated bridge traffic and different walkway widths
3. Simplified ways to design bridges using charts whenever possible
4. Design ideas for different site conditions and spans
5. Bridge construction methods
6. Useful technical data such as cable areas, steel rod sizes and areas, simple geometric relationships, yield strengths and Modulus of Elasticity for steel and cable and other information



Special sections could be added to the manual to describe local bridges built in other regions as those sections become available. The local manual should be written both in English and in Nepali. The engineer's manual should be in English and perhaps also in Nepali.

Glossary

Allowable Load: a load on a structure which causes the materials to be stressed to a permissible stress level. The permissible stress (or synonymously allowable stress) is given in a code or other references for specific materials.

Allowable Stress: the ultimate or yield stress of a material divided by a safety factor. Allowable stress is synonymous with permissible or working stress.

Anchor Block: a masonry or concrete structure which is used to secure the tensile force in the cable. The block is usually buried or partially buried.

Angle Section: A steel section which is 'L' shaped in cross section. The critical dimensions are those of the 'L', including thickness.

Backstay: the section of the main bridge cables behind the tower saddles or cable support points.

Beam: A prismatic bar that is subjected to force acting perpendicular to its axis. Usually the cross sectional dimensions are much less than the axial length.

Bulldog Grip: a device used to clamp a cable onto itself or another cable. It consists of a 'U' shaped bolt and a grooved casting with two holes in the casting permitting insertion of the 'U' bolt. Clamping force is applied by tightening nuts on the ends of the 'U' bolt.

Camber: the maximum rise in the walkway between the landing points. Walkways which are horizontal or sag have no camber. See drawing page 5. Camber is often expressed as a percentage of span length.

Channel Section: a steel section which has a 'C' shape. The critical dimensions are those of the 'C', including thickness.

Coefficient of Friction: the factor which, when multiplied by the normal force, gives the static or dynamic frictional resistance to sliding between two faces.

Compression: a force causing material to condense or squeeze together. Opposite of tension.

Cradle: in plan view the maximum deflection of the cable, from cable supports or saddle points toward the centerline of the bridge. Cradle is often expressed as a percentage of span length.

Cross Support: a beam placed perpendicular to the walkway centerline to support planking or stringers.

Dead Weight: the total weight of all structural elements along the bridge walkway. Usually expressed in weight per unit length along the bridge centerline.

Dry Stone Masonry: a cementless structure built primarily of rock or brick.

Dynamic Load: excess or impact load caused by any moving load. Opposite of static load.

Flat: a steel section of rectangular cross section with common dimensions of 50 x 6 mm, 40 x 6 mm, 25 x 5 mm, etc.

Forestay: the section of the main cable ahead of the tower saddles or cable support points.

Freeboard: the distance between the lowest point of the walkway to the water level.

Full Live Load: the highest anticipated loading condition excluding the dead load. Usually expressed in weight per unit length along the bridge.

Hose Clamps: a device of thin steel strap often used to secure flexible hose to metal tubes such as in a gas or diesel engine. The steel strap has small transverse slits at one end such that it can be tightened by a screw in a housing at the other end of the strap.

Hybrid Walkway: a modified bridge walkway combining design ideas seen in existing walkways of an area.

Local Bridge: any bridge built by persons of a specific area, usually with no outside technical advice. Often local bridges of an area have similar designs.

Longitudinal: lengthwise. In the case of bridges any structural element running parallel to the centerline can be described as longitudinal.

Modulus of Elasticity: a constant of proportionality which equates stress and strain linearly for a specific material. Expressed in force per unit area.

Moment: the tendency of a force to cause rotation about a point or axis. Expressed in force times unit length.

Saddle: the part of the tower on which the cable bears and which in turn transfers the cable load to the tower. Usually made of steel.

Sag Ratio: the ratio of maximum deflection,  $Y_c$ , of the cable between support points to the span length,  $S$ . Usually expressed as a percentage. See drawing, page 5.

Shear: the force tending to cause two parts which are in contact to slide upon each other in opposite directions.

Shear Stress: the pressure caused by shear force acting on the two parts which are in contact with each other. Expressed in force per unit area.

Span: the distance between tower saddles or cable support points.

Stringer: a structural member used as a beam. In the case of bridges it is a longitudinally running beam of the walkway.

Suspender Rod: a steel rod used to connect the main cables to the walkway.

Suspended Bridge: a bridge in which the walkway sag is the same as the cable sag. Usually the sag ratio is less than 5%.

Suspension Bridge: a bridge in which the walkway is horizontal or cambered. Usually the main cables have a sag ratio greater than 5%.

Tension: a force causing material to pull apart. Opposite of compression.

Tower: a structure supporting the cable at the ends of the bridge. It can be made of steel, concrete, masonry or wood.

Working Load: the allowable load. See definition of allowable load.

Working Stress: the allowable stress for a material. See definition of allowable stress.

Appendix I  
Map Showing Investigated Bridge Locations

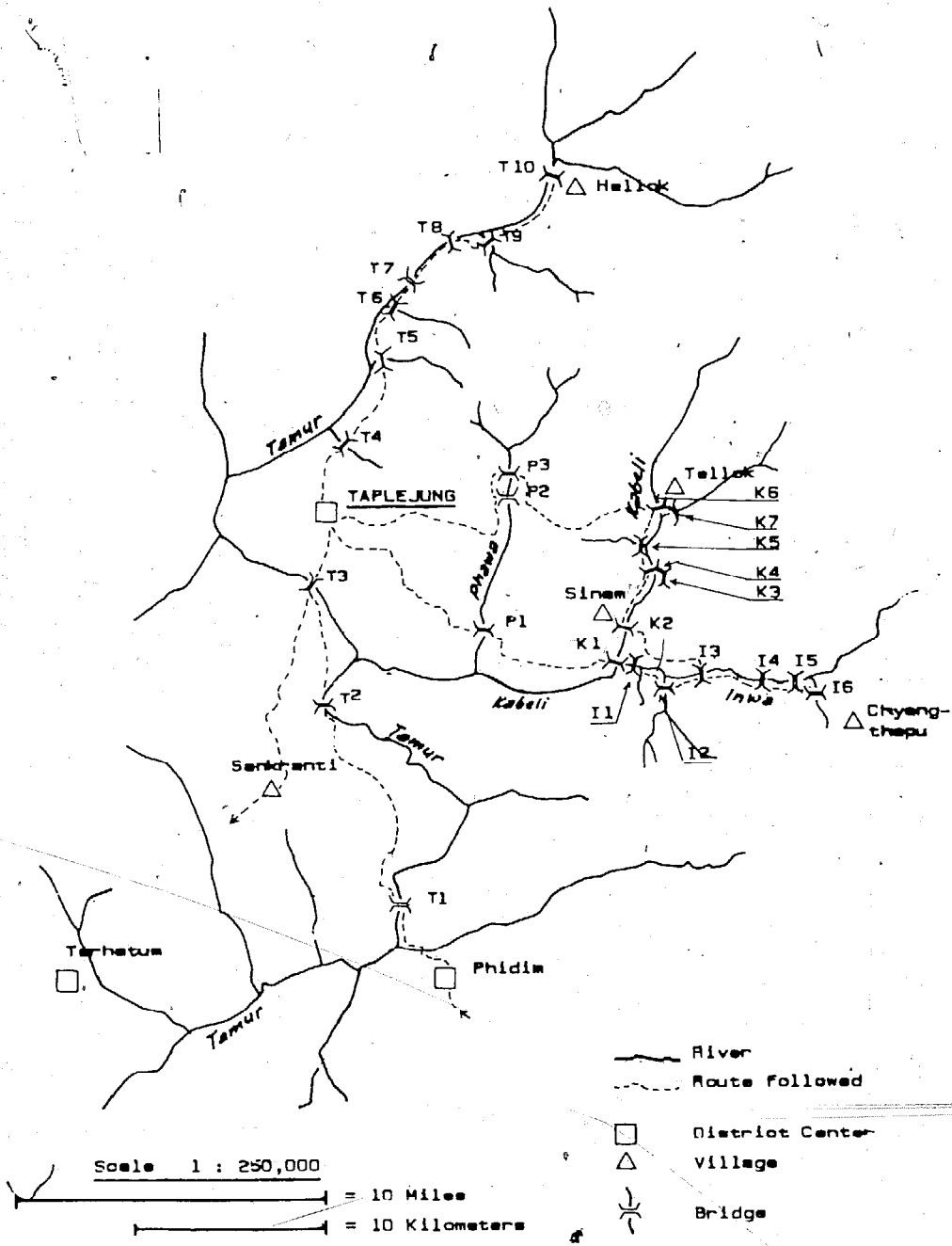

Appendix II - Basic Data for Bridges Studied

Bridge no	Bridge location	span	wsg ratio	cabie description	total cable area (sqm)	allow cable load (kg/m)	walkway	foundation type	cond	notable aspects
T 1	Situla Bridge Tamur River	110	0.058	1, 32 mm 3, 19 mm	823.8	185	standard, 2 string o r = 8 to	2A	good	masonry cap on towers
T 2	Limbura Bridge Tamur River	100	0.04	2, 19 mm 2, 18 mm 2, chain 9 mm links			longitudinal planks on place o r = 1	1	Fair	local bulldog grips
T 3	Khenna Khula Bridge Tamur River	60	0.035	2, 44 mm 2, 26 mm	2,116.0	525	standard, 3 string o r = 6	2C	--	--
T 4	Angdeewa District Kamei Uade River	12	0.037	2, 119 mm	277.4	455	single plank with flat o r = 8	3	Fair	walkway
T 5	Handewa River	40	0.036	2, 18 mm 2, chain 15 mm links			standard, 3 string w-wood handrail o r = 8	2B	Fair	chain and cable parallel
T 6	Siana River	36	0.042	4, 19 mm	554.8	310	standard, wood fence o r = 8	2B	Fair	--
T 7	Morae Lieba Panchayat Tamur River	101	0.045	8, 19 mm	1,108.6	240	standard, o r = 7	1	poor	cracking in towers
T 8	Echaboo Panchayat Tamur River	87	0.044	2, 44 mm	1,594.8	535	standard, wood fence o r = 5	2B	good	hose clamps used to fix suspender rods
T 9	Sisung River	30	0.030	4, 19 mm	554.8	325	standard o r = 1	2B	poor	crack in tower; opens and closes
T 10	Hallok Panchayat Tamur River	48	0.054	2, 26 mm 2, 18 mm	798.6	435	standard o r = 8	2B	good	small freeboard
I 1	Inwa River	36	0.076	2, 32 mm	815.4	745	standard o r = 7	4, 2B	Fair	suspender rods wired to cable to prevent sliding
I 2	Siew River	27	0.024	2, 32 mm	815.4	505	double thickness longitud. planks o r = 7	2B	--	walkway
I 3	Abodea Bridge Inwa River	78	0.038	4, 19 mm	554.8	130	standard o r = 7	2B	--	--
I 5	Inwa Khola	58	0.036	2, 32 mm	815.4	280	standard o r = 5	4, 2A	Fair	5 meter high masonry tower
I 6	Chyangthou Panchayat Misa River	47	0.051	2, 32 mm	815.4	420	angle braces beams wood handrail o r = 10	4, 1	good	walkway
P 1	Duenichne Panchayat Phena River	37	0.800	2, 32 mm	815.4	915	standard, repaired w. longitud. planks o r = 3	1	good	masonry tower base
P 2	Kunsewi Panchayat Phena River	25	0.033	2, 26 mm	521.2	380	standard o r = 1	3	Fair	dangerous cable connections & clamps
P 3	Kunsewi Panchayat	28	0.068	2, 32 mm	815.4	875	longitud. planks poor repair o r = 1	2C	poor	--
K 1	Thumedin Village Kabeil River	60	0.038	4, 19 mm	554.8	175	standard o r = 5	2C	poor	dangerous connections, heavy traffic
K 3	Barundin Village Kabeil River	49	0.047	2, 32 mm	815.4	385	double thickness longitud. planks o r = 8	2C	Fair	walkway
K 4	Barundin Village Phena River	42	0.062	2, 32 mm	815.4	545	walkway repaired w. bamboo o r = 2	2C	Fair	--
K 5	Barundin Village Kansa River	31	0.048	2, 19 mm	277.4	200	bamboo as planks over planks o r = 1	2B	Fair	--
K 6	Telik Village Kabeil River	34	0.043	8, 19 mm	832.2	580	standard o r = 7	2C	good	--
K 7	Telik Village	34	0.066	2, 32 mm	1,082.6	875	longitud. planks with flat o r = 5	4, 2C	good	masonry cap on towers

\* determined by cable tension only, dead weight of bridge not subtracted

= 10,130  
average = 480

\*\* = condition rate

Appendix III  
Calculations

A Allowable loading for cables

The following assumptions were made in the cable computations:

1. The ultimate cable stress was taken as 90 % of the new cable ultimate

$$\begin{aligned} \sigma_{ult.} &= .90 \times 160 \text{ kg/mm}^2 \\ &= 144 \text{ kg/mm}^2 \end{aligned}$$

The value of 160 kg/mm<sup>2</sup> is from the Steel Wire Rope Breaking Strengths and Weights Tables, USHA Martin Black (Wire Ropes) LTD, page 13 - 26.

2. The allowable cable stress is taken as a third of the ultimate cable stress:

$$\sigma_{all} = 144/3 = 48 \text{ kg/mm}^2$$

The factor of 1/3 is suggested in Part A of the Standard Trail Suspended and Suspension Bridges by SBD

The Modulus of Elasticity, E, is assumed to be 10.5 tonne/mm<sup>2</sup>. The USS Tiger Brand Wire Rope Hand Book, page 30, suggests 9.9 tonne/mm<sup>2</sup> for new 6 x 7 and 6 x 19 ungalvanized wire rope. The higher value is taken since the cable is used and therefore pretensioned.

Four different cable types were seen in Taplejung:

cable diameter	assumed construction	assumed area
19 mm	6x7 fiber core	138.7 mm <sup>2</sup>
26 mm	6x19 wire core	260.6 mm <sup>2</sup>
32 mm	6x19 wire core	407.7 mm <sup>2</sup>
44 mm	6x19 wire core	797.4 mm <sup>2</sup>

Above information from USS Tiger Brand Wire Rope Engineering Handbook, page 29.



For a sample calculation Bridge I 3 is used. Data:

cables: 4, 19 mm diameter haulage rope

span: 78 meter (= s)

initial sag ratio: 0.038 at dead load (=  $k_i$ )

area cable =  $4 \times 138.7 \text{ mm}^2 = 554.8 \text{ mm}^2$  (= A)

Mod. of Elasticity = 10.5 t/mm<sup>2</sup>

Allow. cable stress = 0.048 t/mm<sup>2</sup>

initial cable length =  $L_i$

$$L_i = s \left( 1 + \frac{8}{3} k_i^2 \right) = 78 \left( 1 + \frac{8}{3} (0.038)^2 \right) \\ = 78.30 \text{ m}$$

initial cable tension =  $t_i$   
assuming a dead load of 60 kg/m

$$t_i = \frac{w s}{8 k} = \frac{0.06 (78)}{8 (0.038)} \\ = 15.39 \text{ tonnes}$$

The following 3 basic cable equations are used to derive a the equation used to determine the allowable cable load.

$$L_i = s \left( 1 + \frac{8}{3} k_i^2 \right) \quad - \text{ cable length equation}$$

$$t_i = \frac{w_i s}{8 k_i} \quad - \text{ cable tension equation [cable tension is assumed equal to the horizontal tension]}$$

$$L_f - L_i = \frac{(t_f - t_i) L_i}{AE} \quad - \text{ cable elongation equation}$$

The basic equation used for iteration is derived to be:

$$\frac{L_i}{AE} (t_f - t_i) + L_i - s = \frac{w_f^2 s^3}{24 E k_f^2}$$

Substitute  $P = L_i / AE$

$$P (t_f - t_i) + L_i - s = \frac{w_f^2 s^3}{24 E k_f^2}$$

(Reference: USS Tiger Brand Wire Rope Engineering Handbook, page 40)

The variables are defined:

$L_i$	= initial cable length	A	= cable area
$L_f$	= final cable length	E	= cable Modulus of Elasticity
$t_i$	= initial cable tension	$w_f$	= final cable load
$t_f$	= final cable tension	S	= span
		$k_i$	= initial sag ratio

$$P = \frac{78.30}{554.8(10.5)} = 0.013441$$

$$t_f + \frac{78.3 - 78}{0.013441} - 15.39 = \frac{w^2 78^3}{24(0.01344)t_f^2}$$

$$t_f + 6.9298 = 1.471096 \times 10^6 w_f^2 / t_f^2$$

$$t_f = \sqrt{\frac{1.471096 \times 10^6 w^2}{t_f + 6.9298}}$$

Now the iteration can be carried out for different values of W.

For different values of W, the load, the cable tension, t, is calculated:

W.	t	W <sub>all</sub> occurs when t = 26.6 tonnes
300	49.26	
100	22.45	so W <sub>all</sub> is solved for by interpolation between 100 and 200:
200	36.59	

→ 0.1415 tonne/kg/m

$$W_{all} = 100 + \frac{26.6 - 22.45}{0.1415}$$

$$W_{all} = 130 \text{ kg/m}$$

If the bridge dead load is 50 kg/m then the allowable bridge loading would only be 80 kg/m.

### B Stress - Strain Incompatibility between Cable and Chain Links

For a sample calculation bridge T 2 is used. Basic Data:

#### Steel

$\epsilon_y$  = strain at yield

$\sigma_y$  = yield stress = 23.91 kg/mm<sup>2</sup>

$$\epsilon_y = \sigma_y / E = 23.91 / 2.04 \times 10^4 = 1.172 \times 10^{-3} \text{ mm/mm}$$

[the above values are from Indian Civil Engineering Handbook, page 18/3]

C Local Bulldog Grips

Data:

Allowable tensile stress for bolts =  $\sigma_{all} = 10.6 \text{ kg/mm}^2$

Area  $\frac{1}{2}$  " diameter bolt =  $A_{bolt} = 78 \text{ mm}^2$   
 (Ref. ICEHB, page 4/35)

coefficient of friction cable on steel =  $\mu = .1$

Ultimate load capacity 19 mm haulage rope = 18 tons

$N = 4 \times \sigma_{all} \times A_b = 4 \times 10.6 \times 78$   
 = 3.31 tonne

$F_{resisting} = N \times \mu = 3.31 \times .1 = 0.331 \text{ tonne}$

No of bulldog grips required =  $\frac{18}{.331} = 54$

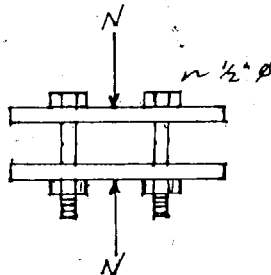

If it were possible to increase the coefficient of friction to .3 by grooving the plates the number of grips could be reduced to 18.

Effective coefficient of friction - standard grip

1" wire core 6x19 galvanized cable

number of grips required = 5 (part A, Trail Bridge Manual, page 5/202)

breaking strength of cable = 41.7 tonne (assuming  $\sigma_{ult} = 160 \text{ kg/mm}^2$ , area cable = 260.6 mm<sup>2</sup>)

allowable normal force of grip = 4.14 tonne (assuming  $\frac{1}{2}$  " diameter U/bolt, 2.07 tonne allowable per side, ICEHB, page 4/35)

effective coefficient of friction =  $\frac{41.7}{4.14 \times 5} = 2.01$

This result indicates that an effective coefficient of friction of higher than .3 should be possible for local grips if they are properly made. Testing would be necessary.

D Walkway Design Calculations

1. Flat with 3 stringers walkway design

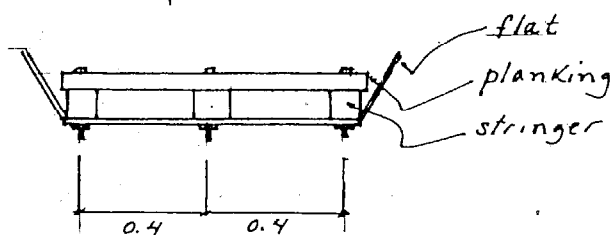

Planking: specify at least 1 1/2" sal wood to assure good durability. Less than 1 1/2" required for strength.

Stringers design:

Loading of stringer

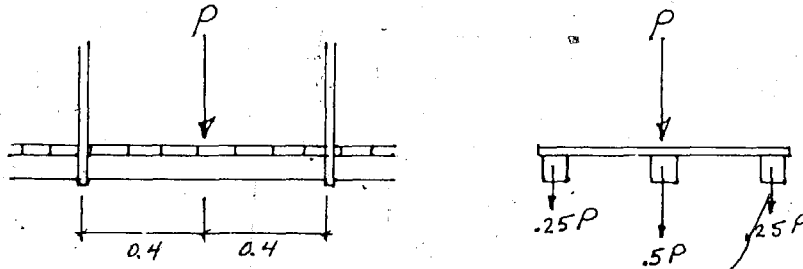

Assume .5 P distributed to the middle stringer and .25 P to the outside stringers.

data:

- $\sigma_{all}$  = allowable stress in Sal stringer = 112 kg/cm<sup>2</sup>  
[reference: ICEHB, page 9/28]
- P = factored point loading on one panel
- S.F. = 1.7 [safety factor]
- M = moment in stringer
- I = moment of inertia
- c = distance to the neutral axis from tension face
- b = width of stringer
- h = height of stringer, parallel to loading

Assume the unfactored point load to be 180 kg

- P = 1.7 x 180 = 306 kg [1.7 is a dynamic load factor]
- M = .5 P x 40 = 20 P = 20 x 306 = 6,120 kg-cm

Stringer Cross Section:

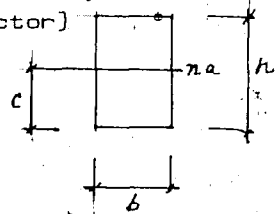

Assume the stringer width to be 10 cm then,

$$I = \frac{1}{12} b h^3, \quad b = 10 \text{ so,}$$

$$I = \frac{10}{12} h^3$$

c = h/2 in the case of a rectangular section

$$\sigma_{all} = M c / I \quad \text{substituting above value for M and equations for I and c,}$$

$$\sigma_{all} = \frac{3060}{\frac{10}{12} \times h \times 12} = \frac{1836}{\frac{h^2}{2}} = \frac{3672}{h^2}$$

$$h = \sqrt{\frac{3672 \times 1836}{\sigma_{all}}} = \sqrt{\frac{3672 \times 1836}{112}} = 5.12 \text{ cm, so, use } 6 \times 10 \text{ cm}$$

For the middle stringer and 6 x 6 cm For the side stringers.

Cross support flat design:

- Sal = Modulus of Elasticity of Sal Wood
- =  $1.27 \times 10^5$  kg/cm<sup>2</sup> (Reference ICEHB, page 9/28)
- Steel = Modulus of Elasticity of Steel
- =  $2.1 \times 10^6$  kg/cm<sup>2</sup> (Reference ICEHB, page 5/47)
- Sal = area sal plank, cross section
- Steel = area steel flat, cross section
- Sal = allowable compressive stress of sal = 29 kg/cm<sup>2</sup>
- Steel = allowable tensile stress steel = 1,260 kg/cm<sup>2</sup> (Reference: ICEHB, page 10/3)
- = moment of inertia of composite beam
- = distance to neutral axis from tensile face
- = distance from outside tensile to compressive face
- = distance from inside tensile to inside compressive face.
- all = allowable moment in beam
- d = design loading for beam

Composite action is assumed between the flat and sal plank.

Composite beam cross section:

$$A_{Sal} = 15 \times 3.8 = 57 \text{ cm}^2$$

$$\sigma_{Steel} = 1,260 \text{ kg/cm}^2$$

$$\sigma_{Sal} = 29 \text{ kg/cm}^2$$

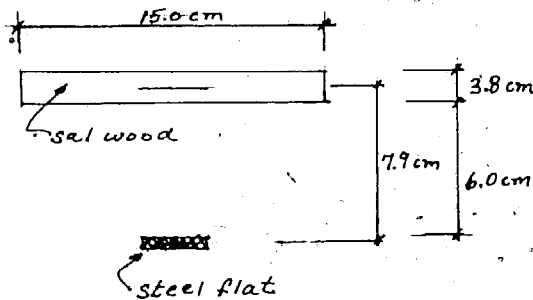

In order to obtain maximum efficiency the steel in the flat should reach allowable stress at the same time the sal plank reaches the allowable compressive stress.

$$A_{Sal} \sigma_{Sal} = A_{Steel} \sigma_{Steel}$$

$$A_{Steel} = \frac{A_{Sal} \sigma_{Sal}}{\sigma_{Steel}} = \frac{5700 \times 29}{1260} = 1.31 \text{ cm}^2$$

tensile stress

Assuming that 1.31 cm<sup>2</sup> of steel is used, a transformed area can be considered in calculating I. The transformed area is composed of two 15 x 3.8 cm sal planks separate by 7.9 cm.

$$I = \frac{b(D^3 - d^3)}{12}$$

$$b = 15 \text{ cm}, D = 11.7 \text{ cm}, d = 4.1 \text{ cm}$$

$$I = \frac{15(11.7^3 - 4.1^3)}{12}$$

$$I = 1,915.86 \text{ cm}^4$$

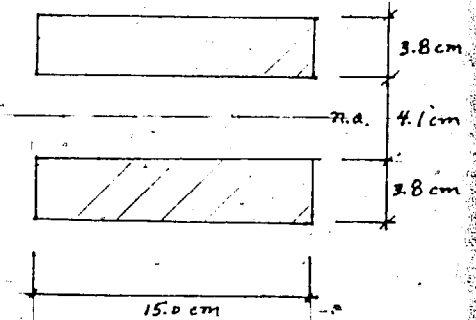

$$M_{all} = \frac{\sigma_{all} I}{c}, \sigma_{all} = 29 \text{ Kg/cm}^2, c = 7.9/2 = 3.95 \text{ cm}$$

$$M_{all} = \frac{29(1915.86)}{3.95} = 14,067 \text{ Kg-cm}$$

$$M_{design} = 300 \text{ kg} \times 40 \text{ cm} = 12,000 \text{ kg}$$

$M_{design} < M_{all}$  so if there is composite action the cross beam system is safe.

### Flat Cross Support design

assuming use of 3/8" bolts

$$A_{bolt} = \frac{.95^2 \pi}{4} = 0.71 \text{ cm}^2$$

$$A_{required} = .71 + 1.31 = 1.42 \text{ cm}^2 \text{ (1.31 cm}^2 \text{ for above calculation)}$$

using 6 mm thick flats the required width of the flat is 2.4 cm,  $\frac{1.422}{6}$ , but specify 40 x 6 mm since it will be more durable and easier to work with.

### 2. Flat with 2 stringers walkway design

Since the plank is narrow assume a point load, unfactored, of 150 kg. All of the below variables are defined earlier

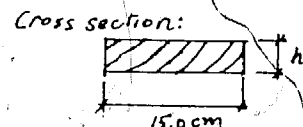
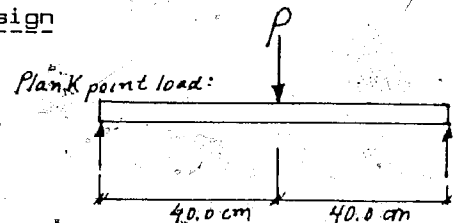

$$= \frac{75}{150} \times 40 = \frac{3000}{5000} \text{ kg-cm}$$

$$= \frac{h}{2}; b = 15$$

$$= \frac{bh^3}{12} = \frac{15h^3}{12}$$

$$\sigma_{all} = \frac{Mc}{I}; \sigma_{all} = 112 \text{ kg/cm}^2$$

$$\sigma_{all} = \frac{Mh}{2(\frac{15h^3}{12})} = \frac{6M}{15h^2} \text{ solving for } h,$$

$$\text{required} = \sqrt{\frac{6M}{15\sigma_{all}}} = \sqrt{\frac{6 \times 6000 \times 3000}{15 \times 112}} = 3.27 \text{ cm}$$

$$= 4.03 \text{ cm}$$

o use 2" (5.08 cm) planking  
1 1/2" 3.81

stringer Design: assume P loads each stringer in the center of the panel so the previously calculated 10 x 6 cm section is sufficient.

slat Design: use the same 40 x 6 mm as previously calculated.

Hybrid Local Design Walkway

slat design: use 1 1/4" thick  
al planking

stringers design: use 6 x 10 cm  
middle stringer and 6 x 6 cm  
side stringers. Attach with  
3/8" bolts through angle

angle cross support design:

$$= 12.25 P$$

$$P = 306 \text{ kg (factored point load)}$$

$$= 12.25 \times 306 =$$

$$= 3,748 \text{ kg-cm}$$

$$= 1,260 \text{ kg/cm}^2$$

$$= \text{Section Modulus} =$$

$$\frac{M}{\sigma_{all}} = \frac{3,748}{1,260}$$

$$= 2.97 \text{ cm}^3$$

Cross section with shear and moment diagrams:

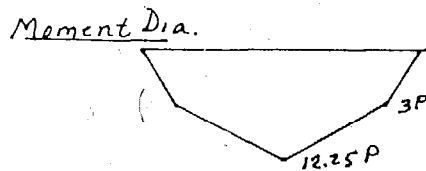
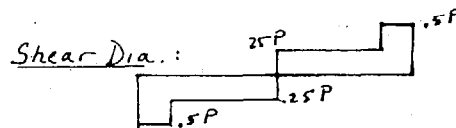
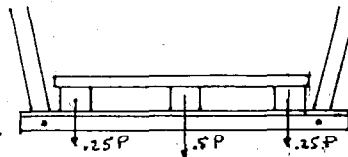

units:  
(force-cm)

use a 50 x 50 x 5 angle with S = 3.1 cm<sup>3</sup> (ICEHB, page 4m/4)

Flat-angle bolt connector design

$V_{all} = \text{allowable shear force} = 800 \text{ kg/cm}^2$  (ICEHB, page 10/3)

$$\frac{P}{2} = 150 \text{ kg}$$

$A_{required} = \frac{150}{800} = 0.1875$  so if  $\frac{1}{4}$ "  $\varnothing$  bolts are used there is a high safety factor of 3.4  
 $\frac{3}{8}$ "  $\varnothing$  bolts are also alright.

It is suggested that the bolt have a small hole in it for a cotter pin so the nut can not come off.

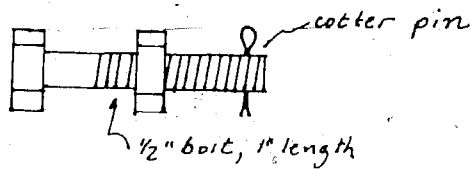



A General Analytical Approach

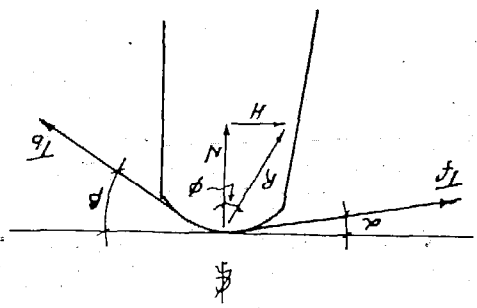

- $T_f$  = cable tension forestay
- $\alpha$  = forestay angle
- $\beta$  = backstay angle
- $T_b$  = back stay tension
- $N$  = vertical component of  $R$
- $H$  = horizontal component of  $R$
- $\phi$  = angle of resultant from vertical

$\mu$  = coefficient of friction  
 $R$  = resultant  
 $N$  = vertical component of  $R$   
 $H$  = horizontal component of  $R$   
 $\phi$  = angle of resultant from vertical

Dec. 17, 1982

However, there is not much difference in calculated values of  $H$  from using the approximation in a typical calculation such as for  $\alpha = 10^\circ, \beta = 30^\circ$  and  $\mu = .15$  or  $.30$

Herbert Rice  
 KAHMANN

$$\frac{N}{H} = \frac{e^{\mu\alpha} \cos\alpha - \cos\beta}{e^{\mu\alpha} \sin\alpha + \sin\beta}$$

becomes  $\alpha^* = \alpha + \beta$ . Equation 5 then should be  $T_f = T_b \cdot e^{\mu\alpha^*}$  where on a saddle of circular section the exact expression for the relation of  $T_f$  and  $T_b$  for cable ( $\alpha^*$  in radians) is only an approximation.

$$T_b = T_f - \mu N, \quad N = \frac{\mu}{T_f - T_b}$$

$$N = \sin\alpha T_f + \sin\beta T_b$$

$$T_b = T_f - \mu (\sin\alpha T_f + \sin\beta T_b)$$

$$T_b = T_f - \mu \sin\alpha T_f - \mu \sin\beta T_b$$

$$T_b (1 + \mu \sin\beta) = T_f (1 - \mu \sin\alpha)$$

$$\frac{T_b}{T_f} = \frac{1 - \mu \sin\alpha}{1 + \mu \sin\beta}$$

$$H = \cos\alpha T_f - \cos\beta T_b$$

$$\frac{N}{H} = \frac{T_f - T_b}{(\cos\alpha T_f - \cos\beta T_b) \cdot \mu}$$

$$T_f = T_b \left( \frac{1 - \mu \sin\alpha}{1 + \mu \sin\beta} \right)$$

$$\frac{N}{H} = \frac{T_b \left( \frac{1 - \mu \sin\alpha}{1 + \mu \sin\beta} \right) - T_b}{\left[ \cos\alpha T_b \left( \frac{1 - \mu \sin\alpha}{1 + \mu \sin\beta} \right) - \cos\beta T_b \right] \mu}$$

equation 1 a, b  
 eg. 2 substitute eq. 2 into a

eg. 3

eg. 4

eg. 4 + eq. 1 b

from eq. 3

$$\frac{H}{N} = \frac{\left[ \cos \alpha \left( \frac{1 + \mu \sin \beta}{1 - \mu \sin \alpha} \right) - \cos \beta \right] \mu}{\left( \frac{1 + \mu \sin \beta}{1 - \mu \sin \alpha} \right) - 1}$$

$$= \frac{\left[ \cos \alpha \left( \frac{1 + \mu \sin \beta}{1 - \mu \sin \alpha} \right) - \cos \beta \right] \mu}{\frac{1 + \mu \sin \beta - 1 + \mu \sin \alpha}{1 - \mu \sin \alpha}}$$

$$= \frac{\mu \cos \alpha (1 + \mu \sin \beta) - \mu \cos \beta (1 - \mu \sin \alpha)}{\mu \sin \beta + \mu \sin \alpha}$$

$$\frac{H}{N} = \frac{\cos \alpha (1 + \mu \sin \beta) - \cos \beta (1 - \mu \sin \alpha)}{\sin \beta + \sin \alpha} \quad \text{equation 5}$$

But eq. 5 is only an approximation. See note on previous page for exact expression for H/N.

From eq. 5 it is possible to determine the ratio of the horizontal force to the vertical force at the tower top if the forestay angle, backstay angle and coefficient of friction are known. The angle,  $\phi$ , can be determined from the H/N ratio:

$$\tan \phi = H/N \quad \text{eq. 6}$$

When designing a masonry tower the following information should be known in order to determine the tower base width,  $d$ :

- $\alpha$  = forestay angle under full bridge load
- $\beta$  = backstay angle
- $h$  = tower height

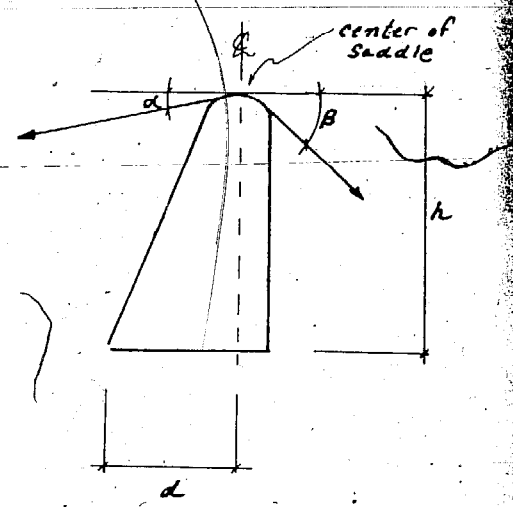

The coefficient of friction ranges from about .1 for a steel saddle to .4 for a masonry rock saddle. The forestay under full load can be determined using the iterative approach described on page 44 of the Appendix.

The reaction force, R, should be within the base of the tower. This condition is described mathematically as:

$$d \geq h \tan \phi \quad \text{equation 7a}$$

or alternatively:

$$d \geq h \left( \frac{H}{N} \right) \quad \text{eq. 7b}$$

Note: Higher values of coefficient of friction should be used for conservative design. Furthermore, though useful for first approximation, equation 7a is an oversimplification. (See below)

B Design Examples

Herbert Rice  
Kathmandu, Dec 17, 1982

For the same bridge geometry 4 different masonry tower and anchor schemes are worked out in order to assess their relative merit. The following data are the initial conditions used in all 4 examples:

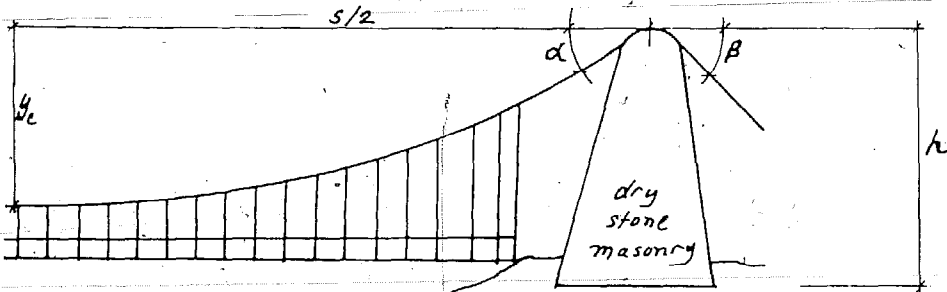

$y_c = 3$  meters at dead load

$S = 50$  meters

dead load = 35 kg/m

full load = 200 kg/m

$\mu = .1$  [coeff of friction for steel saddle]

$\beta = 30^\circ$

$h = 4.8$  meters

cable = 4, 19 mm 6x7 fiber core cable

$A_{cable} = 4 \times 138.7 = 554.8 \text{ mm}^2$

$E_{cable} = 10.5 \text{ tonne/mm}^2$  [Modulus of Elasticity]

tower width = 3.0 meter

(Continued from above)

Equation 7a is conservative in that it neglects the weight of the masonry structure but unconservative in that the total reaction force on any horizontal cross section of the structure should be sufficiently removed from the edge (not just within the edge) of the section so as to meet wall design criteria necessary to prevent overloading the structure.

Herbert Rice

Design Example 1

Type 2 Tower without Wooden Towers

step 1 Determine  $\alpha$ , forestay angle, under full load

$$\text{initial cable length} = l_i = s \left( 1 + \frac{\theta}{3} \frac{y_c^2}{s^2} \right)$$

$$\text{initial cable tension} = T_i = \frac{W s^2}{8 y_c}$$

the iterative equation, described page , is used to compute the cable tension under full load.

$$T_f + \frac{l_i - s}{P} - T_i = \frac{W^2 s^3}{24 P T_f} \frac{1}{T_f}$$

$$P = l_i / A E_c$$

The final cable tension will be solved for a live loading of 200 kg/meter:

$$P = \frac{50.48}{554.8 \times 10.5} = 0.008665 \text{ meter/tonne}$$

$$T_f + \frac{50.48 - 50}{0.008665} - 3.645 = \frac{(0.20)^2 50^3}{24 (0.008665) T_f^2}$$

$$T_f = \sqrt{\frac{2.4043 \times 10^4}{T_f + 51.75}}$$

solving for

$$T_f = 18.5 \text{ tonne}$$

the corresponding  $k$ , sag ratio, and forestay angle can now be solved for:

$$y_c = \frac{W s^2}{8 T_f} = \frac{200 (50)^2}{8 (18.5)} = 3.38 \text{ meter}$$

$$K = \text{sag ratio} = y_c / s$$

$$= \frac{3.38}{150} = 0.0676$$

$$\alpha = \text{forestay angle} = \tan^{-1}(4K)$$

$$= \tan^{-1}(4 \times 0.0676) = 15.13^\circ$$

step 2 Determine the ratio of H, horizontal force, to N, normal force, at the top of the tower

$$\alpha = 15.13^\circ$$

$$\beta = 30.0^\circ$$

$$\frac{H}{N} = \frac{\cos(15.13) [1 + .1 \sin(30)] - \cos(30.0) [1 - .1 \sin(15.13)]}{\sin(30) + \sin(15.13)}$$

$$= 0.2236$$

$$\tan \phi = H/N, \quad \phi = \tan^{-1}(H/N) = \tan^{-1}(0.2236)$$

$$\phi = 12.60^\circ$$

step 3 Determine minimum dimension, d

$$d_{min} = h \cdot \tan \phi$$

$$= 4.6 \tan(12.60) = 1.03 \text{ meter}$$

step 4 Set final proportions for tower-anchor

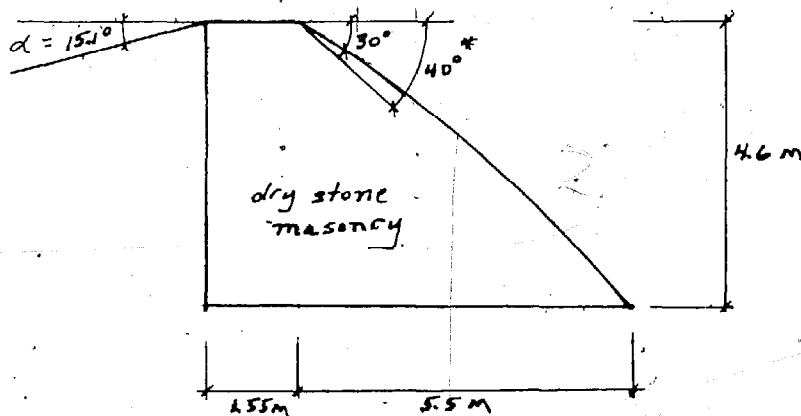

Assuming that the cable can be gradually curved as shown above, the tower volume is

$$V_{total} = 1.55 \times 4.6 \times 3 + 5.5 \times 4.6 \times 3 \times \frac{1}{2}$$
$$= 59.34 \text{ meter}^3$$

\*The 10% increase in the backstay angle was noted on the Inwa Khola Bridge, I 5.

Design Example 2

Type 2 Tower with Wooden Towers

step 1 Determine forestay angle,

Since the cable is supported by wooden towers the angle  $\alpha$  remains horizontal as the bridge is loaded. This means it is constant and equal to zero independent of the loading.

step 2 Determination of  $H/N$  and  $\phi$

$$\frac{H}{N} = \frac{\cos 0 (1 + 1.5 \sin 30) - \cos 30 (1 - 1.5 \sin 0)}{\sin 30 + \sin 0}$$

$$= 0.368$$

$$\phi = \tan^{-1}\left(\frac{H}{N}\right) = \tan^{-1}(0.368)$$

$$= 20.20^\circ$$

step 3 Determination of  $d$

$$d_{min} = h \tan \phi = 4.6 \tan(20.20^\circ)$$

$$= 1.69 \text{ meters}$$

step 4 Final proportions:

$$d = 1.5 (1.69) = 2.55$$

(rounded to 5 cm)

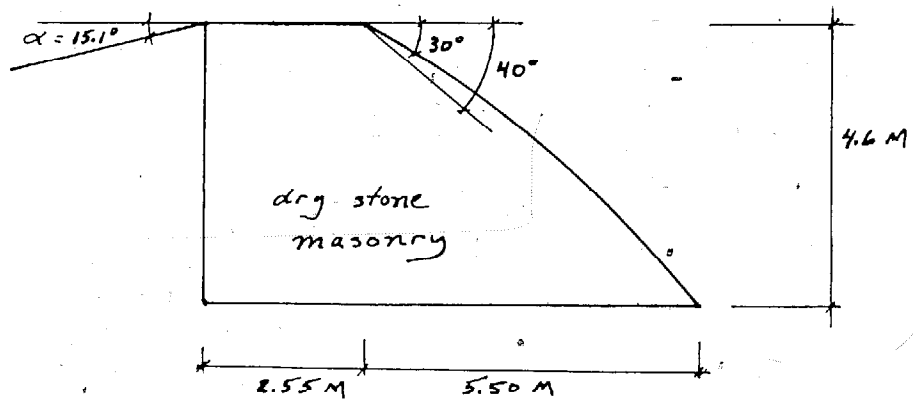

$$V_{\text{total}} = 2.55 \times 3 \times 4.6 + 5.5 \times 3 \times 4.6 \times \frac{1}{2} = 73.14 \text{ meter}^3$$

Design Example 3

Type 1 Tower with Modifications

From example 1 the following values are the same:

- $\alpha = 15.13^\circ$
- $H/N = 0.2236$
- $\phi = 12.60^\circ$
- $d_{min} = 1.03 \text{ meter}$

Masonry Tower Proportions:

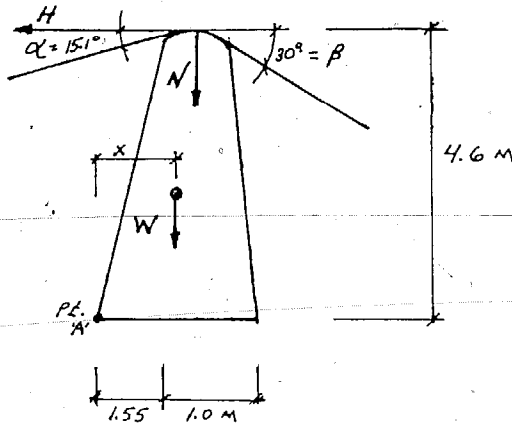

$$V = 1.05 \times 4.6 \times 3 \times \frac{1}{2} + 1.0 \times 4.6 \times 3 + .5 \times 4.6 \times 3 \times \frac{1}{2}$$

$$= 24.5 \text{ meter}^3$$

Overturning:

Volume tower = 24.5 m<sup>3</sup>,  $W = 2.3 \times 24.5 = 56.4 \text{ tonne}$

solve for x:

$$x = \frac{3(.666 \times 1.05) + .5 + 333 \times .5}{3}$$

$$x = 0.92 \text{ meter}$$

solve for N and H:

$$H/N = 0.2236$$

$$T_b = T_f \left( \frac{1 - \mu \sin \alpha}{1 + \mu \sin \beta} \right)$$

$$= T_f \left( \frac{1 - 0.13 \sin 15.13}{1 + 0.13 \sin 30.0} \right)$$

equation 3.

$$T_b = 0.9275 T_f$$

$$H = \cos \alpha T_f - \cos \beta T_b$$

equation 4.

$$= \cos \alpha T_f - 0.9275 \cos \beta T_f$$

$$= \cos(15.13) T_f - 0.9275 \cos(30) T_f$$

$$H = 0.1621 T_f$$

$$N = \sin \alpha T_f + \sin \beta T_b$$

$$= \sin \alpha T_f + 0.9275 \sin \beta T_f$$

$$= \sin(15.13) T_f + 0.9275 \sin(30) T_f$$

$$N = 0.7247 T_f$$

$$T_f = 18.5 \text{ tonne so,}$$

$$H = 0.1621 (18.5) = 3.0 \text{ tonne}$$

$$N = 0.7247 (18.5) = 13.4 \text{ tonne}$$

taking moments around pt. A' :

$$\text{overturning moment} = h \times H$$

$$= 4.6 \times 3.0$$

$$= 13.8 \text{ tonne-meter}$$

$$\text{resisting moment} = x \cdot W + 1.55 \times N =$$

$$= 0.92(56.4) + 1.55(13.4)$$

$$= 72.66 \text{ tonne-meter}$$

$$\text{safety factor against overturning} = \frac{72.7}{13.8}$$

$$= 5.3 > 2.0$$



Anchor Size Determination

$\beta = 30^\circ$   
 $S_{mas.} = 2.3 \text{ tonne}$   
 $T_{max} = 18.5 \text{ tonne (Ex. 1)}$   
 $\mu = .55 \text{ (coefficient of friction)}$

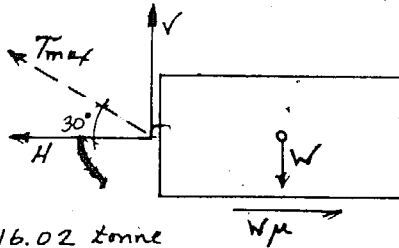

$H = T_{max} \cos \beta = 18.5 \cos(30) = 16.02 \text{ tonne}$   
 $V = T_{max} \sin \beta = 18.5 \sin(30) = 9.25 \text{ tonne}$   
 $H = 16.02 \text{ tonne}$   
 $V = 9.25 \text{ tonne}$

$W_{req.} = V + H/\mu = 9.25 + 16.02/0.55$   
 $= 38.37 \text{ tonne}$

Volume required  $= \frac{38.37}{2.3} =$   
 $= 16.68 \text{ m}^3$

Total tower + anchor Volume  $= 24.5 + 16.7$   
 $V_{total} = 41.2 \text{ m}^3$

Design Example 4

Type 1 Tower with modification and stone saddle

stone-cable coefficient of friction assumed to be .4

$\alpha = 15.1^\circ, \beta = 30^\circ$

$H/N$  and  $\phi$  must be recalculated:

$\frac{H}{N} = \frac{\cos 15.1(1 + .4 \sin 30) - \cos 30(1 - .4 \sin 15.1)}{\sin 30 + \sin 15.1}$   
 $= 0.503$

$\phi = \tan^{-1}(0.503) = 26.7^\circ$

$d_{min} = h \tan \phi = 4.6 \tan 26.7$   
 $= 2.31 \text{ meters}$

$d = 1.5(2.31) = 3.47 \text{ meters}$

$V_{lower} = 3.0 \times 4.6 \times 3 \times \frac{1}{2} + 1 \times 4.6 \times 3$   
 $+ 5 \times 4.6 \times 3 \times \frac{1}{2}$   
 $= 37.9 \text{ m}^3$

$V_{total} = 37.9 + 16.7 = 54.7 \text{ m}^3$

(assume same anchor block as example 3.)

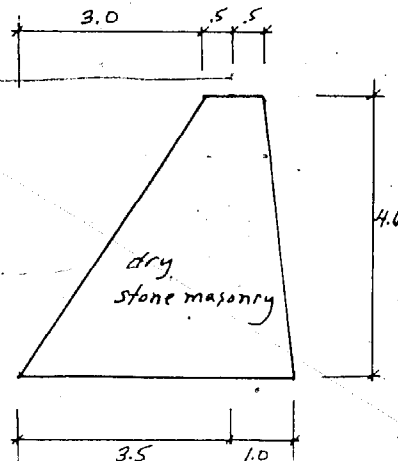

C. Discussion

The results of the first 3 design examples indicate that the modified type 1 tower and anchor system is the most efficient in the use of stone for the 50 meter span bridge given the previously listed initial conditions. The type 2 tower-anchor system with wood towers required the highest volume of dry stone masonry, 73.1 m<sup>3</sup>. The type 2 tower without wood towers required 59 m<sup>3</sup>. The modified type 1 tower and anchor only required 41.2 m<sup>3</sup>. This means that the modified type 1 tower and anchor is 30 % more efficient than the type 2 tower-anchor without wood towers and 44 % more efficient than the type 2 tower-anchor with wood towers.

The use of wood towers in front of the type 2 masonry tower leads to an excessive volume of stone masonry relative to the other tower types considered. The ratio of the horizontal force to the vertical force for the type 2 tower with wood towers in the design examples was 0.37, while the type tower without wood towers had a ratio of 0.22. The higher horizontal component of force for the type 2 tower anchor with wood towers means more masonry is required ahead of the saddle in order for the resultant cable force to be kept within the tower base when the bridge is fully loaded.

Design examples 3 and 4 show the importance of the cable-saddle coefficient of friction. The type 1 tower with a stone saddle required 54.7 m<sup>3</sup> of dry stone masonry, compared to the type 1 tower with a steel saddle, which required 41.2 m<sup>3</sup>. With all variables held constant, the tower with the stone saddles required 25 % more dry stone masonry than the tower with steel saddles.

The following conclusions were reached for the design examples studied:

1. The separate tower-anchor system uses less masonry volume than the combined tower-anchor system.
2. The use of wood towers in front of a combined tower-anchor leads to a higher volume of masonry than without the wood towers.
3. A tower with a steel saddle requires less stone masonry than one with a stone saddle due to the lower coefficient of friction of the steel.

of the above conclusions apply only to the specific design examples considered but it is suspected that they hold true in general, independent of the initial conditions. (Here the initial conditions are the given sag ratio, span, dead load, live load, tower height, tower width, coefficient of friction of the saddle, bearing area, cable Modulus of Elasticity, forestay angle and back-angle).

The details were not considered in the design examples. It is recommended that some cement be used in the top of the tower to transfer the cable load to the dry stone masonry below. A suitable solution is shown here:

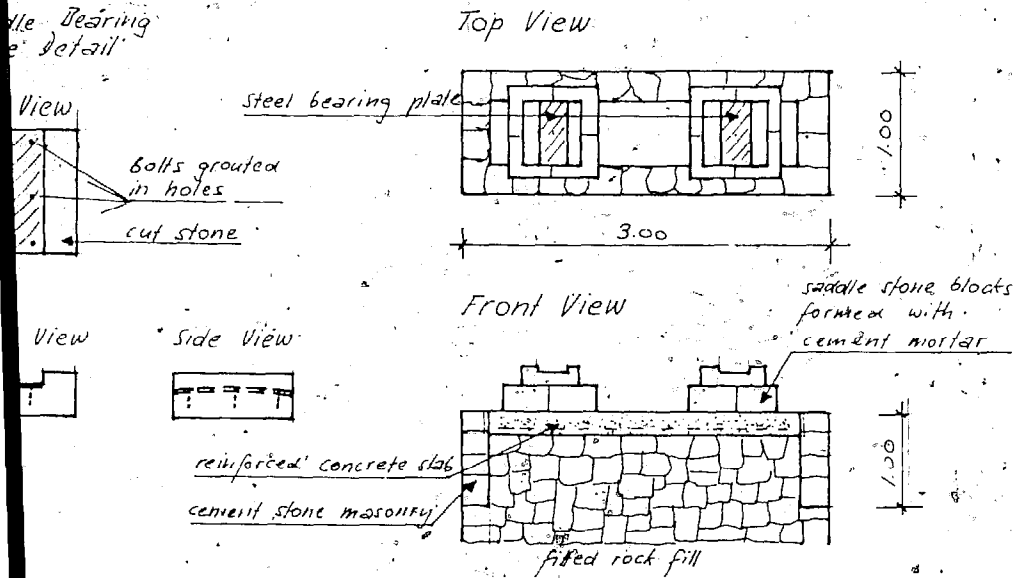

ables rest on stone blocks which distribute the load to a reinforced concrete slab. In this design a steel bearing plate is used by grouted bolts to the stone saddle block. Local persons experienced in stone carving so the cutting of the stone should be no problem. Reinforcement both on the bottom of slab and under the saddle stones is suggested.

local manual the modified type 1 tower and anchor dimensions be worked out for different spans so that the towers have sufficient safety factor against a worst case loading and geometry. Worst case, for example, might be for a high backstay angle  $45^\circ$  and a live load of  $300 \text{ kg/m}^2$ .

Appendix V

Suggested Guidelines for Design Loading

The following are suggested guidelines for design loadings of local bridges and allowable stress (or, synonymously, working stress) of materials. The allowable stress method is assumed to be used as a basis for bridge design. In this method structures are designed so that the actual stress under the condition of design loading does not exceed the specified allowable stress. Design loadings should realistically reflect the expected bridge traffic and should not be multiplied by a safety factor.

A. Design Live Loads

Some possible worst case loadings are considered below:

Case 1 Bridge fully loaded with porters.

Assume: 1 porter weighs 65 kg  
1 porter carries 100 kg  
Total 165 kg

porter density = 1 porter/m<sup>2</sup>  
= 165 kg/m<sup>2</sup>

Case 2 Bridge packed with unloaded people.

Assume: 1 person weighs 65 kg

person density = 4 persons/m<sup>2</sup>  
= 260 kg/m<sup>2</sup>

Case 3 Bridge filled with large water buffaloes.

Assume: 1 buffalo weighs 300 kg

buffalo density = 1/2 buffalo/m<sup>2</sup>  
= 150 kg/m<sup>2</sup>

The second case creates the highest live loading situation. It is possible to place more than 4 porters per square meter but highly unlikely. If six 65 kg persons stood every square meter of a bridge, 390 kg/m<sup>2</sup> live load could be reached. SBD recommends 400 kg/m<sup>2</sup> for the live load. This represents a very high loading and has a low probability of occurrence. For example, in order to load fully a 50 meter bridge with a meter wide walkway, over 300 persons each weighing 65 kg would have to stand on the bridge at one time. SBD reduces the per square meter loading for spans above 100 meter according to the following equation:

$$Q = 400 - \frac{1}{2} ( S - 100 ) , \quad S > 100 \text{ meters } ( Q \text{ in kg/m}^2 )$$

This equation reflects the decreasing probability of having a full load condition with increasing spans. Perhaps an equation similar to this should be developed for local bridges starting at a shorter span length.

A second design live load could be used for local bridge building. A live load of 300 kg/m<sup>2</sup> is suggested. This represents a realistic yet conservative loading condition. It is also suggested that reductions in the per meter live load with decreasing walkway width be permitted only up to a load of 150 kg/m and not beyond that. The following graph shows the suggested linear live loads for the walkway width:

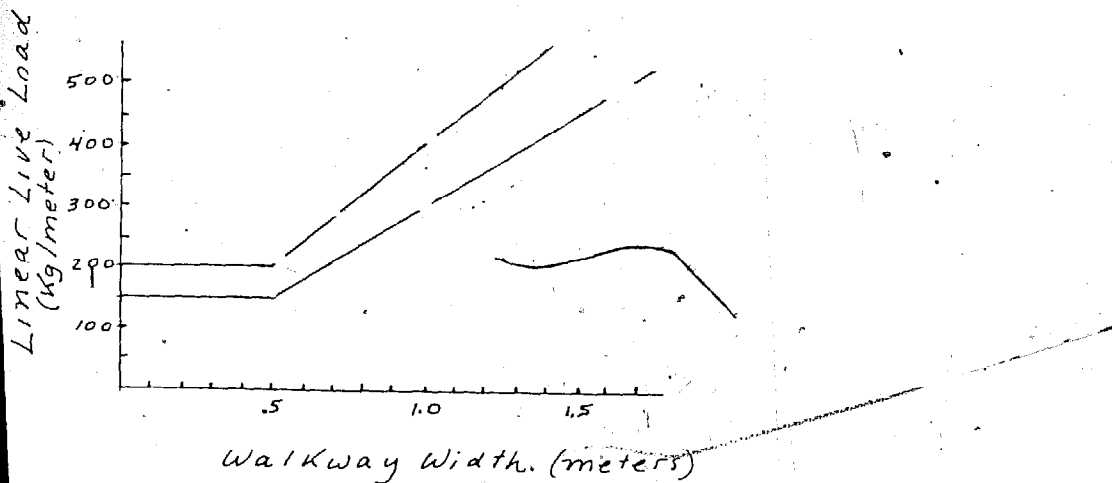

A load of 150 kg/m for narrow walkways represents a case where two persons are standing per meter across the entire span.

### B. Point Loads

The following are possible point loading conditions:

case 1 Loaded porter stepping with entire weight on one foot:

Assume: 1 porter weighs 65 kg  
1 porter carries 100 kg  
total porter load 165 kg

case 2 Water buffalo stepping on one point with half of its weight:

Assume: 1 buffalo weighs 250 kg  
total point load  $\frac{250}{2} = 125$  kg

case 3 Loaded pack animal stepping on one point with half of its weight:

Assume: 1 mule weighs 150 kg  
1 mule carries 100 kg  
total mule load 250 kg  
total point load  $\frac{250}{2} = 125$  kg

A 165 kg point load of a porter with a heavy load is the worst case considered. It is suggested that all bridge walkway be designed to support at least a point load of 165 kg. A loaded porter will try to cross almost any bridge if possible.

### C. Working Stress of Materials

The Indian Civil Engineering Handbook (ICEHB) gives the allowable stress for most of the materials used in bridge building.

#### 1. Wood (ICEHB, page 9/28)

Sal:

allowable bending stress = 140 kg/cm<sup>2</sup> (outside location)  
allowable shear stress parallel to grain = 9.4 kg/cm<sup>2</sup>  
allowable shear stress perpendicular to grain = 13.4 kg/cm<sup>2</sup>

Blue Pine:

allowable bending stress = 56 kg/cm<sup>2</sup> (outside location)  
allowable shear stress parallel to grain = 5.6 kg/cm<sup>2</sup>  
allowable shear stress perpendicular to grain = 8.0 kg/cm<sup>2</sup>

es [ICEHB, page 4/12 and 4/35]

allowable tensile stress = 7.5 tons/in<sup>2</sup> = 1,051 kg/cm<sup>2</sup>

allowable bearing stress = 10 tons/in<sup>2</sup> = 1,409 kg/cm<sup>2</sup>

allowable shear stress = 5 tons/in<sup>2</sup> = 704 kg/cm<sup>2</sup>

areas of different diameter bolts minus the threads is  
given on page 4/35, ICEHB.

1\_parts [ICEHB, page 10/3]

allowable tensile stress untested steel = 1,260 kg/cm<sup>2</sup> (bending)

allowable tensile stress tested steel = 1,650 kg/cm<sup>2</sup> (bending)

allowable tensile stress tested steel = 1,500 kg/cm<sup>2</sup> (axial)

allowable shear stress untested steel = 800 kg/cm<sup>2</sup>

allowable shear stress tested steel = 1,100 kg/cm<sup>2</sup>

s

Handbook by USHA Martin Black Wire Ropes Ltd of Calcutta

gives the ultimate tensile stress of cable strand as 160 kg/mm<sup>2</sup>.

and other sources suggest an allowable working stress of

one third of the ultimate, 54 kg/mm<sup>2</sup>. The steel areas of

different diameter and construction cables are listed in the

annual and handbooks put out by cable manufactures.

Stress-strain curves are available for the cables

commonly used in Nepal perhaps the working stress range

could be set for each cable independently. It might be found

that taking one third of the ultimate breaking strength is

conservative and a safety factor of as low as 2.0 is

possible.

#### Guidelines for Foundations

It is suggested that safety factor of 1.5 should be used for anchor

foundations involving sliding and overturning in Part A

of the Bridge Manual, page 3.701. It also has been suggested

that the middle 1/3 rule be used in anchor block design. The

rule states that the resultant force of the anchor

and the cable force must fall in the middle 1/3 of

the block. Guidelines for foundation design should be further

developed for use in local bridges.

Appendix VI

Method for Preparing Local Lime - "Chuna"

---

Materials

- 8 dokos of limestone rock
- Wood
- Furnace, 3' x 3' x 5', made of stone masonry
- Water
- Clay water jug or tin
- Tonga, long metal type

Procedure

1. Break up limestone rock into pieces about 4 - 5 tolas in weight,  $\frac{1}{2}$ " x  $\frac{1}{4}$ " x  $\frac{1}{4}$ " approximately
2. The kiln should be built about 5 ft high and 3 ft on each side with a hole about 8" diameter about  $1\frac{1}{2}$  ft up from the ground. The wall should be built up 5 ft high with stones and mud.
3. Use firewood  $1\frac{1}{2}$  or 2 ft long and as thick as a man's arm. The firewood should be placed crisscross as shown on a flat rock serving as cover for the hole in the kiln. 
4. Put a layer of about 20 ser of the broken limestone on top of the firewood followed by another layer of firewood placed as described above and then another layer of about 15 ser of limestone. Layers of rock and wood should be 4 - 6" thick, with a total of 5 layers each.
5. After filling the kiln in the above manner put firewood on the top and light a fire at the bottom. After the firewood on top of the cover of the hole starts to burn, the fire at the bottom may be removed.
6. After about  $7\frac{1}{2}$  hours when the firewood has all burned, the limestone should be red in color just like glowing live coals. If not, then add more firewood. Let the limestone remain red for  $\frac{1}{2}$  hour, then remove the cover from the bottom of the kiln and the limestone will fall out.
7. Put about 1 pathi of water in a clay water jug or in a tin and add the limestone pieces by using steel tonga ('chinta). The limestone will dissolve with a hissing, gurgling sound. Add more water gradually.



8. Pour off the lime into another container. It should be the consistency of yoghurt ('dahi'). Any rock pieces remaining are not sufficiently burnt and should be returned to the kiln for reburning according to the above described process
9. Water must be added to the prepared lime in the tin or clay water jug. The lime should not be dried. If it dries, it gets hard like a rock and will not redissolve.
10. When used for making cement the lime should be the consistency of thick buttermilk ('mahi'). About 4 - 5 mana of somewhat coarse, red-type 'kuring' sand should be added and mixed to about 1 pathi of lime in order to make cement.

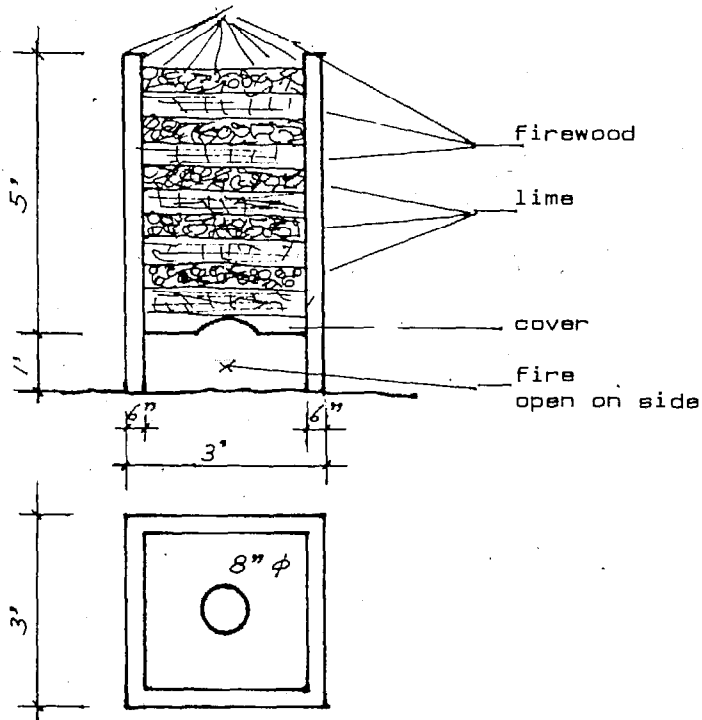

Note should be made that the weight unit of ser is not uniform throughout Nepal. Further research is necessary concerning the meaning of red-type 'kuring' sand. This is evidently not river sand.

The above described procedure was given by a local person and has not been tested by the authors of this report.

Appendix VII  
Photos and Drawings

A selection of photos not shown  
in the main body of the report.

Contents:

Overall View of Bridges  
Cables, Chains, Grips and Connection Details  
Walkways  
Towers and Anchors  
Details of Mewa Khola Bridge, I 6  
Bridge Ilam 2  
Details from other Ilam Bridges

Overall View of Bridges



12

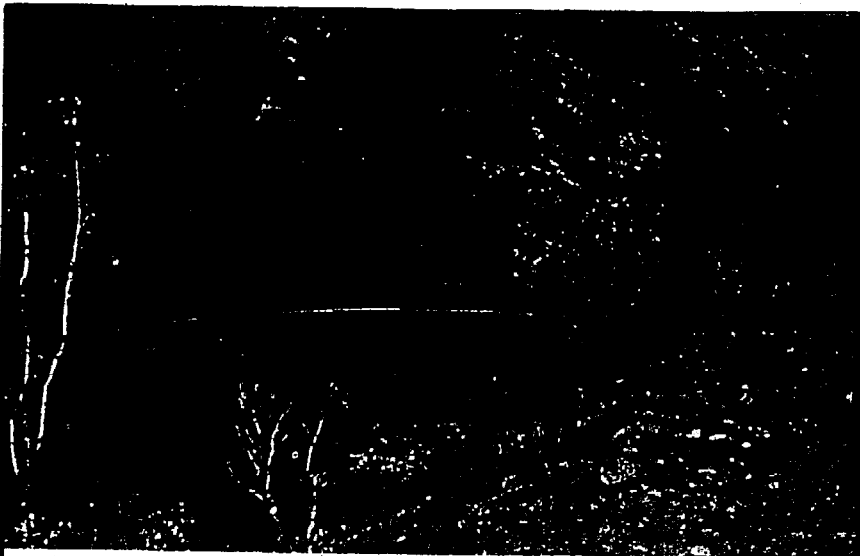

K7

Overall View of Bridges

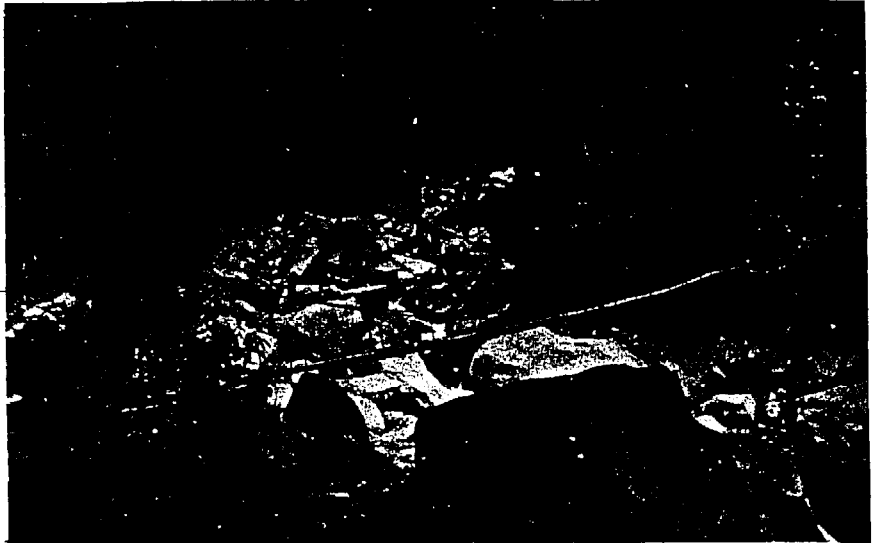

P1

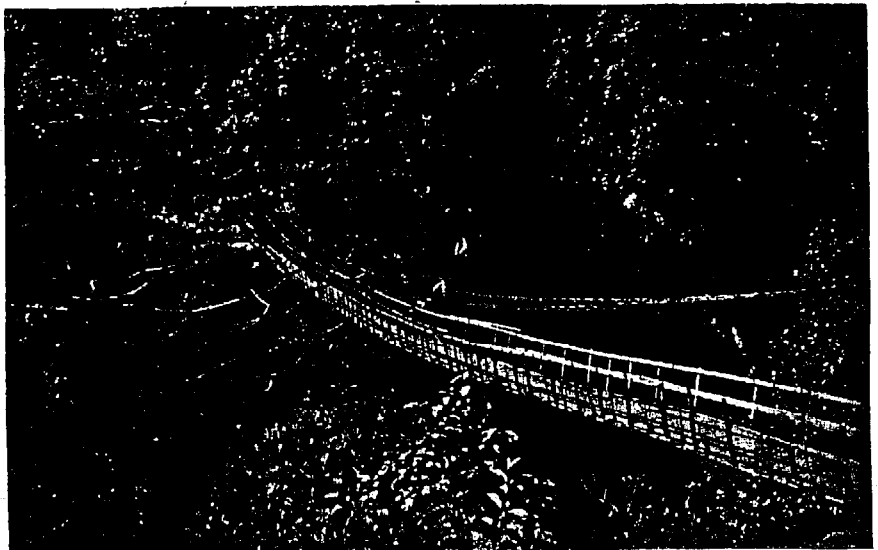

T



Overall View of Bridges



K1

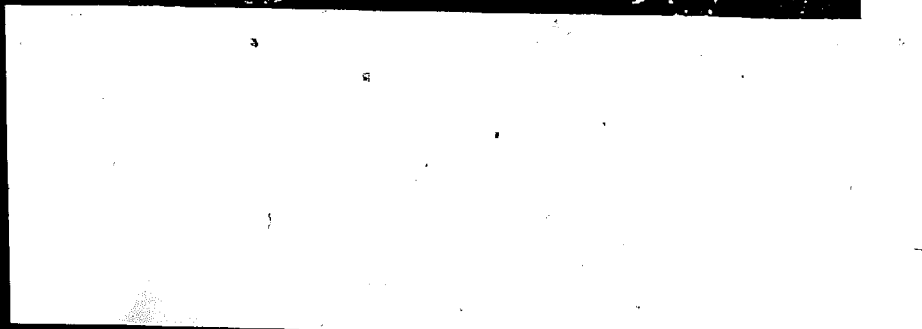

T7

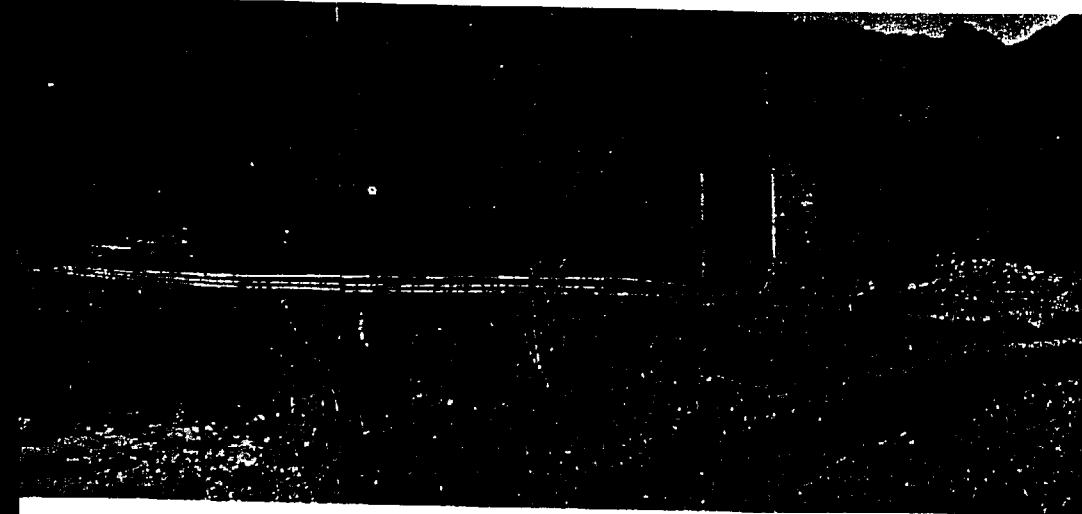

Cables, Chains, Grips and Connection Details



15

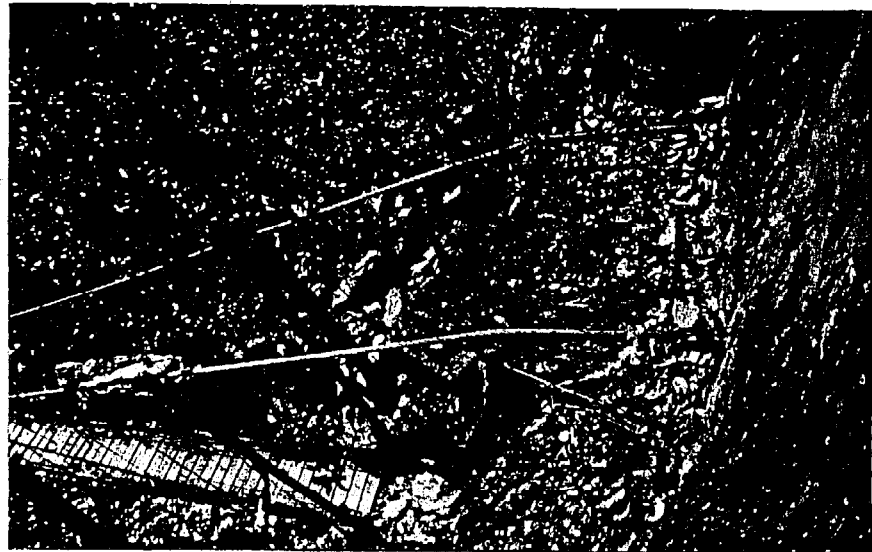

11

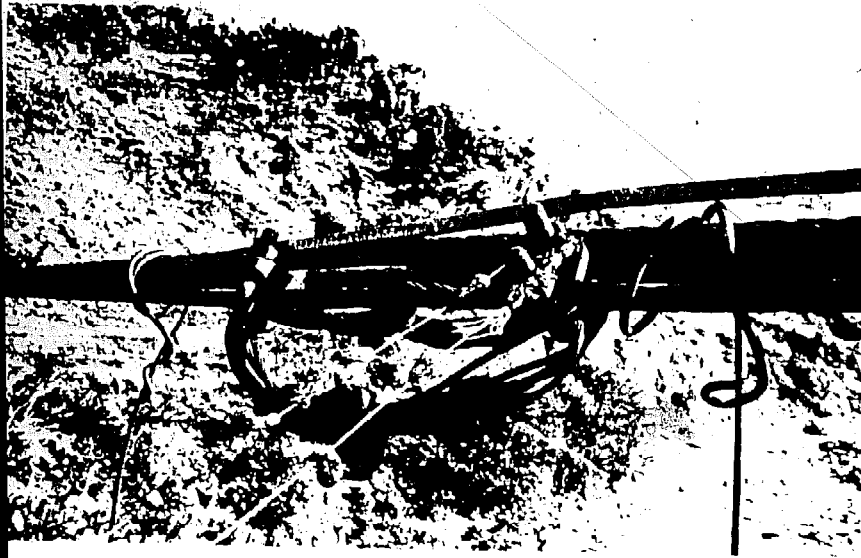

T7

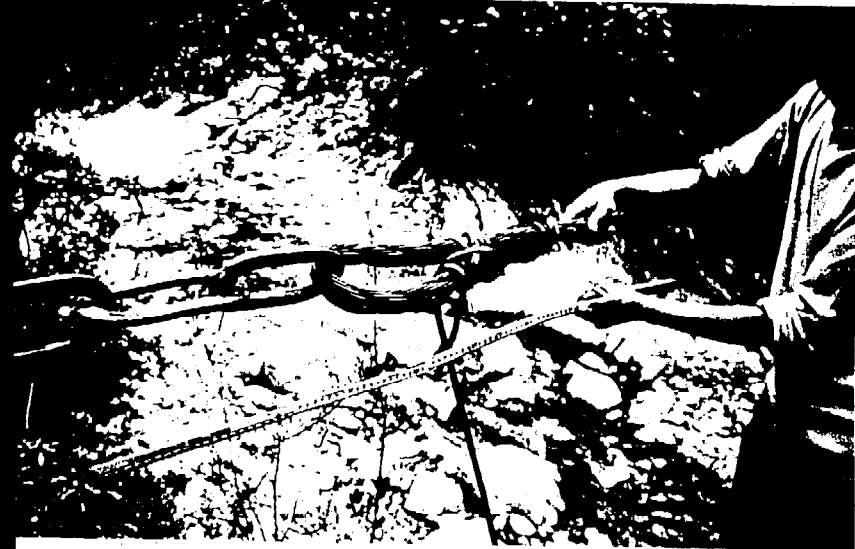

P2

Walkways

TJ

K1

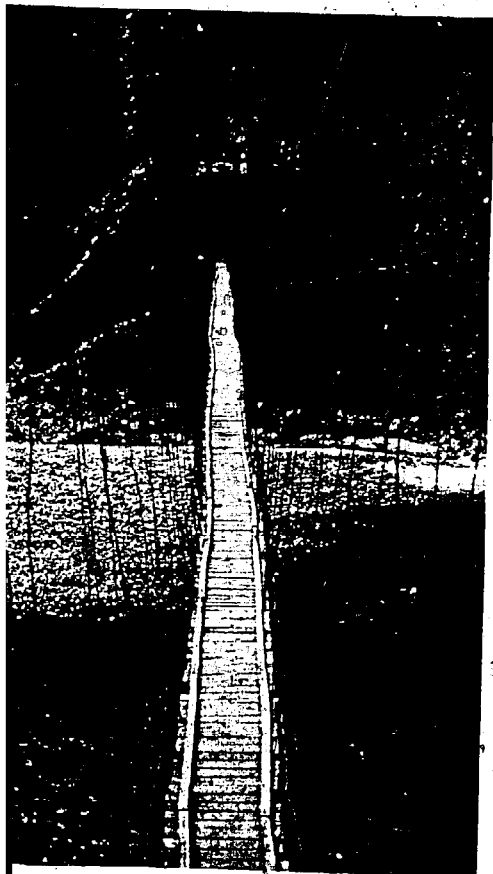



K5

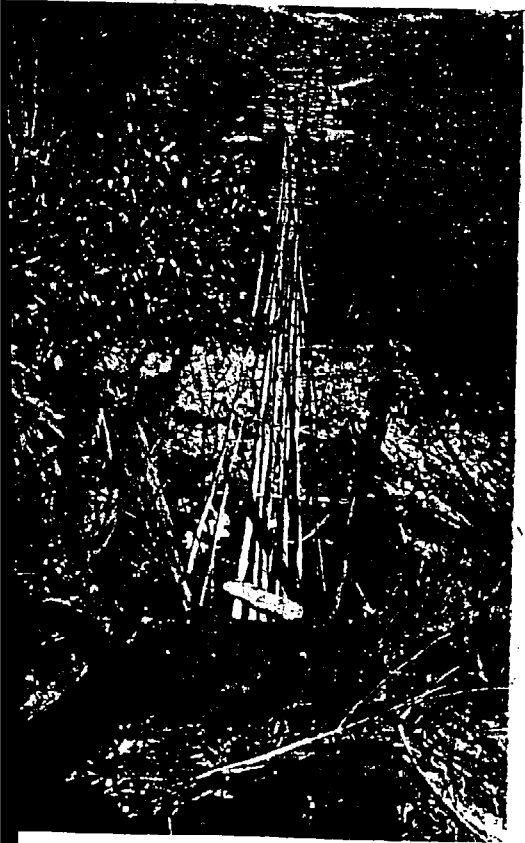



P1

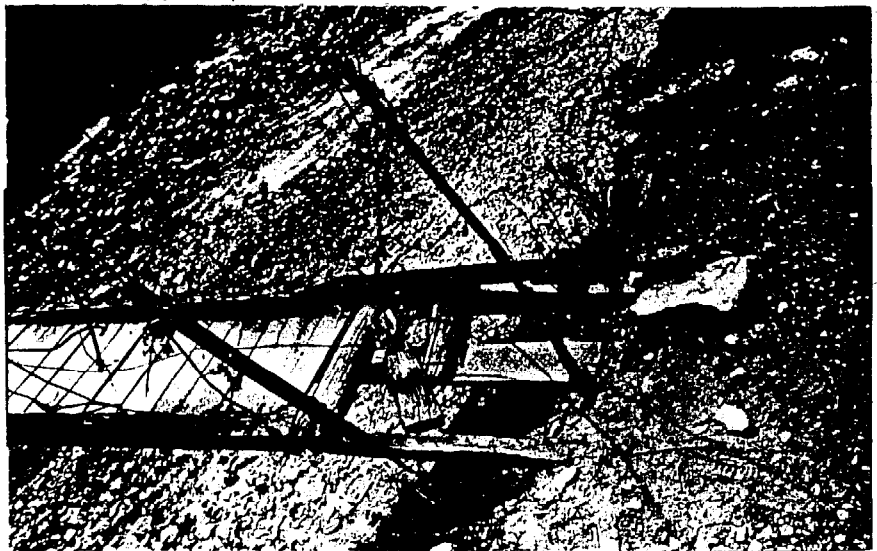

K1

Towers and Anchors

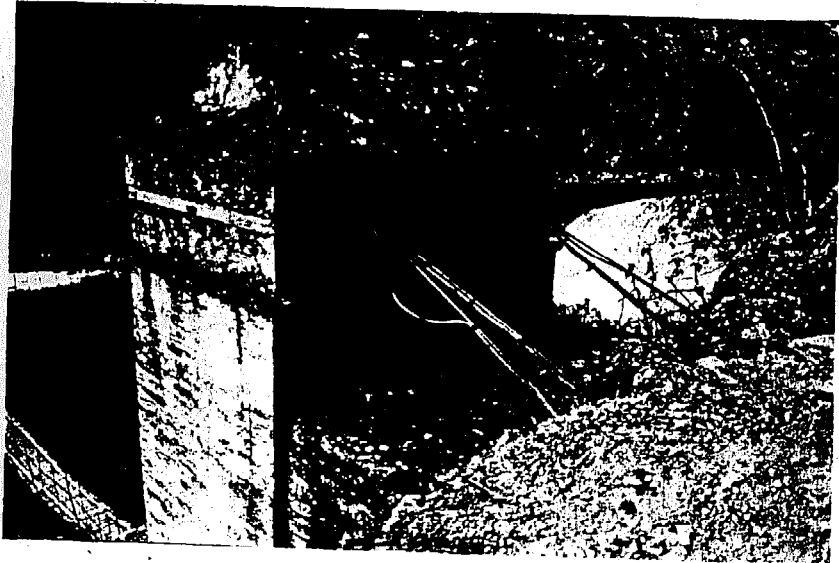

T1



T0

Details of Mewa Khola Bridge, I 6

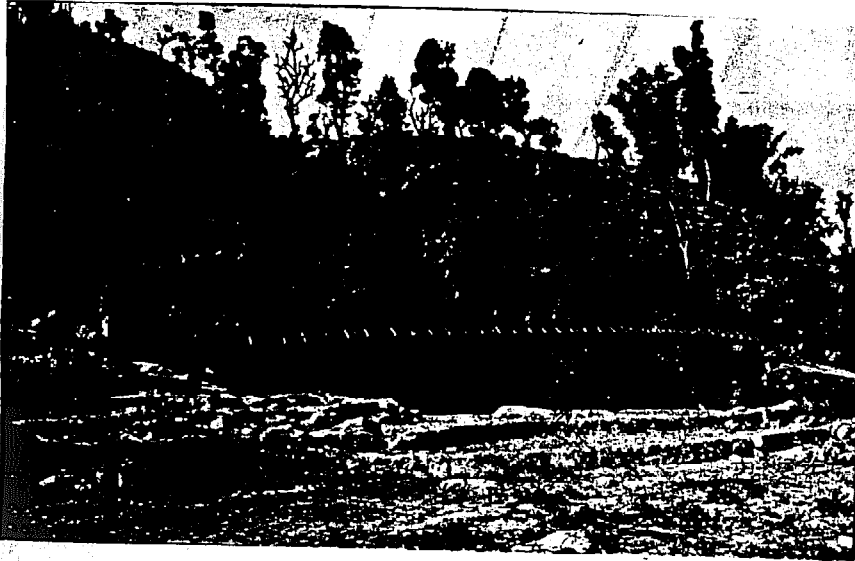

Overall View of the bridge

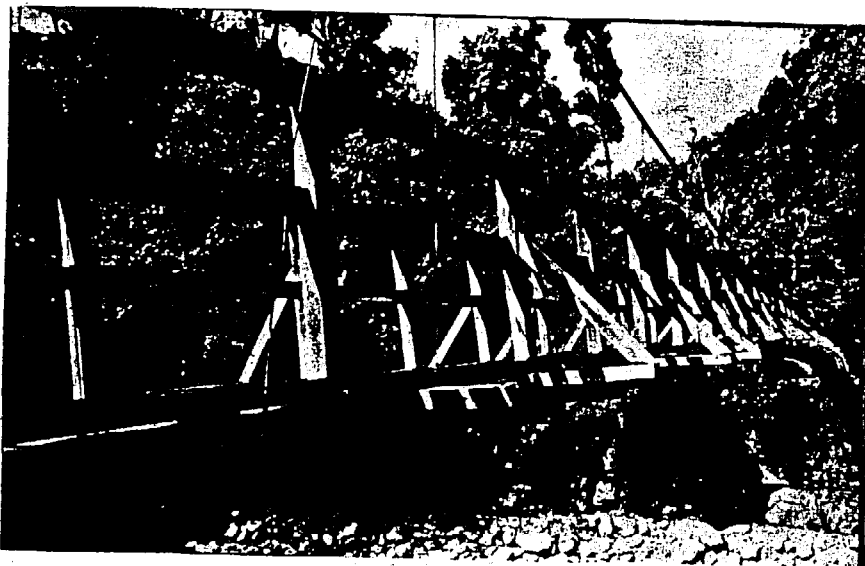

Walkway Construction

Bridge Ilam 2



Overall View of the Bridge



Left Bank Tower

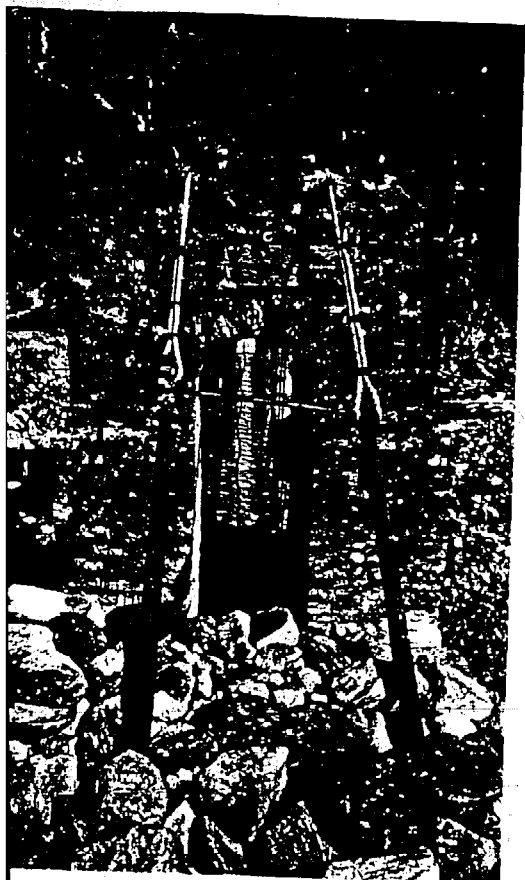

Bank Tower



Walkway,  
Right Bank Tower

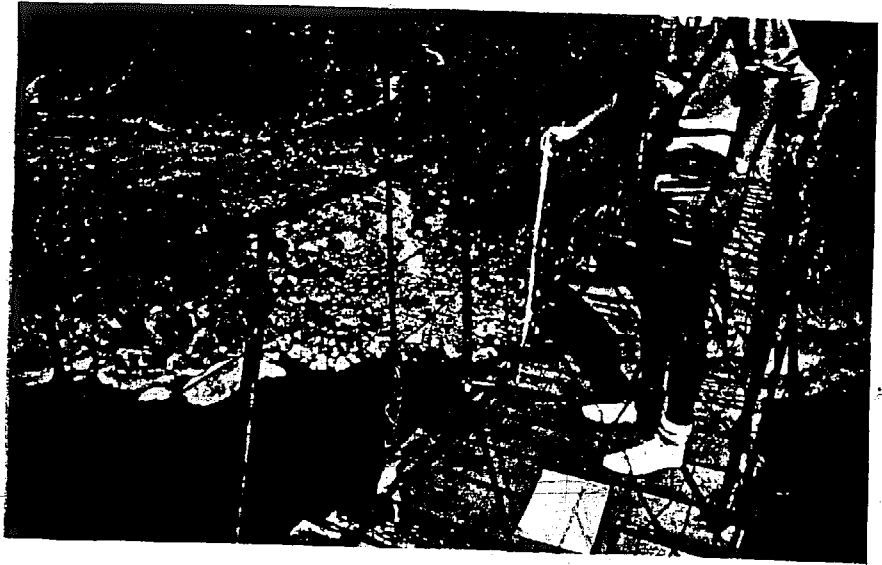

Suspender Rods, Fencing

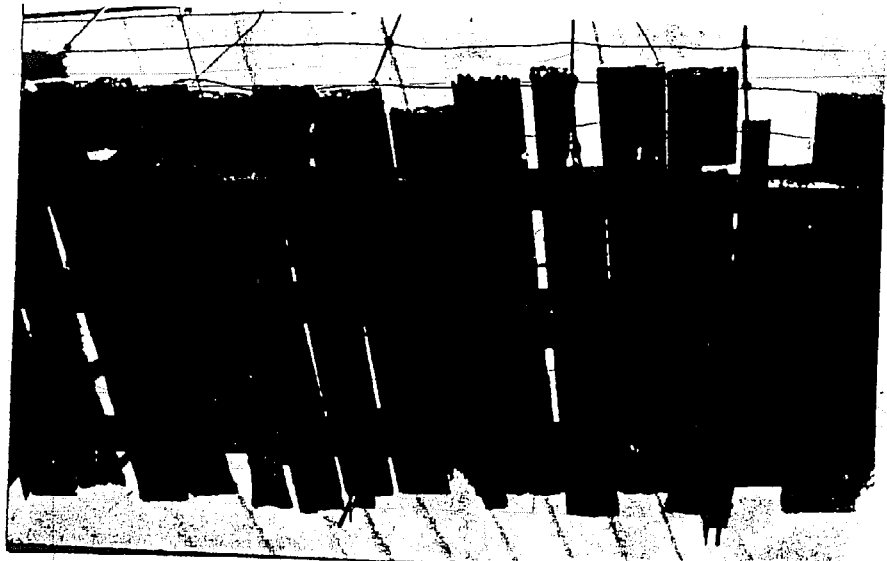

Walkway Construction

over Joakmi Khola

Ham 2

Side elevation 1:200

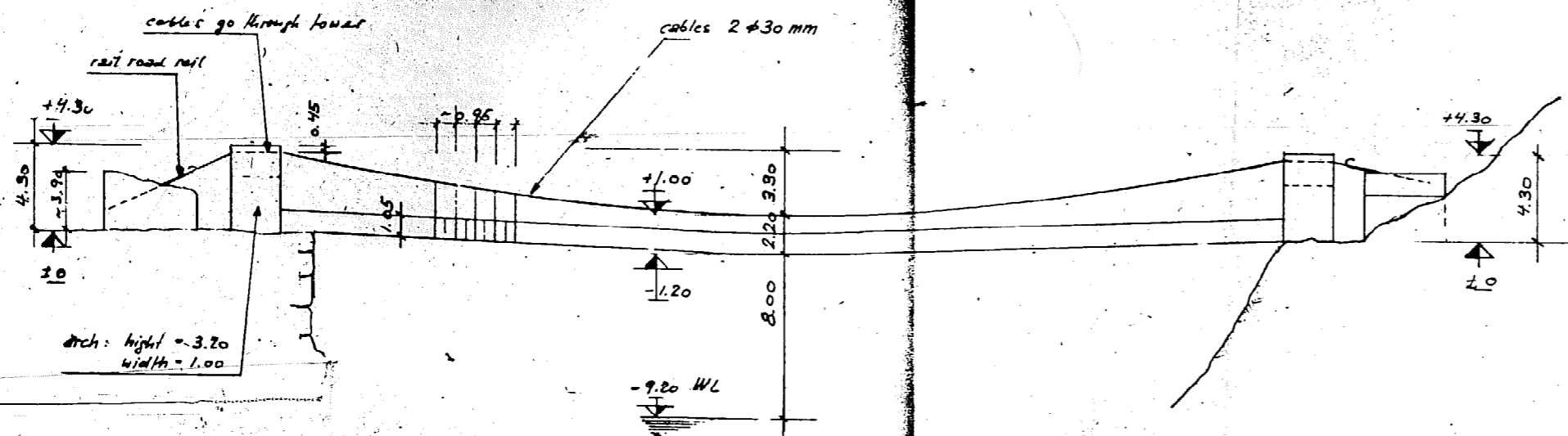

Plan

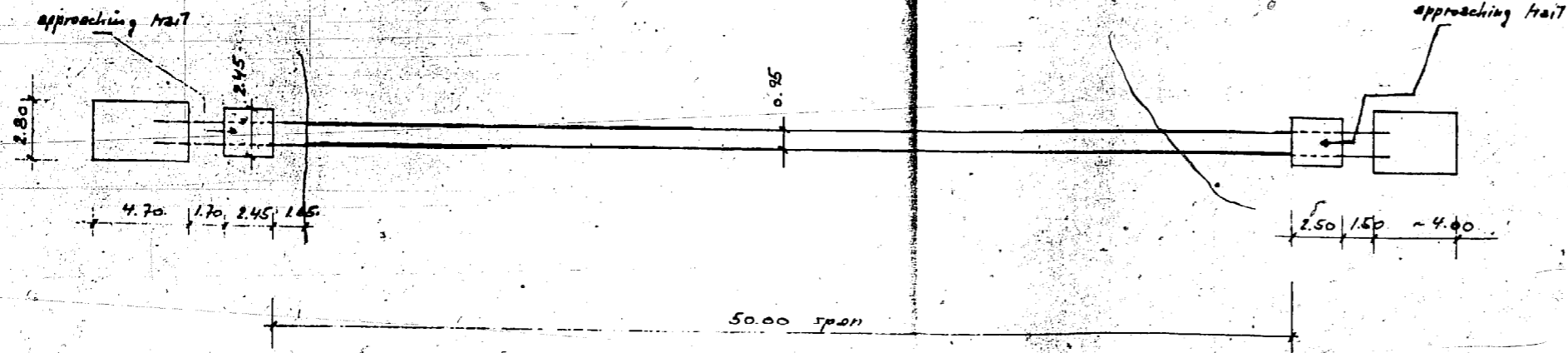

walkway, cross section 1:20

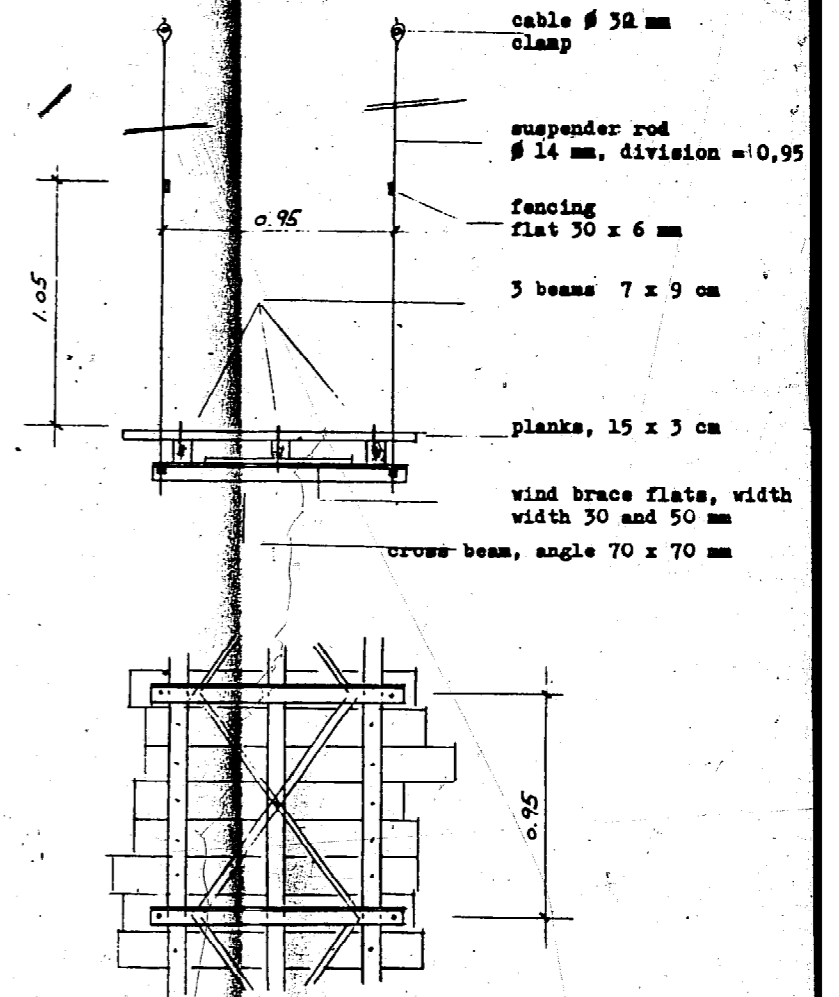



Details from other Ilam Bridges

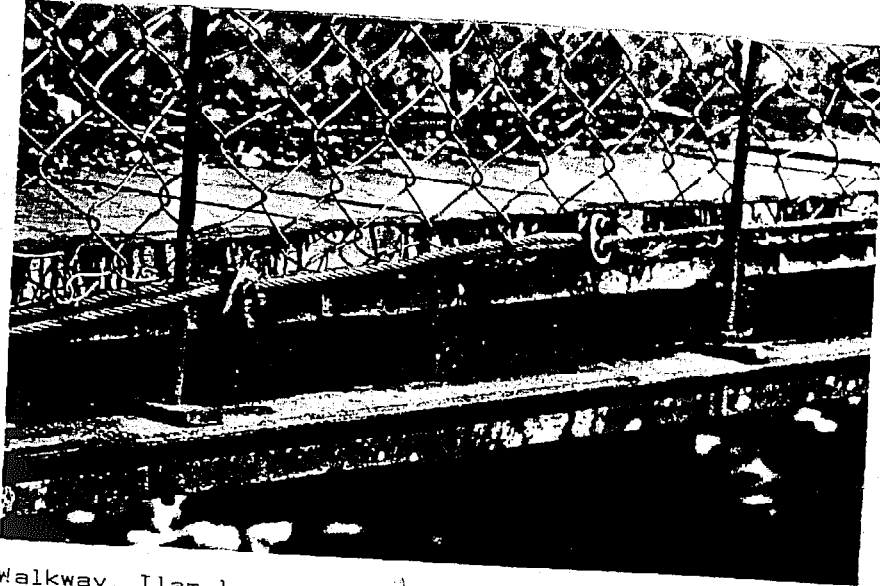

Walkway, Ilam 1

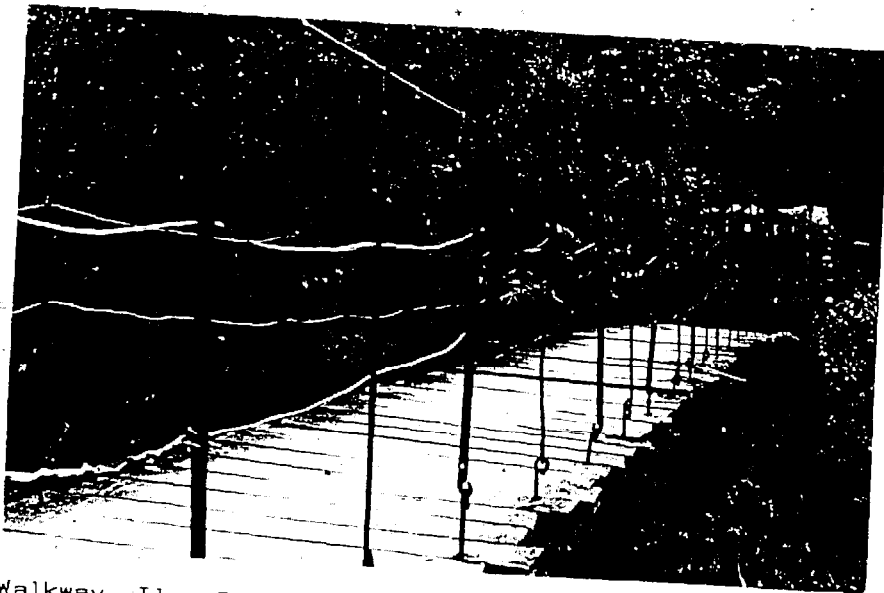

Walkway, Ilam 3



Walkway - Suspender Rod  
Connection, Ilam 3



Walkway - Suspender Rod  
Connection, Ilam 3



Cable Support Point, Item 1



Cable Clamp, Item 1

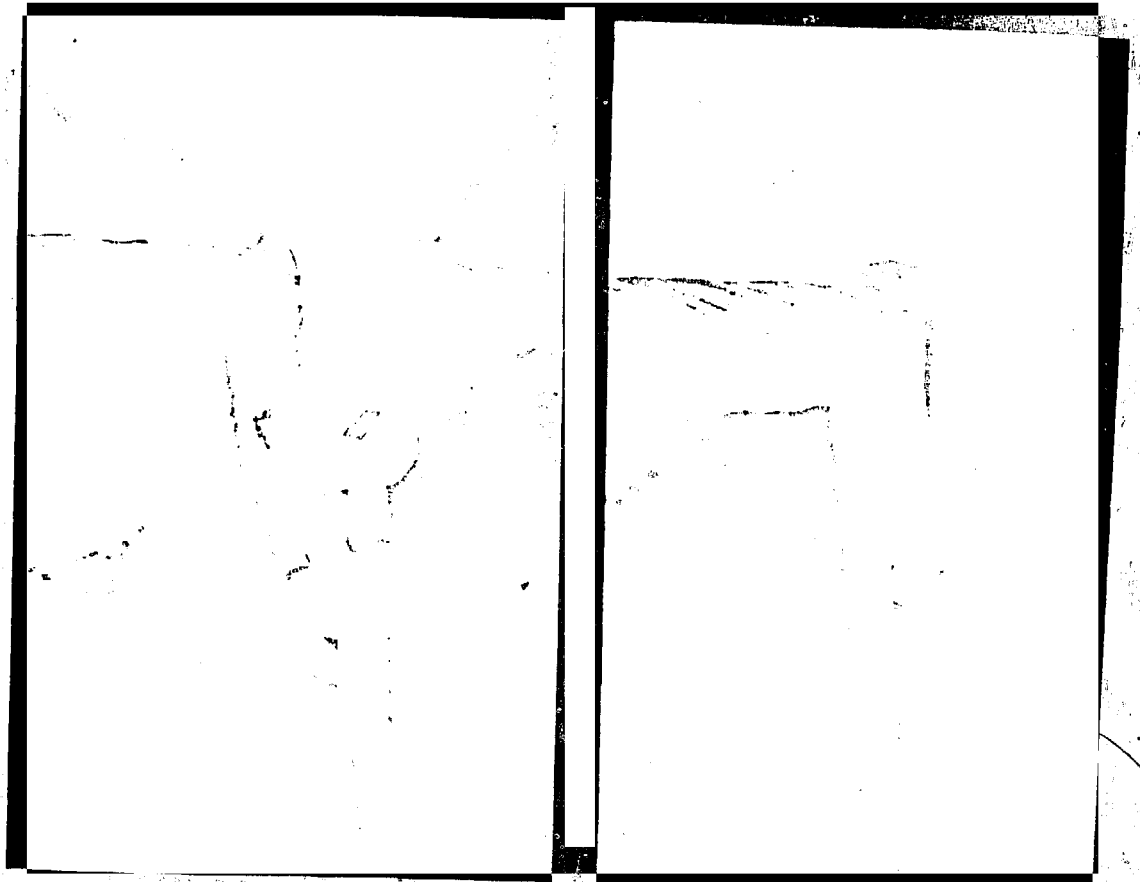

Cable - Suspender Rod Connections, Ilam 3

over Tamur

T/

span = 110.00 m

cables:  
upstream 1.4.17 mm  
down 1.4.22 mm

MALE WAY  
cross section 1:7.10

suspender rod  $\phi$  6 mm  
division 60 - 70 cm  
wrapped around main cable  
+ support flat  
hand rail cable  $\phi$  16 mm

every 3rd panel of the  
cross support flat is ex-  
tended up in order to  
support the handrail  
cable + fencing

beam  
beams 7 x 7 cm

cross support  
flat 50 x 10 / 900 mm

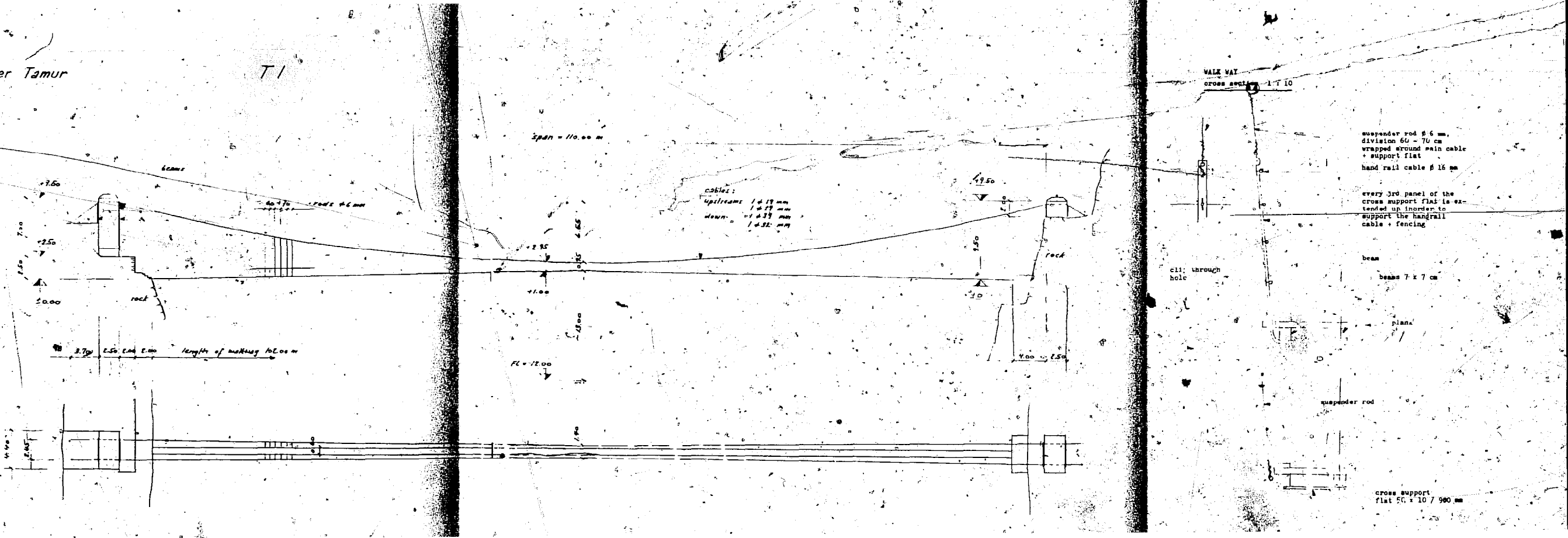

Tamar

T8

span 67.00 length of walkway 64.80

wooden cross beams on tower to help to distribute the shear force more evenly to the masonry.

cables wrapped around steel bars. Secured from sliding with 8 bulldog grip on each cable.

0.90 wire  $\phi$  6mm

cables 2  $\phi$  42mm

50

+5.00

+3.00

+2.00

+1.30

+0.30

8.00

2.00

~10.00

4.20

eroded bank

tower dry stone masonry, wooden towers in front

tower dry stone masonry wooden towers in front

hose clamp

19.00

FL ~ -19.00

3.20

1.50

0.80

1.50

2.20

3 wind ties, wire, fastened on suspenders

30.00

7.00

30.00

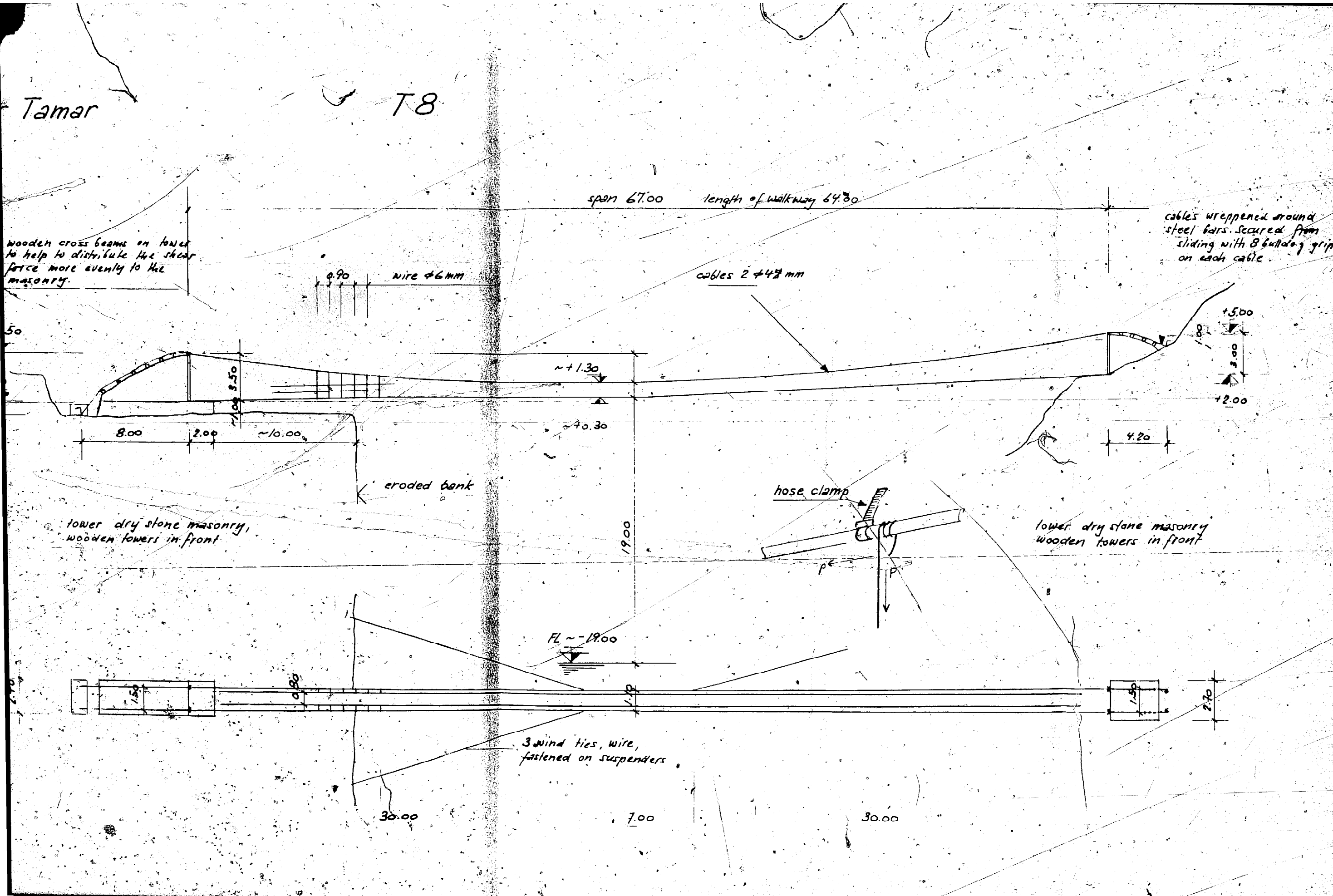

SUPPORT FLATS, TYPES  
cross section 1 : 10

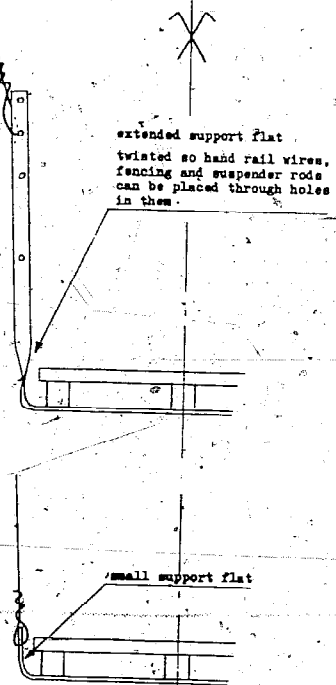

K1

WALK WAY  
cross section

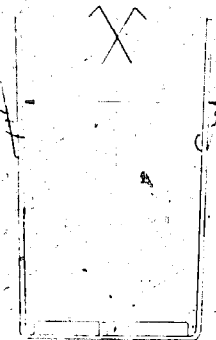

I2

wooden "clamp"  
joins longitudinal  
fencing  
neither clamp nor  
planks fastened  
to support flats

wooden "clamp" longitudinal planks nails

TWO SAMPLES OF 'REPAIRED' WALKWAYS

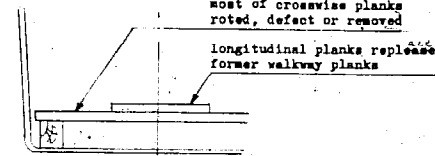

P1

K4, P3

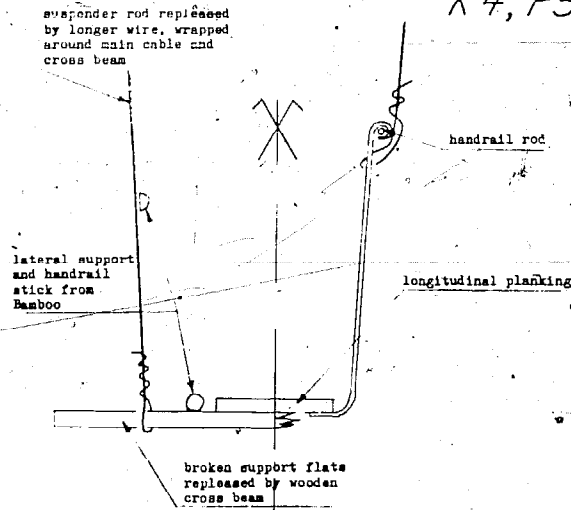

WALK WAY  
cross section 1 : 10

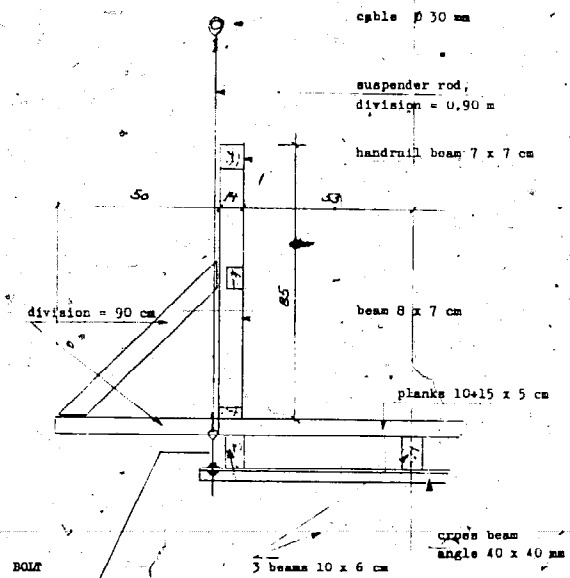

I6

cable φ 30 mm  
suspender rod,  
division = 0.90 m  
handrail beam 7 x 7 cm