



This is a digital copy of a book that was preserved for generations on library shelves before it was carefully scanned by Google as part of a project to make the world's books discoverable online.

It has survived long enough for the copyright to expire and the book to enter the public domain. A public domain book is one that was never subject to copyright or whose legal copyright term has expired. Whether a book is in the public domain may vary country to country. Public domain books are our gateways to the past, representing a wealth of history, culture and knowledge that's often difficult to discover.

Marks, notations and other marginalia present in the original volume will appear in this file - a reminder of this book's long journey from the publisher to a library and finally to you.

Usage guidelines

Google is proud to partner with libraries to digitize public domain materials and make them widely accessible. Public domain books belong to the public and we are merely their custodians. Nevertheless, this work is expensive, so in order to keep providing this resource, we have taken steps to prevent abuse by commercial parties, including placing technical restrictions on automated querying.

We also ask that you:

- + *Make non-commercial use of the files* We designed Google Book Search for use by individuals, and we request that you use these files for personal, non-commercial purposes.
- + *Refrain from automated querying* Do not send automated queries of any sort to Google's system: If you are conducting research on machine translation, optical character recognition or other areas where access to a large amount of text is helpful, please contact us. We encourage the use of public domain materials for these purposes and may be able to help.
- + *Maintain attribution* The Google "watermark" you see on each file is essential for informing people about this project and helping them find additional materials through Google Book Search. Please do not remove it.
- + *Keep it legal* Whatever your use, remember that you are responsible for ensuring that what you are doing is legal. Do not assume that just because we believe a book is in the public domain for users in the United States, that the work is also in the public domain for users in other countries. Whether a book is still in copyright varies from country to country, and we can't offer guidance on whether any specific use of any specific book is allowed. Please do not assume that a book's appearance in Google Book Search means it can be used in any manner anywhere in the world. Copyright infringement liability can be quite severe.

About Google Book Search

Google's mission is to organize the world's information and to make it universally accessible and useful. Google Book Search helps readers discover the world's books while helping authors and publishers reach new audiences. You can search through the full text of this book on the web at <http://books.google.com/>

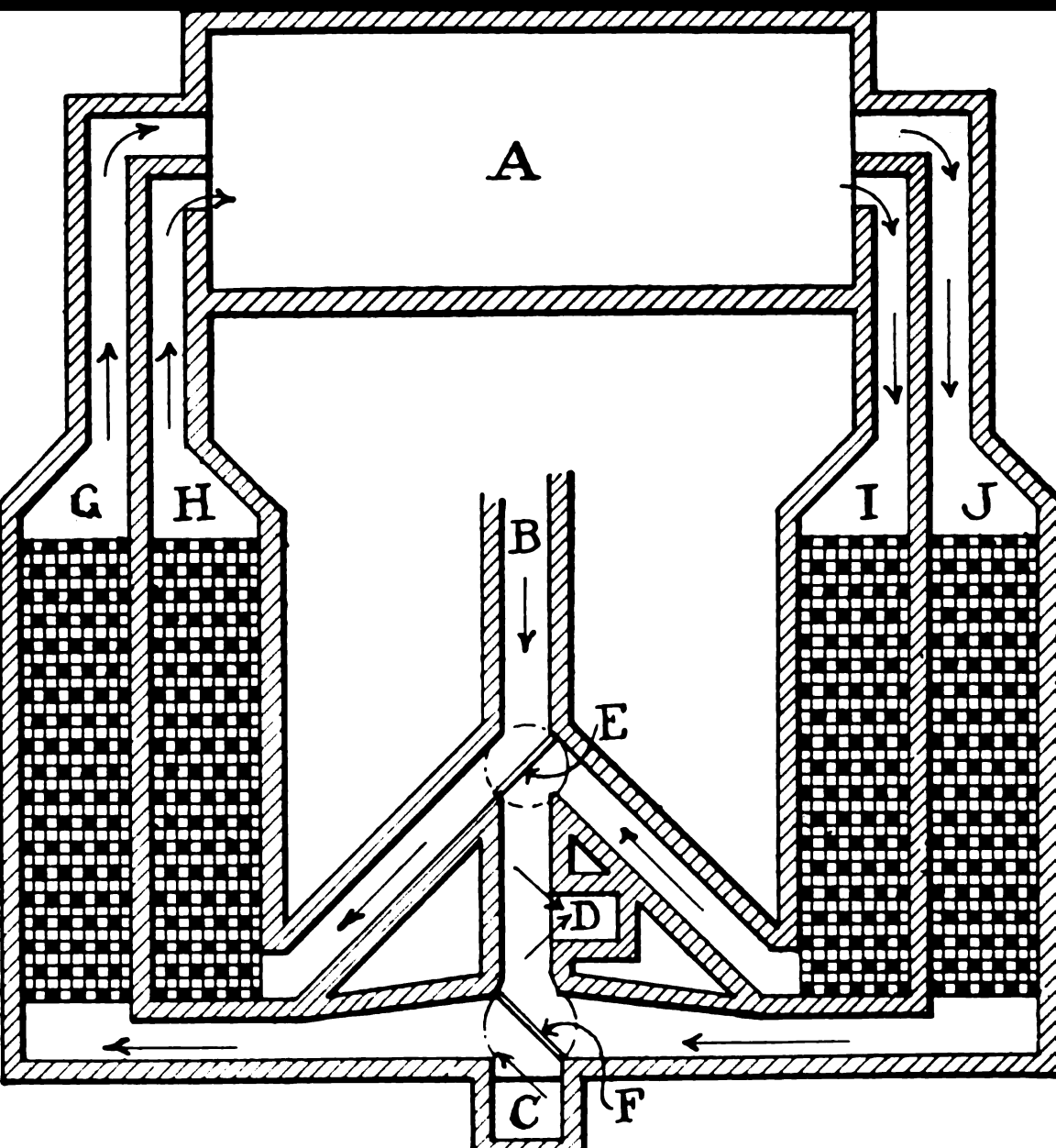

*A treatise on producer-gas
and gas-producers*

Samuel S. Wyer



Library
of the
University of Wisconsin

Gal

A TREATISE
ON
PRODUCER-GAS AND
GAS-PRODUCERS

BY
SAMUEL S. WYER, M.E.
JUNIOR MEMBER AMERICAN SOCIETY MECHANICAL ENGINEERS
MEMBER AMERICAN INSTITUTE MINING ENGINEERS
AUTHOR "CATECHISM ON PRODUCER-GAS"

Second Edition

1907
HILL PUBLISHING COMPANY
NEW YORK AND LONDON
THE ENGINEERING AND MINING JOURNAL, POWER,
AMERICAN MACHINIST

Copyright, 1906, By THE ENGINEERING AND MINING JOURNAL
Copyright, 1907, By THE HILL PUBLISHING COMPANY

125061
DEC 14 1908

~~L P NP
W 7
T
R~~

Wendt
TP
761
P9
W92

5163640

DEDICATED TO MY WIFE.

PREFACE.

THE first four chapters are given for the benefit of readers who may not be familiar with those fundamental laws and definitions of physics and applied chemistry upon which a rational discussion of producer-gas must be based. References are cited in the text by means of their bibliographical serial numbers, these being given in Chapter 30. Since the engineering side of gas-producers is so closely related to applied chemistry, temperatures are stated either in Centigrade or Fahrenheit; however, as the book is intended primarily for engineers, the Fahrenheit scale is used most.

Parts of Chapters 24, 26, and 30 were presented by the author as papers at the Washington, D. C., meeting of the A. I. M. E.

The author wishes to acknowledge the courtesy shown him by the builders of American producers in furnishing illustrations and data, and especially to the United Coke and Gas Company for information on their by-product coke ovens.

Acknowledgment is also due Messrs. Ledebur, Ramdohr, Stegmann, and Gradenwitz, of Germany; Åckerman, of Sweden; Ebelmen, of France; Mathot, of Belgium; Rowan, Jenkins, Dowson, Siemens, Sexton, and Mond, of England; and Taylor, Campbell, Howe, Gow, Raymond, and Nixon, of America, for ideas and suggestions from their contributions to the literature of the subject.

In conclusion I wish to thank Prof. N. W. Lord, of the Ohio State University, for suggestions and criticisms on the book.

SAMUEL S. WYER.

COLUMBUS, OHIO, September, 1905.

AUTHOR'S PREFACE TO SECOND EDITION

It is now nearly a year and a half since the manuscript for the first edition left the author's hands. In this brief period the producer-gas industry has grown very rapidly in America. Not only have a large number of manufacturers gone into the business of manufacturing gas producers, but the advantages of the producer-gas process have become so well known as to make it feasible to adapt producer gas to several new industries. The largest amount of development in the near future will be along the line of developing successful soft coal gas producers for gas-engine work.

The changes that have been necessary to bring the second edition up to date have been made by means of references following the section numbers and headings which refer to notes in the Appendix. As for example, § 47 *Atomic and Molecular Weights* (see App., Note 7). In the same way, if the section number is followed by (B 99) the reference is to the bibliography pages 277-290 inclusive.

Dr. Richards' "Metallurgical Calculations" have done much toward placing the thermo-chemical problems of gas engineering on a firm basis, and the author is under obligations to him for suggestions.

In conclusion the author wishes to thank all those who have been helpful in increasing the value of the book by suggesting changes and making criticisms.

SAMUEL S. WYER.

HARRISON BUILDING, COLUMBUS, OHIO,

March 15, 1907.

CONTENTS.

CHAPTER I.

FUNDAMENTAL PHYSICAL LAWS AND DEFINITIONS.

SECTION.	PAGE.
1. Importance of laws	21
2. Forms of matter	21
3. Perfect gas	21
4. Distinction between a vapor and a gas	21
5. Vapor tension	22
6. Vapor pressure	22
7. Saturation	22
8. Humidity	23
9. Absolute humidity	23
10. Relative humidity	23
11. Boyle's or Mariotte's law	23
12. Law of Charles	23
13. Laws of Boyle and Charles combined	23
14. Joule's law of gases	24
15. Law of Gay-Lussac	24
16. Dalton's law	24
17. Temperature	24
18. Thermal capacity	24
19. Specific heat	24
20. Specific heat of gases	24
21. Heat unit	25
22. Density of gases	25
23. Specific volume	25
24. Specific gravity	25
25. Standard conditions	25
26. Parallel and opposite currents	26
27. Radiation	27
28. Flow of gases	28
29. Equation of pipes	28

CHAPTER II.

FUNDAMENTAL CHEMICAL LAWS AND DEFINITIONS.

30. Division of matter	30
31. Atoms and molecules	30
32. Chemical affinity	30

SECTION.	PAGE
33. Laws of thermal chemistry	30
34. Endothermic reaction	30
35. Exothermic reaction	31
36. Law of definite proportion	31
37. Law of multiple proportion	31
38. Nascent state	31
39. Oxidation	31
40. Reduction	31
41. Combustion	31
42. Temperature of combustion	31
43. Dissociation	31
44. Dissociation temperature	31
45. Heat of decomposition	32
46. Flame	32
47. Atomic and molecular weights	32
48. Destructive distillation	33
49. Fractional distillation	33
50. Direct-firing	33
51. Gas-firing	33

CHAPTER III.

THERMAL AND PHYSICAL CALCULATIONS.

52. Determination of the specific heat of a mixed gas	34
53. Determination of the calorific power of a mixed gas	35
54. Carbon ratio	35
55. Calculation of volume of gas	36
56. Theoretical combustion	36
57. Weight of a mixed gas	38
58. Specific gravity of a mixed gas	39
59. Composition of gases by weight	39
60. Air required for combustion	40
61. Weight and volume of products of combustion	41
62. Heat carried away by products of combustion	42
63. Sensible heat loss of producer-gas	42
64. Flame temperature	43
65. Explosive mixtures	43
66. Calculation of moisture in air	44

CHAPTER IV.

COMMERCIAL GASES.

67. Definition of commercial gases	45
68. Hydrogen	45
69. Marsh gas	46
70. Olefiant gas	46
71. Carbonic oxide	46

CONTENTS.

9

SECTION.	PAGE.
72. Carbon dioxide	46
73. Oxygen	47
74. Nitrogen	47
75. Hydrocarbons	47
76. Water vapor	47
77. Air	48
78. Illuminants	48
79. Natural gas	48
80. Oil gas	48
81. Coal gas	49
82. Coke-oven gas	49
83. Water gas	49
84. Carbureted water gas	49
85. Comparison of commercial gases	49
86. Tabulated data	50

CHAPTER V.

STATUS OF PRODUCER-GAS.

87. Progress made	52
88. Ignorance	52
89. Fuel supply	53
90. Inadaptability	54

CHAPTER VI.

CLASSIFICATION OF GAS-PRODUCERS.

91. Method of operation	55
92. Method of supporting fuel	55
93. Place of removing gas	56
94. Means of agitating fuel	56
95. Nature of draft	56
96. Direction of blast	56
97. Continuity of operation	56

CHAPTER VII.

MANUFACTURE AND USE OF PRODUCER-GAS.

98. Nature of producer-gas	57
99. Simple producer-gas	57
100. Steam-enriched gas	58
101. The action in gas-producer	58
102. Ash zone	58
103. Combustion zone	60
104. Decomposition zone	60
105. Distillation zone	60
106. Hydrocarbons	60

SECTION.	PAGE
107. Condition of fire	61
108. Temperature of gas	61
109. Pre-heating air	62
110. Uses of producer-gas	63
111. Advantages of gas-firing	63
112. Regenerators	64
113. Recuperation	65
114. Comparison of regeneration and recuperation	66
115. Value of regeneration and recuperation	66

CHAPTER VIII.

USE OF STEAM IN GAS-PRODUCERS.

116. Object	67
117. Action	67
118. Effect of temperature on action	68
119. Function of steam	68
120. Proportion of air and steam	69
121. Quantity of steam	70
122. Mechanical effect	71
123. Water vapor	71
124. Summary	71
125. Steam blowers	72
126. Types of steam blowers	74

CHAPTER IX.

CARBON DIOXIDE IN PRODUCER-GAS.

127. Presence	79
128. Effect of temperature and fuel bed	80
129. Effect of feeding	80
130. Effect of leakage	81

CHAPTER X.

EFFICIENCY OF GAS-PRODUCERS.

131. Heat loss	82
132. Definition of efficiency	82
133. Two kinds of efficiency	82
134. Relation of utility and efficiency	83
135. Relation of efficiency and calorific power	83
136. Method of finding efficiency	83
137. Conditions governing efficiency	84
138. Coal and ash analysis	84
139. Grate efficiency	85
140. Heat of combustion of fuel	85
141. Temperatures	85

CONTENTS.

11

SECTION.	PAGE.
142. Figure of merit	85
143. Limited use of figure of merit	86
144. Cold-gas efficiency	87
145. Hot-gas efficiency	87
146. Effect of steam on efficiency	88

CHAPTER XI.

HEAT BALANCE OF THE GAS-PRODUCER.

147. Heat losses	89
148. Arrangement of heat balance	90
149. Calculation of heat balance	90

CHAPTER XII.

FUEL.

150. Early fuels	94
151. Character of fuel	94
152. Condition	94
153. Size of fuel	95
154. Coal	95
155. Peat	95
156. Brown coal	96
157. Refuse	96

CHAPTER XIII.

REQUIREMENTS.

158. Adaptability	97
159. Construction of producer	97
160. Composition of gas	97
161. Automatic feeding	97
162. Continuity of operation	97
163. Agitation of fuel bed	98
164. Removal of ashes	98
165. Deep fuel bed	98
166. Introduction of blast	98
167. Cleanliness	98
168. Ease in starting	99
169. Regulation of steam and air	99
170. Heat insulation	99
171. Grate efficiency	99
172. Conservation of heat energy	99

CHAPTER XIV.

HISTORY OF GAS-PRODUCERS.

173. Chronological record	100
174. Early use	102

SECTION.	PAGE.
175. Conservatism in improvement	103
176. Want of appreciation	103
177. Bischof producer	103
178. Ebelmen s producers	105
179. Ekman producer	110
180. Beaufume producer	111
181. Wedding producer	111
182. Siemens producer	111

CHAPTER XV.

AMERICAN PRESSURE PRODUCERS.

183. Taylor fluxing producer	113
184. Langdon producer	113
185. Fuel gas and Electric Engineering Co.'s producer	116
186. Kitson producer	116
187. American Furnace and Machine Co.'s producer	118
188. Amsler producer	118
189. Swindell producer	119
190. Forter producer	121
191. Smythe producer	125
192. Duff producer	125
193. Taylor producer	126
194. Wood double-bosh producer	130
195. Wood water-seal producer	131
196. Wood flat-grate producer	132
197. Wood single-bosh water-seal producer	132
198. Wellman producer	132
199. Fraser-Talbot producer	132
200. Morgan producer	137
201. Loomis producer	139
202. Wile automatic producer	143
203. Wile water-seal producer	145

CHAPTER XVI.

AMERICAN SUCTION GAS-PRODUCERS.

204. History of development	146
205. Definition of "suction gas-producer"	146
206. Classification	146
207. Operation	147
208. Steam supply and regulation	147
209. American suction producers	147
210. Nagel suction producer	148
211. Pintsch suction producer	150
212. American Crossley producer	152

CONTENTS.

13

SECTION.	PAGE.
213. Fairbanks-Morse suction producer	159
214. Smith suction producer	161
215. Baltimore suction producer	164
216. Wyer suction producer	165

CHAPTER XVII.

GAS-CLEANING.

217. Object of cleaning	169
218. Classification of methods	169
219. Deflectors	170
220. Liquid scrubbers	172
221. Coolers	172
222. Absorbers or filters	172
223. Rotating scrubbers	174
224. Proportion of tower scrubbers	176

CHAPTER XVIII.

BY-PRODUCT GAS-PRODUCERS.

225. Definition	177
226. Number and value of by-products	177
227. Ammonia sulphate	179
228. Method of recovering by-products	180
229. Mond process	180
230. Distinctive features of Mond process	183

CHAPTER XIX.

BY-PRODUCT COKE OVEN GAS-PRODUCERS.

231. Status and future	185
232. Otto-Hoffman oven	185
233. Treatment of gas	188
234. United-Otto oven	188
235. Wall construction	190
236. Heating systems	190
237. Operation	190
238. Quencher	191
239. Air and water coolers	193
240. Exhausters	193
241. Tar scrubbers	193
242. Ammonia scrubbers	195
243. Recovery of ammonia	195
244. Benzol recovery	195
245. Use of gas in engines	196

CHAPTER XX.

PRODUCER-GAS FOR FIRING CERAMIC KILNS.

SECTION.	PAGE.
246. Status	197
247. Value	198
248. Objections	198
249. Difficulties in using producer-gas	198
250. Heat losses	199
251. Effect of solid fuel constituents	200
252. Advantages of producer-gas	201
253. Types of producers for ceramic work	203

CHAPTER XXI.

PRODUCER-GAS FOR FIRING STEAM BOILERS.

254. Field for use	210
255. Principle	210
256. Advantages	211
257. Requirements	211
258. Results	211
259. Methods of firing	212

CHAPTER XXII.

WOOD GAS-PRODUCERS.

260. Field for use	214
261. Types of producers	214
262. Lundin flat-grate gas-producer	214
263. Lundin stepped-grate gas-producer	215
264. Riche distillation producer	215
265. Riche double-combustion producer	220

CHAPTER XXIII.

REMOVAL OF TAR FROM GAS.

266. Object and difficulties of removal	222
267. Nature of tar	222
268. Influence of temperature	223
269. Elimination of tar	223

CHAPTER XXIV.

GAS-PRODUCER POWER PLANTS.

270. Status	228
271. Ignorance	228
272. Newness of work	228
273. Inadaptability	229
274. Fuel economy has not been imperative	230

CONTENTS.

15

SECTION.	PAGE.
275. Smoke nuisance	230
276. Labor	230
277. Cost of installation	231
278. Cost of repairs	231
279. Use of cheap fuels	232
280. Scrubbing of gas	232
281. Fuel economy during hours of idleness	232
282. Time required to start producer	232
283. Time required to stop producer	232
284. Composition of gas	233
285. Thermal efficiency and economy	233
286. Automatic feeding	233
287. Rate of gasification	233
288. Poking the producer	235
289. Calorific value of producer-gas	235
290. Fuel economy	235
291. No loss from condensation	235
292. Leakage of gas	235
293. Saving in shafting	236
294. Floor space	236
295. Control of operation	236
296. Dual use of gas	236
297. Storing of heat energy	236
298. Economy of water	236
299. Driving isolated machines	237
300. Range of sizes	237
301. Danger of explosion	237
302. Location of producer plant	237

CHAPTER XXV.

OPERATION OF GAS-PRODUCERS.

303. Erection	238
304. Starting producer	238
305. Starting engine	239
306. Stopping producer	240
307. Running producer	240
308. Cleaning of plant	240
309. Producer troubles	241

CHAPTER XXVI.

TESTING GAS-PRODUCERS.

310. Object of code	243
311. Object of test	243
312. Value of test	243
313. Determination of object	243

SECTION.	PAGE.
314. Examination of producer	245
315. General condition of producer	245
316. Character of fuel	245
317. Calibration of apparatus	245
318. Auxiliary boiler	246
319. Heating of producer	246
320. Duration of test	246
321. Starting and stopping a test	246
322. Uniformity of conditions	246
323. Keeping the records	246
324. Quantity of steam	247
325. Quality of steam	247
326. Measurement of ashes and refuse	247
327. Sampling the fuel and determining its moisture	247
328. Calorific tests and fuel analysis	248
329. Gas analysis	248
330. Calorific value of gas	248
331. Determination of water vapor, tar, and soot in gas	249
332. Report of test	251

CHAPTER XXVII.

FUTURE OF THE GAS-PRODUCER.

333. Outlook	255
334. Producer-gas locomotives	255
335. Producer-gas power plants for marine service	257
336. Producer-gas portable engines	259
337. Future development	261

CHAPTER XXVIII.

GAS-POISONING.

338. Danger	263
339. Effect of carbon monoxide	263
340. Symptoms of carbon monoxide poisoning	264
341. Effect of carbon dioxide	264
342. Effect of carbon dioxide poisoning	265
343. First aid to sufferer	265
344. Artificial respiration	265
345. Post-mortem effects	266

CHAPTER XXIX. REFERENCE DATA, p. 267

CHAPTER XXX. BIBLIOGRAPHY, p. 277

APPENDIX	291
--------------------	-----

LIST OF ILLUSTRATIONS.

FIGS.	PAGE.
1. Diagram of vapor tension and pressure	22
2. Zones of a gas-producer	59
3. Diagram of regenerator	64
4. Siemens steam blower	73
5. Siemens steam blower	74
6. Thwaite steam blower	75
7. Argand steam blower	75
8. Solid jet steam blower	76
9. Eynon-Evans steam blower	76
10. Curves showing efficiency of blowers	77
11. Bischof producer	104
12. Ebelmen producer	105
13. Ebelmen producer	106
14. Ebelmen producer	107
15. Ekman producer	108
16. Beaufume producer	109
17. Wedding producer	110
18. Siemens producer	112
19. Langdon producer	114
20. Fuel gas and Electric Engineering Co.'s producer	115
21. Kitson producer	117
22. American Furnace and Machine Co.'s producer	119
23. American Furnace and Machine Co.'s producer	119
24. American Furnace and Machine Co.'s producer	119
25. Amsler producer	120
26. Swindell producer	121
27. Swindell producer	122
28. Swindell producer	122
29. Forter producer	123
30. Smythe producer	124
31. Duff producer	125
32. Duff producer	126
33. Duff producer	126
34. Taylor producer	127
35. Taylor producer	128
36. Wood double-bosh producer	129
37. Wood water-seal producer	130
38. Wood flat-grate producer	131
39. Wood flat-grate producer	132
40. Wood single-bosh water-seal producer	133

FIGS.	PAGE.
41. Wellman producer	134
42. Fraser-Talbot producer	135
43. Fraser-Talbot producer	136
44. Morgan producer	138
45. Morgan producer	140
46. Morgan producer plant	141
47. Loomis producer	142
48. Section of Wile automatic producer	143
49. Assembly of Wile automatic producer	144
50. Wile water-seal producer	145
51. Wood suction producer	148
52. Otto suction producer	149
53. Weber suction producer	150
54. Backus suction producer	151
55. Wile suction producer	152
56. Nagel suction producer	153
57. Section of Pintsch producer	154
58. Assembly of Pintsch producer	155
59. Crossley suction producer	156
60. Section of Crossley suction producer	157
61. Crossley suction producer plant	158
62. Section of Fairbanks-Morse suction producer	159
63. Assembly of Fairbanks-Morse suction producer	160
64. Assembly of Smith suction producer	161
65. Grate of Smith suction producer	162
66. Charging hopper of Smith suction producer	163
67. Assembly of regulation for Smith suction producer	164
68. Detail of regulator and superheater for Smith suction producer	165
69. Baltimore suction producer	166
70. Section of Wyer producer	167
71. Arrangement of Wyer water regulation	168
72. Moisture collector	170
73. Dust collector	170
74. Moisture collector	170
75. Tar collector	171
76. Tar collector	171
77. Film scrubber	173
78. Gas cooler	173
79. Windhausen scrubber	174
80. Centrifugal scrubber	175
81. Centrifugal scrubber	176
82. Mond by-product gas plant	181
83. Otto-Hoffman coke oven	186
84. United-Otto coke-oven plant	189
85. Coke quencher	192
86. Condensing apparatus	194
87. Producer for ceramic kilns	202

LIST OF ILLUSTRATIONS.

19

FIGS.	PAGE.
88. Producer for ceramic kilns	203
89. Producer for ceramic kilns	204
90. Producer for ceramic kilns	205
91. Producer for ceramic kilns	206
92. Producer for ceramic kilns	207
93. Producer for firing cement kiln	208
94. Producer for firing cement kiln	209
95. Gas-fired water-tube boiler	212
96. Application of gas-producer to steam boiler	213
97. Lundin flat-grate producer	215
98. Lundin stepped-grate producer	216
99. Section of Riche distillation producer	217
100. Assembly of Riche distillation producer	218
101. Section of Riche double-combustion producer	219
102. Assembly of Riche double-combustion producer	220
103. Duff-Whitfield producer	224
104. Poetter producer	225
105. Wilson producer	226
106. Capitaine producer	226
107. Comparative efficiency of steam and gas plants	234
108. Log of gas-producer test	244
109. Gas-sampling apparatus	249
110. Gasoline motor car	260
111. Producer-gas-engine-driven tugboat	261
112. Gasoline traction engine	262
113. Curve of correction factors	273

LIST OF TABLES.

TABLE.	PAGE.
1. Summary of combustion data	38
2. Explosive mixtures	44
3. Constituents of commercial gases	51
4. Commercial gases	50
5. Effect of temperature on action of steam	68
6. Effect of steam on composition of gas	69
7. Effect of different amounts of steam on gas	70
8. Variation in composition of gas	80
9. Arrangement of heat balance	91
10. Data and results of producer test	251
11. Saturation table	267
12. Relative humidity of air	268
13. Coefficients of radiation	268
14. Radiation ratios	268
15. Radiation loss in iron pipes	269
16. Radiation loss through walls	269
17. Efficiency of pipe coverings	270
18. Discharge of gas	270
19. Equation of pipes	274
20. Solubility of various gases	275
21. Melting points of various salts	275
22. Variation in specific heat of CO ₂	275
23. Mean specific heats	301
24. Comparison of pressures	302

CHAPTER I.

FUNDAMENTAL PHYSICAL LAWS AND DEFINITIONS.

§ 1. *Importance of laws.*

To secure a proper conception of the method of manufacture, the value, advantages, and applications of producer-gas, it is necessary to have a *clear* understanding of some of the fundamental laws and definitions of physics and chemistry; these are given in concise form in this and the following chapter.

§ 2. *Forms of matter.*

A solid is a substance which has more or less rigidity of form. A fluid is a substance which has no rigidity of form. A liquid is a fluid capable of having a free surface and of which the volume is definite. A gas is a fluid of which the volume is limited only by that of the closed containing vessel.

§ 3. *Perfect gas.*

A gas which strictly follows Boyle's law (§11) is called a perfect gas.

§ 4. *Distinction between a vapor and a gas.*

A vapor is a substance in the gaseous state at any temperature below the critical point. A vapor can be reduced to a liquid by pressure alone, and may exist as a saturated vapor in the presence of its own liquid. A gas is the form which any liquid assumes above its critical temperature, and it cannot be liquefied by pressure alone, but only by combined *pressure and cooling*. The critical point is the line of demarcation between a vapor and a gas. The temperature of the substance at the critical point is the critical temperature. The pressure which at the critical temperature just suffices to condense the gas to the liquid form is called the critical pressure. The following are a few of these:

CRITICAL TEMPERATURES.		CRITICAL PRESSURES.	
CO ₂	30.92 C.	77. atmospheres.
C ₂ H ₆	9.2	53. "
CH ₄	-81.8	54.9 "
O.....	-118.	50. "
CO.....	-141.1	35.9 "
N.....	-146.	35. "
H.....	-220.	20. "
H ₂ O.....	-370.	195. "

§ 5. Vapor tension.

All liquids tend to assume the gaseous state, and the measure of this tendency is the vapor tension of the liquid.

§ 6. Vapor pressure.

For a given liquid there corresponds to each temperature a certain definite pressure of its vapor, at which the two will re-

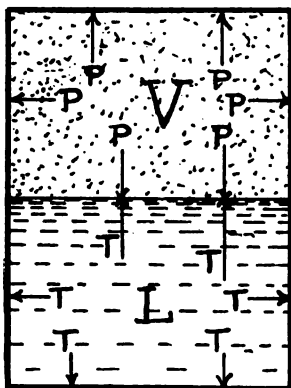

FIG. 1.—DIAGRAM OF VAPOR TENSION AND PRESSURE.

main in contact unchanged. Thus in Fig. 1 the gas pressure, P , of the vapor, V , balances the vapor tension, T , of the liquid L . This gas pressure is said to be the vapor pressure of the liquid at that temperature, and the vapor itself is said to be saturated. The relation between water-vapor pressure at saturation and temperature is shown in table 11, p. 267. For the application of this, see § 331.

§ 7. Saturation.

A gas is saturated when its full capacity of a given volume of vapor has been reached.

§ 8. *Humidity.*

The state of a gas, with reference to vapor that it contains, is called its humidity.

§ 9. *Absolute humidity.*

The amount of vapor actually present is called the absolute humidity for a given temperature.

§ 10. *Relative humidity.*

The absolute humidity divided by the amount of vapor that might exist if the gas were saturated at the given temperature gives a ratio called the relative humidity. This is usually expressed in percentages; thus, air with a relative humidity of 50 per cent has just half as much water vapor in it as it could hold at the corresponding temperature. Table 12, p. 268, gives the relative humidity of air.

§ 11. *Boyle's or Mariotte's law.*

In a perfect gas the volume is inversely proportional to the pressure to which the gas is subjected; or, what is the same thing, the product of the pressure and the volume of a given quantity of gas remains constant.

§ 12. *Law of Charles.*

The volume of a given mass of any gas, under constant pressure, increases from the freezing point by a constant fraction of its volume at zero. In other words, gases expand $\frac{1}{273}$ of their volume at 0 degrees C. for each degree C. rise of temperature, and $\frac{1}{180}$ of their volume at 32 degrees F. for each degree F. rise of temperature.

§ 13. *Laws of Boyle and Charles combined.*

The combination of these two laws shows that the product of the volume and pressure of any mass of gas is proportional to its absolute temperature.

Let V = volume corresponding to temp. 0 degrees C., and pressure $P = 760$ mm.

Let v = volume corresponding to temp. t degrees C., and pressure p .

$$v = V + \frac{1}{273}tV = V + .00366tV = V(1 + .00366t).$$

$$V = \frac{v}{1 + .00366t}.$$

$$\text{But } PV = pv, \text{ hence } V = \frac{vp}{760(1 + .00366t)}.$$

As the presence of water vapor in a gas also influences its volume, the vapor tension must be taken into account. Let a = vapor tension corresponding to t degrees. For values of a , see table 11, p. 267.

$$V = \frac{v(p-a)}{760(1 + .00366t)}.$$

This may be worked out in a similar manner for Fahrenheit temperatures.

§ 14. *Joule's law of gases.*

No change of temperature occurs when a perfect gas is allowed to expand without doing external work, or without taking in or giving out heat.

§ 15. *Law of Gay-Lussac.*

Equal volumes of all gases at the same temperature and pressure contain the same number of molecules.

§ 16. *Dalton's law.*

A mixture of gases, having no chemical action on each other, exerts a pressure which is equal to the sum of the pressures which would be produced by each gas separately, provided it occupied the containing vessel alone at the given temperature.

§ 17. *Temperature.* (See App., note 1.)

Temperature is the measure of the degree of hotness of a body.

§ 18. *Thermal capacity.*

The thermal capacity of a substance is the heat required to raise the temperature of a unit mass of it one degree.

§ 19. *Specific heat.*

The specific heat of a substance is the ratio between the thermal capacities of equal masses of the substance and water.

§ 20. *Specific heat of gases.* (See App., note 2.)

A gas has two specific heats, depending on whether it is kept at constant volume or at constant pressure while being heated. The specific heat of gases also varies with the temperature. This is shown in table 22, p. 275.

§ 21. *Heat unit.* (See App., note 3.)

The unit quantity of heat, or the heat unit, is the heat required to raise the temperature of a unit weight of water one degree.

The heat required to raise one pound of water one degree F. is called a British thermal heat unit, B. t. u.

The heat required to raise one gram of water one degree C. is called a gram-calory.

The heat required to raise one kilogram of water one degree C. is called a calory.

The heat required to raise one pound of water one degree C. is called the Centigrade unit, C. u.

§ 22. *Density of gases.*

The density, or the specific weight, of a gas is the mass contained in a unit volume of the gas. Column G, table 3, p. 51, gives the density of various gases where the unit of volume is the cubic foot.

§ 23. *Specific volume.*

The specific volume of a gas is the number of units of volume which are occupied by a unit weight of the gas. Column H, table 3, p. 51, gives the specific volumes of various gases in terms of cubic feet and pounds.

§ 24. *Specific gravity.*

The specific gravity of a gas is the ratio of its density to the density of another gas taken as a standard. Hydrogen and air are the standards that are generally used. Columns E and F of table 3, p. 51, give the values for different gases. The specific gravity of producer-gas is usually about 0.86 with reference to air. For the method of calculating the specific gravity of producer-gas, see § 58.

It must be remembered that the specific gravity of a gas is affected by the pressure of the gas, and for that reason the values are referred to a standard condition (see § 25). Thus, if the gas pressure is 10 per cent more than that for the standard condition, the specific gravity will also be increased about 10 per cent; if the gas pressure is less than the standard, the specific gravity will be decreased by about the same per cent.

§ 25. *Standard conditions.*

Since the volume of a gas varies with the temperature and pressure, in order to secure comparable results in gas calculations

a standard condition is necessary. This is usually taken as 0 degrees C. and a pressure of 760 millimeters of mercury, abbreviated 0 degrees C., 760 mm.; or its equivalent, 32 degrees Fahrenheit and a pressure of 29.92 inches of mercury, abbreviated 32 degrees F., 29.92 in.

§ 26. *Parallel and opposite currents.*

The construction of most gas-producers used for power purposes is such that the gas is cooled by another fluid as it leaves the producer. This makes it desirable to understand some of the fundamental cooling phenomena. On account of limited space in this book, the discussion must be brief. For a detailed discussion the reader is referred to B 190, from which the following is taken :

Two liquids, gases or vapors, one of which is to transfer heat to the other, may be conducted either in the same or in opposite directions over the surface of separation. If the two fluids move parallel to one another in the same direction, this condition is known as that of *parallel currents*.

If, however, they move in opposite directions, the condition is that of *opposite currents*.

In the case of opposite currents, the fluid to be cooled and also the fluid to be heated have their highest temperatures at one end and their lowest temperatures at the other; and the cooling medium may flow away at a temperature only slightly lower than the highest temperature of the hot fluid.

In the case of parallel currents, the fluid to be cooled has its highest temperature at the commencement, the fluid to be heated its lowest temperature; at the end the reverse is the case, and the cooling medium must always run off at a temperature lower than the lowest temperature of the hot fluid. Parallel currents require much more cooling fluid than opposite currents. Likewise, in order to heat a cold fluid by means of a hot fluid, much more hot fluid must be used with parallel than with opposite currents. Further, the greatest difference in temperature occurs between the highest temperature of the hot and the lowest temperature of the cold fluid, the smallest difference in temperature between the lowest temperature of the hot and the highest temperature of the cold fluid. The first-named difference is the greatest which arises under any conditions; the second

is always very much less, which is also the case with opposite currents.

Since with opposite currents the highest possible temperature difference can never occur, it follows at once, in general, that the mean difference in temperature is greater with parallel than with opposite currents, and consequently that in the former case the necessary heating or cooling surface may almost always be smaller than in the latter case. An opposite-current apparatus is thus always larger than a parallel-current apparatus, but is more efficient, and, in particular with similar materials, permits the attainment of the highest temperatures in heating apparatus and the lowest temperatures in cooling, which it is impossible to obtain with parallel currents. In conclusion, heating and cooling apparatus should always be constructed for *opposite currents*.

§ 27. *Radiation.*

To secure a high efficiency in any gas-producer, it is imperative to keep the radiation loss (§ 147) low, and to do this requires a compliance with the laws of radiation. "Radiation of heat takes place between bodies at all distances apart and follows the laws for the radiation of light. The heat rays travel in straight lines, and the intensity of the rays radiated from any one source varies inversely as the square of the distance from the source. Heat rays are reflected according to the law of optics, that the angle of incidence is equal to the angle of reflection."

If the temperature difference is small, the radiation loss will depend on the material, area, and temperature difference. Table 13, p. 268, gives the radiation coefficients as determined by Péclet. These coefficients are not reliable for large temperature ranges, since a considerable difference in the temperature of the hot body and the surrounding air causes an increased rate of cooling which varies with the magnitude of the temperature range. These corrections are given in table 14, p. 268. The number of heat units radiated from a given material and area should first be computed by the coefficients of radiation given in table 13, and the result multiplied by the ratio of the respective temperature range as given in table 14.

Table 15, p. 269, shows the radiation loss from exposed iron pipes, and is a strong argument in favor of the use of heat insu-

lators around pipes conveying a hot fluid that is to be kept at a high temperature.

Table 16, p. 269, gives the radiation loss through masonry walls, and shows the desirability of enclosing the producer in a suitable jacket.

Table 17, p. 270, shows the efficiency of various heat-insulating materials.

§ 28. *Flow of gases.* (See App., note 5.)

The velocity with which a gas under pressure will flow into a vacuum is inversely proportional to the square root of its density. Thus hydrogen, which is sixteen times heavier than oxygen, would, under the same conditions, flow through an opening with four times the velocity of oxygen. Hence, it is evident that the specific gravity of a gas is an important factor in its flow.

The motion of gas in pipes may be determined by the following formulæ:

- H = Head or pressure in inches of water.
 Q = Quantity of gas in cubic feet per hour.
 L = Length of pipe in yards.
 D = Diameter of pipe in inches.
 G = Specific gravity of gas.

$$Q = 1350 D^2 \sqrt{\frac{H \times D}{L \times G}}$$

$$D = .056 \sqrt[5]{\frac{Q^2 \times G \times L}{H}}$$

Table 18, p. 270, which was calculated by the above formula, gives the discharge in cubic feet per hour through pipes of various diameters and lengths and at different pressures, for a gas of a specific gravity of 0.4. The quantity of gas discharged of any other specific gravity may be determined by means of the curve given in Fig. 113. To apply this, multiply the quantity indicated in table 18 by the correction factor corresponding to the particular specific gravity. Thus, for a gas with a specific gravity of 0.85, the quantity indicated in table 18 must be multiplied by 0.685.

§ 29. *Equation of pipes.*

The volume delivered by two pipes of different sizes and the same velocity of flow is proportional to the squares of their

diameters; thus one 4-in. pipe will deliver the same volume as four 2-in. pipes. However, with the same head the velocity will be less in the 2-in. pipes on account of the larger amount of surface friction in the latter, and the volume delivered varies about as the square roots of the fifth powers of the respective diameters. Table 19, p. 274, has been calculated on this basis. The figures opposite the intersection of any two sizes is the number of the smaller sized pipes required to equal one of the larger. Thus one 5-in. pipe is equal to 9.8 2-in. pipes.

CHAPTER II.

FUNDAMENTAL CHEMICAL LAWS AND DEFINITIONS.¹

§ 30. *Division of matter.*

Matter may be divided into elements, compounds, and mechanical mixtures.

A chemically indivisible substance is an element. Elements unite to form new substances called compounds, which may be entirely different from the original elements.

A compound may be defined as a substance made up of two or more elements, or it is a substance that may be broken up into other substances.

A mechanical mixture is a substance composed of two or more elements not held together by any chemical attraction. Producer-gas is a mixture of other gases.

§ 31. *Atoms and molecules.*

An atom is the smallest particle of an element that can enter into chemical combination. Atoms combine to form molecules of substances.

§ 32. *Chemical affinity.*

The force which holds the atoms of a molecule together is called chemical affinity.

§ 33. *Laws of thermal chemistry.*

The heat evolved or absorbed in any chemical change is *fixed* and *definite*, and depends only on that change.

If a chemical change evolves or absorbs heat, the reverse change will absorb or evolve exactly the same quantity of heat.

Every chemical change effected without the intervention of extraneous forces tends to produce those bodies the formation of which will evolve the *least* heat.

§ 34. *Endothermic reaction.*

Any chemical change that absorbs heat is called endothermic, and is indicated by the sign —. (See § 117.)

¹ See App., note 6.

§ 35. *Exothermic reaction.*

Any chemical change that evolves heat is called exothermic, and is indicated by the sign +.

§ 36. *Law of definite proportion.*

Chemical changes always take place between *definite* masses of substances.

§ 37. *Law of multiple proportion.*

If two elements form several compounds with each other, the masses of one that combine with a fixed mass of the other bear a simple ratio to one another.

§ 38. *Nascent state.*

An element is in the nascent state if, at the moment of its liberation from a compound, it is characterized by abnormal chemical activity.

§ 39. *Oxidation.*

Oxidation, also called oxidization, is the act or process of taking up, or combining with, oxygen.

§ 40. *Reduction.*

Reduction is the abstraction of oxygen from a compound.

§ 41. *Combustion.*

Combustion is a vigorous chemical combination attended by the evolution of heat and light. It may also be defined as the "burning or chemical combination of the constituents of the fuel, mostly carbon and hydrogen, with the oxygen of the air."

§ 42. *Temperature of combustion.*

A certain temperature, varying with the nature of the combustible and air supply, is necessary for combustion. For the calculation of this temperature see § 64.

§ 43. *Dissociation.*

When a substance decomposes and splits up into its constituents by the application of heat, in a reversible way, and yields a larger number of molecules than composed the initial body, it is said to dissociate. Thus if CO_2 and H_2O are heated sufficiently, they are split up or dissociated into their constituents, the H_2O being broken up into H and O, and CO_2 into C and O.

§ 44. *Dissociation temperature.*

This is the temperature at which dissociation takes place; it

is not a fixed point, but varies with the conditions. It is generally lowered by contact with hot solids and raised by the presence of inert gases.

§ 45. *Heat of decomposition.*

In the decomposition of a chemical compound, as much heat is absorbed or rendered latent as was evolved when the compound was formed.

§ 46. *Flame.*

A flame is a mass of intensely heated combustible gas. A simple flame is one in which there is only one product of combustion; if there is more than one product of combustion the flame is compound.

§ 47. *Atomic and molecular weights.* (See App., note 7.)

The atomic and molecular weights of the elements entering into producer-gas are given in columns C and D of table 3, p. 51. A knowledge of these makes it a matter of simple arithmetic to determine how many pounds of each element are in a given weight of the combination. One atom of carbon unites with two atoms of oxygen to form one molecule of carbon dioxide; thus,

$$\begin{array}{r} C + 2O = CO_2, \text{ or in pounds,} \\ 12 + 2 \times 16 = 12 + 32 \\ 12 + 32 = 44 \\ 3 + 8 = 11 \end{array}$$

That is, 3 pounds of carbon unite with 8 pounds of oxygen to form 11 pounds of carbon dioxide; or, in other words, to form 1 pound of carbon dioxide there will be required $\frac{3}{11}$ pound of carbon and $\frac{8}{11}$ pound of oxygen.

One atom of carbon unites with one atom of oxygen to form one molecule of carbon monoxide. Thus:

$$\begin{array}{r} C + O = CO \\ 12 + 16 = 28 \\ 3 + 4 = 7 \\ 1 + 1\frac{1}{2} = 2\frac{1}{2} \end{array}$$

That is, 3 pounds of carbon unite with 4 pounds of oxygen to form 7 pounds carbon monoxide; or, in other words, to form 1 pound of carbon monoxide there will be required $\frac{3}{7}$ pound of carbon and $\frac{4}{7}$ pound of oxygen.

In other words, to burn 1 pound of carbon to carbon monoxide, there will be required $1\frac{1}{2}$ pound of oxygen, and this will form $2\frac{1}{2}$ pounds of the carbon monoxide.

§ 48. *Destructive distillation.*

Destructive distillation is the process of heating a substance beyond the point of decomposition without the access of air. The object may be the dry residue, the condensed distillate, or the gases evolved. The residue will always be carbon.

§ 49. *Fractional distillation.*

This is the separating of different constituents from a composite substance. It is made possible by the fact that different substances pass into vapors at different temperatures.

§ 50. *Direct-firing.* (B 194.)

“By direct-firing is meant burning coal or other solid fuel in a fire-box close to the working chamber, and in a layer so thin that enough free atmospheric oxygen passes through some of the wider crevices between the lumps of fuel, both to burn the carbonic oxide generated by the incomplete combustion of the fuel by the limited quantity of air which passes through other and narrower crevices, and also to burn the hydrocarbons, if any, distilled from the fuel. Thus both the combustible gas and the air for burning it escape simultaneously and side by side from the surface of the fuel, the flame beginning at the very surface of the fuel.”

§ 51. *Gas-firing.* (B 194.)

“By gas-firing is meant chiefly burning the fuel in a layer so thick that all of the oxygen of the air which passes through it combines with the fuel, and that nearly all of it forms carbonic oxide with the carbon of the fuel; so that from the surface of the fuel escapes a stream of combustible gas, chiefly the carbonic oxide thus formed, and hydrocarbons from the distillation of the fuel, diluted with atmospheric nitrogen. The stream of gas is in turn burnt by air specially admitted for this purpose.”

“In short, in direct-firing the fuel bed is so *thin* that it delivers flame direct from its surface; in gas-firing it is so *thick* that it delivers there a stream simply of combustible gas. This is the essential distinction.”

CHAPTER III.

THERMAL AND PHYSICAL CALCULATIONS.

§ 52. *Determination of the specific heat of a mixed gas.* (App., note 2.)

The number of heat units absorbed in heating a given volume of a mixed gas through a given range of temperature will be the aggregate number of heat units absorbed by the several constituents. The number of heat units absorbed by each constituent will be the product of its volume, expressed in cubic feet, and its specific heat per cubic foot. To simplify the calculation, we assume that the total 100 stands for 100 cubic feet of the gas; then the percentage of each constituent will stand for the number of cubic feet of the respective constituents in the hundred. This calculation is illustrated by the following example:

	A		B		C
O.....	4.....	×	.019.....	=	.0077
H.....	8.5.....	×	.019.....	=	.1615
N.....	60.3.....	×	.0192.....	=	1.1577
CO.....	22.8.....	×	.0193.....	=	.4404
CO ₂	5.2.....	×	.0265.....	=	.1378
CH ₄	2.4.....	×	.0264.....	=	.0633
C ₂ H ₄4.....	×	.0289.....	=	.0115
	100.0		Specific heat of 100 cu. ft.	=	1.9799
			Specific heat of 1 cu. ft.	=	.0198

A Composition of gas in percentage by volume.

B Specific heat per cubic foot, column J, table 3, p. 51.

C Specific heat of 100 cubic feet of mixed gas.

It will be noticed that the specific heats of O, H, N, and CO are nearly the same. The amount of C₂H₄ in any ordinary producer-gas is too small to affect the result materially, CH₄ and CO₂ being the only factors whose variation alters the general value to any extent. The gas analysis given is a representative one, and in ordinary practice the specific heat per cubic foot of producer-gas will not be found to vary much from the value calculated.

§ 53. *Determination of the calorific power of a mixed gas.*

The number of heat units produced by the combustion of a given volume of mixed gas will be the aggregate number of heat units produced by the combustion of the several constituents. The number of heat units produced by each constituent will be the product of its volume, expressed in cubic feet, and its calorific power, expressed in heat units per cubic foot. This calculation is illustrated by the following example:

	A	B ¹		C
CO ₂	5.2			
O.....	.4			
C ₂ H ₄	4.....	1670.....	A×B.....	= 668
CO.....	22.8.....	342.....	A×B.....	= 7797
H.....	8.5.....	346.....	A×B.....	= 2941
CH ₄	2.4.....	1070.....	A×B.....	= 2778
N.....	60.3			
	100 cu. ft. gives.....			14184 B. t. u.
	1 cu. ft. gives.....			141 B. t. u.

- A Composition of gas in percentage by volume.
- B Calorific power per cubic foot, column R, table 3, p. 51.
- C Calorific power in 100 cubic feet of mixed gas.

§ 54. *Carbon-ratio.* (B 66.)

A knowledge of the ratio of the weight of carbon to the weight of hydrogen in a given gas is often desirable. While the amount of hydrogen in the gas for one unit weight of carbon depends primarily upon the amount of the former in the original fuel, yet this proportion is changed by the loss of carbon with the ashes, by the decomposition of the steam, and by the loss of carbon and hydrogen with the tar and soot. As a result of these factors, the relative amount of hydrogen in the gas from a unit weight of fuel is always higher than in the original fuel.

The "carbon-ratio" may be defined as the numerical value of the total carbon by weight divided by the total weight of hydrogen in a given volume of the gas, and is designated by the symbols $\frac{C}{H}$. This value will indicate the special conditions under which the sample of gas — from which the ratio was calculated — was made.

The calculation of the carbon ratio is illustrated by the following:

¹ See App., note 8.

36 A TREATISE ON PRODUCER-GAS AND GAS-PRODUCERS.

	A	B	C	D	E
CO ₂	5.2.....	C. 12.....	6.....	31.2	
O.....	4				
C ₂ H ₄	4.....	{C. 24.....	12.....	4.8	
		{H. 4.....	2.....		.8
CO.....	22.8.....	C. 12.....	6.....	136.8	
H.....	8.5.....	H. 2.....	1.....		8.5
CH ₄	2.4.....	{C. 12.....	6.....	14.4	
		{H. 4.....	2.....		4.8
N.....	60.3				
	<u>100.0</u>			<u>187.2</u>	<u>14.1</u>

- A Composition of gas by volume = number of molecules.
- B Weights of elements.
- C Relative weights.
- D Relative weights of atoms of carbon. A × C.
- E Relative weights of atoms of hydrogen. A × C.

$$\text{Carbon-ratio} = \frac{187.2}{14.1} = 13.3$$

§ 55. Calculation of volume of gas. (B 66.)

The calculation of the volume of gas from a given weight of fuel is illustrated by the following example:

	A	B	C	D	E
CO ₂	5.2.....	.123.....	.638.....	11.....	.174
O.....	4				
C ₂ H ₄	4.....	.078.....	.031.....	1.....	.026
CO.....	22.8.....	.078.....	1.780.....	1.....	.763
H.....	8.5				
CH ₄	2.4.....	.0445.....	.107.....	1.....	.080
N.....	60.3				
	<u>100.0</u>				<u>1.043</u>

- A Composition of gas by volume.
- B Weight of 1 cu. ft. of gas in pounds (column G, table 3, p. 51.)
- C Weight of component in 100 cu. ft. of gas, A × B.
- D Proportion by weight of carbon in gas (column K, table 3, p. 51.)
- E Weight of carbon in 100 cu. ft. of gas, D × C.

From the above the carbon in 100 cu. ft. of gas = 1.043 lb.
and the carbon in 1 cu. ft. of gas = .01043 lb.

$$\text{Volume of gas containing 1 lb. of carbon} = \frac{1}{.01043} = 96.1 \text{ cu. ft.}$$

Let K = proportion of carbon in 1 lb. of fuel.

Let G = grate efficiency of producer (see § 139).

Let Q = carbon actually gasified — i.e., total carbon in fuel less that passed through grate.

$$Q = K \times G.$$

Hence the volume at standard conditions of producer-gas per pound of fuel = 96.1 × Q.

§ 56. Theoretical combustion. (B 66.)

The combustible constituents of ordinary producer-gas combine with oxygen according to the following reactions:

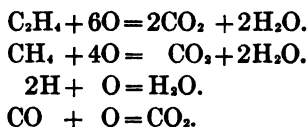

In order to determine the amount of oxygen required in each case, it will be necessary to know in what proportion they combine both by weight and by volume. The gravimetric relation — *i.e.*, the relative proportion by weight — can be determined directly from the atomic weights. The volumetric relation is found by dividing the relative weight of each by its weight per cubic unit of volume. For the discussion of atomic weights see § 47. The volumetric ratios given are not always exact, but are near enough for all engineering calculations. In order to determine the volume of all the products of combustion, it is necessary to assume that they leave the furnace at a temperature above 212 degrees F., so that the water is in the form of steam. In the following calculations the water vapor is taken at 228 degrees F., which corresponds to 20 pounds absolute pressure; at this point the weight of water vapor per cubic foot is .0502 lb. A detailed calculation for each of the combustion reactions is given in the following:

	C_2H_4	+ 6O	= 2CO ₂	+ 2H ₂ O
Relative weights of atoms.....	28	+ 96	= 88	+ 36
Ratio by weight.....	1	+ $\frac{3}{2}$	= $\frac{2}{3}$	+ $\frac{1}{2}$
Weight per cubic foot.....	.078	.089	.123	.0502*
Relative volume.....	12.7	38.3	25.5	25.6
Ratio by volume.....	1 cu. ft.	3 cu. ft.	2 cu. ft.	2 cu. ft.
	Relative volume = $\frac{\text{Ratio by weight}}{\text{Weight per cu. ft.}}$			

That is, 1 lb. of C₂H₄ unites with $\frac{3}{2}$ lb. of O to form $\frac{2}{3}$ lb. CO₂, and $\frac{1}{2}$ lb. H₂O, or, in terms of volume, 1 cu. ft. of C₂H₄, unites with 3 cu. ft. of O to form 2 cu. ft. of CO₂ and 2 cu. ft. of H₂O.

	CH_4	+ 4O	= CO ₂	+ 2H ₂ O
Relative weights of atoms.....	16	+ 64	= 44	+ 36
Ratio by weight.....	1	+ 4	= $\frac{1}{2}$	+ $\frac{3}{2}$
Weight per cubic foot.....	.045	.089	.123	.0502*
Relative volume.....	22.2	43.8	22.3	44.77
Ratio by volume.....	1 cu. ft.	2 cu. ft.	1 cu. ft.	2 cu. ft.
	2H	+ O	= H ₂ O	
Relative weights of atoms.....	2	+ 16	= 18	
Ratio by weight.....	1	+ 8	= 9	
Weight per cubic foot.....	.0056	.089	.0502*	
Relative volume.....	179.	89.5	179.	
Ratio by volume.....	2 cu. ft.	1 cu. ft.	2 cu. ft.	

* Water vapor at 228° F.

	CO	+ O	=CO ₂
Relative weights of atoms.....	.28	+16	=44
Ratio by weight.....	1	+ $\frac{1}{2}$	= $\frac{1}{2}$
Weight per cubic foot.....	.078	.089	.123
Relative volume.....	12.8	6.4	12.8
Ratio by volume.....	2 cu. ft.	1 cu. ft.	2 cu. ft.

Since in all practical cases of combustion the oxygen is taken from the air and is there associated with nitrogen, the latter is always a constituent of the products of combustion. That is, with every pound or cubic foot of oxygen burned there will be thrown into the products of said combustion *3.32 lb. or *3.77 cu. ft. of nitrogen respectively. The following table is a summary of the results just calculated:

TABLE 1.

QUANTITY		REQUIRES	FORMS		
Gravimetrically	1 lb. C ₂ H ₄	$\frac{3}{4}$ lb. O	$\frac{3}{2}$ lb. CO ₂	$\frac{1}{2}$ lb. H ₂ O	11.38 lb. N
	1 lb. CH ₄	4 lb. O	$\frac{1}{2}$ lb. CO ₂	$\frac{1}{2}$ lb. H ₂ O	13.28 lb. N
	1 lb. H	8 lb. O		9 lb. H ₂ O	26.56 lb. N
	1 lb. CO	$\frac{1}{2}$ lb. O	$\frac{1}{2}$ lb. CO ₂		1.9 lb. N
Volumetrically	1 cu. ft. C ₂ H ₄	3 cu. ft. O	2 cu. ft. CO ₂	2 cu. ft. H ₂ O	11.31 cu. ft. N
	1 cu. ft. CH ₄	2 cu. ft. O	1 cu. ft. CO ₂	2 cu. ft. H ₂ O	7.54 cu. ft. N
	1 cu. ft. H	.5 cu. ft. O		1 cu. ft. H ₂ O	1.88 cu. ft. N
	1 cu. ft. CO	.5 cu. ft. O	1 cu. ft. CO ₂		1.88 cu. ft. N

§ 57. *Weight of a mixed gas.*

The method of calculating the weight per unit volume of a mixed gas is best illustrated by a numerical example based on a gas of the following composition:

H.....	10.	per cent by volume.
CH ₄	4.	per cent by volume.
C ₂ H ₄	2.	per cent by volume.
CO.....	20.	per cent by volume.
CO ₂	3.	per cent by volume.
O.....	1.	per cent by volume.
N.....	60.	per cent by volume.
	100.	

By multiplying these figures (see § 52) by the weight of 1 cu. ft. of the respective constituents—see column G, table 3, p. 51—the weight of each constituent in the 100 cu. ft. is obtained. Thus:

* See § 77.

H	10. × .0056 =	.056 lb.
CH ₄	4. × .045 =	.180 lb.
C ₂ H ₄	2. × .078 =	.156 lb.
CO	20. × .078 =	1.560 lb.
CO ₂	3. × .123 =	.369 lb.
O	1. × .089 =	.089 lb.
N	60. × .078 =	4.680 lb.
	100. cu. ft. =	7.090 lb.
	1. cu. ft. =	.0709 lb.

§ 58. *Specific gravity of a mixed gas.*

To determine the specific gravity of a mixed gas, first calculate the weight per cubic foot as explained in the previous section. Then:

$$\frac{\text{Weight per cu. ft.}}{.0807^*} = \text{Specific gravity with reference to air.}$$

$$\frac{\text{Weight per cu. ft.}}{.0056^*} = \text{Specific gravity with reference to hydrogen.}$$

§ 59. *Composition of gases by weight.*

Gas analyses are almost invariably stated in percentage by volume, since it is easier to measure a gas than to weigh it. However, it is sometimes desirable to know the composition by weight. The method of calculating this will be illustrated by a numerical example based on the results of § 57. From these data the gravimetric composition may be easily calculated as follows:

$$\frac{.056 \times 100}{7.09} = 0.79 \text{ H per cent by weight.}$$

$$\frac{.18 \times 100}{7.09} = 2.53 \text{ CH}_4 \text{ per cent by weight.}$$

$$\frac{.156 \times 100}{7.09} = 2.20 \text{ C}_2\text{H}_4 \text{ per cent by weight.}$$

$$\frac{1.56 \times 100}{7.09} = 22.00 \text{ CO per cent by weight.}$$

$$\frac{.369 \times 100}{7.09} = 5.20 \text{ CO}_2 \text{ per cent by weight.}$$

$$\frac{.089 \times 100}{7.09} = 1.25 \text{ O per cent by weight.}$$

$$\frac{4.68 \times 100}{7.09} = \frac{66.03}{100.00} \text{ N per cent by weight.}$$

Since the specific gravity of a gas with reference to H is equal to half its molecular weight (see column D, table 3) these values may also be used to calculate the analysis by weight. Thus:

* See column G, table 3, p. 51.

			Per cent by weight.
H10. × 1 =	10.	$\frac{10 \times 100}{1272} = 0.786$
CH ₄ 4. × 8 =	32.	$\frac{32 \times 100}{1272} = 2.515$
C ₂ H ₄ 2. × 14 =	28.	$\frac{28 \times 100}{1272} = 2.200$
CO20. × 14 =	280.	$\frac{280 \times 100}{1272} = 22.000$
CO ₂ 3. × 22 =	66.	$\frac{66 \times 100}{1272} = 5.180$
O 1. × 16 =	16.	$\frac{16 \times 100}{1272} = 1.258$
N60. × 14 =	840.	$\frac{840 \times 100}{1272} = 66.040$
<hr style="width: 100%;"/>			
1272.			<hr style="width: 100%;"/> 99.979

The slight discrepancy between the two methods is due to the fact that, for various reasons, the densities of gases as deduced from their chemical composition do not always agree exactly with the values found by direct experiment.

§ 60. *Air required for combustion.*

To determine the theoretical amount of air required for combustion of producer-gas, proceed as follows: Multiply the values given in columns O or P of table 3 — depending upon whether the results are to be, and the gas analysis is, in terms of weight or of volume respectively — by the percentage of the respective combustible constituents of the gas, the sum of these products giving the desired value. Thus:

H 10. × 2.39 =	23.9	
CH ₄ 4. × 9.56 =	38.24	
C ₂ H ₄ 2. × 14.34 =	28.68	
CO 20. × 2.39 =	47.80	
CO ₂ 3.		138.62 cu. ft. = air required for 100 cu. ft. gas.
O 1.		1.38 cu. ft. = air required for 1 cu. ft. gas.
N 60.		
<hr style="width: 100%;"/>			
100.			

However, since this particular gas contains some free O, the amount of air that must be furnished for combustion will be decreased by an amount equal to the amount of air that the free O represents. Thus: 1 × 4.782* = 4.782 cu. ft. less air than is required per 100 cu. ft. of gas. Actual theoretical amount of air required to burn 100 cu. ft. gas = 138.62 - 4.782 = 133.838 cu. ft.

* See § 77.

The actual amount of air required for the combustion of the gas will be the theoretical amount plus the per cent of air excess.

§ 61. *Weight and volume of products of combustion.*

The weight and volume of the products of combustion of producer-gas are calculated by means of the factors given in table 1, p. 38. A volumetric numerical case will be worked out with a producer-gas of the following composition:

H	10.	per cent by volume.			
CH ₄	4.	per cent by volume.			
C ₂ H ₄	2.	per cent by volume.			
CO	20.	per cent by volume.			
CO ₂	3.	per cent by volume.			
O	1.	per cent by volume.			
N	60.	per cent by volume.			
	100.	per cent by volume.			
			CO ₂	H ₂ O	N
H	10.	}	× 1.	10.	18.8
			× 1.88.		
CH ₄	4.	}	× 1.	4.	30.16
			× 2.	8.	
C ₂ H ₄	2.	}	× 7.54.		22.62
			× 2.	4.	
			× 11.31.		
CO	20.	}	× 1.	20.	37.60
			× 1.88.		
CO ₂	3.		28.	22.	109.18
O	1.				
N	60.				
	100.				

That is, in burning the combustible constituents of 100 cu. ft. of gas of the composition given, we would get 28 cu. ft. CO₂, 22 cu. ft. H₂O and 109.18 cu. ft. N. These results will be modified, however, by the non-combustible or diluent constituents of the gas — namely, CO₂, O, and N. Since in every 100 cu. ft. of the gas in question there are 3 cu. ft. of CO₂, which go into the products of combustion, the latter will be augmented by that amount. The 1 cu. ft. of O in the gas will decrease the amount of O and associated N that must be furnished by the air for the burning of the combustible constituents; *i.e.*, there will be 3.77 cu. ft. of N less in the products of combustion due to the 1 cu. ft. of free O in the gas. The 60 cu. ft. of N in the gas will simply increase the products of combustion by a corresponding amount. The corrected values are as follows:

$$\begin{aligned} \text{CO}_2 &= 28 + 3 = 31 \text{ cu. ft.} \\ \text{H}_2\text{O} &= \text{same as before, } 22 \text{ cu. ft.} \\ \text{N} &= 109.18 - 3.77 + 60. = 165.41 \text{ cu. ft.} \end{aligned}$$

The above may be worked out in a similar manner in terms of weights by means of the gravimetric factors in table 1, p. 38, and a gas analysis in per cents by weight. In ordinary practice, the products of combustion will also contain air due to the air excess used in burning the gas. Thus, if in burning the gas for which we have just calculated the volumes of the products of combustion we use an air excess of 25 per cent, we will then require $1.33 + 1.33 \times .25 = 1.66$ cu. ft. of air per cubic foot of gas burned, and of this quantity of air 0.33 cu. ft. will pass into the products of combustion without giving up its oxygen.

The products of combustion from burning 1 cu. ft. of this gas with 25 per cent air excess would then contain 0.31 cu. ft. CO_2 , 0.22 cu. ft. H_2O , 1.65 cu. ft. N, and 0.33 cu. ft. atmospheric air.

§ 62. *Heat carried away by products of combustion.*

The sum of the products of the weights or volumes by the respective gravimetric or volumetric specific heats of the constituents of the products of combustion will be the amount of heat carried away per pound or cubic foot of the gas for each degree of temperature of the gases above the atmosphere.

Thus, for the products of combustion calculated in the preceding section:

A	B	C	D
CO_231	$\times .0265 =$.0082
H_2O22	$\times .0173 =$.0038
N.....	1.65	$\times .0192 =$.0317
Air excess.....	.33	$\times .0191 =$.0063
			.0500

- A Combustion product constituent.
- B Quantity of "A" per unit of gas.
- C Volumetric specific heat, column J, table 3, p. 51.
- D Heat units per degree of temperature.

If the temperature of the combustion products were 300 degrees F., the heat carried away by the combustion products of 1 cu. ft. of gas with 25 per cent air excess would be $0.05 \times 300 = 15$. B. t. u.

§ 63. *Sensible heat loss of producer-gas.*

The number of pounds or cubic feet of the gas evolved per

unit weight of fuel multiplied by the gravimetric or volumetric specific heat of the gas will give the heat units carried away as sensible heat in the gas per unit weight of fuel, for each degree of temperature of the gas above the atmosphere. For calculations of specific heat, see § 52.

§ 64. *Flame temperature.* (See App., notes 8 and 9.)

The resulting flame temperature of the combustion of any substance is found by dividing the number of heat units evolved, by the products of combustion multiplied by their respective specific heats. (See App., note 2.) Thus for producer-gas:

$$\frac{\text{Heat units evolved per cu. ft.}}{\text{CO}_2 \times .0265 + \text{H}_2\text{O} \times .0173 + \text{N} \times .0192} = \text{Temperature.}$$

However, since in practical work there will always be an excess of air, this must be taken into account when calculating the temperature, thus:

$$\frac{\text{Heat units evolved per cu. ft.}}{\text{Air excess} \times .0191 + \text{CO}_2 \times .0265 + \text{H}_2\text{O} \times .0173 + \text{N} \times .0192} = \text{Temperature.}$$

The volume of the products of combustion are to be calculated by the method given in § 61.

§ 65. *Explosive mixtures.* (B 163.)

Since producer-gas is frequently used in gas engines, it will be desirable to understand the conditions under which explosion may take place. "Any combustible gas will combine completely with oxygen, (1) when the mixture contains the two gases in the proper proportion; (2) when the temperature and pressure of the mixture are within fixed limits."

"One cubic foot of hydrogen requires half a cubic foot of oxygen for complete combustion, and the latter is furnished by 2.4 cu. ft. of air. A mixture of hydrogen with either oxygen or air in these proportions is termed *explosive*, because the combustion when once started spreads with so great rapidity throughout the whole mixture as to be called an explosion." Explosive mixtures cease to be inflammable, (1) when there is a certain excess either of the gases, or of an inert gas present, and (2) by a reduction of pressure. Table 2 gives the explosive mixtures for several gases:

TABLE 2.

COMBUSTIBLE GAS	EXPLOSIVE MIXTURE AIR TO 1 VOL. GAS
Hydrogen	2.4
Carbon monoxide.....	2.4
Marsh gas	9.6
Olefiant gas.....	14.4
Acetylene.....	12.
Coal gas	5.7

§ 66. *Calculation of moisture in air.*

The amount of moisture or water vapor carried or held by air depends on the degree of saturation of the latter. Table 11, p. 267, gives the weights of vapor in pounds for 1 cubic foot of saturated air at different temperatures. Table 12, p. 268, gives the relative humidity of air; for definitions see §§ 7, 8, 9, and 10.

To determine the amount of vapor in air, multiply the values given in column *F* of table 11, p. 267, by the relative humidity, found from table 12, for the corresponding temperature, and the result will be the weight in pounds of the moisture in 1 cubic foot of air or gas, at the given temperature.

CHAPTER IV.

COMMERCIAL GASES.

§ 67. *Definition of commercial gas.*

A commercial gas is not a definite compound and is always made up of a plurality of constituents, the number of the constituents and their proportion being dependent upon the method of manufacture and the nature of the raw fuel. Table 3, p. 51, gives the properties of these constituents, the object of this chapter being to show their general effect upon the various commercial gases and especially upon producer-gas; by co-ordinating these in their proper relation to one another, we thereby secure a basis for the extensive discussion of producer-gas in the following chapters.

§ 68. *Hydrogen.*

This is colorless, odorless, non-poisonous, and the lightest known substance. The effect of hydrogen in a commercial gas is to make it lighter, to increase the heating value, the amount of air required for combustion, and the heat loss in the products of combustion. It is very combustible, and hydrogen uniting with oxygen burns with a pale blue nearly non-luminous flame, producing water in the form of water vapor. The reaction is as follows:

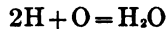

In the gas-producer it is formed as follows:

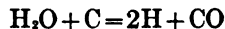

Hydrogen is always a desirable constituent of a commercial gas on account of its high calorific power and its avidity for combustion; however, as it will not stand much compression without danger of self-ignition, the amount that may be present in producer-gas, when the latter is to be successfully used in a gas engine, is limited.

§ 69. *Marsh gas.*

It is sometimes called methane, and is the main constituent of natural gas and "fire-damp" in coal mines. It has a high calorific power, is colorless, slightly soluble in water, odorless, and burns readily with a slightly luminous flame. However, the rate of combustion is much slower than that of hydrogen or carbonic oxide, which makes it a very desirable constituent of producer-gas, especially when the latter is to be used in gas engines, as the presence of marsh gas decreases the danger of back-firing and pre-ignition by retarding the rate of combustion. It is produced by the decomposition of vegetable matter under restricted access of oxygen. It is also one of the products of the destructive distillation of coal. When it burns, the following reaction takes place:

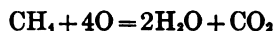
§ 70. *Olefiant gas.*

This is sometimes called ethylene or ethene, and is the main illuminating constituent of coal gas. It is evolved when oil or coal is heated. It has a very high calorific power, is odorless, colorless, and burns with a highly luminous flame, having fourteen times the luminosity of marsh gas. On complete combustion, the following reaction takes place:

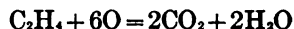
§ 71. *Carbonic oxide.*

This is also known as carbon monoxide and is one of the most important constituents of producer-gas. It is odorless, colorless, practically insoluble in water, very poisonous (see § 339), and burns with a distinctive pale blue flame. The reaction is as follows:

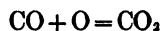

It is formed by bringing carbon dioxide in contact with incandescent carbon, the reaction being exothermic and taking place as follows:

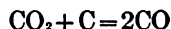
§ 72. *Carbon dioxide.*

It is also called carbonic acid and carbonic anhydride. It is colorless, odorless, soluble in water (see table 20, p. 275), non-

combustible, and is formed by the complete combustion of carbon and oxygen at high temperature. Thus:

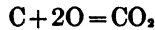

For an extended discussion of the effects of carbon dioxide on producer-gas, see Chapter 9.

§ 73. *Oxygen.*

This is tasteless, odorless, invisible, and slightly heavier than air. Its presence in a fuel gas is indicative either of leakage after the gas has been cooled or of improper action in the gas-producer, since it could not pass through a gas-producer in normal condition without combining with the combustible gas.

§ 74. *Nitrogen.*

This is a colorless, odorless, non-combustible gas and is always present in large quantity in gases produced by incomplete combustion, as in producer-gas, for instance. It has no influence except to act as a diluent. It forms four-fifths of the volume of air.

§ 75. *Hydrocarbons.*

The number of known hydrocarbons is nearly two hundred. The term is applied to all compounds consisting only of hydrogen and carbon. These compounds exist in gaseous, vaporous, liquid, and solid states. Their character depends in a large measure on the temperature at which the reactions take place. Low temperatures are conducive to the formation of the easily condensed tarry compounds, while with high temperatures the yield of hydrogen and permanent gases is greatly increased. (See § 106, and Chapter 23.)

§ 76. *Water vapor.*

As the vaporization of the moisture in, and the destructive distillation of, the fuel always produce steam or water vapor, it is nearly always found in producer-gas. Above the boiling point corresponding to the pressure of the gas, all the water will be in the vaporous state; below this point, part of the steam will condense, but a certain amount of water will always remain in the gas. Water vapor, on account of its high specific heat, may cause a large heat loss in the products of combustion. For the determination of the amount of water vapor in a gas, see § 331.

§ 77. *Air.*

This consists of a mixture of oxygen and nitrogen with very small quantities of other substances, such as argon, ammonia, carbon dioxide, and water vapor, the amount of the latter depending upon the temperature and relative humidity of the atmosphere. The method of calculating this will be found in § 66. The amounts of argon, ammonia, and carbon dioxide are so small that they need never be considered.

Pure dry air is composed of 20.91 parts O and 79.09 parts N by volume, or 23.15 parts O and 76.85 parts N by weight.

Ratio of N to O:

$$\text{By volume, } \frac{79.09}{20.91} = 3.77. \quad \text{By weight, } \frac{76.85}{23.15} = 3.32$$

Ratio of air to O:

$$\text{By volume, } \frac{100}{20.91} = 4.78. \quad \text{By weight, } \frac{100}{23.15} = 4.315$$

Ratio of air to N:

$$\text{By volume, } \frac{100}{79.09} = 1.265. \quad \text{By weight, } \frac{100}{76.85} = 1.302$$

§ 78. *Illuminants.*

In a gas analysis, part of the constituents are sometimes mentioned as "illuminants," the term "illuminant" meaning a substance that makes the gas flame luminous, and olefiant gas is sometimes included with this. The percentage present in producer-gas is usually very small.

§ 79. *Natural gas.*

Natural gas is made by a secret process of nature, the principal constituent being marsh gas and the exact composition varying considerably with the different districts. While an ideal fuel, it is commercially available in only a few localities, and even there the uncertainty of the continuity of the supply makes its use uncertain.

§ 80. *Oil gas.*

This is made from oil, generally by allowing the liquid to flow slowly and in a thin, continuous stream through a highly heated pipe or retort, where the oil is vaporized. This usually evolves hydrogen, marsh gas, and olefiant gas mixed with vapor, which will usually be condensed in the scrubbing apparatus.

§ 81. *Coal gas.*

It is also called "bench" or "illuminating" gas; the former refers to the benches which hold the retorts, while the latter is dubious, since several other gases are distributed as illuminating gas. Coal gas is made by the destructive distillation of bituminous coal in externally heated, air-tight retorts. The resulting gas is withdrawn by an exhauster and the residual coke is removed periodically.

§ 82. *Coke-oven gas.*

This is a gas made in a by-product coke oven; that is, the gas, tar, and ammonia evolved by distilling coal in a closed oven are saved and used as a by-product. Its composition is quite similar to coal gas. (See Chapter 19.)

§ 83. *Water gas.*

This is produced by the decomposition of steam when the steam acts on incandescent carbon. This reaction is discussed in detail in § 117. As this reaction is endothermic (see § 34), the temperature of the carbon will soon be reduced to a point where the reaction cannot take place, and it will then become necessary to store more heat in the carbon. This is almost universally done by shutting off the steam and blowing the carbon with air, thus bringing it back to incandescence and making it ready for the next steaming: this makes the system intermittent. On account of the large amount of carbon monoxide present, the gas is very poisonous. (See § 339.)

§ 84. *Carbureted water gas.*

To change the blue flame of water gas to one that will be luminous, various methods are in use for injecting hydrocarbons — as naphtha or oil — into the gas and making it luminous. The resulting mixture is known as carbureted water gas; a large portion of the illuminating gas sold in this country is carbureted water gas.

§ 85. *Comparison of the commercial gases.*

The relative properties of the several commercial gases described, and the relation that these sustain to producer-gas, is shown in table 4, p. 50, which was compiled by Gow. This also shows the relation that blast-furnace gas sustains to the other commercial gases. The blast furnace is a huge gas-producer, and the resulting gas is very closely allied to producer-gas.

§ 86. *Tabulated data.*

Table 3 gives a summary of the properties and data on the combustion of the constituents of commercial gases. The values

TABLE 4.
COMMERCIAL GASES.

Names	H	CH ₄	C ₂ H ₄	N	CO	O	CO ₂	B. t. u. in 1 cu. ft. explosive mixture	B. t. u. cu. ft.	O required for combustion	Air for combustion
Natural gas (Pittsburg)	3.0	92.0	3.0	2.0				91.0	978.	1.94	9.73
Oil gas	32.0	48.0	16.5	3.0		0.5		93.0	846.	1.61	8.07
Coal or bench gas	46.0	40.0	5.0	2.0	6.0	0.5	0.5	91.7	646.	1.21	6.05
Coke-oven gas	50.0	36.0	4.0	2.0	6.0	0.5	1.5	91.0	603.	1.12	5.60
Carbureted water gas	40.0	25.0	8.5	4.0	19.0	0.5	3.0	92.0	575.	1.05	5.25
Water gas	48.0	2.0		5.5	38.0	0.5	6.0	88.0	295.	0.47	2.35
Producer-gas from hard coal	20.0			49.5	25.0	0.5	5.0	68.0	144.	0.22	1.12
Producer-gas from soft coal	10.0	3.0	0.5	58.0	23.0	0.5	5.0	65.5	144.	0.24	1.20
Producer-gas from coke	10.0			56.0	29.0	0.5	4.5	63.0	125.	0.19	0.98
Blast-furnace gas	1.0			60.0	27.5		11.5		91.	.143	.72

given in column E are only approximate, but are close enough for all engineering calculations. The exact values are as follows: H. = 1; CH₄ = 7.99; C₂H₄ = 13.97; CO = 13.97; N = 14.01; O = 15.96; CO₂ = 21.95. Columns F, G, and I are taken from the Smithsonian Physical Tables.

$$H = \frac{1}{G}$$

$$J = \frac{I}{H}$$

K is calculated by the method given in § 47.

$$L = \frac{G}{K}$$

M and N are calculated by the method given in § 56.

$$O = 4.32 \times M. \quad (\text{See } \S 60.)$$

$$P = 4.782 \times N. \quad (\text{See } \S 60.)$$

Q. These values have been determined by various experimenters.

$$R = \frac{Q}{H}$$

S is taken from Poole's Calorific Power of Fuels.

TABLE 3.
CONSTITUENTS OF COMMERCIAL GASES.

Name	PROPERTIES										COMBUSTION DATA						Combustion products			
	A	B	C	D	E	F	G	H	I	J	K	T	M	N	O	P		Q	R	S
	Symbol	Atomic weight	Molecular weight	H = 1	AIR = 1	Weight per cu. ft. in lb.	Cu. ft. per lb.	I Per lb.	J Per cu. ft.	Pounds of carbon in 1 lb. of gas	Pounds of carbon in 1 cu. ft. of gas	M 1 lb. of A	N 1 cu. ft. of A	O 1 lb. of A	P 1 cu. ft. of A	Q 1 lb. of A	R 1 cu. ft. of A	S Resulting temperature of combustion F.	T	
Hydrogen	H	1	2	1	1	.069	179	3.4	.0194			8	5	34.56	2.39	62100	346	4813	H ₂ O	
Carbon	C	12	24									2	11	52		14500	4892	4892	C + 2O = CO ₂	
Carbon	C	12	24									1	5	76		4450	2639	2639	C + O = CO	
Marsh gas	CH ₄	16	16	8	.559	.045	22.4	.592	.0264	.0337		4	2	0	17.28	9.56	23976	1070	4063	CH ₄ + 4O = CO ₂ + 2H ₂ O
Olefiant gas	C ₂ H ₄	28	28	14	.967	.078	12.8	.37	.0289	.0669		3	3	0	14.8	14.34	21476	1670	5400	C ₂ H ₄ + 6O = 2CO ₂ + 2H ₂ O
Carbon monoxide	CO	28	28	14	.967	.078	12.8	.247	.0193	.0334		3	5	2	4.7	2.39	4385	342	5400	CO + O = CO ₂
Steam at 212° F.	H ₂ O	18	18	9	.469	.036	27.7	.48	.0173											
Nitrogen	N	14	28	14	.972	.078	12.8	.245	.0192											
Oxygen	O	16	32	16	1.105	.089	11.2	.217	.0194											
Carbon dioxide	CO ₂	44	44	22	1.529	.123	8.12	.215	.0265	.0355										
Air					1.000	.0807	12.38	.237	.0191											

NOTE. All calculations with the exception of those for steam are made on a basis of 32° F. and 29.92 in.

¹ In centigrade units, see table 23, p. 301

CHAPTER V.

STATUS OF PRODUCER-GAS.

§ 87. *Progress made.*

The first work for which gas-producers were used was the firing of furnaces for the manufacture of iron, and even to-day this is still a large field of application. The producers shown in Fig. 22-46 are largely used for such work in this country. Without the gas-producer, the iron and steel industry could never have reached the magnitude that it has in this country, and the successful commercial gasification of the cheaper fuels has done more to develop the quality and to reduce the cost of manufacture than any other factor.

Many engineers are beginning to appreciate the superior advantages of producer-gas as a fuel, and it is now recognized by progressive manufacturers as one of the foremost means of effecting a saving in the cost of production. An improvement in the quality and quantity of the manufactured article is the result of its use, and it is now being introduced in many of our industrial establishments. However, any one familiar with the merits of producer-gas must admit that it has not received the recognition that it deserves — especially in America. It has many advantages over solid fuel, both in efficiency and economy. That there are certain disadvantages attending the use of gaseous fuel must be admitted, but they are so few and unimportant that they cannot militate against the many advantages.

The limited and restricted development of the producer-gas industry in America is due to three factors: first, ignorance of the subject; second, an abundant fuel supply which has not made a high fuel economy imperative; third, the want of adaptability of producers for the work that they are expected to do.

§ 88. *Ignorance.*

While the number of patents which have been taken out on gas-producers and producer-gas processes is very large, many of

the patentees have shown an unusual lack of originality in the principles upon which gas production is based. Many inventors seem to be satisfied by merely modifying details of forms already in use; very few have gone back to the physical and chemical laws upon which gas production is based and, after studying the nature of the various operations, have considered how these could be applied. In some cases, recent patents use only copies of old ideas that had been tried a quarter of a century ago.

The various text-books on Metallurgy, Fuel, Applied Chemistry, and allied subjects have given very little attention to producer-gas, and some of the books that have referred to it have shown a marked absence of care, thought, and original research on the part of the authors. Heretofore the subject has not been treated as a whole in this country, and it surely has not received the attention that its magnitude and importance deserve. However, its literature is quite extensive, as is shown by the bibliographical reference list given in Chapter 30. The chronological arrangement of the list is interesting in that it shows the growth of interest in the subject from year to year.

Inasmuch as these references are distributed through a large number of periodicals and books, covering a range of sixty-four years, the scattered data contained therein have not been generally available. One of the most potent means of interesting engineers, manufacturers, and others in the advantages of producer-gas and of increasing its use will be the dissemination of conservative, comprehensive, analytical, and authentic data on the producer-gas industry.

§ 89. *Fuel supply.* (B 107, B-114, B 118, B 130.)

One of the most serious problems of the near future will be that of fuel supply. We are even now returning to mines that were abandoned several years ago and are beginning to rework them with an economy unknown before; and coal seams, formerly regarded as being too thin or too poor to work, are being investigated and purchased in large areas. Brown coal, lignite, peat, sawdust, and other refuse are now being used in European gas-producers, and these low-grade fuels must soon be used extensively in this country. While natural gas is now piped long distances and utilized in manufacturing industries where the use of a gaseous fuel is imperative, yet the states that have gas wells

will soon enact laws that will prevent piping the gas outside the state or using it for anything except domestic service.

On account of its high fuel economy, producer-gas will be one of the best means of curtailing the useless waste of fuel, utilizing low-grade fuels, and presenting a substitute for natural gas.

§ 90. *Inadaptability.*

On the other hand, no gas-producer can be a panacea for all metallurgical ills. The attempt to design the so-called universal producers has always been followed by ignominious failure. There is no "best" form of producer for all purposes. In order that a producer shall be successful, it must be adapted to the particular work it has to do. A producer admirably suited for supplying a steel furnace may be entirely unfit for firing a steam boiler or for furnishing gas to a gas engine. Hence, it is impossible to design a gas plant that will be equally serviceable under all conditions.

CHAPTER VI.

CLASSIFICATION OF GAS-PRODUCERS.

Gas-producers may be classified from seven different points of view, as follows:

§ 91. *Method of operation.*

(1) Externally heated, air-tight retorts, for the destructive distillation of bituminous coal; the resulting gas is withdrawn from the retort by an exhauster, below atmospheric pressure; the residual coke is removed periodically. This is the ordinary form of by-product coke oven.

(2) Producers in which coal is consumed or converted into gas by combustion with air; the hydrocarbons are distilled by the heat of the underlying fuel; the residual coke is first burned to CO_2 , which is then reduced to CO by contact with the incandescent carbon. This is the simple form of the Siemens producer, as shown in Fig. 18.

(3) Producers in which the same result is reached, with a modification in the composition of the resulting gas, due to the introduction of steam with the air supply. This is the usual form of producer.

(4) Producers in which incandescent fuel is used to decompose steam, either continuously by means of externally heated retorts, or intermittently by the use of regenerating chambers, in which the carbon is first made incandescent by an air-blast, and through which steam is then passed, the air-blast being shut off. This is the form of the ordinary water-gas producer.

§ 92. *Method of supporting fuel.*

(1) Solid bottom producers, in which the fuel rests on the bottom of the producer, as in Fig. 15.

(2) Water-seal producers, in which the ashes are received in a trough of water, as in Fig. 44.

(3) Bar-bottom producers, in which the fuel rests on grate bars, as in Fig. 41.

(4) Revolving bottom producers, to facilitate the removal of the ashes and clinkers, as in Fig. 34.

§ 93. *Place of removing gases.*

- (1) Top of producer, which is the usual way.
- (2) Between top and bottom of fuel bed.
- (3) Bottom of producer, as shown in Fig. 47.

§ 94. *Means of agitating fuel.*

- (1) Hand poking, the usual way.
- (2) Mechanical poking, as shown in Fig. 42.
- (3) Moving grate, as shown in Fig. 34.

§ 95. *Nature of draft.*

- (1) Natural draft, as shown in Fig. 18.
- (2) Forced draft, which is the usual way.
- (3) Induced draft.
 - (a) Draft induced by an exhauster, as in the Loomis producer, Fig. 47.
 - (b) Draft induced by the gas-engine piston, as in the suction type of producer.

§ 96. *Direction of blast.*

- (1) Vertical, as in Fig. 37.
- (2) Lateral, as in Fig. 50.
- (3) Downward, as in the inverted combustion or down-draft type.

§ 97. *Continuity of operation.*

- (1) Continuous, as in the ordinary type.
- (2) Intermittent, as in the Loomis, Fig. 47.
- (3) Self-adjusting.
 - (a) Varying with the rate of gas consumption, as in the ordinary suction type.
 - (b) Maintaining a fixed supply of gas, as in the Wile, Fig. 48.

CHAPTER VII.

THE MANUFACTURE AND USE OF PRODUCER-GAS.

(B 214.)

§ 98. *Nature of producer-gas.*

Producer-gas is the product of an incomplete combustion in the gas-producer. In this respect it differs from ordinary retort or coal gas, in that the whole of the combustible part of the fuel is gasified. No combustible residue or coke is left, and the heat required for the gasification is obtained in the interior of the producer by the combustion there of a portion of the charge of solid fuel which is being gasified. Hence, there will always be a necessary loss in the producer itself, and therefore the advantages of producer-gas are to be sought in the greater convenience and economy of its use and manipulation.

Producer-gas may also be defined as "the generic name for the gas resulting from the comparatively slow resolution of solid fuel by means of the heat derived by a partial combustion of the fuel itself, the exact composition of the gas being dependent upon the nature of the fuel, the arrangement and the method of operating the producer." (B 39.)

The terms "Riche gas," "Mond gas," "Loomis gas," "Siemens gas," or "Dowson gas" are misleading, as the gas is virtually the same in all these instances, and is simply made in producers bearing the respective names. However, the exact proportion of the different elements and compounds present in the gas will depend on the type of producer and the nature of fuel used in making the gas.

§ 99. *Simple producer-gas.*

The simplest form of gas-producer is the Siemens, which is shown in Fig. 18. In order to make the demonstration simple, it may be assumed that coke or charcoal is the fuel used in the producer under discussion. The oxygen of the air, entering the producer and passing up through the grates, comes into contact

with the carbon. As this is in excess and the temperature high, carbon monoxide only should be formed as follows:

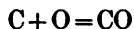

However, some carbon dioxide may be formed as follows:

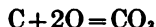

The heat generated by this reaction is taken up by the CO_2 and the nitrogen of the air supplied. As the carbon dioxide is at a very high temperature, it ascends and thus brings the fuel above it to incandescence. In contact with this glowing carbon, the CO_2 should be instantly decomposed into CO .

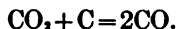

If the air supplied to the producer is dry and the decomposition complete, the resulting gas will consist of a mixture of carbon monoxide and nitrogen, and is called simple producer-gas to distinguish it from the gas enriched by hydrogen and hydrocarbons.

§ 100. *Steam-enriched gas.*

Since dry air is not usually available, and coke and charcoal are generally too expensive for fuels, the use of steam with the air blast is imperative to secure a proper operation of the producer; and as a higher heating value is required than can be secured with simple producer-gas, the latter is used very little in practice. Producer-gas is almost universally enriched by the use of steam; the action of this is of vital importance and is discussed in detail in Chapter 8.

§ 101. *The action in the producer.* (B 42, B 74, B 77.)

For the proper understanding of the action of a gas-producer, it is desirable to divide it into four zones, the relative position of these being given in Fig. 2. However, the line of demarcation between the respective zones is not very distinct in practice.

§ 102. *Ash zone.*

The primary object of the ash zone is to keep the intense heat developed by the combustion of the fuel away from the grate, and thus prevent it from "burning out." The ash zone is theoretically of little importance; however, it has some practical value in that it heats the air and steam before they go to the

combustion zone. As the ashes accumulate, the thickness of the fuel bed must be increased to make room enough for the

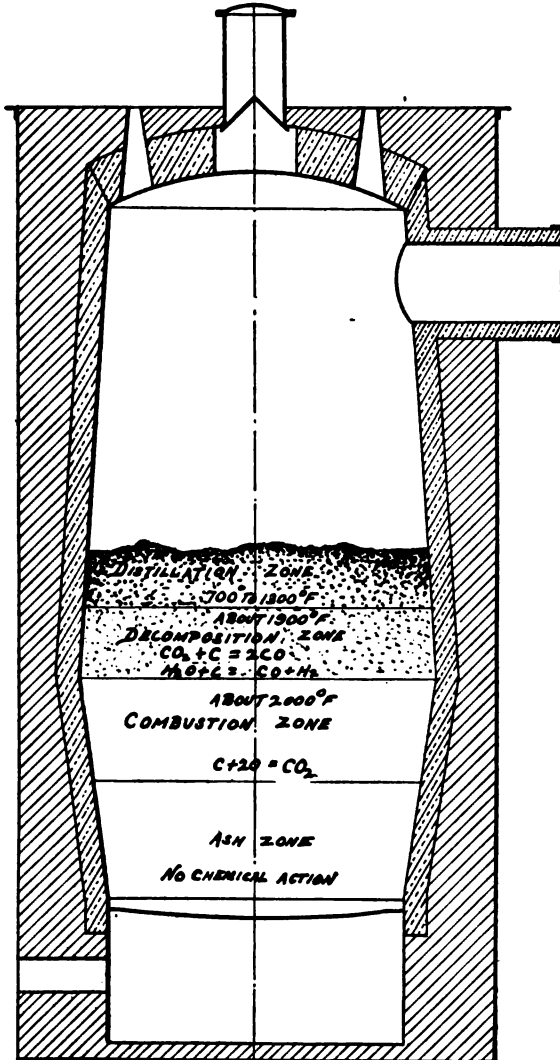

FIG. 2. — ZONES OF A GAS-PRODUCER.

combustion zone; failure to recognize this will result in excess CO_2 and undecomposed steam in the gas.

§ 103. *Combustion zone.*

In this zone the air and steam meet the carbon, the oxygen uniting with the incandescent C to form CO₂, while the steam is superheated and possibly begins to decompose.

§ 104. *Decomposition zone.*

This is where CO is generated, the steam decomposed into H, and the CO₂ reduced to CO. A large amount of heat will be absorbed in this zone to compensate for the carbonization of CO₂ and the decomposition of the steam; in order that the reactions may take place, the temperature must be kept above 1800 degrees F.

§ 105. *Distillation zone.*

This occupies the upper part of the fire. The addition of fresh fuel always lowers the temperature, but the heat from the lower zones distils the volatile constituents of the fresh fuel. The nature of the hydrocarbons will depend upon the temperature. If the temperature is kept high, the hydrocarbons will be easily broken up, and the hydrogen liberated. This means a large yield of permanent gases and very little tar and soot. If the temperature is kept low, the hydrocarbons will be easily condensed and the amount of tar and soot will be greatly increased. For the complete distillation of the coal, a long exposure to a high temperature is necessary on account of its tendency to coke into large masses which are broken up with difficulty.

§ 106. *Hydrocarbons.*

Blauvelt and Taylor have argued that the unstable hydrocarbons enhance the value of the gas for heating purposes, while Campbell (B 66) argued against most of their statements. The discussion is summarized in the following: While it must be admitted that the hydrocarbons contribute to the heating value of the gas, yet the actual value of these has been greatly overestimated. They are so unstable and uncertain in their reactions at varying temperatures — and generally it is not possible to keep the temperature fluctuation within the required range that will not affect these reactions — that they usually cause more trouble than they are worth. In general, the best way is to have the temperature of the distillation zone high enough to distil all the hydrocarbons and then pass them through an incandescent mass of carbon. (See § 269.)

§ 107. *Condition of fire.* (B 66.)

"A hot, deep fire will best promote the desired reactions, but even with a bed of incandescent coke ten feet in depth, the escaping gases will contain some CO₂. In practice, the depth of fire cannot be much over six feet. If deeper, it is found that, no matter how thoroughly the upper surface may be stirred, the lower part of the fire is not thoroughly broken up by the poking and the zone of combustion becomes honeycombed with large cavities, affording passage for undecomposed steam and air. This condition is most marked along the walls, and the intense heat produced on the interior surfaces of these coke chimneys causes clinkers to fuse to the brickwork. Practice therefore demands that the thickness of the fire be limited, that steam be used to avoid extreme temperatures, and that the mass be kept thoroughly broken by poking."

However, the fuel beds, in producers having mechanical means for its agitation, may be considerably deeper than given in the preceding paragraph, and at the same time induce more desirable conditions for satisfactory gasification.

§ 108. *Temperature of gas.*

On account of the sensible heat loss (§ 147) when the gas leaves at a high temperature, the producer should be so designed and operated that the temperature of the issuing gas will be low. The quantity of steam used and depth of fuel bed should be so regulated that the temperature of the fire is kept low. Further, a recuperative device (see § 113) should be used to pre-heat the air and thus further deprive the gas of its sensible heat and return it to the producer. The drying and pre-heating of the fuel by means of the sensible heat in the gas are also very desirable.

It must be distinctly understood that this cooling of the gas should be done at the producer and in such a way that the abstracted heat is returned to the producer. Where the gas is used in furnaces, the heat loss between the producer and furnace should be kept as low as possible.

However, the sensible heat of the gas is of no value when the gas is used in an engine, and a low temperature is very desirable for such work.

Hot gas requires larger ports and passages than cold gas. The calorific power of a cubic foot of cold gas is distributed over

about three cubic feet when the gas is at a temperature of 1200 degrees F. Hence, it takes about three cubic feet of hot gas to carry as many heat units as one cubic foot of cold gas contains.

With reference to the use of producer-gas in steel furnaces, Campbell (B 66) gives the following: "The sensible heat of the gas is regarded as a total loss, since a rise in temperature at the entrance flue of the furnace means a similar and equal rise in temperature for the products of combustion escaping in the stack. It is therefore important to so adjust the calorific work of the producer that the heat developed is utilized in the heart of the fire and the escaping gases are kept as low as possible. The use of steam will lower the temperature, but it must be remembered that the cooling of the upper part of the fire, by steam from the grate, implies cooling of the zones of decomposition and combustion to the same degree, so that the utilization of the sensible heat of the upper surface of the fuel involves the presence of an increased amount of undecomposed steam in the gases."

Where producers are used for heating regenerative steel furnaces, "some engineers advocate — with plausible and, at first sight, conclusive reasons — placing the producer near the furnace, under the impression that thereby they save the sensible heat of the gas. It is true that when the gas is hot, less heating of the gas chambers is required, and hence less checkerwork will suffice, but this is a small matter and has no bearing on the fuel economy. Whatever is gained by hot gas at the incoming end, is lost on reversal in the outgoing products of combustion. Moreover, a special system of valves must be used to handle the hot gases; ordinary valves soon warp and leak, and water cooling is not to be thought of in this case, for this involves chilling the gas, which is manifestly opposed to the intent of the practice in question. With hot gas, the soot and tar will be deposited in the regenerators and this is objectionable. Cool gas is very desirable for the preservation of dampers and valves. Hot gas does not tend to economize energy, since the loss of heat in the escaping products of combustion offsets the apparent gain."

§ 109. *Pre-heating air.* (B 19.)

The use of pre-heated air is of the greatest importance whenever it is desirable to use fuel in an economical manner. The

pioneer iron masters recognized this fact at an early period in the development of the blast furnace, and the pre-heating of air for that purpose was begun as early as 1829. In any gas furnace it is very desirable to use air at a temperature considerably above that of the atmosphere. The Hoffman kiln which is used so extensively in Europe, the Siemens regenerative furnace which is used the world over, and many of the direct-acting regenerators would not be of any use at all without the use of pre-heated air.

The primary function of pre-heated air is to increase the intensity of combustion. At a high temperature the affinity of air for carbon is greater than at atmospheric temperature, and combustion will be very much more vigorous. Pre-heated air should be used in gas-producers whenever it is possible to do so. In producers used for power purposes, the waste heat in the gas engine exhaust should be used in pre-heating the air.

§ 110. *Uses of producer-gas.*

The following diagram shows the general uses of producer-gas:

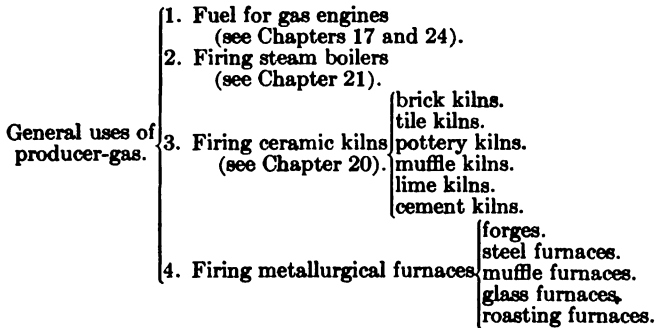

Since producer-gas is frequently used in connection with re-generators and recuperators, these appliances are discussed in § 112, 113, 114 and 115.

§ 111. *Advantages of gas-firing.*

The general advantages of gas-firing are:

1. Less loss by oxidation in furnace; this is made possible by the decreased air excess required for combustion.
2. Temperature and character of flame are under better control.
3. Higher working temperatures may be obtained.

4. Increased fuel economy.

For specific advantages when applied to a particular class of work, see § 252 and § 256.

§ 112. *Regenerators.*

In order to pre-heat the air — and in some cases the gas also — for combustion, some of the sensible heat in the products of com-

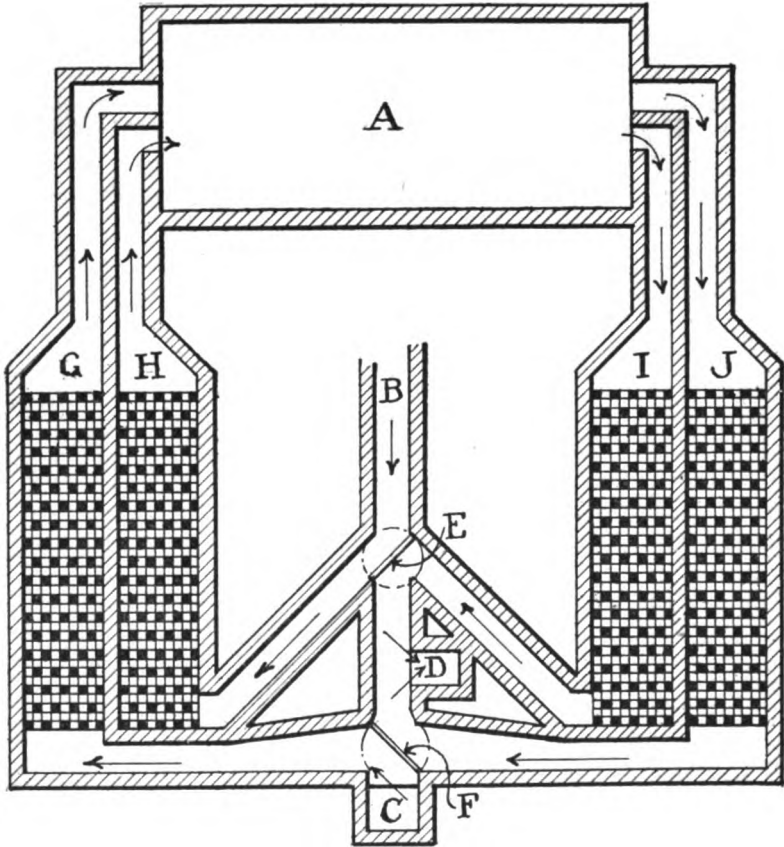

FIG. 3. — DIAGRAM OF REGENERATOR.

bustion is filtered out and given to the air or gas by means of a regenerator. The details of construction of the latter will vary with local conditions. However, the principle embodied is illustrated in Fig. 3. *A* is the furnace. *B* is the gas flue from pro-

ducer. *C* is the air-inlet flue. *D* is the chimney. *E* and *F* are reversing valves. *G* and *J* are the air regenerators. *H* and *I* are the gas regenerators. The chambers *G*, *H*, *I*, and *J* are filled with checkerwork, which acts as a heat trap.

The operation is as follows: The air comes in through *C*, and the gas through *D*; as they pass through *G* and *H* they become heated, on account of the high temperature of the brick checkerwork through which they pass. Then they pass to the furnace which they enter through separate ports, mixing directly on the inside where the intense combustion begins. The products of combustion then pass out through the ports in the opposite side of the furnace and enter the regenerator chambers *I* and *J*, where the checkerwork absorbs a portion of the sensible heat; from *I* and *J* the gases go to the stack *D*. In the illustration the arrows indicate the respective directions of travel.

In this stage of the process, the incoming air and gas absorb the heat stored in *G* and *H*, which are cooled down; at the same time, the escaping products of combustion have been depositing a portion of their sensible heat in *I* and *J*, causing them to become heated up. After about thirty minutes of use, *G* and *H* will have given up the larger part of their heat, and *I* and *J* will have absorbed about their full capacity — since, in order to absorb heat, *I* and *J* must be at a lower temperature than that of the combustion products. Then the valves *E* and *F* are turned, and the direction of the gas, air, and combustion products reversed, when exactly the same action takes place again. This is the essential principle of the Siemens “regenerative furnace,” and is thus known. A modified form of regeneration is used in the Mond by-product process. (See § 229.)

§ 113. *Recuperation.*

Recuperation is a system of pre-heating the air: in this the products of combustion or hot gases are usually passed around tubes through which passes the air to be pre-heated, the air thus absorbing some of the heat. The tubes are usually made of a clay product, since the high temperature would soon cause an iron tube to deteriorate. Ebelmen used this principle on one of his first producers. (See § 178.)

The principle of recuperation is also used in the Mond by-product process. (See § 229.)

§ 114. *Comparison of regeneration and recuperation.* (B 194.)

The regenerative system must be reversed about every thirty minutes: on the other hand, the recuperative system is continuous. However, the former is more efficient in recovering the waste heat, because the air and gas come in direct contact with the hot side of the heat filter, whereas in recuperation the wrong side of a clay tube is presented. With regeneration, it is practical to heat both air and gas, while with recuperation the air only may be heated. The difficulty of heating the gas is caused by the deposition of carbon in the tubes, which soon renders them useless as heat filters. However, the heating of the gas is not usually important. With high temperatures, the regenerative system will cost less for repairs than the recuperative; the plain bricks used in the former cost less and are more durable than the clay tubes used in the latter.

§ 115. *Value of regeneration and recuperation.* (B 194.)

The values of both systems have been frequently overestimated. In general, the value will depend upon the cost of the raw fuel; if that is very low, the first cost and the cost of operating any heat-filtering device may preclude its use.

The products of combustion cannot heat any system to a temperature higher than their own. As a matter of fact, on account of the large radiation losses and inefficient transfer of heat in the heat filter, the attainable temperature of the preheated air or gas will always be much less than the temperature of the combustion products.

CHAPTER VIII.

USE OF STEAM IN GAS-PRODUCERS.

§ 116. *Object.*

The primary object in the use of steam in a gas-producer is to increase the calorific power of the gas and eliminate some of the difficulties in connection with producer operation. Its use will retard clinkering, reduce the inert N, lower the temperature of the exit gases, and in this way decrease the loss of sensible heat in gases.

§ 117. *Action.*

The action of the steam is not complicated; coming in contact with the incandescent C, the steam is decomposed and a mixture of CO and H is evolved. Thus:

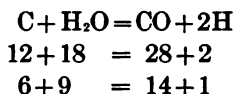

By the equation above, it will be seen that 6 lb. of C will be oxidized for each pound of H liberated; however, the amount of CO evolved from each pound of C is the same as if the C were burned by air, but the inert N has been eliminated and the CO is now mixed with its own weight of H, thereby increasing the calorific power of the resulting gas. The chemical reaction as a whole is endothermic (see § 34) and may be divided into two distinct steps:

(1) The formation of CO, and this will evolve heat exactly as when the oxidation takes place by means of air.

(2) The decomposition of water, which will absorb a large quantity of heat. The heat absorbed will be that required in separating 1 lb. of H from 8 lb. of O, with which it is combined in the form of water. The heat evolved will be that given out by the combustion of 6 lb. of C to CO.

Heat absorbed = $62100 \times 1 = 62100$ B. t. u.

Heat evolved = $4480 \times 6 = 26880$ B. t. u.

35220 B. t. u.

Heat absorbed from producer per lb. of C = $35220 \div 6 = 5870$
B. t. u.

Hence it is evident that the amount of steam that can be used is limited, for unless heat be supplied in some way, the fuel would soon become so cool that the reactions would not take place.

§ 118. *Effect of temperature on action.*

The effect of temperature on the reaction between steam and C is of fundamental importance, and data showing the effects of different temperatures are given in table 5. The figures were obtained from the experiments of Dr. Bunte. (B 163.) Table 5 shows conclusively that it is very desirable to keep the decomposition zone at a high temperature.

TABLE 5.
EFFECTS OF TEMPERATURE ON ACTION OF STEAM.

TEMPERATURE, C	PERCENTAGE OF STEAM DECOMPOSED	COMPOSITION OF GAS BY VOLUME		
		H	CO	CO ₂
674	8.8	65.2	4.9	29.8
758	25.3	65.2	7.8	27.
838	41.	61.9	15.1	22.9
954	70.2	53.3	39.3	6.8
1010	94.	48.8	49.7	1.5
1125	99.4	50.9	48.5	.6

§ 119. *Function of the steam.*

The recoverable excess of the sensible heat of the producer is conserved by taking advantage of the fact that when a chemical compound is decomposed, it absorbs an amount of heat equal to that which is evolved when its elements unite to form it. (See § 33.) Thus, the heat absorbed in the decomposition of the water is conserved in the heat energy of the liberated H. Thus the primary function of the steam is to act as a carrier of heat energy. The heat which was absorbed by its decomposition is given out again when the constituents of the gas are burned. No possible use of steam can cause a gain of heat in the producer, and in no possible circumstances can more heat be given out than was previously absorbed; and the heat of combustion of the gas

can never exceed, however closely it may be made to approach, that which the solid fuel could give. However, the judicious use of steam may reduce the loss of heat in the producer to about 15 per cent of the heating power of the fuel. A further function is to alter the composition of the gas; the effect of this is shown in table 6. This is interesting historically in that the figures were obtained from observations made by Ebelmen, the designer of one of the first gas-producers built. (B 5.)

TABLE 6.
EFFECT OF STEAM ON COMPOSITION OF GAS.

CONSTITUENT	WITH AIR BLAST	WITH AIR AND STEAM FOR BLAST
CO	33.04	27.2
H	4.43	14.0
CO ₂	.41	5.5
N	62.12	53.3

§ 120. *Proportion of air and steam.*

The proportions of air and steam required will vary with the type and condition of producer and blower, nature of fuel and the purpose for which the gas is to be used. However, 10 parts of steam and 90 parts of air represent a usual proportion. As the specific gravity of steam with reference to air is 0.6218, 10 per cent by volume of steam will be about 6 per cent by weight; therefore, 6 lb. of steam with 94 lb. of air is a usual proportion.

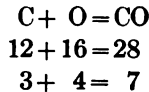

Thus 4 lb. of O are required for the combustion of 3 lb. of C, or 1.33 lb. of O per lb. of C, to form CO. Since air contains 23 per cent of O by weight, the quantity of air required to burn 1 lb. of C will be

$$\frac{1.33 \times 100}{23} = 5.8 \text{ lb.},$$

and one lb. of air will burn

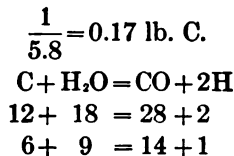

Thus 9 lb. of steam will be required to burn 6 lb. of C, or 1.5 lb. of steam per lb. of C, and 1 lb. of steam will burn $\frac{1}{1.5} = 0.67$ lb. C.

In a mixture of 100 lb. of this proportion,

$$6 \text{ lb. steam} \times 0.67 = 4 \text{ lb. of C burnt by steam.}$$

$$\frac{94}{100} \text{ lb. air} \times 0.17 = \frac{16}{20} \text{ lb. of C burnt by air.}$$

Thus the average practice is, for every 5 lb. of C consumed, 4 lb. are burned by air and 1 lb. by steam. However, there are cases where the amount of steam used is far in excess of the above proportion.

§ 121. *Quantity of steam.*

The more steam that can be used the better and richer will be the gas evolved, and the smaller will be the proportion of heat evolved in the producer. However, the amount of steam that can be used depends on the amount of heat lost in the decomposition of the steam and other sources. Therefore, any device or arrangement which prevents the loss of heat in the producer, or pre-heats the air and steam before these enter the producer, must be an advantage. At the same time, excess of steam must be carefully guarded against. Not only will it cool the producer if it be decomposed, but if not decomposed it will pass through as steam, and thus lower the heating value of the gas.

Table 7, which is composed of data collected by Jenkin (B 99), shows the effects of different amounts of steam.

TABLE 7.
EFFECT OF DIFFERENT AMOUNTS OF STEAM ON GAS.

	MODERATE EXCESS OF STEAM	GREAT EXCESS OF STEAM	MAXIMUM QUANTITY OF STEAM
CO ₂ %	5.3	8.9	15.
CO %	23.5	16.4	11.5
CH ₄ %	3.3	2.55	1.9
H %	13.14	18.6	24.6
Calorific power.	1343.	1202.	1150.
Temperature...	800 C	700 C	500 C

With the proportions assumed in § 120, 1 lb. of steam would be required for every 5 lb. of C burned, or 0.2 lb. of steam for each pound of fixed C in the fuel. However, with pre-heated air and superheated steam, a much larger quantity of steam may be used.

§ 122. *Mechanical effect.* (B 72.)

Steam will keep the clinkers soft and porous, thus allowing the blast to pass up readily through the entire bed of fuel; this gives a uniform distribution of the blast. In the absence of steam, when the clinkers are hard, it is necessary for the blast to pass up through the interstices between the clinkers. This is frequently the case when an all-air blast is used, since this tends to localize combustion and form the clinkers into hard and non-porous lumps through which the air cannot pass.

The mechanical effect of the steam on the ashes is to moisten them, keep combustion away from the grate and thus protect the latter, prevent the blowing of fine ashes up and into the combustion zone and the fusing of the ashes to the walls of the producer.

§ 123. *Water vapor.*

An excessive use of steam will result in part of it passing through the fire without being decomposed, and then passing into the gas and appearing there as water vapor, and in this way decreasing the value of the gas. For the method of determining the water vapor in the gas see § 331.

§ 124. *Summary.*

The following is a brief summary, by Raymond (B 72), of the facts and principles involved:

(1) No possible use of steam can cause a gain of heat. If steam be introduced into a bed of incandescent carbon, it is decomposed into hydrogen and oxygen.

(2) The heat absorbed by the reduction of 1 lb. of steam to H is much greater in amount than the heat generated by the union of the O thus set free with C forming either CO or CO₂. Hence the effect of steam upon a bed of incandescent fuel is to chill it.

(3) This loss may be recovered if the H of the steam is subsequently burned to form steam again. Such a combustion of the H is contemplated in the case of fuel gas as secured in the subsequent use of the gas.

(4) The advantages to be secured consist principally in the transfer of heat from the lower side of the fire, where it is not wanted, to the upper side, where it is wanted. The decomposition of the steam below cools the fuel and the grates, whereas a

blast of air alone would produce at that point intense combustion (forming at first CO_2), to the injury of the grate, the fusing of the fuel, etc.

(5) The proportion of steam most economical is not easily determined. The temperature of the steam itself, the nature of the fuel, air supply, and form of bottom affect the problem.

§ 125. *Steam blowers.* (B 171, B 12.)

The method of supplying the steam and air is of fundamental importance because the blast has such a vital bearing on the operation of the producer. The steam-jet blower is almost universally used; it requires less steam, costs less than any other type, and secures a thorough mixture of the steam and air by introducing them together. The principle of operation is very simple, and depends on the well-known fact that when a stream of any fluid is sent through the air, the friction between the fluid and the air is enough to draw the latter along in the direction that the fluid is moving and in this way induce a current of air. In fact, the steam-jet blower is simply an air injector.

Siemens conducted the first careful and extensive experiments that were made on steam jets, and from these experiments he drew the following conclusions. (B 12.)

“First, the quantity of air delivered per minute by a steam jet depends upon the extent of surface contact between the air and the steam, irrespective of the steam pressure, up to the limit of exhaustion or compression that the jet is capable of producing.

“Second, the maximum degree of vacuum or pressure attainable increases in direct proportion to the steam pressure employed, other circumstances being similar.

“Third, the quantity of air delivered per minute, within the limits of effective action of the apparatus, is in inverse relation to the weight of air acted upon; and a better result is therefore realized in exhausting air than in compressing it.

“Fourth, the limits of air pressure attainable with a given pressure of steam are the same in compressing and in exhausting, within the limit of a perfect vacuum in the latter case.”

Hence, the amount of air carried with a steam jet is a function of the area of the surface contact between the two and the velocity of the steam, and as the latter increases with, and is proportional to, the steam pressure used, it is evident that a large area of sur-

face contact between the steam and air is necessary, and the steam must be used at considerable pressure in order to produce a good draft of air. As the amount of air required in a gas-producer

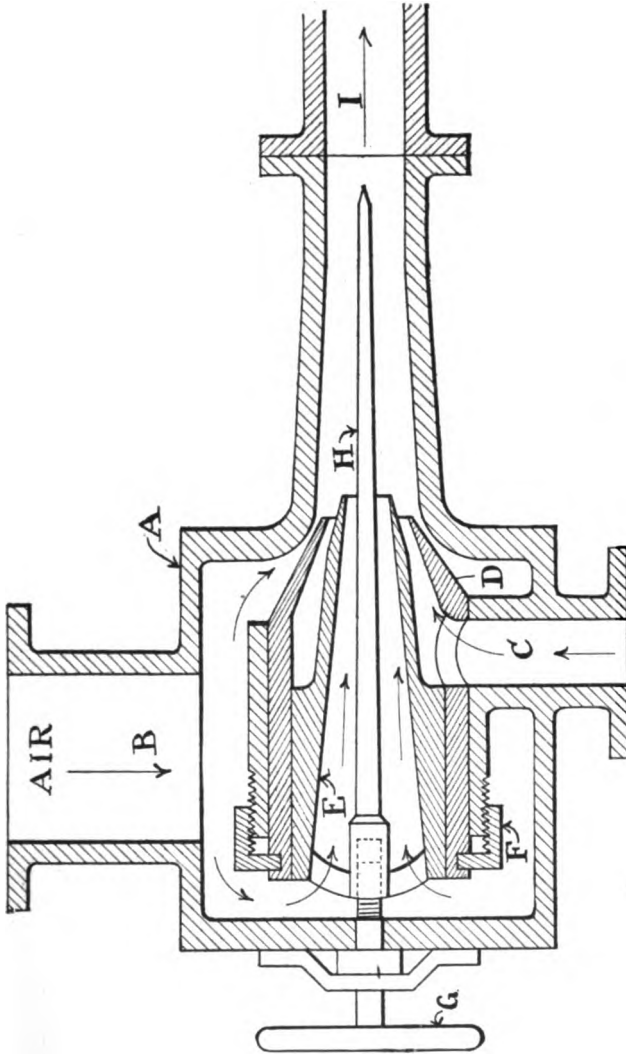

FIG. 4. — SIEMENS STEAM-JET BLOWER.

is very much larger than the amount of steam that may be used (see § 120), it follows that a small quantity of steam must carry

in a large quantity of air. Since a solid steam jet has relatively little surface contact for a given quantity of steam, it is not well adapted to carry a large volume of air. To increase the air-carrying power of a given quantity of steam, the jet is made of annular form.

§ 126. *Types of steam blowers.* (B 12, B 95.)

The Siemens steam-jet blower is shown in Fig. 4. It consists of a body *A* with air inlet *B* and steam inlet *C*. *D* is the outer conical nozzle and *E* is the inner conical nozzle. *D* may be adjusted by nut *F* and thus change the space between *A* and thereby regulate the amount of air that may enter. *E* may be adjusted by hand wheel *G*, and thus regulate the thickness of the annular steam jet. *H* is a tapering spindle to prevent reflux through the combined current. *I* is the pipe to the producer.

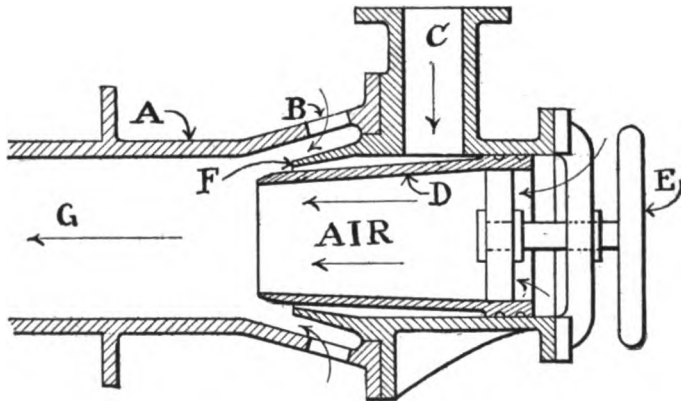

FIG. 5. — SIEMENS STEAM BLOWER.

A modified form of the blower just described is shown in Fig. 5. *A* is the body of the blower with auxiliary air-ports *B*. *C* is the inlet for the steam which enters the mixing chamber *G* through the conical nozzle *F*. The nozzle *D* may be adjusted by hand wheel *E*. Since *D* is tapering, the adjusting of it will change the thickness of the annular steam jet. The air enters through *B* and *D*.

Fig. 6 shows the Thwaite steam blower. This is composed of a body *A*, adjustable head *B*, which is held by nuts *C*. *D* is the steam inlet; *E* is the outer conical nozzle and *F* is the inner;

the latter may be adjusted by wheel *G*. *H* is the mixing chamber. The air enters at *I* and through *F*.

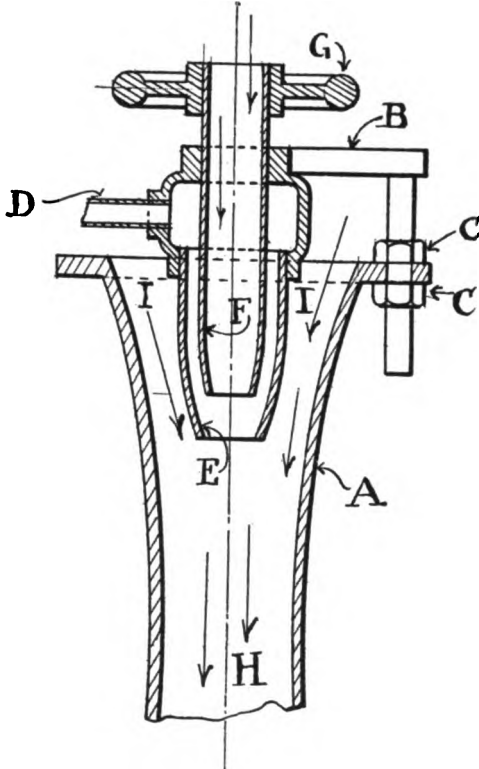

FIG. 6. — THWAITE STEAM BLOWER.

The Argand steam blower is shown in Fig. 7. It consists of a curved annular body *A*, which contains the ring *B*. *B* has small holes on the one side and is supplied with steam by pipe *C*. The

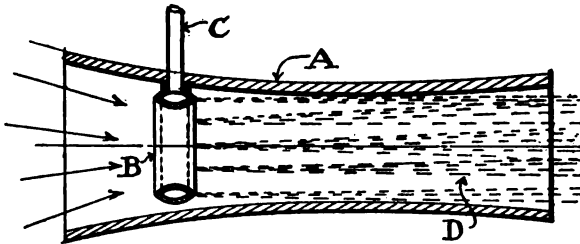

FIG. 7. — ARGAND STEAM BLOWER.

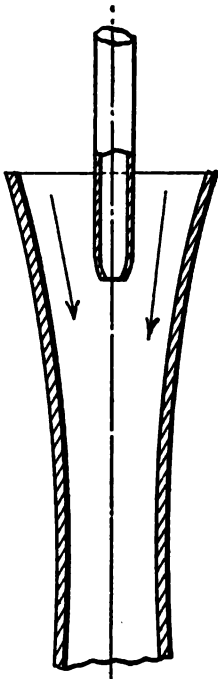

FIG. 8. — SOLID JET STEAM BLOWER.

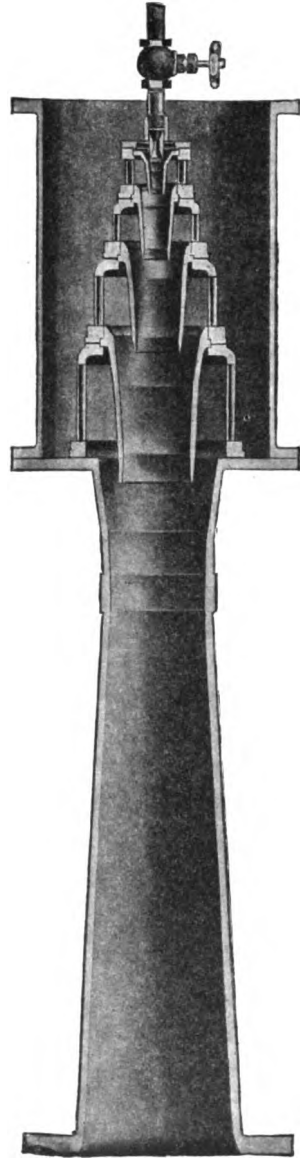
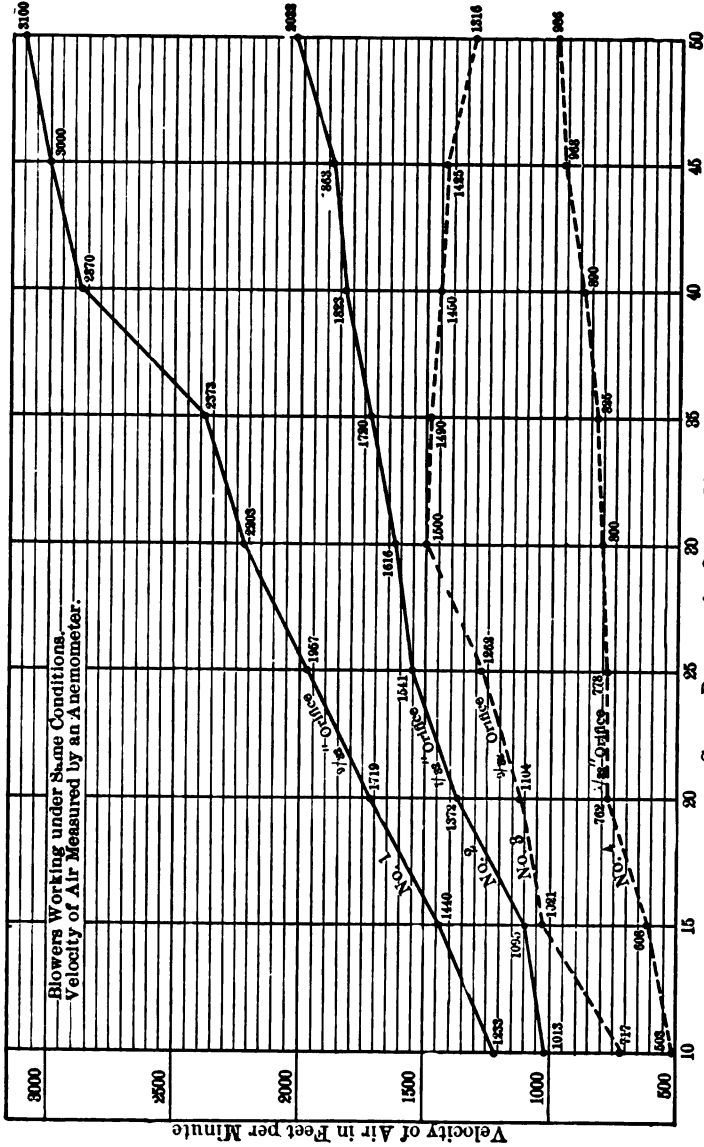

FIG. 9. — EYNON-EVANS STEAM BLOWER.



Steam Pressure, by Gauge. Lbs. per Sq. Inch
FIG. 10. — EFFICIENCY CURVES OF BLOWERS.

steam enters the mixing chamber *D* in a large number of fine sprays, and draws the air in with it.

Fig. 8 is an ordinary solid jet steam blower; these are very inefficient on account of the small surface of contact between the air and the steam.

The Eynon-Evans steam blower, shown in Fig. 9, belongs to the type most generally used in this country. It consists essentially of four concentric conical nozzles through which the steam and air pass, additional air being drawn in at each nozzle. This secures a thorough mixture of the steam and air, and as the area of surface contact is large, the blower is very efficient.

The curves shown in Fig. 10 show the efficiencies of two different types of blowers. Curves 1 and 2 were made from data obtained from a Eynon-Evans blower, and curves 3 and 4 were made from data obtained in testing a solid jet blower like the one shown in Fig. 8.

CHAPTER IX.

CARBON DIOXIDE IN PRODUCER-GAS.

§ 127. *Presence and deleterious effect.*

The presence of CO_2 in producer-gas in excess of 3 per cent is always indicative of a badly constructed or carelessly operated producer. It is an indication of the failure of the producer to decompose the CO_2 formed at the bottom and to reduce it to CO , or shows that the CO evolved from the producer has been burned. The CO_2 represents its own volume of CO uselessly burned in the producer, thus causing a serious loss of heat and charging the gas with a useless constituent. Not only is the CO_2 a diluent, but the additional O required for its formation will increase the amount of N in the gas, and thus further reduce the heating value per unit volume.

One pound of C burned to CO_2 evolves 14500 B. t. u.

One pound of C burned to CO evolves 4450 B. t. u.

10050

Hence, for every pound of carbon in the gas in the form of CO_2 , there will be a waste of 10050 heat units in the producer, and a decrease of the heating power of the gas by about the same amount.

The deleterious effect of even a small percentage of CO_2 may easily be illustrated by the representative gas analysis given in § 55. There 5.2 per cent CO_2 places $0.0335 \times 5.2 = .174$ lb. — see col. L of table 3, p. 51 — of useless C in every 100 cu. ft. of the gas, or 0.0017 lb. C for each cu. ft. As one pound of C will make 96.1 cu. ft. (§ 55) of this gas, the amount of useless C in the gas due to the presence of 5.2 per cent CO_2 equals $96.1 \times 0.00174 = 0.167$ lb.

Hence, for every pound of C gasified in the producer when the resulting gas contains 5.2 per cent CO_2 , 0.167 lb. is wasted. This

means a loss of $10050 \times 0.167 = 1678$ B. t. u., or over 11 per cent of the calorific energy in the fuel. In other words, the percentage of fuel loss due to the formation of CO_2 will be about double the percentage of the CO_2 in the gas evolved from the fuel.

§ 128. *Effect of temperature and fuel bed.*

A low temperature in the producer, especially if it has been caused by an excessive use of steam, is greatly conducive to the formation of CO_2 , and an irregular temperature will have a like effect. Thus, the log. of the test given in Fig. 108 shows that just as soon as the temperature became regular the percentage of CO_2 decreased and the CO increased. In the experiments conducted by Mr. Emerton (B20), the results of which are given in table 8, it was found that the CO_2 was lower at the end of a charge than at the beginning, thus tending to show that the temperature of the fire had more effect on the composition of the gas than the depth of the fuel.

TABLE 8.
VARIATION IN COMPOSITION OF PRODUCER-GAS.

	JUST CHARGED	HALF HOUR	ONE HOUR	END
CO_2	9.47	9.48	8.96	6.72
CO	12.74	16.53	14.52	16.89

While a considerable depth of fuel bed is desirable for the elimination or reduction of the CO_2 , yet depth of fuel alone will not suffice, as the uniformity or compactness of the fuel bed is of equal importance; also, thorough and frequent but not too vigorous poking is always conducive to keeping the fuel in such a condition that the CO may be reduced.

§ 129. *Effect of feeding.*

Irregular and intermittent feeding will always produce conditions favorable for the formation of CO_2 . The chilling effect of a fresh charge of fuel, especially if it contains much moisture, will so reduce the temperature of the upper zone of the producer that the CO_2 will pass through without being reduced to CO . These facts are very strong arguments in favor of the use of automatic feeding devices as discussed in §§ 161 and 286.

§ 130. *Effect of leakage.*

The leakage of air up through the fuel or up along the walls of the producer, or, in the suction type of producer, the leakage of air into the inside through the walls of the producer will always result in the burning of the gas and the resultant formation of CO₂. For this reason the fuel bed should be kept compact and free from channels and all connections of the producer free from leaks.

CHAPTER X.

EFFICIENCY OF GAS-PRODUCERS.

§ 131. *Heat loss.*

When fuel is gasified, the amount of heat which can be obtained by the combustion of the gas from a unit weight of solid fuel will always be less than the amount of heat which would be evolved by the complete combustion of the fuel itself, by the amount of heat evolved in the producer and lost in the process of gasification.

Let H = Heating power of 1 lb. of solid fuel.

H' = Heating power of the gas from 1 lb. of solid fuel.

H'' = Heat evolved in the producer for each pound of solid fuel gasified.

Then $H = H' + H''$.

§ 132. *Definition of efficiency.* (B 99.)

It is obvious that the lower the amount of heat evolved in the producer or lost in the process of gasification, the higher will be the amount of heat available where the gas is to be used. Producer-gas is used for many purposes, but in all cases the primary object is to *supply heat*; this heat is of course derived from the fuel fed into the producer. Efficiency is equal to output divided by input. Hence the efficiency of the producer is defined as the ratio of the heat contained in the gas as it leaves the producer to that in the fuel from which the gas is made.

$$\text{Efficiency} = E = \frac{H'}{H}$$

§ 133. *Two kinds of efficiency.*

The gas is simply a *carrier* of heat energy from the producer to the place where this energy is to be utilized; the heat contained in the gas may be divided into two parts, namely, the heat of combustion and the sensible heat of the gas due to its temperature. It will always be desirable to keep the temperature of the

gas as low as possible as it leaves the producer. When the gas is cooled after leaving the producer and before it is burnt, the sensible heat is abstracted by the cooling arrangement and is no longer available. It will be useful to consider the efficiency of producers both when the gas is used hot, and when it is used cold. For simplicity, these two values may be called the hot-gas and the cold-gas efficiencies respectively.

§ 134. *Relation of utility and efficiency.* (See App., note 11.)

There is a vast difference between the efficiency and the utility of a gas-producer, and it is necessary to distinguish clearly between them. By utility is meant the suitability or adaptability to the *particular work* that the producer has to do. For instance, if by-products, such as ammonia, tar, etc., are collected from the gas, the utility of a producer giving large quantities of such products with a poorer gas may be greater than that of a more efficient producer which gives smaller quantities of by-products. If such matters were taken into account, the efficiency of the apparatus would be obtained, considered not as a gas-producer alone, but as a tar, ammonia, and gas-producer.

§ 135. *Relation of efficiency and calorific power.* (B 99.)

“In most cases, the efficiency of a furnace burning gas depends to some extent on the richness of the gas; this is measured by the ‘calorific power’ of the heat of combustion per unit volume of the gas. The quantity is determined incidentally in the calculation of the efficiency of the gas-producer. In practice the calorific power usually, but not always, varies approximately with the efficiency. A high value for both the calorific power of the gas and the efficiency of the producer is desirable; it is well to consider both figures in estimating the merits of a producer. When the gas is to be used in a gas engine, the calorific power is of more importance than the efficiency. In determining the best form of producer for any given circumstances, many other considerations besides its efficiency must be taken into account. However, in most cases the efficiency should rank as one of the most important, and after any form of producer has been selected it will almost always be desirable to work it as efficiently as possible.”

§ 136. *Method of finding efficiency.*

In order to determine the efficiency, one must determine by

experiment the average analysis of the gas, the amount of carbon in the fuel, the amount of carbon lost in the ashes, the heat of combustion of the fuel, and the average temperature and composition of the gas. These should be made according to the methods given in Chapter 26.

A direct method for finding the efficiency of a producer would be to measure in a meter the quantity of gas made, and burn samples of the gas and fuel in a calorimeter; from these data the efficiency could be calculated at once. However, the direct measurement of the quantity of gas made is not usually possible, and recourse must be had to chemical analysis to find the relation between the quantity of gas made and the fuel burnt. (See § 55.)

§ 137. *Conditions governing efficiency.*

The efficiency will be reduced by any action which tends to evolve heat in the producer, and especially by the production of carbon dioxide. Conversely, any action, such as the use of steam, which tends to reduce the evolution of heat in the producer will increase the efficiency.

But the amount of steam which can be used is limited, because the temperature of the producer must be kept up to that at which water is decomposed, and carbon dioxide is converted into carbon monoxide by the incandescent carbon. An increased amount of carbon dioxide will be the result of a decrease in temperature, and the efficiency of the producer will thus be seriously reduced.

It is evident that the heat evolved in the producer must always be sufficient to balance any loss of heat that may take place, and also to maintain the fuel at the necessary temperature, so that the proper chemical reactions can take place. Therefore, these heat losses determine the minimum heat evolution in the producer. If the gases are used hot, the efficiency will be higher by the amount of sensible heat which is *actually* utilized.

§ 138. *Coal and ash analysis.*

No reliable determination of the efficiency of a producer can be made without an accurate analysis of the coal used and its resulting ash. An ultimate analysis of the coal should be made to determine its exact chemical composition. If the ashes become wet, the amount of moisture must be deducted. The exact amount of carbon in the ash can easily be determined by burn-

ing a weighed sample and observing the diminution of weight, which must be due to the combustion of the carbon, as all the other volatile constituents have been driven off in the producer. (See Chapter 26.)

The total weight of the carbon in the ashes divided by the total weight of carbon in the coal burnt during the same period will give the proportion of carbon lost in the ashes. This figure varies largely in practice and is discussed in the following section.

§ 139. *Grate efficiency.*

A certain amount of fuel will always escape combustion by falling through the grate, or reaching the bottom of the producer without coming in contact with air. The amount thus lost should be very small in a good producer. In most producers it is not more than $2\frac{1}{2}$ per cent, rarely reaching 5 per cent of the weight of the fuel. However, in badly constructed producers this loss may amount to 30 per cent.

The proportion of carbon made into gas is equal to unity minus the amount of carbon in ash. This represents the grate efficiency of the producer. It is also evident that the efficiency of the producer must be multiplied by the grate efficiency to give actual working efficiency of producer.

§ 140. *Heat of combustion of fuel.*

It will be best to have the heat of combustion determined in a reliable form of calorimeter. The calorimetric value of the heat of combustion should be corrected for the latent heat of the steam formed.

§ 141. *Temperatures.*

One of the most useful guides as to the working of a producer is the temperature of the gas and the extent of its variations. The temperatures of the different zones will also show if the producer is working properly. The curve on Fig. 108 shows the fluctuation of temperature during a producer test.

§ 142. *Figure of merit.*

This term was introduced by Jenkin (B 99). When the fuel is gasified, all the hydrogen present will go into the gas, together with the carbon, except that which escapes gasification by passing out with the ash. However, the carbon will be represented in the gas by the hydrocarbons from the coal, and by carbon

monoxide and carbon dioxide from the combustion of the carbon. The first two are combustible and useful; the carbon dioxide indicates a certain amount of carbon wasted in the producer. Each unit weight of fuel will yield a certain amount of gas whose calorific power will depend upon the *form or state* of the carbon in the gas.

Hence, the real value — or, what is the same thing, the “Figure of merit” — of the gas will be defined as the heating power of the gas per unit weight of carbon contained. Expressed in another form, the calorific power of the gas, divided by the weight of carbon in a cubic foot, gives the heat of combustion of the gas per pound of carbon contained in the gas — that is, the figure of merit of the gas.

The figure of merit is obtained directly from the volumetric analysis of the gas by the aid of columns L and R of table 3, p. 51.

EXAMPLE OF CALCULATION OF FIGURE OF MERIT.

	A	B	C	D	E
CO ₂04	× .0335 =	.00134
CO.....	.254	× .0034 =	.00748
		× 342 =		86.86
CH ₄015
		× 1070 =		16.05
H.....	.111	× 346 =		38.4
N.....	.58				
	1.000		Calorific power =		141.31

Lb. C per cu. ft. = .01387

A = gas analysis by volume given in terms of 1 cu. ft.

B = heating value or calorific power per cu. ft.

C = A × B = calorific power of gas.

D = pounds of C in 1 cu. ft. of gas; see column L, table 3, p. 51.

E = A × D = pounds carbon in gas.

$$\text{Figure of merit} = \frac{141.3}{.01387} = 10187 \text{ B. t. u. per pound of carbon in the gas.}$$

§ 143. *Limited use of figures of merit.* (B 99.)

“The figure of merit can be used to compare the gas made in two or more producers (without the use of steam or air under pressure) working with similar coal and under similar conditions, or it can be used to compare the gas made in one producer at different times, but it cannot be used to compare the gas made in one or more producers with varying qualities of coal.

“It should also be noted that the tests and calculations required to arrive at a balance sheet of all the heat units involved

are in no way simplified by adopting the figure of merit, and it is decidedly better to adopt the balance sheet in all cases. It is correct and cannot mislead."

§ 144. *Cold-gas efficiency.* (B 99.)

Let M = figure of merit.

K = proportion of carbon in coal.

H = heat of combustion of coal measured in corresponding units with M .

G = grate efficiency.

E_c = cold-gas efficiency.

$$E_c = \frac{M \times K \times G}{H}$$

The product of M and G is a complete indication of how economically a producer is working as long as one quality of coal is used throughout the test.

§ 145. *Hot-gas efficiency.*

This differs from the cold-gas efficiency only because account is taken of the sensible heat of the gas as it leaves the producer, as shown by the formula.

Let E_c = cold-gas efficiency.

E_h = hot-gas efficiency.

S = sensible heat of gas per cubic foot.

H = calorific power of the gas.

t = temperature of atmosphere.

T = temperature of gas as it leaves the producer.

C_v = volumetric specific heat.

$$S = (T - t) C_v$$

$$E_h = E_c \times \left(1 + \frac{S}{H}\right).$$

"Most modern producers supply hot gas, but it must not be assumed on this account that the real efficiency of these producers is their hot-gas efficiency. When the gas is used without passing through a regenerator, the sensible heat is all available, and the real efficiency is the hot-gas efficiency; but when the gas is used with a regenerative furnace the case is different, and it seems probable that the sensible heat is almost entirely wasted,

the only result being the higher temperature of the chimney gases. If this theory is correct, then for all producers supplying gas to regenerative furnaces the only efficiency which need be considered is the cold-gas efficiency." (B 99.)

§ 146. *Effect of steam on efficiency.*

On account of its high specific heat, a relatively small volume of steam carries with it a large quantity of heat. Hence, the amount of steam in a gas is of considerable importance.

If the gas is used cold the heat is all lost in the cooling apparatus, and if the gas is used hot the steam will carry its heat to the furnace; but only a portion of it can be used there, since the products of combustion escape above atmospheric temperature.

CHAPTER XI.

HEAT BALANCE OF THE GAS-PRODUCER.

§ 147. *Heat losses.*

There are several sources of heat losses in a gas-producer, none of which can be entirely eliminated, but all of which may be reduced.

(1) *Loss in ashes.* The heat of the ashes is nearly all utilized while lying in the lower part of the fire and in the ash pit, in heating the incoming air and moisture; the amount of heat actually carried away as specific heat is usually small. In water-bottom producers this loss may be nearly zero, as any heat in the ashes is used in volatilizing some of the water.

(2) The loss of unburned carbon dropping down with the ash and removed with it.

(3) The loss in raising the air and the resulting products of combustion from the standard temperature (32 degrees F.) to the temperature of the delivery flue. This loss may be diminished by pre-heating the air by waste heat, and by diminishing the weight of diluent air in excess of that needed for combustion.

(4) Loss in the latent heat of the volatilization of the hydrocarbons.

(5) Loss in sensible heat of the gas evolved. The gases always leave the producer at a high temperature, often at 1000 degrees F., and thus carry away considerable heat. This quantity is large in nearly all ordinary forms of producers; there is no need of this, and the cooler the gases are the better.

One pound of carbon will give 6.7 lb. of simple producer-gas, which has a specific heat of about 0.245, so that the heat carried away will be $0.245 \times 6.7 = 1.641$ heat unit for each pound of fuel, for each degree of temperature of the gases; or at 1000 degrees F., 1641 heat units, or about 11 per cent of the heat which the solid fuel could give. About 10 per cent is the usual amount of heat to be carried away in the gases, but it may be very much higher, especially if the gas contains a large quantity of hydrogen (sp.

ht. 3.409), or if undecomposed steam (sp. ht. 0.48) is carried through, or if the fuel is wet. It is clear, therefore, that the escaping gases should be kept at as low a temperature as possible.

(6) Loss due to evaporation of moisture in coal and to heating the resulting steam. Hence it will be advisable to use dry fuel, and the coal should be protected from the action of the weather.

(7) Loss in heating the undecomposed steam that passes through the fire. This is very objectionable and is due to the supply of more steam than the incandescent carbon can decompose under the conditions of working. Steam has a high specific heat and a high latent heat, so that it may carry away a considerable quantity of heat.

(8) Loss of heat in the decomposition of the steam.

(9) Loss of heat due to the formation of carbon dioxide. This is probably the most serious source of loss in most forms of producers. The presence of carbon dioxide is always due to the column of fuel either not being deep enough or not hot enough to decompose all the carbon dioxide which may be formed. The effect of CO_2 is discussed in detail in Chapter 9.

(10) Loss of solid carbon as soot and tar. The cooling of the gases has a tendency to increase these two losses; however, they are usually small. The amounts of tar and soot deposited in the conducting pipe may be ascertained by the quantities removed from time to time in cleaning the tube, or may be calculated by the method of § 331.

(11) Heat lost by radiation. The hot fuel is surrounded by walls, which on the other side are exposed to the air. Heat will necessarily travel through the walls and will be lost by radiation and conduction into space. It is almost impossible to form an estimate of the amount of heat thus lost, but it is certainly very large.

§ 148. *Arrangement of heat balance.*

The simplest arrangement is that of debit and credit columns; this is given in table 9, p. 91.

§ 149. *Calculation of heat balance.*

32 degrees F. is taken as the standard temperature and from this all temperature ranges are calculated.

TABLE 9.

HEAT BALANCE.

DR.		CR.
To heat per lb. of coal.		By heat per lb. of coal.
From calorific power of fuel.....A		Evolved in formation of CO ₂D
From air blast.....B		Evolved in formation of CO.....E
From steam in blast.....C		In calorific power of gas.....F
		Absorbed in decomposing steam..G
		Lost in ashes.....H
		Lost in unburned carbon.....I
		Lost in tar and soot.....J
		Lost in volatilization of hydrocarbons.....K
		Lost in sensible heat of gas.....L
		Lost in heating undecomposed steam.....M
		Lost in evaporating moisture in coal.....N
		Lost in radiation.....P
	Total sum of debits = total sum of credits

i.e. (A + B + C) = (D + E + F + G + H + I + J + K + L + M + N + P).

A, the calorific power of the fuel, is that found experimentally by means of a reliable calorimeter.

B Let T = temperature F. of air as it enters producer.

W = pounds air supplied per pound of fuel.

$(T - 32) W \times 0.237$ = heat carried in by air blast.

C Let T_1 = temperature F. of the steam as it enters the producer.

W_1 = pounds of steam used per pound of fuel.

X = quality of steam.

h = heat of the liquid = $T_1 - 32$.

L = latent heat corresponding to T_1 .

Q = total heat in 1 lb. of steam from 32 degrees.

$Q = XL + h$.

$C = W_1 (XL + h)$.

D = lb. carbon as CO₂ (per lb. of fuel) 14,500.

E = lb. carbon as CO (per lb. of fuel) 4450.

F = the calorific power of the gas found by the method of § 53 and § 33.

G In § 117, it was shown that 35,220 B. t. u. were absorbed in decomposing one pound of hydrogen. As one pound of steam is composed of $\frac{1}{8}$ pound hydrogen and $\frac{7}{8}$ pound oxygen (see § 47), the decomposition of one pound of steam will absorb $\frac{35,220}{9} = 3913$ B. t. u.

G = lb. of steam decomposed (per lb. of fuel) 3913.

H Let W_2 = weight of ashes (dry).
 T_2 = temperature of ashes.
 .16 = specific heat of ashes.

$$H = W_2 (T_2 - 32) 0.16$$

I Let y = grate efficiency of producer.
 $100 - y$ = per cent of unburned carbon.
 $(100 - y) A$ = heat loss in unburned carbon.

J Calculate the weight of carbon in the tar and soot per unit volume (cu. ft.) of gas and take its calorific power at 14,500 B. t. u.

Let Z = weight of carbon from tar and soot per cu. ft. of gas.
 $J = Z$ (number cu. ft. of gas per lb. of fuel) 14,500.

K Bell gives this to be 600 calories per kilogram of coal, or 1082 B. t. u. per pound of coal. This figure is not very reliable, but for want of a more exact value it is given here.

L Let V = volume of gas in cu. ft. per pound of fuel calculated by the method given in § 55.
 S = specific heat of gas calculated by the method given in § 52.

T_3 = temperature of escaping gases.

$L = V (T_3 - 32) S$ = sensible heat carried out by gas.

M Let W_m = per cent of moisture in fuel.
 W_1 = lb. of steam used per lb. of fuel.
 W_d = lb. of steam decomposed per lb. of fuel.
 W_n = lb. of undecomposed steam per lb. of fuel.
 W_v = lb. of moisture in gas per lb. of fuel.

The moisture carried in by the air may be neglected, as it will be very small.

$$W_1 + W_m = W_d + W_v$$

$$W_1 + W_m - W_v = W_d$$

$$W_1 - W_d = W_n$$

W_1 to be found by the method of § 324.

W_v to be found by the method of § 331.

W_m to be found from fuel analysis.

T_3 = temperature of escaping gases.

T_4 = temperature of steam.

$$M = W_n (T_3 - T_4) 0.475$$

N Evaporation of moisture in fuel and heating of resultant steam.

Let W_m = per cent of moisture in fuel.

T_s = temperature of escaping gases.

$(212 - 32) W_m$ = B. t. u. required in heating from 32 to 212.

966 W_m = B. t. u. required in latent heat of evaporation.

$(T_s - 212) 0.475 W_m$ = B. t. u. required in heating steam
from 212 degrees to T_s degrees.

N = total heat req. = $(212 - 32) W_m + 966 W_m + (T_s - 212) 0.475 W_m$
= $W_m [180 + 966 + (T_s - 212) 0.475.]$

P = radiation loss; since this is the only unknown, it may be found by difference.

Thus, $(A + B + C) - (D + E + F + G + H + I + J + K + L + M + N)$
= P .

CHAPTER XII.

FUEL.¹

§ 150. *Early fuels.*

Coke and charcoal were the fuels used in the earliest forms of gas-producers, and they are still used where the gas is to be used in gas engines. The cost of these is too high for ordinary use and cheaper fuels must be used in most cases.

§ 151. *Character of fuel.*

A thorough and comprehensive knowledge of the kind and character of fuel to be used is a primary necessity. Since fuel varies so much in different sections of the country, great care should be exercised in its purchase; however, there is nothing that is bought so carelessly by the ordinary fuel user. Fuel is seldom sold on analysis or on a guarantee of its heating value, and when analyses are furnished by the seller, they rarely represent a fair average. A knowledge of the adaptability of a fuel to the particular type of producer in which it is to be used is imperative, since a producer that would give excellent results with one kind of fuel might fail completely in handling another kind. If the gas is to be used in gas engines or for many kinds of metallurgical work, the amount of sulphur in the fuel must be very low.

§ 152. *Condition.*

Coal should be used fresh, or carefully stored under cover to prevent the atmospheric distillation of the volatile matter, and it will always be found poor economy to use coal that has been stored outside and subjected to climatic changes. When used it should be as dry as possible at the time of its manufacture into gas, for two reasons:

First, to prevent the loss of the heat, which otherwise would be required to evaporate the moisture. Second, to prevent condensation or chemical combination of the moisture in the flue, which would precipitate the heavy hydrocarbons.

Where wood is used it should be thoroughly air dried, thus

¹ See App., note 12.

relieving the producer of the evaporation of the large amount of moisture that all green wood contains.

§ 153. *Size of fuel.*

The coal should be as nearly as possible uniform in size, as this will make level fires which burn evenly; fine dust should not be used, as it will obstruct the passage of the blast through the fuel bed. Neither should large lumps be allowed, as they will require longer burning than surrounding material and this causes irregular combustion, some parts of the fuel being at a white heat, while large masses will hardly be heated through. Air and steam soon force their way through these weak spots and escape into the gas space above, burning both coal and gas. With the use of coal having no extremely large lumps, the repairs and delays, as well as operating expenses of the gas-producer, are greatly lessened, and the reliability and capacity of the plant are greatly increased.

Large or crooked sticks of wood should never be placed in the producer, and the sizes of all pieces should be such as to form a compact and uniform bed in producer.

§ 154. *Coal.*

If this is used, it should be of good quality, rich in hydrogen, and ought to have a low percentage of ash, which should not clinker or run together under the influence of heat. Coals which become pasty when heated should not be used, as they will always give trouble in the producer. Local and commercial conditions will determine whether anthracite or bituminous coal is the less expensive in first cost, but the type of producer that is to gasify the coal and the use of the resulting gas will be the final criterion in deciding which coal is the cheaper.

§ 155. *Peat and lignite.* (B 308, B 156, B 146.)

The two principal difficulties in the use of peat and lignite are the large amounts of moisture present and the resistance offered to the passage of gas by the layer of fuel. On account of the latter point it is not ordinarily feasible to gasify these fuels in a suction producer, but a pressure gas-producer should be used that is capable of furnishing a higher pressure than is usually used. These fuels have been used extensively in Europe, and in many cases the gas has been used in gas engines.

It would be very desirable to have the producer so arranged

that the gases pre-heat the fuel before it goes on to the fuel bed proper. This would remove a large amount of the moisture in the fuel, cool the gas, and thus conserve the sensible heat loss and also condense a large amount of the tar carried by the gas. The producer should be so arranged as to carry this condensed tar down into the incandescent fuel and thus break the former up into stable compounds.

It is not generally advisable to use a coke scrubber with the usual type of lignite and peat producer, since the coke soon fills up with tar; a simple tower provided with a thorough spraying and sprinkling device is used in place of the coke. If the gas-producer were built on the lines suggested in the preceding paragraph, the tar would be held in the producer and the problem of scrubbing would then be much simpler.

§ 156. *Brown coal.* (B 226, B 182, B 177.)

Brown coal in the form of briquettes has been used to a limited extent in Germany. Operating producers there with brown-coal briquettes proves in many cases more convenient than the use of anthracite. There is almost an entire absence of slag, and the fuel bed may be readily cleaned. The fuel bed holds the fire very well and when once blown up it may be restarted with ease. The coal in the form of briquettes is clean, easy to handle and to store; several plants are now in successful operation where the gas is used in gas engines.

§ 157. *Refuse.* (B 325, B 328, B 310.)

Shavings, sawdust, straw, bark, and similar refuse have been successfully gasified in the Riche gas-producer. (See § 264.)

CHAPTER XIII.

REQUIREMENTS OF GAS-PRODUCERS.

§ 158. *Adaptability.*

The adaptability of the gas-producer to the work it has to do is one of its most important requirements. The use and composition of the gas, nature of fuel, method of operation, economy required, and type of producer — all are factors that must be co-ordinated in their proper relation, in order to secure a satisfactory producer-gas plant. The proper appreciation of this requirement, in its broadest sense, by designers and prospective users of gas-producers is imperative in order to insure the extensive development of the gas-producer in America. (See § 87 and § 270.)

§ 159. *Construction of producer.*

It should be compact and simple. Parts which wear or burn out rapidly should be made interchangeable and easily renewable. Proper provision must be made for cleaning all parts of the apparatus.

§ 160. *Composition of gas.*

This will depend on the nature of fuel, method of operating producer, and use of gas. In all cases, the amount of diluents should be kept as low as possible. For use in engines, the gas must be free from dirt, tar, or condensible constituents. When the gas is to be used in heating furnaces, it is not necessary to clean it, but a higher heating value is usually desirable than is necessary for engine use.

§ 161. *Automatic feeding.*

This will always be desirable and should always be used; it may be accomplished by mechanical means as described in § 200, or by gravity as shown in Fig. 70.

§ 162. *Continuity of operation.*

In all cases it will be desirable to have the producer able to

give continuous service; in fact, for some classes of work, continuity of operation is of the utmost importance. The factors which have the greatest bearing on this requirement are automatic feeding, agitation of fuel bed, and removal of ashes.

§ 163. *Agitation of fuel bed.*

Mechanical pokers or revolving, swinging, or shaking grates are desirable to reduce the manual labor in operating the producer. Any one of the above devices is also conducive to continuity of operation.

§ 164. *Removal of ashes.*

For the continuous and satisfactory operation of the producer, it must be so arranged that the ashes may be removed without interfering with the process of gasification.

§ 165. *Deep fuel bed.*

The fuel bed should have considerable depth to insure complete gasification and a uniform quality of gas. In the suction type of gas-producer, where the blast velocity is low, the depth of fuel bed must not be too great; otherwise the negative work of drawing the air and steam through the fuel will become excessive. (See § 273.) A low-blast velocity necessitates a shallower fuel bed and *vice versa*. With high-blast velocity, a deep fuel bed prevents the formation of least resistance channels for the blast, which would result in localized high temperatures and a higher percentage of CO₂ in the gas.

§ 166. *Introduction of blast.*

The steam and air should be introduced together, as they will then be more thoroughly mixed. They should be introduced at such a place and in such a manner as to secure a uniform distribution through the fuel bed. The zone of highest temperature should be kept away from the grates and walls of the producer, thus preventing the "burning out" of the former and the fusing of clinkers to the latter. Neither should the blast form channels in the fuel bed.

§ 167. *Cleanliness.*

The producer should be so built that the fuel may be introduced without spilling and the ashes removed without difficulty. All joints must be made tight to prevent leakage of the gas into the producer room. This is of more importance with the pressure

type than with the suction type of producer. In case of leakage with the former, the gas will be forced into the producer room and thus vitiate the atmosphere; in the latter case, air will simply be drawn into the producer. (See Chapter 28.)

§ 168. *Ease in starting.*

With producers used for power purposes, it is important that the producer may be easily started after a period of idleness. To do this, it is necessary to have the producer so constructed that it may be kept air-tight during the hours of idleness.

§ 169. *Regulation of steam and air.*

In all suction gas-producers, it is imperative that the proportion of steam and air be kept constant, although the load may fluctuate through a large range (§ 208).

§ 170. *Heat insulation.*

To prevent undue loss by radiation, the producer must be surrounded by a proper non-conducting material. (See § 27.)

§ 171. *Grate efficiency.*

The grate or fuel support must be designed with care and with special reference to the kind of fuel to be used. An inefficient grate may cause a serious loss of fuel in the producer. (See § 139.)

§ 172. *Conservation of heat energy.*

The successful producer must utilize very little of the heat in the solid fuel in the process of gasification, and this is of special importance in producers used for power purposes. The fuel should be pre-heated by means of the sensible heat in the gas; this dries the fuel and cools the gas which is thereby made more desirable for use in an engine. The steam should be superheated and the air pre-heated; this may be done very nicely by utilizing the heat in the exhaust gases of the engine (see § 214 and § 216), and thus return to the producer about 10 per cent of the heat that would otherwise be wasted. With this arrangement a gas-producer will give over 90 per cent efficiency.

CHAPTER XIV.

HISTORY OF GAS-PRODUCERS.

§ 173. *Chronological record.*

The following chronological record gives the dates of the early development of the gas industry.

- 1669. Thomas Shirley conducted crude experiments with carbureted hydrogen.
- 1691. Coal gas distilled by Dean Clayton.
- 1726. Stephen Hales in England pointed out that, by the distillation of coal, an inflammable gas is evolved.
- 1788. British patent issued to Robert Gardiner for the application of waste heat of furnaces to raising steam, by passing the heated products of combustion under a boiler.
- 1791. John Barber took out a patent in England in which he proposed to use "inflammable air" for driving an engine and for metallurgical operations.
- 1792. Manufacture of coal gas introduced in England by Murdock.
- 1798. Lebon tried to make gas by the distillation of wood, but his apparatus was defective.
- 1801. Lampadius (B 10) proved the possibility of using the waste gases escaping in the carbonization of wood.
- 1804. Fourcroy mentioned the separation of hydrogen from water when the latter is brought in contact with white hot carbon.
- 1809. Aubertot (B 9) began to use the waste gases of blast furnaces for roasting ores and burning lime.
- 1812. Aubertot (B 13) secured patent on furnaces for using waste gases of blast furnaces for roasting ores.
- 1814. Aubertot (B 9) suggested gas furnaces for general metallurgical work.

1814. Berthier published paper on waste gases (B 14).
1815. First oil gas-producer built and patented in England by J. Taylor.
1817. First application of the regenerative principle by Stirling.
1829. Neilson began the pre-heating of air for blast furnaces.
1830. Invention of first water-gas generator.
1830. Lampadius (B 16) tried to cupel silver lead by means of coal gas.
1831. British patent issued to James Slater for a method of utilizing waste heat. This is an ingenious application of the same principle to which, in a great measure, the modern regenerative gas furnace owes its success.
1833. British patent issued for the utilization of the waste heat from blast furnaces.
1834. In Jern-Kontoret's *Annaler* there is given a drawing of an apparatus for pre-heating the blast of a blast furnace by means of waste gas (B 8).
1836. Victor Sire, of Cleval, obtained a patent for the manufacture of wrought iron by means of waste gases from a blast furnace (B 18).
1837. Wilhelm von Faber du Faur applied gases to puddling furnaces (B 9).
1837. Furnace for the use of pre-heated air designed by Slater.
1838. Ebelmen, Thomas, and Laurens (B 36) conducted experiments on the gasification of coal in France.
1839. Bischof experimented with the production of combustible gases by means of a separate producer (B 9). This producer is shown in Fig. 11.
1840. Austrian metallurgists attempt to produce combustible gases by the imperfect combustion of small charcoal (B 19).
1840. Ebelmen built a producer at the iron works of Audincourt in France (B 9). This is shown in Fig. 13.
1841. Karsten pointed out the advantages of the gas-producer for the utilization of low-grade fuels (B 9).
1842. Heine verified and amplified the deductions made by Karsten in 1841 (B 9).
1843. In Jern-Kontoret's *Annaler* there is a drawing of Ekman's method of pre-heating the blast by means of waste heat.

1847. Regenerative furnace for the gasification of solid fuel followed by the burning of the gas in a chamber with air pre-heated by the products of combustion; designed and patented in England.
1850. Jern-Kontoret's Annaler contained drawings of Ekman's producer; this is shown in Fig. 15.
1856. British patent granted to Frederick Siemens for an improved gas-furnace.
1856. Beaufume producer tried by the French Government.
1857. Charles W. Siemens made improvements in gas-fired furnaces.
1858. Turner (B 22) in his "Eisenhüttenwessin in Schweden" published an extensive report of the workings of the Ekman gas furnace and gas-producer.
- 1859(?). Wedding producer built in Berlin.
1861. Siemens gas-producer built.

The advent of the Siemens type, which was the first producer that was commercially successful, was the real starting point of the modern gas-producer industry. There are still three important points in the development of the gas-producer: First, the introduction of the Dowson gas-producer in 1878, which was the starting point of the modern producer-gas power development; this was the first producer that was successful for power purposes. Second, the introduction of the Mond by-product process on a large scale in 1889. Third, the introduction of the Benier suction gas-producer in 1895, which was the beginning of the use of gas-producers in small sizes and compact units.

§ 174. *Early use.* (B 14, B 15, B 39, B 44.) (See App., note 13.)

The employment of waste gases from iron furnaces or other metallurgical operations was one of the first steps in the development of gaseous fuel. The chronological record given in the preceding section shows the dates of the early experiments. It is quite probable that the first producer was built by Bischof in 1839, and he was closely followed by Ebelmen in 1840, whose producer resembled a small blast furnace. The methods of both these men have formed the basis of nearly all the fuel-gas systems that have since been used; they consisted in the partial combustion of carbon by forcing a limited supply of air or a mixture

of air and steam into a furnace containing the solid fuel in a state of combustion.

§ 175. *Conservatism in improvement.*

There is no piece of apparatus used in connection with modern industrial work that has undergone so few actual changes and real improvements until the last few years as the gas-producer. Until recently, one found in general use, with but few exceptions, the same form of producer as that originally constructed some sixty-six years ago — a cupola-shaped furnace provided with some form of stationary grate or bed below, a hand-operated coaling hopper above, several poke holes at the top and possibly one at the side. Broadly speaking, the original type of Bischof and Ebelmen represented the larger part of recent practice.

From the foregoing one might conclude that the producer has always given satisfaction and is ideal in its action. But experience shows that this is not the case; in many instances the prevailing form of producer has been very unsatisfactory, especially when fuel economy is considered. At present there are several industries demanding a better producer than most manufacturers are offering, the most important of which being the gas-engine industry.

§ 176. *Want of appreciation.*

While the production and utilization of gaseous fuel for industrial purposes were demonstrated in the earlier part of the last century, yet it is only within recent years that the value of the gas-producer is beginning to be appreciated and that the industry has received any impetus at all. Causes for this lack of appreciation are indicated in §§ 88–90.

§ 177. *Bischof producer.*

This producer is shown in Fig. 11, which gives all the general dimensions of same. The central part or body of the furnace *A*, where the gases are generated, is cylindrical; the upper part *B* and the under part *D* are conical. *R* is a grate, underneath which is an ash pit *E*, closed by an iron plate *F*. An opening immediately above the grate is arranged to be closed by an iron door *G*; *S* is a damper in the delivery flue. The throat of the producer is separated from the body by a damper *C*, and the top is closed by an iron lid *P*. The volume included between *C* and *P* is sufficient to hold one charge of the fuel with which the producer is

charged at intervals; by moving *C*, when *P* is closed, the charge of fuel can be introduced through the throat without any escape

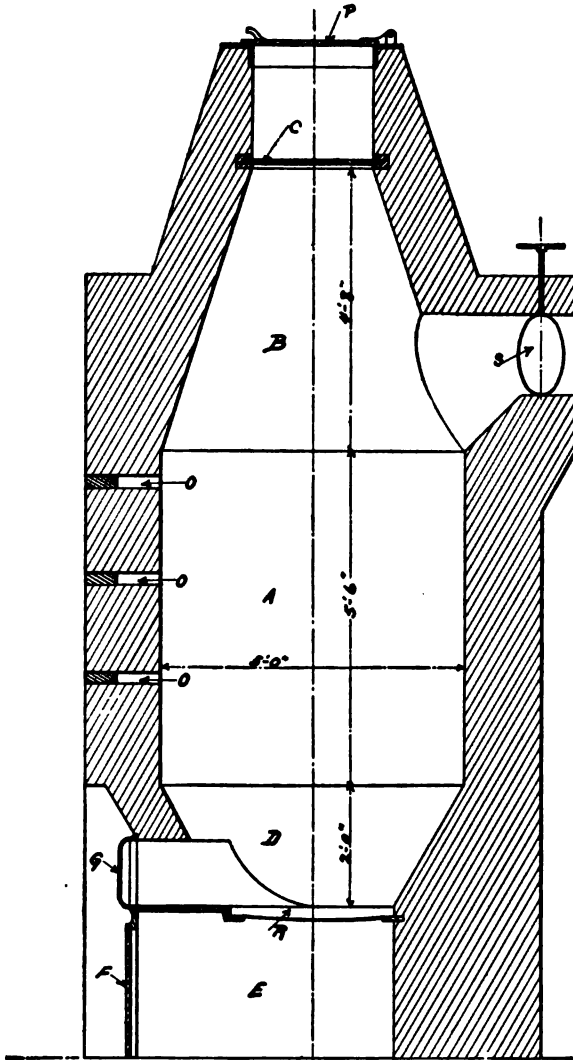

FIG. 11. — BISCHOF PRODUCER.

of gas. The air required for combustion enters through several apertures in the plate *F*; these are so arranged that their areas

can be increased or diminished. The progress of combustion is under control by means of the damper and the apertures referred to, and can be observed through the holes *O*, which, when not in use, are closed by brick stoppers.

When the producer is working properly, its interior, as viewed through the lowest hole, should appear incandescent; at the middle hole the action should be less intense, and at the upper hole no signs of ignition should be visible. When the latter is not the case, there is much danger that the CO_2 will be excessive. In order to diminish this trouble, the fuel bed should be increased in thickness and possibly the amount of air should be decreased. No blast is used and the draft is produced by the furnace which the producer supplies.

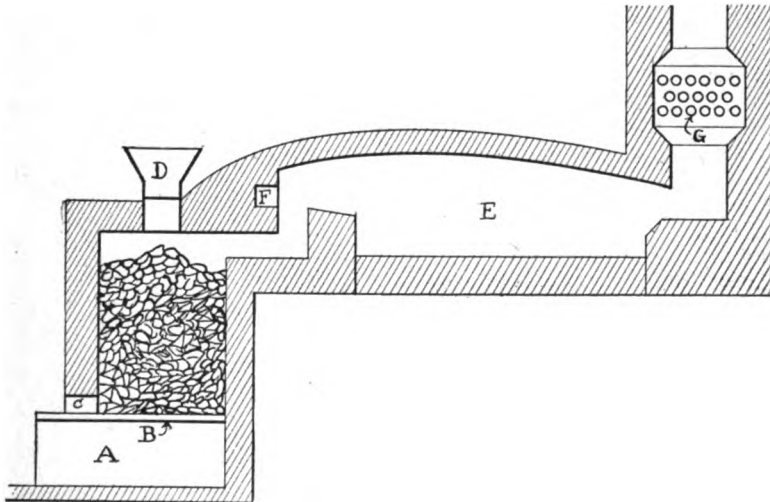

FIG. 12. — EBELMEN GAS-PRODUCER.

§ 178. *Ebelmen's producers.* (B 2, B 3, B 39, B 214.)

Ebelmen designed, built, and operated three types of gas-producers at the iron works of Audincourt, France. The first of these is illustrated in Fig. 12, which shows the application of the producer to a puddling furnace. *A* is the ash chamber into which the blast is introduced; it then passes up through the grates *B* and into the fuel above. Steam is admitted at *C*. *D* is the charging hopper. *E* is the furnace in which the gas is burned, the air for combustion being pre-heated by

passing through the pipes *G* and then introduced into the furnace at *F*.

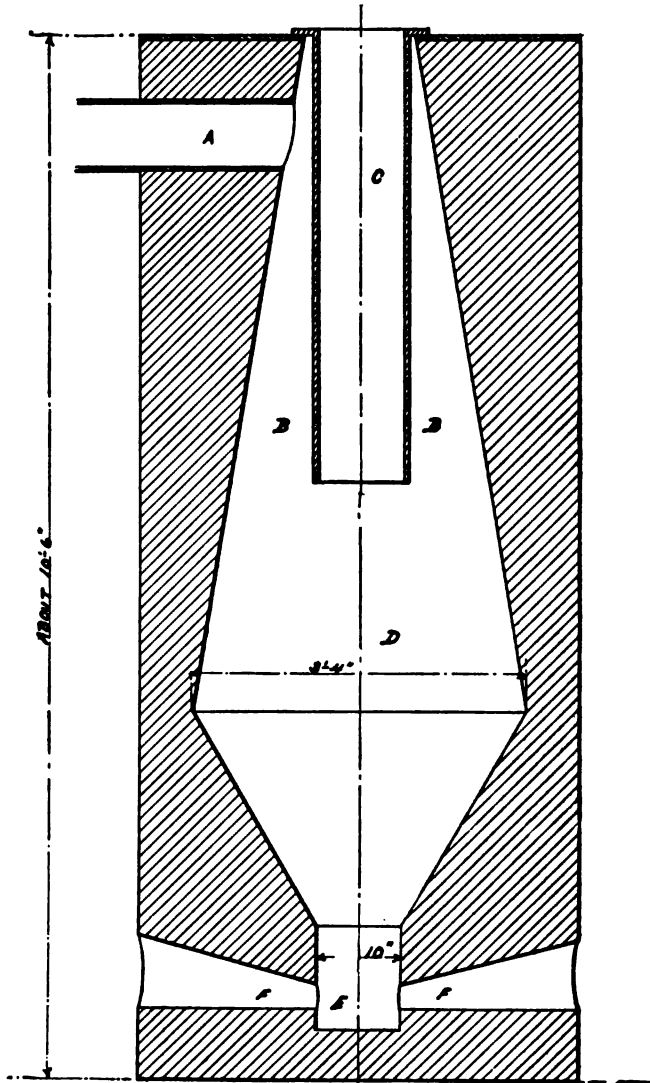

FIG. 13. — EBELSEN PRODUCER.

The blast-furnace type of producer is illustrated in Fig. 13. It is worked with a blast of air which enters at *F*. In general

outline it resembles a small blast furnace. *C* is a cast-iron pipe which descends from the throat into the body of the furnace and which is kept constantly filled with fuel; at Audincourt the fuel was small charcoal. A lid is necessary only when large lumps of fuel are used, the small pieces offering sufficient resistance to the passage of the gases which find a free passage from the body of the furnace *D*, up and through *B*, and out into the flue *A*. *E* is the hearth of the furnace into which the blast is introduced. About $1\frac{1}{2}$ parts by volume of iron-furnace slag and clay are

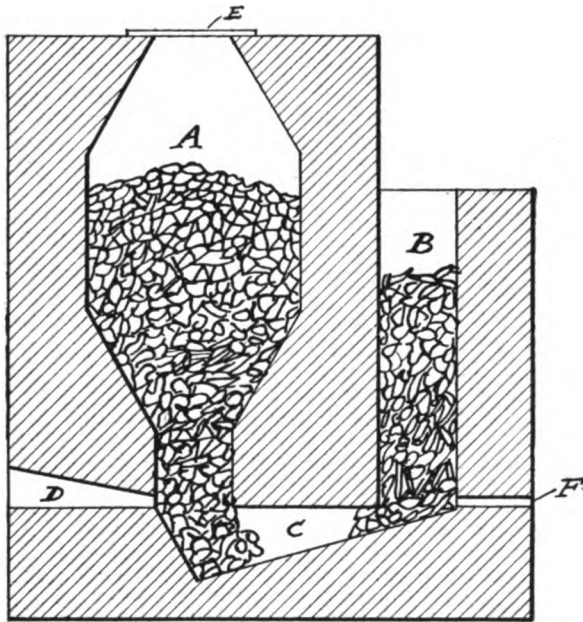

FIG. 14. — EBELMEN GAS-PRODUCER.

charged into the furnace with every 100 parts of combustible; this forms an easily fusible slag with the ash, which can then be run off from the bottom of the hearth, *E*. In the operation of this producer, the condensation of the tarry vapors in the flue *A* was a source of constant trouble when uncharred fuel was used in the producer.

The down-draft type of producer is illustrated in Fig. 14. *A* is the main chamber of the producer; this is connected with *B* by

means of *C*. Raw or fresh fuel is delivered to *A*, and *B* is filled with incandescent carbon. The blast is admitted at *D*, passes

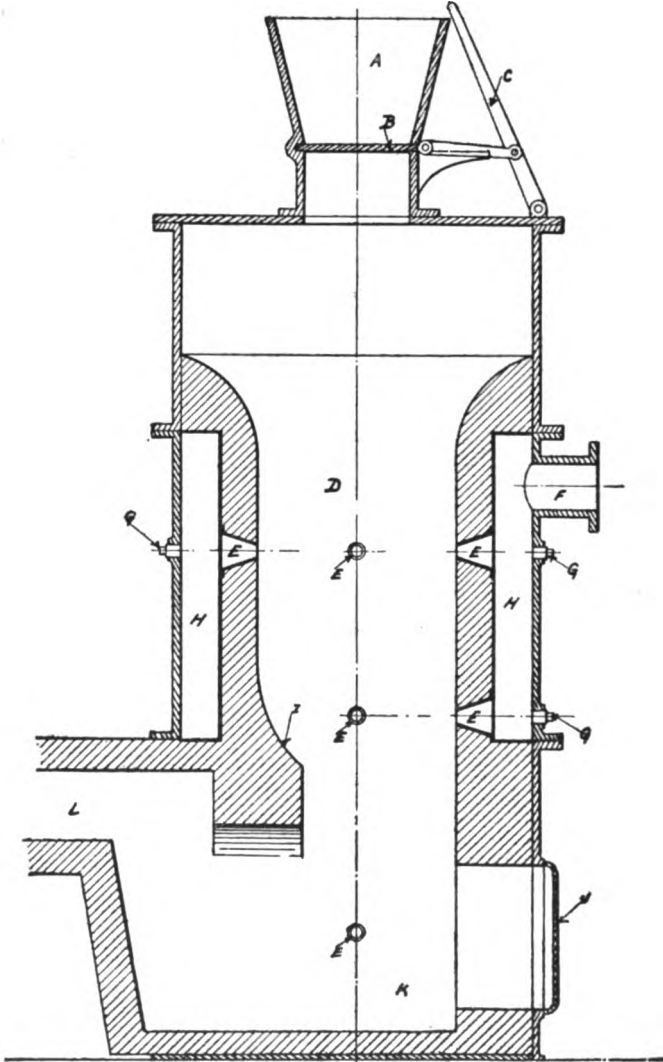

FIG. 15. — EKMAN PRODUCER.

through *C* and up through *B*; in this way the air is drawn down through the fuel in *A*. *E* is the lid for the chamber *A* and is

fitted with an arrangement to regulate the amount of air passing through. The object of this type of producer was to break up

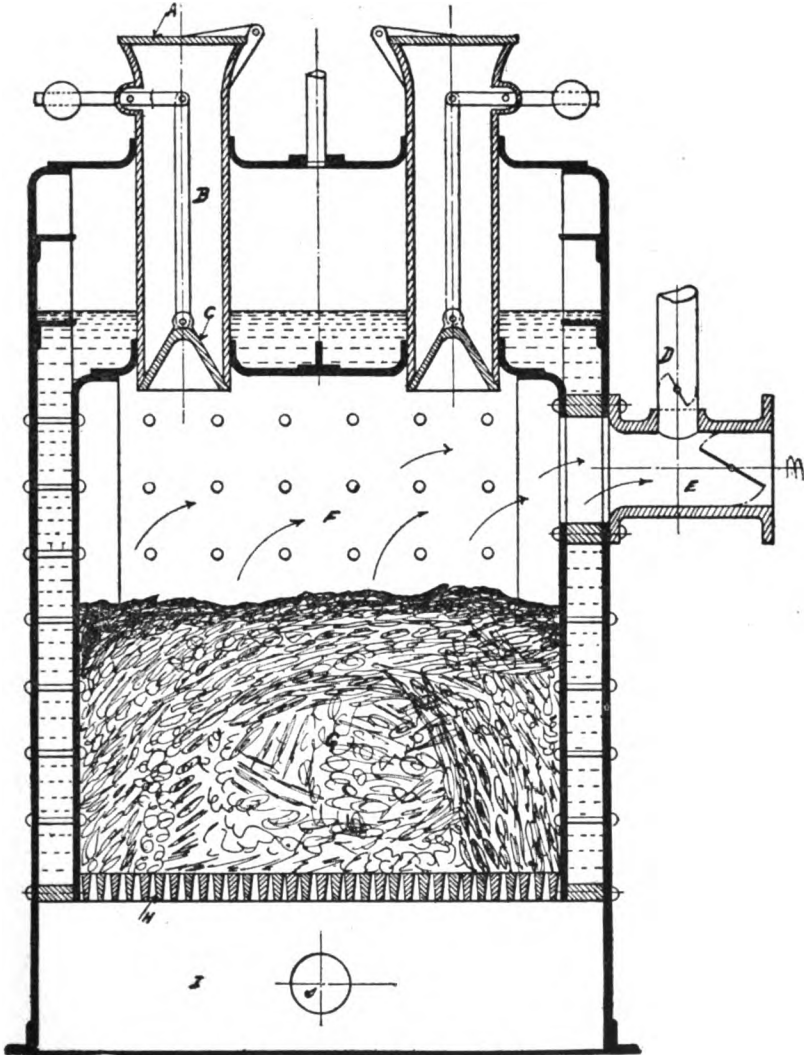

FIG. 16. — BEAUFUME PRODUCER.

the tar and other hydrocarbons in the gas. The original drawings show a small blast pipe at *F*, and it is quite probable that

steam was introduced at this point, although no mention is made of it in the original description.

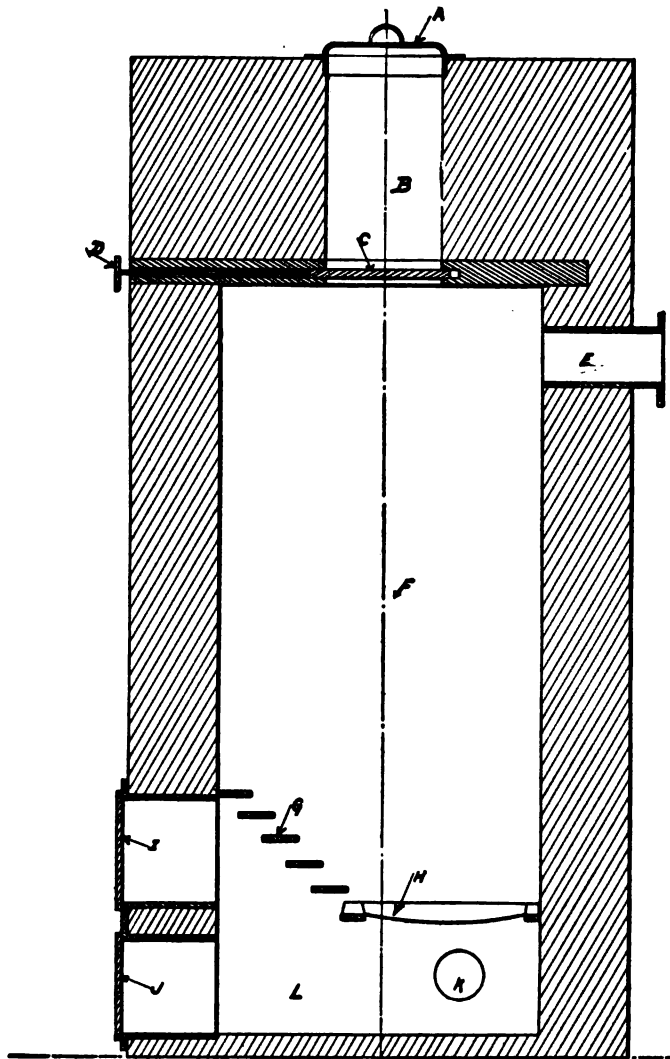

FIG. 17. — WEDDING PRODUCER.

§ 179. *Ekman producer.* (B 15.)

This producer was designed by Gustaf Ekman and was used at the Ekman Iron Works in Sweden for reheating slabs of iron.

Its construction is shown in Fig. 15. *D* is the body of the producer into which the fuel is charged by means of hopper *A* and sliding damper *B*. *C* is a lever for operating *B*. The inside of the producer is lined with firebrick and the body of the producer is inclosed within a cast-iron jacket; a free annular space is left between them. The blast enters at *F* and then passes into the producer through the tuyeres *E*; the object of the annular space *H* is to pre-heat the blast and also to reduce the radiation loss. The interior of the producer could be examined by removing the plugs *G*. *K* is the ash pit, the ashes being removed by means of the door *J*. The object of the ledge *I* is to prevent the entire mass of fuel from falling or sliding down while the ashes are being removed. *L* is the flue leading to the furnace where the producer-gas is burned. Wood charcoal was the fuel used in this producer.

§ 180. *Beaufume producer*. (B 8, B 9, B 39.)

This producer was tried by the French Government at the Imperial Arsenal at Cherbourg, and it is shown in Fig. 16. *A* is the cover to the charging hopper. *C* is a bell which is connected to a counterweight by means of link *B*. *E* is the flue leading to the furnace and *D* is a pipe communicating with the atmosphere. *G* is the fuel bed, which is about 24 inches deep, and this is supported on the grate bars *H*. The blast enters the ash pit *I* through pipe *J*, then passes up through the fuel into the space *F*, then out into *E*. The entire producer is surrounded by the water jacket.

§ 181. *Wedding producer*. (B 15.)

This producer was in use at the Mint and Royal Porcelain Manufactory at Berlin prior to 1861. (See preface to Percy's Metallurgy, vol. on Fuel, also p. 517 therein.) It is shown in Fig. 17. *A* is the door to the charging chamber *B*. The fuel is dropped into the body of the producer *F* by means of the sliding damper *C*, which is operated by handle *D*. *E* is the flue leading to the furnace. *G* and *H* are grate bars. *I* and *J* are doors for gaining access to the ash-pit *L*. *K* is a pipe through which the blast enters.

§ 182. *Siemens producer*.

This is shown in Fig. 18. *A* is a self-closing hopper for charging the producer with fuel. *B* is the apron wall composed of brick resting on a cast-iron plate *C*. *D* is a grate composed of

horizontal flat bars. *E* is an opening for cleaning or poking the fire or testing the gas. *F* is a cleaning and explosion door.

The gas leaves the producer through the brick uptake *G*, iron-cooling tube *H*, and iron downtake *I*; it then goes to the furnace through the flue *J*. *K* is a tar well that catches the tar condensed in the tube. The action of the cooling tube is as follows: The temperature of the gas as it leaves the producer is about 400 degrees C.; this is cooled to about 100 degrees C., thus de-

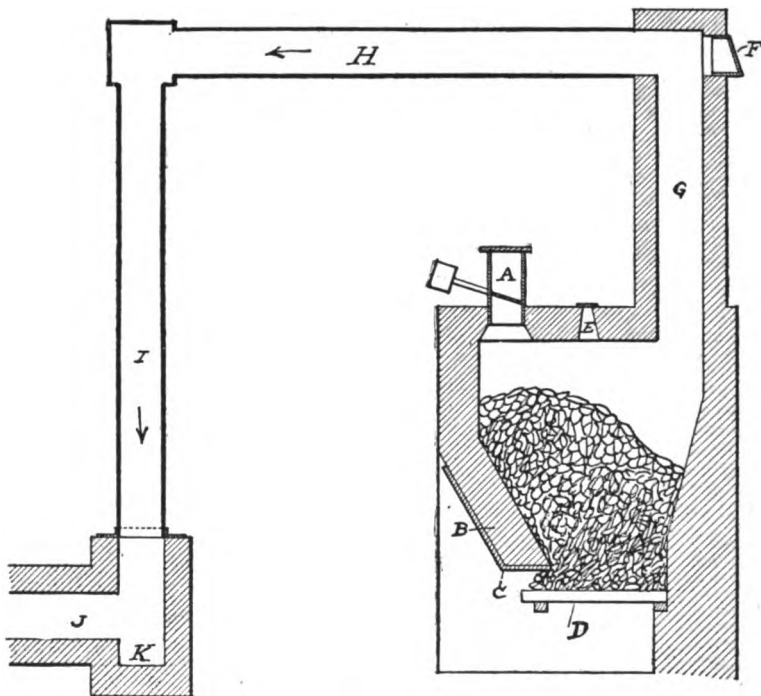

FIG. 18. — SIEMENS GAS-PRODUCER.

ing the volume and increasing the density of the gas, thereby making the volume of gas in *I* heavier than that in *G*. As a result, a current is produced in the direction of the arrows, and a draft is established in the producer.

The cooling tube is a very cumbersome means for inducing the draft in the producer, and this now is always dispensed with and a positive blast is introduced in the ash pit, which is enclosed.

CHAPTER XV.

AMERICAN PRESSURE GAS-PRODUCERS.

§ 183. *Taylor fluxing gas-producer.* (B 24.)

This producer was designed about 1878 by Mr. W. J. Taylor, for use in his ore-roasting kilns at Chester, N. J. It has the general lines of a blast furnace, with the following dimensions: The hearth is 24 in. diameter and 24 in. high. The bosh wall makes an angle of 25 degrees from the vertical, and enlarges to 4 ft. diameter; then it is drawn in to 3 ft. at the top, the total height being 12 ft.

The blast enters through a 1½-in. nozzle which is placed in a water-coil tuyere 12 in. above the bottom. The blast is produced by a small Weimer blowing engine which furnishes 300 cu. ft. of air per minute at a pressure of 1½ lb. per square inch. The producer consumes about 200 lb. of coal per hour and 1½ h. p. is required to blow it. The ashes are fluxed out about every two hours. Cinders and limestone are charged in with the coal and thus act as fluxes.

The advantages claimed for this producer were:

- (1) Uniform quality of gas and low per cent of CO₂.
- (2) There was no cleaning of ashes; the producer was kept in continuous operation for at least four weeks.
- (3) The quantity of gas from this producer could be increased by simply increasing the amount of air entering it.

§ 184. *Langdon gas-producer.* (B 35.)

This producer is shown in Fig. 19, and it was designed for use at the Taylor ore-roasting furnace at Chester, N. J. The producer is built on the general lines of a blast furnace, and consists essentially of a cylindrical furnace, enclosed in an iron jacket or casing, having a bosh or inverted cone-shaped base. The fuel is charged in through the bell and hopper at the top. The producer is cleaned by means of the small door placed at the hearth level,

which, in order to facilitate cleaning, is elevated above the floor. The door can be removed, and when closed is held tightly against its frame by means of lugs.

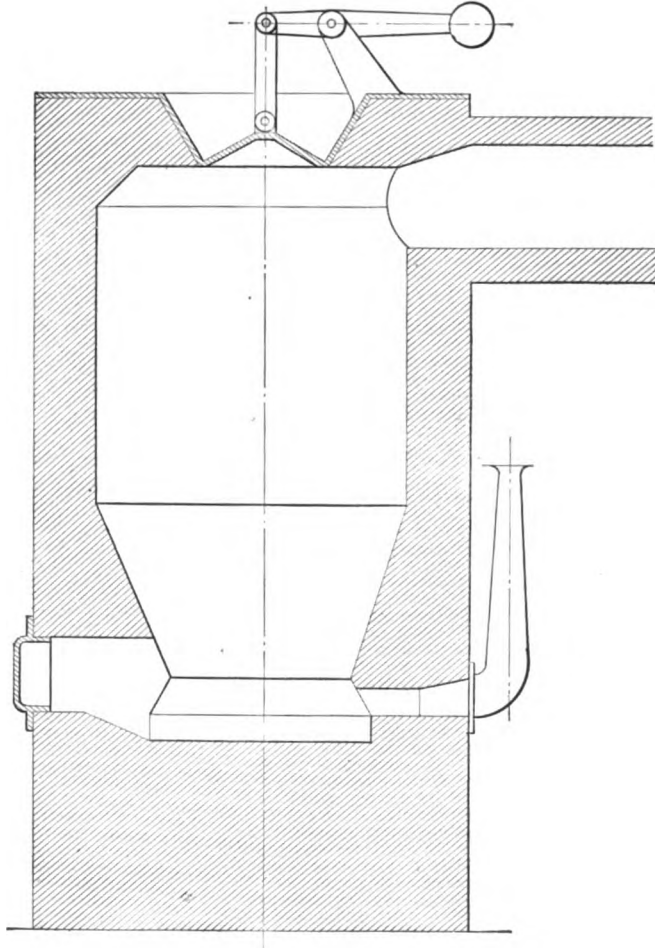

FIG. 19. — SECTION OF LANGDON GAS-PRODUCER.

The blast is furnished by air and steam which is injected into the fuel through a series of tuyeres underneath the bosh. A small flue also connects the door passages with the blast pipe, and a portion of the blast entering in this way prevents the doors

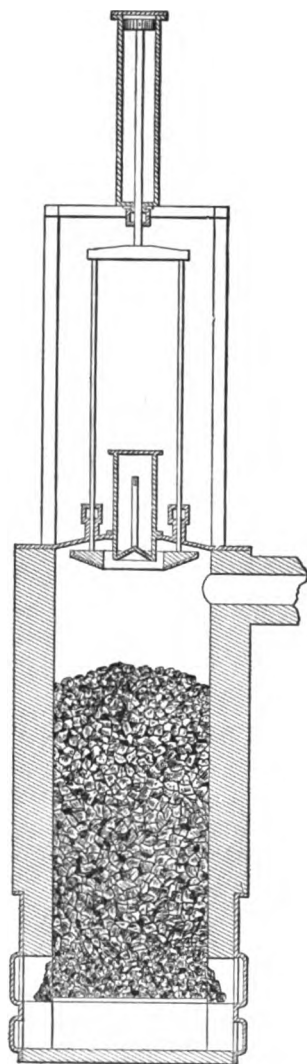

FIG. 20.—SECTION OF FUEL
GAS AND ELECTRIC ENGINE-
ERING CO.'S GAS-PRODUCER.

from becoming warped and overheated. The gases pass off through the flue at one side near the top.

In cleaning, the fuel in the upper part of the producer is held by the sloping walls of the bosh while the ash below is removed. Anthracite and bituminous coal and coke dust have been used successfully in this producer.

§ 185. *Fuel Gas and Electric Engineering Co., Ltd., Producer.*

This producer is shown in Fig. 20; it was used by the above company for the manufacture of fuel gas.

Fig. 20 represents a vertical section. The shell is 20 ft. high, 9 ft. outside diameter, and the diameter inside the lining is 6 ft. The producer has large cleaning and ash-pit doors on both sides opposite each other in order to facilitate cleaning.

In order to get a gas low in carbonic acid, a much larger depth of fuel was used. As it would be impossible to poke such a deep fire by hand, a pneumatic rammer was placed upon the producer. This rammer consists of a cast-iron ring, so constructed that it will not only exert a pressure upon the coal but also force the coal to the periphery of the producer, which is desired because the gas has a tendency to creep up along the walls. The ring is raised by air pressure and allowed to fall upon the fuel, the stroke given depending upon the blow necessary to make the fuel sink regularly.

Steam is admitted under the grate, and both air and steam are controlled by valves from the top of the producer.

This producer gasified from 12 to 15 tons of coal in 24 hours.

The carbonic acid in the gas was sometimes as low as 1.4 per cent.

The following is an analysis of the gas, at a pressure of four inches of water:

CO ₂	3.4%
CH ₄	3.1%
H	9.2%
C ₂ H ₄8%
CO	23.3%

The remainder was mainly nitrogen.

§ 186. *Kitson gas-producer.* (B 90, B 131.)

This producer is shown in Fig. 21. The grate is connected on one side with a steam and air injector; on the other, with the

gas-supply pipe, which runs to the place of consumption and is surrounded by a cast-iron box securely attached to the cylindrical

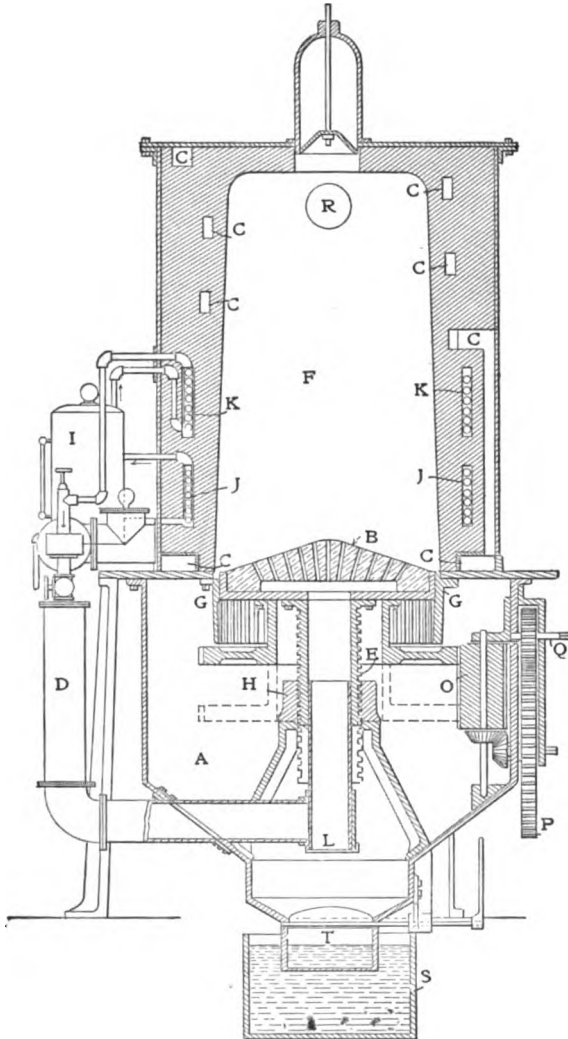

FIG. 21. — SECTION OF KITSON GAS-PRODUCER.

shell, forming the ash pit. The whole machine is supported on four cast-iron legs.

The ash box terminates in a mouthpiece which is opened and closed with a valve operated by a lever from the outside; the mouthpiece thus serves to dump the ashes, whenever desirable, without interfering with the process of making the gas. A small reservoir forming the boiler is placed on one side and communicating therewith are two coils contained in the brickwork. The lower coil heats the water and furnishes steam, and the upper coil superheats it.

Air channels are arranged spirally in the brickwork, through which air is drawn by the injectors. The air thus becomes heated before mixing with the steam, which must be thoroughly dry.

The grate is provided with a mechanism for giving it a rotary and up-and-down motion, the effect of which is to break up any clinker that may have adhered to the sides of the furnace, to keep the coal in a compact mass, avoiding holes in the fuel, and to throw the dust and ash into the ash pit. The coking with soft coal is effectively broken up, and the steam finds an easy passage through it.

The following is an explanation of Fig. 21: *A* ash pit, *B* fire-brick hearth or grate, *C* air-passage ways for heating air supplied to injectors, *D* injector pipes leading to center of grate, *E* and *H* screw and hub for giving grate the rotary and up-and-down motion, *F* furnace, *G* vertical grate bars, *I* steam boiler, *J* hot-water coils connecting with boiler, *K* superheating steam coils communicating with boiler, *L* dust valve, *M* injectors, *N* hopper to supply coal to furnace, *O*, *P*, *Q* mechanism for rotating grate, *R* gas take-off pipe, *S* water seal, *T* butterfly valve for dumping ashes.

§ 187. *American Furnace and Machine Co.'s producer.*

Fig. 22 is a vertical section on line *CD*. Fig. 23 is a vertical section on line *AB*. Fig. 24 is a horizontal section on line *EF*. The producer consists of a cylindrical body with charging hopper above, sloping grates and water-sealed ash pit below. Two blowers are used for furnishing the blast, which is admitted under the grates as shown in Fig. 22.

§ 188. *Amsler gas-producer.*

The construction of this is shown in Fig. 25. *A* is the producer body with the usual charging hopper *B* and gas outlet *C*. *D* are poke holes for stirring the fuel in *A*. *E* is a steam blower

which drives the blast through *F* into *G* and up through cone *H*. *I* is the water-seal ash pit.

§ 189. *The Swindell gas-producer.*

The principal features of this producer are shown in Fig. 26,

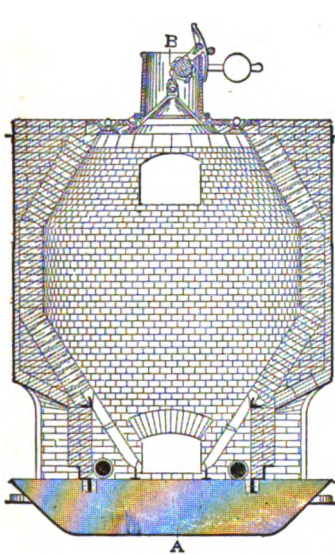

FIG. 22. — AMERICAN FURNACE AND MACHINE CO.'S PRODUCER.

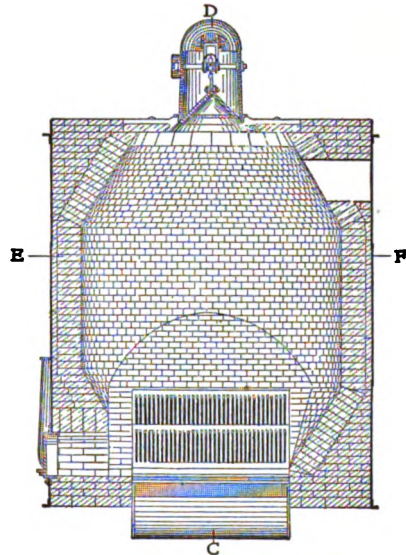

FIG. 23. — AMERICAN FURNACE AND MACHINE CO.'S PRODUCER.

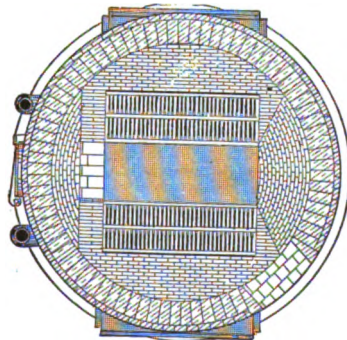

FIG. 24. — AMERICAN FURNACE AND MACHINE CO.'S PRODUCER.

which is a vertical section; Fig. 27, which is an elevation; and Fig. 28, which is a horizontal section. There are two sloping grates,

G, Fig. 26, located centrally, with a body of coal between them, so as to secure the full working capacity of the grate surfaces.

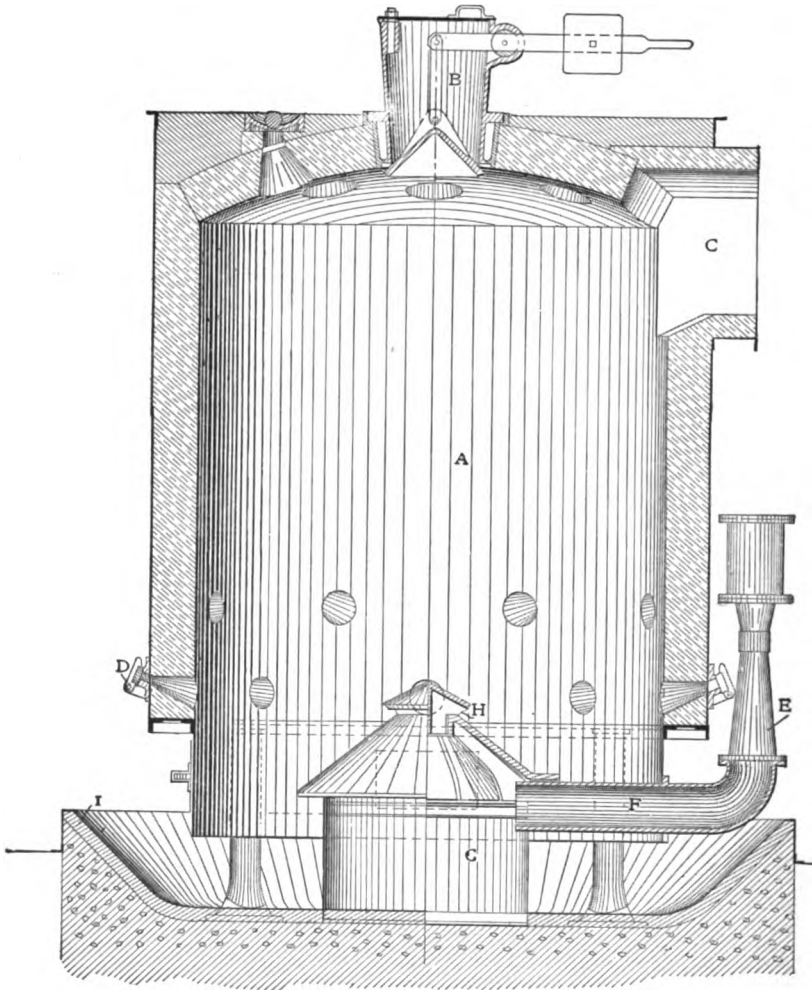

FIG. 25. — SECTION OF AMSLER GAS-PRODUCER.

The starting and cleaning door *C* is located at the lowest point at the water-seal line. The water-seal pan *AP* has a width equal to that of the grates and a length equal to the diameter of the jacket. It is divided into two sections, so that the ashes may be

removed at both ends conveniently. The steam pipes *S* extend over the whole length of the grates and are so arranged that the current of steam is directed toward the center of the body of coal instead of toward the walls. This is done to avoid the formation of clinkers. The gas neck is located at the highest point of the chamber so that there is no dead space for the accumulation of gas. This gas neck has a cleaning stopper hole at the top and a cleaning door at its end. By shutting off the gas main by the damper plate *SD*, any producer of a battery in operation can be cleaned without stopping the operation.

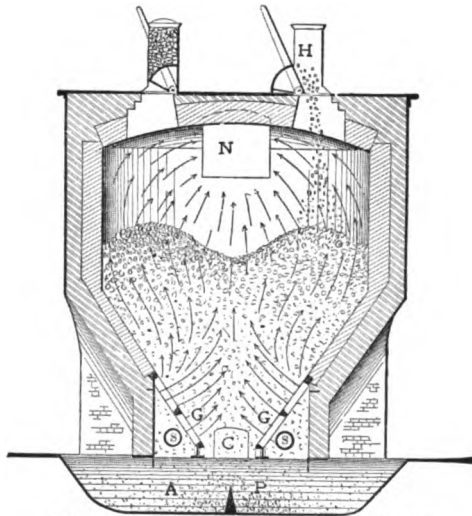

FIG. 26. — SWINDELL GAS-PRODUCER.

Two coal hoppers, *H*, are provided to effect an easy and even distribution of the coal over the whole area of the grates. The tongue of these hoppers is hollow at the back so as to avoid the over-heating and consequent warping which causes leaky joints. There are four ball poke holes in the roof and two stopper poke holes in the top plates of the hoppers, so that every part of the coal pile in the chamber is within easy reach of the operator. Since the gas chamber has a brick roof, the top of the producer is protected against excessive heat.

§ 190. *The Forter gas-producer.*

This producer is shown in Fig. 29. It consists, in the main, of a

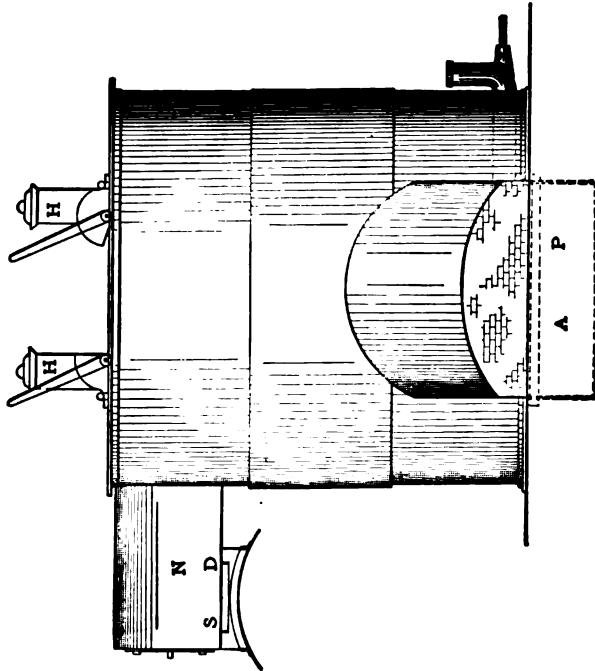

FIG. 27. — SWINDELL GAS-PRODUCER.

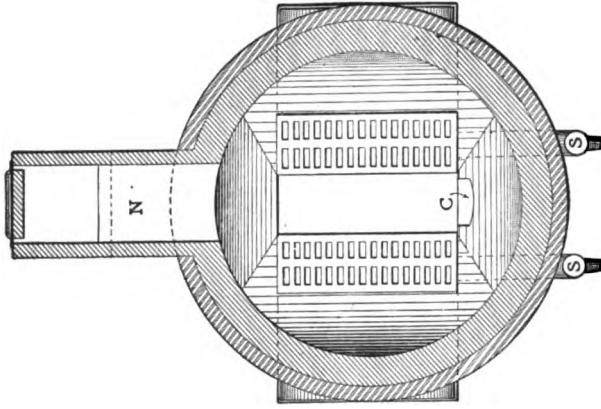

FIG. 28. — SWINDELL GAS-PRODUCER.

circular body *A*, with gas outlet *B* on the side, and a cast-iron plate containing the usual hopper *C*, and poke holes *D* on top.

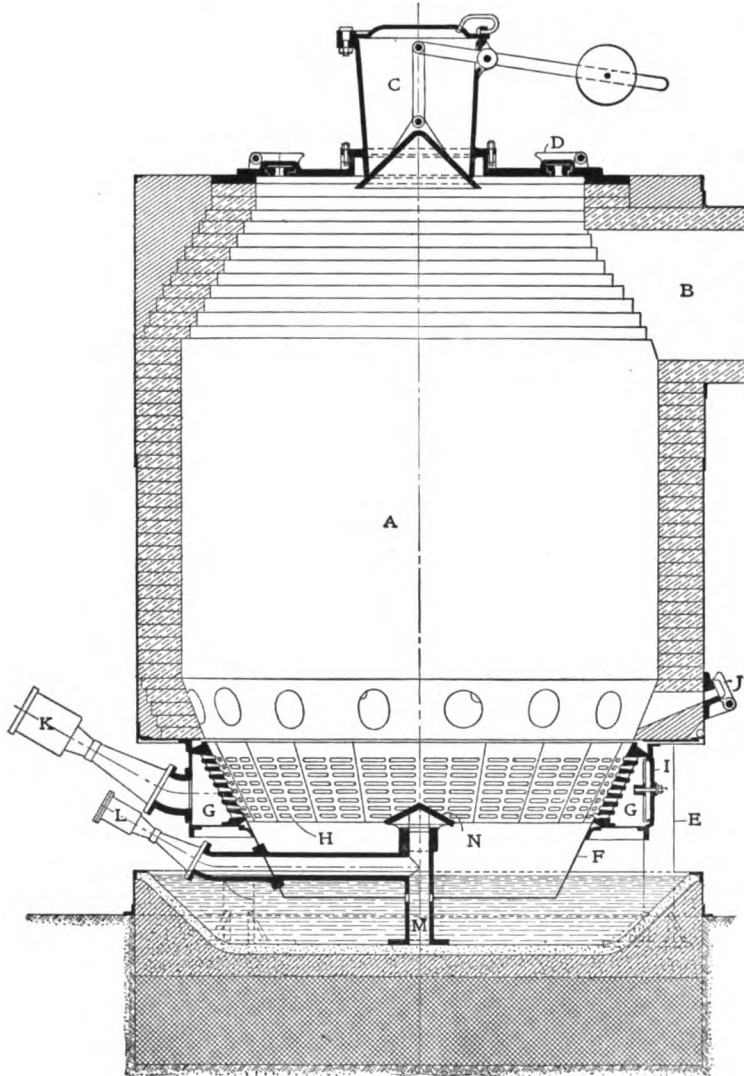

FIG. 29. — SECTION OF FORTER-MILLER GAS-PRODUCER.

The shell and lining are supported by four cast-iron columns *E*, which rest on the foundation of the producer. A conical ash

hopper *F*, made of heavy steel plates and calked air-tight, is suspended from the bottom of the shell and extends a few inches below top of ash pan, thus forming a water seal with the water contained in the pan.

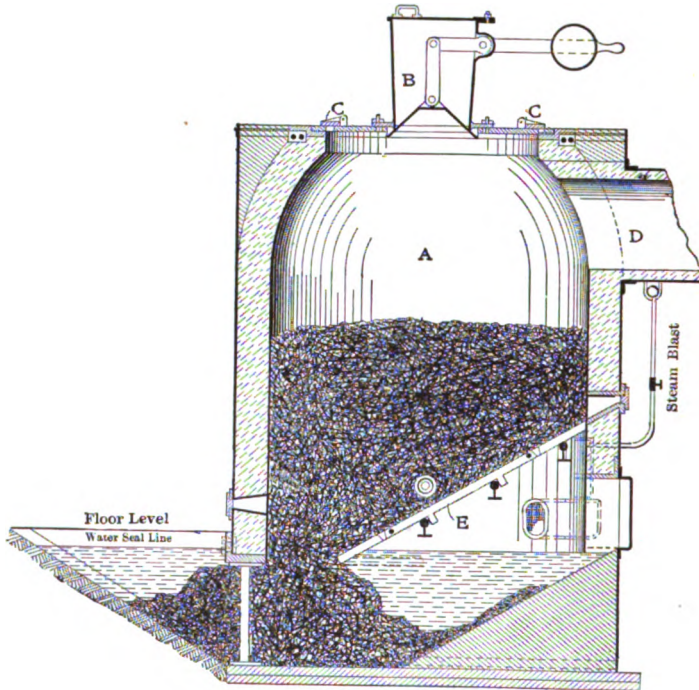

FIG. 30. — SMYTHE GAS-PRODUCER.

At its upper end, the ash hopper is provided with a wind box *G* adapted to receive grate sections *H*. A number of air-tight doors *I* are located in the wind box, through which the grate sections can be inserted or removed. These doors, when open, give access to the fuel bed through the grate sections, so that clinkers that might accumulate on the grates can easily be removed from the outside. A row of poke holes *J*, just above the wind box, give additional facilities for removing heavy clinkers.

The air necessary for gasification and partial combustion is delivered into the wind box by steam blower *K*, and enters the fuel through the circumferential grates. A third steam blower *L* delivers air through a centrally located vertical pipe *M*, covered

with a cone-shaped hood *N*, to the center of the fuel bed. The fuel is supported on a bed of ashes which rests in a pan below the hopper.

§ 191. *Smythe gas-producer.*

The construction of this producer is shown in Fig. 30. It consists of a circular body *A*, charging hopper *B*, cast-iron top with poke holes *C*, gas exit *D*, and inclined grate *E*. The steam is introduced at a higher point than usual and acts directly on the incandescent mass of coal.

§ 192. *Duff gas-producer.*

The construction of this is shown in Fig. 31, which is a section

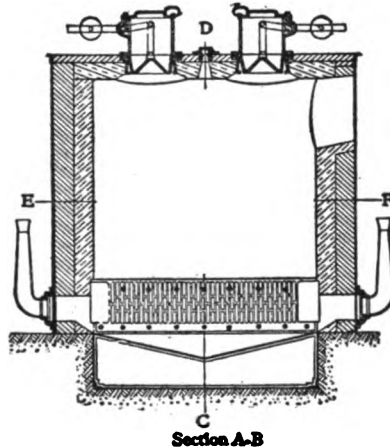

FIG. 31. — DUFF GAS-PRODUCER.

on line *AB*; Fig. 32, which is a section on line *CD*; and Fig. 33, which is a section on line *EF*. The main features are embodied in the following patent claims, given verbatim:

1. "A gas-producer provided with a water-sealed bottom trough and a casing located in the lower portion of the producer provided with an inlet for air from the blower and with a cover of gratings inclined from the sides of the casing upward to a middle angular ridge, and free spaces between the said casing and the sides of the producer for the residues to pass from the gratings of the said casing to the water trough."

2. "A gas-producer of rectangular section provided with a water-sealed bottom trough and a transverse casing extending

from side to side of the producer across the center thereof, the said casing being provided with an inlet for air from the blower and with a cover having vertical openings therein, said cover being inclined upward from its opposite sides between the casing and the sides of the producer."

3. "A bottom casing or chamber into which a blast of air and steam is delivered; a top or cover for this casing or chamber consisting of outwardly inclined gratings having openings to distribute the blast under the bed of the fuel and forming also guiding surfaces down which the residue ashes will slide towards the

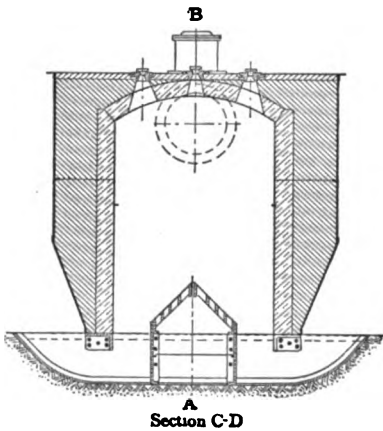

FIG. 32. — DUFF GAS-PRODUCER.

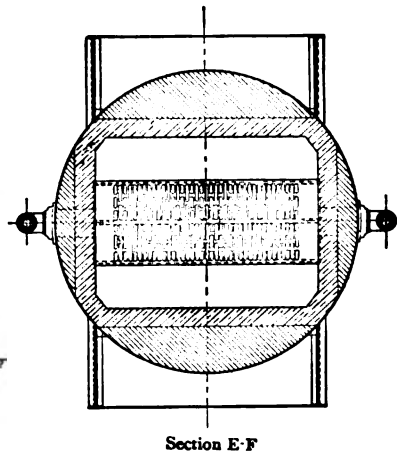

FIG. 33. — DUFF GAS-PRODUCER.

exterior of the producer, and free spaces between the lower edges of the inclined gratings and the walls of the producer through which the ashes will descend into the water trough which seals the bottom of the producer, and from which trough the removal of the ashes is effected without making any opening into the producer and without interruption of the air blast."

§ 193. *Taylor gas-producer.*

This producer was designed as a result of extensive experiments covering about twelve years, conducted by Mr. W. J. Taylor in connection with his ore-roasting kilns at Chester Furnace, N. J. It is shown in Fig. 34 and 35.

The type illustrated in Fig. 35, with a revolving bottom and shell lined with firebrick, is that usually adopted for an-

thracite and a good quality of bituminous coal. For bituminous coals liable to clinker, the design with the water jacket

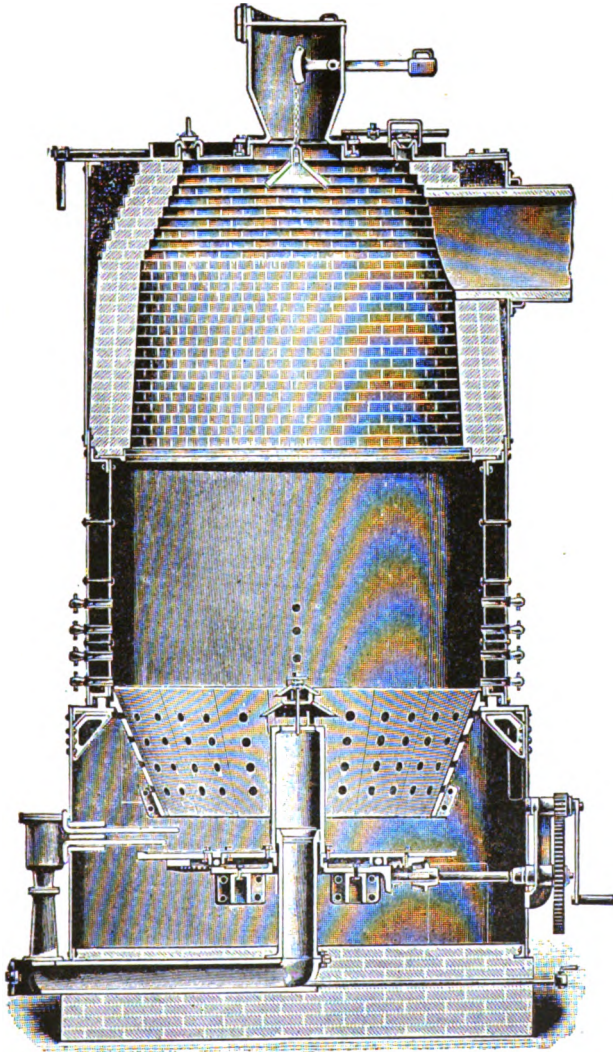

FIG. 34. — SECTION OF TAYLOR GAS-PRODUCER.

shown in Fig. 34 is used. The clinker will not adhere so readily to the smooth sides of the water jacket as to firebrick, and the

former is not liable to injury when poke bars are used from above.

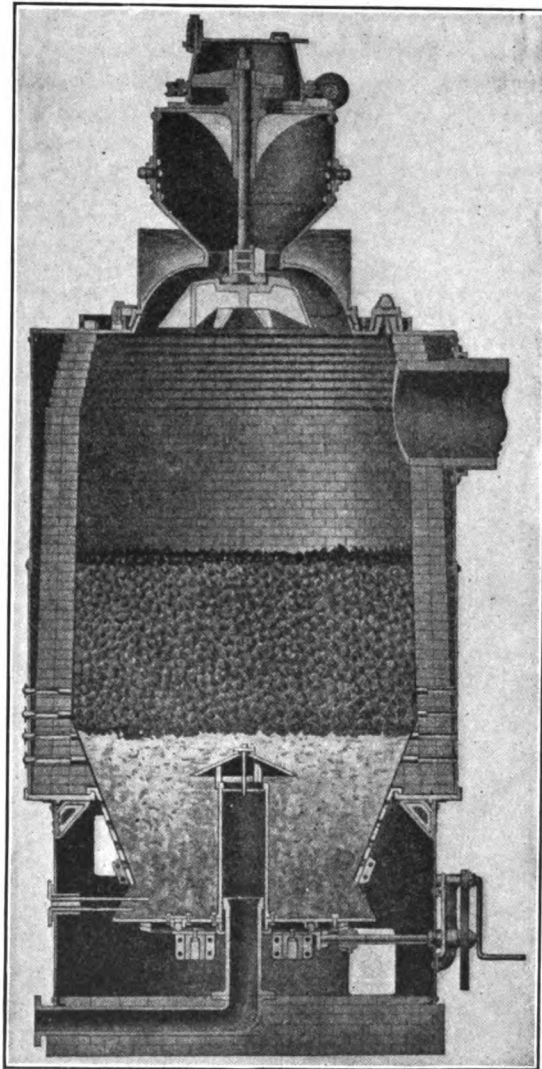

FIG. 35. — SECTION OF TAYLOR GAS-PRODUCER.

The distinguishing features of the producer are as follows:
The maintenance of a deep fuel bed carried on a deep bed of

ashes. Blast carried by conduit through the ashes to the incandescent fuel.

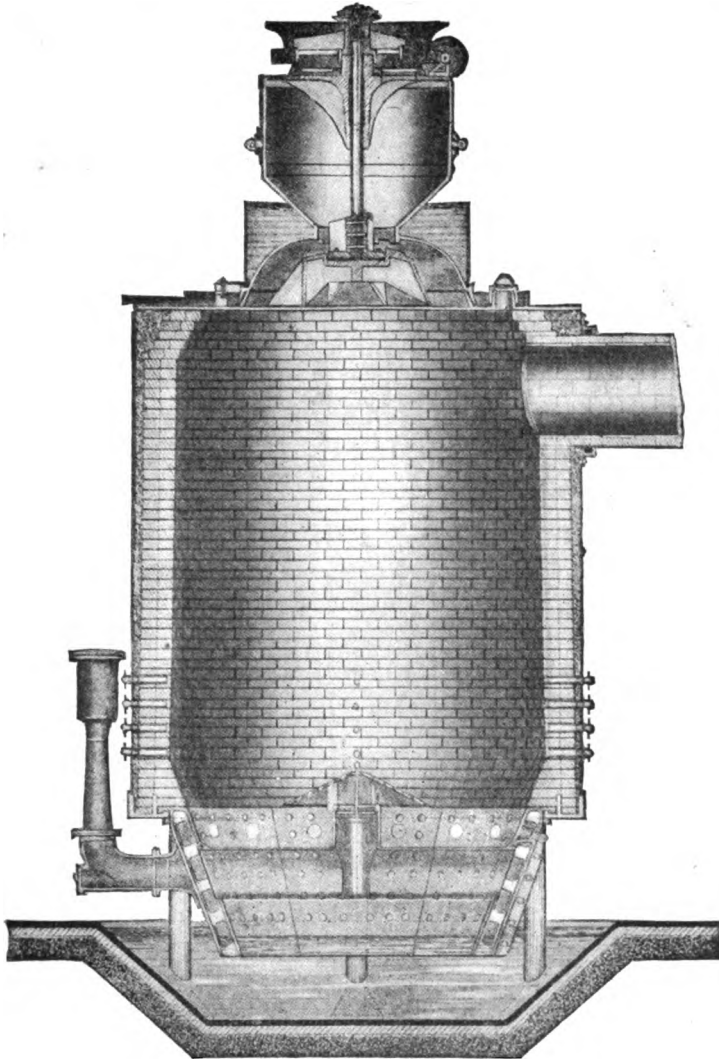

FIG. 36. — SECTION OF WOOD DOUBLE-BOSH GAS-PRODUCER.

The revolving bottom, the turning of which will produce a grinding action in the lower part of the fuel bed, and thus close up any channels that may have been formed by the blast, in this

way keeping the CO_2 in the gas low. A few turns of the crank at frequent intervals will keep the fuel bed solid.

§ 194. *Wood double-bosh gas-producer.*

This is shown in Fig. 36. The special feature is its double

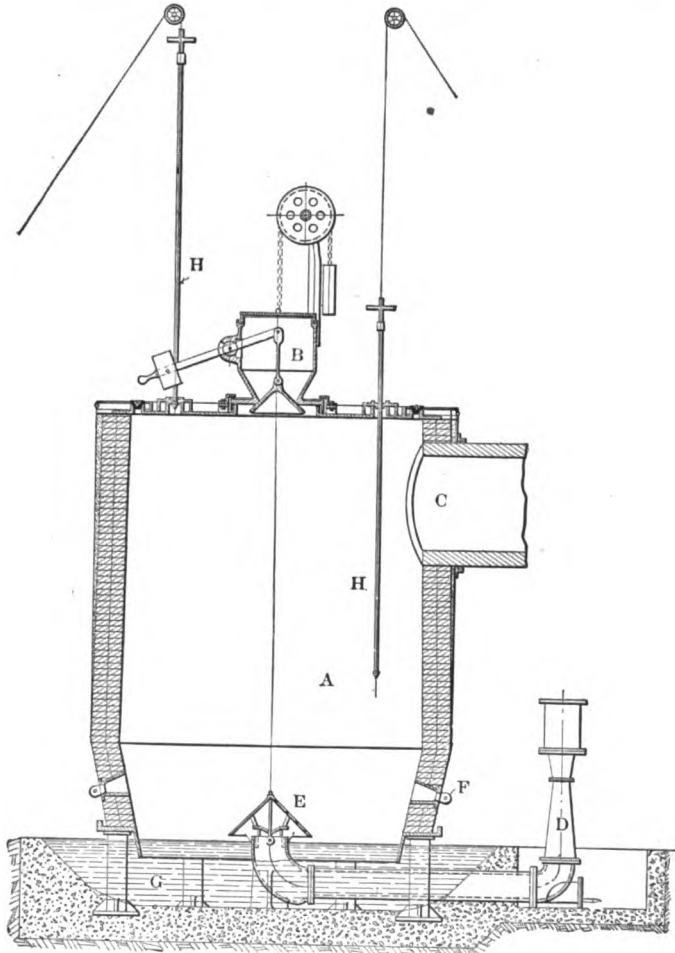

FIG. 37. — SECTION OF WOOD WATER-SEAL GAS-PRODUCER.

bosh. The air entering the blast pipe, which protrudes through the bosh plate, passes to the vertical central air conduit and circulates also about the inner boshes. These are perforated, per-

mitting the passage of the air into the ash bed, taking up its heat and insuring checking the escape of combustibile matters in the ash.

This type, equipped with the Bildt automatic feed as shown, has given excellent service with the lignite coals of the West.

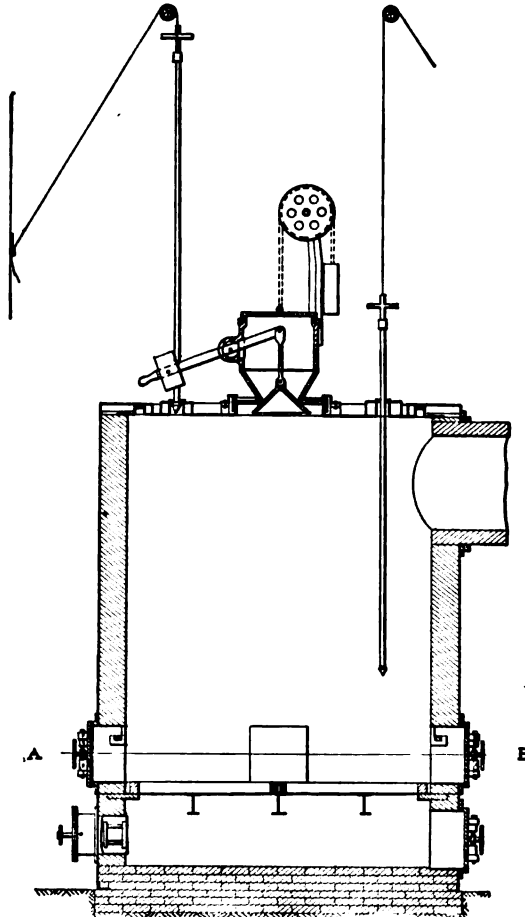

FIG. 38. — WOOD FLAT-GRATE GAS-PRODUCER.

§ 195. *Wood water-seal gas-producer.*

This is shown in Fig. 37, where *A* is the body of the producer, *B* the coal-feeding hopper, and *C* the gas exit. *D* is a steam

blower that forces the blast through and around the cone *E*. *F* are poke holes, and *G* is the water-seal ash pit. *H* are balanced poking bars, six being placed on the top of the producer.

§ 196. *Wood flat-grate gas-producer.*

The construction of this is shown in Fig. 38 and 39, the latter being a horizontal section through line *AB* of the former.

§ 197. *Wood single-bosh water-seal gas-producer.*

The construction of this is shown in Fig. 40.

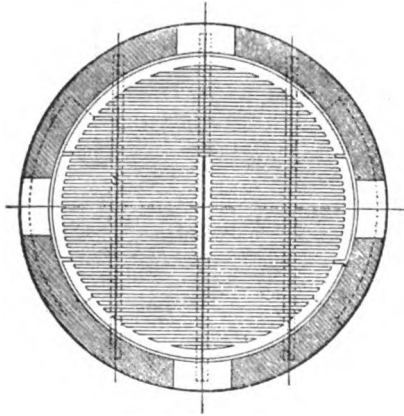

FIG. 39. — SECTION OF WOOD FLAT-GRATE GAS-PRODUCER.

§ 198. *Wellman gas-producer.*

This is shown in Fig. 41. It is a modified form of the old Siemens type, with a steam blast attachment. It is intended primarily to be used in connection with a heating furnace. *A* is the body of the producer with charging hopper *B* and exit *C*. *D* is the grate over ash pit *E*. *F* is the blast pipe.

§ 199. *The Fraser-Talbot gas-producer.*

In the design and mode of operation this producer is radically different from any other type.

In some cases rotary or revolving bottoms have been introduced with a view to facilitate the discharge of the ashes and to provide for a greater capacity for gasifying the coal; the continued demand for a mechanical producer has led to the development of this type.

The producer is shown in Fig. 42 and 43. It consists of a

cylindrical shell or casing riveted to four *I*-beam columns *C*, which rest upon foundations and support the shell and operating

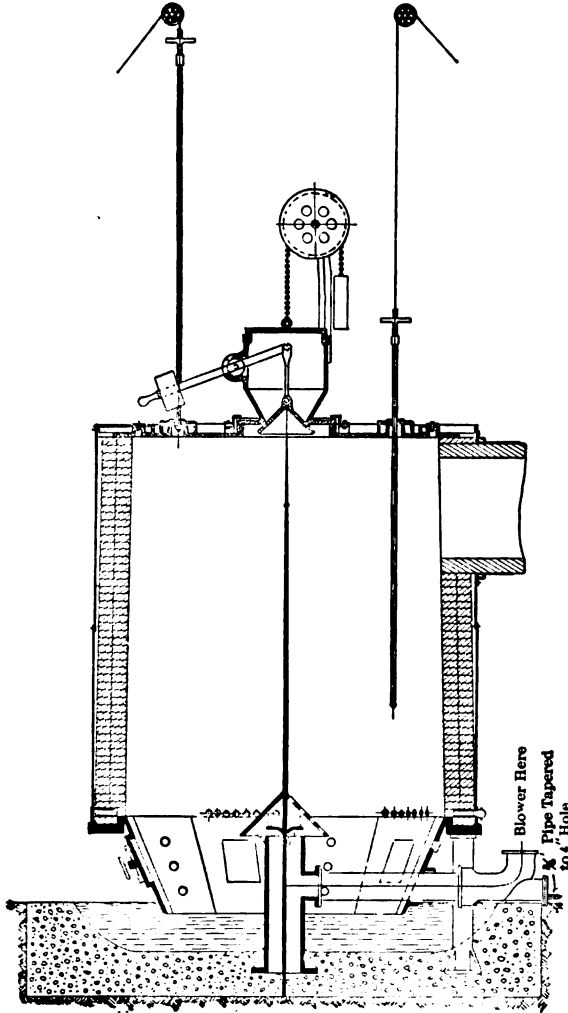

FIG. 40. — WOOD SINGLE-BOSH WATER-SEAL GAS-PRODUCER.

machinery. It is not connected in any way to the building in which it is placed. To the lower part of the shell is attached a conical cast-iron fire pot *D*, the lower edge of which is covered

by water in a concrete ash pan *E*, therefore forming a water seal. In the center of this ash pan is a hollow cylindrical column *F*, terminating at its upper end in a cone. The annular space between the edge of the cone and the cylinder and the opening in the top cone, which is protected by the circular flange, form

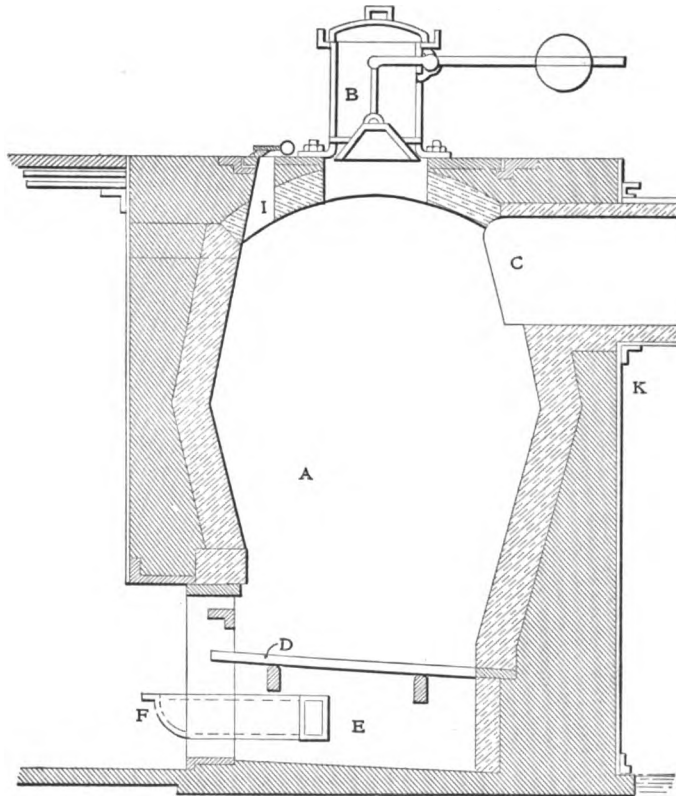

FIG. 41. — WELLMAN GAS-PRODUCER.

outlets for the blast, which is conveyed to the central column *F* by means of a circular inlet pipe *G* on one side of the producer. This inlet pipe is provided with a force blower, preferably of the injector type.

The cone forms a bearing for the vertical water-cooled shaft *H*, to which are connected two water-cooled arms *I*, one arm being inclined at the angle shown and the other arm extending

in a horizontal direction and at right angles to the shaft. The combination of the shaft and the arms forms a mechanical stirrer or agitator.

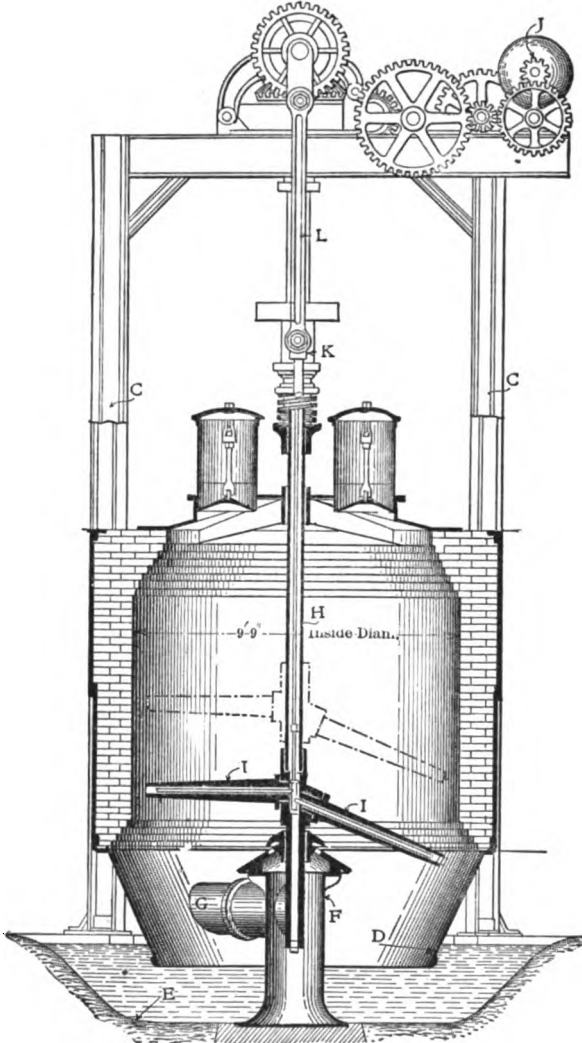

FIG. 42. — SECTION OF FRASER-TALBOT GAS-PRODUCER.

The shaft *H* has a combination of rotating and vertical motions, which are effected by means of gearing connecting the shaft to

an electric motor *J*. This motor and the gearing are carried on a steel platform riveted to the tops of the supporting columns

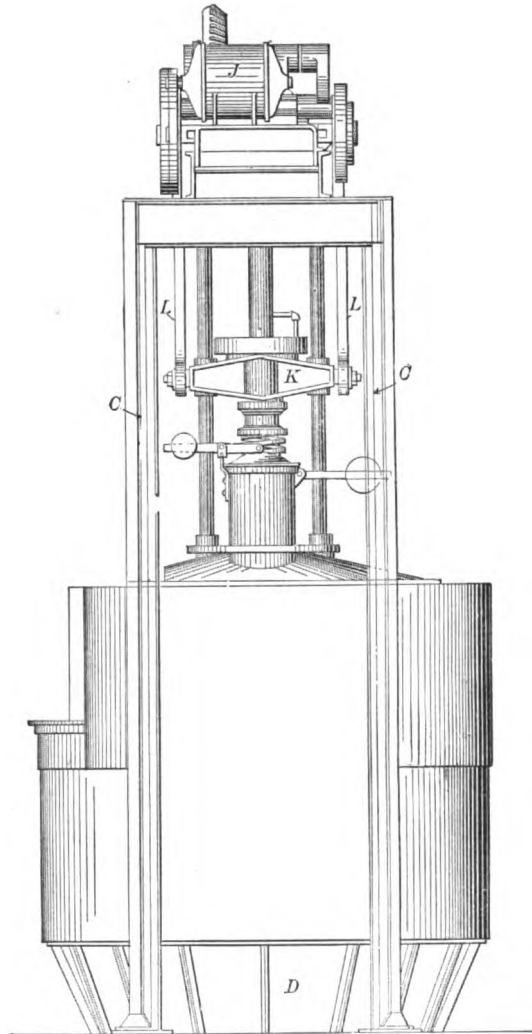

FIG. 43. — ELEVATION OF FRASER-TALBOT GAS-PRODUCER.

C, and braced to them. The gearing for giving the shaft the rotary and vertical motions is of an exceptionally heavy design,

and in general consists of a train of spur gears reducing the motion from the electric motors to a worm wheel, which is connected to the upper end of the shaft *H* by means of a feather and groove. The latter provide for the vertical motion of the shaft, which is effected by means of two cranks on a horizontal shaft directly over the vertical shaft. These cranks are connected to a cross head *K* by means of connecting rods *L*. The cross head is connected to the vertical shaft by means of two collars, between which is placed a powerful spiral spring.

The arrangement of gearing is such that the vertical shaft has a slow rotating and vertical movement, and if at any time the shaft should become jammed against an excessively large and hard clinker the vertical motion will cease automatically until the arm which is in contact with the clinker moves through a segment of a circle past the clinker, when it will be forced down into its proper position by the spring. This allows a slight elasticity in the movement of the shaft and will prevent the breakage of the arm. As a further safeguard, a slip clutch is placed on one of the gear wheels. In practice it is found that the combined rotary and vertical movements prevent the formation of any large and hard clinkers.

The producer is fed through two hoppers as shown, or by means of a Bildt or any other approved form of feed.

Among the advantages of this form of gas-producer is the doing away of the severe and continued labor of poking the fire, an operation which is extremely difficult to maintain in a steady and uniform manner. The poking being entirely mechanical, it is done in a thorough and proper manner without reference to any manual labor, and as a consequence the quality and quantity of gas should be much improved.

§ 200. *Morgan gas-producer.*

The construction of this producer equipped with the Bildt automatic feed is shown in Fig. 44, where *A* is a hopper into which the coal is primarily deposited, *B* is a register valve controlling the admission of coal to the tank *C*, directly below. *D* is a rotating distributing disk, having sloping sides of varying angles so designed as to deposit the coal evenly over the charging area. The disk is rotated by the bevel gears *E* and a special ratchet motion *F* operating through the vertical shaft *G*. *H* is

a shallow annular pan for holding water which is used to seal the poke holes and the joint formed by the lower edge of tank base.

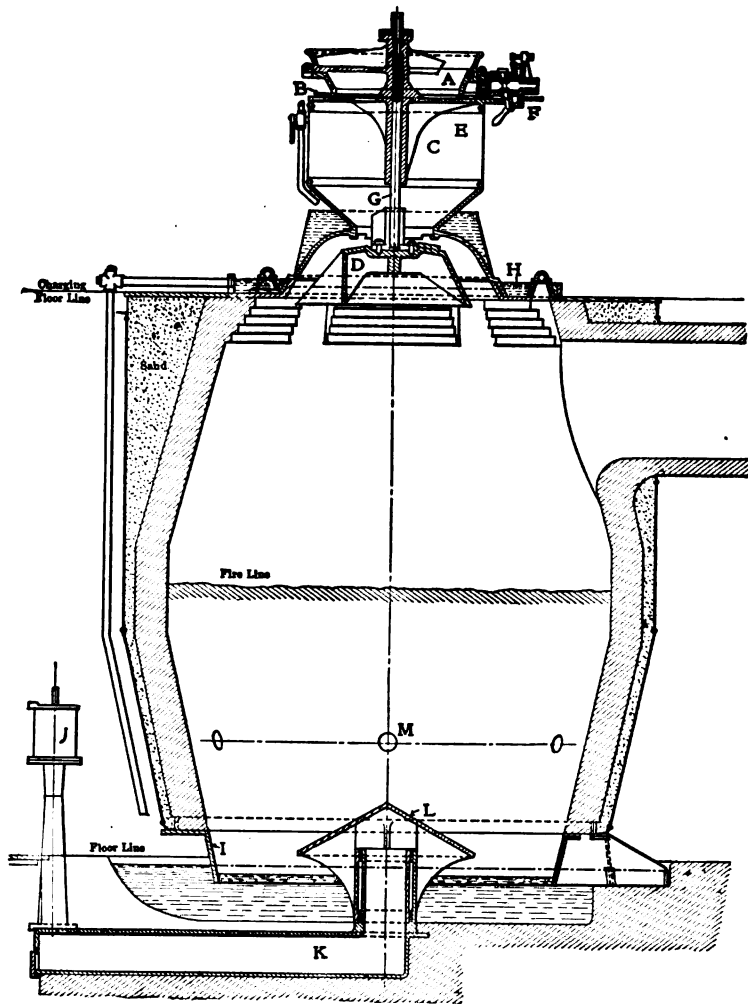

FIG. 44. — SECTION OF MORGAN GAS-PRODUCER EQUIPPED WITH BILD T AUTOMATIC FEED.

The body of the producer is cylindrical in form, the walls being heavy to prevent undue loss from radiation of heat. *I* is a sub-

stantial cast-iron mantle, upon which the producer rests. The lower edge of the mantle dips into the water below, forming an effective seal. There are but four narrow points of support for the mantle, so that practically the whole circumference is unobstructed for the removal of ash.

J is a steam blower, which is built with special view to regulating the proportion of air and steam going into the producer at any pressure. *K* is a cast-iron box forming a conduit through which the blast is enabled to reach the lowest possible point of the producer. *L* is a cap or hood which serves the double purpose of keeping ashes out of the blast box and of distributing the blast to a proper point under the fuel bed. The hood is circular in form, proportioned to the diameter of the producer. All of the blast is delivered from under the center of area of charging surface.

Referring again to the feeding mechanism, the coal is supplied to the hopper by any convenient means and dropped into the coal tank *C* below as needed. The coal tank may be made large enough to receive any desired quantity of coal, but two or three hours' supply is usually deemed sufficient. The slow rotating motion of the distributor causes the coal to work out of the tank *C* and fall over the edge of the distributor. The speed of the distributor is from a fraction of 1 to 10 or 15 revolutions per hour. Speed adjustments are made by an adjustable guard moving under the ratchet pawl.

Fig. 45 shows a Morgan producer fitted with the George automatic feed, and Fig. 46 shows the operating or charging floor of the Lackawanna Steel Co. at Buffalo, N. Y., where a large number of these producers have been installed.

§ 201. *Loomis gas-producer.*

This is shown in Fig. 47. The producer is of the down-draft type and presents several unique features of design. *A* and *B* are two cylindrical producers connected at the top by the fire-brick-lined pipe *F*. *E* and *D* are valves connecting the producers with the economizer *C*, which is simply a vertical tubular boiler. *G* is a pipe connecting the economizer with the water-spray scrubber *H*. *I* is a pipe connecting *H* with the exhauster *J*, which is driven by engine *K*. *L* is a seal. *M* is a pipe leading to producer-gas holder. *O* is a pipe connecting the producer with

the chimney. *P* is a cleaning door. *R* is the ash-pit door. *Q* is the charging door through which the coal is fed. *S* is a steam pipe leading from *C* to the ash pit of the producers. *N* leads to the water-gas holder.

In starting the producers a layer of coke or wood and coal about five feet in depth is put in and ignited at the top, the ex-

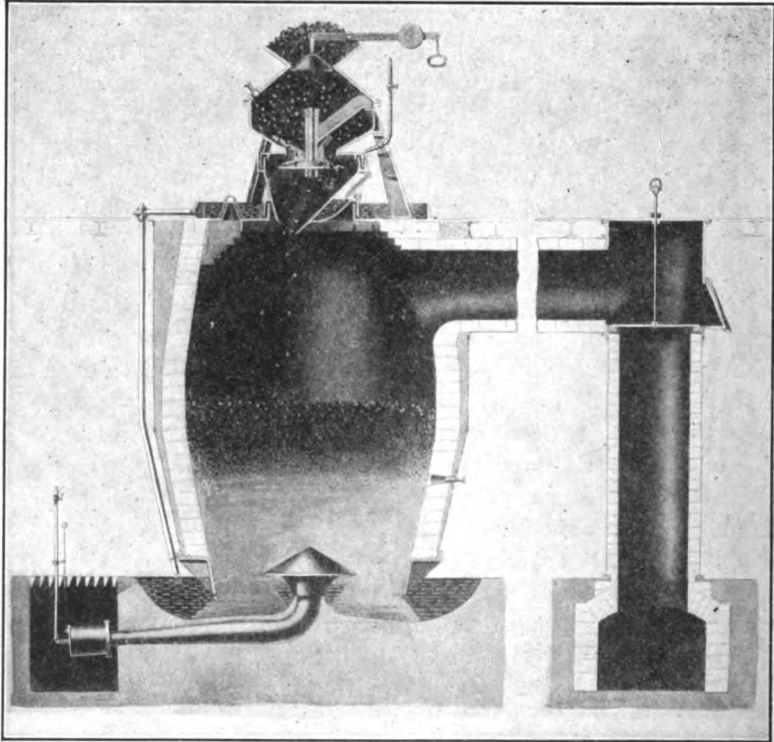

FIG. 45. — SECTION OF MORGAN GAS-PRODUCER EQUIPPED WITH THE GEORGE AUTOMATIC FEED.

hauster *J* creating a downward draft. When this body of fuel is ignited, coal is frequently charged, raising the fuel bed to about eight feet above the grates, and there maintained. Bituminous coal is generally used; this is delivered on the operating floor and fed through the doors *Q*, as needed.

The air is also admitted through *Q* and by means of the ex-hauster *J* is drawn down through the fresh charge of coal and

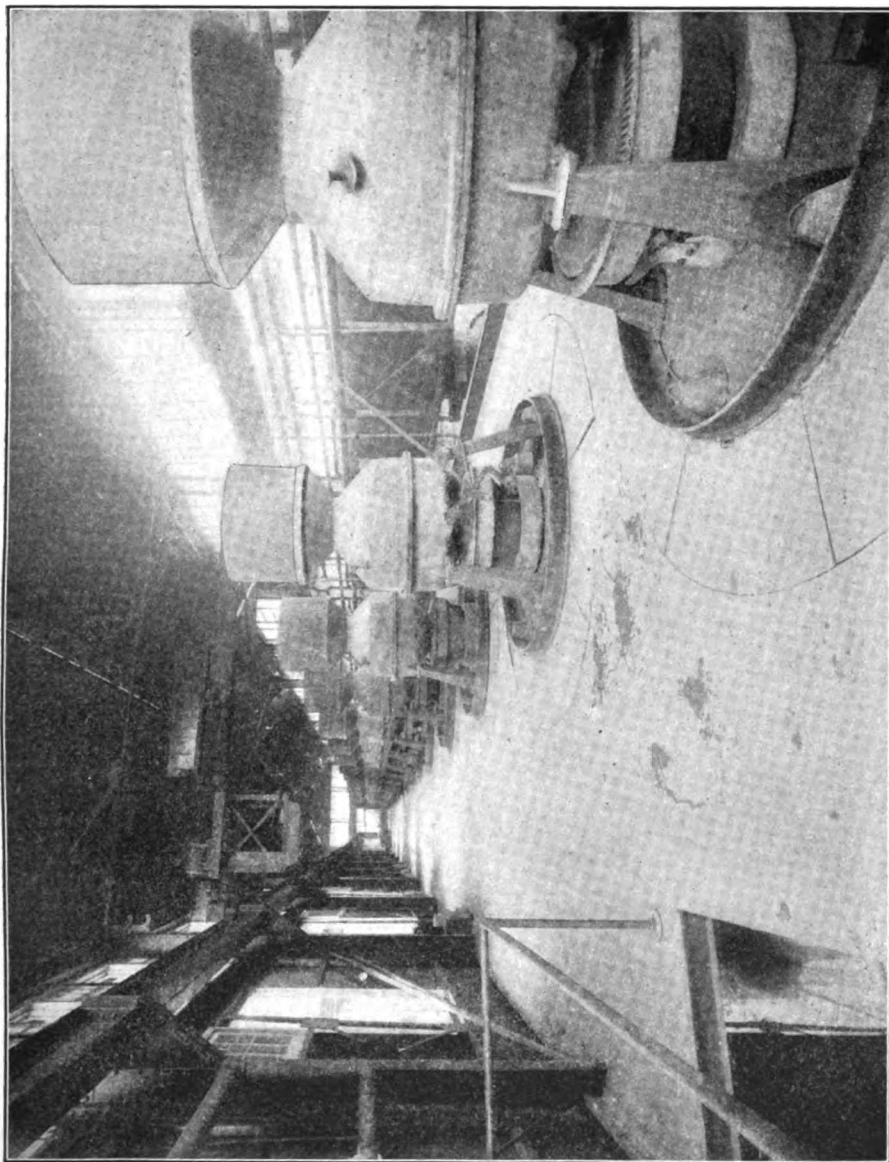

FIG. 46. — CHARGING FLOOR OF MORGAN GAS-PRODUCER PLANT.

then through the hot fuel bed underneath. The valves *E* and *D* being open, the producer-gas is drawn down through the grates and ash pits of producers *A* and *B*, then up through the economizer *C*, down *G* and up through *H*, down through *I* and *J* into *L*. It

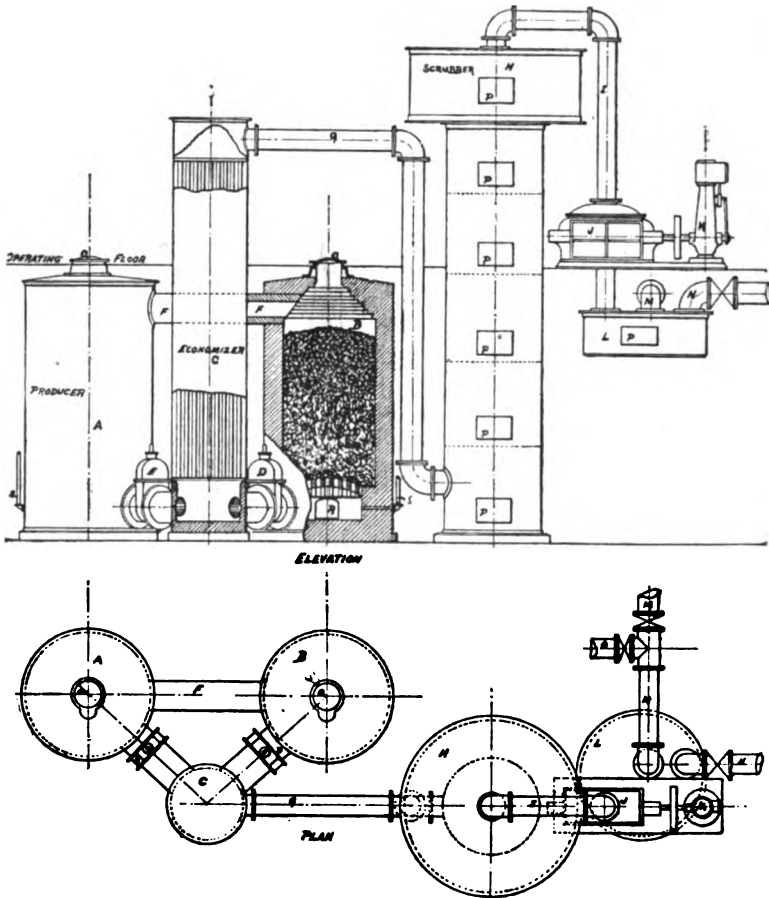

FIG. 47. — LOOMIS GAS-PRODUCER.

requires about ten minutes to start the producers; during this time the gas will be too lean for use, and hence it is allowed to go to the chimney by means of a pipe *O*. As soon as the producer is working properly, the valve in *O* is closed and the valve in *M* opened, thus allowing the gas to go to the holder.

In making water gas the operation is as follows: When the exhauster has brought the fuel up into incandescence, the charging doors *Q* are closed, valve *D* lowered and the valve in *N* opened, the valves in *O* and *M* being closed. Steam is then turned on in *B* by means of *S*, and, in passing through the incandescent coal, is decomposed, forming water gas. Water gas is made about five minutes; when the temperature of the fuel beds has been considerably reduced, the steam is shut off and producer-gas is made again. This process of making water and producer-gas is alternated at intervals of five minutes or more, according to the quality of gas desired. In making the next run of water gas the course of the steam is reversed; *i.e.*, valve *D* is opened and valve *N* closed.

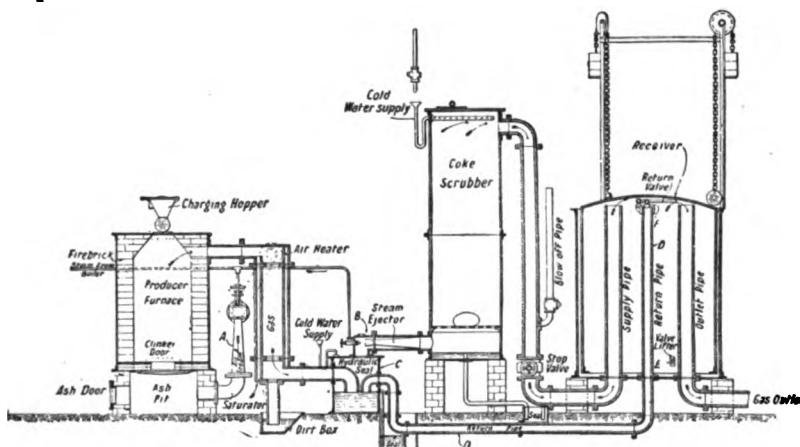

FIG. 48. — SECTION OF WILE AUTOMATIC GAS-PRODUCER.

This type of producer has been used quite extensively for making gas for power purposes, and it has given very good results. It is also guaranteed to make a gas clean enough for engine use from bituminous coal, and an economy of $1\frac{1}{4}$ lb. of coal per brake-horse-power hour is the guarantee of the builders.

§ 202. *Wile automatic gas-producer.*

This is shown in section in Fig. 48, and Fig. 49 shows the general arrangement. It is a combination of a pressure and suction producer. The producer is under suction while the gas is delivered under pressure by means of a steam ejector, which sucks the gas from the producer and forces it through the

usual cooling and scrubbing apparatus into a regulating gas holder. Referring to Fig. 48, *B* is the ejector which sucks the gas from the producer and forces it through the scrubber and into the regulating holder or receiver. The latter has three pipes: a gas

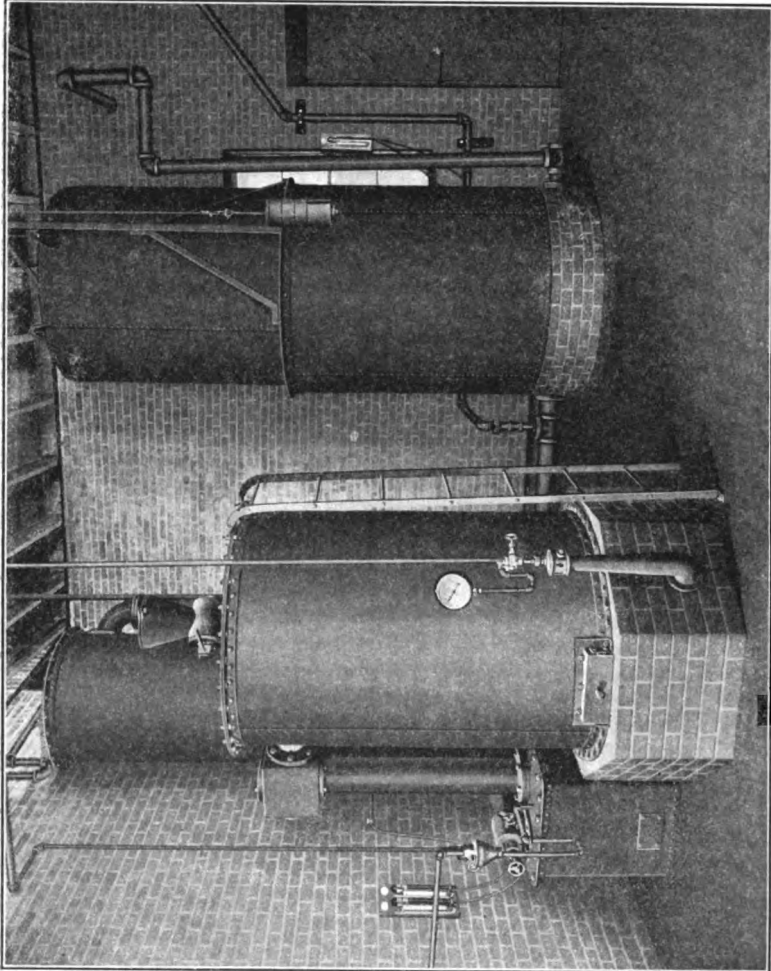

FIG. 49. — WILE AUTOMATIC GAS-PRODUCER.

outlet to engine, a gas inlet, and a return pipe *D* which leads back to the seal box *C* and is provided at its top end with the valve *F*, carried by a lever arm which is arranged in the path of a projecting valve lifter *E* fixed to the gas bell.

When the bell rises to its top position, the valve *F* is opened, and the ejector at *B*, instead of sucking gas from the producer, sucks it from the receiver and keeps it circulating through *D* until the bell drops enough to close *F*. As the producer is not under suction or in operation while the gas is in circulation,

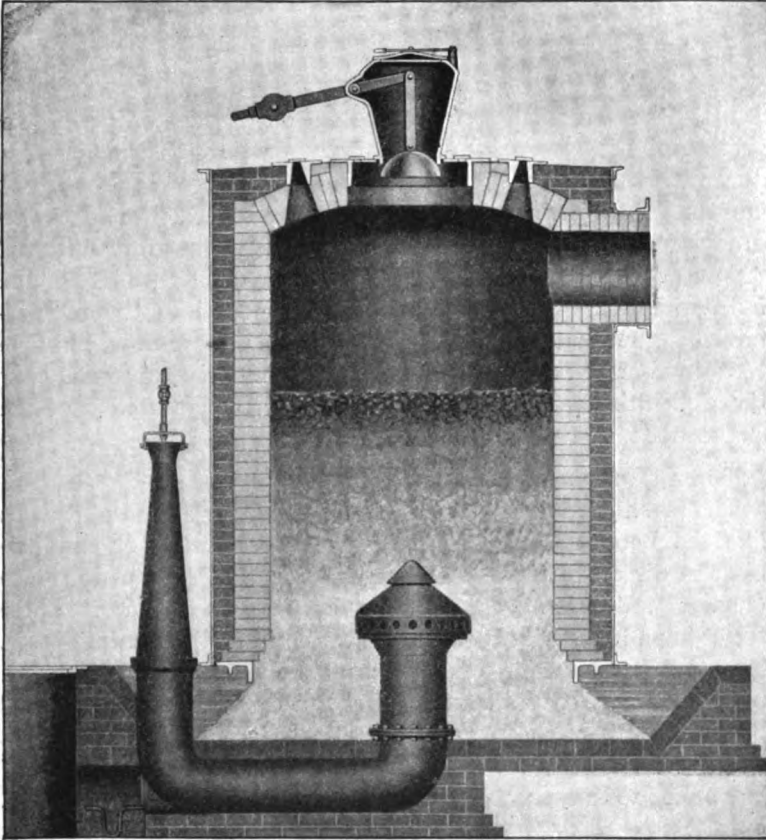

FIG. 50. — WILE WATER-SEAL GAS-PRODUCER.

the movement of the bell makes the operation of the producer automatic.

§ 203. *Wile water-seal gas-producer.*

The construction of this is shown in Fig. 50. The larger part of the blast enters the fuel bed in a lateral direction from the central cone.

CHAPTER XVI.

AMERICAN SUCTION GAS-PRODUCERS.

§ 204. *History of development.*

In 1884 C. Wiegand secured a patent on the idea of having the suction of the gas-engine piston draw air through the gas-producer and thus generate gas which in turn was used in the engine. On the investigation of several interested firms the idea was dropped and the patents allowed to lapse. However, Wiegand was very close to the successful solution of the problem, and failed only because he did not understand all of the requirements. The first practical suction gas-producer was built in 1895 by Benier in France; this was not entirely successful, but the difficulties were primarily due to the inadaptability of the engine that was used with it.

§ 205. *Definition of suction gas-producer.*

The fact that a producer may be operated by an induced draft like the Loomis (Fig. 47), made by an exhauster, or that the blast is directed downward as in the inverted combustion type (Fig. 47), does not constitute a *suction gas-producer*. These terms have frequently been used incorrectly and indiscriminately. The term suction gas-producer must be applied only to those producers that have the air and steam drawn through the fuel bed by means of the exhausting action of the gas-engine *piston* on its charging stroke. Neither should the term "suction gas" be applied to the gas made in the "suction" type of gas-producer. (See § 98.)

§ 206. *Classification.*

The suction gas-producers now on the market may be divided into three general classes, with reference to the position of the steam-generating apparatus: First, where the vaporizer is an integral part of the producer. Second, where the vaporizer is entirely separate from the producer. Third, where the vaporizer is not only separate but is heated by the engine exhaust. The

nomenclature of the steam-generating apparatus has not been uniform on account of the individual preferences of the various designers. The terms "boiler," "saturator," "vapor chamber," "steamer," "evaporator" and "vaporizer" have been used indiscriminately; the last term is the best.

§ 207. *Operation of suction gas-producers.*

The reactions by which the gas is evolved are not novel and are the same as those taking place in a pressure gas-producer as discussed in detail in Chapter 7. For data on the handling of a suction gas-producer plant see Chapter 25.

§ 208. *Steam supply and regulation.*

The accurate regulation of the amount of steam fed into the producer is of *great* importance, especially if the load on the engine is variable. The quantity of steam going into the producer must always be proportional to the amount of gas that the engine is using, regardless whether that amount is fixed and uniform or variable. If the normal amount of steam required at full load is allowed to go into the producer when the engine is running light, not only will the composition of the gas be changed very materially and cause trouble in exploding, but the fire in the producer will be extinguished in a very short time. However, when the engine is working at full load, a maximum amount of steam is necessary to avoid excessive temperature of the fire and the formation of clinkers. In order that a suction gas-producer plant shall work satisfactorily through a wide range of load on the engine, it will be necessary to have a sympathetic and accurate adjustment of the amount of steam used to the amount of gas used by the engine. There are several devices for accomplishing this result; Smith's is shown in Fig. 67 and 68, and described in § 214. The author's is shown in Fig. 71 and described in § 216. Dowson and Wintherthur of England, and Pierson of France, also have devices for securing this regulation.

§ 209. *American types of suction gas-producers.*

The suction gas-producer is comparatively new in this country, yet in the short time that it has been on the market a large number have been placed in successful operation. The larger part of producers built and installed in this country have not been original American designs, but are either built under European patents or else have been modeled after European types.

All the types that are now on the market (June, 1905) are herein illustrated and some are described in detail. Fig. 51

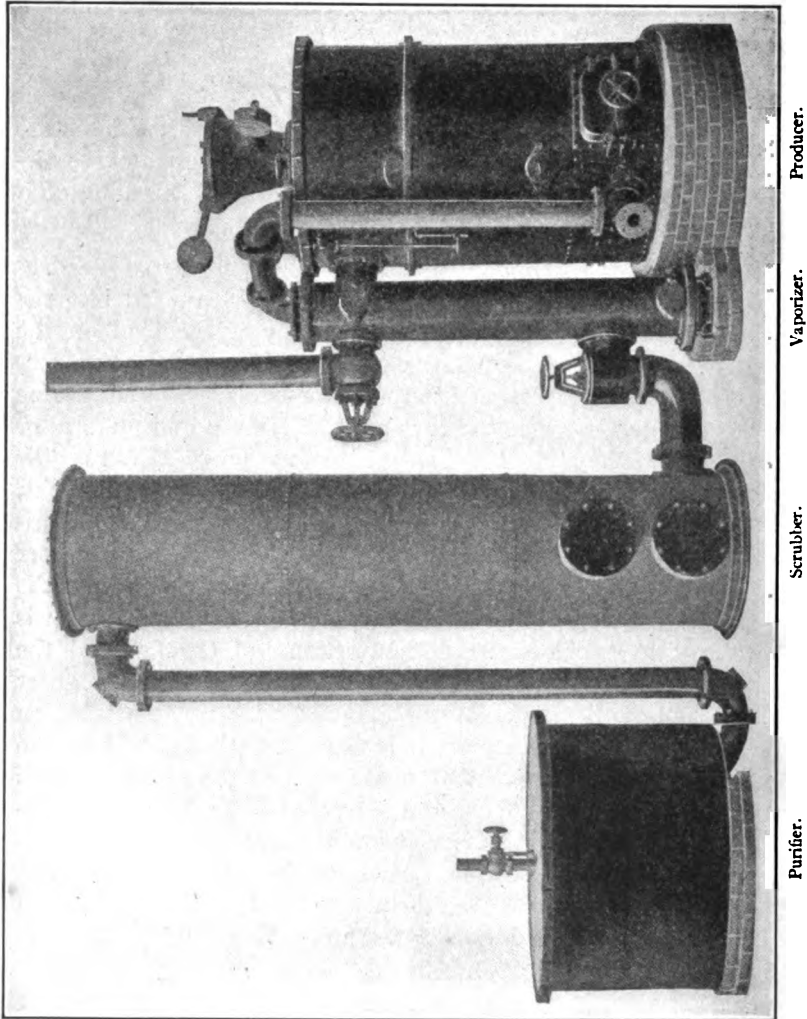

shows the Wood; Fig. 52, the Otto; Fig. 53, the Weber; Fig. 54, the Backus; Fig. 55, the Wile suction gas-producer.

§ 210. *Nagel suction gas-producer.*

This is shown in Fig. 56. *A* is the producer body with grate

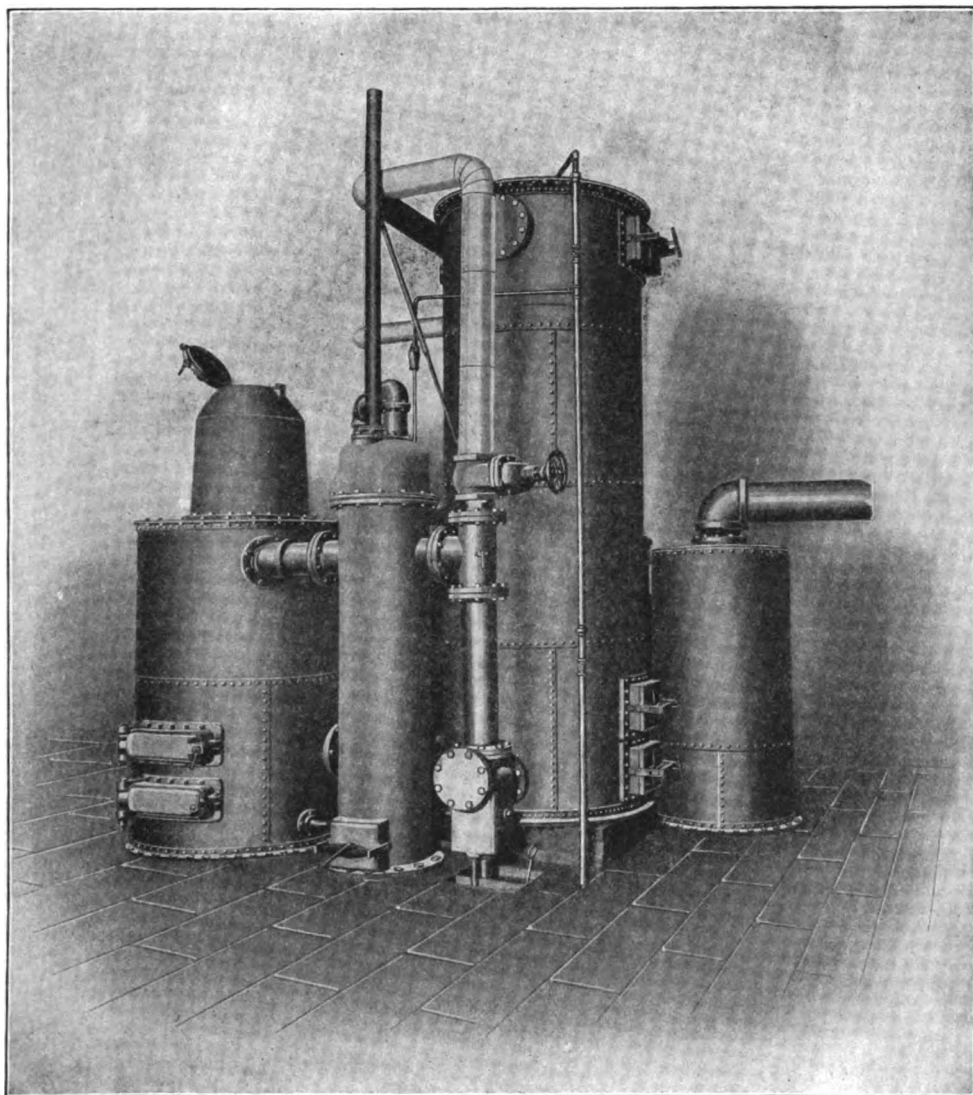

Producer.

Vaporizer.

Scrubber.

Equalizer.

FIG. 52. — OTTO SUCTION GAS-PRODUCER.

B and ash pit *C*. *D* is the fuel magazine which is placed over and above the vaporizer *E*. The air enters the vaporizer at *F*, then goes to the ash pit by means of pipe *G*. The gases escape at *H*, then go down pipe *I* and around the deflector *J*, and into the coke scrubber *K*; then down through pipe *L* to equalizer *M*,

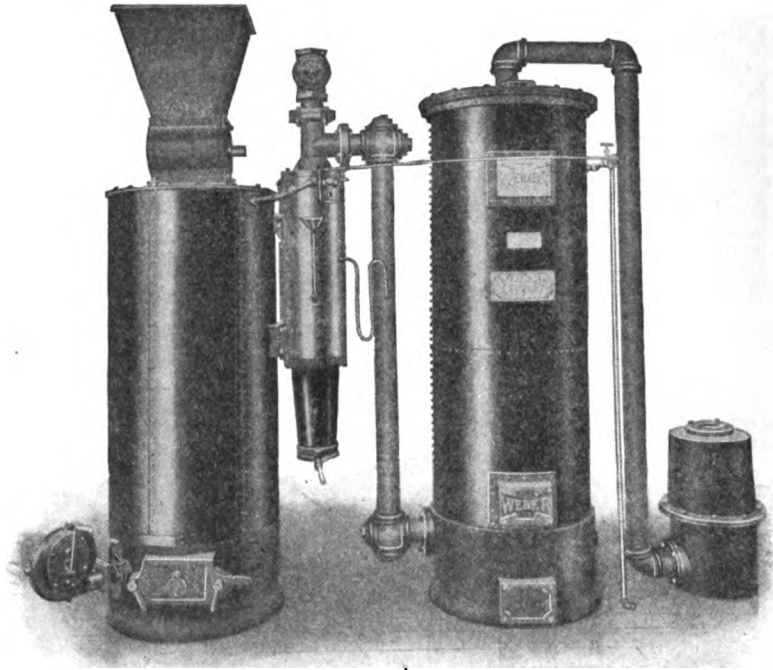

Blower. Producer Vaporizer. Scrubber. Receiver.
 FIG. 53. — WEBER SUCTION GAS-PRODUCER.

and then to the engine through pipe *N*. The object of *J* is to deflect impurities in the gas downward into the trap below. *O* is the hand blower for starting the fire in the producer.

§ 211. *Pintsch suction gas-producer.*

This is shown in Fig. 57 and 58. Referring to the former, *A* is the hand blower. *B* is an ash tube to water-sealed ash trough *C*. *D* is the body of producer and has a charging hopper *E*. *F* is the vaporizer with vent pipe *G* and trap *H*. *I* is the usual form of coke scrubber. *J* is a two-tray purifier. *K* is an automatic regulator

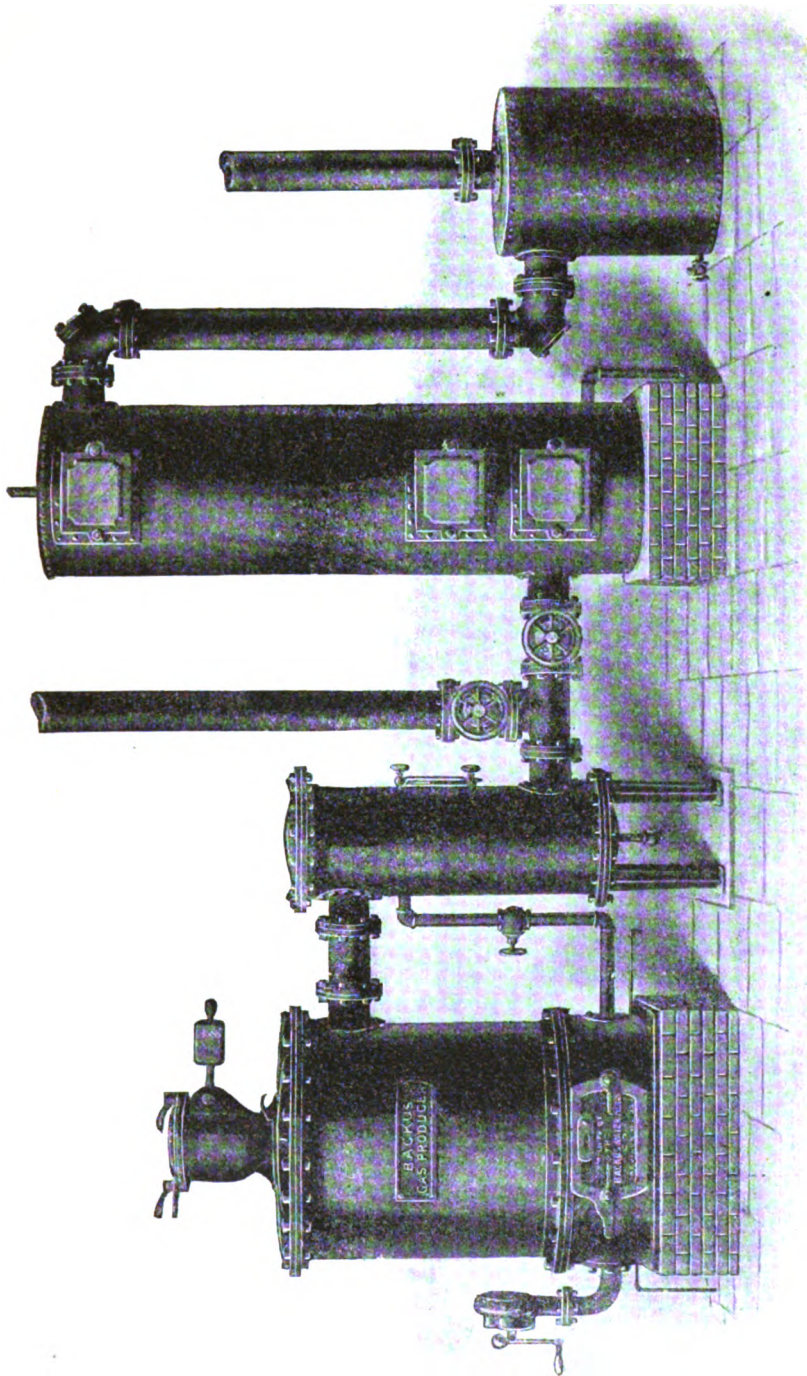

Equalizer.

Scrubber.
FIG. 54. — BACKUS SUCTION GAS-PRODUCER.

Producer.

which operates as follows: The spring *M* acts upward and tends to keep the dome *L* of the reservoir full of gas. When the engine draws gas from the regulator, the dome moves down on account of the exterior atmospheric pressure, but is drawn back again by the spring; in so doing, it sucks gas from the producer. The range of travel of the dome *L* may be regulated by varying the tension on spring *M*. Thus, instead of the suction action taking place only during the charging stroke of the engine, the actual gas-making is carried on for a longer period.

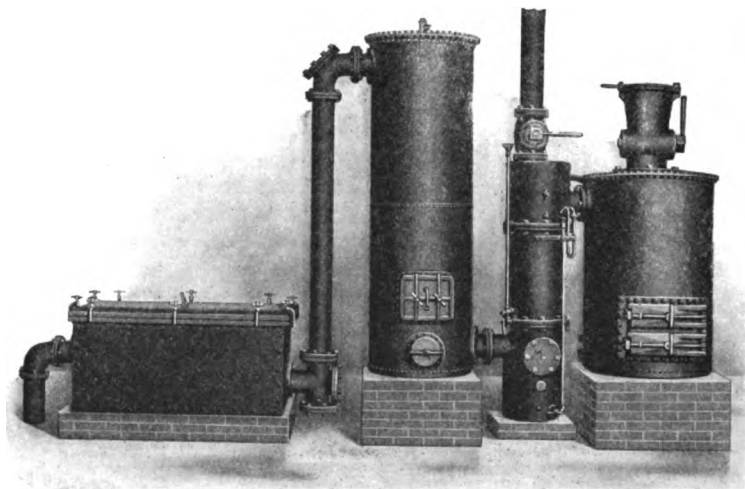

FIG. 55. — WILE SUCTION GAS-PRODUCER.

§ 212. *American Crossley suction gas-producer.*

The construction and arrangement of this producer is shown in Fig. 59, 60, and 61. The producer consists of a cylindrical plate steel shell, lined with firebrick and provided at its bottom with a shaking grate *A*, ash pit *F*, and door *G*. The grate is operated from the outside of the producer by means of the lever as shown. *B* is a sealed hopper, so arranged that a charge of fuel may be placed in the hopper top *C*, and then allowed to fall into the feed tube *D* without opening the producer to the outside air. The feed tube conducts the fuel down to where combustion takes place. *E* is a waste heat vaporizer and has a water-jacket extension around the feed tube *D*. The object of this vaporizer

is to furnish the steam required in the producer; the water in *E* is maintained at a fixed level by means of the tank *S* and float shown on the right side of Fig. 60.

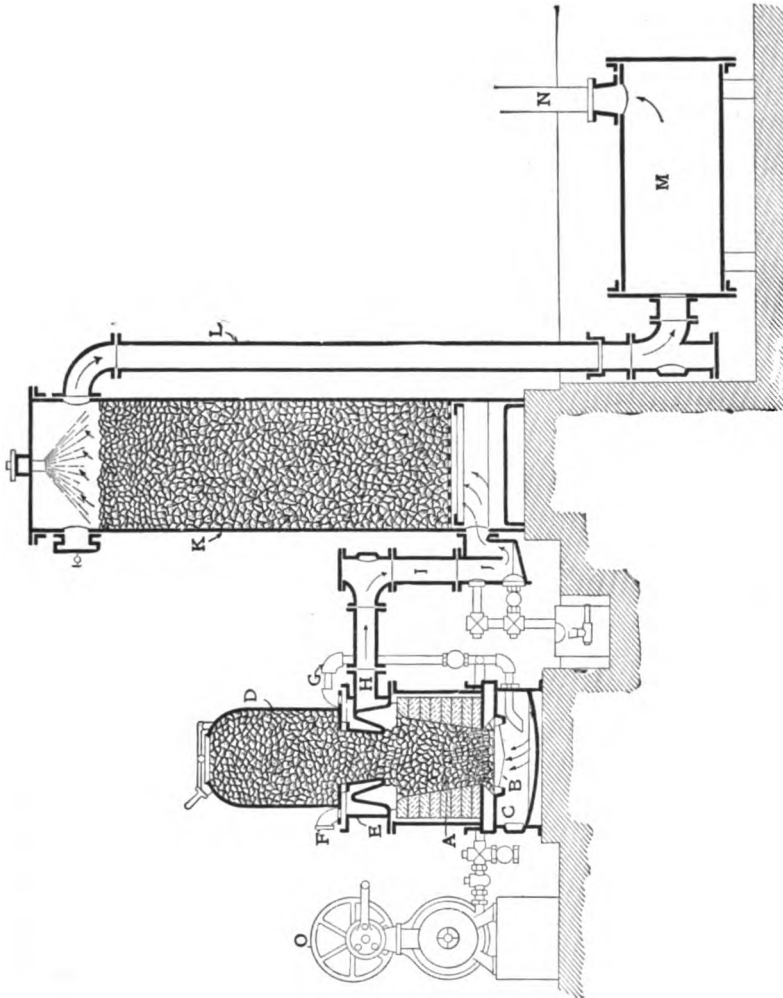

FIG. 56. — NAGEL SUCTION GAS-PRODUCER.

The gas-cleaning apparatus consists of a wet scrubber, hydraulic box, and a combination wet and dry scrubber. The first consists of a plate steel cylinder, filled with coke and mounted on the hydraulic box. Water is introduced at the top of both

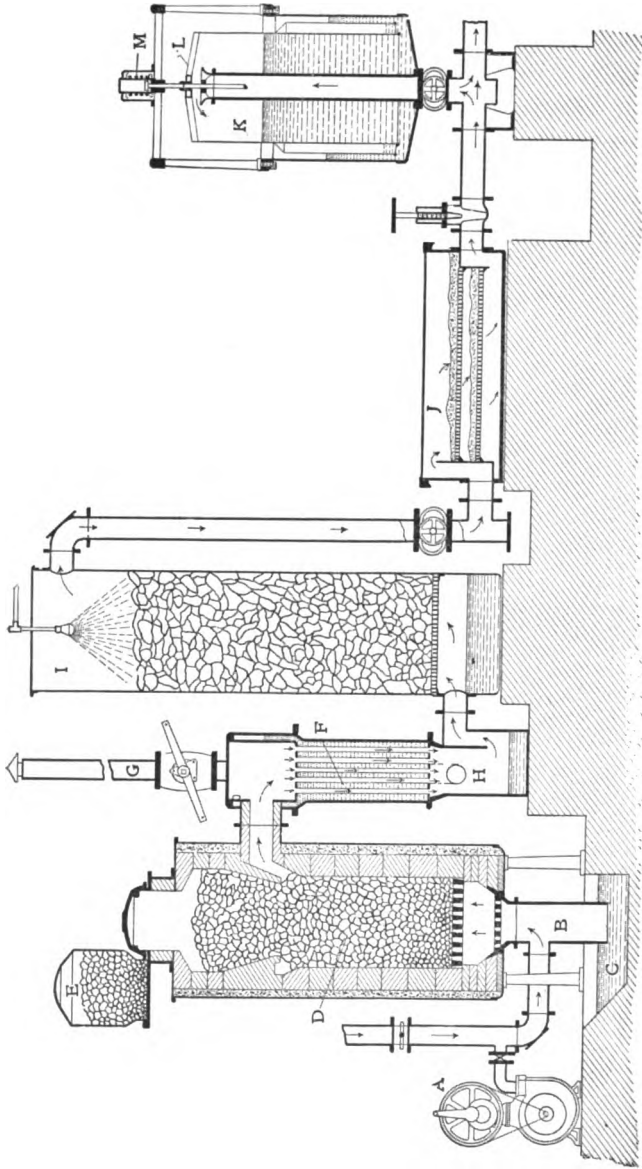

FIG. 57. — SECTION OF PINTSCH SUCTION GAS-PRODUCER.

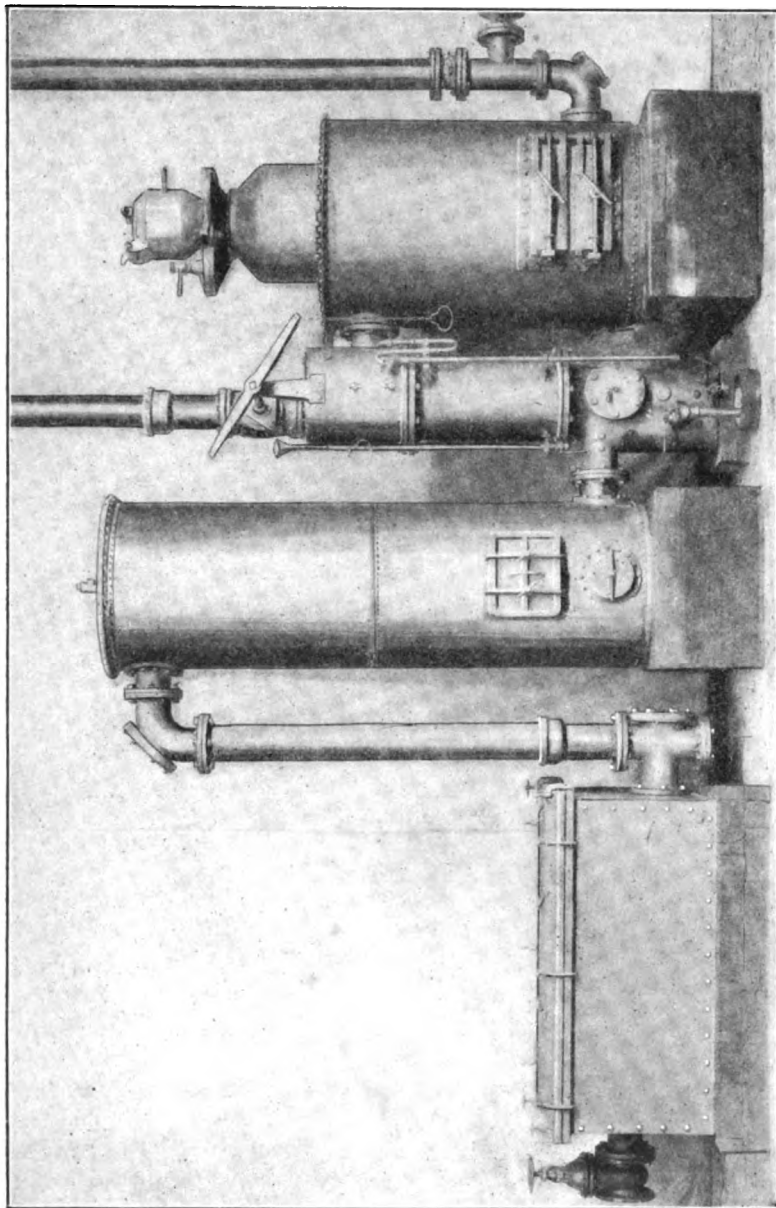

FIG. 58. — PINTSCH SUCTION GAS-PRODUCER.

wet scrubbers in the form of a spray and trickles down into the hydraulic box underneath. The gas from the producer enters the first scrubber near the top and passes downward into the

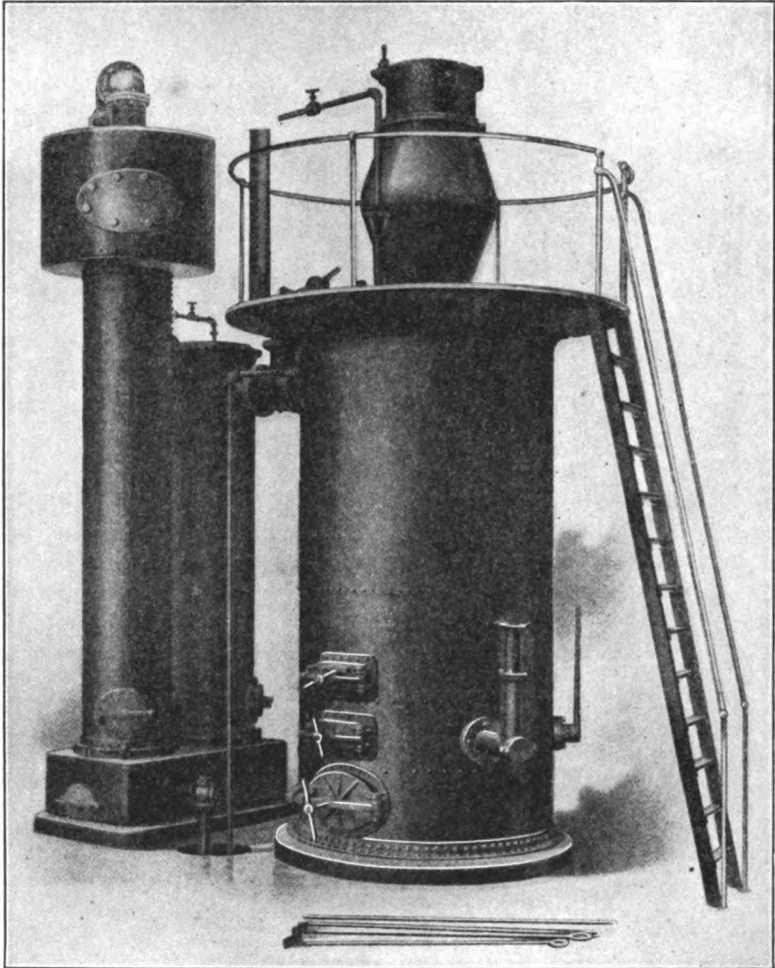

FIG. 59. — CROSSLEY SUCTION GAS-PRODUCER.

hydraulic box which contains a water seal with the necessary overflow; from here the gas goes into the combination scrubber, the wet section being constructed the same as the first wet scrubber, having but an extension mounted on its top, in which are

placed trays containing shavings, excelsior, or similar material through which the gas filters and in which it gives up its moisture. While the fan *R* is being used to start the fire in the producer, the purge pipe is kept open to the atmosphere.

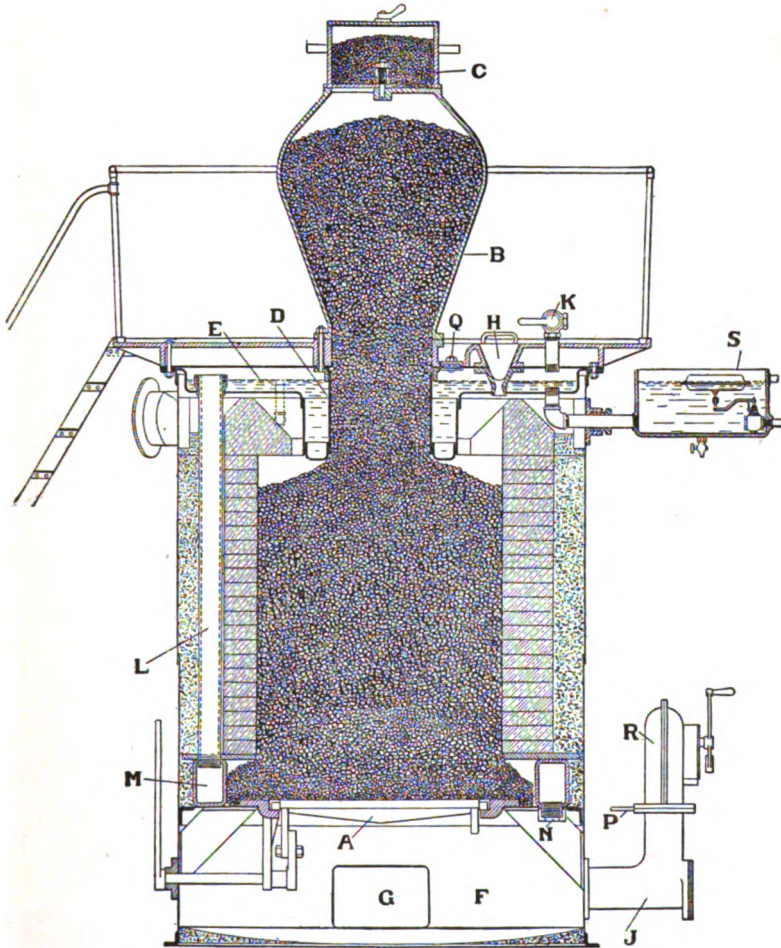

FIG. 60. — CROSS-SECTION OF CROSSLEY SUCTION GAS-PRODUCER.

H is a poke hole for barring the fire in the producer, and *Q* is a hand hole for removing sediment from the water jacket. As shown in Fig. 59, cleaning doors are placed above the grate level to facilitate the cleaning of the interior of the producer.

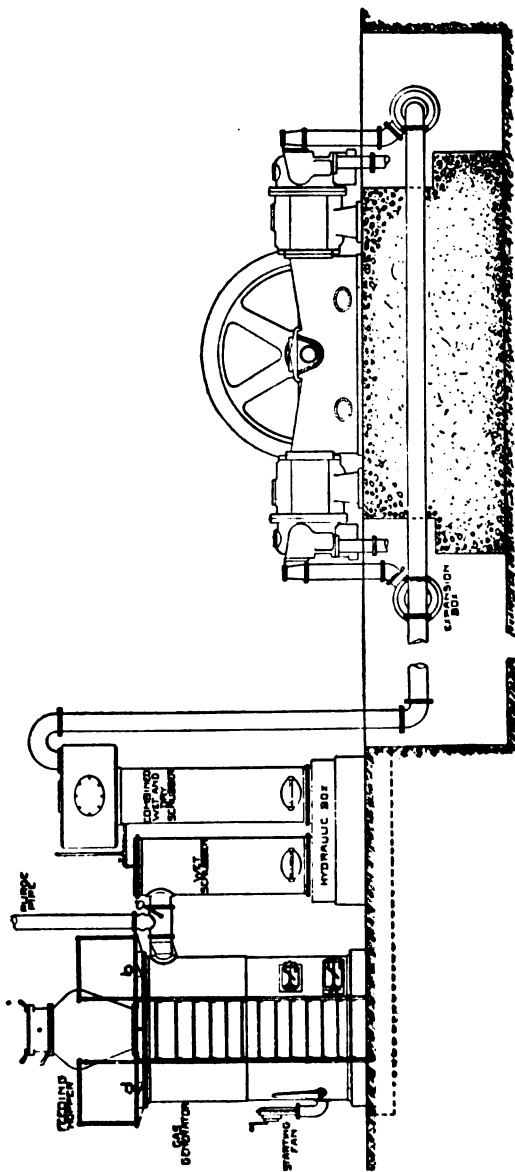

FIG. 61. — ARRANGEMENT OF CROSSLEY SUCTION GAS-PRODUCER PLANT.

The air is supplied to the ash pit from two sources, known as the primary and secondary supply. The primary supply enters directly from the outside air through the pipe *J* and is sucked up through the fuel bed. The secondary supply enters the top of the producer through valves *K*, passes over the surface of the water in the vaporizer and descends through side pipes *L*, heavily

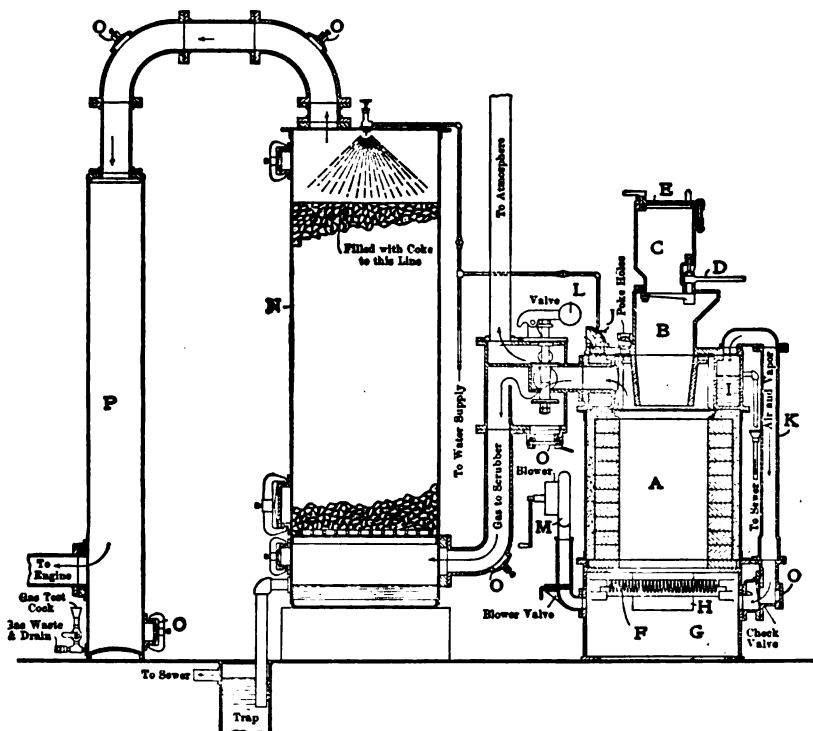

FIG. 62. — SECTION OF FAIRBANKS-MORSE SUCTION GAS-PRODUCER.

charged with steam, to the air boxes *M*, through which it circulates, and from which it is delivered to the ash pit through the nipples *N*.

§ 213. *Fairbanks-Morse suction gas-producer.*

This producer is shown in Fig. 62 and 63. Referring to the former, *A* is the producer composed of a cylindrical plate steel shell and firebrick lining. *B* is the fuel magazine charged by means of valve *D* from the fuel hopper *C*, which is hermetically

sealed by the lid *E*, and thus it is possible to charge *B* from *C* without permitting any outside air to enter the producer. The fire is supported on the grates *F*, which discharge the ashes into the ash pit *G*, which is accessible by means of the door *H*.

I is the vaporizer for furnishing the fuel bed with steam; on the larger sizes of this producer, the vaporizer is removed from

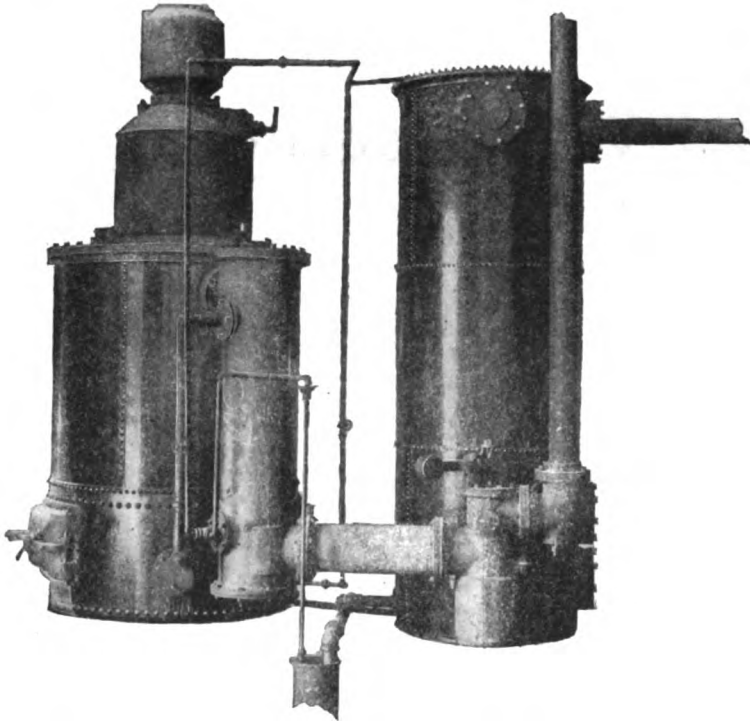

FIG. 63. — ASSEMBLY OF FAIRBANKS-MORSE SUCTION GAS-PRODUCER.

the top and placed on the side, as shown in Fig. 63. The air is drawn in through opening *J* and then, passing over the surface of the water in *I*, the steam becomes mixed with the air and the two then go down through pipe *K* and up into the fuel bed in *A*. By means of valve *L* the gas may be discharged into the atmosphere while the producer is being blown up with the hand blower *M*, preparatory to starting.

N is the usual form of coke scrubber with water spray at top. *O* are hand holes for cleaning purposes. The object of the gas

tank *P* is to form a storage receiver near the engine so that fluctuations in the requirements of the engine will be equalized.

§ 214. *Smith suction gas-producer.*

This producer is a radical departure from the usual practice and is shown in Fig. 64, 65, 66, 67, and 68. Referring to Fig. 65, the grate proper is a flat circular grid *A*, supported on the top of the frustum of a cone *B*, which rests on an annular ring *C* that is supported by chains *D*. By means of the lateral flexibility of the chains the grate may be swung in any direction. *E E* are cast-iron bosh plates for giving lateral support to the ash bed. A

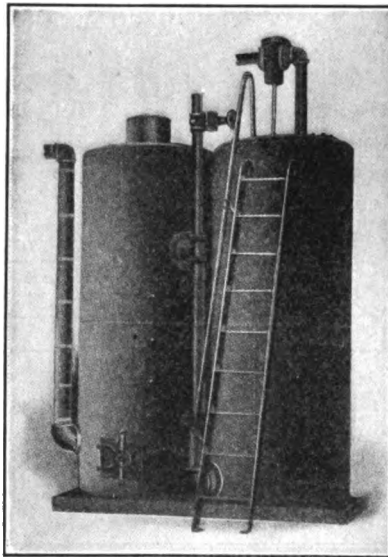

FIG. 64.—SMITH SUCTION GAS-PRODUCER.

space of four or five inches is allowed between the lower ends of *E* and the top of the grate, thus giving ample space for the removal of clinkers.

Referring to Fig. 66, *A* is the wall of the annular charging hopper and *B* the water-seal trough. *D* is the hopper valve which is secured by means of pin *L* to lever *E*; this is secured to shaft *F* which is turned by handle *G*. *H* is a spring used to keep *D* up against *A*. *K* is a shield surrounding *H*, *F*, and hub *M*. *T* is the hopper cover; since the producer is under a partial vacuum, the water seal between *T* and *A* rises to level *S*.

Referring to Fig. 67 and 68, *A* is the exhaust inlet from the engine to the superheating chamber *B*, which contains the pipes *C*, which are heated from the engine exhaust and through which the air and water are passed. *D* is a shaft on which the balanced weighing vessel *E* is supported; the latter has a rod *F* with circular vane *G* which is arranged to move in the curved inlet pipe *H*. *I* is an orifice in *E*, the amount of water passing through

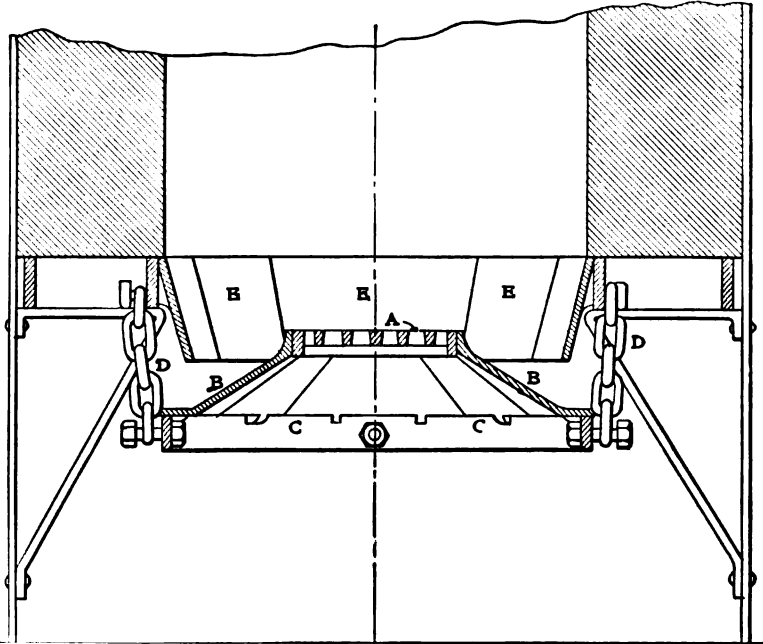

FIG. 65. — DETAIL OF SWINGING GRATE OF SMITH SUCTION GAS-PRODUCER.

I being adjusted by the screw *J*. *K* is the water-inlet pipe controlled by the valve *L*. If more water comes into *E* than passes out of *I*, the surplus is drained to *M* by an opening in *E* not shown in the figure and then out through the overflow *N*.

The operation is as follows: When air is drawn into the producer, the vane *G* is moved to the position shown by the dotted lines, thus turning *E* and allowing a certain amount of water to flow out of *I*, the quantity of water being proportional to the amount of the movement of *G* and *E*. When the suction stroke of the engine is finished, the counterweight *O* swings *E* back to

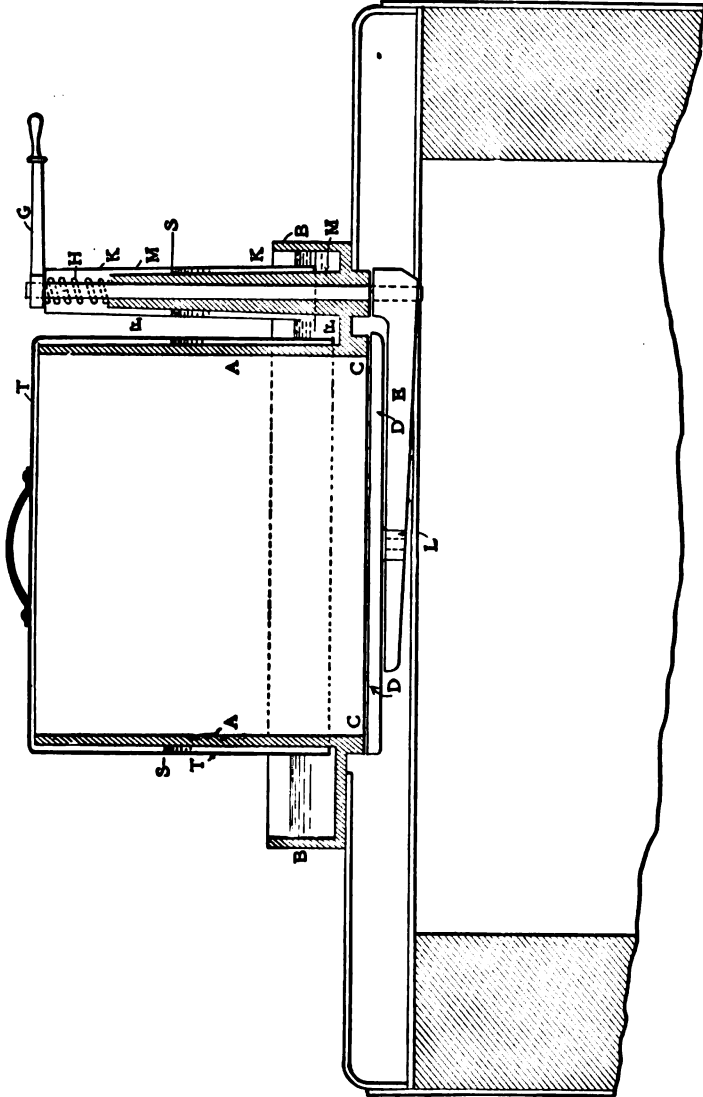

FIG. 66. — DETAIL OF WATER-SEAL CHARGING HOPPER OF SMITH SUCTION GAS-PRODUCER.

its normal position. As the water and air pass into *C*, the former is converted into superheated steam and the latter is pre-heated to about 300 degrees F.

Since the heat of the outgoing gases from the producer is not required to raise the steam necessary for the gas-making process, the gas outlet may be placed higher above the grate, thereby cooling the outgoing gases by contact with the cold fuel above the fire.

In the scrubber which is shown on the right side of Fig. 64,

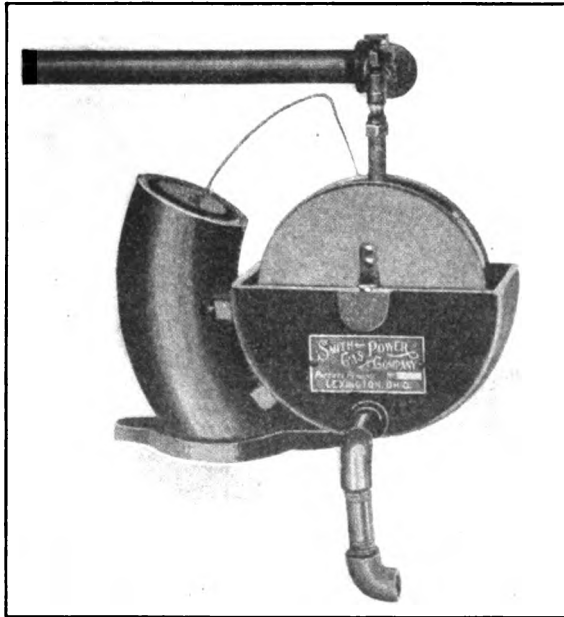

FIG. 67. — WATER REGULATOR FOR SMITH SUCTION GAS-PRODUCER.

the cleaning and cooling of the gas is accomplished by passing the gas through a series of wooden slats that are continually sprayed with water. When the gas leaves the scrubber, it is passed through a separator (shown over and above the scrubber) which operates on the same principle as a steam separator.

§ 215. *Baltimore suction gas-producer.*

This is shown in Fig. 69. *A* is the body of the producer, the fuel resting on grates *B*. *C* is the charging hopper. *D* is the

vaporizer, containing the gas outlets *E*. *F* is the collecting chamber from which the gas goes to pipe *H* or vent pipe *I*. *J* is the air heater that is connected with ash pit *L* by pipe *K*. *M*

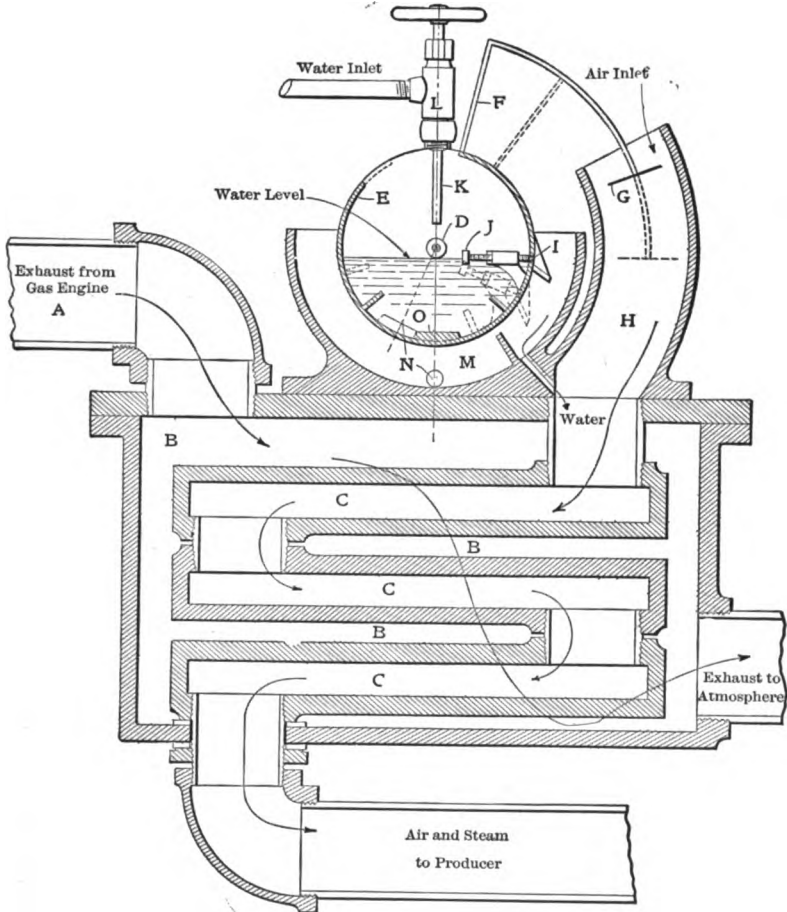

FIG. 68. — DETAIL WATER REGULATOR AND SUPERHEATER OF SMITH SUCTION GAS-PRODUCER.

is a steam pipe connecting *D* with *L*. *N* is the air inlet. *O* is a tower scrubber with blocks of wood *P* and a filter chamber *Q*.

§ 216. *Wyer suction gas-producer.*

This is shown in Fig. 70 and 71. Referring to Fig. 70, *A* is

the shaking grate which is operated by lever *B*. The grate may also be raised and lowered by means of a screw not shown in the illustration. *C* is a fuel pre-heating tube with renewable mouthpiece *D*. The gas must go up and around *C* and then down

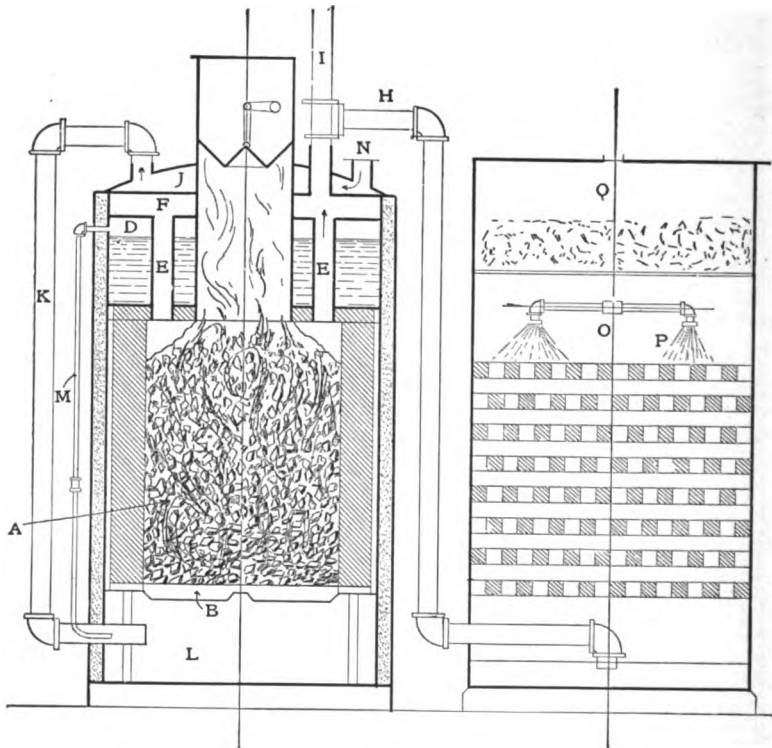

FIG. 69. — BALTIMORE SUCTION GAS-PRODUCER.

the port *E*. In this way the gas gives up a large part of its sensible heat to the column of fuel in *C*. When the lid *F* is in place the cone *G* is lowered, and any vapors that are evolved from the fuel in *C* pass down in port *H* and by means of pipe *I* are led to the ash pit; these vapors then go up through the fuel bed and are broken up there into permanent gases. The other details of the construction are evident from the illustration. The air is pre-heated and the water is vaporized and the resulting steam

superheated by means of a tubular heater placed near the engine, which utilizes a portion of the heat in the exhaust gases. Fig. 71 shows the automatic water regulator, for a hit-and-miss gas engine. *J* is a piston with stem *K* upon which is the follower

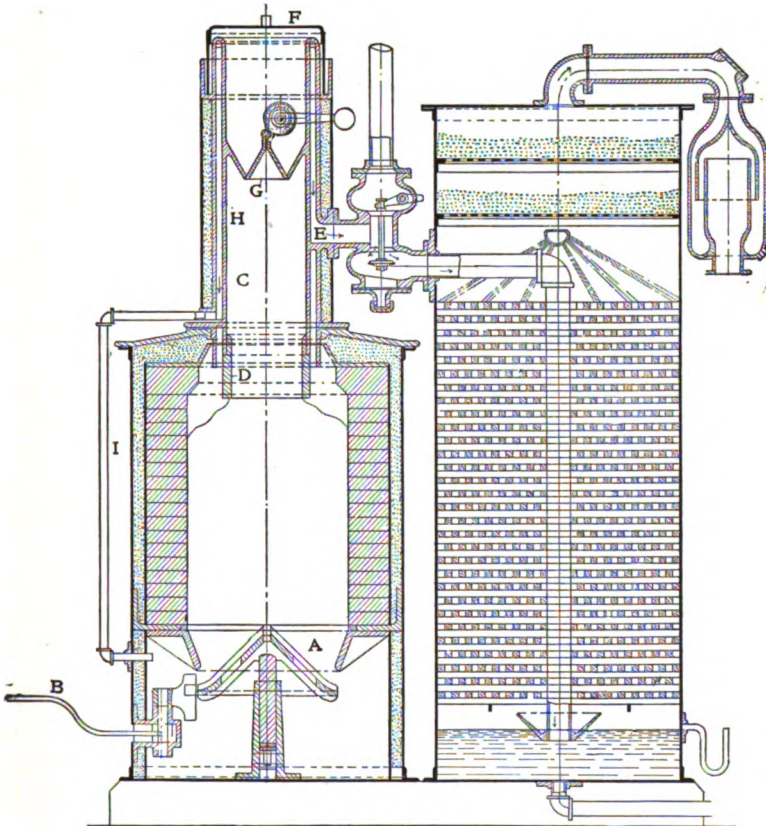

FIG. 70. — WYER SUCTION GAS-PRODUCER.

piston *L*; *M* is the inlet port that is supplied with water from the trap *N*, through which the jacket water circulates. *O* is a port that leads the water to the vaporizer. *J* is connected to some mechanism of the engine whose movement is controlled by the governor. Every time that an explosion takes place, port *M* is closed and port *O* opened and the water contained between *J* and *L* passes down into *O*. Then the spring *P* draws *J* and *L*

back to their starting position. Thus a small amount of water is admitted to the vaporizer every time that the engine draws in a charge of gas; this amount may be adjusted by changing the

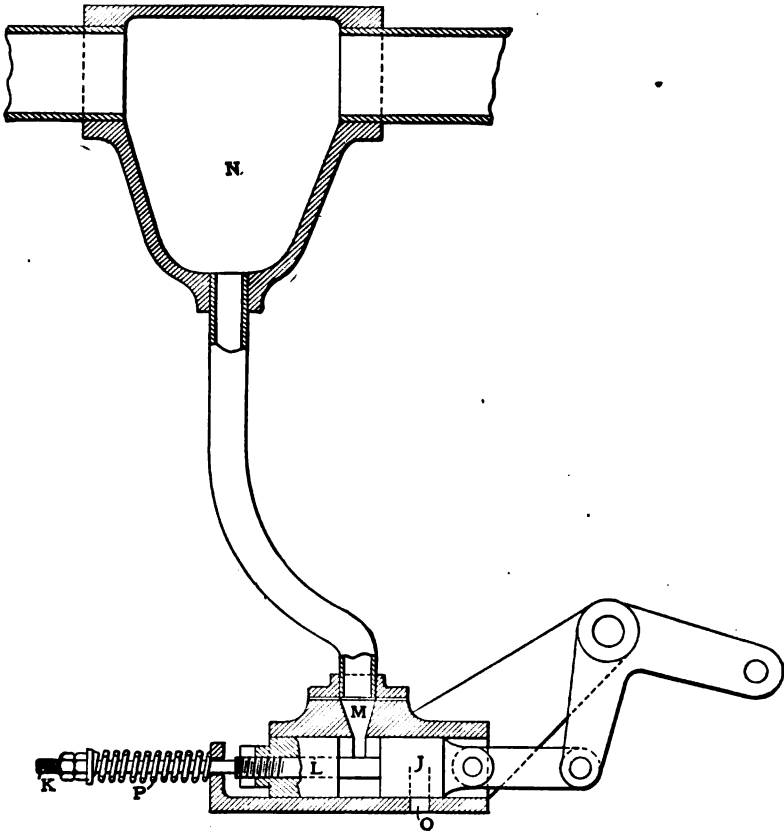

FIG. 71. — WYER WATER REGULATOR.

distance between *L* and *J*. This secures an accurate and positive regulation of water under any variation of load. A similar device working in a vertical direction is used for throttling engines.

CHAPTER XVII.

GAS CLEANING.

§ 217. *Object of cleaning.*

The object in cleaning producer-gas is to remove such constituents as have a deleterious effect on the particular work that the gas has to do, the use of the gas determining the extent of cleaning or the purity of the gas. Constituents that would be harmless where the gas is to be burned in a furnace might make the gas utterly worthless for use in engines. Further, in some cases, the cleaning of gas to a degree of purity suitable for engine use would prohibit the use of such cleaned gas in furnaces on account of the additional cost. The only general rule that may be laid down is that of the adaptability of the gas to its particular use. The removal of the tar is of such vital importance that it is discussed in detail in Chapter 23.

§ 218. *Classification of methods.*

The methods used in cleaning gas may be classified as follows:

1. Deflectors.
2. Liquid scrubbers.
 - a. Sprays.
 - b. Films.
 - c. Seals.
3. Coolers.
4. Absorbers or filters.
5. Rotating scrubbers.
 - a. Slow speed (mixing action).
 - b. High speed (centrifugal force).

These classified types are generally not used alone but two or more are usually combined; thus, in Fig. 57, we have a combination of deflector, spray scrubber, and absorber.

The principle of operation of the respective types will now be discussed in detail.

§ 219. Deflectors.

The operation of these depends upon the fact that when the motion of a rapidly moving volume of gas, carrying matter in suspension, is suddenly checked or deflected by impinging against an obstruction, a part of the suspended matter will settle down into a chamber — if one is provided — and at the same time the gas will go around the obstruction or deflector. If the settling

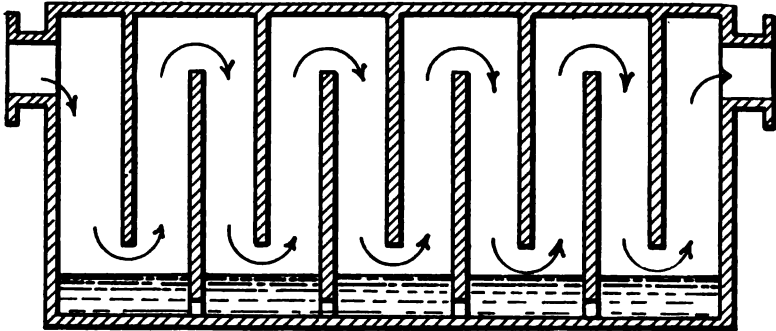

FIG. 72. — MOISTURE COLLECTOR.

chamber is provided with a means for cleaning same, the matter collected from the gas may be removed from time to time as desired. Fig. 72 is a moisture collector. Fig. 73 shows an arrangement for collecting dust, while Fig. 74 is intended to

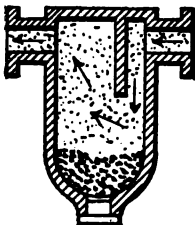

FIG. 73. — DUST COLLECTOR.

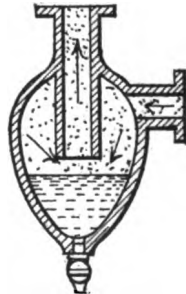

FIG. 74. — MOISTURE COLLECTOR.

dry gas by catching the water carried in suspension. Fig. 75 shows the arrangement of a device to remove tar from gas. It consists of an inclosed tank *A* with gas inlet *B* and outlet *C*. *D* are deflectors made of sheet brass, a full sized detail

of these being shown in Fig. 76. As the gas passes through the apparatus, it must pass through *D*, and in so doing is split up

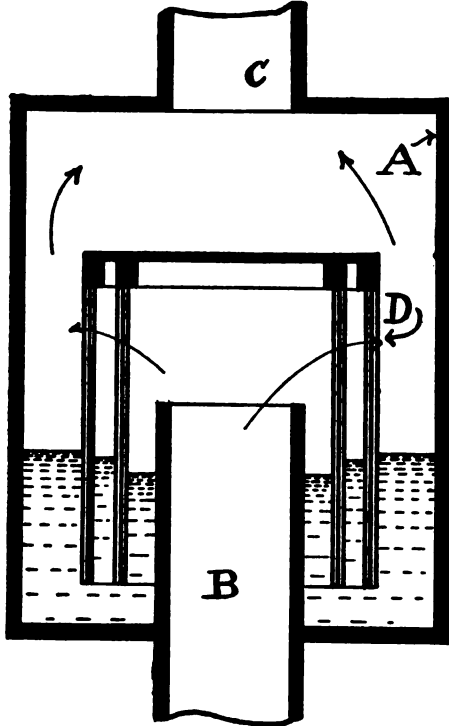

FIG. 75. — TAR COLLECTOR.

into fine streams and the tar is deposited on the brass sheets, where it then drains into the tar seal below. This has been used

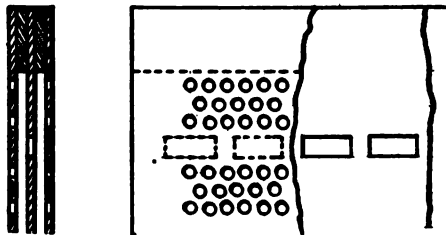

FIG. 76. — FULL SIZE DETAIL OF DEFLECTOR IN TAR COLLECTOR.

with some success in Europe, but the clogging up of the small holes gives trouble.

§ 220. *Liquid scrubbers.*

Water is usually used in connection with the cleaning of producer-gas, and this has a twofold action: First, to condense any steam that may be in the gas. Second, to wet the particles carried in suspension and thus cause them to settle down to the bottom of the scrubber where they may be drained off at intervals. Fig. 62 shows a spray. A film of water is used in the scrubber shown in Fig. 77. Here the gas enters at *A* and leaves at *B*, the water coming in at *C* and running down over the shelves *D*. As the water drops from one shelf to another in the form of a film, the gas passes through it, and the suspended matter is washed out. In all liquid scrubbers, it is desirable to have opposite currents. (See § 26.) Water seals or bell washers are discussed in § 242.

§ 221. *Coolers.*

The function of the cooler is to precipitate the condensible constituents, or simply to reduce the temperature of the gas by passing it through air- or water-cooled vessels. A cooler of this type, which is shown in Fig. 78, has been used extensively in Sweden for removing the moisture, tar, and acetic acid in producer-gas made from wood. In the arrangement shown, the gas enters at *A*, then passes down through the annular opening *B* between the water jackets *C* and *D*; as cold water is kept circulating through these, the walls of *B* are kept cool, which in turn cools the gas and causes the condensible constituents to be precipitated in the tank *E* below; the cleaned gas passes out at *F*. Air coolers are sometimes used for reducing the temperature of gas before it goes to a gas engine.

§ 222. *Absorbers or filters.*

These act by absorbing impurities in the gas and they are frequently used for removing globules of tar and water. Sawdust, shavings, excelsior, coke, and charcoal are used for this purpose; it is evident that these absorbing substances must be kept reasonably clean, since, if they become clogged up or saturated with impurities, their efficiency is materially decreased, and they may become useless. The purifier *J*, in Fig. 57, is of this type.

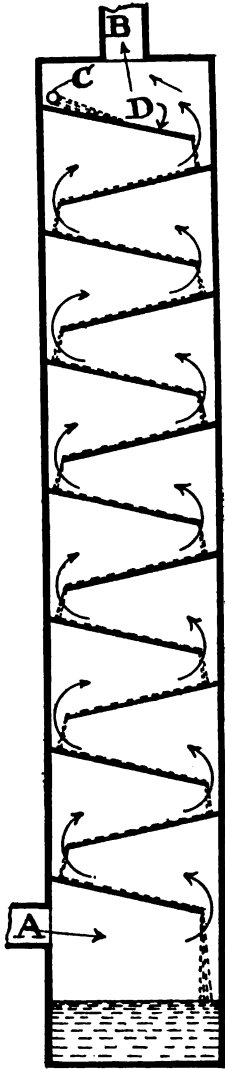

FIG. 77.
FILM SCRUBBER.

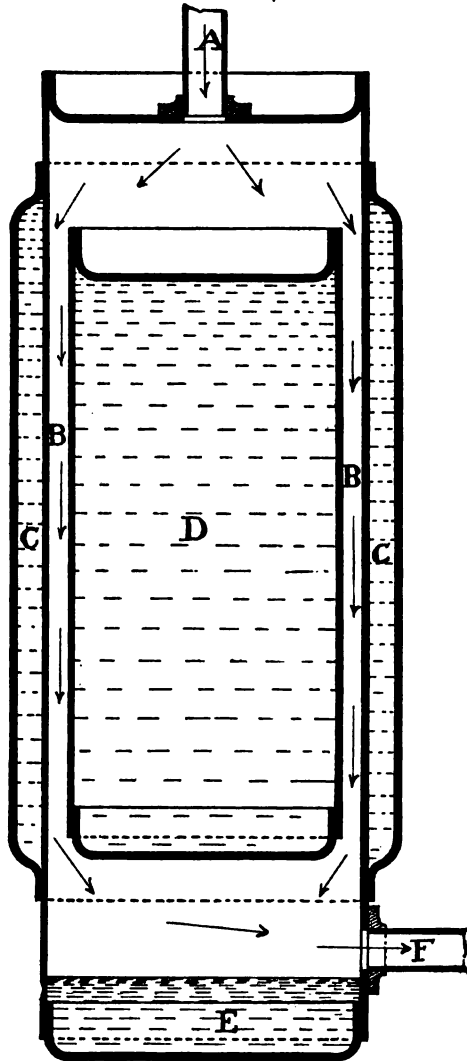

FIG. 78. — WIMAN GAS COOLER.

§ 223. *Rotating scrubbers.*

These may be divided into slow- and high-speed types. To separate the impurities, the slow-speed type depends upon a

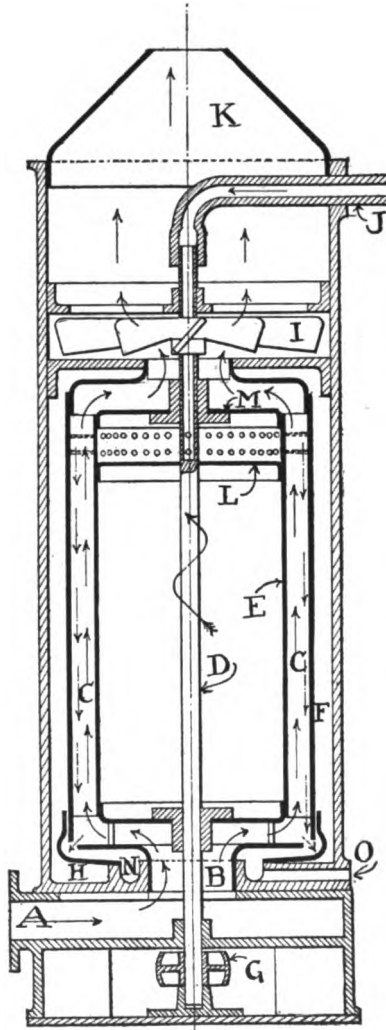

FIG. 79. — SECTION OF WINDHAUSEN GAS-SCRUBBER.

thorough mixture of the gas and a liquor, usually water; the high-speed, on the centrifugal force of the impurities in the gas.

A German design of the slow-speed type is shown in Fig. 79. It consists of a central shaft, *D*, driven in the direction shown by pulley *G*; at the upper end of *D* is a fan *I*. The gas enters at *A* and is drawn up through *B* and *C* by *I*. *E* is an inner and *F* an outer shell attached to *D* and rotated with it. *J* is the water-inlet pipe. The upper end of *D* is hollow, and water is forced

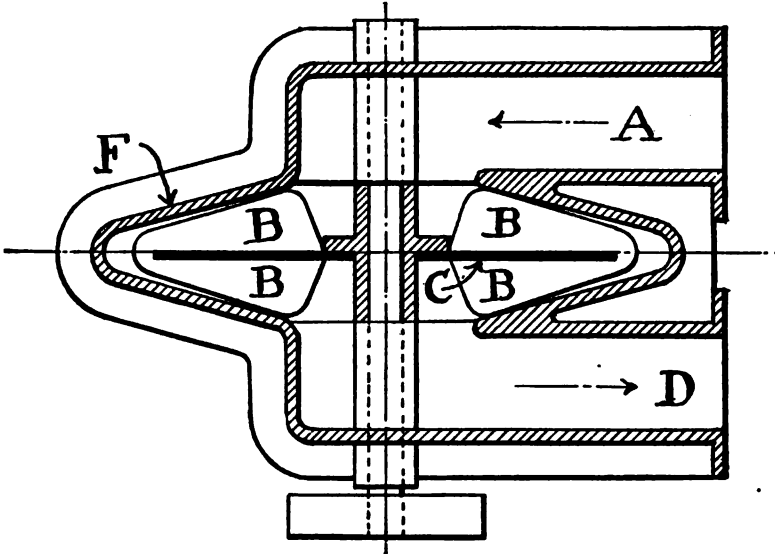

FIG. 80. — HORIZONTAL SECTION OF CENTRIFUGAL SCRUBBER.

into it and out into the chamber formed by *L* and *M*. As *C* is perforated between *L* and *M*, the water goes on through and impinges against *F*; after flowing down, it is caught in the annular pan *H* and channel *N* and then goes out at *O*. *K* is the gas outlet.

The operation is as follows: As the fan draws the gas through the apparatus, the gas and water travel in opposite directions in *C*; and as this space is made very thin, the gas comes in close contact with the film of water and the impurities are washed down into *H* and out at *O*.

An English design of the centrifugal type is shown in Fig. 80 and 81. The gas enters at *A* and is given a high peripheral velocity by vanes *B*. *C* is a partition disc that compels the gas

to go out to its circumference in order to pass through the apparatus. In so doing, the impurities are dashed against the casing *F* and then drained out at *E*, while the purified gas passes out at *D*. The machine is simple, does not require very much power, and has given good results in the elimination of dust, water, and tar.

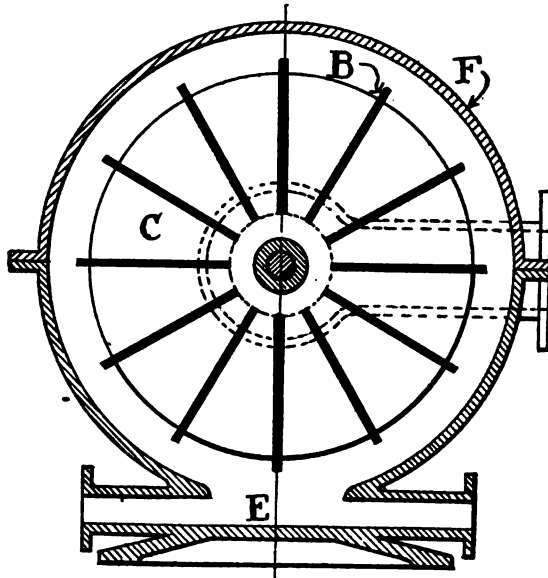

FIG. 81. — VERTICAL SECTION OF CENTRIFUGAL SCRUBBER.

§ 224. *Proportions of tower scrubbers.*

Height is an advantage so that the gas may be more easily broken up and more wet surface may be presented. In pressure-gas plants the diameter is usually one-sixth the height, while in suction-gas plants the diameter is one-fourth the height. The volume of the scrubber should be about six times the normal fuel volume of the producer.

CHAPTER XVIII.

BY-PRODUCT GAS-PRODUCERS.

§ 225. *Definition of by-product gas-producer.*

The by-product gas-producer, in addition to making gas for a certain purpose, also produces one or more auxiliary products which are based on certain constituents of the raw fuel and resulting gas. The by-products are usually based on constituents that are otherwise useless and would go to waste. The number, nature, and value of the by-products and the method of collecting will depend on the composition of the raw fuel, type of apparatus, cost of operating, and *commercial value* of the products saved.

§ 226. *Number and value of by-products.*

Coal will generally contain about 1.5 per cent of nitrogen; in the process of gasification in the producer about 15 per cent of this quantity of nitrogen is given off in the form of ammonia. The use of an excess of steam will greatly increase the yield of ammonia. By means of suitable apparatus, the ammonia may be recovered by combining it with some acid. Diluted sulphuric acid is generally used, as this produces the sulphate of ammonia, which is the most valuable and important by-product at present. This is about the only one saved and is discussed in § 227. Its principal use is that of an artificial fertilizer. Tar is sometimes saved, but this is so troublesome that the commercial value of the product does not justify the additional expense. However, this refers only to cases where the tar is recovered for its *intrinsic* value, and does not apply to the many instances where the tar must be removed from the gas in order that it may be used for engine work. (See § 280, and Chapter 23.)

The factors which will determine whether a by-product producer-gas plant will be profitable or feasible are as follows: (1) Increased cost of installation and maintenance; (2) Salary of skilled technical chemist who will control all operations of

the plant; (3) Cost of raw fuel; (4) Cost of chemicals for process; (5) Commercial value and sale of by-product; (6) Use of gas.

1. On account of the extensive scrubbing apparatus required, the cost of installation and maintenance for a by-product plant will be considerably higher than for an ordinary plant. However, as a by-product plant must be on an extensive scale from the very nature of the case, the cost of labor-saving appliances will be decreased. This is an important advantage, since the use of labor-saving devices is imperative in all well designed plants.

2. For a by-product plant to be successful, it must be in the control of a skilled technical chemist. Not only must the incoming raw material be sampled and analyzed at regular intervals, but the finished by-products must be kept up to a certain definite standard in order that they may be of commercial value. The laws of some states prescribe the composition of various by-products, and in such cases it is imperative to keep the quality up to the legal standard in order to secure a safe market. This can be done only by careful supervision.

3. In general, a cheaper grade of fuel may be used in the by-product process than in the ordinary system.

4. In some cases, the cost of the chemicals required would be so high as to make the process unprofitable.

5. The successful selling of the by-products will be the most important factor. Since ammonia sulphate is at present about the only product of value, it is evident that the installation of a large number of by-product plants would cause an over-production of it and would result in a decrease in the market price, unless the use of ammonia sulphate can be increased at the same rate with the production, thus maintaining an economical equilibrium. Companies now operating or about to install by-product plants will find it advantageous commercially to interest farmers in the value and use of ammonia sulphate. This will require judicious advertising and the dissemination of simple and authentic data with regard to the application of this fertilizer to the different soils. Most of the failures made in its use have been due to ignorance, *i.e.*, using it in improper quantities, by poor methods, or on soils for which it is not adapted. The inevitable failures following its indiscriminate application will be sure to react against its extensive use, whereas the success following

its scientific use will greatly augment the sales. Hence the vital importance of the statements in the preceding sentences.

6. A by-product process will make a cleaner gas from a low-grade fuel than the average producer. If the gas is to be used for power purposes this is an important advantage.

§ 227. *Ammonia sulphate.*

Since this is the only by-product of value, it will be desirable to have a clear understanding of its properties and uses. The high value of ammonia salts as a fertilizer for certain soils has long been recognized. "Ammonia sulphate is one of the most concentrated forms in which ammonia can be applied to the soil, and is, at the same time, one of the most active and readily available forms, being decidedly quicker in its action than any form of organo-nitrogenous matter. This manure is a very valuable one on clayey and loamy soils, while for cereals, potatoes, and some other crops it is used with great success, especially where it can be harrowed in and covered with the soil." (B 349.)

"Pure ammonia sulphate is a whitish crystalline salt, extremely soluble in water. The commercial article, however, is generally grayish or brownish in color, owing to the presence of slight quantities of impurities. The pure salt should contain 25.75 per cent of ammonia; but the commercial article is generally sold on a basis of 24.5 per cent. A useful test of its purity is the fact that, when subjected to a red heat, it should almost entirely volatilize, leaving very little residue. The chief impurities which it is likely to contain are an excess of moisture, free acid, or the presence of insoluble matter." (B 350.)

Ammonium sulphocyanate, which is an extremely poisonous substance for plants, may sometimes be present. To test for this, treat a sample of the ammonia sulphate with ferric chloride; if the sulphocyanate is present, the sample will change to a blood-red color.

"The chief advantages of ammonia sulphate are that it is very concentrated, therefore reducing the cost of handling; it is always in the same form, a distinct and definite product, thus rendering its purchase a safe proceeding. It is quick to act, thus making it a very useful form, especially for quick-growing crops. Its physical character is such as to permit its ready distribution in a mixture." (B 348.)

The fact that this fertilizer is not adapted for all soils, and in fact is worthless for some, is illustrated in the following. For instance, it is practically worthless on soils containing chalk or lime, for when it is applied the following reactions take place:

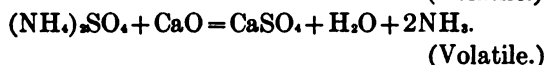
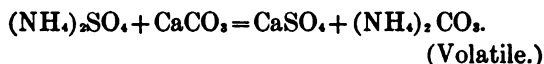

As the ammonium compound in either case is volatile, it will simply pass off to the atmosphere without nourishing the plant.

§ 228. *Method of recovering by-products.*

There are numerous patents on different methods for recovering the by-products. They all embody the following fundamental points: The gas on leaving the producer is cooled by passing through radiating appliances and then goes to various forms of scrubbers and washers, where it is treated with some reagent whose function is to precipitate or absorb some of the constituents in the gas, which is then thoroughly washed with water to remove the fine dust and condense the tar. Sometimes the gas is further treated to remove its moisture.

§ 229. *Mond by-product producer-gas process.*

This was the first process to be commercially successful and is the only one that has been introduced in this country. It was developed and perfected by Dr. Ludwig Mond of England.

A diagrammatic drawing of a Mond plant is shown in Fig. 82. *A* is the producer with the charging hopper *B* and hopper extension *C*. The producer consists of two steel shells which thus form an annular space in which the air and steam may be heated by circulating around the producer. The lower end of the producer has a cone *D* which extends into the ash trough *E*, and with the water there forms a water seal. *F* is a thin firebrick lining. *G* are recuperator pipes which cool the gas and pre-heat the air and steam passing around them. *H* is a washer with revolving blades *I*. *J* is the pipe connecting *H* with ammonia-recovery tower *K*, which is filled with checkerwork.

L is the acid-supply tank. *M* is the drain tank from *K*, the liquor in the latter being led to *M* by pipe *N*. *O* is the liquor-circulating pump which carries the liquor to the top of *K* by

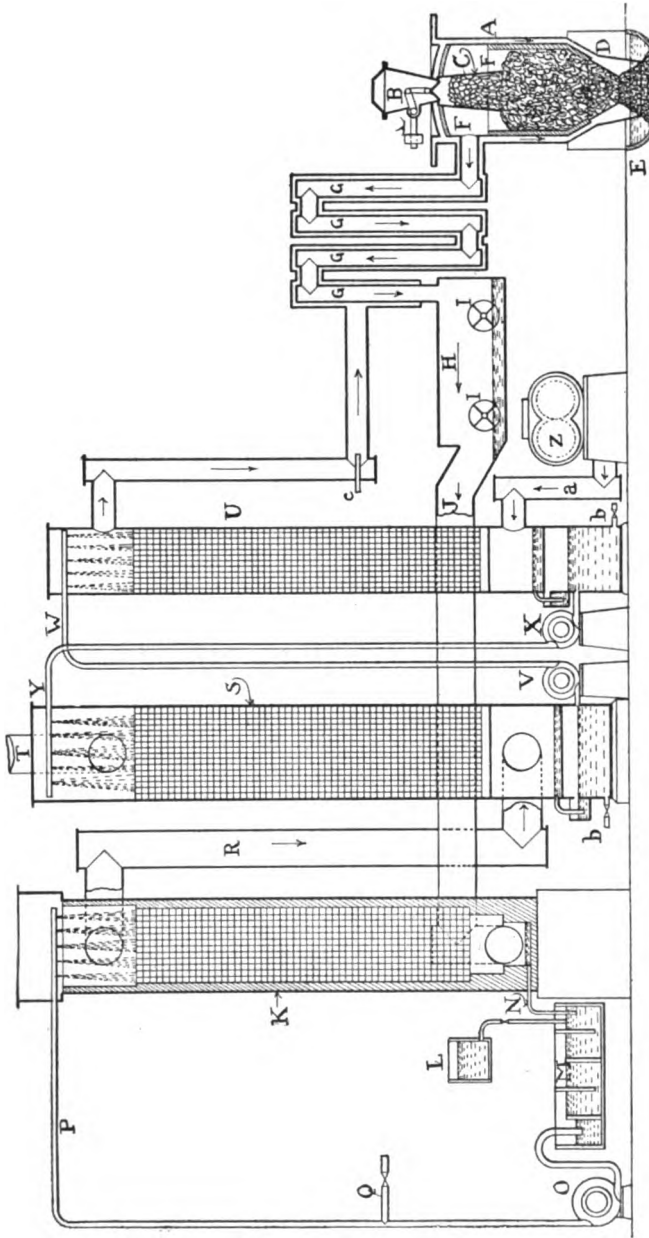

FIG. 82. — MOND BY-PRODUCT PRODUCER-GAS PLANT.

means of pipe *P*. *Q* is a pipe leading to the concentrated ammonia sulphate tank.

R is the pipe connecting *K* with the gas-cooling tower *S*, which is filled with checkerwork. *T* is the gas exit; from here the gas is delivered to the mains. *U* is the air-heating tower, also filled with checkerwork.

V and *X* are pumps for circulating hot and cold water respectively, by means of pipes *W* and *Y*. *Z* is the air blower connected to *U* by pipe *a*. *b b*, tar drains. *c* is a pipe for admitting some of the engine exhaust gases to the air and steam blast.

The operation is as follows: As the coal is fed to *C*, the heat of the surrounding gases causes the moisture and some of the tarry vapors to be distilled off. In order to escape from *C*, these vapors must pass down and into the hot fuel bed, where they are broken up and converted into fixed gases. The fuel is kept at a dull red heat by an excessive amount of superheated steam; 3 lb. of air and 2½ lb. steam at 250 degrees C. are furnished per pound of fuel. About one-sixth of the steam is decomposed in the producer, the remainder being condensed in the scrubbing apparatus. The large amount of steam is used to prevent the decomposition of the ammonia, the formation of clinkers, and to secure a low and uniform temperature.

The gas leaves the producer at about 500 degrees C., and, in passing through the recuperators *G*, gives up a large portion of its sensible heat to the incoming steam and air. From *G* the gas goes to the mechanical washer *H*, where the revolving dashers *I* fill the chamber with fine water spray which washes the dust and soot out of the gas. Tarry products will also be condensed and these may be skimmed off at intervals. In this washer the gas is cooled and charged with steam, but not to the saturation point. This is important, as it is very desirable to prevent the formation of water in the ammonia-recovery tower, which would be the inevitable result of allowing the gas to become saturated.

From *H* the gas goes to the tower *K*. The checkerwork is kept saturated with a diluted solution of sulphuric acid from the pipe *P*. When the ammonia in the gas comes into contact with the acid, sulphate of ammonia is formed. Thus:

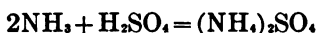

It will be noticed that the acid and the gas travel in opposite

directions (§ 26), thus securing a very close contact of the two. The acid liquor is kept in circulation by pump *O* until it contains about 36 per cent of sulphate of ammonia. The continuity of the process is maintained by removing some of the sulphate-laden liquor at intervals by means of pipe *Q* and adding a corresponding amount of fresh diluted acid from tank *L*. The solution of the sulphate is then reduced to a solid state by evaporation.

The gas then goes to the cooling tower *S*, where the temperature is reduced to about 55 degrees C. by means of cool water introduced from *Y*. Thus the water condenses the water vapor in the gas and takes up the sensible and latent heat. The gas is now ready for delivery to the mains.

The hot water accumulating at the bottom of *S* has a temperature of about 75 degrees C. and is withdrawn by pump *V* and delivered by pipe *W* to the top of the air-heating tower *U*. The air is forced into the system by the rotary blower *Z*, and as it comes up through *U* is heated and saturated with water vapor. From *U* the air goes around the recuperators *G*, where it absorbs more heat and is then delivered to the producer. The water in coming down through *U* is cooled to about 40 degrees C. Pump *X* then delivers this to the top of the tower *S*.

The tar collecting in the bottom of *S* and *U* may be removed by means of drain pipes *b*. Steam is usually supplied by a small auxiliary boiler.

The Mond producer may be used without the by-product feature by omitting the ammonia tower from the scrubbing apparatus. In such a case part of the engine exhaust gases are introduced at *c*; the CO_2 contained in these is reduced to CO in the producer. The object of this is to keep the temperature of the producer down without the use of the excess of steam required in the by-product system.

§ 230. *Distinctive features of Mond process.*

1. The manufacture of a gas of uniform quality, and clean enough for engine use, from cheap bituminous slack.
2. The use of a large excess of superheated steam in the producer, thus eliminating clinkering.
3. The use of recuperation and regeneration to conserve the heat loss.

4. The recovery of 70 per cent of the nitrogen in the slack and the conversion of this into sulphate of ammonia, each ton of slack yielding about 90 lb. of the sulphate.

5. "The method of continuously employing the water in circulation as the heat-carrying agent between the hot gas in one tower and the cold air in another, and the method of recovering from the hot gas, by this continuous cyclical exchange of heat, a large proportion of the steam required for the blast." (B 201.)

CHAPTER XIX.

BY-PRODUCT COKE-OVEN GAS-PRODUCERS.

§ 231. *Status and future.*

The composition (see table 4, p. 50) of coke-oven gas and the method of manufacture are radically different from producer-gas. However, the method used in handling the raw fuel and resulting gas, the treatment of the by-products, and the probable extensive development of the system make it desirable to have a clear understanding of its value, scope, method of operation, and type of apparatus used.

The by-product coke-oven process has already attained a well recognized position in the metallurgical field, and is destined to play an important part in the fuel supply of the larger cities and thickly populated districts. To such communities the by-product oven delivers gas for illuminating, power, and fuel purposes on a basis as favorable as that of any other method, and at the same time yields coke suitable for domestic and industrial consumption which does not produce smoke. The approaching exhaustion of the anthracite mines prevents any reduction in the price of anthracite coal, and the consequent increase in the use of soft coal is arousing bitter opposition, particularly in those localities hitherto comparatively free from the smoke nuisance. The by-product oven offers a ready solution of the domestic smoke problem. It seems, therefore, beyond doubt that the by-product oven will play a large part in the future industrial development of this country.

Over 70 per cent of the ovens built in this country may be classed under two heads, viz.: the Otto-Hoffman oven, the original type built in Europe by Dr. C. Otto & Company, and the United-Otto oven, which is the improved type resulting from the American developments and modifications.

§ 232. *Otto-Hoffman Oven.*

The Otto-Hoffman oven in the American form is shown in sectional perspective in Fig. 83. The coking chamber itself con-

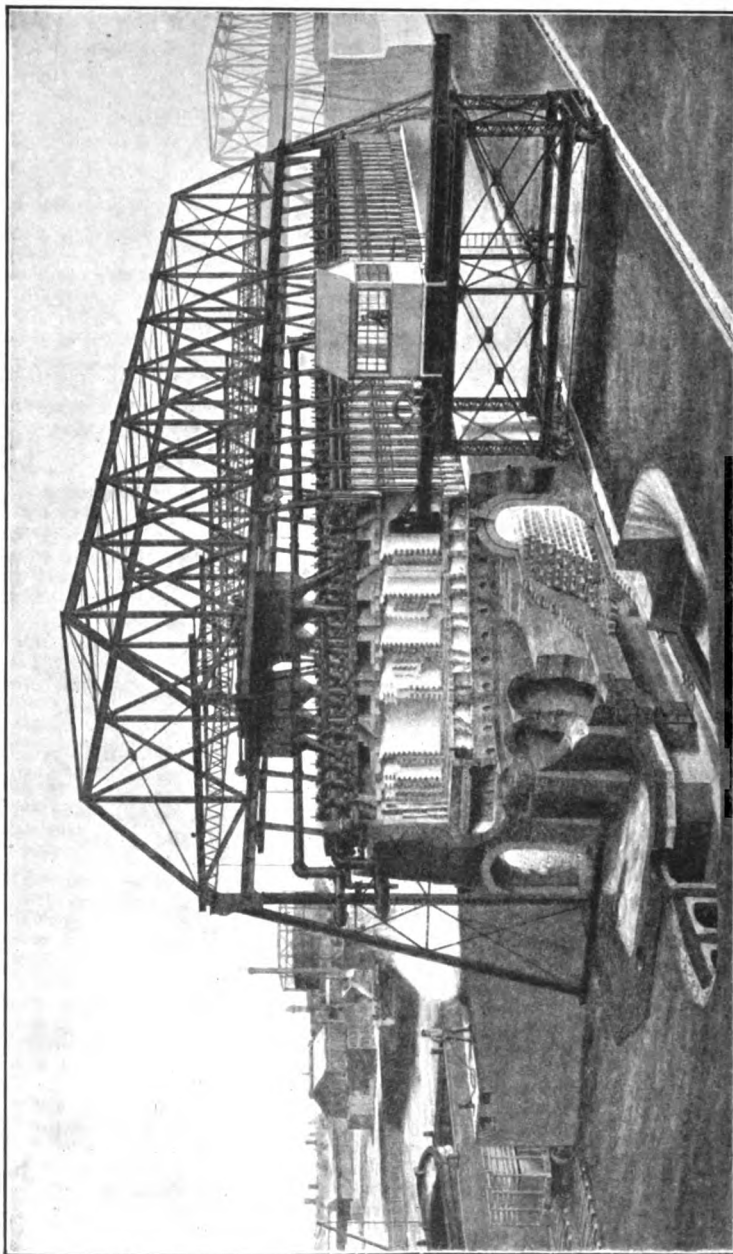

FIG. 83. — OTTO-HOFFMAN COKE-OVEN.

sists of a long, narrow retort of firebrick construction, a number of such retorts, usually 50, being placed side by side to form a battery. The dimensions of this retort are 33 ft. long, 6½ ft. high, and from 17 in. to 22 in. in width, containing 6 to 7 net tons of coal at a charge. The walls of the retort are built with vertical internal flues, heated by gas. The ends of the retorts are closed by iron doors, lined with firebrick, fitting closely to the brickwork and luted with clay. These are raised and lowered by a winch or by an electrical lifting device. The coal is charged into the ovens from three larries moved by hand along tracks, laid on the oven top or, in the later plants, by a single electrically operated larry as shown in the illustration. The single larry has spouts which deliver the coal from corresponding openings in the oven top to the oven chamber below. The coke is pushed out of the oven by the electrically operated pusher and is received and quenched on a wharf, from which it is loaded by hand into railroad cars on a depressed track alongside. The heating of the oven is done by gas, returned from the condensing house through lines running along each side of the battery, there being a burner at each end of each oven. Only one burner is used at a time. The air for combustion is taken in at the end of the battery, where the gas and air reversing valves are located, and is led through the underground passages, shown in the figure, to the flues beneath the regenerative chambers. These extend the whole length of the oven battery and are filled with checkerbrick. The air rising through this checkerwork is heated to a high degree, passing then through uptake connections to the space beneath the floor of the oven chambers, and through lateral ports to the combustion chamber, where it meets the gas from the burner. The burning gases rise through the vertical flues of half the wall, pass along the horizontal connecting flue above, and down the remaining vertical flues to the horizontal flues below, thence passing to the regenerator, where their sensible heat is absorbed by the checkerwork. From there they are led to the lower regenerator flue, past the reversing valve to the draft stack. On the reversal of the air and gas, the gas burner on the other end of the oven comes into use, the air passing up through the heated regenerator on that side, and to the gas chamber and combustion chamber, the heated gases passing in a reverse direction through the wall flues downward through the

regenerator and so to the stack. The period of reversal is 30 minutes.

§ 233. *Treatment of gas.*

The gas given off from the coal during the coking operation is led away from the oven through uptake pipes furnished with valves to the gas-collecting mains. If the surplus gas is to be used for fuel purposes only, one gas-collecting main is needed, but if it is required to make illuminating gas, two are used — one to take the portion of the gas delivered during the first part of the coking time, known as the "rich gas." This fraction is higher in illuminants than the last portion of the gas, and is therefore better suited for distribution purposes. This separation is done by the application of the principle of fractional distillation (§ 49). The last portion of the gas is led off into the fuel-gas main and is used for heating the ovens. The two portions of the gas are kept absolutely separate through the subsequent cooling and condensing operations, the condensing house being so arranged as to handle them in separate systems, usually arranged in parallel.

§ 234. *United-Otto oven.*

This is a modification of the type described in the previous section. The adoption of the underfired principle in this oven admits of properly heating a longer retort of greater coal capacity than would be possible with the older system of a single burner at either end; at the same time the retention of the regenerative system aids the heat distribution and permits each oven battery to be an economical unit without the use of the steam boiler auxiliary to absorb the heat from the waste gases.

The details of this type of oven are shown in the cross-section in Fig. 84, which also gives the arrangement of the coal conveyors, coal bin, pusher, and quencher. The oven itself is a rectangular retort from 33 to 43 ft. long, 7 to 9 ft. high, and 17 in. wide, the dimensions varying with the characteristics of the coal that is to be used. The retort walls, top and bottom, are composed of refractory material, and the masonry is supported on a steel and concrete substructure so as to be entirely independent of the regenerative chambers below. This avoids the cracking of the oven walls and the subsequent loss of gas liable to occur from the expansion and contraction of the heated regenerator walls

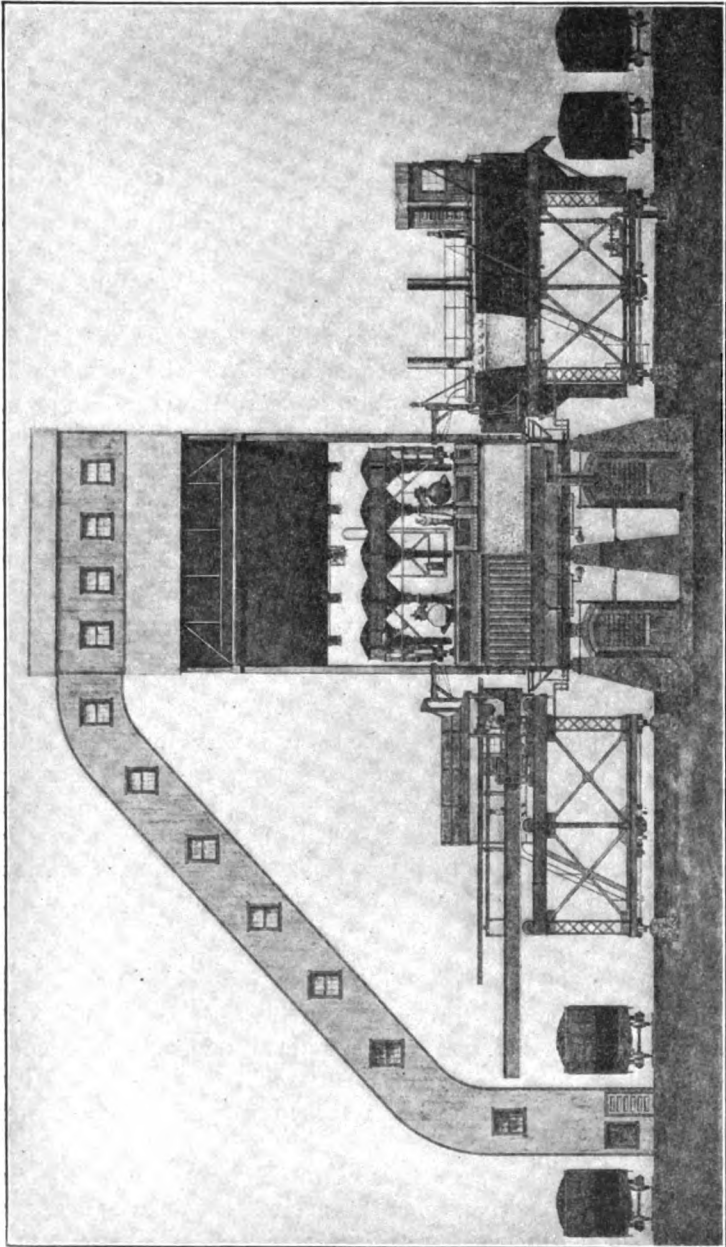

FIG. 84. — CROSS-SECTION OF UNITED-OTTO COKE-OVEN PLANT.

beneath the oven structure. The open substructure admits of a complete anchoring system joining the buckstays above and below, and holding the oven walls securely in place. The steel work of the substructure is protected from the heated brickwork above by a course of hollow tile, which also serves to retain the heat in the ovens themselves.

The oven chamber is closed at either end by doors, which are of the self-sealing type, replacing clay luted doors. These do away with the labor of mixing and applying the luting clay.

§ 235. *Wall construction.*

The construction of the oven walls is a point of vital importance. Shaped brick ground to exact size by carborundum grinding wheels are used. This results in a practically gas-tight wall of great strength.

The resistance of the wall is enhanced by the vertical flue system. As will be seen in the drawing, the heating flues run perpendicularly along all that portion of the oven wall against which the coal can exert any pressure. The divisions between the flues form vertical strengthening ribs, and tie the walls into a single homogeneous whole. This is of vital importance when coals of only slightly shrinking or even expanding nature are to be coked.

§ 236. *Heating systems.*

The heating of the United-Otto ovens is accomplished, as in the Otto-Hoffman oven, by the use of gas returned from the condensing house through the two mains shown beneath the middle portion of the ovens in Fig. 84. The air for combustion is supplied to the regenerator by a fan, this method aiding in the equal distribution of the air to each oven and reducing the amount of stack draft necessary.

§ 237. *Operation.*

The gas is admitted through a burner at each end and four or six burners in the bottom, placed symmetrically on each side of the middle line. This avoids the use of bottom burners above the regenerative chambers, where they are less easy of access for cleaning and regulation.

The surface of the checker brick in the regenerators is so proportioned as to render efficient service in absorbing the heat from the waste gases. The temperature of the waste gases leaving

the regenerators is not high enough to cause deterioration of cast-iron reversing valves of the usual form.

The coal received in the cars is dumped into track hoppers below the ground level and transported by the coal conveyor to the storage bin above. From this bin the coal is drawn through chutes to the charging larry beneath, which is operated by electric motors and travels on rails over the top of the oven battery. From the larry the coal is charged into the ovens by means of the chutes, which correspond with the openings in the oven top. The charge is then leveled to an even surface in the oven by an electrically operated leveling bar, which travels back and forth through an opening in the oven door. This leveling bar is carried on the pusher, and is operated by the pusherman. When this is completed, the oven is sealed up and the valve leading to the gas main is opened. There are two of these mains provided, the one for the rich gas and the other for the fuel gas. When the coking period has elapsed, the ovens are disconnected from the gas mains, the doors are removed, and the coke charge pushed out of the oven by the ram or pusher seen on the left-hand side.

§ 238. *Quencher.*

The quencher is shown in actual operation in Fig. 85.

The coke is received in the quencher, which is a rectangular box of cast iron with cellular walls to admit of water cooling. It is large enough to take in the whole oven charge, and its bottom is formed of a motor-driven chain conveyor. The whole machine travels on rails parallel to the oven battery, and connection is made with the particular oven to be pushed by means of swing doors and a drop bottom which guide the coke charge to the receptacle, assisted by the moving conveyor bottom. When the charge is received the doors are closed and the coke quenched with water. The immediate and violent generation of steam is taken care of by the escape stack shown in the illustration. The whole receptacle is filled with steam, practically excluding the air, so that the silvery gray color of the coke is preserved, as in the beehive product. When the quenching is complete the coke is discharged into the car on the track adjoining.

Another form of quencher consists of a steel car having a sloping bottom, which travels along the oven battery as described above, and into which the coke falls as it is pushed out of the

oven and across the narrow oven platform. The coke lying in the car is quenched by means of a water hose. The motion of the car across the path of the coke leaving the oven serves to distribute it evenly on the floor of the car. Many of the older plants still quench the coke on a wharf built at the height of

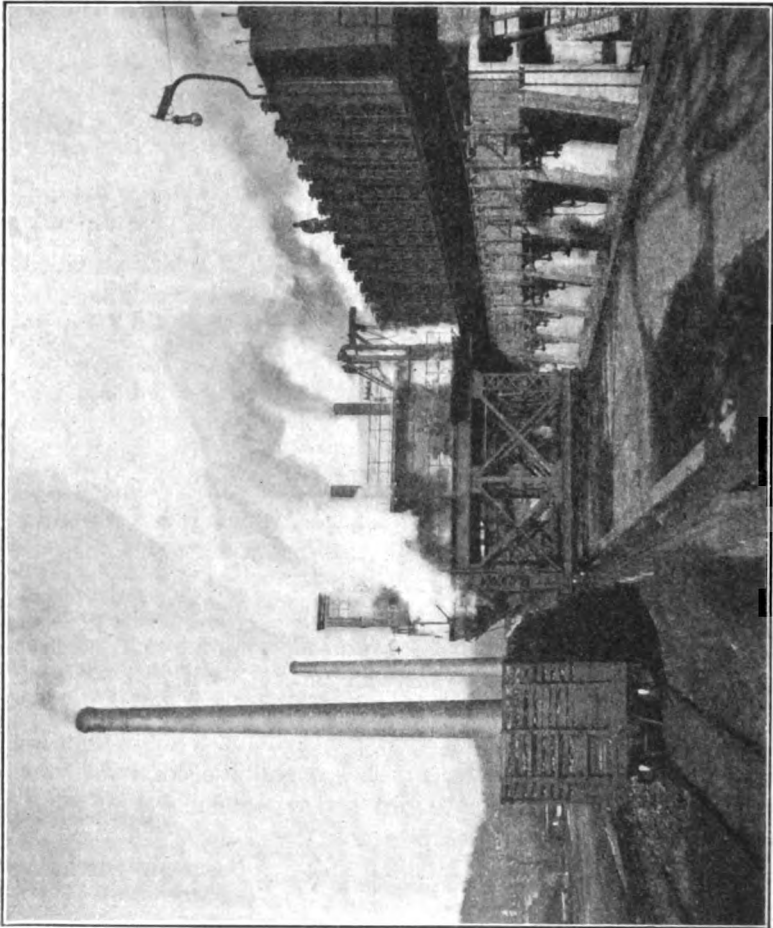

FIG. 85. — COKE QUENCHER.

the oven bottom, and wide enough to take the whole oven charge easily. The coke pushed out on this wharf is spread out with hooks and quenched with a hose, as shown in Fig. 83, afterwards being loaded into railroad cars by barrows.

§ 239. *Air and water coolers.*

These are shown in Fig. 86. The gas enters on the left, coming directly from the ovens. It first passes through air and water coolers, which lead the gas to and fro in ascending zigzag passages, exposing a large surface for atmospheric cooling. A number of these cooling units are arranged in parallel, so that any single one may be taken off for cleaning without disturbing the operation of the remainder. All are provided with an external sprinkling system, so that water cooling may be used in hot weather if necessary. The cross-section of the gas passages in this apparatus is long and narrow, so that the cooling surface is large for the volume of gas space.

The further reduction of the gas temperature is accomplished by the use of rectangular water coolers of special design. The gas space is divided by successive baffles so that a tortuous path is followed, and the water circulation is made to flow through the tubes in an opposite direction; this gives a high efficiency of heat transmission and permits economy in the use of cooling water.

§ 240. *Exhausters.*

These are of the positive rotary type, and are steam driven. The function of the exhauster is to remove the gas from the ovens and draw it through the mains and cooling apparatus, it being undesirable to rely upon the pressure generated by the gas evolution in the ovens to accomplish this. In order to avoid leakage of air into the ovens, a slight pressure is maintained on them at all times. The exhausters also force the gas through the scrubbing apparatus and deliver it to the ovens under pressure, or to the purifiers and storage gas holder in the case of the rich gas. The control of the gas passing through the system therefore centers in the exhauster room, and here is placed the gauge board, on which are carried the pressure and vacuum gauges showing the working conditions in the various apparatus.

§ 241. *Tar scrubbers.*

These are of the frictional type and remove the tar existing as a fine mist in the gas by passing it through small openings in successive thin steel diaphragms, the friction causing the tar to deposit in globules. With coal yielding considerable naphthalene, the temperature at the scrubber must be raised enough to

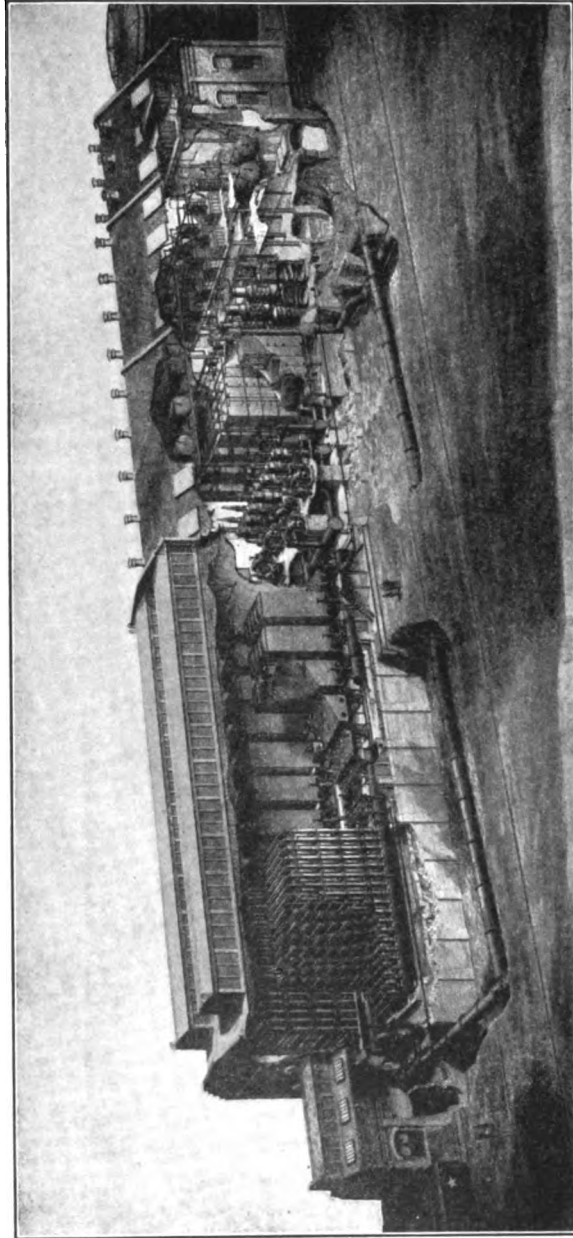

Fig. 86. — SECTION SHOWING CONDENSING APPARATUS.

overcome the stoppages occurring there from naphthaline deposits.

§ 242. *Ammonia scrubbers.*

These are of the tower type, the gas passing upwards through a lattice work of wooden slats, and the scrubbing water passing downwards. Fresh water is used in the last scrubber, and the weak resulting liquor is used in the scrubbers preceding this, until it becomes strong enough for distillation.

Another form of scrubber sometimes employed is of the rotary type. In this the gas passes through a cylindrical shell horizontally placed, through which passes a revolving shaft carrying wooden grids, lattice work on steel plates, which dip in compartments filled with water, forming the lower portion of the cylinder, and thus present a constantly wetted surface to the gas passing through the upper part. The ammonia is absorbed by the water, as in the tower scrubber. Bell washers in which the gas is forced through a series of water seals have been successfully used. The gas leaving the ammonia scrubbers is sufficiently clean for use in oven heating, for transportation to a distance under pressure, or for use in gas engines in the majority of cases. For illumination purposes it should be passed through purifiers to remove the sulphur compounds present, as is the case with ordinary illuminating gas. The amount of sulphur present in the gas depends entirely upon the quality of coal used.

§ 243. *Recovery of ammonia.*

The ammonia obtained is in the form of a crude weak liquor, containing from 1 to 2 per cent of ammonia (NH_3). This is transformed by distillation into concentrated crude liquor, having 14 to 18 per cent NH_3 , or by combining it with sulphuric acid into ammonium sulphate. In the first instance it can be disposed of to the manufacturers of alkali, soap and chemicals of various forms. It may be further purified to form aqua ammonia, or by distillation and compression transformed into anhydrous ammonia, either of which is used in artificial refrigeration.

§ 244. *Benzol recovery.*

Benzol (C_6H_6), or benzene, exists as a vapor in coke-oven gas. As it is an excellent illuminant, a large portion of the candle power is due to its presence. It can be recovered from the gas by passing through washers in which dead oil — creosote — is

used as the scrubbing liquor. This oil absorbs the benzol and it may be recovered from the oil by fractional distillation and subsequent condensation. It is a colorless liquid possessing great inflammability and is used as a solvent of India rubber and in various chemical manufactures. It is much employed abroad as an enricher of illuminating gas, but the limited production and high price, as well as the general use of petroleum products for the same purpose, have militated against its introduction in this country.

When the rich fraction of the gas is to be used for illuminating purposes, the removal of the benzol is clearly a detriment. It is, however, possible to obtain considerable benzol from the fuel-gas fraction, the loss in heating power being negligible. The transfer of this benzol without intermediate condensation to the rich fraction for its further enrichment is done by scrubbing the gas with dead oil — creosote — which absorbs the benzol, this oil in turn being deprived of its benzol by heating, and the benzol vapors mixed with the rich gas fraction. The process also has an advantage in its tendency to remove all naphthaline troubles.

§ 245. *Use of gas in engines.*

Coke-oven gas is well adapted for use in the gas engine for power purposes, the rich fraction having about 700 B. t. u. or the poor fraction having from 400 to 600 B. t. u. per cu. ft., according to the coal; or, in case the gas is not divided, the general run of gas averaging between these two in calorific power.

In general, the gas as delivered from the condensing house may be considered ready for use in the engine cylinder without further necessity for purification. The small amount of sulphur present does not appear to have sufficient action upon the working parts of the engine to justify the cost of its removal. The experience of a number of foreign coke-oven works, where oxide purification apparatus was provided for the removal of the sulphur before admitting the gas to the engines, has resulted in the majority of cases in eliminating this process entirely. In some cases further scrubbing through sawdust or other mechanical purifiers has been resorted to, but with a thoroughly cleaned gas this is, of course, unnecessary.

CHAPTER XX.

PRODUCER-GAS FOR FIRING CERAMIC KILNS.

§ 246. *Status.*

While producer-gas has been used to a considerable extent in Europe for the heating of ceramic kilns, it has not been introduced to any extent in this country. This fact may be accounted for as follows:

First, the limited literature on the subject — and this of a fragmentary nature — has made it generally impossible for engineers and manufacturers to secure reliable data on all the different phases of the problem. This ignorance of the subject has made it easy for many persons connected with the ceramic industry to entertain distorted and erroneous ideas of the advantages and disadvantages of the use of producer-gas for such work. In some cases, the advocates of both sides of the question have gone to extremes and have lost sight of the fundamental conditions of the problem.

Second, the economical use of fuel has not always been necessary. In general, a gas-producer will do more work with a given quantity of fuel and will also make it possible to use a lower grade of fuel.

Third, the absence or non-enforcement of laws against the smoke nuisance of ceramic plants. Since the gas-producer is an ideal solution for this problem, the enforcement of anti-smoke laws will result in an increased use of producers.

Fourth, the conservatism against change; "this peculiarity must be sought in the ancient traditions of the potter." However, as the customs and empirical recipes of the fathers are being rapidly replaced by the scientific methods and chemical formulæ of the technically trained ceramic engineers, we may expect that future methods of burning ceramic kilns will have a more rational basis, and that the true value of producer-gas for such work will be appreciated.

Fifth, inadaptability of kiln to producer. The neglect to recognize that it is imperative to have the kiln adapted to the producer, or *vice versa*, has resulted in many costly failures. A producer that would give good results in firing a lime or cement kiln might be a complete failure in firing some types of brick or tile kilns.

§ 247. *Value.*

Seeger (B 160) states: "The main point of gas-firing in all industries lies in the utilization of low-grade fuel which, on account of its high content of ash, its content of water and impurities, as well as owing to its form, does not produce the required heat effect." In other words, with gas-firing, higher and more uniform temperatures may be obtained when a low-grade fuel is gasified than when it is burned direct.

§ 248. *Objections.*

"The objections made to gas kilns — such as danger of explosions, greater cost of construction, obstruction of conduits by tar, more expensive firing, etc. — have very little, if any, foundation. But to succeed in using them carefully, well trained workmen are required who are capable of ensuring a steady and uniform working of the producer; there lies the whole secret of success." (B 126.)

§ 249. *Difficulties in using producer-gas.*

One of the first difficulties in the use of producer-gas is that, since the products of combustion are different from those of solid fuels, it is not possible to secure comparable results where the workman attempts to judge the degree or intensity of burning by observing the color of the finished product, as seen through the products of combustion. When a heated brick or other object is observed through this atmosphere, the shade of color appears very different from similar objects, at the same temperature and color, when observed through an atmosphere composed of the products of combustion of a solid fuel. This fact has been the cause of several failures where good coal burners have not been able to succeed with gas. It is evident that this trouble is not the fault of producer-gas, but rather the inability of the workman to interpret the results obtained, and it may easily be eliminated either by teaching the workman how to observe

the correct color and corresponding temperature or by controlling that point by means of a reliable pyrometer.

The regulation of the air supply — especially in burning brick — has often given trouble; this feature is discussed as follows by Davis (B 48), with reference to natural gas, but the same difficulties have frequently been experienced with producer-gas:

“If from any cause there is a disproportion between the gas and the air, the brick will be injured, as we shall see in relation to water-smoking and the early stage of firing. In water-smoking with gas, the process will require a longer period than with solid fuel in order to preserve the brick in their natural color and original form. If haste is attempted, the gas will not be thoroughly consumed and the oxygen taking up the hydrogen frees the carbon, which, being in minute particles, seems to enter the pores of the clay and discolor the brick. When the kiln becomes hotter, these particles are consumed and act as if bituminous coal dust had been mixed with the clay.”

The tar in the gas made from soft coal will frequently give more or less trouble by clogging valves, dampers, and conduits, or by discoloring the articles being burned in the kiln. The easiest solution for this is to so design the producer as to require the gas to pass through a mass of incandescent coke and in this way break up the tar into non-condensable compounds. Scrubbing the gas would remove the trouble but would usually abstract the larger part of the sensible heat of the gas.

It is almost impossible to secure the ignition of producer-gas in a cold chamber and with cold air. For this reason it has usually been difficult to water-smoke brick with producer-gas, and in its place wood is often used for this preliminary heating. A type of kiln in which the air is pre-heated is always desirable for the utilization of producer-gas; the effect of pre-heating is discussed in §§ 109, 112, and 113.

§ 250. *Heat losses.*

The non-cooling of the gas in traveling from the producer to the kiln is of vital importance and is ably discussed by Professor Orton (B 142): “In the producer, we perform the first reaction, burning the carbon substantially to CO. Of course there are numerous other side reactions taking place, but the gas produced

is essentially CO, and still contains locked up 10,050 B. t. u. per pound of carbon contained. We may then carry this pound of carbon in the form of producer-gas to the point where we wish to burn it, and there liberate the remaining 10,050 B. t. u. If the gas is cooled down to atmospheric temperature, it means a loss of 4450 B. t. u. out of 14,500 — a heavy proportion to pay for the advantage of producer-gas. If the producer is located a long distance from the kilns so that the gas reaches them cool, you lose substantially thirty per cent of the heat contained in the fuel. On the other hand, if the producer is located very close, you may greatly reduce the loss of the 4450 heat units given off in making the gas; a large part may remain in the gas as sensible heat, and these heat units may be carried by the gas directly into the kiln where the remaining heat units are given off when the gas meets the air. Therefore, if you are using gas hot from the producer, and throwing it into the zone of combustion with comparatively little cooling off, there is no great loss of efficiency in using coal in this form. In a gas-producer process this point should be carefully studied. The efficiency of the producer depends on using the gas from the producer at as small a distance as possible, and the utmost pains should be taken to prevent cooling down of the gas before it reaches the scene of its final combustion.”

The loss of 30 per cent mentioned in the preceding paragraph may be reduced to at least 15 per cent by the use of steam in the producer, as discussed in Chapter 8. At Mt. Savage, Maryland, where the gas is used for heating a continuous brick kiln, a unique arrangement has been worked out to reduce the sensible heat loss in the gas. “The producer is portable, and moves on wheels on a track along the side of the kiln on the side opposite to the main flue. The idea of having the producer portable is that, by being able to move it to successive chambers, the gases are still hot when they enter the kiln and ignite more readily than if conveyed through flues or pipes from a stationary producer.” (B 142.)

§ 251. *Effect of solid fuel constituents.*

This point has been discussed thoroughly by Seger (B 160). “From the very start a correct conception of the effects which the separate constituents of the gas exert has not been had, and

it has been believed that if only the ash is removed all discoloring influences are done away with also. But has really the quality of the fuel been changed by gasification? Is there not present the same quantity of steam, volatile sulphur compounds, ammonium salts, alkali vapors, and perhaps other impurities which are present when the low-grade fuel is burnt on a grate? And are not the constituents mentioned those which exert the most injurious effects owing to violent chemical reaction and hence are to be feared more than the ash? These constituents cause the difference between the flames of fossil fuels and wood. The chemical reactions of the flame, and especially the volatile impurities, exert exactly the same influence whether the low-grade and impure fuel is burnt in the form of producer-gas or by direct combustion; in fact, the effect is stronger with the gas, as has been shown by practice and of which I have convinced myself by corresponding experiments. I believe that satisfactory results will be obtained with gas-firing only when it is possible to produce gas from low-grade fuel, removing from the former the injurious constituents before introducing the gas into the kiln."

It must be understood, however, that the limitations made by Seger in the preceding paragraph are not of universal application, but are effective only where the constituents of the gas would have a deleterious effect on the quality of the *particular* ceramic product under treatment.

§ 252. *Advantages of producer-gas.*

1. With regeneration appliances, an unlimited intensity may be obtained, and the combustion of the gas is under complete control.
2. The mildness of the gas flames will insure the best results for the ceramic product under treatment, "since a mild and diffused heat is preferable to an intense local heat in the arches and decreases every course away from them."
3. "It may be produced from the cheaper grades of fuel, and makes more available heat than is possible with the costliest fuel used in the ordinary grate."
4. No more skilled labor required than with grates, the tendency being to decrease this.
5. Centralization of furnaces, thereby making it easier to handle fuel by mechanical appliances.

6. Elimination of clinking in kiln, thereby decreasing the heat losses and wear on the kiln.

7. Steady maintenance of a uniform heat.

8. More uniform burning.

9. Better combustion; this is discussed in detail by Orton (B 142). "Another source of economy lies in the fact that it is possible to approximate much more closely to the theoretical perfect combustion. To burn a pound of coal requires, as we know, about eleven pounds of air — speaking in averages —

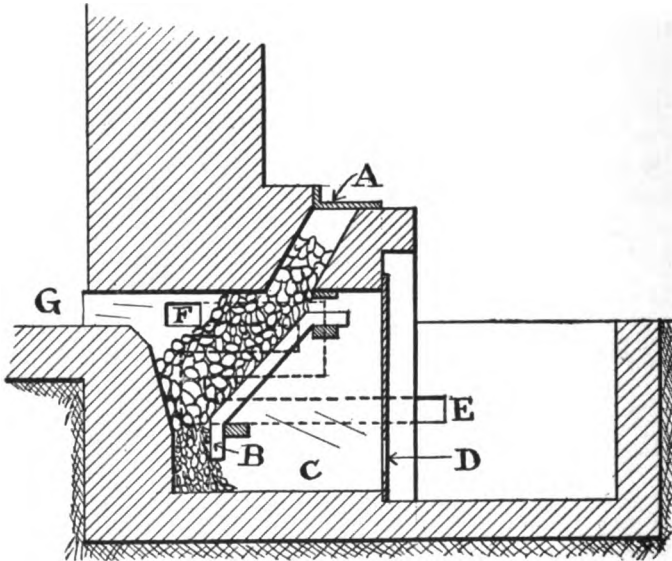

FIG. 87. — SECTION OF GAS-PRODUCER FOR KILN.

yet we often use twenty-two or thirty-three pounds, or even fifty-five pounds of air per pound of coal in actual operation. An excess of 300 per cent of the theoretical amount of air required is not uncommon."

"With the use of producer-gas, it is quite safely possible to cut down the excess of air in cases where it is the intention merely to consider the efficiency of heat production. In clay burning the chemical condition of the atmosphere is often most important, and all questions of fuel economy must be considered as secondary to this. But it is possible in the use of gas to limit

the excess of air very much more than with solid fuel, while still maintaining an oxidizing fire, and consequently there is much less heat carried out as sensible heat of the waste gases, and so economy may come in that way."

§ 253. *Types of gas-producers for ceramic work.*

The producer shown in Fig. 87 is an integral part of the kiln proper. *A* is the charging door; *B* is an inclined grate over ash

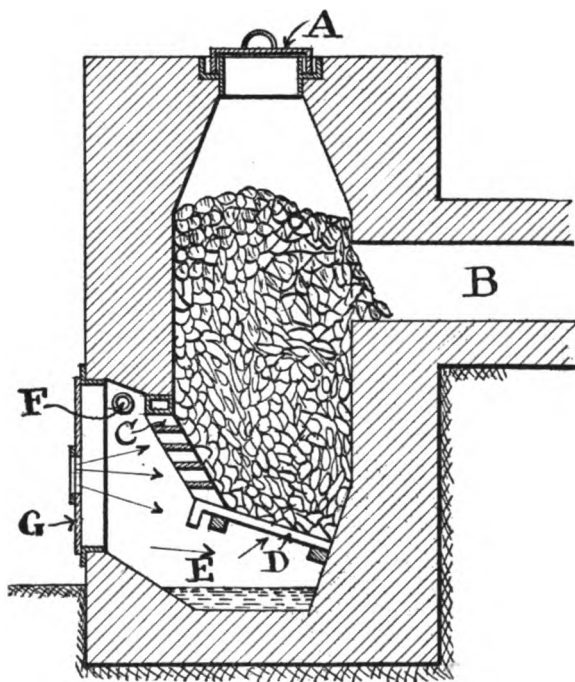

FIG. 88. — SECTION OF GAS-PRODUCER FOR KILN.

pit *C*. The air for the producer enters at *D*. The air required for the combustion of the gas enters at *E* and, in passing through the duct shown by the dotted lines, becomes pre-heated and then comes out at *F* and meets the hot gas from the producer, where combustion begins and is carried out into the chamber *G*.

The producer shown in Fig. 88 is built as a separate structure from the kiln. *A* is the charging lid, which is kept gas-tight by means of a water seal. *B* is the gas flue to combustion chamber

in kiln. *C* and *D* are grates, the former being so arranged that a poker may be inserted through the horizontal openings. *E* is the ash pit kept partially filled with water by means of pipe *F*, and *G* is the ash-pit door.

The producers shown in Fig. 89 and 90 are practically

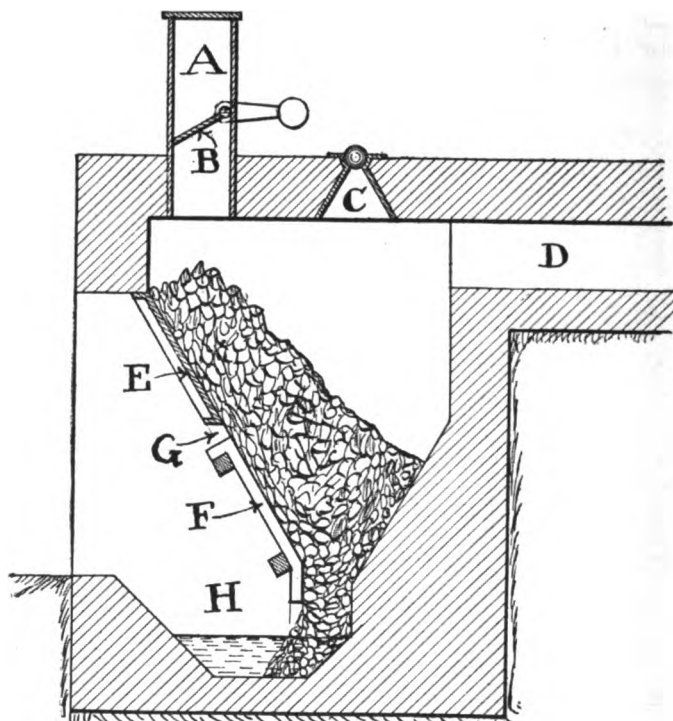

FIG. 89. — SECTION OF GAS-PRODUCER FOR KILN.

the same as the old Siemens type. Referring to the former, *A* is the charging hopper with swinging valve *B*. *C* is a poke hole with ball cover, and *D* is the gas flue to the combustion chamber of the kiln. *E* is a solid apron and *F* is a grate for supporting the fuel; the latter may be poked through the opening *G*. *H* is the ash pit partially filled with water.

The producer shown in Fig. 90 was used for firing a French continuous brick kiln. The producer shown in Fig. 91 is a German design that has been successfully used for heating a muffle

pottery kiln. *A* is the lid to the charging hopper *B*, which is fitted with swinging valve *C*. *A* is kept tight by means of a water seal. *D* is the body of the producer, the fuel resting on grates *F* and *E*, the latter being so arranged that a poker may be inserted through the horizontal openings. *G* is the ash pit, *H* are poke and inspection openings. *I* is a valve. *J* is the main air duct with port *K*, which has a grating *L*. *M* and *N* are combustion chambers. *O* is the muffle kiln. The gas from *D* comes

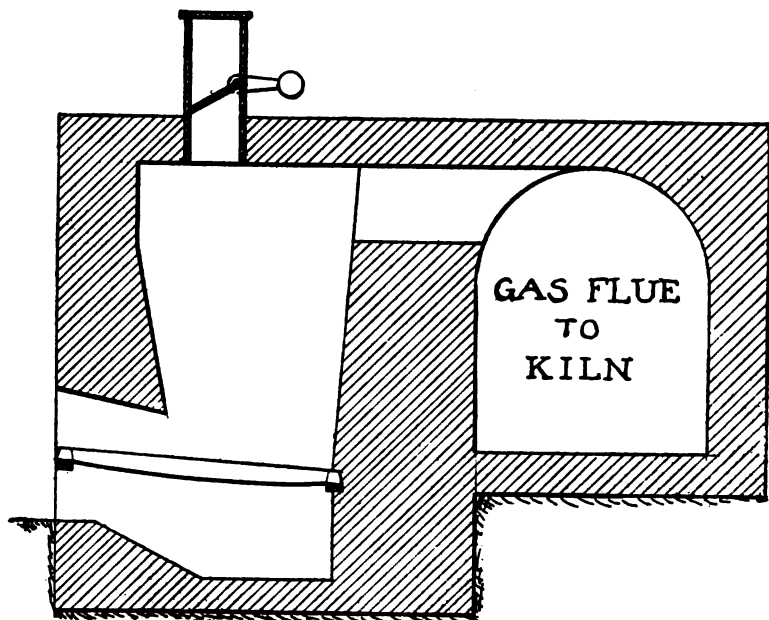

FIG. 90. — SECTION OF GAS-PRODUCER FOR KILN.

through *I* and then meets the air coming up from *K* through *L* — the object of *L* being to divide the air up into small streams; this assists in the combustion of the gas; *i.e.*, the gas can be burned with a smaller excess of air.

The producer shown in Fig. 92 is also a German design and is used in heating a continuous brick kiln. *A* is the body of the producer with charging hopper *B* and ash pit *C*; no grates are used in this, the fuel simply resting on the bottom. *D* is the gas flue to combustion chamber *G*. *E* is the main air duct and

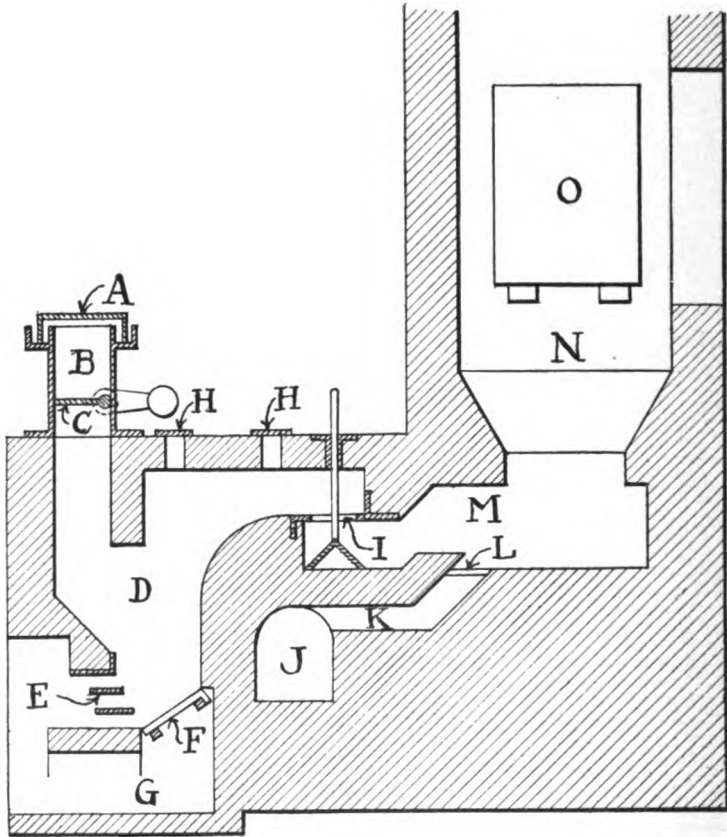

FIG. 91. — GAS-PRODUCER FOR MUFFLE KILN.

has a port *F*. The air for gasification of the fuel comes in through *C*, while the air for the combustion of the gas enters at *E* and *F*.

A Swindell gas-producer connected to a rotary cement kiln is shown in Fig. 93 and 94. This is a modified design of the producer shown in Fig. 26 and 28. *J* are air-heating pipes which

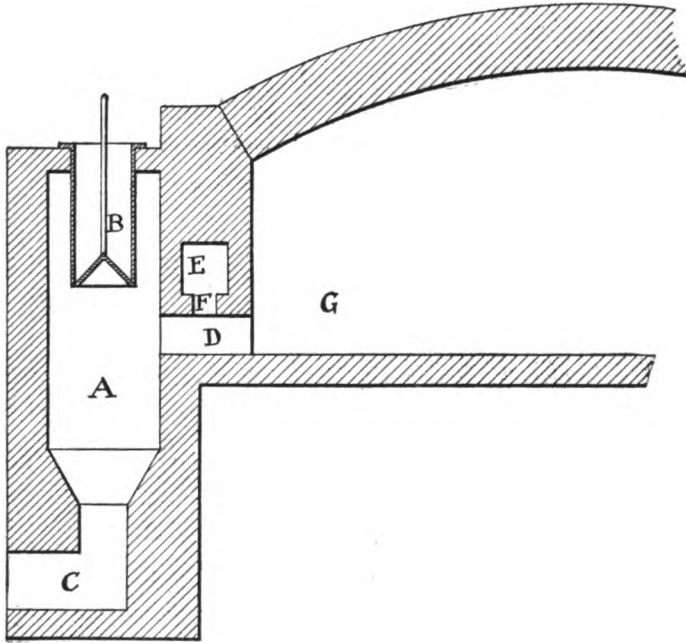

FIG. 92. — GAS-PRODUCER FOR CONTINUOUS BRICK KILN.

are connected to the circular chambers *K* and *L*. *M* are air ports which lead to the kiln *N*. Here the gas from flue *O* mixes with the pre-heated air and is burned. The pre-heating is accomplished by the heat radiated through the producer wall, which contains the pipes *J*.

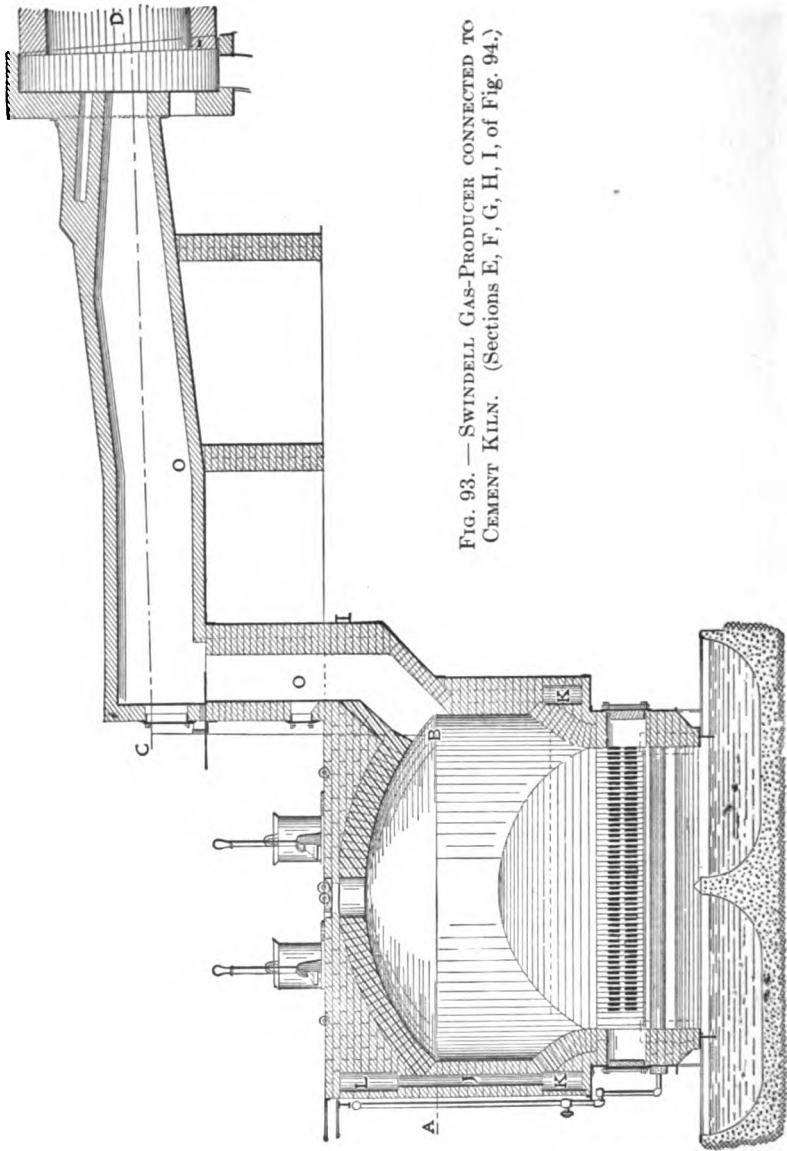

FIG. 93. — SWINELL GAS-PRODUCER CONNECTED TO CEMENT KILN. (Sections E, F, G, H, I, of Fig. 94.)

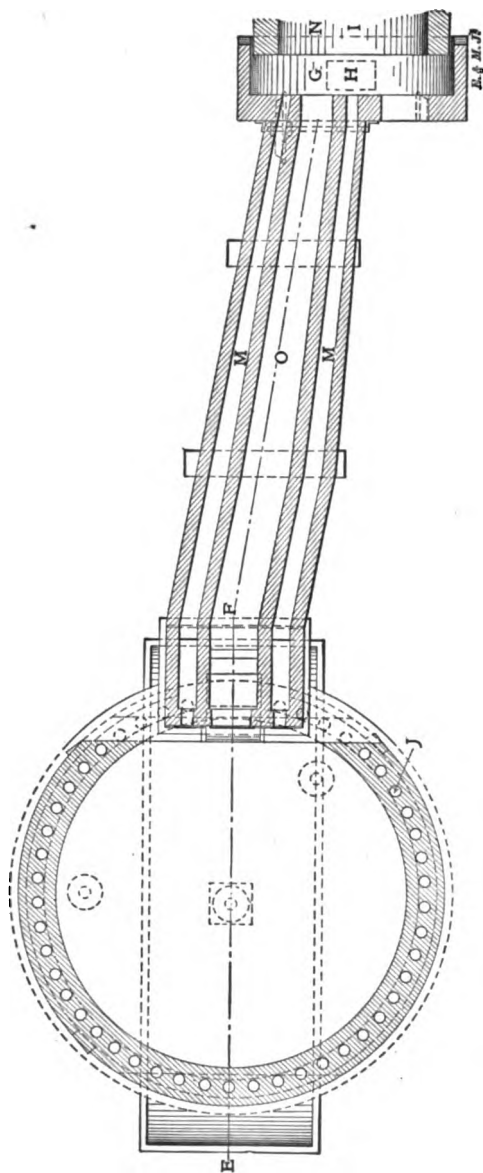

FIG. 94. — SWINDELL GAS-PRODUCER CONNECTED TO CEMENT KILN. (Sections A, B, C, D of Fig. 93.)

CHAPTER XXI.

PRODUCER-GAS FOR FIRING STEAM BOILERS.

§ 254. *Field for use.*

There are only two classes of plants where the use of producer-gas for firing steam boilers may be justified, in the light of present-day gas engine economy. First, in plants that require steam or hot water in the process of manufacture, as the soap and paper industries. Second, in existing steam plants where the change to gas power cannot be made, and yet where it is desirable to eliminate the smoke nuisance. Producer-gas will give better results than direct firing in either of the cases named, but in new plants for power generation it should be used directly in the gas engine and thus eliminate the boiler entirely.

§ 255. *Principle.*

To secure complete combustion in any furnace and with any fuel, it is imperative to have an intimate mixture of the oxygen of the air and the combustibles, and also to maintain a temperature high enough to allow the chemical reactions to take place freely. The use of any solid fuel, even in small pieces, does not permit the full realization of this requirement. Only the surfaces of the pieces of fuel can be reached by the oxygen, and even then an excess of air must be used, which results in a lowering of the temperature and decreased chemical activity and the inevitable incomplete combustion. As a result of the latter point, the heating surface of the boiler will be coated with soot, thus diminishing its evaporating power and also producing dense smoke. Further, the alternate heating and cooling of the boiler, which results from the irregular and incomplete combustion and the opening of firing doors, produces abnormal strains which decrease its life to a great extent.

The fundamental principle of the use of gaseous fuel is to secure complete combustion with a minimum air excess. This is made possible by the thorough mixture of the oxygen and the

gas during combustion, a requirement which is not feasible with any other fuel.

§ 256. *Advantages.*

1. With gas, complete combustion may be secured with practically no more than the theoretical amount of air.

2. It is much easier to maintain a maximum economy than with solid fuel.

3. Personal feelings or indifference of the firemen do not affect the operation of the boiler, and steaming is much more regular.

4. Gas-firing of boilers presents an adequate, economical, and practical solution for the smoke nuisance. The entire prevention of smoke is decidedly better than attempts to "consume" it. To prevent the formation of smoke, it is imperative that the combustion be practically complete before the gases impinge on the cold surfaces of the boiler; thus the deposition or condensation of unburned particles of carbon is prevented.

5. With gaseous fuel, the life of the boiler is much longer, due to the elimination of the excessive strains produced by alternate heating and cooling caused by hand firing.

6. Less labor is required, including the operation of the producers, since they may be charged with fuel much more easily than a steam boiler.

§ 257. *Requirements.*

It is exceedingly important to secure a thorough admixture of the gas and air before they enter the combustion chamber. In a boiler, the heating must be entirely by radiation; from this it follows that a highly radiative flame is required. As thus a luminous flame is necessary the tar must not be removed from the gas. If possible, the air for combustion should be pre-heated.

§ 258. *Results.*

In general, no economy of fuel will result by first gasifying solid fuel in a gas-producer and then burning the resulting gas under a steam boiler. The advantages to be derived from such an arrangement usually lie in other directions, and are given elsewhere. (See § 256.)

However, the results obtained by Blauvelt (B 78), and given below, are an exception. The application of producer-gas to return tubular boilers, in accordance with the principles given

in §§ 255 and 257, "resulted in the prevention of all smoke and an increase in the evaporation capacity of the boilers by over 12 per cent, as compared with the results of the same coal burned on the grate. At the same time there was a saving of about 15 per cent in the amount of fuel used."

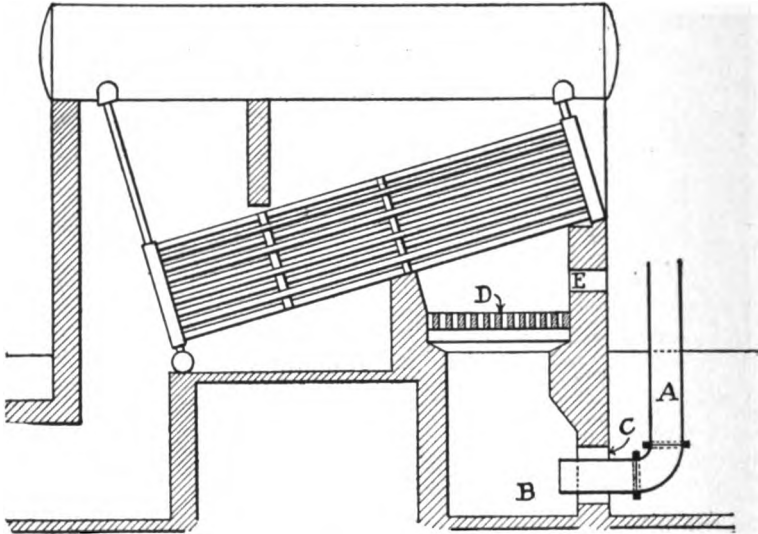

FIG. 95. — PRODUCER-GAS-FIRED WATER-TUBE BOILER.

§ 259. *Method of firing.*

There have been three general types of producers or methods used in firing steam boilers with producer-gas. The first is similar to the arrangement shown in Fig. 93 and Fig. 94, the boiler taking the place of the kiln. An English design of the second type is shown in Fig. 95. Here the producer may be at a considerable distance from the boiler, the gas being brought to the boiler by pipe *A* which delivers the gas to chamber *B*. The air for combustion enters at *C*. *D* is a perforated arch through which the gas and air pass, and in so doing they become thoroughly mixed. *E* is a door for lighting the gas. (B 106.)

A modified form of the Swindell gas-producer represents the third type. This is shown in Fig. 96. It consists of grates *A*, water-sealed ash pan *B*, steam blower *C*, and fuel door *D*. The air for the combustion of the gas is introduced through the duct

E; part of it enters the vertical port *F*, and the remainder enters at *H* through port *G*. This secures a pre-heating of the air before it meets the gas.

Of the three types, the last is the best. However, a better arrangement would be to build the producer out in front of the boiler setting, but an integral part of it, thus making it possible to feed the fuel into the producer by gravity.

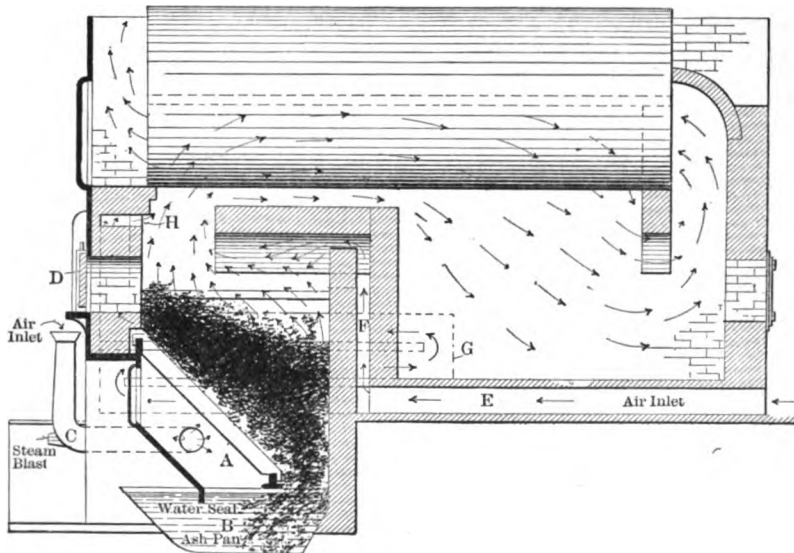

FIG. 96. — APPLICATION OF GAS-PRODUCER TO STEAM BOILERS.

CHAPTER XXII.

WOOD GAS-PRODUCERS.

§ 260. *Field for use.*

There are many places where coal is not available as a fuel and in such cases a cheap substitute must be provided. Sometimes wood is the only fuel that can be secured. Further, in some industries, large quantities of wood refuse, such as sawdust, bark, shavings, and irregular pieces of lumber, accumulate and must be disposed of. It is evident that an inexpensive system of generating power from such material is a great desideratum. There are many plants that have enough such refuse to generate all their power by means of producer-gas. The gas-producer presents a practical solution for this problem, and it will undoubtedly be used extensively in this country for such work in the future. In the past, the most extensive development has been in France and Sweden. The producers described in §§ 262 and 263 are Swedish, while those described in §§ 264 and 265 are French designs.

§ 261. *Types of producers.*

There are two general classes; the distillation type, where the wood is distilled in a closed retort, and the combustion type, which is similar to the ordinary coal-gas producer. The chemical reactions of gasification in either type are similar to those taking place when coal is used for fuel. The Loomis producer shown in Fig. 47 has been used successfully for the gasification of wood. (B 281.)

§ 262. *Lundin flat-grate gas-producer.*

This is shown in Fig. 97. *A* is a rectangular body with charging hopper *B*, flat wrought-iron grate *C*, closed ash pit *E* and blast pipe *D*. *F* is the gas condenser, the upper part of which is arranged with checkerwork of iron bars *H*. *G* are water-spray pipes, and *I* is the gas outlet. The object of the condenser is to remove the moisture, tar, and acetic acid in the gas by coal-

ing the gas and thus condensing the impurities. In other words, the gas is dried by wetting it. The water which accumulates at the bottom of *F* must be drained away continuously. As this water is saturated with impurities which will have a polluting effect on any stream into which it is discharged, care must be used in its disposal.

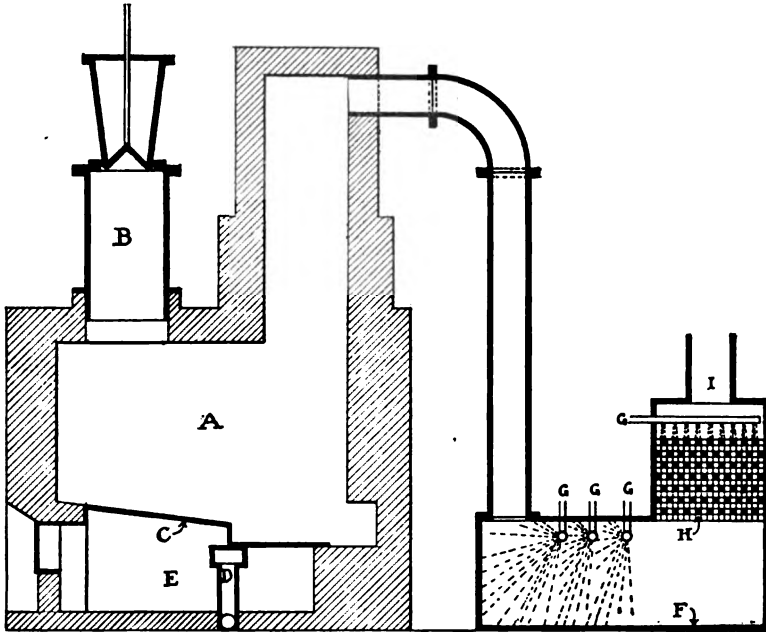

FIG. 97. — LUNDIN FLAT-GRATE GAS-PRODUCER.

§ 263. *Lundin stepped-grate gas-producer.*

The construction of this is shown in Fig. 98. It is of the blast-furnace type, and consists of a circular shaft about 20 feet high. *A* is the stepped grate over the closed ash pit *B*. The latter is supplied with blast from four pipes, two of which are shown at *C*. *D* is the body of the producer with gas exit *E* and charging hopper *F*, which is fitted with a water-sealed lid, *G*. The impurities in the gas are removed by means of a Wiman surface gas cooler, as shown in Fig. 78.

§ 264. *Riche distillation gas-producer.*

The section of this is shown in Fig. 99, while the assembly is

shown in Fig. 100. The fundamental principle of the producer is to secure the destructive distillation of the wood placed in a

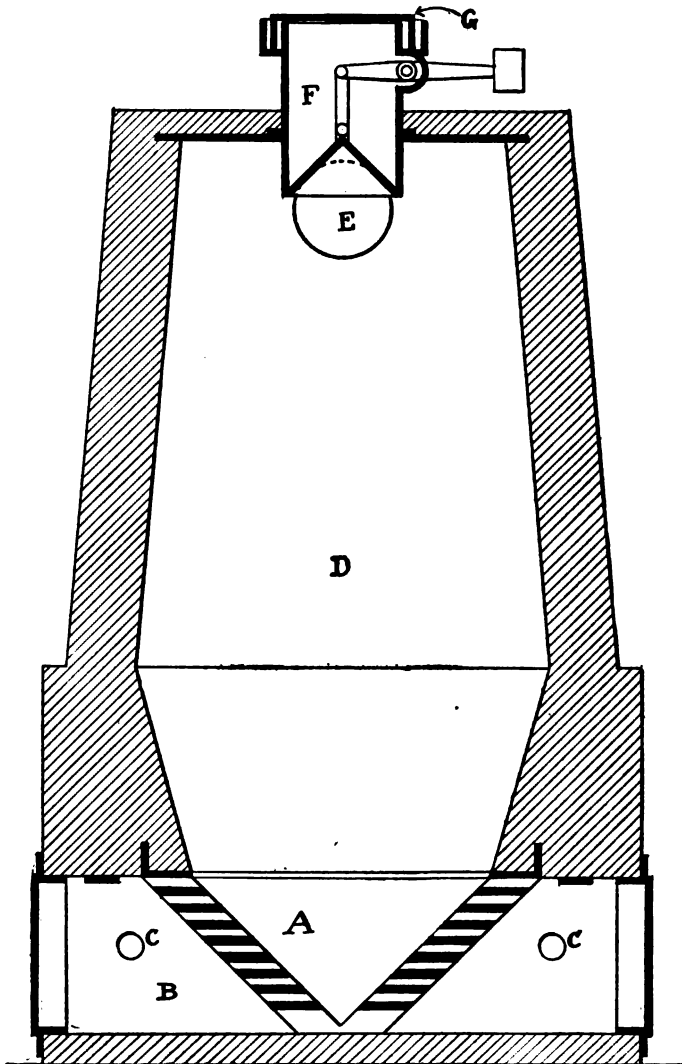

FIG. 98. — LUNDIN STEPPED-GRATE GAS-PRODUCER.

vertical, externally heated retort. Referring to Fig. 99, the fuel to be gasified is introduced into the vertical retort denoted by

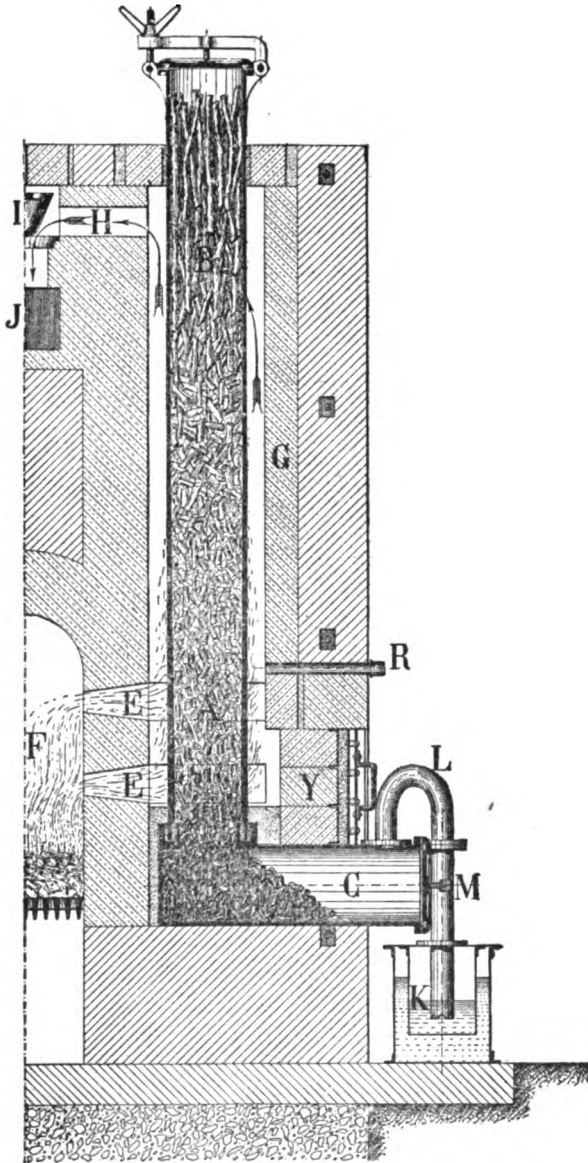

FIG. 99. — HALF SECTION OF RICHE DISTILLATION WOOD GAS-PRODUCERS.

A and *B* by means of the door placed on its top. The heating of the retort is accomplished by means of a fire in chamber *F*, the products of combustion passing through ports *E* and up around the vertical retort and out through exit ports *H*, valve *I*, and chimney flue *J*. The draft is regulated by the valve *I*. Since the combustion products first come in contact with the lower end of the vertical retort, it is evident that they will give up a large portion of their heat before they reach the exit port *H*. As a result, the lower end of the vertical retort will be much

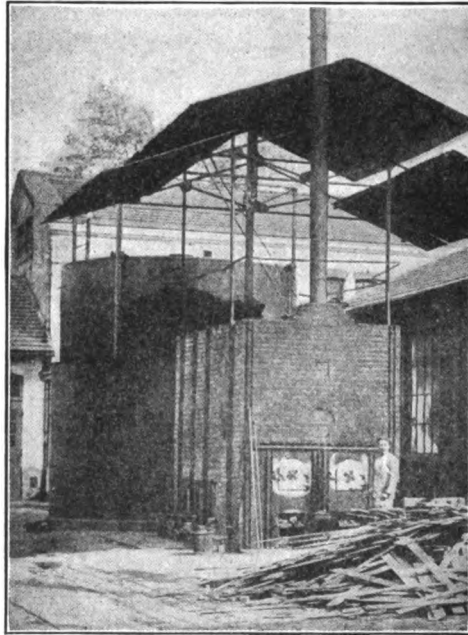

FIG. 100. — ASSEMBLY OF RICHE DISTILLATION GAS-PRODUCER.

hotter than its upper end. *R* is a peep hole covered with mica, which permits the operator to observe the temperature of the vertical retort and thereupon regulate the rate of combustion by means of valve *I*. *C* is a foot chamber for the vertical retort and is connected to it by a cemented joint composed of a special refractory cement. *Y* is made removable so as to secure access to this joint. *K* is a water seal that communicates with the gas

holder; the object of *K* is to prevent gas coming back into *C* when the retort is being charged with fresh fuel. *M* is a pipe for connecting *K* with the gooseneck *L*.

The vertical retorts are surrounded by brickwork and each one has its own combustion chamber lined with firebrick, as

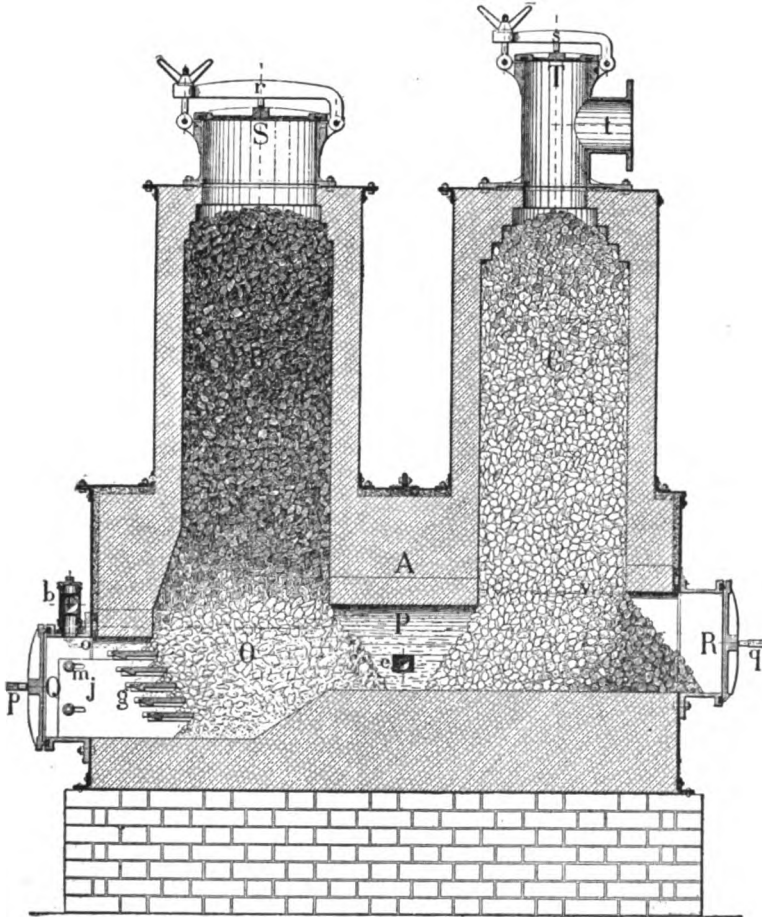

FIG. 101. — SECTION OF RICHE DOUBLE-COMBUSTION WOOD GAS-PRODUCER.

shown by *G*. One fuel chamber *F* may be made to serve a number of the retorts. The life of a retort is about eight months. The brickwork is held together by tie rods and buckstays, as shown in the illustrations.

The lower zone *A* of the vertical retort is filled with charcoal, the green wood being reduced to that form by the time it reaches *A*. All the gases and vapors given off from zone *B* must pass down through the incandescent charcoal in *A*. By so doing, the vapors are converted into fixed gases and the CO_2 reduced to CO .

§ 265. *Riche double-combustion gas-producers.*

The section of this is shown in Fig. 101 and an assembly in Fig. 102. It receives its name from the fact that it consists of

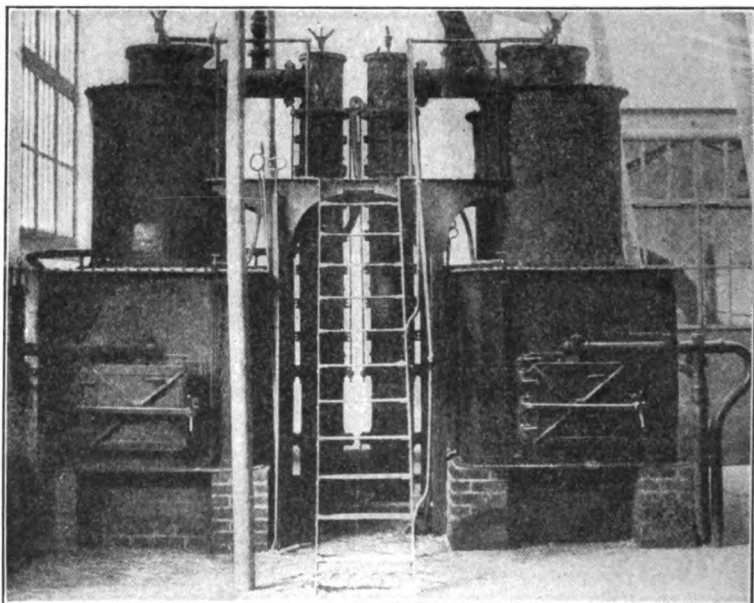

FIG. 102.—ASSEMBLY OF RICHE DOUBLE COMBUSTION WOOD GAS-PRODUCER.

two producers working together, the raw fuel being charged into one and the resulting gas passed through a mass of incandescent carbon in the other. Referring to Fig. 101, *B* is the producer that contains the raw fuel which is introduced by means of door *S* that is held in position by clamp *r*. *C* is similar to *B*, but is filled with coke or charcoal by means of door *T* which is held in position by clamp *s*. *t* is the gas exit. *R* and *Q* are cleaning doors held in position by clamps *q* and *p* respectively. *P* is a chamber connecting *B* and *C* and is surrounded by a mass

of thick masonry *A*. *o* is the ash zone of *B*. *g* are grates that are supported on frame *J*, which may be adjusted by nut *m*. By means of this adjustment the position of the grate bars may be changed. *b* is the blast inlet pipe. *o* is a pipe which delivers water on to the grates *g*. *c* is an auxiliary blast pipe.

By regulating the amount of blast admitted at *c*, it is possible to vary the intensity of combustion in *C*. This secures a regulation of the temperature of *C*, and as a result of this the amount of reduction taking place in *C* is also regulated. By this means it is possible to so adjust the producer as to reduce the amount of CO_2 to a minimum.

CHAPTER XXIII.

REMOVAL OF TAR FROM GAS.

§ 266. *Object and difficulties of removal.*

It is absolutely necessary to remove the tar from gas that is to be used in gas engines, and there are many other cases where the removal would be desirable. The use of tar-laden gas in an engine will soon cause the engine valves to stick and the ports to become closed. This is the specific objection against its presence in the gas. Since the gasification of bituminous coal will always result in the formation of tar, it is evident that the use of bituminous coal for gas power depends on the removal of the tar from the gas. The problem is a very difficult one on account of the complex nature of the tar, and in a large measure the extensive future development of the producer-gas power industry depends on its successful solution.

In other words, the problem of the use of bituminous coal for gas power is the problem of the elimination of the tar from the gas. There are now several producers on the market that are in successful use with bituminous coal for power-gas purposes.

§ 267. *Nature of tar.* (B 40.)

Tar is one of the products of the destructive distillation of fuel. It is a highly complex mixture of a large number of chemical compounds. The exact composition and nature will depend on the raw fuel constituents, temperature and pressure in, and form of, vessel in which the destructive distillation takes place. There are two principal classes of tar — First, wood tar, from the destructive distillation of wood, and second, coal tar, from the destructive distillation of coal. These tars are closely related to the petroleum, asphalt, and bitumen obtained from nature.

Tar consists of hydrocarbons, oxygenized, sulphureted, chlorinated, and nitrogenized compounds. There are nearly two hundred of these and their complexity is such that, even with the advanced knowledge and methods of technical chemical re-

search of the present day, very little is known about some of them. Many of these can be separated only by means of fractional distillation. The ordinary ones are marsh gas (CH_4), paraffine ($\text{C}_{17}\text{H}_{36}$ to $\text{C}_{27}\text{H}_{56}$), ethylene (C_2H_4), acetylene (C_2H_2), benzene (C_6H_6), naphthalene (C_{10}H_8), anthracene ($\text{C}_{14}\text{H}_{10}$), acetic acid ($\text{C}_2\text{H}_4\text{O}_2$), creosote, carbolic acid ($\text{C}_6\text{H}_6\text{O}$), hydrogen sulphate (H_2S), ammonium sulphide ($(\text{NH}_4)_2\text{S}$), sulphur dioxide (SO_2), ammonium chloride (NH_4Cl), ammonia (NH_3), and aniline ($\text{C}_6\text{H}_7\text{N}$).

Coal tar has a specific gravity of 1.1 to 1.2, is black, but sometimes has yellow streaks due to the presence of sulphur, is viscous and has a very penetrating odor. Wood tar has a strong odor, an acid taste due to the acetic acid, and may sometimes have a dark brown color.

§ 268. *Influence of temperature.*

The quality, quantity, and behavior of tar is greatly influenced by the temperature at which the decomposition of the coal takes place. High temperatures are conducive to the formation of small amounts of tar and large quantities of fixed gases, and *vice versa* for low temperatures. Tar brought in close contact with incandescent carbon is broken up into fixed gases. The cooling of tar-laden gas has a tendency to precipitate the tar.

§ 269. *Elimination of tar.*

There are three general methods for removing the tar from the gas, and they may be classified as follows:

1. Mechanical separation.
2. Washing.
 - a. Tower scrubbers.
 - b. Deflectors.
 - c. Mechanical sprays.
3. Destruction.
 - a. Inverted combustion.
 - b. Removal of gas in middle of producer.
 - c. Circulation of distillation products.
 - d. Distillation retort.
 - e. Passing gas through separate coke chamber.
 - f. Underfeeding.

Mechanical separation involves the use of rotating scrubbers, as discussed in § 223.

Washing by tower scrubbers may be used if the gas is not too heavily laden with tar. This is the method used in the Mond process, already described in § 229. The principle and method of operation of deflectors is discussed under § 219. The mechanical spray is a device for bringing the gas and tar, when the latter is in the form of a fine mist, into intimate contact and thus

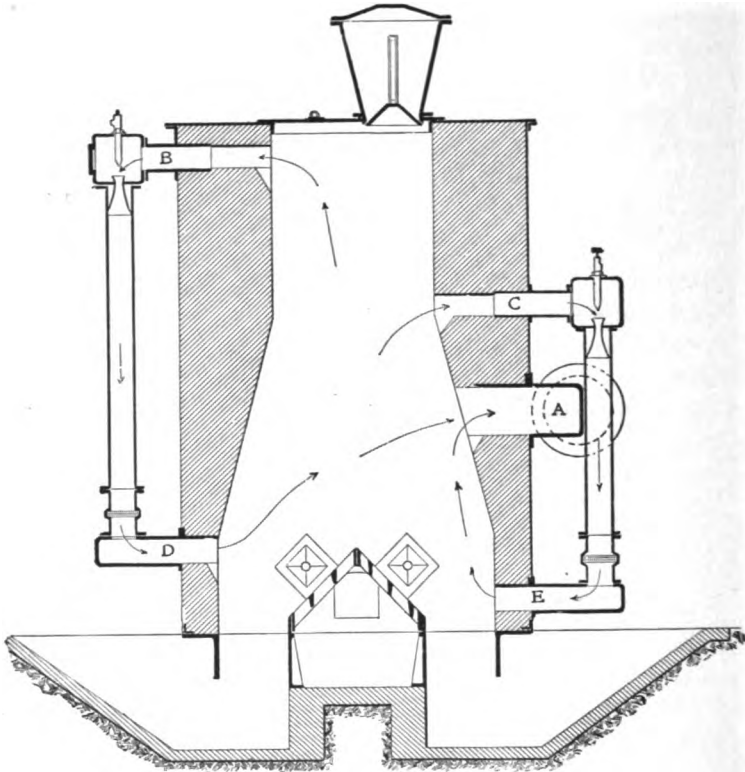

FIG. 103. — SECTION OF DUFF-WHITFIELD GAS-PRODUCER.

condense the tar into small globules which may then be more easily separated from the gas. The water must be used with considerable pressure so that the spray will be fine, in order to make it effective.

It will be observed that the two classes of eliminating devices just mentioned deal exclusively with the removal of the tar carried by the gas. Now, it is self-evident that the prevention

of a trouble is always very much better than after attempts to rectify it; therefore, the prevention of the formation of tar in the gas is preferable to any after attempt of tar removal. In other words, secure the destruction of the tar in the producer and thus eliminate the trouble of its removal from the gas. This is the fundamental idea of the destruction type of tar eliminators.

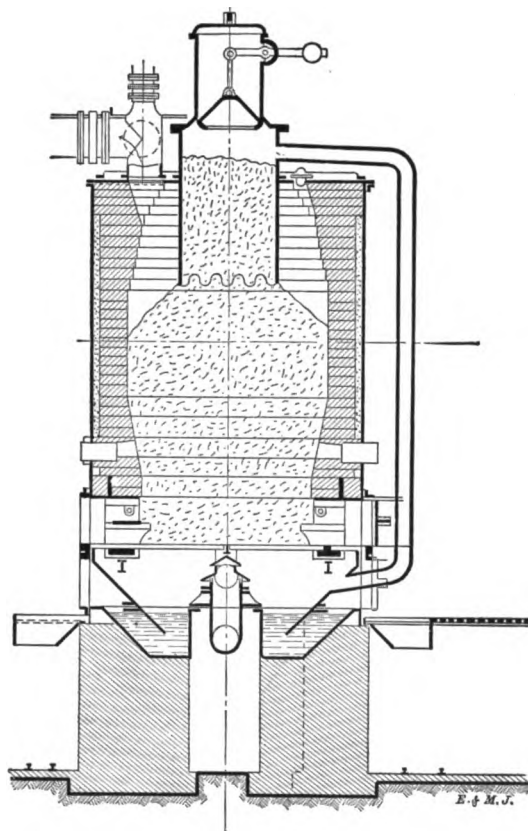

FIG. 104. — SECTION OF POETTER GAS-PRODUCER.

They all depend on the fundamental principle of bringing the tar in the distillation products into intimate contact with an incandescent mass of carbon.

The object of the inverted combustion type is to cause the products of the destructive distillation of the fresh fuel to pass

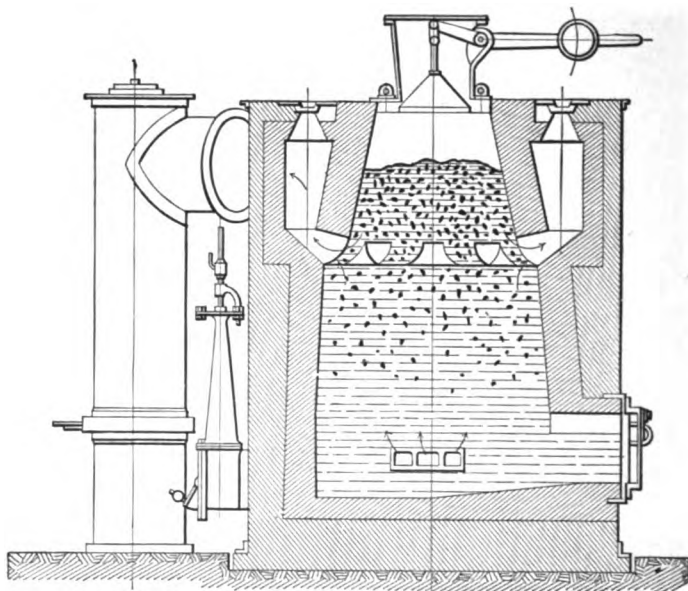

FIG. 105. — SECTION OF WILSON GAS-PRODUCER.

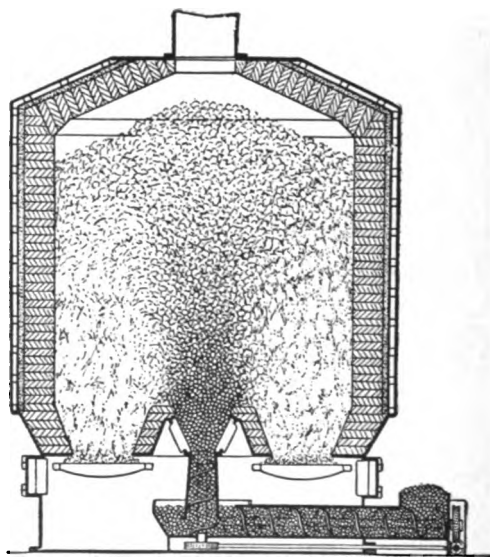

FIG. 106. — SECTION OF CAPITAINE SOFT-COAL
PRODUCER.
(Courtesy of *Engineering Magazine*.)

down and through the incandescent mass of carbon underneath and thus become converted into fixed gases. The producers shown in Fig. 14 and 47 are of this type.

The removal of the gas in the middle of the producer and the circulation of the distillation products is illustrated in Fig. 103. *A* is the main gas outlet. *B* and *C*, *D* and *E*, respectively, are outlets and inlets for the distillation products.

The distillation retort is shown applied to the Mond producer in Fig. 82, the Wilson producer in Fig. 105, and the Poetter producer in Fig. 104. In the Mond and Wilson producers the distillation products must pass down through the fuel; in the Poetter there is a pipe between the retort and the ash pit by means of which the distillation products may pass up through the fuel.

The passing of the gas through a separate coke chamber is illustrated in Fig. 14 and Fig. 101. The same idea is used in producers working in pairs — *i.e.*, where the blast goes up through one fuel bed and the resulting gas down the other. The Loomis (§ 201) may be used in this way.

The principle of underfeeding is shown in Fig. 106, the idea being that, by introducing the fresh fuel at the bottom of the fuel bed, the resulting distillation products must pass up through the incandescent fuel.

CHAPTER XXIV.

GAS-PRODUCER POWER PLANTS.

§ 270. *Status.*

The installation of the gas-producer power plant in America has been so unusual that all engineers have viewed it with interest; a large majority, however, regard it with a lack of confidence and many with positive distrust. Despite the fact that European engineers have usually been less inclined to take the initiative along experimental lines than are Americans, they have, nevertheless, developed the gas-producer plant to a very high state of efficiency, to which they were forced by the necessity of economy in fuel consumption.

The gas-producer power plant is so common in Europe that engineers as well as the general public regard it with the same degree of confidence that is now universally placed in steam plants. Gas engines, both small and large, are in general use there, and central stations, aggregating several thousand horsepower, are quite numerous.

The fact that gas-producer power plants have received so little attention in America may be attributed to five conditions: (1) Ignorance and prejudice; (2) newness of work; (3) inadaptability of gas engines; (4) fuel economy not imperative; (5) smoke nuisance not given attention.

§ 271. *Ignorance and prejudice.*

The only literature pertaining to gas-producer power plants is that found in the various technical journals and in the transactions of engineering and other technical societies. In many cases the papers are of a fragmentary character, and seldom are they complete or comprehensive. It may be that the lack of reliable data available to engineers is the cause of the ignorance and prejudice that exist concerning this important branch of engineering.

§ 272. *Newness of work.*

The manufacture of producer-gas is an old process, and gas

engines have been developed to a very high stage of mechanical efficiency, hence there is no valid reason why such installations should be regarded as experimental.

The Winchester Repeating Arms Co., at its plant in New Haven, Conn., has a Loomis-Pettibone gas-producer plant, built primarily to furnish gas for fuel purposes (such as for annealing ovens, furnaces, etc.); a 100-h.p. Westinghouse gas engine was installed some time ago, and later three direct-connected units, each of 175 h.p., have been ordered. At the present time this example is one of the best instances in America of an industrial producer-gas plant where gas is furnished both for fuel and for power.

The following list comprises some of the larger gas-producer power plants now in operation in America:

Moctezuma Copper Co., Nacozari, Sonora, Mexico. (B 281.)

The Guggenheim Exploration Co., 700 h.p., Santa Barbara, Chihuahua, Mexico.

Detroit Copper Mining Co., 1000 h.p., Morenci, Ariz.

Rockland Electric Co., 1000 h.p., Hillburn, N. Y.

Potosina Electric Co., 600 h.p., San Luis Potosi, Mexico.

Valardeña Mining and Smelting Co., 2000 h.p., Valardeña, Durango, Mexico.

The Sayles Bleacheries, 250 h.p., Sayersville, R. I.

It is obvious that much has already been accomplished in this important field of power generation.

§ 273. *Inadaptability of gas engines.*

No gas-producer power plant can be successful unless the gas engine is adapted to suit the particular gas available for its use. On the authority of Westinghouse, Church, Kerr & Co.,* an engine which will develop 100 h.p. with natural gas will give only about 80 h.p. with producer-gas — a loss of 20 per cent. With a 200-h.p. engine, this loss would be about 15 per cent, and with sizes above 300 h.p. it would be about 10 per cent. Further, in the suction type of gas-producer, about 4 per cent of the power of the engine will be consumed in drawing the gas through the producer and scrubbers. This negative work will vary with the kind of fuel, type of producer, and the frictional resistance offered by the different types of gas-cleaning apparatus. Hence the obvious necessity of using an engine adapted to the gas that

* Private communication.

is to be used therein, and of making due allowance for the negative work. Several failures have been made by neglecting this important point.

§ 274. *Fuel economy has not been imperative.*

In the list of plants just given, it will be noticed that most of them are in remote regions where the cost of fuel is high, hence the high economy of the gas-producer plant was a feature that commended itself.

§ 275. *Smoke nuisance.*

A good gas-producer, by the very nature of its construction and operation, does not allow the smoke to escape into the atmosphere; hence, the gas-producer itself presents a practical solution for the elimination of the smoke nuisance. The non-requirement of a chimney means a large saving in the first cost and in the maintenance of a power plant, and is an additional advantage in plants where the esthetic features of the design are of importance—for instance, in the case of a municipal power plant.

The laxity of the laws regarding the smoke nuisance has not made it imperative for manufacturers to give attention to the prevention of smoke. As soon as regulations concerning the smoke nuisance are enforced, the gas-producer industry will receive a new impetus on account of the easy solution that the gas-producer plant offers for this trouble.

§ 276. *Labor.*

The cost of labor required to operate a pressure gas-producer plant is about the same as that required in a steam plant of similar size. With the suction gas-producer the labor will be much less. However, during the time that a gas-producer plant is idle, it requires less attention than does a steam boiler.

In the case of a municipal pumping station, the labor required to operate the producer-gas plant would be one-half that of a similar steam plant, the gas plant being operated as follows: The gas-producers are to use coal for supplying the gas to operate a three-cylinder vertical gas engine direct connected to a triplex double-acting power pump. In this case, the usual fire engine will be dispensed with and, should a fire occur, the requisite pressure will be obtained by pumping directly into the system. For ordinary domestic supply the pump will deliver the water into a water tower, from which the mains will receive the supply

as needed. In every case the maximum quantity of water required during a fire is much larger than the average domestic consumption; hence the pump must be designed for this maximum quantity. As a result, the working of the pump at its full capacity for 6 out of 24 hours would furnish enough water for the daily domestic consumption; the pump would usually be operated from 7 to 10 A.M. and from 3 to 6 P.M. A gas holder of sufficient capacity to run the pump for 30 minutes is to be filled before the producers are closed down.

Compressed air is to be used to start the engine, which may be put into motion simply by moving a lever.

The engineer is to live adjacent to the plant so that, when an alarm is sent in to the hose company, simultaneously with alarms to the engineer's home and to the plant, it would be possible for the engineer to have the pump at work direct into the system by the time the fire company could reach the fire and make hose connections.

Since the gas holder would supply the engine until the producers could be started, the above scheme eliminates the necessity of a night fireman and the keeping up of at least 70 lb. of steam-pressure in a steam plant. A similar arrangement could be equally well adapted for fire purposes in connection with large industrial plants.

With regard to the skill required, a producer-gas power plant does not require any greater skilled labor than does a steam plant of similar size; however, in some cases, it may require time for men, trained to handle steam apparatus, to become accustomed to gas engines and gas-producers.

§ 277. *Cost of installation.*

Two well-known engineering concerns give the following data:

"The cost of gas-power plants, including gas-generating plant and gas engines, up to 500 h.p., is about 25 per cent higher than the cost of a steam plant of similar size. Large plants, from 1000 h.p. upwards, cost about the same as a first-class steam plant of similar size."*

§ 278. *Cost of repairs.*

The cost of repairs on a gas-producer plant will not exceed that of a boiler plant.

* Private communication.

§ 279. *Use of cheap fuels.*

In order that a gas-producer plant shall be commercially successful, it must be able to make, from a low-priced fuel, gas that is sufficiently clean for use in an engine. Bituminous slack is usually the lowest priced fuel to be had; however, anthracite-culm, or even wood, may be cheaper in some localities. In all cases the percentage of sulphur must be low if the gas is to be used in a gas engine. Even with the usual price of anthracite coal, coke, or charcoal, the gas-producer power plant will generate power much cheaper than a steam plant on bituminous slack. Frequently the use of a mechanically washed coal will be economical.

§ 280. *Scrubbing of gas.*

The only *uniformly* reliable way to remove tar and other hydrocarbons from gas made from soft coal is to have the producer so arranged that the gas comes in close contact with an incandescent mass of carbon. No mechanical means has yet been found to be *thoroughly* successful in removing tar, although several forms of centrifugal apparatus are in use. For the removal of fine dust particles, however, rotating scrubbers have proved very satisfactory. (See Chapters 17 and 23, and § 223.)

§ 281. *Fuel economy during hours of idleness.*

The stand-by loss of heat is very small, being limited to radiation only; a gas-producer is tightly closed during the time it is not making gas and the entrance of air is thereby prevented. This feature is a marked advantage over a steam boiler under similar conditions.

§ 282. *Time required to start producers.*

Even after a producer has been idle for several hours, it may be started and can be working at its full capacity within fifteen minutes. If a gas holder is used in connection with the producer, from which a supply of gas can be taken, the gas engine may be started instantly and kept in operation until the gas-producers are making clean gas.

§ 283. *Time required to stop producers.*

A gas-producer may be stopped instantly by simply shutting off the supply of air and steam.

§ 284. *Composition of gas.*

The gas from the gas-producer is quite uniform in composition, and in the pressure type, where it usually passes first to a holder before reaching the gas engine, it becomes thoroughly diffused, thus insuring a still greater uniformity. In the suction gas-producer, where a holder is not used, the regulation of composition must be secured as explained in § 208.

§ 285. *Thermal efficiency and economy.*

The thermal efficiency of gas-producers in good condition is generally about 80 per cent, and in some cases it is even higher than this. Since the thermal efficiency of the gas engine is very much higher than the steam engine, the aggregate efficiency of the gas-power plant will be very much larger than a steam-power plant. This is shown very clearly in Fig. 107, a part of which is made from data collected by Eyermann (B 323).

A represents an ordinary steam plant, while *B* represents a large steam plant with water-tube boilers and triple-expansion engines. *C* represents a small gas plant and *D* a large gas plant. With a suction type of producer, the boiler loss in *C* may be considerably decreased. The utilization of the waste heat in the gas-engine exhaust gases for pre-heating the air and super-heating the steam will make the boiler loss nil, and may place the thermal efficiency of the producer above 90 per cent.

Curve No. 1 shows the relation between fuel consumption per b.h.p. hour, curve No. 2 the relation between energy available in b.h.p., and curve No. 3 the relation between the water consumption per b.h.p. of the respective classes of plants. The decided advantages of the gas-power plant are so evident as not to require emphasis.

§ 286. *Automatic feeding.*

It is much easier to use an automatic feeding device on a gas-producer than on a steam boiler, because all producers are placed vertically and the fuel can be dropped into position by gravity. The use of an automatic feed always decreases labor and insures more uniformity in the composition of the gas produced.

§ 287. *Rate of gasification.*

The rate of gasification in a gas-producer is relative to the character of the coal used. The best rate determined by experience for a pressure-type producer is 12 lb. of coal per square

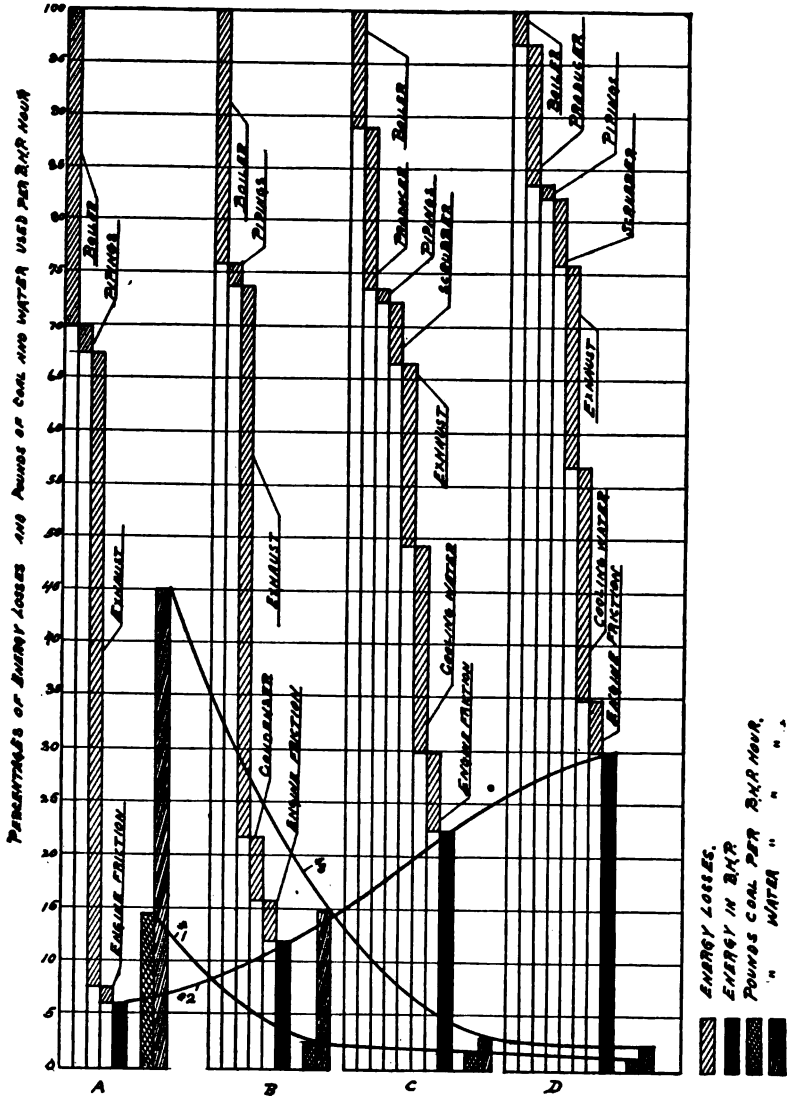

FIG. 107. — RELATIVE ECONOMIES OF STEAM AND GAS-POWER PLANTS.

foot of grate area per hour, although some makers have advised as high as 20 lb. of coal. However, the exact limit of coal consumption is not known, as it is dependent on a large number of empirical factors. Experience has also demonstrated that too rapid driving opens a wide door for the admission of adverse gasifying conditions.

§ 288. *Poking the gas-producer.*

The amount and frequency of poking a gas-producer will depend on the nature of the fuel and the *design* of the producer. The mechanical agitation of the fuel-bed eliminates poking entirely. In using bituminous coals, the difficulties of clinker formations are augmented by the production of coke. The judicious use of a steam blast, automatic feeding, and proper grates will generally reduce poking to a minimum and, in some cases, will eliminate it entirely. Hand-poking is very laborious for the attendant and usually it will be shirked whenever possible. Gas will usually escape around the poke holes while the producer is being poked, which will vitiate the air in the producer-room and also affects the regularity of the composition of the gas. Suction producers require less fuel agitation than the pressure type.

§ 289. *Calorific value of producer-gas.*

The calorific value of producer-gas varies from 125 to 150 B. t. u. per cubic foot.

§ 290. *Fuel economy.*

The generation of one brake horse-power per hour with from 1 to 1.25 lb. of coal or 3 lb. of wood is very common in producer-gas power-plant practice at the present time, and the gas contains at least 80 per cent of the heat energy resident in the fuel, if the producer is in normal condition.

§ 291. *No loss from condensation.*

A very important advantage of the producer-gas installation is that the gas does not condense or lose power on its way to the gas engine. On the contrary, the cooler the gas the better it is for the engine. With steam, the condensation loss is considerable.

§ 292. *Leakage of gas.*

It is easy to prevent leakage of gas from the piping, owing to the low pressure of the gas (about 2 in. of water); whereas, with

steam, there is often much loss and inconvenience on this account.

§ 293. *Saving in shafting.*

By using isolated engines, a large saving in shafting may be made in many cases. It is not possible to do this in steam plants and still maintain a good economy.

§ 294. *Floor space.*

The floor space required for gas holders, gas-producers, and auxiliary apparatus is about the same as that required in a steam plant; the holder, however, need not be placed adjacent to the producers, but at any other convenient place.

§ 295. *Control of operation.*

A gas-producer plant is under much better control than the average steam plant, because in the gas-producers the air-supply, rate of gasification, and fuel supply can be regulated more easily.

§ 296. *Dual use of gas.*

Another important advantage of the gas-producer power-plant is that, in many cases, the gas may be used both for power and for metallurgical purposes, the same pipes being used to supply engines and furnaces. The plant of the Winchester Repeating Arms Co., at New Haven, Conn., illustrates an installation of this character.

§ 297. *Storing of heat energy.*

One of the most potent advantages of the gas-producer plant compared with the steam plant is the ability of the former to store the heat energy in a holder where it may be drawn upon for immediate use. In this way irregularities and fluctuations of load need not affect the regularity of the action of the gas-producer. This condition means an economy of operation and convenience of use that are impossible with any steam plant, and especially in handling "peak" loads.

§ 298. *Economy of water.*

In many cases it is a serious matter to secure a sufficient supply of water for a steam plant, and sometimes, even with an adequate supply, the quality of the water is such that it is entirely unfit for use in a steam boiler. One of the most annoying difficulties of many steam plants is the trouble caused by the corro-

sion and subsequent cleansing of the boilers, together with the maintenance of feed-water purifiers.

The gas-producer power plant forms an almost ideal solution for the problem of water supply. With a producer in normal condition, the consumption of water will not exceed 2 lb. per brake horse-power hour. The water used in cooling the gases in the scrubber may be cooled in a simple tower and used repeatedly.

§ 299. *Driving isolated machines.*

There is no difficulty in piping the gas for several thousand feet in order to reach an engine that drives an isolated machine; this often makes it possible to dispense with abnormal lengths of line shafting and the consequent friction loss, or other unsatisfactory methods of power transmission. This condition is especially valuable in places where electrical power is not used.

§ 300. *Range of sizes.*

Standard gas-producers now range from a few horse-power to more than 1000 h.p. in size.

§ 301. *Danger of explosion.*

There is *much* less danger of explosion in a gas-producer than there is in connection with a steam plant; moreover, should an explosion occur, it would be much less violent and destructive than that of a steam boiler.

§ 302. *Location of producer plant.*

If desired, the gas-producer plant may be placed near the fuel supply, which, in many cases, would reduce the expense of transportation, the gas being piped to the gas engines or furnaces where it is to be used. This arrangement, which is impossible with a steam plant, means a decided saving in favor of the gas-producer installation.

The transmission of gas from a large central gas-producer plant to gas engines several miles away is a scheme that is not only practical but has many marked advantages, and may become a formidable rival of electricity in some cases. Large producer-gas plants could be operated on a very cheap fuel and, by saving the by-products, the gas could be delivered and sold with profit at a much lower price than the power from steam plants costs in many cases.

CHAPTER XXV.

OPERATION OF GAS-PRODUCERS.

§ 303. *Erection.*

This requires care, but ordinarily not as much labor as a steam plant. In the smaller sizes of power producers, the firebrick lining should be fitted in the producer at the shop before shipment; in the larger sizes this is not usually feasible and the setting of the firebrick lining must be done during erection. The firebrick should be homogeneous in structure, uniform in size, and fit very closely so as to require but little mortar. The mortar should be made of clear water and pure fire clay thoroughly mixed into a thin paste. It is not the object of the mortar to bind the firebrick together, but merely to make the joints gas-tight.

Heavy foundations are never required and many of the suction gas-producers require only a level and solid floor. All valves should be placed within easy reach of the operator.

All joints must be gas-tight before the producer is put into service. The easiest way to determine this is to build on the grate a small fire of some black smoke-producing material — such as pine knots — and force the smoke through the apparatus by means of the hand blower; if any of the joints are not tight, the black smoke will come out, and thus show the location of the leak.

§ 304. *Starting producer.*

Before starting the first fire in a new producer or in one that has been re-lined, be sure that the fire-clay mortar is thoroughly dry. The exact method of procedure will vary with the different types of producers. However, the following general rules, with special reference to suction plants, will suffice. Open the vent pipe to atmosphere and close the inlet to scrubber, so as to prevent the gases entering the latter. Some producers have an automatic arrangement, so that if the vent pipe is open the scrub-

ber inlet is closed, and *vice versa*. In such cases it is necessary to handle one valve only. Also see that the vaporizer has the proper amount of water.

To start the fire, place some kindling, oily waste or other inflammable material on the grate, then add wood and a little coal, and leave the ash-pit door open. After the fire has started nicely close all doors and begin forcing it with the blower, taking care to do this very slowly at first or else the excessive blast will kill the fire. After several minutes, add more wood and coal, filling the producer about two-thirds full, and continue the blast until it is ready for use in the engine. The blowing usually consumes about twenty minutes. The quality of the gas is judged by the color of the flame from the test cock. This should be opened and the issuing gas lighted after the producer has been blown for about ten minutes. At first the gas will burn with a blue flame, this color indicating the presence of air. The blowing must be continued until the gas burns evenly with an orange-colored flame, this color indicating the fitness of the gas for use in the engine. Then open the scrubber inlet, close the vent pipe, adjust the water spray in the scrubber and purge the latter by forcing the gas through it. A by-pass near the engine from the gas pipe to the exhaust pipe is very desirable, as then the air and gas which are being purged out of the piping between the producer and the engine may be led outdoors by means of the exhaust pipe, thus permitting the thorough purging of the piping without vitiating the atmosphere in the room.

§ 305. *Starting engine.*

The exact method of procedure will vary with the type of producer, type and size of engine, and the starting mechanism available. With regard to the latter, a supply of compressed air is the most desirable.

In order to secure a good explosive mixture, it will be necessary to adjust the quantity of air admitted, to the quality of the gas that is being used in starting. With a suction producer, the gas will usually be below the average for several minutes, or until the engine and producer have been working together long enough to induce the proper gasifying conditions in the producer. Electric ignition should be used on all producer-gas engines and, in starting, it will usually be desirable to have the

time of firing much later than is required when the engine is running at full speed.

If the engine is required to work at full load as soon as started, it will be better to have the producer filled with fuel before the engine is started, and also use the hand blower for several minutes after the engine is in operation.

§ 306. *Stopping producer.*

With the pressure type the shutting off of the steam blower, and with the suction type the stopping of the engine, is all that is necessary. If the fire is to be held in the producer, it must be kept air-tight during the hours of idleness.

§ 307. *Running producer.*

Care should be exercised in charging the producer with fuel. If coal is used, all the large lumps should be broken, and the slate and fine dust removed before the fuel is placed in the producer. The fuel bed should be kept up to its normal height at all times, and all clinkers and channels should be kept broken up. The ashes must be removed regularly so as not to keep the ash bed excessively thick. It is imperative that the charging box should be kept closed when the valve, bell, or damper connecting the box with the producer is open. If this caution is not observed, air may rush into the producer, mingle with the gas, and cause a small explosion.

The quantity of steam should be so regulated that the fire will be maintained at the proper working temperature. All valves must be kept in their proper position; if water-seals are used, they must always be supplied with water. The producer room should be amply ventilated. All joints should be tested at intervals to determine their tightness; this may be done by passing a lighted candle along the joint and watching the flame, a leakage causing a deflection of the flame.

The air furnished the producer should be clean and reasonably dry. The use of air laden with dust will increase the work of the gas scrubbers.

§ 308. *Cleaning of plant.*

To secure good results, it is imperative to keep the plant clean. The doors to the scrubbers should be opened at intervals so that the interior of the scrubber may be inspected. Whatever material is used in the scrubber for catching the dirt should be kept

clean enough to insure its efficient working. New coke should always be washed before being placed in the scrubber. If it is necessary to remove the coke from the scrubber the following precautions are important:

The cleaning should be done by two men as a safeguard against asphyxiation of either one, in case of carelessness. The room should be well ventilated and all openings to the scrubber and producer kept open for some time before cleaning is begun. In no case should lamps with exposed flames be used, on account of the danger of explosion of the mixture of air and gas. For this reason it will be preferable to do the cleaning by daylight. If the above precautions are observed there is absolutely no danger from gas-poisoning. (See Chapter 28.)

All pipes and connections should be examined at intervals to see that they are free from dust or tar. The producer must be kept free from clinkers. Whenever it is necessary to draw the fire, the firebrick lining must be allowed to cool slowly to avoid danger of fracture; and the top of the producer must be kept airtight until all the incandescent fuel has been removed, to avoid the danger of explosion.

§ 309. *Producer troubles.*

Excessive steam will increase CO_2 , H and water vapor in gas and decrease CO.

Holes in the fire are caused by excessive air blast, want of poking, or too thin a fire bed.

Oxygen in the gas is caused by air leaking in through the walls of producer.

Rapid driving and excessive blast with thin ash bed will allow air to pass up and through the fire.

High temperature of exit gases is due to insufficient supply of steam or fuel and to the ash bed being too thin.

Coal or unburned carbon in the ashes is due to an inefficient grate.

Burning of the gas is caused by channels in the fire or along the wall, which permit the air to come up through the fuel without giving up its oxygen.

Excessive CO_2 in the gas is sometimes caused by the burning of the gas.

Hanging of the fire is caused either by fusing of the clinkers to the brickwork or the non-agitation of the fuel bed.

Clinkers are usually caused by an insufficient steam supply.

The cooling of the fire may be caused by excessive steam, undue radiation, or insufficient air supply.

Producer-gas made when steam is blown in will always contain more CO₂ than does that made under similar circumstances when only air is blown in.

CHAPTER XXVI.

TESTING GAS-PRODUCERS.

§ 310. *Object of code.*

The following description of methods for conducting gas-producer tests is probably the first attempt to give the subject an analytical, thorough, and comprehensive treatment.

In some cases where tests have been made, the methods have been so unsystematic and ambiguous that it has been impossible to secure comparable results. To eliminate this difficulty, the following provisional code of gas-producer tests — which has some resemblance to the code of boiler-trials of the American Society of Mechanical Engineers — has been developed.

§ 311. *Object of test.*

The primary object in testing a gas-producer is to determine whether the producer is working satisfactorily, or, in other words, to see if the efficiency is as high as it should be with the type of producer in question, and also to find out if the composition of the resulting gas is adapted to the work it has to do.

§ 312. *Value of test.*

In order that the test shall be of any value, it must be thorough and comprehensive, and must be conducted with skill and care. When so conducted, the test will reveal the economy of the producer, and, by making suitable changes, the efficiency will often be greatly increased. As a result of the tests made by Jenkins (B 99), the efficiency was raised from 56.2 to 71.2 per cent. This shows the large saving that may frequently be made in the fuel consumption by studying the results of a careful test. The log of the test, given in Fig. 108, shows that just as soon as the temperature became regular the percentage of CO₂ decreased and that of CO increased.

§ 313. *Determination of object.*

Determine at the outset the specific object of making the test — whether it is to ascertain the capacity of the producer,

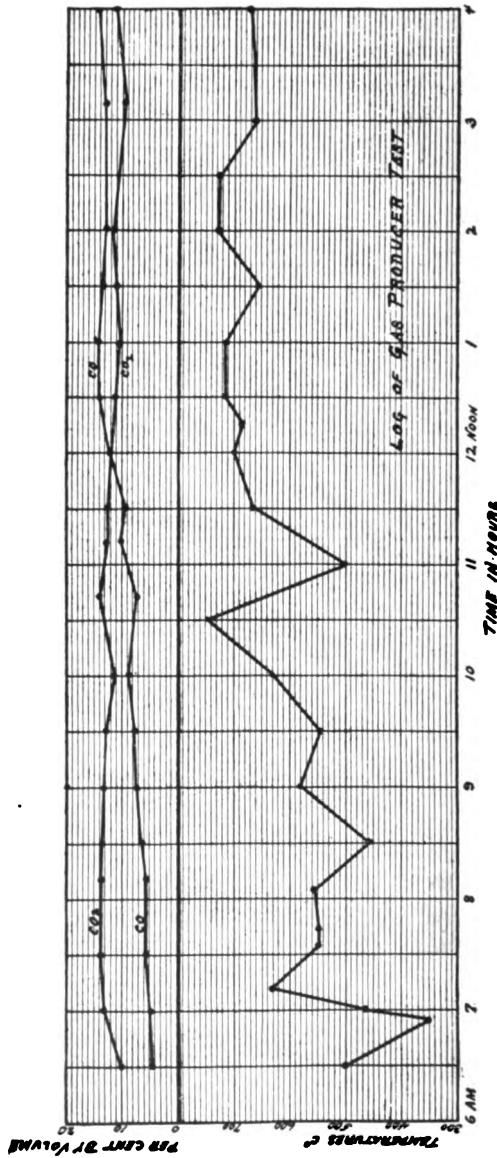

FIG. 108. — LOG of GAS-PRODUCER TEST.

its efficiency and defects, or the effect of certain changes of design, proportion, or operation, and prepare for the trial accordingly.

§ 314. *Examination of producer.*

Examine the producer in detail, ascertain the dimensions of grates and contour of inner walls, determine the angle of the bosh wall with the vertical, make a full record describing the same, and illustrate special features by sketches. If possible, secure a drawing or make one giving the general dimensions of the producer.

§ 315. *General condition of producer.*

Notice the general condition of the producer and its equipment, and record such facts in relation thereto as bear upon the objects in view. If the object of the trial is to ascertain the maximum economy of the gas-producer, the producer and all its appurtenances should be put in first-class condition. Remove clinkers from grates and from sides of the walls. Remove all dust, soot, and ashes from the chambers, gas connections, and flues. Close air leaks in the masonry and poorly fitting cleaning doors. See that all dampers will open wide and also close tight. Test for air leaks by passing the flame of a candle over cracks in the brickwork.

§ 316. *Character of fuel.*

Determine the character of the fuel to be used. For test of the efficiency or capacity of the producer in comparison with other producers, the fuel should, if possible, be of some kind which is commercially regarded as a standard.

§ 317. *Calibration of apparatus.*

Establish the correctness of all apparatus used in the test for weighing and measuring. These are:

- a. Scales for weighing coal and ashes, and water if an auxiliary boiler is used.
- b. Thermometers and pyrometers for taking temperatures; if a thermo-electric pyrometer is used, it must be calibrated with the same lengths of wire and same resistance used in taking the readings.
- c. Pressure gauges, draft gauges, etc.
- d. Apparatus used in making gas-analysis.
- e. Anemometers used in measuring air.

The kind and location of the various pieces of testing apparatus must be left to the judgment of the person conducting the test; always keep in mind the main object, *i.e.*, to obtain authentic data.

§ 318. *Auxiliary boiler.*

When an auxiliary boiler or vaporizer is used to furnish the steam for the producer, the amount of fuel it consumes must be charged against the producer. The amount of water that the boiler evaporates must also be measured.

§ 319. *Heating of producer.*

See that the producer is thoroughly heated to its usual working temperature before the trial.

§ 320. *Duration of test.*

For tests made to ascertain either the maximum economy or the minimum capacity of the producer, the duration should be at least 12 hours of continuous running, after the producer has been brought up to its *normal* working condition.

§ 321. *Starting and stopping a test.*

The conditions of the producer in all respects should be as nearly as possible the same at the end of the test as at the beginning. The fire should be the same in quantity and condition, and the walls, flues, etc., should be of the same temperature. In no case should the fires be drawn out, as is often done in boiler-tests. In producers that must be shut down for cleaning, it is advisable that the test should cover one continuous phase only.

§ 322. *Uniformity of conditions.*

Arrangements should be made to utilize the gas so that the rate of gasification may be constant during the test. Uniformity of conditions should prevail as to the pressure of steam and air blast, the thickness of fire and bed of ashes, the times of firing and quantity of coal fired at one time, frequency of poking, and the intervals between the times of cleaning the fires.

§ 323. *Keeping the records.*

Take note of every event connected with the progress of the trial, however unimportant it may appear. Record the time of every occurrence and the time of taking every weight and every observation.

§ 324. *Quantity of steam.*

When an auxiliary boiler or vaporizer is used for each producer, the amount of steam used can easily be determined from the amount of water evaporated in the boiler.

In the absence of an auxiliary boiler, proceed as follows: After the test has been made, remove the steam nozzle and calibrate it by determining the amount of steam that will pass through in a unit of time with the same pressure and percentage of moisture used during the test. Then examine the boiler that is furnishing the supply of steam, and determine as accurately as possible the quantity of coal used per hour in making the quantity and quality of steam used per hour, and charge this amount of coal to the producer.

The amount of steam may also be determined as follows: The hydrogen in the gas and water vapor must come from three sources — namely, coal, moisture in coal, and steam. As all these quantities are known except the last, it can easily be determined.

§ 325. *Quality of steam.*

The percentage of moisture in the steam should be determined near the nozzle where the steam enters the producer, by means of a throttling or separating calorimeter. The sampling nozzle should be placed in a vertical steam pipe.

§ 326. *Measurement of ashes and refuse.*

The ashes and refuse will generally be wet before they are drawn from the producer, especially if a producer of the water-seal type is used. After the test, rake out all the ashes and weigh them immediately; in the meantime set aside a sufficient sample for chemical analysis and weigh it; then let this large sample dry in the air until it reaches a constant weight, after which reduce to a laboratory sample and determine the residual moisture. The amount of incombustible material should be accurately determined, and, in this way, find the grate efficiency of the producer.

§ 327. *Sampling the fuel and determining its moisture.*

This is of great importance, since the fuel analysis is worthless unless it is made from a representative sample of the fuel. The method of the American Chemical Society, which is given here-with in substance, is to be used.

In any method of sampling, two conditions must be insisted on; the original sample should be of considerable size and thoroughly representative, and the quartering, down to an amount which can be put in a sealed jar, should be carried out as quickly as possible after the sample is taken. Unless the coal contains less than two per cent of moisture, the shipment of large samples in wooden boxes should be avoided.

In sampling from a pile, take every sixth shovelful and place the coal taken on a close, tight floor. Break all lumps larger than an orange. Mix by shoveling it over on itself, back and forth. Quarter, and reject opposite quarters. Break finer if necessary, and continue to quarter down till a sample is obtained small enough to go into a quart fruit jar, having no pieces larger than will pass a 0.5 inch mesh. Then air dry for 24 hours or more — long enough to insure that the quantity of moisture remaining will vary less than 1 per cent.

The sample may, with advantage, be run rapidly through a mill which will break it into the size mentioned. Transfer to the jar and make sure the latter is sealed air-tight before it is set aside. All of these operations should be conducted as rapidly as possible, to guard against any change in the moisture content of the coal.

In gas-producer tests, shovelfuls of coal should be taken at regular intervals and put in a tight, covered barrel, or some air-tight covered receptacle, and the latter should be placed where it is protected from the heat of the producer.

§ 328. *Calorific tests and fuel analysis.*

The method adopted by the American Chemical Society is to be used (B 351). Since this is purely a standard laboratory work, the details need not be discussed here.

§ 329. *Gas analysis.*

The gas is to be analyzed according to standard chemical methods.

§ 330. *Calorific value of gas.*

The calorific value per cubic foot should be calculated from its chemical composition (§ 53), and also determined directly by the Junker calorimeter. The two values should correspond closely.

§ 331. *Determination of water vapor, tar, and soot in gas.*

The use of the following apparatus, designed by Prof. N. W. Lord and shown in Fig. 109, is advised.

B is the sampling tube made of 0.5 in. pipe which is placed in the gas flue; *A* is an annular jacket surrounding it, and has pipe connections at *D* and *C*.

Live steam is blown in at *D*, and out at *C*, the object of this being to keep the temperature of the iron pipe *B* below the point at which the iron would act on the CO_2 . This will secure a suf-

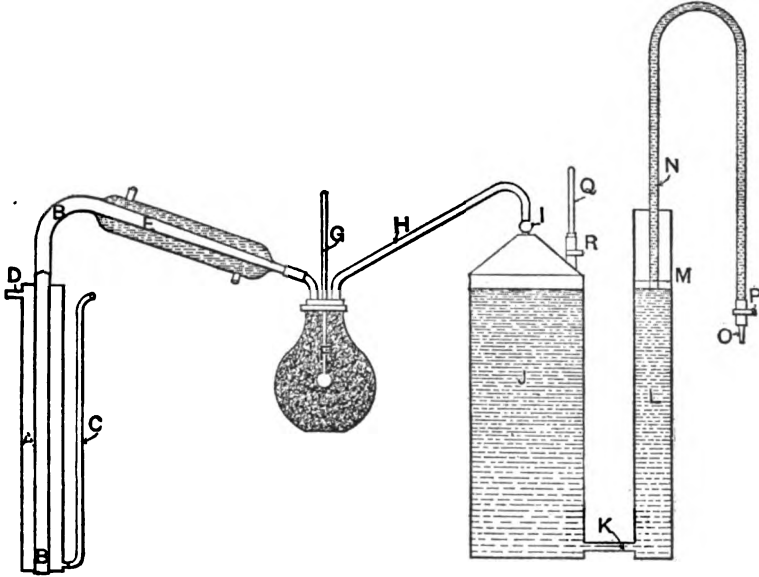

FIG. 109. — APPARATUS FOR SAMPLING GAS, DESIGNED BY PROF. N. W. LORD.

ficient cooling and yet will leave the temperature high enough to prevent the condensation of moisture.

E is an ordinary condenser through which cold water is circulated.

F is a small flask filled with ignited asbestos fiber and containing a thermometer *G*.

J and *L* are tanks filled with water and connected at *K*. *I* is a valve. *H* is a rubber tube connecting *J* and *F*. *Q* is a thermometer placed in a stopper in a pipe with valve *R*, the object

of this valve being to make it possible to remove the thermometer when gas is in the tank *J*. *M* is a float to which is fastened the curved tube *N*, which acts as a siphon and which has a small nozzle *O*, with a pinch-cock *P*, on the rubber connection. The object of the float and tube is to keep a constant head above the nozzle, and thus insure a uniform flow through it. The operation of the tank is as follows: Disconnect the rubber tube *H* and fill the tanks *J* and *L* with water until they overflow at the valve *I*; fill the siphon *N* with water and close the stop-cock *P*, attach the rubber tube *H* to stop-cock *I*, and circulate water through the condenser *E*, and steam through the water jacket *A*. Then open valve *P*; the water will be drawn out of tanks *L* and *J*, and the gas will be drawn through condenser *E*, flask *F*, and tube *H*, into the top of the tank *J*. The water in excess of the saturation of the gas at the temperature of the small flask is condensed and any tar and soot in the gas retained in the ignited asbestos in the flask. After the test, the flask and its contents are weighed, and the increase over the weight taken before the test gives the quantity of the tar and water condensed from the volume of the gas which has passed through the flask. This volume is determined by measuring the quantity of water which had run out of the aspirating tank *J*, which had been used in drawing the sample.

The quantity of water remaining in the gas, after passing out of the little flask used as a receiver, is then calculated from the temperature of the issuing gas, which was saturated with water vapor, by means of saturation table 11, p. 267. The water in the gas is then the sum of the permanent vapor and that condensed. The water in the flask is determined by drying the contents over sulphuric acid to constant weight and determining the loss. The dry contents are then ignited and the further loss of weight estimated as soot and tar.

B = barometric pressure.

Tt = temperature of gas in tank.

Tb = temperature of gas flask.

Vt = volume of wet gas in tank at temperature *Tt*.

Vs = *Vt* reduced to 0 degrees C. and 760 mm.

Vd = volume of dry gas at 0 degrees C. and 760 mm.

Bt = aqueous tension of water vapor corresponding to *Tt*.

Bb = aqueous tension of water vapor corresponding to Tb .

W = weight of 1 cubic unit of water vapor corresponding to Tb .

Wb = weight of water vapor condensed in flask.

Wt = weight of permanent water vapor in volume Vs .

$$Vs = \frac{Vt(B - Bt)}{760(1 + 0.00366 Tt)} \quad (\text{See } \S 13.)$$

$\frac{Bb}{B}$ = percentage by volume of water vapor in flask.

$\frac{Bt}{B}$ = percentage by volume of water vapor in Vs .

$$Vd = Vs \left(1 - \frac{Bt}{B}\right).$$

$Vs \frac{Bb}{B}$ = total volume of permanent water vapor in Vs .

$$Vs \frac{Bb}{B} W = Wt.$$

$Wt + Wb$ = total weight of water carried in volume, Vd , of gas.

From this, the amount of H_2O and tar and soot per pound of coal can be calculated directly.

§ 332. *Report of test.*

The data and results should be reported in the manner given in table 10. It is also recommended that the full log of the test be shown graphically by means of a chart, represented by Fig. 108.

TABLE 10.

DATA AND RESULTS OF GAS-PRODUCER TEST.

General Data.

1. Test made by
2. Test made to determine
3. Chemical analysis made by
4. Type of producer
5. Producer built by
6. Date of installation
7. Kind of fuel
8. Form of grate
9. Form of ash pit
10. Form of blower
11. State of weather
12. Barometer in producer room
13. Date of test
14. Duration of test

Dimensions of Producer.

A complete description and drawings of producer should be given on an annexed sheet.

- 15. Grate surface..... Width..... Length.....
Diameter..... Area.....
- 16. Height of bed of ashes.....
- 17. Height of top of fire above grate.....
- 18. Thickness of ash zone.....
- 19. Position of air pipes.....
- 20. Position of steam inlets.....
- 21. Diameter of producer.....
- 22. Inclination of bosh wall.....

Average Pressures.

- 23. Steam pressure near nozzle (lb. per sq. in.).....
- 24. Force of draft in ash pit (in. of water).....
- 25. Force of draft in gas flue (in. of water).....
- 26. Steam pressure in auxiliary boiler (lb. per sq. in.).....

Average Temperatures.

- 27. Of external air.....
- 28. Of producer room.....
- 29. Of steam near nozzle.....
- 30. Of air entering pre-heater.....
- 31. Of air entering producer.....
- 32. Number of degrees of pre-heating.....
- 33. Of escaping gases from producer.....
- 34. Of escaping gases from economizer.....
- 35. Of ash pit.....
- 36. Of ash zone.....
- 37. Of combustion zone.....
- 38. Of decomposition zone.....
- 39. Of distillation zone.....
- 40. Of feed-water entering auxiliary boiler.....
- 41. Of water entering jacket.....
- 42. Of water leaving jacket.....
- 43. Of water entering spray.....
- 44. Of water leaving spray.....

Fuel.

- 45. Size and condition.....
- 46. Total weight of fuel fired.....
- 47. Percentage of moisture in fuel.....
- 48. Total weight of dry fuel consumed.....
- 49. Total weight of ashes as drawn out.....
- 50. Percentage of moisture in ashes.....
- 51. Total weight of dry ashes.....
- 52. Percentage of carbon in dry ashes.....
- 53. Total combustible consumed.....
- 54. Percentage of incombustible in dry fuel.....
- 55. Total combustible consumed in auxiliary boiler.....
- 56. Total combustible required to generate the steam used in producer when the producer was used without its own auxiliary boiler.....
- 57. Total amount of combustible used in the production of the gas.....

Proximate Analysis of Fuel.

	Of Fuel Per cent.	Of Combustible. Per cent.
58. Fixed carbon,
59. Volatile matter.
60. Moisture.
61. Ash.
	100 per cent.	100 per cent.
62. Sulphur, separately determined.

Ultimate Analysis of Fuel.

	Of Fuel. Per cent.	Of Combustible. Per cent.
63. Carbon (C)
64. Hydrogen (H)
65. Oxygen (O)
66. Nitrogen (N)
67. Sulphur (S)
68. Ash
	100 per cent.	100 per cent.
Moisture in sample of fuel as received.

Analysis of Ash and Refuse.

- 69. Carbon
- 70. Earthy matter.

Consumption of Fuel.

- 71. Total fuel consumed per hour in running producer.
- 72. Total combustible consumed per hour in running producer
- 73. Dry fuel per sq. ft. of grate surface per hour consumed in producer itself

Calorific Value of Fuel.

- 74. Calorific value by oxygen calorimeter per pound of dry fuel B. t. u.
- 75. Calorific value by oxygen calorimeter per pound of combustible B. t. u.
- 76. Calorific value by analysis per pound of dry fuel. . . B. t. u.
- 77. Calorific value by analysis per pound of combustible. B. t. u.

Quality of Steam.

- 78. Percentage of moisture in steam.
- 79. Number of degrees of super-heating.

Quantity of Steam.

- 80. Apparent weight of steam per hour.
- 81. Actual weight of steam per hour.
- 82. Ratio of steam to air supply.

Quantity of Air.

- 83. Percentage of moisture in air.
- 84. Apparent weight of air per hour.
- 85. Actual weight of air per hour.

Water.

- 86. Total weight of water used in jacket.....
- 87. Number of heat units carried out per pound of fuel.....

Efficiency.

- 88. Grate efficiency of producer.....
- 89. Apparent hot-gas efficiency.....
- 90. Actual hot-gas efficiency.....
- 91. Apparent cold-gas efficiency.....
- 92. Actual cold-gas efficiency.....

Cost of Gasification.

- 93. Cost of fuel per ton delivered in producer room.....
- 94. Cost per British thermal unit in gas.....

Poking.

- 95. Method of poking.....
- 96. Frequency of poking.....

Firing.

- 97. Method of firing.....
- 98. Average intervals between firing.....
- 99. Average amount of fuel charged each time.....

Gas Analysis.

Per cent.

- 100. Carbon dioxide (CO₂).....
- 101. Carbon monoxide (CO).....
- 102. Oxygen (O) (as admixed air).....
- 103. Hydrogen (H).....
- 104. Marsh gas (CH₄).....
- 105. Olefiant gas (C₂H₄).....
- 106. Sulphur dioxide (SO₂).....
- 107. Nitrogen (N) by difference.....

100 per cent.

- 108. Pounds moisture in gas per pound of fuel.....
- 109. Pounds soot and tar in gas per pound of fuel.....
- 110. Calorific value of gas from analysis.....
- 111. Calorific value of gas determined with calorimeter.....
- 112. Specific heat of gas.....
- 113. Figure of merit of gas.....
- 114. Carbon ratio $\frac{C}{H}$
- 115. Volume of gas per pound of fuel.....

CHAPTER XXVII.

FUTURE OF THE GAS-PRODUCER.

§ 333. *Outlook.*

In Chapters 5 and 24 we have shown the many advantages of the gas-producer as a power generator; the large number now in successful operation shows that the experimental stage has been passed and that they have become a formidable competitor of the steam boiler. Gasoline-engine-driven cars are now in successful operation on the Union Pacific Railroad. Gasoline traction and portable engines and gasoline marine engines in small powers have become standard articles of commerce and are giving unusual satisfaction. The high thermal efficiency of the gas engine makes it a great desideratum as a prime mover, if a suitable fuel is available. As the storage and handling of gasoline is dangerous, and the commercial price so high as to limit its use in small sized engines and entirely prohibit its use in large sizes, a cheaper fuel is required. This demand is met in the gas-producer, and the time is not far distant when producer-gas locomotives, producer-gas portable engines, and producer-gas marine plants will be in ordinary use.

§ 334. *Producer-gas locomotives.*

Since producer-gas locomotives are —

Smokeless.

(a) The trains and stations may be kept cleaner than at present and that with less labor.

(b) Tunnels may be passed through with greater safety and less trouble.

(c) The comfort of passengers would be greatly increased, the most disagreeable feature of nearly all trains being the almost omnipresent smoke. This will be a valuable inducement to increase the passenger traffic, and will also cause a very marked increase in the earning powers of the roads equipped with smokeless locomotives.

Cinderless.

(a) The fuel economy will be increased, as the loss due to unburned coal passing out through the stack is always very high. In the trials conducted by Professor Hitchcock on freight locomotives, this loss amounted to 14 per cent of the coal fired (B 352), and on passenger locomotives the loss was 10 per cent of the coal fired (B 353).

(b) The comfort of passengers will be greatly increased and the cost of cleaning trains and stations will be decreased.

(c) The large fire losses due to sparks on property adjacent to railroads would be entirely eliminated. "Locomotives fired eighty-five buildings in Ohio last year (1904), a majority being in cities where there is great danger of conflagrations" (B 354). The annual loss from this source to farmers having crops in close proximity to railroads is enormous, and is not included in the previous quotation.

(d) The insurance rates on property adjacent to railroads would be lower.

More economical.

(a) In fuel and water. In the trials conducted by Hitchcock (B 353), the fuel consumption was about $4\frac{1}{2}$ lb. of coal per i.h.p. hour, and the water consumption was about 28 lb. per i.h.p. hour. Every-day working figures would be larger than these. According to G. R. Henderson (B 355), "The fuel bills of a railroad constitute ordinarily about 10 per cent of the total expense of operation, or from 30 to 40 per cent of the actual cost of running the locomotive. On important systems the gross amount of coal burned assumes a very large figure — running into millions of tons. On the average, each engine will probably consume \$5000 worth of coal in a year." Inasmuch as a producer-gas locomotive will develop one i.h.p. hour on 1 lb. of coal and 2 lb. of water, the remarkable economy is self-evident.

(b) In time required to take fuel and water, since the amounts required will be so very much less. This will be of vital importance in through passenger trains, as there the economy of time is imperative. As a producer-gas locomotive can run four times farther with the same amount of coal and fourteen times farther with the same amount of water than a similar steam locomotive, the marked advantages of the former are evident.

(c) In labor required to fire. The amount of fuel used per hour would be only one-fourth as large as at present; also with the gas-producer it will be very easy to arrange an automatic feeding device, thus reducing the manual labor to almost nothing. With the large steam locomotive the problem of firing is a very serious one; there is not enough room for two men, and in hot weather the intensity of the labor is such as to require a man of almost superhuman endurance.

(d) In idleness, since the stand-by losses are practically nil.

(e) In number of fuel and water stations. Only one-fourth as many of the former and one-fourteenth as many of the latter will be required. This advantage is even more marked on railroads that are compelled either to use impure water in their boilers or to install water-softening plants. In the former case, the rapid corrosion of the boiler necessitates a large amount of repair work and shortens the useful life of the boiler. Further, numerous disastrous boiler explosions, entailing large losses of life and property, have been the result of the corrosive action of impure feed waters. Where softening plants are used, the cost of installation and maintenance is always high and requires a large annual expenditure of money.

Safer.

The danger of explosion is eliminated entirely.

§ 335. *Producer-gas power plants for marine service.*

Since producer-gas marine plants are —

Smokeless.

(a) The ships may be kept much cleaner and less labor will be required in cleaning. Not only will this reduce the number of the crew, but the operating expenses also will be materially decreased.

(b) The comfort of passengers will be greatly increased and the lines operating smokeless ships will be given the preference by tourists. This alone is a valuable advertising feature that will net large profits to the owners of such vessels.

(c) A war vessel may conceal its location much more easily. The clouds of black smoke often betray the location of a steam vessel long before the vessel itself is visible. In the recent battle of the Sea of Japan, the use of smokeless vessels would have been a decided advantage to either party. The introduction of the

gas-producer will be the means of greatly augmenting the effectiveness of any navy that adopts it.

More economical.

(a) In fuel, since a producer-gas marine plant will require only about one-half the amount of fuel demanded by a similar steam plant. As the cost of fuel delivered in a vessel bunker is always high, the economy of this feature, and the ability to travel twice as far from the base of supplies with the same bunker capacity as a similar steamship, is self-evident.

(b) In water, because a marine producer-gas power-plant will require only about one-sixth of the water now used on a steam plant of the same size.

(c) In labor required in fueling; since the amount of coal required for a given number of horse-power hours is decreased 50 per cent, it is evident that the labor required in fueling will be decreased a similar amount.

(d) In bunker space, since a given bunker volume will run a gas-producer plant about twice as long as a similar steam plant.

(e) In floor and deck space. The amount of floor space required in the hold of the vessel will be less than a similar steam plant, and the elimination of the large funnels from the decks will be a desirable feature. In the words of Mr. Lewis Nixon, one of the foremost naval engineers of the day (B 222): "A gas-producer plant would greatly simplify the design of ships. The greatest problem before the ship-designer is how to handle the boiler. The production of power by steam engine gets us back at once to the man-fired boiler. We must have air and space in which to shovel, fire-rooms whose size will prevent prostration from heat, and bunkers much larger than should be necessary, on account of the waste of coal. When we get our boiler space arranged, after obtaining every concession that can be squeezed out of all other factors, we proceed to build a vessel around it."

(f) In labor. With a gas-producer installation, it will be very easy to arrange automatic feeding devices for delivering the fuel in the producers, thus eliminating the laborious hand stoking that is now required on steam plants.

(g) In auxiliary machinery, since the condensing apparatus would be dispensed with.

(h) In weight, as a gas-producer plant, including gas engines

and producers, would be about a third lighter than a similar steam plant. On a vessel of 10,000 i.h.p. this would make a difference of about 1000 tons in the displacement required. Further, the center of gravity of the gas-producer plant would be lower, thus giving the vessel greater stability.

(i) In stand-by losses, when vessel is not moving, as these would be practically nil. This is an advantageous factor in all cases and especially with boats of irregular service — as tugs.

Safer.

The danger of boiler explosion is eliminated entirely. The recent explosion on the United States gunboat *Bennington*, in which sixty-two lives were lost, should be a strong object lesson in favor of the gas-producer and the elimination of the boiler.

§ 336. *Producer-gas portable engines.*

Since producer-gas portable engines are —

Smokeless.

(a) Their use would eliminate the large fire losses to farm buildings from sparks of portable engines.

(b) The insurance rates on barns or other buildings adjacent to where an engine is used would be less.

More economical.

(a) In fuel. The average portable steam engine requires 10 lb. of coal per h.p. hour. A producer-gas portable engine requires only 1 lb. of coal per h.p. hour.

(b) In water. A producer-gas portable engine requires about 2 lb. of water per h.p. hour, while a portable steam engine requires about 30 lb. per h.p. hour.

(c) In labor, since only one-tenth as much fuel is required as in a similar steam engine and then this is fed automatically. The producer-gas engine will run for several hours without any attention at all. With the modern threshing rig equipped with automatic band cutter and feeder, two men are required to operate the rig — one to run the steam engine and one to watch the threshing machine. If a producer-gas traction engine is used in place of the usual steam engine, one man can operate both engine and thresher with ease.

(d) In time required to secure fuel and water. As only one-tenth as much of the former and one-fifteenths of the latter is

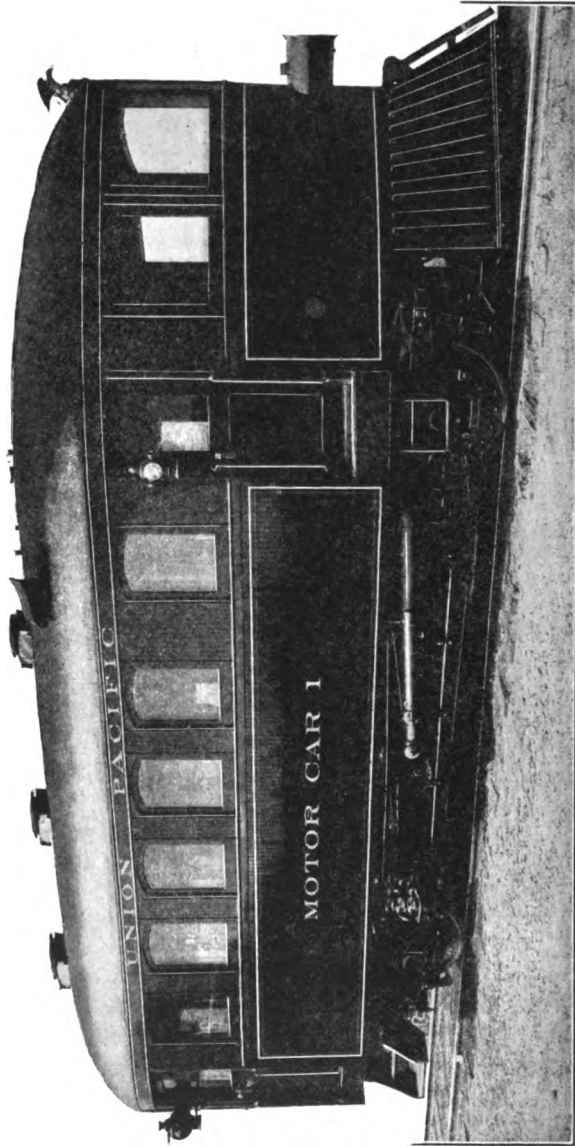

FIG. 110. — GASOLINE MOTOR CAR.

required as is used on the usual steam engine, the economy of this feature is self-evident.

Safer.

Since all danger of explosion is eliminated.

§ 337. *Future development.*

The three previous sections have shown the advantages of the gas-producer for certain lines of work. We will now briefly outline the future development of the industry. Fig. 110 shows a 100 h.p. gasoline motor car that is now in successful operation on the Union Pacific Railroad. It will be necessary to increase

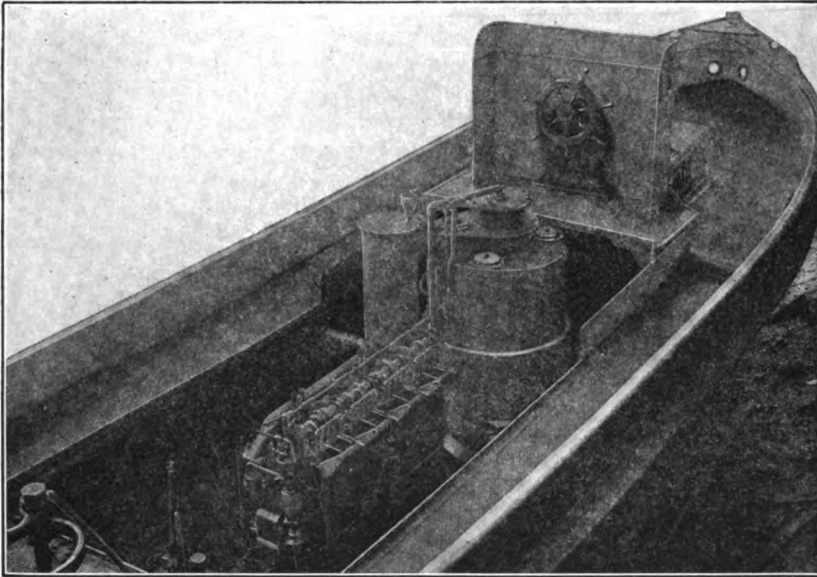

(Courtesy of *Engineering Magazine*.)

FIG. 111. — PRODUCER-GAS-ENGINE-DRIVEN TUGBOAT.

the length of the car but very little in order to secure room enough for a suction gas-producer. With gasoline at 12c. per gallon, or coal at \$5 per ton, the costs of fuel per hour will be \$1.50 for the former and 25c. for the latter. Producer-gas-engine driven motor cars will compete in many cases with electric installations, since no power station is required for the former, and at the same time a 100 h.p. producer-gas engine will give a better fuel economy than a large size steam engine. (See § 285.)

Further, the large electrical transmission and maintenance losses will be eliminated entirely. It is quite probable that the future producer-gas locomotives will be built along the general lines of the motor car shown.

Fig. 111 shows an 80 h.p. Capitaine suction gas-producer installed on a tugboat. One of the European naval boards is now seriously considering the introduction of producer-gas in connection with the rebuilding of a certain navy.* The gas-producer



FIG. 112. — HART-PARR GASOLINE TRACTION ENGINE.

has such vital advantages for naval work that a large number will be installed within a few years.

Fig. 112 shows a Hart-Parr gasoline traction engine used for plowing. It will be an easy matter to attach a suction gas-producer to such a rig; as a result of such a combination, with gasoline at 12c. per gallon or coal at \$5 per ton, the cost of operating the producer-gas engine will be about one-sixth of the operating cost with gasoline. One of the largest fields for the future development of the gas-producer is in connection with traction engines.

* Private communication.

CHAPTER XXVIII.

GAS-POISONING.

§ 338. *Danger of gas-poisoning.*

With a gas-producer plant in normal condition, there is absolutely no danger from gas-poisoning except through extreme carelessness. However, as gas is handled at a very much lower pressure than steam, and since its odor is the only usual evidence of a leak, versus the visible moisture and hissing sound of steam, gas leakage is not usually detected as soon or as easily as steam leakage. In case of poor ventilation, a small leakage of gas is much more dangerous than a large amount, since in the former case the vitiation of the atmosphere is so slow as not to be noticed until its pathological effects become manifest.

The fact that gas-producer plants are sometimes neglected and that employees may be ignorant and careless makes it very desirable to have a clear understanding of the specific effects and symptoms of gas poisoning, as well as first aid to the asphyxiated. The following discussion of these points is taken mainly from volumes 2 and 4 of T. C. Allbutt's "System of Medicine."

§ 339. *Effect of carbon monoxide.*

Carbon monoxide owes its extremely poisonous character to the fact that, when inspired, it enters into direct combination with the hemoglobin of the blood, imparting to that fluid a bright cherry-red color. It forms so stable a compound with the coloring matter of the red blood cells that they become incapable of carrying oxygen to the tissues. Inhalation of atmospheric air containing 1 to 2 per cent CO may cause not only unpleasant but very serious symptoms. The rapidity with which CO unites with hemoglobin, and the stability of the carboxyhemoglobin formed, render it a peculiarly dangerous gas. Although under these circumstances the blood has a bright cherry-red color, it is quite incapable of carrying or imparting oxygen to the tissues,

and thus, as internal respiration becomes impossible, the patient dies asphyxiated. So insidious is it in its operation and narcotizing in its action that, if respired during sleep, the sufferer quietly passes into a state of coma, which may be very profound, particularly if the gas has been breathed in small quantities and for a long time.

The quantity of CO absorbed by the blood is influenced by the amount of oxygen in the atmosphere. CO is more poisonous when air contains a diminished proportion of oxygen; and should CO be present in such an atmosphere, it may cause death with convulsions in so few seconds that the blood in certain parts of the body may contain very little carboxyhemoglobin, death having occurred too rapidly for the whole of the blood to have become saturated.

§ 340. *Symptoms of carbon monoxide poisoning.*

Poisoning by CO has frequently been confounded with that caused by CO₂. In the case of CO, the symptoms are those of a narcotic; the nervous system is gradually lulled into a sleep which ends in coma; whereas in CO₂ poisoning there is usually greater disturbance of the respiration.

The symptoms vary with the amount of CO inhaled. Usually, after experiencing a sense of discomfort with throbbing of the blood-vessels, the patient complains of severe headache, giddiness, and great debility. These may be followed by nausea and vomiting. A drowsy feeling may creep on, gradually leading to insensibility, preceded occasionally by convulsions and ending in delirium or coma. The pulse is full and bounding, respiration is accelerated and labored, the skin is dusky, the lips and extremities blue, and (in fatal cases) by degrees the patient dies asphyxiated.

Should recovery take place, convalescence is usually tardy, and its course frequently interrupted by pulmonary or nervous affections. There may be loss of memory for some time afterwards, and the lungs may be the seat of bronchitis or a low form of pneumonia.

§ 341. *Effect of carbon dioxide.*

This is not a poison in itself, but its specific effect is that it vitiates the atmosphere, which therefore will not support life on account of the absence of the proper amount of oxygen.

§ 342. *Symptoms of carbon dioxide poisoning.*

Spasmodic and convulsive breathing, dilated eyes, flushed face, swollen tongue, and a feeble pulse are the usual symptoms. The rapidity and intensity of these is dependent on the amount of CO₂ present in the atmosphere; if that is large, a state of coma succeeded by death will quickly follow the inhalation of the gas.

§ 343. *First aid to sufferer.*

The first thing to do is to remove the sufferer from the contaminated atmosphere and to send for a physician. Remove all tight clothing from about the neck and chest. If a well ventilated and moderately warm room is available, the patient should be placed therein, stripped of his clothing, and warmed by hot water bottles and hot linen cloths.

Avoid rough usage and under no circumstances hold the body up by the feet. Never allow the body to remain on the back unless the tongue is tied. This may be accomplished by drawing the tongue out and then tying a cord around it and the chin. The rhythmic traction of the tongue may be very effective if executed as follows: The tongue is drawn out quickly from the mouth and then allowed to re-enter again. To be effective, these movements must be rhythmic and repeated about fifteen times per minute. The tongue may be held with forceps or a string may be tied around the tip.

Since the carboxyhemoglobin is so stable as not to be affected by the oxygen of the atmosphere, it will be very desirable to have a supply of pure oxygen available, as this will oxidize the poisonous matter. In plants where there is danger of gas-poisoning, a portable tank of pure oxygen should be kept ready for emergencies. The tank should be provided with a tube fitted at its free end with a mask for covering the nostrils of the patient.

§ 344. *Artificial respiration.*

Place the patient on the back on an even surface, slightly inclined upward from the feet, and secure the tongue as specified in the preceding paragraph. Then, standing or kneeling at the patient's head, grasp the arms just above the elbows and draw the arms gently and steadily upwards and above the head, keeping them stretched in that position for about two seconds. Then turn the arms down and press them against the sides of the chest. Repeat these movements alternately and uniformly about fifteen

times per minute, until a spontaneous effort to respire is noticed. Then cease the mechanical respiratory movements and induce circulation and warmth.

The rhythmic traction of the tongue when worked in synchronism with the arm movements is very effective and is better than keeping the tongue tied.

Hypodermic injections of strychnine, applications of the faradaic current to the phrenic nerves, venesection and transfusion of healthy blood may sometimes be necessary. The various methods should be tried as long as there is any possible hope of life.

§ 345. *Post-mortem effects.*

The usual proof that death has been caused by carbon monoxide is the pink color of the skin, and a reddening of the face and hands, which gives the body an extraordinary appearance of life. The blood retains its bright cherry-red color for a time, but when shaken it forms a violet-colored froth.

CHAPTER XXIX.

REFERENCE DATA.

TABLE 11.

(KENT.)

Weights of Air, Vapor of Water, and Saturated Mixtures of Air and Vapor at Different Temperatures, under the Ordinary Atmospheric Pressure of 29.921 inches of Mercury.

Temperature, Fahrenheit	Weight of a Cubic Ft. of Dry Air at different Temperatures, lbs.	Elastic Force of Vapor, Inches of Mercury	MIXTURES OF AIR SATURATED WITH VAPOR				Weight of Vapor mixed with 1lb. of Air, pounds
			Elastic Force of the Air in Mix- ture of Air and Vapor Inches of Mercury	Weight of Cubic Ft. of the Mixture of Air and Vapor			
				Weight of the Air, lbs.	Weight of the Vapor, pounds	Total W'ght of Mixture, pounds	
A	B	C	D	E	F	G	H
0°	.0864	.044	29.877	.0863	.000079	.086379	.00092
12	.0842	.074	29.849	.0840	.000130	.084130	.00155
22	.0824	.118	29.803	.0821	.000202	.082302	.00245
32	.0807	.181	29.740	.0802	.000304	.080504	.00379
42	.0791	.267	29.654	.0784	.000440	.078840	.00561
52	.0776	.388	29.533	.0766	.000627	.077227	.00819
62	.0761	.556	29.365	.0747	.000881	.075581	.01179
72	.0747	.785	29.136	.0727	.001221	.073921	.01680
82	.0733	1.092	28.829	.0706	.001667	.072267	.02361
92	.0720	1.501	28.420	.0684	.002250	.070717	.03289
102	.0707	2.036	27.885	.0659	.002997	.068897	.04547
112	.0694	2.731	27.190	.0631	.003946	.067046	.06253
122	.0682	3.621	26.300	.0599	.005142	.065042	.08584
132	.0671	4.752	25.169	.0564	.006639	.063039	.11771
142	.0660	6.165	23.756	.0524	.008473	.060873	.16170
152	.0649	7.930	21.991	.0477	.010716	.058416	.22465
162	.0638	10.099	19.822	.0423	.013415	.055715	.31713
172	.0628	12.758	17.163	.0360	.016682	.052682	.46338
182	.0618	15.960	13.961	.0288	.020536	.049336	.71300
192	.0609	19.828	10.093	.0205	.025142	.045642	1.22643
202	.0600	24.450	5.471	.0109	.030545	.041445	2.80230
212	.0591	29.921	0.000	.0000	.036820	.036820	Infinite.

TABLE 12. (KENT.)
RELATIVE HUMIDITY OF AIR, PER CENT.

Dry Ther- mometer, Deg. F.	Difference between the Dry and Wet Thermometers, Degree F.																											
	1	2	3	4	5	6	7	8	9	10	11	12	13	14	15	16	17	18	19	20	21	22	23	24	26	28	30	
	Relative Humidity, Saturation being 100																											
32	90	79	69	59	50	40	31	21	12	3																		
40	92	84	76	68	60	53	45	38	30	22	16	8	1															
50	93	87	80	74	67	61	55	50	44	38	33	27	22	16	11	6	1											
60	94	89	84	78	73	68	63	58	53	48	44	39	34	30	26	22	18	14	10									
70	95	90	86	81	77	72	68	64	60	55	52	48	44	40	36	33	29	26	23	19	16	13	10					
80	96	92	87	83	79	75	72	68	64	61	57	54	51	47	44	41	38	35	32	29	26	23	20	18	13	8	3	
90	96	92	88	85	81	78	75	71	68	65	62	59	56	53	50	47	44	41	39	36	34	32	29	26	22	17	13	
100	97	93	90	86	83	80	77	74	71	68	65	62	59	57	54	51	49	47	44	42	39	37	35	33	29	25	21	
110	97	94	90	87	84	81	78	76	73	70	67	65	62	60	57	55	53	50	48	46	44	42	40	38	34	30	27	
120	97	94	91	88	85	83	80	77	75	72	70	67	65	62	60	58	56	54	51	49	47	45	44	42	38	35	31	
140	97	95	92	89	87	84	82	79	77	75	73	71	68	66	64	62	60	58	56	55	53	51	49	48	44	41	38	

TABLE 13. (FROM SUPLEE.)
COEFFICIENTS OF RADIATION.

Surface	B. t. u. per 1 degree F., per square foot, per hour
Silver, polished	.02657
Copper, polished	.03270
Tin, polished	.04395
Tinned iron, polished	.08585
Iron, sheet, polished	.0920
Iron, ordinary	.5662
Glass	.5948
Cast iron, new	.6480
Cast iron, rusted	.6868
Sawdust	.7215
Sand, fine	.7400
Water	1.0853
Oil	1.4800

TABLE 14. (FROM SUPLEE.)
RADIATION RATIOS.

Difference in temperature, Fahr. Degrees	Ratio	Difference in temperature, Fahr. Degrees	Ratio	Difference in temperature, Fahr. Degrees	Ratio
10	1.15	160	1.61	310	2.34
20	1.18	170	1.65	320	2.40
30	1.20	180	1.68	330	2.47
40	1.23	190	1.73	340	2.54
50	1.25	200	1.78	350	2.60
60	1.27	210	1.82	360	2.68
70	1.32	220	1.86	370	2.77
80	1.35	230	1.90	380	2.84
90	1.38	240	1.95	390	2.93
100	1.40	250	2.00	400	3.02
110	1.44	260	2.05	410	3.10
120	1.47	270	2.10	420	3.20
130	1.50	280	2.16	430	3.30
140	1.54	290	2.21	440	3.40
150	1.57	300	2.27	450	3.50

For use of this table see § 27.

TABLE 15.
RADIATION LOSS IN IRON PIPES.
(FROM SUPLEE.)

Mean temperature of pipes, Fahr. degrees	Units of heat (B. t. u.) emitted, per square foot, per hr. Temperature of air = 70 degrees F.				
	By convection		By radiation alone	By convection and radiation combined	
	Air still	Air moving		Air still	Air moving
80	5.04	8.40	7.43	12.47	15.83
90	11.84	19.73	15.31	27.15	35.04
100	19.53	32.55	23.47	43.00	56.02
110	27.86	46.43	31.93	57.79	78.36
120	36.66	61.10	40.82	77.48	101.92
130	45.90	76.50	50.00	95.90	126.50
140	55.51	92.52	59.63	115.14	152.15
150	65.45	109.18	69.69	135.14	178.87
160	75.68	126.13	80.19	155.87	206.32
170	86.18	143.30	91.12	177.30	234.42
180	96.93	161.55	102.50	199.43	264.05
190	107.90	179.83	114.45	222.35	294.28
200	119.13	198.55	127.00	246.13	325.55
210	130.49	217.48	139.96	270.49	357.48
220	142.20	237.00	155.27	297.47	392.27
230	153.95	256.58	169.56	323.51	426.14
240	165.90	279.83	184.58	350.48	464.41
250	178.00	296.66	200.18	378.18	496.84
260	189.90	316.50	214.36	404.26	530.86
270	202.70	337.83	233.42	436.12	571.25
280	215.30	358.85	251.21	466.51	610.06
290	228.55	380.91	267.73	496.28	648.64
300	240.85	401.41	279.12	519.97	680.53

For use of this table see § 27.

TABLE 16.
RADIATION LOSS THROUGH WALLS.
(FROM SUPLEE.)

LOSS, IN BRITISH THERMAL UNITS, PER SQUARE FOOT, PER HOUR,
FOR 1 DEGREE F. DIFFERENCE.

Thickness in inches	Brick	Stone	Thickness in inches	Brick	Stone
4	.273	.330	24	.129	.255
8	.223	.312	28	.116	.244
12	.188	.295	32	.106	.234
16	.163	.280	36	.097	.224
20	.144	.267	40	.090	.216

For use of this table see § 27.

TABLE 17.

EFFICIENCY OF PIPE COVERINGS.

(TRANS. A. S. M. E., VOL. VI, P. 168.)

Substance 1 in. thick Heat applied, 310 deg. F.	British thermal units per sq. ft. per minute	Solid matter in 1 sq. ft. 1 in. thick, parts in 1000	Air included, parts in 1000
1. Loose wool	1.35	56	944
2. Live-geese feathers	1.60	50	950
3. Loose lampblack	1.63	56	944
4. Hair felt	1.72	185	815
5. Carded cotton wool	1.73	20	980
6. Compressed lampblack	1.77	244	756
7. Cork charcoal	1.98	53	947
8. Loose calcined magnesia	2.07	23	977
9. Best slag-wool	2.17		
10. Light carbonate of magnesia	2.28	60	940
11. White-pine charcoal	2.32	119	881
12. Paper	2.33		
13. Loose fossil-meal	2.42	60	940
14. Cork strips bound on	2.43		
15. Compressed carb. of magnesia	2.57	150	850
16. Crowded fossil-meal	2.62	112	888
17. Paste of fossil-meal with hair	2.78		
18. Straw rope wound spirally	3.00		
19. Loose rice chaff	3.12		
20. Ground chalk (Paris white)	3.43	253	747
21. Loose bituminous-coal ashes	3.50		
22. Blotting-paper wound tight	3.50		
23. Asbestos paper wound tight	3.62		
24. Paste of fossil-meal with asbestos	3.67		
25. Loose anthracite-coal ashes	4.50		
26. Paste of clay and vegetable fiber	5.15		
27. Dry plaster of paris	5.15	368	632
28. Anthracite-coal powder	5.95	506	494
29. Compressed calcined magnesia	7.10	285	715
30. Air alone	8.00	0	1000
31. Fine asbestos	8.17	81	919
32. Sand	10.35	529	471

TABLE 18.

(R. D. Wood & Co.)

DISCHARGES OF GAS, IN CUBIC FEET PER HOUR, THROUGH PIPES OF VARIOUS DIAMETERS AND LENGTHS, AND AT DIFFERENT PRESSURES OF WATER, IN INCHES.

These results must be applied with care. No allowance is made in the tables for obstructions in the pipes. For every right-angle bend add $\frac{1}{8}$ inch to the pressure of water.

The use of this table may be extended by the application of the following laws:

1. The discharge of gas will be doubled when the length of the pipe is only one-fourth of any of the lengths given in the table.
2. The discharge of gas will be only one-half when the length of the pipe is four times greater than the lengths given in the table.
3. The discharge of gas is doubled by the application of four times the pressure.

SPECIFIC GRAVITY .4; SEE § 28.

Lengths of Main, in Yards	1½ IN. DIAMETER				2 IN. DIAMETER				3 IN. DIAMETER			
	PRESSURES				PRESSURES				PRESSURES			
	1.	1.5	2.	2.5	1.	1.5	2.	2.5	1.	1.5	2.	2.5
	Discharges				Discharges				Discharges			
100	588	720	832	932	1208	1480	1708	1908	3100	4075	4700	5260
150	478	598	680	759	986	1208	1394	1560	2718	3329	3840	4293
200	416	509	590	655	853	1046	1208	1350	2350	2881	3328	3718
300	351	420	478	537	697	853	984	1103	1920	2353	2714	3037
500	263	323	372	416	540	661	762	853	1488	1823	2108	2353
750	215	263	304	340	441	540	624	697	1216	1488	1718	1920
1000	186	228	264	294	381	468	540	534	1054	1289	1488	1644
1250	166	204	236	263	342	419	484	540	942	1155	1332	1354
1500	152	186	215	240	312	381	442	493	850	1052	1216	1357
1750	141	172	199	223	280	353	408	457	795	974	1130	1279
2000	132	161	186	208	270	331	381	427	744	912	1054	1176

Lengths of Main, in Yards	4 IN. DIAMETER				6 IN. DIAMETER				8 IN. DIAMETER			
	PRESSURES				PRESSURES				PRESSURES			
	1.	1.5	2.	2.5	1.	1.5	2.	2.5	1.	1.5	2.	2.5
	Discharges				Discharges				Discharges			
100	6831	8370	9658	10 800	18 820	23 050	26 600	29 770	38 650	47 350	54 640	61 100
150	5580	6830	7888	8817	15 370	18 820	21 700	24 300	31 550	38 640	44 600	49 940
200	4829	5920	6826	7674	13 310	16 400	18 800	21 000	27 340	33 460	38 600	43 200
300	3944	4829	5577	6233	10 870	13 310	15 370	17 180	22 310	27 340	31 550	35 270
500	3055	3740	4320	4829	8418	10 310	11 940	13 310	17 280	21 170	24 400	27 340
750	2420	3055	3522	3944	6872	8418	9720	10 870	14 100	17 280	19 800	22 310
1000	2160	2646	3052	3413	5950	7290	8420	9410	12 220	14 960	17 280	19 320
1250	1932	2366	2732	3052	4340	5320	7540	8415	10 940	13 650	15 520	17 280
1500	1761	2160	2490	2789	4860	5970	6860	7672	9900	12 200	14 040	15 800
1750	1634	2000	2310	2582	4500	5500	6360	7115	9237	11 300	13 040	14 600
2000	1530	1870	2150	2415	4209	5155	5970	6655	8640	10 585	12 200	13 670

TABLE 18 (concluded.)

Lengths of Main, in Yards	10 IN. DIAMETER					12 IN. DIAMETER					14 IN. DIAMETER				
	Pressures					Pressures					Pressures				
	1.	1.5	2	2.5		1.	1.5	2.	2.5		1.	1.5	2.	2.5	
	Discharges					Discharges					Discharges				
500	30 100	37 100	42 600	47 700	47 600	58 320	67 900	73 240	73 240	70 000	85 700	98 800	110 660		
750	24 650	30 180	34 800	39 900	38 880	47 600	55 000	61 710	61 710	57 160	69 900	80 800	90 352		
1000	21 640	26 180	30 100	33 750	33 060	41 200	47 000	53 240	53 240	49 507	60 620	70 000	78 300		
1500	17 400	21 300	24 700	27 850	27 800	33 600	38 680	45 515	45 515	43 600	51 600	57 000	63 300		
2000	15 050	18 900	21 900	23 850	23 600	29 250	33 000	37 620	37 620	35 600	42 600	47 000	53 350		
2500	13 075	16 180	18 632	20 850	21 190	26 100	30 116	33 631	33 631	31 300	38 380	44 280	49 500		
3000	12 027	14 961	17 008	19 016	19 440	23 800	27 800	30 740	30 740	28 580	34 980	40 400	46 170		
4000	10 413	12 786	14 729	16 468	16 850	20 600	23 800	26 620	26 620	24 760	30 310	35 000	39 180		
	16 IN. DIAMETER					20 IN. DIAMETER					24 IN. DIAMETER				
	Pressures					Pressures					Pressures				
500	98 000	120 200	138 240	154 560	170 600	204 600	241 000	270 000	270 000	271 200	326 000	375 000	425 800		
750	79 770	97 740	113 200	128 020	139 600	170 600	197 600	220 400	217 200	271 200	310 000	344 000			
1000	69 120	84 670	98 000	109 260	120 744	147 900	170 600	191 000	189 200	233 280	271 200	301 160			
1500	56 600	69 120	79 800	89 230	98 800	120 700	139 600	155 800	155 800	190 500	217 200	246 800			
2000	49 000	60 100	69 120	77 280	85 300	102 300	124 500	135 000	135 000	163 000	187 600	212 900			
2500	43 680	53 540	61 824	69 120	76 500	93 500	108 000	120 744	119 600	145 500	168 000	194 400			
3000	39 885	48 870	56 600	64 000	69 800	85 300	98 800	110 200	108 000	131 600	155 000	172 000			
4000	34 560	42 340	49 000	54 630	60 370	73 950	85 300	95 500	95 500	116 640	135 600	150 590			
	30 IN. DIAMETER					36 IN. DIAMETER					48 IN. DIAMETER				
	Pressures					Pressures					Pressures				
500	468 000	574 000	664 000	744 200	824 000	996 000	1164 000	1320 000	1320 000	1320 000	1632 000	1872 000	2112 000		
750	384 000	468 000	558 000	648 000	726 000	884 000	1032 000	1176 000	1176 000	1440 000	1656 000	1872 000			
1000	332 000	408 000	488 000	576 000	648 000	792 000	936 000	1080 000	1080 000	1320 000	1536 000	1752 000			
1500	272 000	332 760	384 140	457 600	518 400	624 000	744 000	864 000	864 000	1056 000	1248 000	1440 000			
2000	234 000	287 000	332 000	372 100	417 600	504 000	600 000	700 000	700 000	864 000	1008 000	1176 000			
2500	210 000	257 000	298 000	332 000	362 000	432 000	516 000	600 000	600 000	744 000	864 000	1008 000			
3000	192 000	234 000	270 000	308 800	338 800	408 000	492 000	576 000	576 000	700 000	816 000	936 000			
4000	166 000	203 000	234 000	268 000	298 000	352 000	420 000	492 000	492 000	600 000	700 000	816 000			

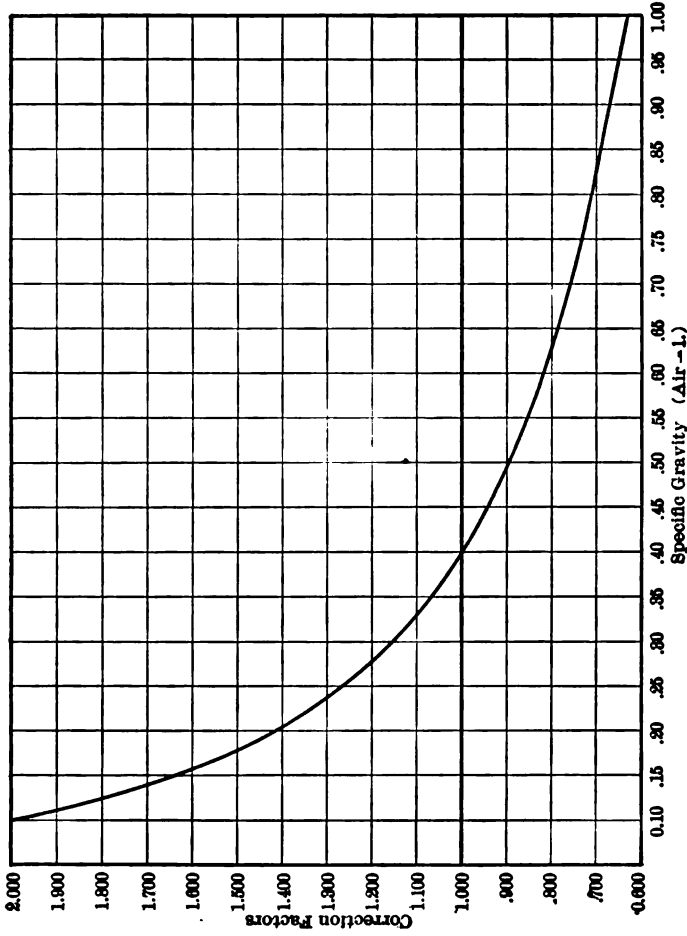

FIG. 113. — CURVE OF CORRECTION FACTORS FOR TABLE 18.
For use of this, see §28.

TABLE 19.
TABLE FOR EQUALIZING PIPE DIAMETERS.
(APPLETON'S CYCLOPEDIA OF DRAWING.)
See § 29.

Diameter of main Pipe in inches	1	1	1	1
2	5	7	2	
3	16	27	3	
4	32	57	2	4
5	56	98	3.6	1.8
6	88	16	5.7	2.8
7	129	23	8.3	4.1
8	180	32	12	5.7
9	244	42	16	7.6
10	317	56	20	9.9
11	402	71	26	12
12	501	88	32	16
13	613	107	39	19
14	737	129	47	23
15	876	152	56	27
16	1026	180	65	32
17	1197	208	76	37
18	1375	239	88	43
19	1580	275	100	49
20	1797	313	114	56
21	2284	398	145	71
22	2834	493	180	88
23	3474	605	219	108
24	4165	725	265	129
25	4963	864	315	154
26	5818	1036	371	183
27	6759	1231	433	216
28	7798	1451	501	254
29	8957	1698	576	297
30	10248	1973	660	345
31	11683	2278	753	398
32	13275	2614	856	457
33	15027	2993	970	522
34	16953	3417	1095	594
35	19068	3898	1233	674
36	21387	4438	1385	762
37	23925	5049	1552	859
38	26698	5734	1735	966
39	29722	6496	1934	1084
40	33014	7348	2150	1214
41	36591	8294	2394	1367
42	40471	9338	2667	1544
43	44671	10484	2970	1746
44	49209	11836	3304	1974
45	54104	13400	3670	2230
46	59375	15182	4070	2514
47	65042	17190	4505	2828
48	71125	19441	4977	3174
49	77654	21952	5488	3554
50	84659	24731	6040	3969
51	92161	27787	6635	4421
52	100191	31139	7266	4913
53	108771	34806	7935	5447
54	117934	38808	8644	6025
55	127703	43166	9396	6649
56	138101	47903	10193	7321
57	149161	53042	11038	8044
58	160917	58607	11934	8819
59	173404	64623	12884	9648
60	186667	71116	13890	10533

TABLE 20.

SOLUBILITY OF VARIOUS GASES IN WATER

One volume of water at 20 deg. C. absorbs the following volumes of gas reduced to 0 deg. C. and 760 mm. pressure

Name of gas	Symbol	Volumes
Carbonic oxide	CO	0.023
Carbon dioxide	CO ₂	0.901
Hydrogen	H ₂	0.019
Methane	CH ₄	0.035
Nitrogen	N	0.014
Oxygen	O ₂	0.028
Air		0.017

TABLE 21.

MELTING-POINTS OF VARIOUS METALS AND SALTS
(FROM CARNELLY MELTING- AND BOILING-POINT TABLES.)

Alphabetically		By Temperatures	
	Deg. C.		Deg. C.
Aluminum	660	Tin	233
Antimony	432	Bismuth	268
Barium chloride	860	Cadmium	320
Bismuth	268	Lead	334
Calcium fluoride	902	Antimony	432
Cadmium	320	Zinc	433
Cadmium chloride	541	Cadmium chloride	541
Copper	1095	Aluminum	660
Lead	334	Potassium chloride	734
Potassium chloride	734	Sodium chloride	772
Sodium chloride	772	Barium chloride	860
Tin	233	Calcium chloride	902
Zinc	433	Copper	1095

TABLE 22.

VARIATION IN THE VOLUMETRIC SPECIFIC HEAT OF CARBONIC ACID.
SEE § 20.

The following table was calculated by Professor Åkerman (B 67). The specific heat is in calories per cubic meter, and for each temperature the figure represents the mean value of the specific heat at constant pressure between 0 degrees C. and *t* degrees C.

	Specific heat
<i>t</i> 400467
<i>t</i> 500487
<i>t</i> 600507
<i>t</i> 700525
<i>t</i> 800544
<i>t</i> 900562
<i>t</i> 1000580
<i>t</i> 1100598
<i>t</i> 1200615

FUEL DATA.

COAL.

A bushel of bituminous coal weighs 76 pounds (Pennsylvania) and contains 1.554 cubic feet; in Ohio and West Virginia the weight is 80 lb.

41 to 45 cubic feet bituminous coal = 1 ton, 2240 lb.

34 to 41 cubic feet anthracite coal = 1 ton, 2240 lb.

CHARCOAL.

A bushel of charcoal weighs 20 lb. and contains 2748 cu. in.
123 cubic feet charcoal = 1 ton, 2240 lb.

COKE.

A bushel of coke weighs 40 lb.

70.9 cubic feet coke = 1 ton, 2240 lb.

WOOD.

2½ lb. of dry wood = 1 lb. of coal.

COMPOSITION OF WOOD.

Average	Oak, 120 yrs.	Birch, 60 yrs.	Willow
Carbon 50	50.97	50.59	51.25
Hydrogen 6	6.02	6.21	6.19
Oxygen 41	41.96	42.16	41.98
Nitrogen 2	1.27	1.01	.98
Ash 2	1.93	2.1	3.67

The calorific value of dry wood is about 7000 B. t. u. and of air-dried wood about 5600 B. t. u.

The calorific intensity is very low.

Ordinary firewood contains, by analysis, from 27 to 80 per cent of hygrometric moisture.

1 cord of hickory or maple weighs 4500 lb.

1 cord of white oak weighs 3850 lb.

1 cord of beech, red oak, or black oak weighs 3250 lb.

1 cord of poplar, chestnut, or elm weighs 2350 lb.

1 cord of average pine weighs 2000 lb.

A cord of wood = $4 \times 4 \times 8 = 128$ cu. ft. = about 56 per cent solid wood and 44 per cent interstitial spaces.

CHAPTER XXX.

BIBLIOGRAPHY OF GAS-PRODUCERS.

The following abbreviations have been used in the text:

- A. d. mines*, *Annales des mines*.
Cassier's, *Cassier's Magazine*.
Eng. and Min. Jour., *The Engineering and Mining Journal*.
Eng. Lond., *The Engineer* (London).
Eng. Mag., *Engineering Magazine*.
Eng. News, *Engineering News*.
Eng. Rec., *Engineering Record*.
Engng., *Engineering*.
Engr., *The Engineer* (Chicago).
Gasmt., *Die Gasmotorentechnik*.
I. C. T. R., *Iron and Coal Trades Review*.
Iron S. M., *Iron and Steel Magazine*.
J. I. and S. I., *Journal of the Iron and Steel Institute*.
Jour. F. I., *Journal of the Franklin Institute*.
Jour. Assn. Eng. Soc., *Journal of the Association of Engineering Societies*.
J. S. C. I., *Journal Society Chemical Industry*.
Mar. Eng., *Marine Engineering*.
Mem. Soc. Ing. Civ., *Memoires de la Société des Ingenieurs Civils*, France.
N. B. M. A. National Brick Manufacturers Association report.
Prac. Eng., *Practical Engineer* (London).
Proc. Eng. Soc. of W. Pa., *Proceedings of the Engineers' Society of Western Pennsylvania*.
Proc. I. C. E., *Proceedings of the Institute of Civil Engineers*.
Proc. I. M. E., *Proceedings of the Institution of Mechanical Engineers*.
Sci. Am., *Scientific American*.
Sci. Am. Sup., *Scientific American Supplement*.
Trans. A. I. M. E., *Transactions of the American Institute Mining Engineers*.
Trans. A. C. S., *Transactions American Ceramic Society*.
Trans. A. S. M. E., *Transactions American Society Mechanical Engineers*.
Zeitschr. d. V. D. Ing., *Zeitschrift des Vereines Deutscher Ingenieure*.

CHRONOLOGICAL ARRANGEMENT.

1841.

- B 1. *A. d. mines*, Vol. IV, p. 436. Reference to the value of the use of steam in gas-producers.
B 2. *A. d. mines*, Vol. XX, p. 463. Illustration of Ebelfmen gas-producer.

1843.

- B 3. *A. d. mines*, Vol. III, p. 210. Illustration of Ebelfmen gas-producer.
B 4. *A. d. mines*, Vol. III, p. 222. Illustration of Ebelfmen gas-producer.
B 5. *A. d. mines*, Vol. III, p. 225 and 258. Discussion of the effect of steam in gas-producers.

1857.

- B 6. *Proc. I. M. E.*, p. 103. Discussion of a gas furnace for the development of intense heat.

278 A TREATISE ON PRODUCER-GAS AND GAS-PRODUCERS.

1862.

- B 7. *Proc. I. M. E.*, p. 21. Discussion of regenerative furnaces.

1866.

- B 8. *Mem. Soc. Ing. Civ.*, France, p. 585. Complete description of the Beaufume producer.

- B 9. *Transactions of the Institute of Engineers in Scotland*, Vol. I, p. 14. General description of the Beaufume producer.

1868.

- B 10. *Journal of the Chemical Society (London)*, Vol. XXII, p. 293. Discussion of the Siemens producer.

1869.

- B 11. *Manufacture of Iron and Steel*, by F. Kohn, p. 132. Discussion and illustration of the Siemens gas-producer.

1872.

- B 12. *Proc. I. M. E.*, p. 97. Extensive discussion of steam jets and blowers; gives several illustrations.

1874.

- B 13. *Mem. Soc. Ing. Civ. France*, p. 678. Results obtained with Ebelmen's producer.

1875.

- B 14. *Percy's Metallurgy*, volume on Fuel, p. 532. Discusses gaseous fuel.

- B 15. *Percy's Metallurgy*, volume on Fuel, p. 517. Description of Ekman and Wedding producers.

- B 16. *Percy's Metallurgy*, volume on Iron and Steel, p. 463. Discussion of waste heat.

1878.

- B 17. *Etudes sur les Combustibles*, by M. Lencauchez. Extensive treatise devoted to the gasification of fuel and the applications of fuel gas. Gives plates with exceptionally good illustrations.

1879.

- B 18. *Combustion of Coal*, by W. M. Barr, p. 128. Discusses the pre-heating of air.

- B 19. *Fuel, its Combustion and Economy*, by Clark, p. 282. Discusses gas furnaces and gas-producers, decomposition of fuel in gas-producers, and gives summary of results obtained by Ebelmen.

1880.

- B 20. *Trans. A. I. M. E.*, Vol. VIII, p. 27. General description, with good illustration of the Tessié producer.

- B 21. *Trans. A. I. M. E.*, Vol. VIII, p. 289. Discussion of the Strong gas system.

- B 22. *Treatise on Fuel*, by R. Galloway, p. 86. Description of Siemens gas-producer.

1881.

- B 23. *Gasfeuerung und Gasöfen*, by H. Stegmann. Numerous references to the use of producer-gas in the ceramic industry.

- B 24. *Trans. A. I. M. E.*, Vol. IX, p. 309. Discussion of a fluxing gas-producer.

- B 25. *Trans. A. I. M. E.*, Vol. IX, p. 310. Discussion of gas-producers using blast, and good illustrations of Swedish types for using wood.

- B 26. *Zeitschrift für physikalische Chemie*, Vol. II, p. 161. Extensive discussion of the action in a gas-producer.

1883.

- B 27. *Eng. News*, December 1st. Discusses invention of gas, and gives early history.

- B 28. *J. S. C. I.*, Vol. II, p. 62. Discusses the economical use of fuel.
- B 29. *J. S. C. I.*, Vol. II, p. 453. Discussion of the Wilson gas-producer and the recovery of by-products.
- B 30. *J. S. C. I.*, Vol. II, p. 504. Extensive discussion of the advantages of gaseous fuel.
- B 31. *Proc. I. C. E.*, Vol. LXXIII, p. 311. Discussion of producer-gas for motive power, with several illustrations.
- B 32. *Trans. A. I. M. E.*, Vol. XI, p. 292. Discussion of analysis of furnace gases.
- 1884.
- B 33. *Handbuch der Eisenhüttenkunde*, by Ledebur. Numerous references to the use of and value of fuel gas to the iron industry.
- B 34. *J. I. and S. I.*, Vol. I, p. 72. Utilization of gaseous fuel; description, with illustration, of producer and scrubber.
- B 35. *Trans. A. I. M. E.*, Vol. XII, p. 93. Illustration and general description of Langdon gas-producer.
- 1885.
- B 36. *Engng.*, October 30th. Discussion of water-gas production.
- B 37. *J. I. and S. I.*, Vol. I, p. 126. General description and good illustration of modified form of Siemens producer.
- B 38. *J. S. C. I.*, Vol. IV, p. 439. Extensive discussion of flame action, and production of gas in Siemens modified producer.
- 1886.
- B 39. *Proc. I. C. E.*, Vol. LXXXIV, p. 4. Classification, historical data; illustrates various forms of producers and gives extensive table showing the gas analyses from fifty-seven different producers.
- 1887.
- B 40. *Coal tar and Ammonia*, by G. Lunge. Numerous references to the extraction of tar and ammonia from gas.
- B 41. *Elements of Metallurgy* by J. A. Phillips, p. 98. Discussion of Siemens gas-producer.
- B 42. *Feuerungskunde*, by Ludwig Ramdohr, p. 78. Thorough discussion of the gasification of fuel.
- 1888.
- B 43. *J. I. and S. I.*, Vol. I, p. 86. Extensive discussion of the use of water gas and producer-gas for metallurgical purposes.
- 1889.
- B 44. *Chemical Technology*, by Groves and Thorpe, Vol. I, p. 250. General discussion of foreign gas-producers.
- B 45. *J. I. and S. I.*, Vol. II, p. 139. General discussion of gaseous fuel.
- B 46. *J. I. and S. I.*, Vol. II, p. 256. Description and illustrations of a Siemens furnace arranged to recover waste gases.
- B 47. *J. S. C. I.*, Vol. VIII, p. 503. Description and illustration of Mond gas plant.
- B 48. *Practical Treatise on Manufacturing Bricks*, by C. T. Davis, p. 246. Discussion of the use of gas in burning brick.
- 1890.
- B 49. *Eng. News*, Vol. XXIV, p. 317. Discussion of fuel gas, giving illustration of the Loomis system.
- B 50. *Les Moteurs à Gaz et les Moteurs à Petrole*, by C. Wehrin, p. 61. Gives illustration of a gas-producer.
- B 51. *Trans. A. I. M. E.*, Vol. XVIII, p. 609. Notes on fuel gas.
- B 52. *Trans. A. I. M. E.*, Vol. XVIII, p. 859. Thorough discussion of the energy, utilization, and gasification of fuel.

1891.

- B 53. *Clay Worker*, May 15, p. 499. Brief discussion of the production of gas.
- B 54. *Clay Worker*, June 15, p. 596. Brief discussion of gaseous fuel.
- B 55. *Clay Worker*, July 15, p. 25. Brief discussion of the physics of gaseous fuels.
- B 56. Dictionary of Applied Chemistry, by Thorpe, Vol. II, p. 217. Brief discussion of producer-gas.
- B 57. *Eng. and Min. Jour.*, Vol. LI, May 9, p. 562. Description of producer plant for roasting-kilns; gives summary of fuel consumption.
- B 58. *Eng. News*, Vol. XXV, p. 512 and 521. Discussion of fuel gas.
- B 59. *Eng. News*, Vol. XXVI, p. 329. Discussion of the gasification of anthracite.
- B 60. Gasfeuerungen by Ledebur. Numerous references to producer-gas and the manufacture of same.
- B 61. *Jour. F. I.*, Vol. CXXXII, p. 424. Fuel gas; its production and distribution.
- B 62. J. I. and S. I., Vol. II, p. 104. Description of a Thwaite gas plant, giving several drawings.
- B 63. Moteurs à Gaz, by Gustave Chauveau, p. 275. Brief description of gas-producers.
- B 64. N. B. M. A., p. 134. Extensive discussion of the use of producer-gas for burning brick.
- B 65. *Proc. I. M. E.*, p. 47. Extensive discussion of gas furnaces; gives sixty-three illustrations.
- B 66. *Trans. A. I. M. E.*, Vol. XIX, p. 128. Physical and chemical equations; gives thorough discussion of the chemistry of a gas-producer, with numerous tables.

1892.

- B 67. Berg- und Hüttenmannisches Jahrbuch der k. k. Bergakademien, Vol. XL, p. 81-203. German translation of Prof. R. Akerman's paper on gaseous fuel; discusses gas-production in detail and gives drawings of seven wood producers.
- B 68. Chemical Technology, by Rudolf Wagner, translated by Crookes, p. 41. Brief description and illustration of the Lürmann, Boetius and Siemens gas-producers.
- B 69. *Eng. News*, Vol. I, p. 540. Gives history of fuel gas; also discusses manufacture of water gas and producer-gas.
- B 70. *School of Mines Quarterly*, Vol. XIII, No. 2. The valuation of fuel gas; discusses method of determination.
- B 71. *Traité des Moteurs à Gaz*, by A. Witz, Vol. I, p. 115. Brief description of gas-producers.
- B 72. *Trans. A. I. M. E.*, Vol. XX, p. 635. Discussion of the mechanical effects of steam on the gas-producer.

1893.

- B 73. N. B. M. A., p. 151. Discussion of the use of producer-gas for burning brick.
- B 74. *Proc. Eng. Soc. of W. Pa.*, Vol. IX, p. 184 and 237. Gas-producers for metallurgical work.
- B 75. *Proc. I. C. E.*, Vol. CXII, p. 2. Discussion of gas power for electric lighting.
- B 76. *Trans. A. I. M. E.*, Vol. XXIII, p. 134 and 585. Discussion of fuel consumption in a Taylor producer.
- B 77. *Trans. A. I. M. E.*, Vol. XXII, p. 371. Description and illustration of Wellman gas-producer, with discussion of manufacture of producer-gas.

1894.

- B 78. *Cassier's*, December, p. 123. Gas-producers for boilers.
 B 79. *Eng. and Min. Jour.*, May 12th. Illustration and description of a Dauber gas-producer.
 B 80. *Jour. F. I.*, November, p. 321. Description of the American Gas-Furnace Co.'s system of fuel-gas production.
 B 81. *Trans. A. I. M. E.*, Vol. XXIV, p. 289. Description and illustrations of Swedish gas-producers for coal and wood.
 B 82. *Trans. A. I. M. E.*, Vol. XXIV, p. 573. Brief notes on a Taylor gas-producer.
 B 83. *Zeitschr. d. V. D. Ing.*, November 10th. Brief discussion of the theoretical and practical problems involved with producer-gas.

1895.

- B 84. *Eng. Lond.*, July 5th. Discussion of the Thwaite system of gas power.
 B 85. *Iron Age*, March 14th. Description and illustration of Kitson producer, with discussion of fuel gas.
 B 86. *Zeitschr. d. V. D. Ing.*, December 21st and 28th. Full details of the test of a producer-gas power plant; gives summary of results.

1896.

- B 87. *Colliery Guardian*, March 27th. Discussion of history and efficiency of gas-producers.
 B 88. *Eng. Lond.*, August 28th. Discussion of a Thwaite gas plant.
 B 89. *Eng. Mag.*, Vol. XI, p. 905. The important features of producer-gas.
 B 90. *Iron Age*, April 30th. Description and illustration of Kitson producer.
 B 91. *Jour. Assn. Eng. Soc.*, Vol. XVII, p. 169. Brief discussion of gas-producers.
 B 92. *Manufacture and Properties of Structural Steel*, by H. H. Campbell, p. 95 and 117. Brief reference to producer-gas.
 B 93. *Prac. Eng.*, Vol. XIII, p. 666. Discusses fundamental principles of gas-producers.
 B 94. *Prac. Eng.*, Vol. XIV, p. 112. Discusses efficiency and forms of gas-producers.
 B 95. *Prac. Eng.*, Vol. XIV, p. 149. Discusses steam blowers for gas-producers.
 B 96. *Prac. Eng.*, Vol. XIV, p. 174. Describes various English types of gas-producers.
 B 97. *Prac. Eng.*, Vol. XIV, p. 251. Discusses tar, ammonia, and Mond gas.
 B 98. *Prac. Eng.*, Vol. XIV, p. 294. Discusses regenerative furnaces.
 B 99. *Proc. I. C. E.*, Vol. CXXIII, p. 328. Efficiencies of gas-producers; thorough discussion, with reports of several tests.
 B 100. *The Gas and Oil Engine*, by Dugald Clerk, p. 354. Discussion of producer-gas, with description of several types of producers.
 B 101. *The "Otto" Cycle Gas Engine*, by William Norris, p. 198. Description of several gas plants.

1897.

- B 102. *Eng. Lond.*, October 29th. Description of a Thwaite gas plant.
 B 103. *Fuel*, by Sexton, p. 139. Extensive discussion of producers and producer-gas.
 B 104. *Iron Age*, September 30th. Complete description of Kitson producer, with report of test.
 B 105. *Practical Treatise on Modern Gas and Oil Engines*, by Frederick Grover, p. 176. Application of producer-gas in engines.
 B 106. *Proc. I. C. E.*, Vol. CXXIX, p. 190. Extensive discussion of Mond gas and its applications.
 B 107. *Railroad Gazette*, April 16th. Discussion of future fuel problem.
 B 108. *J. S. C. I.*, Vol. XVI, p. 420. Comparison of gas-producers.

1898.

- B 109. *Eng. and Min. Jour.*, February 26th. Illustration and description of Kitson gas-producer.
- B 110. *Electric Review* (London), November 11th. Report of test of gas-producer plant in Switzerland.
- B 111. *Engng.*, September 23d. Description of Benier gas-producer.
- B 112. *I. C. T. R.*, January 21st. Discussion of modern types of gas-producers.
- B 113. *N. B. M. A.*, p. 161. Brief discussion of the use of producer-gas for burning brick.
- B 114. *Nineteenth Century*, July. Discussion of future fuel supplies.
- B 115. O'Conner's Gas Engineer's Pocket Book, p. 385. Brief discussion of the various systems of gas-production.
- B 116. Poole's Calorific Power of Fuels, p. 92. Discussion of gaseous fuels.
- B 117. *Trans. A. I. M. E.*, Vol. XXVIII, p. 166. Illustrated description of an automatic feed-device for gas-producers.

1899.

- B 118. *Colliery Guardian*, July 14th. Economical use of fuel; shows how economy may and must be improved.
- B 119. *Electric Review* (London), July 28th. Discussion of a gas engine with 30 per cent efficiency.
- B 120. *Gas World*, September 9th. Discussion of the fuel problem of the future.
- B 121. Heat and Heat Engines, by Hutton, p. 60. Discussion of producers and producer-gas.
- B 122. *J. S. C. I.*, Vol. XVIII, p. 646. Discussion of gaseous fuels.
- B 123. *Mineral Industry*, Vol. VIII, p. 124. Economical utilization of fuel.
- B 124. Proceedings Cleveland institution of Engineers (England), March 16th. Discussion of the advantages of gas engines for general power purposes.
- B 125. Thorp's Outlines of Industrial Chemistry, p. 30. Brief discussion of producer-gas.

1900.

- B 126. Architectural Pottery, by Leon Lefèvre, English translation by Bird and Binns, p. 231. Discussion of the use of gaseous fuel in continuous kilns.
- B 127. *Brick*, November 1st. Notes on the use of producer-gas in burning brick.
- B 128. *Eng. and Min. Jour.*, Sept. 8th, p. 281. Describes method of making gas by the Riche system.
- B 129. *Eng. and Min. Jour.*, October 20th, p. 460. Description and illustrations of the Riche wood gas-producers.
- B 130. *Eng. Mag.*, October. Discussion of the coal supply of the U. S.
- B 131. *Engng.*, Vol. LXX, p. 169. Brief description of the Siemens, Gardie, Taylor, Benier, Kitson, Loomis, Wilson, Longston, Mond, Beurencachez, Dowson, and Pinkey gas-producers, the last named being illustrated.
- B 132. *Engng.*, Vol. LXX, p. 202 and 203. Considerable tabulated data are given with regard to the operation of gas-power plants.
- B 133. *Engng.*, Vol. LXX, p. 244. Valuable tabulated data are given on cost of gas-producer power plants.
- B 134. *Engng.*, Vol. LXX, p. 399. Description and illustrations of a gas-producer plant in Switzerland.
- B 135. *Engng.*, Vol. LXX, p. 526. Description and illustrations of a Fichet-Heurty gas-producer power plant.
- B 136. *Engng.*, Vol. LXX, p. 589. Description with several illustrations of a Crossley gas-producer plant.
- B 137. *Engng.*, Vol. LXX, p. 654. Description and illustrations of a Kört-ing gas-producer plant.

- B 138. *Engng.*, Vol. LXX, p. 811 and 845. Extensive discussion of the use of Mond gas; gives several illustrations.
- B 139. *Gas, Oil and Air Engines*, by Byran Donkin, p. 158. Extensive discussion of gas-production for motive power.
- B 140. *Handbuch der Eisenhüttenkunde* by Ledebur, p. 100. Thorough discussion of the use of producer-gas, with illustrations of producers.
- B 141. *I. C. T. R.*, July 20th. Discusses extent of coal fields at the close of the nineteenth century.
- B 142. *Trans. A. C. S.*, p. 38. Notes on the use of producer-gas in burning brick.
- 1901.
- B 143. *Dawson's Engineering and Electric Traction Book*, p. 829. Discussion of the manufacture of producer-gas, with several illustrations of producer plants; also general data on scrubbers, gas holders, flame temperatures, and operating costs.
- B 144. *Engng.*, Vol. LXXI, p. 41. Detailed description and illustration of the Duff by-product gas-producer plant.
- B 145. *Eng. Lond.*, Vol. XCI, p. 287. Applications of Mond gas.
- B 146. *Glückauf*, May 11th. Description of power plant using lignites in producer.
- B 147. *Gasmt.*, Vol. I, p. 106. Illustration and brief description of a suction gas-producer plant.
- B 148. *Iron Age*, September 12th, p. 8. Report on the efficiency test of a gas-producer plant for heating furnaces.
- B 149. *J. S. C. I.*, Vol. XX, p. 879. Brief description with illustration of gas-washer.
- B 150. *Kent's Mechanical Engineer's Pocket Book*, p. 646. Discusses fuel gas.
- B 151. *Mem. Soc. Ing. Civ.*, France, September. Discusses the action of various types of gas-producers.
- B 152. *Prac. Eng.*, Vol. XXIII, p. 58. Discussion of gas power.
- B 153. *Prevention of Smoke*, by W. C. Popplewell, p. 91. Brief discussion of gaseous fuel.
- B 154. *Proc. I. C. E.*, Vol. CXLIV, p. 269. General discussion of producer-gas plants.
- B 155. *Proc. I. M. E.*, p. 41 and 247. Extensive discussion of Mond gas.
- B 156. *Stahl und Eisen*, June 15th. Discussion of the use of lignites for making producer-gas.
- B 157. *Treatise on Ceramic Industries*, by Emile Bourry, English translation by W. P. Rix, p. 336. Discussion of firing kilns with producer-gas.
- 1902.
- B 158. *Cassier's*, May, p. 48. Description of some representative gas-producer power plants for mining work.
- B 159. *Cassier's*, August, p. 500. General description of the method of making producer-gas.
- B 160. *Collected Writings of H. A. Seger*, edited by A. V. Bleininger, Vol. I, p. 316. Discussion of gas-fired kilns.
- B 161. *Eisenhüttenkunde*, by Wedding, Vol. II, p. 795. Brief discussion of producer-gas.
- B 162. *Eng. Lond.*, Vol. XCIV, November 21st, p. 494. Description and illustration of Mond gas-producer.
- B 163. *Gas and Petroleum Engines*, by Robinson, p. 553. Discussion of producer-gas.
- B 164. *Gasmt.*, Vol. I, p. 167. Description and illustrations of several suction gas-producers.
- B 165. *Gasmt.*, Vol. I, p. 188. Illustration and description of the Pintsch patented gas regulator for suction gas-producers.

284 A TREATISE ON PRODUCER-GAS AND GAS-PRODUCERS.

- B 166. *Gasmt.*, Vol. II, p. 97 and 121. Extensive discussion of the scrubbing of gases.
- B 167. *Gasmt.*, Vol. II, p. 119. Discussion of gas-producer power plants.
- B 168. Gas-Producer Catalogue of the R. D. Wood Co., Philadelphia, Pa. This is one of the best catalogues issued on the subject of gas-producers up to 1902; gives valuable data.
- B 169. *Gas World*, September 27th, p. 485. Description and illustration of Körting gas-producer.
- B 170. *Genie Civil*, April 25th. Illustration and description of a suction gas-producer.
- B 171. *Iron Age*, March 6th, p. 18. Discussion of steam blowers for gas-producers.
- B 172. *J. S. C. I.*, Vol. XXI, p. 79. Brief discussion of the efficiency of a Wilson producer.
- B 173. *I. C. T. R.*, October 17th. Gas-power station with Pintsch producer.
- B 174. *Mem. Soc. Ing. Civ.*, France, June. Discussion of power gas.
- B 175. *Mineral Industry*, Vol. X, p. 167. Discusses the progress made in recent years.
- B 176. *Prac. Eng.*, Vol. XXV, p. 440, 471, 487, 511. Extensive discussion of the applications of producer-gas.
- B 177. *Stahl und Eisen*, Vol. XXII, p. 1208. Discussion of the use of brown coal in producers.
- B 178. Thermodynamics of the Steam Engine, by Peabody, p. 214. Brief discussion of gas-producers.
- B 179. Transactions National Electric Light Association, May. General discussion of the advantages of gas engines for central station work; gives comparison with steam plant.
- B 180. *Zeitschr. d. V. D. Ing.*, November 8th. Discussion of producers for engine work.
1903.
- B 181. *American Gas-Light Journal*, March 30th. Gas for industrial purposes.
- B 182. *Braunkohle*, p. 358 and 373. Discussion of the use of brown coal in producers.
- B 183. *Bulletin de la Société de l'Industrie Minerale*, p. 889. Description of an experimental reversed combustion gas-producer, designed to work on fuels of low calorific value.
- B 184. *Das Entwerfen und Berechnen der Verbrennungsmotoren*, by H. Güldner, p. 358. Illustrations and description of several German producers.
- B 185. *Eng. Lond.*, December 11th, Vol. XCVI, p. 578. Description and illustrations of the Crossley gas-producers.
- B 186. *Engng.*, Vol. LXXV, June 5th, p. 761. Description and illustration of Taylor suction gas-producer.
- B 187. *Engng.*, Vol. LXXVI, September 25th, p. 420. Description and excellent illustrations of a Pierson gas-producer plant.
- B 188. *Engng.*, Vol. LXXVI, October 2d, p. 474. Description and illustration of Talbot mechanical gas-producer.
- B 189. *Engng.*, Vol. LXXVI, November 20th, p. 696. Drawing and description of Pierson gas-producer.
- B 190. *Evaporating, Condensing, and Cooling Apparatus*, by E. Hausbrand, translated by A. C. Wright. Numerous references to the cooling and condensing of gases.
- B 191. *Gas World*, April. Cheap gas for motive power.
- B 192. *I. C. T. R.*, April 24th. Discussion of gas power.
- B 193. *I. C. T. R.*, Vol. LXVI, p. 1644. Illustration and description of Duff producers and ammonia recovery plant.
- B 194. *Iron, Steel, and Other Alloys*, by H. M. Howe, p. 407. Discussion of metallurgical furnaces with special reference to gas regeneration.

- B 195. *J. I. and S. I.*, Vol. II, p. 582. Abstract of B 214.
- B 196. *J. I. and S. I.*, Vol. II, p. 584. Abstract of article in B 215.
- B 197. *Jour. Assn. Eng. Soc.*, October, Vol. XXXI, p. 89. Description and illustration of the methods of making coal and water gas, with illustrations of gas meters.
- B 198. *Machinery* (Engineering Edition), March 3d, p. 353. Brief description and three illustrations of gas-producers.
- B 199. *Materials of Machines*, by Smith, p. 14. Brief description of the producer-gas process.
- B 200. *Mechanical Engineer*, April 4th. Discussion of the production of power by means of gas-producers and gas engines.
- B 201. Monograph on Mond Gas, by The R. D. Wood Co. Contains considerable data and illustrations of general interest to the gas-producer industry.
- B 202. *Power*, April, p. 178. Illustration of suction producer.
- B 203. *Power*, April, p. 181. Producer-gas and gas engines. Illustration and description of Mond and Loomis producers.
- B 204. *Power*, September, p. 512. Brief description, with illustration, of a suction gas-producer.
- B 205. *Prac. Eng.*, Vol. XXVII, p. 345. Brief discussion of gas-producers.
- B 206. *Prac. Eng.*, Vol. XXVIII, p. 7. Illustrations and descriptions of recent forms of gas-producers.
- B 207. *Proc. Eng. Soc. of W. Pa.*, Vol. XIX, p. 195. Extensive discussion of gas for power purposes.
- B 208. *Proc. I. C. E.*, Vol. CLIV, p. 430. Abstract of article on a power gas plant in Switzerland; gives summary of results obtained.
- B 209. *Proc. I. C. E.*, Vol. CLVI, p. 483. Abstract of article giving the summary of the results obtained in testing a suction gas-producer plant.
- B 210. *Proc. I. C. E.*, Vol. CLVI, p. 489. Abstract of article describing a reversed combustion gas-producer.
- B 211. *Proc. I. C. E.*, Vol. CLVI, p. 578. Abstract of a description of a new gas-producer plant.
- B 212. *Progressive Age*, January 15th, p. 33. Description and illustrations of suction gas-producers for gas engines.
- B 213. *Schweiz Bauzeitung*, February 28th and March 7th. Description of a complete gas-power house.
- B 214. *Stahl und Eisen*, Vol. XXIII, p. 433-441, 515, and 528. Elaborate discussion of the thermal reactions in the gas-producer and the action of the blast in detail.
- B 215. *Stahl und Eisen*, Vol. XXIII, p. 695. Discussion of the changes that take place in the composition of producer-gas between the producer and the furnace.
- B 216. *Stevens Indicator*, January. The blast furnace as a power plant.
- B 217. *Teknisk Tidskrift, Allmänna Afedningen*, Vol. XXXIII, p. 53. Discussion of the relative merits of various gas-producers for use in iron works.
- B 218. *The Gas Engine*, by Hutton, p. 41. Brief discussion of gas-producers, with several illustrations.
- B 219. *Transactions of the Civil and Mechanical Engineers' Society*, Volume for 1902-1903, p. 53-68. Discussion of the advantages of the gas-producer as a power generator.
- B 220. *Zeitschr. d. V. D. Ing.*, p. 157. Gives results of a suction gas-producer test; abstract of this is given in B 209.
- 1904.
- B 221. *Cassier's*, October. Extensive and detailed discussion of fuel gas for gas engines; several illustrations given.
- B 222. *Cosmopolitan*, December, p. 169. Brief discussion of the adaptability of gas-producers for marine work.

- B 223. *Electric Club Journal*, Vol. I, March, p. 65. Lecture on gas-power plants.
- B 224. *Electrical World and Engineer*, November 19th. Gives figures taken from a number of plants, indicating marked economies in the use of producer-gas and gas engines instead of steam.
- B 225. *Eng. and Min. Jour.*, December 8. Section and description of the Wile gas-producer.
- B 226. *Eng. Lond.*, Vol. XCVII, March 15th, p. 311. Brief description of a German producer-gas plant that uses brown coal briquettes for fuel.
- B 227. *Eng. Lond.*, Vol. XCVII, April 8th, p. 370. Description and illustration of a Duff producer-gas plant using soft coal.
- B 228. *Eng. Lond.*, Vol. XCVIII, August 12th, p. 151. Description and illustration of a Crossley gas-producer plant.
- B 229. *Eng. Lond.*, Vol. XCVIII, November 4th, p. 450. Description and illustration, with summary of test, of a Pierson suction gas-producer.
- B 230. *Eng. News*, August 4th, p. 96. Description of the producer-gas and gas-engine plant of the Moctezuma Copper Company at Nacozari, Sonora, Mexico. Abstract of B 281.
- B 231. *Engng.*, Vol. LXXVIII, August 26th, p. 285. Description of the testing of a Pierson suction gas-producer.
- B 232. *Engng.*, Vol. LXXVIII, September 2d, p. 295. Description and illustration of a Mond gas plant.
- B 233. *Engng.*, Vol. LXXVIII, October 21st, p. 540. Description and illustration of a gas-producer designed to work on bituminous coal.
- B 234. *Engng.*, Vol. LXXVIII, November 18th, p. 692. Brief discussion of bituminous coal-gas production.
- B 235. *Engr.*, February 1st, p. 106, and March 1st, p. 177. Discussion of gas power for central stations.
- B 236. *Engr.*, June 15th, p. 416. Description and illustration of the Otto producer.
- B 237. *Engr.*, July 1st, p. 450. Description and illustration of the Bollinckx suction gas-producer.
- B 238. *Engr.*, October 15th, p. 717. Description and illustration of the Weber suction gas-producer.
- B 239. *Engr.*, December 15th, p. 821. Illustration and description of producer-gas power plant.
- B 240. *Eng. Rec.*, Vol. L, October 1st, p. 406. Brief reference to the economy of an English gas-producer plant.
- B 241. *Eng. Rec.*, Vol. L, December 3d, p. 654. Description and illustration of a gas-producer plant.
- B 242. *Gasmt.*, Vol. IV, p. 10 and 27. Discussion of the theory of the combustion of carbon in the gas-producer.
- B 243. *Gasmt.*, Vol. IV, p. 33. Detailed discussion of the manufacture of producer-gas.
- B 244. *Gasmt.*, Vol. IV, p. 79 and 85. Discussion of the purification of gas; gives several illustrations.
- B 245. *Gasmt.*, Vol. IV, p. 107. Description and illustration of the Thesian centrifugal gas washer.
- B 246. *Gas Power*, October, p. 3. Brief discussion of gas-producers.
- B 247. *Gas Power*, November, p. 3. Suggestions for a marine-engine producer.
- B 248. *Gas Power*, November, p. 4. Illustrations and descriptions of the Weber, Dunlop, Crossley, Bollinckx, and Nagel producers.
- B 249. *Gas Power*, December, p. 16. Discussion of the advantages of gas-engine power plants.
- B 250. *Iron Age*, August 18th. Description and illustration of the Thesian centrifugal gas washers.

- B 251. *Iron Age*, December 29th. Description and illustration of a modern gas-producer plant.
- B 252. *I. C. T. R.*, Vol. LXVII, p. 1559. Description and illustration of Mond gas plant.
- B 253. *I. C. T. R.*, Vol. LXVIII, p. 679. Gives comparison of the cost of power with water gas, Mond gas, coal gas and electricity.
- B 254. *Journal of Electricity*, December. Illustration and description of a gas-producer power plant equipped with a Pierson producer of special design.
- B 255. *Les Gazogenes*, by Jules Deschamps. This book is divided into 15 chapters, contains 432 pages with 240 figures, and gives a comprehensive discussion of the manufacture and use of producer-gas.
- B 256. *Mar. Eng.*, October. Description and illustration of a suction gas-producer installed on a ship.
- B 257. *Modern Gas-Engine and Producer-Gas Plants*, by R. E. Mathot, chapters 10-13. Extensive discussion of producer-gas engines, producer-gas, pressure gas-producers, suction producers, generators, vaporizers, dust collectors, and the operation of generators.
- B 258. *Oesterreichische Zeitschrift fuer Berg und huettenwesen*, September 24th. Discussion and description of the methods used in successfully gasifying peat, where the gas is to be used in gas engines.
- B 259. *Power*, January, p. 1. Discussion of the "blast furnace as a gas-producer"; describes plant and apparatus used in cleaning the gas.
- B 260. *Power*, January, p. 50. Brief discussion of the "blast furnace as a gas-producer."
- B 261. *Power*, February, p. 72. Description and illustration of the Crossley gas-producer for bituminous coal.
- B 262. *Power*, February, p. 100. Comprehensive and illustrated discussion of gas power for central stations.
- B 263. *Power*, April, p. 201. Brief description of a power plant where wood is used in the gas-producers.
- B 264. *Power*, June, p. 362. Illustration and description of the Bollinckx suction gas-producer.
- B 265. *Power*, July, p. 425. Illustration and brief description of the Thwaite gas-producer for bituminous coal.
- B 266. *Power*, August, p. 457. Illustration and brief description of a gas-producer used as a superheater.
- B 267. *Power*, September, p. 520. Description and illustrations of several gas-producers; gives summary of costs.
- B 268. *Power*, September, p. 560. Brief discussion of gas-producer guarantees.
- B 269. *Power*, October, p. 632. Description and illustration of the Thesian centrifugal gas washer.
- B 270. *Power*, November, p. 696. Brief discussion of the transmission of producer-gas.
- B 271. *Power*, December, p. 736. Description and illustrations of suction gas-producers; thorough discussion of details.
- B 272. *Power*, December, p. 789. Description and illustration of the Wile gas-producer.
- B 273. *Power*, December, p. 752. Summary of comparative economies of steam and gas plants.
- B 274. *Proceedings of the South African Association of Engineers*, Vol. I, p. 131. Discussion of the evolution of the modern gas-power plant.
- B 275. *Producer-Gas*, by Sexton. Extensive discussion of the physics and chemistry of the gas-producer.
- B 276. *Proc. I. C. E.*, Vol. CLVIII, p. 309. Brief discussion of the value of gas-producers.
- B 277. *Proc. I. C. E.*, Vol. CLVIII, p. 320. Description of methods used in testing gas-producers, giving summary of efficiency, gas analysis, and water consumption.

- B 278. *Proc. I. C. E.*, Vol. CLV, p. 472. Abstract of article on gas-producer plants for heating.
- B 279. *Sci. Am. Sup.*, September 3d. Illustration and description of a Pierson gas-generating system.
- B 280. Suction Gas, by O. H. Haenssger. A monograph devoted to the advantages of the suction gas-producer.
- B 281. *Trans. A. I. M. E.*, Vol. XXXIV, p. 748. The gas-power plant of the Moctezuma Copper Co. at Nacozari, Sonora, Mexico. Paper containing excellent illustrations and much valuable statistical data of actual working results.
- B 282. *Zeitschr. d. V. D. Ing.*, October 29th, p. 1656. Discussion of the principles involved in making power-gas, with a summary of the cost of the various forms of fuel gas.
- B 283. *Zeitschr. d. V. D. Ing.*, November 26th, p. 1793. Extensive discussion of the results obtained with a gas-producer designed for experimental work. Gives valuable tables and diagrams.

1905.

- B 284. *American Engineer and Ry. Journal*, April, p. 124. Description and illustration of gas-producer power plant.
- B 285. *Bulletin* No. 261, U. S. Geological Survey, p. 85. Results of gas-producer tests with different fuels; gives much tabulated data.
- B 286. *Eng. Mag.*, May, p. 185. Discussion with illustrations of the design and operation of suction gas-producers.
- B 287. *Eng. Mag.*, May, p. 211. Report of test of a gas-producer plant; abstract of B 285.
- B 288. *Eng. Mag.*, June, p. 347. Extensive and illustrated discussion of gas-producers for marine work.
- B 289. *Eng. News*, Vol. LIII, January 19th, p. 78. Brief description of a Pintsch suction gas-producer.
- B 290. *Eng. News*, Vol. LIII, February 16th, p. 161. Illustration and description of Pinstch suction producer.
- B 291. *Engng.*, March 17th, p. 352. Brief discussion of the cost of gas power.
- B 292. *Engng.*, March 24th, p. 381. Brief discussion of suction gas plants.
- B 293. *Engr.*, January 1st, p. 18. Extensive and detailed discussion of gas-producer systems; contains illustrations of the American, Baltimore, Nagel, Weber, Wile, and Taylor producers.
- B 294. *Engr.*, January 1st, p. 27. Description and illustration of Crossley suction gas-producer.
- B 295. *Engr.*, January 16th, p. 89. Description, with illustration, of the Fetu De Fize gas-producer.
- B 296. *Engr.*, February 1st, p. 104. Illustration, with brief description, of a Mond gas-producer plant.
- B 297. *Engr.*, February 1st, p. 107. Illustration and description of the Campbell suction gas-producer.
- B 298. *Engr.*, February 15th, p. 137. Description and illustration of the LeTombe gas-producer.
- B 299. *Eng. Rec.*, Vol. LI, January 21st, p. 89. Same as B 289.
- B 300. *Eng. Rec.*, May 27th, p. 601. Extensive discussion of the gas-cleaning methods.
- B 301. *Eng. Lond.*, March 31st, p. 308. Discussion of the theory and operation of suction gas-producers.
- B 302. *Eng. Lond.*, April 14th, p. 360. Description and illustrations of the Baltimore, Benier Benz, Campbell, Crossley, Dawson, and Körtig suction gas-producers.
- B 303. *Eng. Lond.*, April 28th, p. 420. Illustration and description of Acme, Dynamic, Pintsch, Pierson, and Tangye producers.
- B 304. *Gas Engine*, January. Brief description with illustration of the Wile producer.

- B 305. *Gas Engine*, January, p. 3. Brief discussion of the gasification of peat.
- B 306. *Gas Engine*, February, p. 39. Brief discussion of gas for power.
- B 307. *Gas Engine*, March, p. 70. Brief discussion of the manufacture of gas from vegetable products for power purposes.
- B 308. *Gas Engine*, March, p. 94. Discussion of gas-driven locomotives and ships.
- B 309. *Gas Engine*, April, p. 110. Description and illustration of the Fairbanks-Morse suction gas-producer.
- B 310. *Gas Engine*, May, p. 136. Discussion of power production from gaseous fuel.
- B 311. *Gas Engine*, June, p. 165. Description of a coke gas-producer.
- B 312. *Gas Engine*, June, p. 175. Discussion of power gas.
- B 313. *Gas Engine*, June, p. 178. Discussion of producer-gas units.
- B 314. *Gas Power*, January, p. 3. Illustration and brief description of the Pintsch suction producer.
- B 315. *Gas Power*, January, p. 5. Illustration and description of the Westinghouse producer for soft coal.
- B 316. *Gas Power*, February, p. 6. Brief description of the Baltimore gas-producer.
- B 317. *Gas-Producers*, by W. A. Tookey. British book of 142 pages, devoted to the production of gas and descriptions of representative gas-producers.
- B 318. *Ice and Refrigeration*, May, p. 277. Discussion of producer-gas for power purposes.
- B 319. *I. C. T. R.*, April 14th. Discussion of the principle and requirements of gas-producers.
- B 320. *Iron Age*, February, p. 674. Illustrated description of the Swindell gas-producer.
- B 321. *Iron S. M.*, January, p. 64. Description and illustration of the Amsler gas-producer.
- B 322. *Iron S. M.*, February, p. 177. Illustrated description of a gas-producer plant.
- B 323. *Journal American Society Naval Engineers*, Vol. XVII, p. 319. Discusses future of marine gas engine and gas-producer.
- B 324. *London Electrician*, April 7th. Discussion of the principal forms of gas-producers with special reference to the suction type.
- B 325. *Mining Reporter*, March 9th. Discussion and illustration of a Riche gas-producer for the gasification of waste wood, ligneous matter, and agriculture residues.
- B 326. *Power*, January, p. 14. Brief discussion of the use of peat as a gas-producer fuel.
- B 327. *Power*, March, p. 129. Illustrations and description of the method of manufacture, and use of coke-oven gas in gas engines.
- B 328. *Power*, March, p. 178. Brief editorial on the gasification of city waste.
- B 329. *Power*, April, p. 212. Description and illustration of a gas-power plant.
- B 330. *Power*, May, p. 261. Illustrated description of the Riche gas-producer.
- B 331. *Power*, May, p. 273. Description and illustration of a gas-producer power plant.
- B 332. *Prac. Eng.*, Vol. XXXI, p. 203. Description and illustration of a suction gas-producer installed on a ship.
- B 333. *Prac. Eng.*, Vol. XXXI, p. 401. Discussion of gas as a source of power.
- B 334. *Prac. Eng.*, Vol. XXXI, p. 537. Advantages of producer-gas plants.
- B 335. *Prac. Eng.*, Vol. XXXI, p. 597, 635, 676, 716, 794. Extensive and illustrated discussion of power-gas plants.
- B 336. *Progressive Age*, April 15th. Extensive discussion of producer-gas with special reference to power generation.

290 A TREATISE ON PRODUCER-GAS AND GAS-PRODUCERS.

- B 337. *Sci. Am.*, February 4th, p. 98. Brief discussion of gas-driven locomotives and ships.
- B 338. *Sci. Am.*, February 18th, p. 139. Brief discussion of the gas-producer, with special reference to power plants.
- B 339. *Sci. Am.*, March 4th, p. 180. Description and illustration of the Capitaine suction gas-producer for marine work.
- B 340. *Sci. Am. Sup.*, January 28th. Illustration and brief description of a Pierson producer-gas plant.
- B 341. *Sci. Am. Sup.*, February 4th. Illustration and discussion of gas-producers for locomotive work.
- B 342. *Sci. Am. Sup.*, April 1st. Illustrated description of the Pintsch suction gas-producer.
- B 343. *Sci. Am. Sup.*, April 29th. Illustrated description of the Nagel suction gas-producer.
- B 344. *Sci. Am. Sup.*, June 3d. Discussion of producer-gas power plants.
- B 345. *Stahl und Eisen*, Vol. XXV, March 1st, p. 308. Illustration and brief description of a Swedish gas-producer for gasifying wood and peat in connection with the firing of steam boilers.
- B 346. *Stahl und Eisen*, Vol. XXV, April 1st, p. 387. Illustrations and discussion of the use of gas-producers in iron works.
- B 347. *Zeitschr. d. V. D. Ing.*, February 18th, p. 233. Extensive discussion of the gasification of fuels for the production of power; gives graphical analysis of the thermo-chemical reactions involved.

The following references are not related directly to gas-producers, but are quoted in the text:

- B 348. Fertilizers, by E. B. Voorhees, p. 51.
- B 349. Treatise on Manures, by A. B. Griffiths, p. 187-8.
- B 350. Manures and the Principles of Manuring, by C. M. Aikman, p. 355.
- B 351. *Journal of the American Chemical Society*, Vol. XXI, p. 1116. Report of committee on standard methods of testing fuels.
- B 352. *Trans. A. S. M. E.*, Vol. XXV, p. 550. Road tests of freight locomotives.
- B 353. *Trans. A. S. M. E.*, Vol. XXVI. Road tests of Brooks passenger locomotives.
- B 354. Ohio State Fire Marshal's report.
- B 355. *Trans. A. S. M. E.*, Vol. XXVI. Paper on fuel consumption of locomotives.

APPENDIX

NOTE 1.

Temperature is analogous to pressure of gases. The degree of temperature is measured by means of temperature scales, of which there are two, viz., the Centigrade and the Fahrenheit. The Centigrade has the freezing point of water at zero, and the boiling point of water at 100; the Fahrenheit has the freezing point of water at 32 and the boiling point of water at 212. Let C. = degrees Centigrade; let F. = degrees Fahrenheit, and $F. = \frac{9}{5} C. + 32$; $C. = \frac{5}{9} (F. - 32)$.

Absolute Zero is the point where the volume of the gas, following Charles' law, § 12, would become zero. On the Centigrade scale it is 273 degrees below freezing, and on the Fahrenheit scale 491 degrees below freezing. The absolute zero is a convenient point from which to calculate temperatures and for that reason it is of considerable practical value.

Absolute temperature is temperature reckoned from absolute zero. Let A. = absolute temperature; let C. = Centigrade temperature; F. = Fahrenheit temperature. $A. = C. + 273$; $A. = \frac{5}{9} (F. - 32) + 273$. $A. = F. + 459$.

NOTE 2.

The specific heat of nearly all gases increases with the temperature and for that reason the specific heats corresponding to ordinary temperatures are not accurate for high temperatures. The specific heats given in columns "I" and "J" of Table 3 are not accurate enough for *close* calculations at high temperatures, and for that reason, in calculating the quantity of heat required to raise gas from standard conditions to any higher temperature, the mean specific heats must be used. The mean specific heats for the gases entering into fuel calculations are given in Table 23, p. 301.

Sensible Heat. This is the heat possessed by a body by virtue of its temperature. It is equal to the product of the specific heat per unit of mass and the temperature of the body. If the substance is stated in terms of volume, then, of course, the specific heat must also be stated in terms of volume: for the calculation of the sensible heat of producer-gas. See § 63, p. 42.

NOTE 3.

Calorific Power. This term is used to designate the number of heat units that are evolved by the combustion of a unit weight of fuel. The terms "heating power," "heating value," "thermal value," and "heat of combustion" are frequently applied to the same phenomena.

NOTE 4.

Latent Heat of Evaporation. The latent heat of evaporation of a body is the amount of heat required to change the body from a liquid state to a vapor, without change of temperature. The latent heat of water on the Fahrenheit scale is equal to 966 B. t. u. per pound, and on the Centigrade scale to 537 calories per kilogram. In both cases the temperature is that of the normal boiling point at atmospheric pressure.

NOTE 5.

The flow of a gas is, of course, influenced by the pressure. Gas pressures are stated in inches of water, inches of mercury, ounces per square inch, pounds per square inch, and pounds per square foot. The pressure used in the average gas main being low, the ordinary U-tube filled with water is used extensively for measuring the pressure, the value of the pressure being stated as so many inches of water. For the relation of the different units used for expressing gas pressure, see Table 24.

NOTE 6.

Laws of Chemical Reactions.

1. All atomic and molecular weights are relative.
2. The densities of all gases are proportional to their molecular weights.
3. "The relative number of molecules of a gaseous substance concerned in a reaction stands for the relative volume of the gas concerned in the reaction."
4. "The relative volumes of all gases taking part in the reaction are derived simply from the number of molecules of each gas concerned."
5. If the relative weights in an equation representing a certain reaction are called ounces avoirdupois, each molecule of the gas represented by the equation will represent 22.22 cubic feet. If the relative weights are called kilograms, then each molecule of the gas represented by the equation will represent 22.22 cubic meters.
6. "The densities of all gases are found experimentally to be proportional to their molecular weights."
7. "The density of any gas referred to hydrogen is expressed numer-

ically by one-half its molecular weight." This property may be seen by referring to columns "D" and "E" of Table 3.

NOTE 7.

Weights and Volumes in Chemical Reactions. By means of the application of the laws given in Note 6, it is an easy matter to determine the exact weights or the exact volumes of the different substances represented by a chemical equation. An ordinary case which takes place in the gas-producer may be illustrated by the equation for the production of water gas.

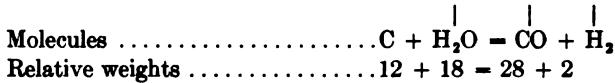

By this equation, 12 ounces or kilograms of carbon and 18 of water produce 28 of carbon monoxide and 2 of hydrogen. A cubic meter of hydrogen at standard conditions weighs approximately .09 kilograms, hence two kilograms will have a volume of $2 \div .09 = 22.22$ cubic meters. Richards* has already noted that the relation between the ounce avoirdupois and the kilogram is the same as between the cubic foot and cubic meter, hence the same value that is used to represent cubic meters may be used to represent cubic feet, when the weights are taken in ounces in place of kilograms. In other words, from the preceding, twelve kilograms of carbon uniting with 22.22 cubic meters of water vapor produce 22.22 cubic meters of carbon monoxide and 22.22 cubic meters of hydrogen, or 12 ounces of carbon uniting with 22.22 cubic feet of water vapor produce 22.22 cubic feet of carbon monoxide and 22.22 cubic feet of hydrogen. This same line of reasoning may be applied to any chemical equation with the same results.

NOTE 8.

Calorific Intensity. The calorific intensity of a fuel is the theoretical maximum temperature that may be obtained by burning the fuel under any given conditions. It is *not* proportional to the calorific power, and it will vary with the conditions under which combustion takes place.

The combustion of a fuel necessitates the raising of all the combustion products to a certain temperature. The quantity of heat in the products of combustion from a unit of fuel is the same as the calorific power of the fuel. Since the product of the temperature and mean specific heat of the combustion products gives the quantity of heat in the combustion products, we have the following equality:

* *Metallurgical Calculations*, by Dr. J. W. Richards.

Let C	= calorific power.
A and B	= constants.
M	= mean specific heat of combustion products.
t	= temperature, or calorific intensity.
Q	= quantity of heat in combustion products.
Mt	= C .

By reference to Table 23 we see that t is already a function of the mean specific heat and that the general expression for M will be

$$A + Bt = M.$$

For instance, the M of a cubic meter of H would be $.303 + .000027t$; the $.303$ corresponding to A and the $.000027$ to B .

Also
$$Q = Mt = At + Bt^2$$

but
$$Q = C$$

hence
$$At + Bt^2 = C, \text{ and } Bt^2 + At - C = 0$$

The only unknown will be t and this may be solved as an affected quadratic equation.

$$t = \sqrt{\frac{4A^2 \times BC - A}{2B}}$$

Flame temperature is discussed in Note 9.

NOTE 9.

Flame Temperature. If either the fuel or air for combustion is pre-heated, the sensible heat produced by such pre-heating is added to the heat of combustion. In other words, if 1000 heat units are brought into the combustion chamber as sensible heat, the effect in the combustion chamber will be the same as if the calorific power of the fuel was 1000 heat units higher.

If the fuel is burned with an air excess the amount of heat available from the combustion will be reduced by an amount equal to that required to heat up the excess of air to the temperature of the combustion products.

The calculation of the flame temperature available with any fuel gas and under any given conditions, first necessitates the determination of the weights or volumes of the combustion products; the method of doing this is given in § 61. The quantity of heat represented by each combustion constituent will be obtained by the use of Table 23, p. 301, and the formula

$$At + Bt^2 = \text{quantity of heat.}$$

By the results deduced in Note 8, the sum of the aggregate heat quan-

ties represented by the respective combustion products will be equal to the calorific power of the fuel. Since t and t^2 are common factors of all the heat quantities, the aggregate sum will be represented by the product of a new coefficient, As , (corresponding to A) and t plus the product of a new coefficient, Bs (corresponding to B) and t .

Let C = calorific power of fuel.
 C_p = heat carried in by pre-heated air or gas.

For perfect combustion with cold air or gas:

$$Ast + Bst^2 = C.$$

For perfect combustion with gas or air pre-heated:

$$Ast = C + C_p.$$

If the gas is burned with an air excess, then the quantity of such excess must be reckoned in with the combustion products, as explained in a 61, and will change the values of the coefficients As and Bs . In any of the above conditions the only unknown will be t , which may readily be solved as explained in Note 8.

NOTE 10.

Gross and Net Heating Values. In calculating the heating values given in columns "Q" and "R" of Table 3, the results are based on utilizing the latent heat of evaporation (Note 4, p. 292) when the water formed by the combustion of the hydrogen is condensed. In many cases, notably gas engines, the steam is not condensed and hence the heat generated by the combustion is not all utilized. The combustion of one pound of hydrogen produces nine pounds of steam, which, if not condensed, will carry away at atmospheric pressure the latent heat of steam corresponding to these nine pounds. This will be equal to $9 \times 966 = 8694$ B. t. u.; hence the heat of combustion per pound of hydrogen, where the products of combustion leave the combustion chamber at a temperature high enough not to condense the water vapor, is $62,100 - 8694 = 53,406$ B. t. u. per pound. The 62,100 is known as the gross heating value, and the 53,406 is known as the net heating value. The terms "high" and "low" are also used synonymously for gross and net heating values, and the term "effective" is used synonymously for low heating values. The use of the term "effective," however, is restricted almost entirely to gas-engine practice. Practically all gas-engine builders state the thermal efficiency of their engines in terms of effective B. t. u.; in other words, the gas-engine builder does not figure on using the heat locked up in the latent heat of evaporation of the water moisture which is formed by the combustion of the hydrogen in the gas-engine cylinder. From a thermal point of view this is not

correct, and the gas-engine efficiency should always be expressed in terms of the gross heating value of the gas delivered to the engine cylinders. The fact that the engine is incapable of utilizing all of the heat evolved by the combustion of the gas should be considered as a defect of the gas-engine system, and the engine should be charged with it accordingly. The question of high and low heating values comes in not only in connection with the combustion of hydrogen, but also with all compounds containing hydrogen. The effective heating value per cubic foot of hydrogen is 298 B. t. u.; of Marsh gas is 964 B. t. u.; and of Olefiant gas is 1573 B. t. u.

NOTE 11.

In certain cases, the production of a gas excessively high in hydrogen may make the gas very undesirable for certain classes of work; for instance, if a gas unusually high in hydrogen is used in a gas engine, more or less trouble may be experienced from back-firing or pre-ignition due to the low compression point of the hydrogen. Further, the gas engine not being able to utilize the latent heat of the condensation of the water vapor which is the result of the combustion of hydrogen, the thermal efficiency of a gas engine using a producer-gas high in hydrogen will be lower than when the producer gas is lower in hydrogen. In case producer-gas is used for burning certain classes of ceramic products, a high percentage of hydrogen, while making the gas process efficient in keeping the temperature of the producer low, may make more or less trouble in the combustion chamber on account of the action of the water vapor on the particular ceramic product under treatment. This is especially true in the preliminary stages of the burning of high-grade face brick.

NOTE 12.

Certain coals containing iron pyrites will, when stored in a damp condition, have a tendency to induce favorable conditions for spontaneous combustion. For this reason all coals of such a nature should either be stored in such a manner as to secure a thorough circulation of air, or be practically dry before being heaped up in large piles.

The percentage of volatile matter permissible in the fuel will, of course, depend on the type of producer used in gasifying and the use of the resulting gas. If the gas is to be used in gas engines, a fuel that is low in volatile matter must be used or else the fuel must be gasified in a producer-gas plant that will secure the removal of the tar before the gas reaches the engine.

The fuels that are ordinarily available at the present time for use in gas-producers are as follows:

- | | |
|--------------------------|-------------------|
| 1. Anthracite Coal. | 5. Black Lignite. |
| 2. Semi-Anthracite Coal. | 6. Brown Lignite. |
| 3. Bituminous Coal. | 7. Peat. |
| 4. Semi-Bituminous Coal. | 8. Wood. |

There is no sharp line of demarcation between the first four fuels given in this classification, and it is sometimes hard to tell where one grade stops and another begins. The anthracite and semi-anthracite are used quite extensively in gas-producers where the resulting gas is used in gas engines. Their desirability for this work is due to the fact that their yield of tar is unusually low, and for this reason it is an easy matter to make a clean gas from an anthracite coal. The other fuels are frequently used for making gas for gas engines, but their most general use is in making producer-gas for heating purposes.

The following classification gives the constituents of fuels as well as their nature and action:

NAME.	NATURE.	ACTION.
Fixed Carbon.	Combustible.	Supports combustion.
Volatile Matter.	Partly Combustible.	May be made to support combustion.
Moisture.	Impurity.	Increases heat losses.
Ash.		
Red.	Impurity.	Forms hard clinkers.
White.	Impurity.	Makes fine dust.
Sulphur.	Impurity.	Corrosive.

The volatile matter is that portion of the coal which is given off in the form of a vapor when the coal is heated. The volatile matter consists essentially of hydrogen and oxygen. The large amount of tar evolved by the gasification of bituminous coal comes primarily from the volatile matter. The problem of the removal of the tar is of such vital importance that it is discussed in detail in Chapter 23. A pound of tar contains approximately 18,000 B. t. u. Many bituminous coals, when gasified in the ordinary producer (where no provision is made for the destruction of the tar in the producer), will produce as high as 300 or 400 lb. of tar per ton of coal gasified. It is evident that the heat loss in such a plant will be excessively high, and also that the producer producing such a heat loss is not adapted for gasifying fuel of that nature.

The following table shows the principal effects of tar in producer-gas for the different classes of work, and emphasizes the importance of having the right kind of a producer for gasifying coals yielding large amounts of tar:

Tar-laden producer-gas used in

1. Gas Engines, will cause
 - (a) Clogging of pipes.
 - (b) Sticking of valve stems.
 - (c) Deterioration of valve seat.
 - (d) Sticking of piston rings.
 - (e) Leakage past piston rings.
 - (f) Increased engine friction.
 - (g) Faulty ignition due to fouling of igniter contacts.
2. Gas-Heating Furnaces, will cause
 - (a) Clogging of pipes.
 - (b) Incomplete combustion, producing smoke.
3. Ceramic Kilns, will cause
 - (a) Stopping up of ports.
 - (b) Incomplete combustion, producing smoke.
 - (c) Discoloration of ceramic product in certain cases.
 - (d) Trouble in water-smoking process.

The use of a coal containing a large percentage of moisture will result in producing adverse gasifying conditions in the producer. The amount of heat lost in a gas-producer using a fuel containing a certain amount of moisture may be calculated by means of the formula given for "N" in Table 9. If a fuel containing a high percentage of moisture is gasified in the ordinary producer, all the moisture that is given off will pass into the gas as water vapor. However, if such a fuel is gasified in a down-draft producer, then all the water vapor that is evolved from the moisture will pass down into the fuel bed and may be decomposed into hydrogen and carbon monoxide. In the latter case, the heat loss is not nearly as high as in the former case, since the water vapor passing down through the down-draft producer would replace the use of the steam for keeping the fuel bed at the proper temperature. In other words, the down-draft producer will give better results with a fuel high in moisture than the ordinary type of producer, where the gas is given off at the top of the fuel bed.

While the presence of moisture in producer-gas generally has a deleterious effect on any use that may be made of a gas, there is, however, one condition where the reverse *may* be true. Some gas-engine builders prefer to use a wet producer-gas in their gas engines, claiming that by so doing they are able to secure better operating conditions in the engines. The use of wet producer-gas in a gas engine will, of course, have a tendency to produce an action in the cylinder similar to that which takes place in a steam engine. The high temperature of the ex-

ploding gases will instantly convert the moisture into steam and this will then expand with the expanding combustion gases, and in that way it *may* increase the amount of work done in the engine cylinder. The advantages of a gas engine using wet producer-gas may be summarized as follows:

- (a) The securing of more expansion from the working fluid in the engine cylinder.
- (b) More uniform turning torque for engine.
- (c) Lower temperature of engine cylinder.
- (d) Decreased noise from engine exhaust.
- (e) Decreased temperature of exhaust gases.

In cases where a dry gas is necessary, the use of a fuel high in moisture will always increase the work of the scrubbing apparatus; not only will more water be required, but the scrubbing apparatus must be larger in order to effectively remove the moisture. If the coal contains considerable sulphur, the moisture has a doubly bad effect in that the sulphur fumes in the gas will be converted into sulphuric acid, which will corrode all wrought-iron parts in the scrubbing apparatus. This corrosive action may be so marked as to necessitate the use of cast-iron scrubbers and in fact cast-iron parts for all the connections between the producer and the scrubbing apparatus.

The term "ash" is applied to the incombustible part of fuel and includes all the mineral matter left on the grates after the complete combustion of fuel. The chemical combustion of the ash has a very vital bearing on its behavior in the gas-producer, and the effect that it may have on the satisfactory or unsatisfactory operation of the producer. Ashes are generally divided into two classes, white and red. The term "white" is hardly correct, since the ash to which this term is usually applied is more of a steel-gray color. White ashes will give less trouble in the gas-producer than red ashes. In general, white ashes will be in the form of soft lumps or fine powder. Red ash will always be in the form of hard lumps or clinkers. This brings us to the question of the difference between ashes and clinkers. The term "clinker" is applied only to the products formed in the fire by the fusing together of the different constituents that go to make up the ashes. The most active substance tending to the formation of clinker is the oxide of iron. When the oxide of iron becomes heated it will frequently combine with the silica, lime, and potash in the ash and form a semi-fluid mass, which readily adheres to the internal parts of the producer and which on cooling becomes so hard as to make its removal extremely difficult. As a conclusion of the preceding, the following general statement may be made: Coals yielding a white ash will, in general, not produce any clinkers,

while coals yielding a red ash will almost universally produce clinkers in a gas-producer; hence, inasmuch as the formation of clinkers is always undesirable, the coal yielding a red ash will not be desirable for gas-producer purposes.

The following gives some of the common constituents of ash with their specific properties. This list is not complete, but comprises all those that have a direct bearing on the behavior of the fuel in the gas-producer.

NAME.	PROPERTY.
Silica.	Produces fine sand residue.
Alumina.	Produces fine dust residue.
Oxide of Iron.	Produces clinkers.
Lime.	Flux for other impurities.
Potash.	Flux for other impurities.

The silica and alumina are the two principal constituents as far as quantity is concerned. The quantity of silica will, in general, be in the neighborhood of 54 per cent, and the quantity of alumina in the neighborhood of 36 per cent. However, the oxide of iron, although usually present in small quantities, is the most troublesome constituent of all. The lime and potash are in themselves not injurious, but by fluxing with the other impurities they frequently produce very favorable conditions for the formation of clinkers. This is especially true where the fuel is gasified in a producer having a grate. For fuels containing an ash high in oxide of iron, in addition to lime and potash, the producer so designed as to have the fuel rest on its bottom, and protected from the external air by means of a water seal, will give the best results.

The principal effect of the sulphur in coal used in a gas-producer will be to produce conditions favorable for the production of sulphuric acid from the condensation of the gas. The sulphur will generally be converted either into hydrogen sulphide or sulphur dioxide. When the sulphur dioxide comes in contact with the water vapor, quite frequently sulphurous acid is formed. Sometimes the sulphur is converted into sulphur trioxide and when this comes in contact with the water, sulphuric acid is formed. Both reactions are very undesirable, since the corrosive effect of the acid on the scrubbing apparatus will be such as to produce an unusually rapid deterioration of same. Several gas-producer plants have recently been installed in America where cast iron is used exclusively for all connections between the gas-producer and the gas engine. The acids have practically no corrosive effect on cast iron, and for this reason the use of cast iron would practically eliminate the troubles from the eating out of metal parts.

NOTE 13.

Conception of the Producer-Gas Process. The honor of the conception of the producer-gas process falls upon Achilles Christian Wilhelm Friedrich von Faber du Faur, Director of the Wurtemberg Government Iron Works, at Wasseraifingen, Germany. On December 3, 1832, Mr. Faber du Faur made the first introduction of a hot blast into a blast furnace, and from this time he gave a great deal of thought and attention to the production of combustible gases entirely separate from the blast furnace. In 1837 he started to utilize the blast-furnace gas for heating a reverberatory furnace. On account of sickness, Mr. Faber du Faur was not able to pursue his studies any farther, but communicated his ideas to Abelman and Bischof, who went ahead and built producers in accordance with the suggestions made by Mr. Faber du Faur. He was not able to build his own producer until 1843, when a small producer was placed beside the blast furnace, and the resulting gases were used for heating furnaces in connection with the manufacture of iron.

TABLE 23
MEAN SPECIFIC HEATS UP TO 2000° C.

	CENTIGRADE UNIT C. U.*	B. T. U.
1 cu. ft. H	.0189 + 0000017t	.0341 + 0000017t
1 cu. ft. N	.0189 + 0000017t	.0341 + 0000017t
1 cu. ft. CO	.0189 + 0000017t	.0341 + 0000017t
1 cu. ft. O	.0189 + 0000017t	.0341 + 0000017t
1 cu. ft. CO ₂	.023 + 000014t	.041 + 000014t
1 lb. H	3.7 + .0003t	6.66 + .0003t
1 lb. N	.2405 + .0000214t	.4329 + .0000214t
1 lb. CO	.2405 + .0000214t	.4329 + .0000214t
1 lb. O	.2104 + .0000187t	.3837 + .0000187t
1 lb. CO ₂	.19 + .00011t	.34 + .00011t

* See § 21, p. 25.

TABLE 24

COMPARISON OF PRESSURES

1 lb. per sq. in.	=	2.3	ft. water.
	=	27.71	in. water.
	=	51.71	mm. of mercury.
	=	2.035	in. of mercury @ 32° F.
	=	144	lb. per sq. ft.
1 in. of water	=	5.2	lb. per sq. ft.
	=	.0361	lb. per sq. in.
1 atmosphere	=	14.6969	lb. per sq. in.
	=	33.9	ft. of water.
	=	2116.35	lb. per sq. ft.

INDEX.

- Absolute humidity, 23
Absorbers, 172.
Action in producer, 58.
Action of steam, 67.
Advantages of gas-firing, 63.
Affinity, chemical, 30.
Agitation of fuel bed, 98.
Air, 48.
Air, Pre-heating, 62.
Air, Proportion of steam and, 69.
Air required for combustion, 40.
American Crossley suction producer, 152.
American Furnace and Machine Co. producer, 118.
Ammonia, Recovery of, 195.
Ammonia scrubbers, 195.
Ammonia sulphate, 179.
Amsler producer, 118.
Analysis, coal and ash, 84.
Apparatus, Calibration of, 245.
Argand steam blower, 75.
Arrangement of heat balance, 90.
Artificial respiration, 265.
Ashes, Removal of, 98.
Ash zone, 58.
Automatic feed, Bildt, 137.
Automatic feed, George, 139.
Atomic weights, 32.
Atoms, 30.
- Backus suction producer, 151.
Baltimore suction producer, 164.
Beaufume producer, 111.
Benzol gas, 49.
Benzol recovery, 195.
Bibliography, 277.
Bildt automatic feed, 137.
Bischof producer, 103.
Blast, Direction of, 56.
Blast, Introduction of, 98.
Blowers, Steam, 72.
Boyle's law, 23.
British thermal heat unit, 25.
Brown coal, 96.
By-product coke-oven producers; 185.
By-product coke-oven producers, Status and future, 185.
- By-product, Definition of, 177.
By-product producers, 177.
By-products, Method of recovering, 180.
By-products, Number and value of, 177.
- Calculation of heat balance, 91.
Calculation of moisture in air, 44.
Calibration of apparatus, 245.
Calorific power of a mixed gas, 34.
Calorific power, Relation to efficiency, 83.
Calory, 25.
Capacity, Thermal, 24.
Capitaine producer, 227.
Carbon dioxide, 46.
Carbon dioxide, Deleterious effect of, 79.
Carbon dioxide, Effect of feeding on, 80.
Carbon dioxide, Effect of leakage on, 81.
Carbon dioxide, Effect of temperature and fuel bed, 80.
Carbon dioxide in producer-gas, 79.
Carbonic anhydride, 46.
Carbonic acid, 46.
Carbonic oxide, 46.
Carbon monoxide, 46.
Carbon monoxide poisoning, Symptoms of, 264.
Carbon monoxide, Poisonous action of, 263.
Carbon-ratio, 35.
Carbureted water gas, 49.
Centigrade unit, 25.
Centrifugal scrubber, 175.
Ceramic kilns, Producer-gas for firing, 197.
Charles' law, 23.
Chemical affinity, 30.
Chronological record, 100.
Classification of gas-producers, 55.
Cleaning gas, Classification of methods of, 169.
Cleaning gas, Object of, 169.
Cleanliness, 98.
Cleaning plant, 240.

- Coal, 95.
 Coal and ash analysis, 84.
 Coal gas, 49.
 Coke quencher, 191.
 Cold gas efficiency, 87.
 Combination of laws of Boyle and Charles, 23.
 Combustion, 31.
 Combustion, Air required for, 40.
 Combustion, Heat carried away by products of, 42.
 Combustion, Temperature of, 31.
 Combustion, Theoretical, 36.
 Combustion, Weight and volume of products of, 41.
 Combustion zone, 60.
 Commercial gas, 45.
 Commercial gas constituents, Tabulated data of, 50.
 Commercial gases, Comparison of, 49.
 Comparison of commercial gases, 49.
 Composition of gas, Effect of different amounts of steam on, 70.
 Composition of gas, Effect of steam on, 69.
 Composition of gases by weight, 39.
 Compounds, 30.
 Condition of fire, 61.
 Condition, Standard, 25.
 Continuity of operation, 56.
 Conservatism in improvement, 103.
 Coolers, 172.
 Cost of installation, 231.
 Critical point, 21.
 Critical temperature, 21.
 Critical pressure, 21.
 Currents, Opposite, 26.
 Currents, Parallel, 26.

 Dalton's law, 24.
 Decomposition, Heat of, 32.
 Decomposition zone, 60.
 Definite proportion, Law of, 31.
 Deflectors, 170.
 Density of gas, 25.
 Destructive distillation, 33.
 Direct-firing, 33.
 Direction of blast, 56.
 Dissociation, 31.
 Dissociation temperature, 31.
 Distillation, Destructive, 33.
 Distillation, Fractional, 33.
 Distillation zone, 60.
 Division of matter, 30.
 Dowson producer, Introduction of, 102.
 Draft, Nature of, 56.
 Duff producer, 125.
 Duff-Whitfield producer, 224.

 Early use of gas-producers, 102.
 Ebelmen's producers, 105.
 Economy of water, 236.
 Efficiency, Cold-gas, 87.
 Efficiency, Conditions governing, 84.
 Efficiency, Definition of, 82.
 Efficiency, Effect of steam on, 88.
 Efficiency, Grate, 85.
 Efficiency, Hot-gas, 87.
 Efficiency, Method of finding, 83.
 Efficiency of gas-producers, 82.
 Efficiency of steam blowers, 77.
 Efficiency, Relation to utility, 83.
 Efficiency, Relation to calorific power, 83.
 Efficiency, Thermal, 233.
 Efficiency, Two kinds, 82.
 Ekman producer, 110.
 Elements, 30.
 Equation of pipes, 28.
 Endothermic reaction, 30.
 Erecting producers, 238.
 Ethene, 46.
 Ethylene, 46.
 Exothermic reaction, 31.
 Explosion, Danger of, 237.
 Explosive mixtures, 43.
 Eynon-Evans steam blower, 76.

 Fairbanks-Morse suction producer, 159.
 Fading, Effect of on carbon dioxide, 80.
 Figure of merit, 85.
 Figure of merit, Limited use of, 86.
 Filters, 172.
 Fire, Condition of, 61.
 Fire damp, 46.
 Firing, Direct, 33.
 Firing, Gas, 33.
 First aid to sufferer, 265.
 Flame, 32.
 Flame, Temperature of, 42.
 Flow of gases, 28.
 Forms of matter, 21.
 Forter producer, 121.
 Fractional distillation, 33.
 Fraser-Talbot producer, 132.
 Fuel bed, Agitation of, 98.
 Fuel bed, Depth of, 98.
 Fuel bed, Effect of on carbon dioxide, 80.
 Fuel, Character of, 94.
 Fuel, Condition of, 94.
 Fuel constituents, Effect of solid, 200.
 Fuel Gas Co. producer, 116.
 Fuel, General data on, 276.
 Fuel, Heat of combustion, 85.

- Fuel, Means of agitating, 56.
 Fuel, Size of, 95.
 Fuel supply, 53.
 Fuels, Early, 94.
 Fuel, Use of cheap, 232.
 Function of steam, 68.
- Gas, Bench, 49.
 Gas, Calculation of volume, 36.
 Gas cleaning, 169.
 Gas, Coal, 49.
 Gas, Commercial, 45.
 Gas, Composition of by weight, 39.
 Gas, Density of, 25.
 Gas discharges, Table of, 270.
 Gas, Distinction between vapor and, 21.
 Gases, Flow of, 28.
 Gases, Joule's law of, 24.
 Gases, Specific heat of, 24.
 Gases, Table of solubility of, 275.
 Gas-firing, 33.
 Gas-firing, Advantages of, 63.
 Gasification, Rate of, 233.
 Gas, Illuminating, 49.
 Gas, Natural, 48.
 Gas, Oil, 48.
 Gas, Perfect, 21.
 Gas, Place of removing, 56.
 Gas poisoning, Danger of, 263.
 Gas poisoning, Post-mortem effects, 266.
 Gas-producer, Adaptability of, 97.
 Gas-producer, Automatic feeding for, 97.
 Gas-producer, Composition of gas from, 97.
 Gas-producer, Construction of, 97.
 Gas-producer, Continuity of operation of, 97.
 Gas-producer, Future of, 255.
 Gas-producer, Heat balance of, 89.
 Gas-producer, Heat losses of, 89.
 Gas-producer power plants, 228.
 Gas-producer power plants, Status of, 228.
 Gas-producer requirements, 97.
 Gas-producers, Early use of, 102.
 Gas-producers, Efficiency of, 82.
 Gas-producers for ceramic work, Types of, 203.
 Gas-producers for gasifying wood, 214.
 Gas-producers, History of, 100.
 Gas-producers, Operation of, 238.
 Gas, Scrubbing of, 232.
 Gas, Specific gravity of a mixed, 39.
 Gas, Steam-enriched, 58.
 Gas, Temperature of, 61.
- Gas, Water, 49.
 Gas, Weight of a mixed, 38.
 Gay-Lussac, Law of, 24.
 George automatic feed, 139.
 Gram-Calory, 25.
 Grate efficiency, 85.
 Grate efficiency, 99.
 Gravity, Specific, of gas, 25.
- Heat balance, Arrangement of, 90.
 Heat balance, Calculation of, 91.
 Heat carried away by products of combustion, 42.
 Heat energy, Conservation of, 99.
 Heat energy, Storage of, 236.
 Heat of decomposition, 32.
 Heat insulation, 99.
 Heat loss, 82.
 Heat losses, 89.
 Heat losses, 199.
 Heat, Sensible heat loss of, 42.
 Heat, Specific, 24.
 Heat unit, 25.
 History of gas-producers, 100.
 Hot gas efficiency, 87.
 Humidity, 23.
 Humidity, Absolute, 23.
 Humidity, Relative, 23.
 Humidity table, 268.
 Hydrocarbons, 47.
 Hydrocarbons, Value of, 60.
 Hydrogen, 45.
- Illuminants, 48.
 Illuminating gas, 49.
 Inadaptability of gas engines, 229.
 Inadaptability of producers, 54.
- Joule's law of gases, 24.
- Kitson producer, 116.
- Labor required, 230.
 Langdon producer, 113.
 Law, Dalton's, 24.
 Law, Joule's, of gases, 24.
 Law of Boyle, 23.
 Law of Boyle and Charles combined, 23.
 Law of Charles, 23.
 Law of definite proportion, 31.
 Law of Gay-Lussac, 24.
 Law of Mariotte, 23.
 Law of multiple proportion, 31.
 Laws, Importance of, 21.
 Laws of thermal chemistry, 30.
 Leakage, Effect of on carbon dioxide, 81.
 Lignite, 95.

- Liquid scrubbers, 172.
 Loomis producer, 139.
 Lundin flat-grate producer, 214.
 Lundin stepped-grate producer, 215.
- Manufacture of producer-gas, 57.
 Mariotte's law, 23.
 Marsh gas, 46.
 Matter, Division of, 30.
 Matter, Forms of, 21.
 Means of agitating fuel, 56.
 Mechanical effect of steam, 71.
 Mechanical mixtures, 30.
 Melting points, Table of, 275.
 Merit, Figure of, 85.
 Methane, 46.
 Method of finding efficiency, 83.
 Method of supporting fuel, 55.
 Mixtures, Explosive, 43.
 Moisture in air, 44.
 Molecular weights, 32.
 Molecules, 30.
 Mond by-product producer, 180.
 Mond by-product producer, Introduction of, 102.
 Mond process, Distinctive features of, 183.
 Morgan producer, 137.
 Multiple proportion, Law of, 31.
- Nagel suction producer, 148.
 Nascent state, 31.
 Nature of draft, 56.
 Nature of producer-gas, 57.
 Natural gas, 48.
 Nitrogen, 47.
- Object of use of steam, 67.
 Oil gas, 48.
 Olefiant gas, 46.
 Operation, Continuity of, 56.
 Operation of producers, 238.
 Opposite currents, 21.
 Otto-Hoffman oven, 185.
 Otto suction producer, 149.
 Oxidation, 31.
 Oxygen, 47.
- Parallel currents, 26.
 Peat, 95.
 Perfect gas, 21.
 Pintch suction producer, 150.
 Pipe coverings, Table of efficiencies, 270.
 Pipes, Equation of, 28.
 Place of removing gas, 56.
 Poetter producer, 225.
 Poking, 235.
 Point, Critical, 21.
- Poisoning, Gas, 263.
 Pre-heating air, 62.
 Pressure, Critical, 21.
 Pressure, Vapor, 22.
 Producer, Action in, 58.
 Producer, Examination of for test, 245.
 Producer-gas, Carbon dioxide in, 79.
 Producer-gas for firing ceramic kilns. Advantages of, 201.
 Producer-gas for firing ceramic kilns, Difficulties in using, 198.
 Producer-gas for firing ceramic kilns, Objections to, 198.
 Producer-gas for firing ceramic kilns, Status of, 197.
 Producer-gas for firing ceramic kilns, Value of, 198.
 Producer-gas for firing steam boilers, 210.
 Producer-gas for firing steam boilers, Advantages of, 211.
 Producer-gas for firing steam boilers, Field for use of, 210.
 Producer-gas for firing steam boilers, Principle of use of, 210.
 Producer-gas for firing steam boilers, Requirements of, 211.
 Producer-gas, Ignorance of, 52.
 Producer-gas locomotives, 255.
 Producer-gas, Manufacture of, 57.
 Producer-gas marine plants, 257.
 Producer-gas, Nature of, 57.
 Producer-gas portable engines, 259.
 Producer-gas, Progress made in, 52.
 Producer-gas, Simple, 57.
 Producer-gas, Status of, 52.
 Producer-gas, Uses of, 63.
 Producer plant, Location of, 237.
 Producers, Classification of, 55.
 Producers, Inadaptability of, 54.
 Producers, Method of operation, 55.
 Producer troubles, 241.
 Progress made in producer-gas, 52.
- Quantity of steam, 70.
- Radiation, 27.
 Radiation coefficients, 27.
 Radiation coefficients, Table of, 268.
 Radiation loss in pipes, Table of, 269.
 Radiation loss through walls, Table of, 269.
 Radiation ratio, Table of, 268.
 Recuperation, 65.
 Recuperation, Comparison with regeneration, 66.
 Recuperation, Value of, 66.
 Reduction, 31.

- Refuse, 96.
 Regeneration, Comparison with recuperation, 66.
 Regeneration, Value of, 66.
 Regenerators, 64.
 Relative humidity, 23.
 Removal of ashes, 98.
 Repair, Cost of, 231.
 Requirements of gas-producers, 97.
 Respiration, Artificial, 265.
 Riche distillation producer, 215.
 Riche double-combustion producer, 220.
 Rotating scrubbers, 174.
 Running producer, 240.

 Saturation, 22.
 Saturation table, 267.
 Sensible heat loss, 42.
 Siemens producer, 111.
 Siemens steam blower, 74.
 Simple producer-gas, 57.
 Smith suction producer, 161.
 Smoke nuisance, 230.
 Smythe producer, 125.
 Solid jet steam blower, 76.
 Specific gravity of a mixed gas, 39.
 Specific gravity of gas, 25.
 Specific heat, 24.
 Specific heat of a mixed gas, 34.
 Specific heat of gases, 24.
 Specific heat, Variation of, 275.
 Specific volume of gas, 25.
 Standard condition, 25.
 Starting, Ease in, 99.
 Starting Engine, 239.
 Starting producers, 238.
 Steam, Action of, 67.
 Steam and air regulation, 99.
 Steam blower, Argand, 75.
 Steam blower, Eynon-Evans, 76.
 Steam blower, Siemens, 74.
 Steam blower, Solid jet, 76.
 Steam blower, Thwaite, 75.
 Steam blowers, Efficiency of, 77.
 Steam blowers, 72.
 Steam blowers, Types of, 74.
 Steam boilers, Method of firing with producer-gas, 212.
 Steam boilers, Results obtained by firing with producer-gas, 211.
 Steam, Effect of on composition of gas, 69.
 Steam, Effect of on efficiency 88.
 Steam, Effect of temperature on action, 68.
 Steam-enriched gas, 58.
 Steam, Function of, 68.
 Steam, Mechanical effect, 71.

 Steam, Object of use, 67.
 Steam, Quantity of, 70.
 Steam, Proportion of air and, 69.
 Steam regulation for suction producers, 147.
 Steam, Summary of principles involved in use, 71.
 Steam, Use of in gas-producers, 67.
 Suction producers, Introduction of, 102.
 Suction producers, American, 146.
 Suction producers, American types, 147.
 Suction producers, Classification of, 146.
 Suction producers, Definition of, 146.
 Suction producers, History of, 146.
 Suction producers, Operation of, 147.
 Suction producers, Steam regulation for, 147.
 Sufferer, First aid to, 265.
 Supporting fuel, Method of, 55.
 Summary of principles involved in use of steam, 71.
 Swindell producer, 119.

 Tabulated data of commercial gas constituents, 50.
 Tar collector, 171.
 Tar, Determination of, 249.
 Tar, Methods of elimination, 223.
 Tar, Influence of temperature on, 223.
 Tar, Nature of, 222.
 Tar, Object of removal of, 222.
 Tar, Removal of from gas, 222.
 Tar scrubbers, 193.
 Taylor fluxing producer, 113.
 Taylor producer, 126.
 Temperature, 24.
 Temperature, critical, 21.
 Temperature, Effect of on carbon dioxide, 80.
 Temperature, Effect of on operation of producer, 85.
 Temperature of combustion, 31.
 Temperature of dissociation, 31.
 Temperature of flame, 42.
 Temperature of gas, 61.
 Tension, Vapor, 22.
 Test, Duration of, 246.
 Testing producer, 243.
 Test, Object of, 243.
 Test, Report of, 251.
 Test, Value of, 243.
 Theoretical combustion, 36.
 Thermal capacity, 24.
 Thermal chemistry, Laws of, 30.
 Thwaite steam blower, 75.

- Tower scrubbers, proportions of, 176.
Troubles, Producer, 241.
Types of steam blowers, 74.
- Unit, British thermal heat, 25.
Unit, Centigrade, 25.
United-Otto oven, 188.
Unit, Heat, 25.
Use of steam in gas-producers, 67.
Uses of producer-gas, 63.
Utility, Relation of, to efficiency, 83.
- Vapor, Distinction between gas and, 21.
Vapor pressure, 22.
Vapor tension, 22.
Vapor, Water, 47.
Vapor, Water, 71.
Value of recuperation, 66.
Value of regeneration, 66.
Volume of gas, Calculation of, 36.
Volume, Specific, of gas, 25.
- Want of appreciation, 103.
Water gas, 49.
Water gas, Carbureted, 49.
Water vapor, 47.
- Water vapor, 71.
Water vapor, Determination of, 249
Weber suction producer, 150.
Wedding producer, 111.
Weight and volume of products of combustion, 41.
Weight of a mixed gas, 38.
Weights, Atomic, 32.
Weights, Molecular, 32.
Wellman producer, 132.
Wile automatic producer, 143.
Wile suction producer, 152.
Wile water-seal producer, 145.
Wilson producer, 226.
Windhausen scrubber, 174.
Wood double-bosh producer, 130.
Wood flat-grate producer, 132.
Wood single-bosh water-seal producer, 132.
Wood suction producer, 148.
Wood water-seal producer, 131.
Wyer suction producer, 165.
- Zone, Ash, 58.
Zone, Combustion, 60.
Zone, Decomposition, 60.
Zone, Distillation, 60.

89065636052



b89065636052a

✓
ayku

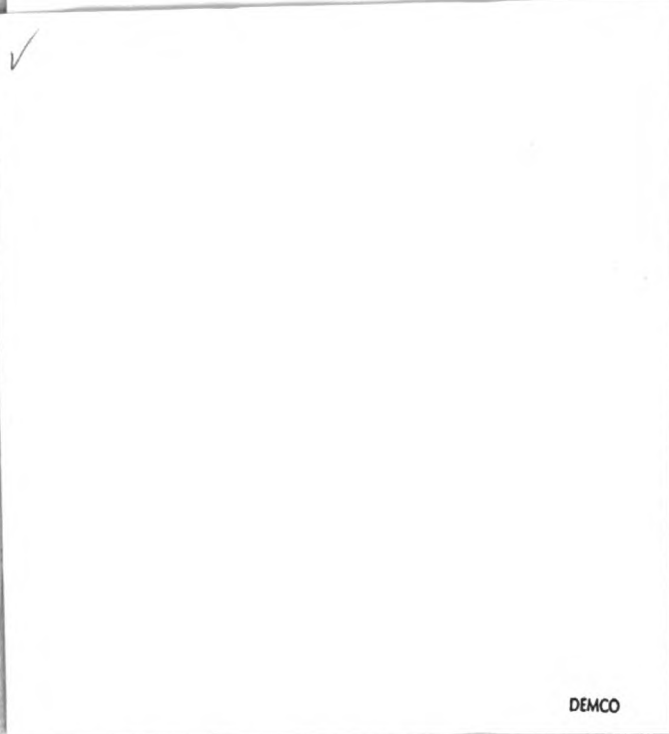

DEMCO

ENGINEERING
LIBRARY

89065636052



B89065636052A