

**AT** MICROFICHE  
REFERENCE  
LIBRARY

A project of Volunteers in Asia

Guide Book for Rural Cottage and Small & Medium  
Industries: Paddy Rice Cultivation

Published by:  
Central Commercial Company  
P.O. Box 8  
Ibaraki, Osaka 567  
Japan

Paper copies are \$12.00.

Available from:  
Central Commercial Company  
P.O. Box 8  
Ibaraki, Osaka 567  
Japan

Reproduced by permission of the Central  
Commercial Company.

Reproduction of this microfiche document in any  
form is subject to the same restrictions as those  
of the original document.

Providing the World with Cheap Food and Fuel

Guide Book for

**RURAL COTTAGE and  
SMALL & MEDIUM SCALE INDUSTRIES  
PADDY RICE CULTIVATION**

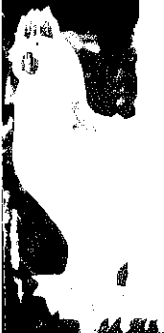

POULTRY & WHEAT    BAMBOO & CANE    GROUND-NUT    CORN (MAIZE)    COCONUT

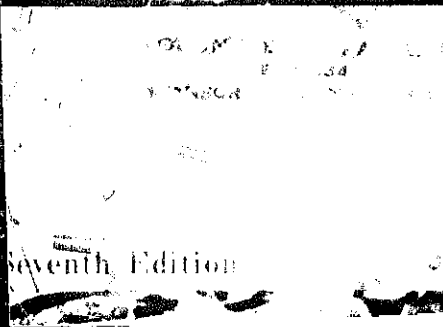

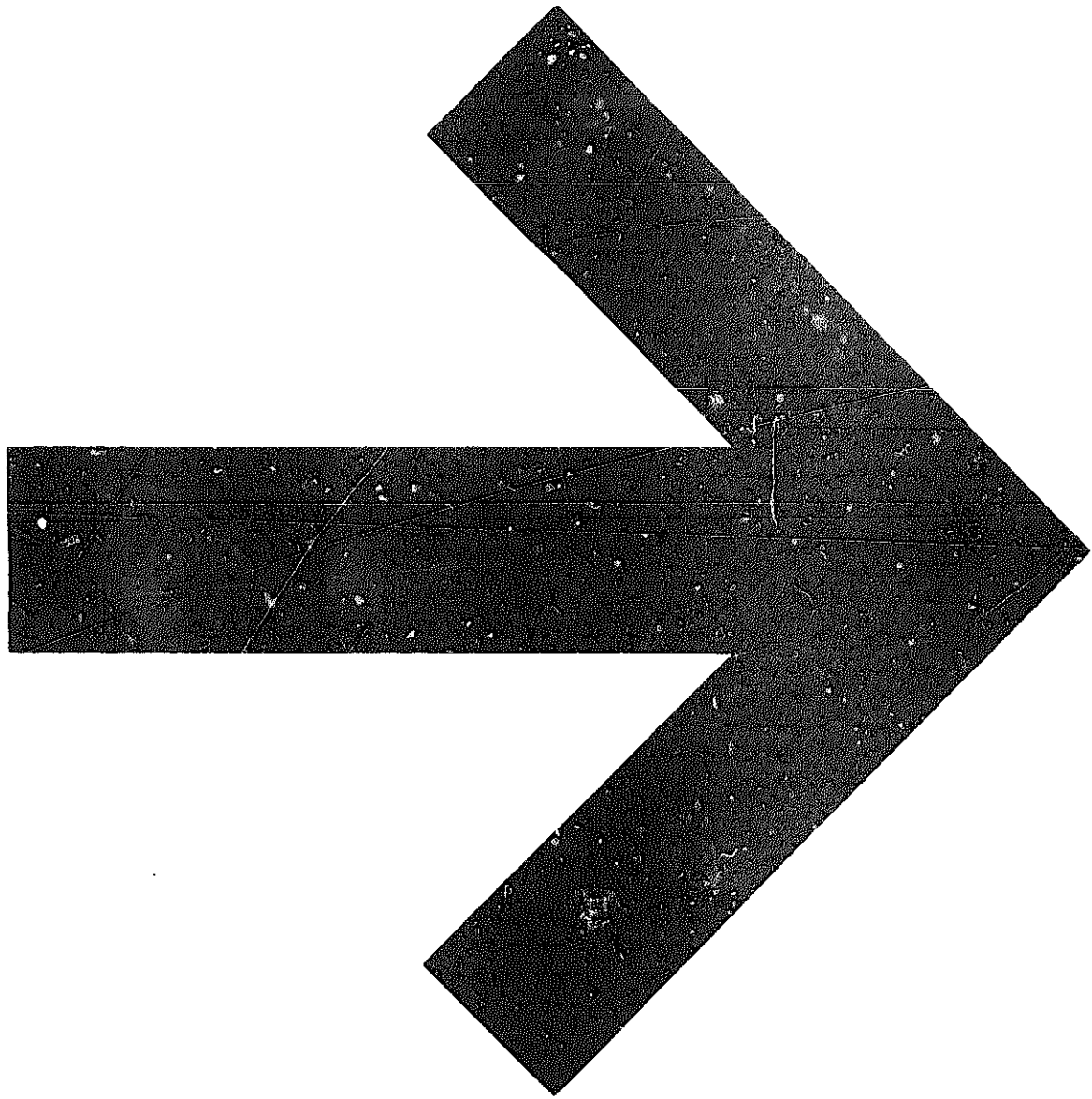

# (WINNER OF EXPORT CONTRIBUTION AWARDED) BY THE JAPANESE GOVERNMENT

## TABLE OF CONTENTS

PROMOTION OF SMALL SCALE & COTTAGE INDUSTRIES	
AND INCREASE OF FOOD PRODUCTION IN SOUTHEAST ASIAN COUNTRIES .....	Page 1 to 2
COTTAGE INDUSTRIES TRAIN PEOPLE TO BECOME SKILLED ENGINEERS NATURALLY .....	Page 2 to 3
JAPAN TO INCREASE IMPORTATIONS OF PRIMARY PRODUCTS FROM AA COUNTRIES .....	Page 4
REASON WHY JAPAN SUCCEEDED IN INCREASING RICE PRODUCTION .....	Page 5
THE EFFECT OF DEEP PLOUGHING AND HEAVY FERTILIZATION ON THE YIELD OF RICE IN KOREA .....	Page 5
PROMOTION OF DIRECT SOWING RICE CULTURAL METHOD IN JAPAN .....	Page 6 to 18
FIELD CULTIVATION AND SOIL CONTROL .....	Page 19 to 36
Japanese Plough, Rotary Break Harrow, Animal Drawn Cultivator, Walking Tiller and Tractor, 4-Wheel Tractor, Seeder and Planter, Weeder, Ridger, Bird & Animal Scarer Bang, Sprayer and Duster,	
HARVESTING AND DRYING .....	Page 37 to 40
Rice Plant Cutter and Reaper, Combine, Ventilatory Dryer, Automatic Continuous Grain Dryer, Grain Moisture Meter,	
RICE PROCESSING (THRESHING, CLEANING, SEPARATING, SHELLING AND POLISHING)	
Manually Operated Rice Processing Machines .....	Page 41 to 42
Power Rice Processing Machines .....	Page 42 to 54
Thresher, Paddy Cleaner, Grain Winnowing, Rubber Roll Rice Huller, Rice Polisher, Rice Grader, Rice Milling Unit	
WHEAT AND BARLEY PROCESSING MACHINERY .....	Page 55 to 58
Flour Mill, Wheat Separator, Noodle Making Machine, Bakery Machine & Equipment, Barley Polisher,	
BEANS PROCESSING MACHINE .....	Page 59 to 60
Beans Thresher, Separator and Grader, Bean Splitting & Dehusking Machine	
MISCELLANEOUS AGRICULTURE, FORESTRY AND MARINE-PRODUCTS MACHINERY .....	Page 61 to 75
Tapioca and Potatoes Starch Producing Method, Coffee Processing Machinery, Sugar Cane Processing Machinery, Fish Processing Machinery, Cotton Processing Machinery, Garden Tools, Portable Cutting Saw, Tea-Leaf Picking Machine	
IRRIGATION PUMP .....	Page 76 to 81
ANIMAL AND POULTRY EQUIPMENT .....	Page 82 to 88
Chaff Cutter, Ensilage Cutter, Feed Grinder, Hammer Mill, Root Cutter, Chopper Mill, Grater-Masher, Cereals Breaker, Corn Sheller, Feed Mixer, Feed Grinding Plant, Incubator, Brooder, Poultry Slaughter Equipment, Ham & Sausage Making Machine, Cookery Machine, Fish Dryer,	
PEANUT OR GROUNDNUT PROCESSING MACHINE .....	Page 89 to 91
Peanut Digger, Thresher, Washer, Sheller, Grader, Roaster, Thin-skin Peeling Machine, Butter Making Machine and Peanut Pulverizing Machine, Peanut Crusher,	
RICE STRAW & ITS UTILIZATION .....	Page 92 to 96
Rice Straw Softening Machine, Rope Finishing Machine, Straw Mat Making Machine, Three-Plate Braider, Straw Mattress Making Machine,	
RUSH AND GRASS SPLITTER AND MATTING LOOM .....	Page 96 to 98
COCONUT-FRUITS PROCESSING MACHINERY .....	Page 99 to 114
Coconut Fibrous Husk Processing .....	Page 101 to 109
Coconut-husk Crusher & Softener, Defibering Machine, Mattress Coir Carding Machine, Coir Carding Machine, Spreader, 2-ply & 3-ply Twine Making Machine, Twine Balling Machine, Mattress Coir Spinning and Curling Machine, Floor Mat Loom, Door Mat Loom, Fishing Net Making Machine, Coir Yarn Making Machine, Strand Making Machine, Rope Twisting Machine, Rope Packing Machine, Kitchen Brush Making Machine, Coconut Cracker,	
Wood-wool and/or Coir-wool Board Making Machine .....	Page 108 to 109
Coconut Hard Shell .....	Page 111
White Meat & Copra Processing .....	Page 111 to 112
Coconut-milk Juicer, Dryer, Oil Mill Machinery	
Briquetted Fuel Making Process .....	Page 110 to 114
HERBACEOUS PLANT PROCESSING MACHINERY .....	Page 115 to 120
Hand and Automatic Ramie Decorticator and Finisher, Plant Fibre Decorticator, Abaca Decorticator, Small Scale 3-ply Twine Making Machines, Small Scale Hard Fibre Rope Making Machine, Largest Hard Fibre Twine and Rope Making Machines	
RATTAN AND BAMBOO PROCESSING MACHINES .....	Page 121 to 126
WIRE PRODUCTS AND METAL FABRICATING MACHINERIES .....	Page 127 to 143
Gem Clip Making Machine, Paper Pin Making Machine, Staple Pin Making Machine, Hair Pin Making and Finishing Machine, Safety Pin Making Machine, Nickel Plating Equipment, Snap Button Making Machine, Metallic Tape Working Machine, Nail Making Machine, Barbed Wire Making Machine, Sheet Tack Making Machine, Double Stroke Cold Header, Bifurcated Rivet Making Machine, Machinescrew and Woodscrew Making Machine, Coach Screw Threading Machine, Cold Process Bolt and Nut Making Machine, Spring Coiling Machine, Chain Making Machine, Universal Net Weaving Loom, Hexagonal Wire Netting Machine, Zip-Fastener Making Machine,	
SMALL COTTAGE INDUSTRIAL MACHINERY & IMPLEMENTS .....	Page 144 to 157
Pulverizing and Grinding Machine, Concrete Block & Brick Making Machine, Chalk Moulding Machine, Candle Moulding Machine, Wooden Tooth-Pick, Ice-cream Spoon & Candy Stick Making Machines, Wire Stitched and Corrugated Paper Box Making Machine, Paper Bag Making Machine, Seal & Label Printing Press, Filtramic Home Water Conditioner, Sack and Bag Closing-Seaming Machine, Portable Circular Cutting Saw, Paper Band Making Machine, Shelf Type Ventilatory Dryer, Bucket Barrow, Wood Workig Machine, Scrap Barbecue plant,	
COTTAGE INDUSTRY AND MECHANICAL TRAINING .....	Page 155 to 156
QUESTIONARY SHEET FOR INQUIRIES.....	Page 158



## "PROMOTION OF SMALL SCALE & COTTAGE INDUSTRIES AND INCREASE OF FOOD PRODUCTION IN SOUTHEAST ASIAN COUNTRIES"

Speech of Mr. T. Kagawa, President, "GECOCO" Chuo Boeki Goshi Kaisha, member of Delegates of Japan Chamber of Commerce and Industry representing the Osaka Chamber of Commerce and Industry delivered as follow, at the First Asian Conference of Chambers of Commerce held at Manila, Philippines, inviting 57 Chambers in 16 countries: Japan, South Korea, Taiwan, Pakistan, Malaysia, Burma, South Vietnam, Cambodia, India, Hong Kong, Thailand, Australia, New Zealand, Indonesia, Ceylon and Philippines. Feb. 15-20, 1965.

It is my greatest honour to have this opportunity of expressing my views on the importance of so called "COTTAGE INDUSTRIES" and "INCREASE OF FOOD PRODUCTION" to meet the expanding populations. Both of these problems are being considered seriously as fundamental subjects for "Developing Countries" to attain a level of senior nations.

From my experiences in the past and also several inspection tours in 1962-1963 around 16 countries in South East Asian countries including Australia and New Guinea, it gave me an impression that majority of the people seem to have somewhat incorrect illusion, and are in an idea that since Japan and West Germany made a remarkable economical achievement within such a short period from the debris of the Second World War, then why not they too would be able to attain the similar achievements by starting various large industries as Japan and West Germany. For this, I have no slightest doubt they will be able to do so if they plan properly and take the similar steps which Japan and West Germany pursued from the beginning step by step. However, in contrary, instead of proper planning and practice it step by step, they started to organize large modern industries by spending a huge amount of money, and on top of this great sacrifice, God knows whether it was fortunate or not, due to the prevailing so called "Cold War", those senior nations emulate each other in the further investments as well as made loans to such large productive industries which were too far and many steps ahead of the prevailing economical situation of these countries.

As a result of recent inventories made on these already established large industries, it is to our regret that most of them are being organized in unhealthy status and did not grow up as they expected at first. Most of them neither able to pay the dividend nor even interest against those loans. Under the circumstance, very pessimistic symptoms are over-shadowing some of these ventures. For this state of affairs, I would like to recall the valuable warning made by Mr. Eugene R. Black, past president of the World Bank, that "It is a vital necessity to the developing world to realize that it is not just a matter of financing a power project but is equally a matter of assuring that the power project will be strong and solvent. There can be no large scale industry without first stabilizing the basic production method of the small and medium scale industries. If this is not done, the development process is retarded, not advanced".

I, so all of you, can not deny this realistic admonition because we also know that the top piece stone of a pyramid, one of the seven wonders of the world, would not stay steady and firm so long unless thousands of other pieces of stones are being laid underneath in layers.

It is a fact that remarkable economical achievement attained by West Germany and Japan is not what people call it as "MIRACLE". No doubt there were many other factors for the achievements, but one thing can be clearly said that both of these countries were fundamentally and traditionally well developed in small and medium scale industries long before the Second World War.

As to this country of Philippines, I am extremely glad to understand from an article and report made by Mr. Jovito A. Rivera, Administrator of National Cottage Industry Development Authority, in the 'Journal of Commerce' dated in New York, Oct. 12, 1964, that the Government of Philippines has launched a scheme to encourage the cottage industries, and it is progressing very successfully.

If there is a suitable and good example to be taken up as an model, it will be very much easier for anyone who wishes to attain the similar achievements which other nations have already reached. And for this purpose, may I suggest Japan as an example, because Japanese are the same Asian as you are, having the same complex and mode of living and many other similar customs, and so their way of occupations and methods can easily be adopted. In fact, at the beginning of MEIJI ERA Japan was a totally undeveloped nation until she was waken up by Western countries. She was then quite primitive just as same as those people in rural areas far away from towns in some of Asian countries of today. Those peasants were living on their primitive way of farming and fishing with only a hoe, spade and simple fishing nets with their own labours. Most of them were lack of educations.

No doubt Japanese achievement in prosperity today was in many ways adopted from Western countries, and they started to absorb western cultures and various machineries, but digested them in their own way. Due to their level of education at that time, those new machineries and implements imported were too complicated and required highly experienced engineers to handle, and as a result they had to modify and improve such machines to be produced by themselves much more simple to handle and at moderate prices in accordance with their requirements. So at the beginning they started to use home made simple implements modified from those imported ones for their farming and fishing, and after step by step through experiences, most of them are now able to manoeuvre modern tractors and tillers for their paddy fields and up-to-date electronic fish radar for their fishing.

These technical advancements are all outcome of their practical experiences obtained from theory or special vocational educations. Although what I have spoken was concluded in a very short sentences, however, Japanese

have been struggling along a good distance of hardships and bitter experiences and all these hardships were really "blessing in disguise". After all, she now escaped from a "bog" and crawled up to a certain level of developed countries, and you can see most of Japanese peasants today attained a good level of living.

### COTTAGE INDUSTRIES TRAIN PEOPLE TO BECOME SKILLED ENGINEERS NATURALLY

Japanese, after familiarized with simple machineries and implements for their occupations, they have succeeded to find some spare times which they could not have before—they have been practically worked with their own labours—and beside this they have now obtained certain technics to handle primary machineries which helped them very much to profitable products for their subsidiary incomes other than their original occupations. Those simple machineries and implements saved for them a lot of labours while their adoption of improved method and self contrivances on farming, their crops increased inspite of continued natures' menaces such as earth-quake and typhoons.

Further since they are now able to handle primary machineries and implements, they are apt to have further ambitions which led them start various kinds of cottage industries. Toward the end of MEIJI ERA, these cottage industries of various kind grown up further until they started to employ young boys and girls from rural area as apprentices to be trained to further expand their ability.

These apprentices were allowed to live with the employers and received practical trainings in various productions. Finally these young folks became experienced engineers and contributed to create a basical foundations for Japanese economical achievements of today. Here is one of those good examples, that is one of the largest small diesel engine maker in Shiga Prefecture, about 150 kilometers from Osaka, adapt cottage industry to manufacture some parts required for their engines. The factory is to assemble those parts finished by outsiders into complete engines, and yet their output is very remarkable. Where these important engine parts were made?

This maker have a specific system of consigning their raw materials to farmers and fishers in surrounding villages, and let these people produce those parts they require. In this way, their engines can be produced in mass quantity with lower cost to compete with other makers. I was given to understand that at the very beginning, it was indeed a painstaking problem for the said makers because those peasants neither even know what is a bolt or nut nor they ever seen before such machine tools as drill or lathe. However, with tireless perseverance of the said maker in guiding these peasants how to do it from A, B, & C, today even women and teenagers became as well experienced and able to produce genuine and standard precision parts of engines in their own small cottage during their spare time.

Of course, at the very beginning they were taught to use hand manual machine tools and now they are able to manoeuver latest machine tools powered by electricity. Further it is reported that those people so trained up in the same villages, are being welcomed by various other industrial factories with high wages, while many of them started their own small scale factories in their compounds to produce something else which are marketable.

In some Asian countries, the authorities spent so much money for furnishing vocational educations to the rural people instead of giving them practical trainings. In this case those people with fair education only could be graduated, and still these graduated people are unable to find suitable jobs or occupations by themselves. If the result shows in this manner, then what is the use of the said valuable budget spent for. Isn't it better, if in this case, that the authorities should consider to spare a portion of the said budget in purchasing primary machineries and implements suitable for the people in each area for suitable cottage industries. I believe this manner will stimulate people in voluntary assume some sort of technical professions by themselves. Don't you consider the latter method would bring a better results for the promotion of cottage industries and to contribute to provide the excessed populations with employment?

For the problem of EXPANSION OF POPULATION AND INCREASE OF FOOD PRODUCTION, do I have to clamour again here that it is being one of the serious problems which all of Asian countries are facing at now. Beside the hard task to increase the food production, we have to solve the 'problem of' expansion of population, and to find ways to provide them with suitable jobs. These are very difficult problems but anyway we have to solve them.

"FOOD IS A MUNITION OF WAR, DON' T WASTE IT". This phrase was a headline slogan almost appeared every day in the most of New Delhi's papers when I was there during the yuletide of 1962. This specific phrase recalls me of the similar clamours heard all over the United States during the First World War, when I was residing there. Since this critical problem severely prevailing over our Asian countries today, I myself consider there is no time for us to say such a passive phrase, but it is absolutely necessary that we have to "FIND A WAY TO INCREASE IT" as soon as possible. Many of Asian countries even still purchasing great quantity of foods from abroad with their valuable foreign exchange painfully earned, while suitable plans of how to increase the food production are being neglected. No one can be so long tolerated by the great sacrifice for such consumptive economy status which will continue further.

Although I do not wish at all to put my head into one's private affairs, but in spite of the aforementioned heart breaking slogan, India shut out all the importation of agricultural machineries and implements including those simple and primary ones. Well, it might be due to her own policy or inevitable emergency measure, however to consider those valuable foreign currency going out from India for foods which are entirely

consumptive commodity without any returns, isn't it better that a portion of the said money be utilized in the purchase of some implements for the farmers for their increase of food productions. Although it may take a little time to obtain an evident result, once those farmers are familiarized with these implements, the result is sure that more crops from the said soil with less labour should be obtained.

Furthermore, when they mastered these implements, it will naturally contribute to promote their voluntary productive minds in consequence and this immaterial assets will remain and even grow up further. In the meanwhile, in line with the said proceeding, India may start to produce by herself those machineries and implements required, and I believe, at that time, it is not too late for India to ban those importations. We shall remember the words "ROME WAS NOT BUILT IN ONE DAY".

Here is a good example which was reported in the editorial column of "CARIBBEAN AGRICULTURE" magazine volume 2, No. 4 dated December 1, 1964. It was written that as a result of introducing simple machineries and implements and also new methods of agriculture to the farmers there, the harvest of various agricultural crops beside sugar canes and bananas in Caribbean countries increased to break their past records.

It was known well that toward the end and after the Second World War, Japan was in a very critical state, many starved to death due to the shortage of foods beside her labours. Every inch of vacant land was utilized for cultivating foods, most of them went around in picking up edible grass. It is unbearable to explain the real facts of dire panic ruled over Japan for years, but after inexpressible struggles, today she is able to produce her main food in a quantity almost enough for her present expanded population which is now almost 100 millions. However, those expanded population did not at all help Japan in the production of food, on the contrary, Japanese agricultural population is actually decreasing, because those industrial factories require so many labours in their productions.

You may raise a question why Japan can produce enough main foods for her large population inspite of lesser agricultural population, and the answer is Japan adopted more machineries, implements and new methods to produce more foods from the same area of soil with less labour. As stated previously, almost of Japanese farmers, beside their original occupations, have enough spare time to carry on various subsidiary occupations such as dairy farms and other cottage industries. This is only due to those machineries and implements which their elders have, after painstaking and bitter experiences, improved or invented just to suit their ways.

As I was residing in California for many years, I know there are large scale farming systems being employed in the United States and also some other western countries, however, in our Asian countries where our mode of living and numerous other conditions are far different from those countries, and therefore, there are actually many difficult problems to be solved before we will be able to immediately adopt the similar systems as they are practicing. Under the circumstance, the method and implements now being adopted by Japanese are perfectly suitable for every Asian countries, and so they can adopt the same things without least trouble. Needless to say, these implements and machineries are much more simple to be operated while the cost is moderate to suit the economical situations of Asian countries. Please take this for your reference, beside other numerous agriculture, the Japanese new method of paddy cultivation which could be harvested only once a year with nature's severe menaces, still yields enough crops to feed the tremendously expanded populations.

**PROMOTION OF COTTAGE INDUSTRIES WILL PROVIDE JOBS TO THOSE EXCESSED POPULATIONS.** While we have to increase the production of foods, there is another burden that we have to also find suitable jobs for those expanded population which is growing day by day. As stated previously, most of our Asian countries, there are lack of industrial establishments to absorb these excessed populations, and you can see jobless and idling people are increasing day by day. There are only few industrial factories to provide them with suitable jobs because most of them are peasants without up-to-standard educations and also technical knowledge. And therefore, the best way, I would like to suggest, is to guide them to assume primary cottage industries which do not require expensive, complicated machineries and also deep technical knowledge. This method will stimulate them to grip further ambition and be able to attain higher technics from which they might be able to voluntarily establish their own steady and lasting occupations.

**TURN WASTE INTO REMUNERATIVE PRODUCTS.** So called "A spectacular show in economic recovery of Japan" is not so colourful as it appear outwardly, in fact it owed very much to those screen shifters behind the stage. One of the most important scene shifters was the "Good Utilization of Waste". Everybody knew Japan does not have raw materials or primary products, and beside her importations, she had to find various ways of utilizing waste and manufacture them into the valuable products for her domestic consumption and also the excess for export. From the time of disastrous war, Japanese utilization of waste was so remarkable, and has greatly contributed Japan when the materials were unavailable.

So let us now carefully look around where we will be able to find there are many and so many waste which could be turned into very useful products. Needless to say, those coconut husks, the waste from copra productions, could be turned into coir, ropes, brushes and mats while the coir dusts could be fabricated into a pressed hardboard for construction as well as for insulating materials. We also know that even the coconut shell could be turned into hard carbon charcoal, while pineapple rinds can be used as raw materials for industrial alcohol. Beside these, how about those saw dusts, peanut shells, paddy husks and stalks which are being thrown away scattered around us?

It is to my surprise to know that some of our Asian countries are still importing toilet papers from abroad while in Japan, at this moment more than 95% of toilet papers are being turned out from waste papers, which

you can easily pick up from paper bins around the street corners. And one of good examples is that the famous invention of plastic called 'Vinyon' is actually turned out from clay which could be found everywhere. I can remember a very good verse in a hymn saying "All things around us are given from heaven above", and therefore, I trust that our mother nature has so geniously made all things useful for us, and even those waste too. Promotion of cottage industries, utilization of wastes will also find jobs for those overflowing populations.

#### JAPAN TO INCREASE IMPORTATIONS OF PRIMARY PRODUCTS FROM AA COUNTRIES

I used to hear complaints from my friends in many Asian countries that Japan did not purchase adequate quantity of their products to balance the mutual trades. Against these complaints, I personally fully sympathise with, but speaking very fairly, it is a fact that if you have a commodity with fair quality and reasonable price which your customer needs very much, then you are sure to sell it without a single arguments. On the contrary, I have now electric washer and electric house cleaner and try to sell these things to the people in rural area where no electricity is available, labours are abundant and cheap, would I be able to succeed?

Many years ago, as I said, I was residing at Sanjoquin Valley in California, raising potatoes and onions. Without a careful investigations, I simply considered that those soils were unsuitable for planting other crops such as rice and soyabeans but after painstaking researches and improvements on the same soil by junior people, the same area became one of the largest producers of soya bean and also rice in the States.

Another story is, in 1963, I met a youngman in Dacca when I was there on my inspection tour. I happened that I knew him before whilst he was in Japan studying at Kyoto University. He told me with his bright and pleasing face that he finally succeeded to grow soya beans which were never grown before in Dacca. Of course he told me that he took more than two years of disappointment and failures before his success. So I am now praying that his success will also stimulate other many Pakistani to assume the similar endeavours for the sake of Pakistan's progress.

Up to very recent year, it was a common sense of the people that pearl only be cultivated in seawater, but now it was found after several years of researches that pearl can be cultivated in fresh water too. Now let us recall the words "FRONTIER Spirit" of the late President Kennedy of the United States and also our old proverb of 'God will help those help themselves'. You can produce many things which other Asian neighbours are ready to buy, if you are fully intended to do so. The important thing is that you should make a good market research of neighbouring countries and make sure what they are in need of. Please do not forget that Japan with a population of 100 millions and many industrial factories, always requires various ranges of raw materials and primary products beside more foods for her expanding population, from nereby Asian countries. And whatsoever you are in a position to supply, there is a steady and good market for you.

In conclusion of my speech and after considering from every angles, may I suggest that Japan is one of the most well developed countries in small or medium scale industries which could be taken up by the neighbours as a good model.

There are various institutions, establishments for practical and theoretical studies. There are many displaying rooms for those implements and machineries which are suitable for cottage industries. There are experimental farms for agriculture and agricultural implements too. In this connection, it can be said in one word that you will never fail to find a place where you wish to see them, and these various facilities are all meant for you, and Japan is not at all illiberable to open all of the cards in her hand to our neighbouring Asian friends.

Although you might be able to see those things which I have said here in my speech, at everywhere in Japan, but Osaka is specially recognized as the center of small scale or cottage Industries of numerous kinds, and therefore, the Chamber of Commerce of Osaka has a special facility at your disposal, and to assist you in everyway from inspection up to your finding of suitable factories in which you wish to make a short stay for practice.

For my own researches, fortunately I am myself possessing Display and Demonstration Halls where comprehensive Japanese machineries and implements for cottage industries and agriculture are being displayed at all time, and there is also a wide experimental farm annexed to it. So I am only too pleased to receive your kind visit whenever you have such an opportunity. Moreover, in 1970, Japan is going to organize the first World Trade Fair in Osaka, and all of us presenting here, as well as in Japan cordially invite you to visit Japan at that occasion when we are quite prepared to furnish you with our available facilities you may require.

Remarks: The above speech was accepted as the frank and straight forwarded advice by all members attended with most popularity, impressing the m deeply why the agriculture and cottage industry are essential in improving and developing their countries. Mr. D. A. Munoz, president of Chamber of Commerce of the Philippines, sponsor, acclaimed the speech as "timely and vital". Mr. T.Kagawa was honored with a "Blue Ribbon Medal" for his untiring contribution for past 40 years and "CECOCO" with "Export Contribution Award" by the Japanese Government.

## REASON WHY JAPAN SUCCEEDED IN INCREASING RICE PRODUCTION

It would have been unthinkable in prewar days when Japan had to import large quantities of rice not only from its overseas territories in Korea and Taiwan but also from the China mainland, Indonesia and Burma. In 1935, its peak prewar year, Japan produced only 8,619,000 tons of rice. In 1962, harvest was 13,009,000 tons, the highest in this nation's history. However, in 1963, after rain and cool temperature sparked predictions of a poor crop, the harvest is put at 12,879,000 tons, second only to the 1962 record year.

Of course, the fact that many more Japanese are eating bread to-day than they did in 1930's is one factor which helped Japan gain self-sufficiency in rice. But this is not all. The total acreage devoted to rice cultivation in 1936 was 3,070,000 chobu (7,675,000 acres). In 1962, it was only 89,000 chobu (222,500 acres) more, an increase of only 2.9 per cent. But total harvest in 1964 was 51 per cent over the 1935 crop.

The reason why such remarkable increase is attained is attributed to introduction of improved agricultural machinery such as walking tiller, small and medium sized tractor, thresher, harvesting combine and rice milling machine etc. to better use of fertilizers, advanced farming techniques. However, in looking forward the scientists are already experimenting with the direct-sowing in paddy fields in order to save time and labour of transplanting the paddy-seedlings by hand to eliminate the drudgery back-breaking work.

This change enabled Japan to channel more of the foreign exchange it earns from export into the import of raw materials, machinery and other essential items and through them to attain the prosperity and higher standard of living the Japanese people can enjoy to-day.

## THE EFFECT OF DEEP PLOUGHING AND HEAVY FERTILIZATION ON THE YIELD OF RICE IN KOREA

By Mr. Young Chul Chang

As early as 1954, an inspection of high yielding paddy field belonging to the Irrigation Association disclosed that capable, experienced farmers produced from 6 to 8.55 M/T<sup>a</sup> per hectare of polished rice. This is two to three times normal yields. Careful examination of these fields showed that they were either irrigated by sewage coming from a village or fertilized with large quantities of compost, manure and fertilizer. Further studies also revealed the fact that in contrast with other areas, the high yielding fields were well drained and had been deeply ploughed for several years.

From these observations it was concluded that high rice yields, like those referred to above, are possible for any farmer if his soil is properly handled. It must be deeply ploughed and heavily fertilized with the major elements nitrogen, phosphorous and potassium. Compost or farm manure must also be added to improve soil conditions and provide part of the minor elements (manganese, boron etc.).

Previous studies on the subject described in the literature were also reviewed. However, none of those reported increased yields over normal culture of more than 50 percent as a result of deep ploughing and heavy fertilization. In this regard, it is suggested that the roots of some rice plants, which cannot penetrate a hard subsoil, will also not grow well when this is broken up and incorporated into top soil.

In 1956 a complete factorial design experiment was established at the Agricultural Experiment Station, Suwon, Korea, to obtain more information on the problem. It consisted of ploughing paddy soil at these different depths, adding compost and fertilizer at three different amounts, and replicating each treatment five times. Meter square plots were measured out on a poor loam soil having a percolation rate of 5 to 10 c.m., per day. The soil of one group of plots was excavated to a depth of 10 c.m., usual ploughing depth; another set, 20 c.m.; and a third set, 30 c.m. The soil to each depth was replaced by top soil, which was brought from a neighboring field and thoroughly mixed with the fertilizer and compost. Ammonium sulphate, triple superphosphate, potassium sulphate and compost were added at the rate of 142 k.g., 115 k.g., 60 k.g. and 10 M/T, respectively, per hectare in the usual manner. Every plot was surrounded by a concrete frame.

The results for each year were about the same. Taking the year 1959 as an example, the yield of polished rice per hectare on soil ploughed 10 c.m. deep and receiving normal fertilization was 3.7 M/T; 4.4 M/T with twice and 5.1 M/T with three times the normal fertilization rate. On the other hand, the yield from the soil ploughed 20 c.m. deep was 4.6 M/T; 5.5 M/T and 6.0 M/T, while that from the soil ploughed 30 c.m. deep was 5.0 M/T; 5.8 M/T and 6.6 M/T respectively for the three fertilizer rates.

The yield from the soil ploughed to the greatest depth and receiving the heaviest fertilization compares favorably with those obtained by the better farmers belonging to the Irrigation Association as mentioned above. However, additional yields up to 10 M/T of polished rice per hectare were obtained through drying the soil, and supplying mud containing considerable iron, calcium, magnesium, etc., and dense transplanting.

The above data indicates the possibilities for increasing rice yield. Since the results cover a five year period they should be considered as significant.

Although the wet paddy field Japanese Rice Trans-planting Method was introduced in the previous issues of "CECOCO" Booklets ending The 6th Edition, in this 7th Edition a new method of The Direct-Sowing Rice Cultivation is introduced, which is becoming very popular among the rice growers in Japan. Because it saves labour and time to a great extent.

## DIRECT-SOWING RICE CULTURAL METHOD IN JAPAN

By Professor Toraji Tahara, Agricultural Department, Tokyo University of Agriculture and Industry

### I. POPULARITY OF DIRECT SOWING METHOD:

Although this method has been started in order to counter act against the shortage of labour during the Second World War among the Japanese rice growers, it slowly ebb-tided after the war for a time being.

However as per the TABLE No. 1 it again suddenly became popular, and in the year 1963, about 8,700 hectares of Japanese paddy fields except in Hokkaido, adopted this method. And it is well expected among the farmers that this method will be a new technical trend in the rice culture.

Table No. 1 Practiced area of Direct-Sowing Rice Culture investigated by Extension and Education Section, Department of Agriculture and Forestry of Japan.

Prefecture	1955	1961	1962	1963	ratio 1963/1962	Unit in hectare	
						machinery utilized area (1963)	area by large tractor (1963)
Hokkaido	—	8,374	10,130	9,401	93%	—	—
Aomori	1	4	5	18	374%	—	—
Iwate	4	2	35	39	112%	—	—
Miyagi	12	8	25	28	112%	16.8	(3.0)
Akita	1	—	16	37	239%	—	—
Yamagata	5	2	91	92	100%	33.7	(7.3)
Fukushima	3	1	62	88	143%	70.6	(11.2)
Ibaraki	185	30	285	427	150%	41.6	(4.4)
Tochigi	24	9	187	139	74%	12.5	—
Gunma	5	43	325	245	76%	16.4	(3.5)
Saitama	1,753	104	1,080	1,284	119%	166.9	—
Chiba	7	4	44	64	145%	24.0	(24.0)
Tokyo	6	1	5	17	320%	1.5	—
Kanagawa	—	1	41	103	247%	112.5	(10.0)
Niigata	16	5	46	65	142%	17.4	—
Toyama	2	6	39	49	125%	—	—
Ishikawa	—	1	11	15	133%	2.7	(0.3)
Fukui	2	1	3	15	383%	0.3	—
Yamanashi	73	29	55	80	146%	5.8	(0.8)
Nagano	—	5	96	182	189%	44.9	(51.4)
Gifu	18	73	404	299	74%	30.6	(16.2)
Shizuoka	14	28	243	380	156%	45.0	—
Aichi	155	109	687	549	80%	—	—
Mie	263	195	185	175	94%	10.7	(0.9)
Shiga	—	2	105	72	68%	2.1	—
Kyoto	142	34	190	233	123%	17.9	—
Osaka	7	2	26	13	148%	1.6	—
Hyogo	117	368	695	378	54%	46.8	(0.5)
Nara	131	1	13	14	106%	4.9	—
Wakayama	—	3	50	75	149%	10.6	—
Tottori	43	15	180	105	58%	24.8	(3.1)
Shimane	17	3	116	197	171%	12.6	—
Okayama	405	89	870	798	92%	143.6	(2.0)
Hiroshima	—	10	253	647	256%	31.1	—
Yamaguchi	7	10	497	840	169%	50.7	—
Tokushima	—	—	19	46	247%	1.1	—
Kagawa	—	10	136	102	75%	2.9	—
Ehime	—	5	113	80	71%	32.8	(1.2)
Kochi	—	—	26	66	258%	—	—
Fukuoka	51	33	306	165	54%	3.4	(12.5)
Saga	—	10	120	115	96%	9.7	—
Nagasaki	3	1	7	75	1065%	33.8	(28.1)
Kumamoto	136	33	77	154	200%	23.9	—
Oita	3	3	24	62	260%	4.1	(0.3)
Miyazaki	4	4	138	171	124%	13.7	—
Kagoshima	8	—	19	230	1197%	9.4	(1.8)
Total, 46	3,625	9,671	18,080	18,427	102%	1,135.4	(182.5)

### II. DIRECT-SOWING RICE CULTURAL METHOD:

At this moment, the direct sowing method adopted by various places in Japan, can be classified as follows:

Direct-sowing Method	{	Direct sowing on submerged fields	{	on cropless fields
		Direct-sowing on dry fields		between rows of other crops

A direct-sowing method on submerged fields is practiced chiefly in the colder parts in the country. Seeding is done after plowing, harrowing and puddling in the same manner as the traditional transplanting method.

A direct-sowing method on dry fields is usually practiced in the warm areas. Plowing, harrowing and seeding is carried out in the drained state, and after about 30 days the field is brought into submergence.

A direct-sowing method between rows of other crops is usually done in those wheat, barley, vegetables and other feed-stuff fields. Till those gutters between ridges, manure, sow seeds and then fill the field with water.

From the point of mechanization, in the case of direct-sowing on submerged fields, it requires to do puddling operation before seeding, and therefore it restricts the uses of large type tractors. Under the circumstance, at this moment, a hand seeder or a small type power seeder, or seeding from the air by using a helicopter are popularly employed.

While in the case of direct-sowing on dry fields, after plowing, harrowing and sowing in the drained state there is still about 30 days of dried period before submergence, therefore the uses of various machineries including various types of tractors are possible. And mechanization can easily be applied in full.

### III. PROBLEMS IN TECHNICAL POINT FOR DIRECT-SOWING METHOD:

To make the direct-sowing method a success, it requires ;

- a) To uniform the germination of rice seed.
- b) To attain effective control of various weeds.
- c) To manure the soil in a logical and practical way.

#### 3-1. HOW TO PROTECT OBSTACLES AGAINST THE GERMINATION OF SEED

The direct-sowing method being employed previously was done mostly without proper soil preparation. However, recently tillers, the tilling and levelling etc., are highly advanced, and a high percentage in germination of seed rice could be obtained.

From the nature of germination of rice seed, there are still many problems being existed, and effective counter acts against these problems are so important to have the direct-sowing method be a success.

The effective methods in preventing those obstacles against a proper germination of rice seed are described in the Figure No. 1.

Figure No. 1 - How to protect obstacles against the germination of seed rice.

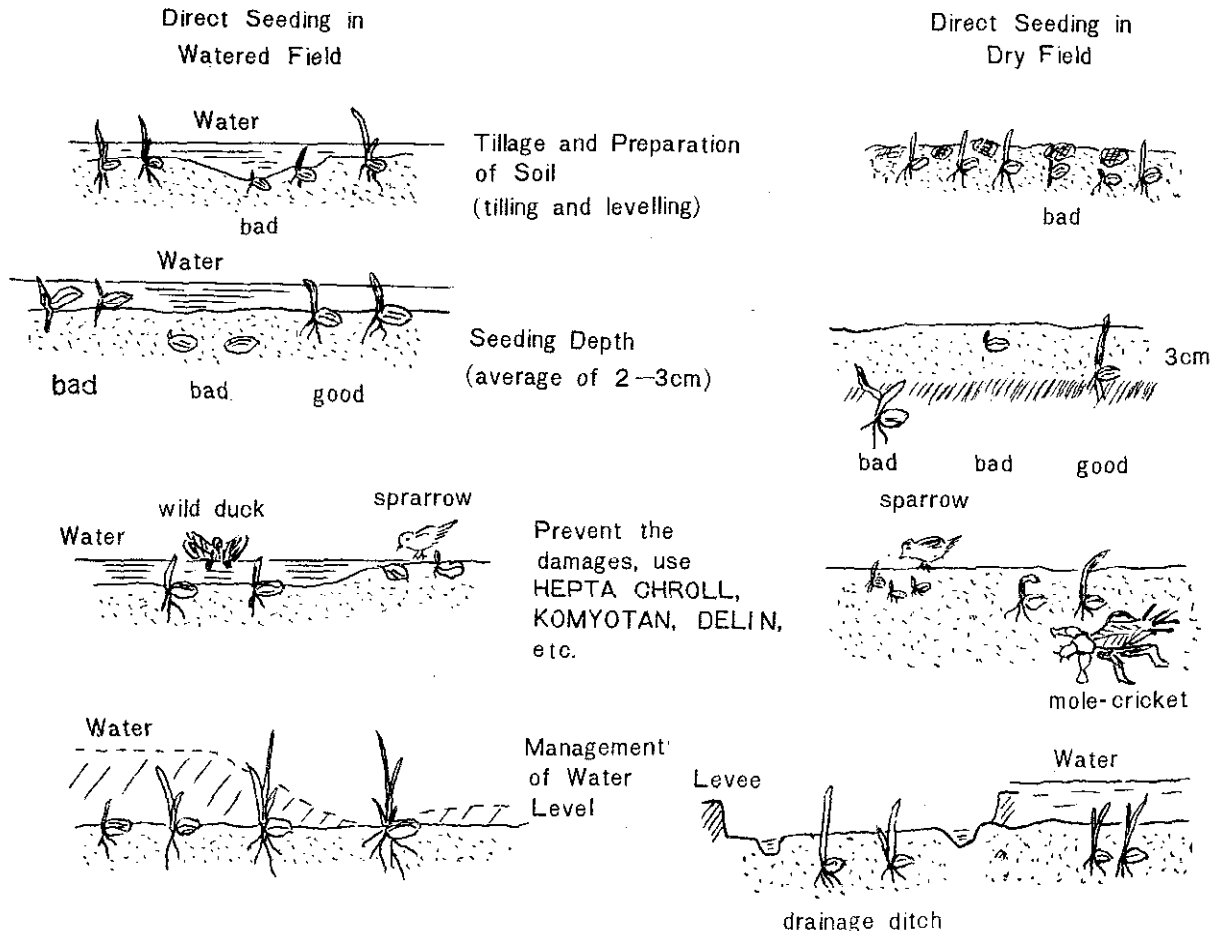

In the direct-sowing on dry fields, the water contents in the soil itself are always unstable when seeds start to germinate. Some fields are too dry and some fields too wet. Further, rice plants are apt to get damaged by mole-crickets and also sparrows etc.

To counter acts against these obstacles and damages, it is necessary to have soil be broken down in to fine grains—to break soil down properly to sizes under 3 cms. in diameters—and seeds must be sown at an average of 2 cms. to 3 cms. depth. Further, to prevent these damages by mole-crickets etc. use HEPTACHROLL (3% in weight of dried rice seed) or KOMYOTAN (1% in weight of dried rice seed) to be coated to the seeds before sowing, or spread DELIN on the soil at the time of soil preparation.

For those fields which are easily set flooded, it is necessary to make proper drainages around the fields for draining of surplus water.

In the method of direct-sowing on submerged fields, it is necessary to level and prepare the soil evenly so that seed rice should lay steadily on the soil without floating by the water. This will be the most suitable condition for getting the uniform germination of rice seed. Should those seeds germinate below the water level, for a long time, they will be damaged according to the shortage of oxygen, and seedlings become to have "floating or falling". Therefore, the adjustment of water level is quite important problem to be considered.

### 3-2. ELIMINATION OF GENERAL WEEDS —

In the direct-sowing method, it is usually advisable to have the soil plowed, levelled and prepared earlier than the usual time of transplanting method. And to make direct-sowing method a success, the elimination of general weeds is very important.

In the transplanting method, the uses of chemicals for weed control became popular now, however in the direct-sowing method, it still requires hand labours combined with hand operated machines. Anyway, in the very near future, the uses of various chemicals for weed control will become popular.

The weed control in the dry fields is, firstly to have the soil properly tilled for two or three times to bury those winter and early spring weeds deeply in the soil itself. The counter measure after seeding in dry field period is to properly eliminate those weeds including barnyard grass etc. by use of herbicides, and after submergence, if there are still remaining weeds, the use of rotary weeder is effective. And in those fields where less weeds grow, use chemicals to subdue them. See the counter measures against weeds described in the Figure No. 2.

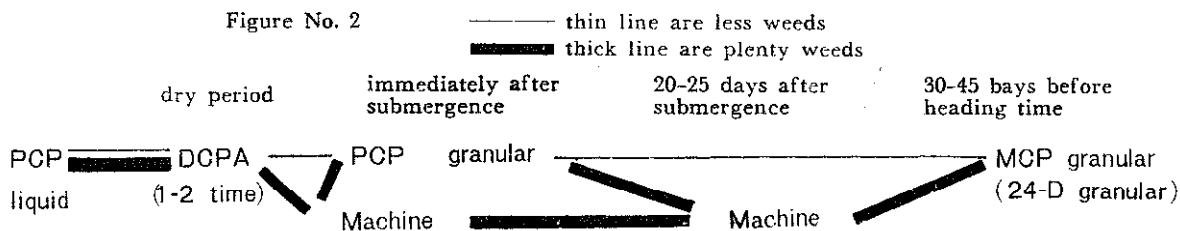

Where less weeds are found in the field, use chemical only to subdue, and it will be adequate, but where plenty of weeds are found, use machine to eliminate them immediately after the field is irrigated. And then use the same machine again 20 to 25 days after submergence.

The use of machine immediately after submergence will also prevent "water leaking" in the field which was caused during the field was dry. Whenever the surface of the soil is too hard and also the need of weeding after filled with water, use power cultivator previously before the submergence. This is effective for weeding and cultivation between rows of rice plants for softening the surface of soil.

In the Direct-sowing on submerged fields, the uses of DCPA chemical to control those weeds is restricted. Those places where water is unable to drain from the field it is recommended to use machine (rotary weeder), and thereafter the system of weed control is similar to those methods to be applied in the direct-sowing on dry field as per the Figure No. 3.

Figure No. 3—Weed control system of Direct-sowing Method on Submerged Fields

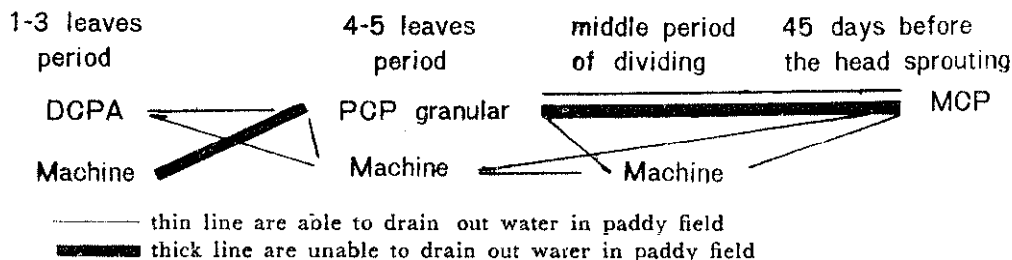



### 3-3. APPLICATION OF FERTILIZER

In the direct-sowing on dry field, AMMONIUM type Nitrogen fertilizer which is applied during dry period, will be nitrified and leached away after submergence, therefore, it is generally accepted that 20-30 percent of the total nitrogen is applied at the seeding time, and the rest is applied immediately before submergence. Phosphorus and Potassium fertilizers are applicable before seeding.

In the direct-sowing method on submerged fields, there is not much difference in fertilizing method with the case of transplanting method, however in those places where climate is warm, the quantity of basic application should be less and the quantity of top dressing should be applied more.

## IV. USE OF MACHINERIES IN DIRECT-SOWING METHOD ON DRY FIELDS :

### 4-1. SOIL PREPARATION ;

In those fields where weeds found in plentiful and stubbles of winter crops are remaining, intensive soil preparation is necessary to bury those weeds and those remaining stubbles properly. Break down the soil properly into fine sizes of less than 3 cms. in diameters, level the surface of soil and finally level the entire surface of the field to an average height of plus minus 5 cms.

### 4-2. WORKING METHOD AND SYSTEM ;

In the direct-sowing on cropless field, methods of soil preparation are mainly divided into two as per Figure No. 4, machineries to be used for this purpose are described in the Table No. 2.

Figure No. 4

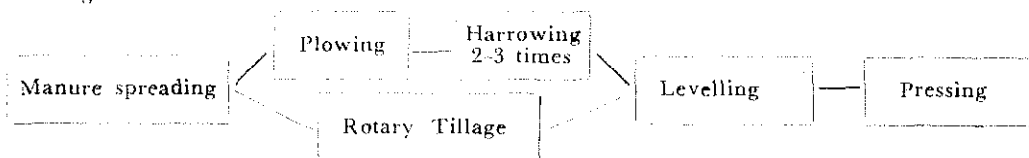

Table No. 2

Machine	Manure Spread	Plowing	Rotary Tillage	Harrowing	Levelling	Pressing
Small 2-wheel Tiller	Trailer	Plough	Rotary or Screw	Rotary	Cage-Rotor and Rake	
Medium / Large Tiller / Tractor	Vac. Car Spreader	Plough	Rotary	Rotary Disk Harrow	Harrows	Culti-Packer

In those fields for single crop where plenty of weeds are found or soils are difficult to dry, and also in the double crop fields where plenty of weeds are found and high stubbles of the previous crops are still remaining, it is advisable to use Japanese type plough or mouldboard plough. In those single crop fields where soil get dried easily during winter time, and weeds are found less, and in those double crop fields where working time before and after seeding is rather short, it is advisable to use rotary tiller.

In ploughing work, it is important that weeds and stubbles on the surface should be thoroughly turned over otherwise it will be difficult to use seeding machine.

In the case of ploughing by a large type tractor, the use of fixed bottom plough or multiple Japanese plow make the plough ridges too high and soils will become uneven, therefore in the first stage of harrowing, it is advisable to use one-way disk harrow. The number of time required for harrowing and also for the use of rotary depend on the nature of soil, however it is 2 to 3 times harrowing will be usually necessary.

The last operation of harrowing is mainly for cleaning and good finishing of soil preparation, so it is advisable to use a cage-rotor with a rake or levelling-plate with small tillers, and tooth-harrow or plate-harrow with medium or large size tractors.

To prevent the damage of mole-crickets and other insect, use ALDOLINE or similar type of chemicals to be spreaded over the soil before seeding, when the soil get too dry, repress the soil by culti-packer before seeding.

### 4-3. FERTILIZER APPLICATION AND SEEDING OPERATION ;

Main Point: In relation to the variety of rice plant and to the spacing of seeding, it is suggested to decide the method of planting and also the density of seeding previously.

The depth of seeding should be about 2 to 3 cms. deep, and see that seeds should be averagely sown into the soil.

Density and spacing of seeding: The usual spacing of seeding for direct sowing carried out in various places are described in the Figure No. 5, such as in equal wide seeding of average distances in double-row seeding of double distances and in broadcast seeding etc. However in the case of direct-sowing on dry field, the first and second methods are quite suitable.

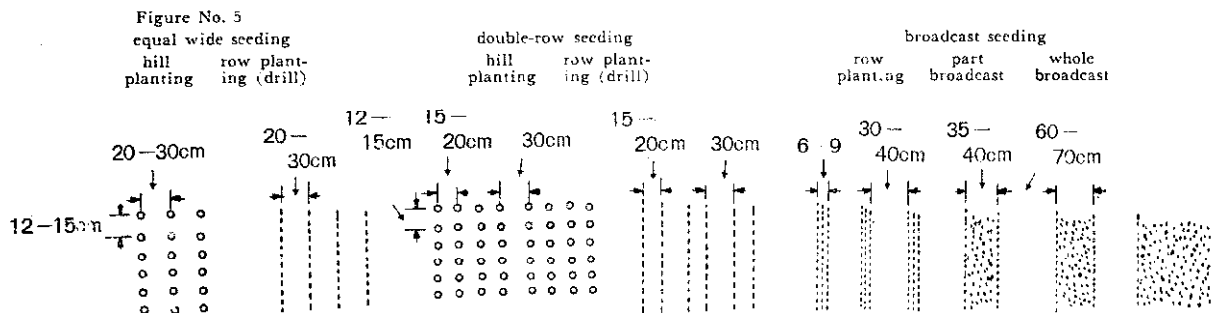

Quantity of seeding is usually 5 to 8 kgs. (in weight of dry paddy rice) per 10 ares and this will be able to obtain 500 to 600 seedlings per 3.3 sq. meter (0.033 are). This is considered to be the best for a high harvesting. The regulation of seeding quantity can be adjusted by the seeding machine itself, however it is suggested to calibrate seeding quantity after the seed are properly selected and then coated in HEPTACHROLE or other chemicals

**Manure:** Basic fertilizers should be mixed with the soil at the time of harrowing in the case of seeding by a hand seeder/planter. And in the case of using a power seeding machine, fertilizer should be applied at the same time of seeding. And in this case, it is advisable to use chemical fertilizer which is easily flow from the fertilizer-hopper of the seeding machine.

**Seeding:** Machines to be used for seeding and fertilizing in dry field are usually three types of Driving, Trail and Multi-planter as described in the Figure No. 6.

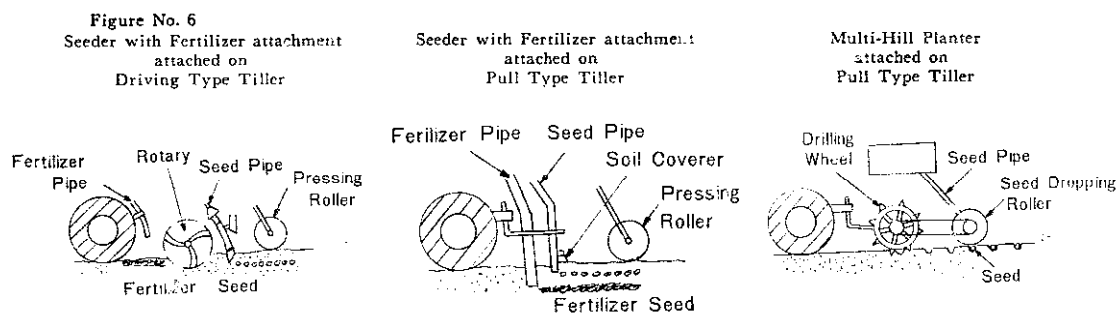

The Driving type seeder with fertilizer attachment usually fitted with rotary or screw tillers, and at the same time, a fertilizing and seeding devices are incorporated. The fertilizer which come down from hopper through the pipe spreading evenly on the entire width of the tiller. At the rear portion of rotary, 2 to 4 rows of pipes are installed through which seeds are being distributed evenly on the soil. After the seeds are sown, the finely broken mold tilled up rotary-blade/tines, will automatically cover up those seeds, and then properly repressed by the pressing-roller which was installed in place of rear wheel at the rear portion of the tiller. These seeding and fertilizing devices are operated by the man power of the tiller through the shaft, sprocket gear or directly driven from the transmission gear.

The Pull Type seeder with fertilizer attachment usually drawn by a Pull Type tiller. It is comprising of seed hopper, fertilizer hopper, furrow-opener, pipes for seeding and fertilizing together with soil-coverer and pressing-roller etc. Adjusting the fertilizing furrow to be about 3 cms. deeper than seeding furrow. The covering soil will be automatically flow into the seeding furrows after seeds are sown. The covering soil should be 2 to 3 cms. deep at an average, and this operation can be done by adjusting the seeding furrow and soil-coverer in accordance with the soil condition, at the time of seeding. In using seeding and fertilizing devices which are operated by a leading-wheel, it is necessary to adjust the proper contact of the said wheel and the soil. There are various types of seeding and fertilizing device and seeding pipes, and there are 3 to 6 rows types are available.

The Multi-hill planter are usually used for seeding of wheat and barley, and the fertilizing should be done previously to seeding, and also soil covering after seeding should be done with a rake separately. Therefore this specific type is rather unefficient when compared with the former two types.

Seeding by medium and large type 4-wheel tractors are generally practised by a seed-drill. There are seed-drill with a width of 1.5 to 2 meters for tractors with a main power capacity of under 25 h. p.-mounted type with 7 to 11 rows and a wide of 2.7 to 3.4 meters-trained type with 13 to 16 rows-power capacity of over 26 H.P. for those tractors with a main as per the Picture No. 7 and No. 8. However the constructions of these implements are similar to seeders with fertilizer attachment trained by small type tillers.

Picture No. 7  
Seeder with Fertilizer attachment  
mounted on medium type tractor



Picture No. 8  
Seed-Drill trained on  
large type (35HP) tractor

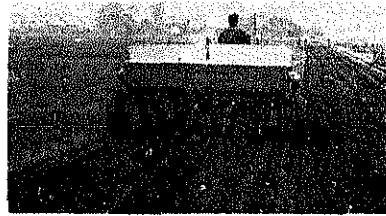

In seeding by a small type tiller/tractor, the marker should be previously set so that seeding could be done in a continual straight column (equal wide seeding). For an instance, for a proper width of seeding, the marker should be laid or placed as per examples given in the Figure No. 9.

Figure No. 9

- a- distance between center of tiller's wheel and center of seeders' hopper
- b- width of spacing between row

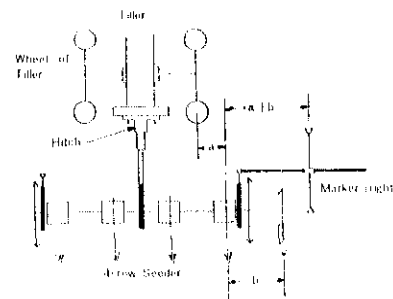

In the case of medium or large type tractors, the mounted type Seed-Drill could be raised automatically by a hydraulic system of the tractors so that the tractors could be turned back at any part of the field. The examples of turn-back operations are described in the Figure No. 10, and the continuous operations in the field as well as the corner operations at the head-land of the field can be done.

Figure No. 10

Working Process by mounted type Seed-Drill, Seeding width in 2.4 meter

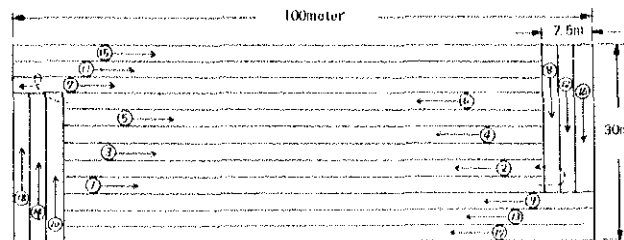

For a trained type, as the "turn-back" operation is not easy, it is advisable to operate in the ways as described in the Figure No. 11. However, in the above both cases, the advancing course should be straight by use of markers set before the operation.

Figure No. 11

Working Process by trailed type Seed-Drill, Seeding width in 3.3 meter

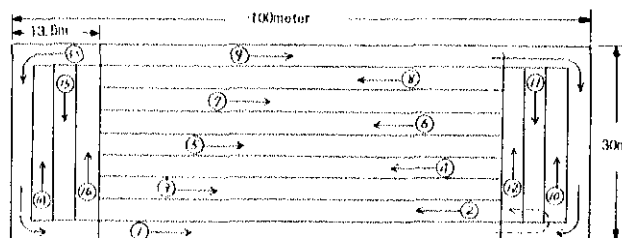

## V. USE OF MACHINERIES ON SUBMERGED FIELDS:

### 5-1. TILLING, PUDDLING AND LEVELLING:

**Point:** Although the fundamental preparation works are similar to the case of traditional transplanting method, for a good average germination and growth of seedlings, puddling and levelling should be done carefully so that the field surface may become even and smoothed out.

**Method of Works:** In the case of using small driving type tiller, tilling and puddling are done by a rotary-tines. And for a good levelling work, use levelling-plate with rotary-tines. In using a pull type tiller, a cage-rotor with rake is generally used. The important things to be considered at the time of working are to break the soil as much as possible into fine grains and do not over puddling.

### 5-2. SEEDING:

**Point:** Adjust the seeder in accordance with the soil condition at the time of seeding, so that rice-seed does not float up by irrigated water, or not be buried too deep in the soil.

**Seeder and Operation:** In the direct sowing on submerged field, the use of machineries after puddling is rather difficult, and so a hand seeding machine is popularly utilized. However, recently seeder for a small and medium tiller/tractors have been placed on market to replace the said hand seeding machine.

Beside the traditional "Octopus" type hand seeder (for submerged field) and hand seeder for condition of letting-out-water with 2 to 4 rows is now being popularly utilized. The Figure No. 12 shows a double-rows seeder for submerged field. This specific type seeder has to floats at the front with 'V' shaped seeding furrow opener and the driving wheel operates the seed-dropping-roller to drop the seed continually. After the seeds are sown, then the "net-press-roller" will repress the soil softly to have the seed stay stably in the surface soil.

Figure No. 12 Paddy Seeder for submerged field.

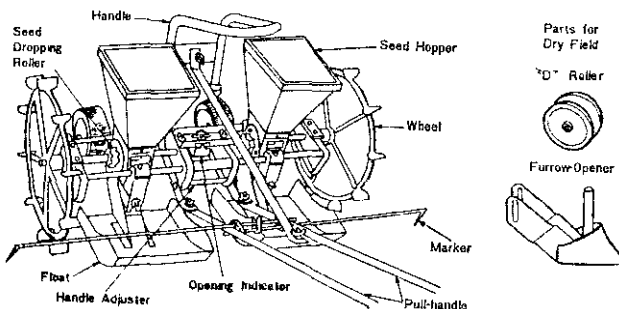

When an "Furrow-Opener" instead of floats and a roller are changed, this also can be used for dry field seeding.

In using these seeders, it is necessary to letting-out-water after levelling, so that the soil should become "Jelly-like" condition (A proper condition can be tested by using a hand to cut a furrow of about 3 cms. deep, and see that soil do not return into the said furrow) which is the best soil condition for seeding.

By the recent various improvement of seeding machines for field, "W"-shape furrow-opener combining with "H"-shape press-roller was devised. It opens furrows in "W"-shape and seeds are sown on the top-plane of the said "W" shaped furrows. "H"-type press-roller is used as per the Figure No. 13 to press the seed after seeding. In this case, when the field is irrigated after seeding, the water will run through the narrow trench on both sides of "W" shaped furrows evenly so that seeds sown on the soil will not float, and then water will be automatically adjusted to prevent the shortage of oxygen in the soil which is necessary for good germination and seedling standing.

Figure No. 13 "W"-shape Furrow-Opener and "H" type Press-Roller

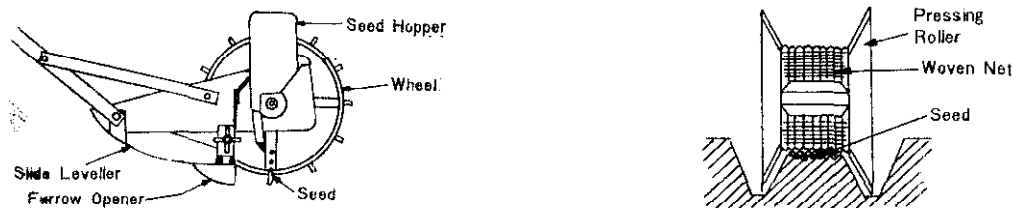

Seeding device for a small tractor/tiller for use on submerged field usually has 4 to 6 rows, and its construction is quite similar to those hand seeders. The wheel-tack on the field made by the tractor could be erased off by the levelling-plate attached to the front portion of the seeding device, and at the same time, the furrowing device fitted to bottom of levelling-plate, will cut furrows for seeding. In the operation, the wheel position should be fixed at "offset" to the planting-row. After all it is expected with a good hope that improvements of seeding device for medium riding type tractor will be on the market soon.

## VI. WORKS FOR INTERCULTURE AND WEEDING :

### 6-1. REDUCTION OF LABOURS FOR WEEDING ;

The labour for weeding usually occupies 15 to 20% of the total labour required in rice culture, and as the weeding labour usually practised in very hot summer days to reduce the said labour for weeding as much as possible is being desired by every rice planters.

After the Second World's War, the labour required for paddy-rice culture is much reduced by mechanization, and the labour for weeding is also much reduced in line with the labours for soil preparations, but still the labour for weeding occupies the great part of the total labour. As per the Figure No. 14, when compare the average labour required for rice culture in 1960, the weeding labour has been reduced by 20% in 1962.

Figure No. 14 Table of Reduction of Working Hours, in compared 1962/1960

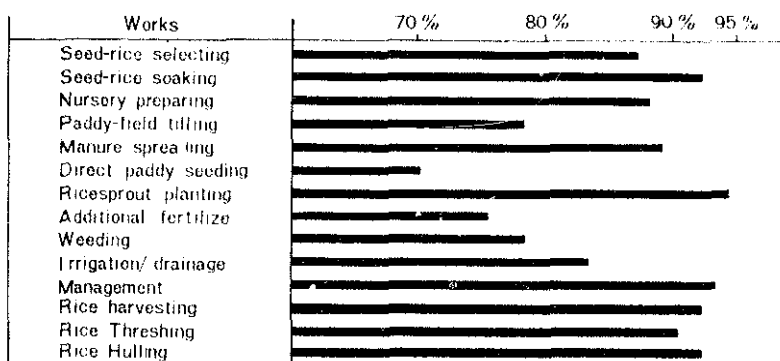

The main factor of the labour reduction is due to the popularity of using chemicals for weeding. In the year 1949 "2,4-D" (2 : 4 di-chloro-phenoxy-acetic acid) has been found, in 1951 "MCP" was started in use, and then in 1956 "PCP" came into market. The area of paddy fields using these weeding chemicals has been increasing rapidly so that in the year 1962, about 2,190,000 hectare, which is more than 3/2 of the total paddy fields in Japan are utilizing these weeding chemicals,

The popularity of using weeding chemicals signifies that in using these weeding chemicals, both the reduction of labour and merits in economy are obtainable.

However each weeding chemical has its own specific nature, and in this connection, the using of weeding chemical combined with mechanical weeding are very essential.

### 6-2. VARIOUS WEEDING METHOD :

#### a) Weeding by burying weeds by means of ploughing or tilling.

Weeds' seeds are generally contained in upper layer of the soil, and the depth of emergence of weeds is generally very shallow. However, it is affected by some environment conditions as per the Figure No. 15, for an instance. A test on barnyard grass seed shows that the depth of emergence become more shallow according to the soil moisture increase. While as per the Figure No. 16. Since the furrow slice is turned over by plowing, most of the seeds of weeds contained in the upper layer soils are plowed under the deepen layer where the seeds can not easily germinate.

Figure No. 15 Relationship between the Depth of emergence of Barnyard-grass and Soil-moisture

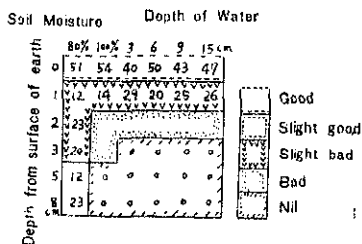
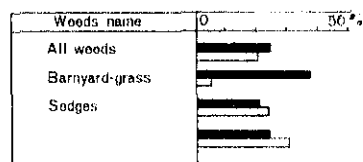

Figure No. 16 Ploughing method and Weeds



#### b) Weeding by Machineries.

This method has been in utilization for a long time by employing various types of paddy field weeders between the rows of rice plants. Hand operated weeders are being widely used, however recently there are farmers began to use power weeding machines drawn by small tiller/tractor.

In the power weeding, there are two methods such as using weeder trailed by a small type tiller and using weeder device attached as driving wheels of a tiller. However, the former method is quite popular in Japan.

Figure No. 17 Power Weeder for Small Type Tiller,  
 (1) Rear attach Type Weeder (2) Front attach Type Weeder

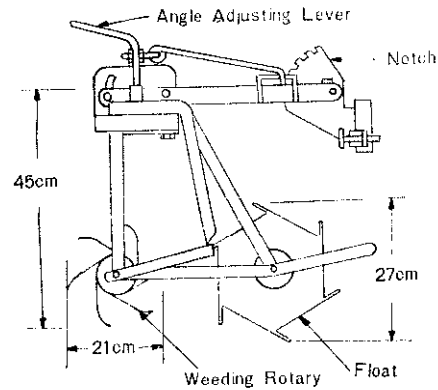
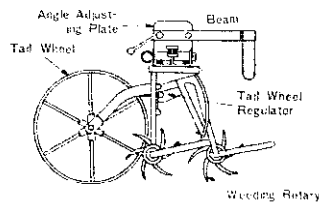

When using trailing type weeder, tractor's wheel should be small as about 36 cms. and 63 to 68 cms. in diameters for a inside row type and a double row type respectively, as per the Figure No. 18. The wheel should be made of cast iron with about 6 to 8 cms. lug width as per the Figure No. 19.

Figure No. 18  
 Inside Row Type Double Row Type

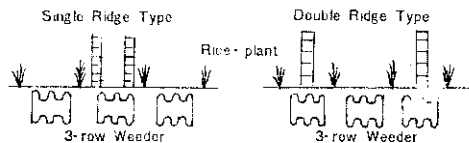
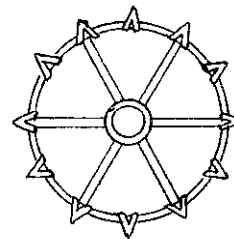

Figure No. 19  
 Iron Wheel for Submerged Paddy Field



In comparing the wheels of inside-row type with double row type, the former type has a smaller diameter, and therefore working it in a deep submerged field is rather difficult. Further it is also limited for use on fields where the row spacing is more than 36 cms. width, however at the edge or end of the field the maneuvering is more easier and consequently the damage of rice plant is a few. On the other hand, in the double row type wheel is more stable, and it can be operated in straight course because of the size of its wheel. And it can be used or operated in those fields where the width of each ridge is narrow - about 30 cms. width. However the turning operation at the end of rows is rather difficult.

In operating these machines, the wheel distance and its maneuvering sphere must be preadjusted in accordance with the planting method, and the hitch point of weeder to the tractor should be adjusted according to the depth of soil and also the height of the operator himself. Further, it is quite necessary to adjust the angle of weeder, so that the maneuvering of the machine will be at always parallel to the surface of soil. In the case of weeder having tail wheel, effective depth of rotary is adjusted by the tail wheel, and in the case of weeder having front float, can be done by handle lever and also the angle adjuster, as per the Figure No. 20 and No. 21.

Figure No. 20  
 Adjustment of Trailing Type Weeder

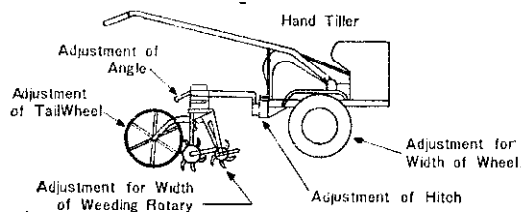
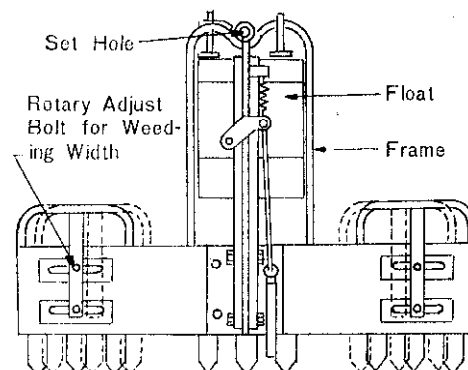
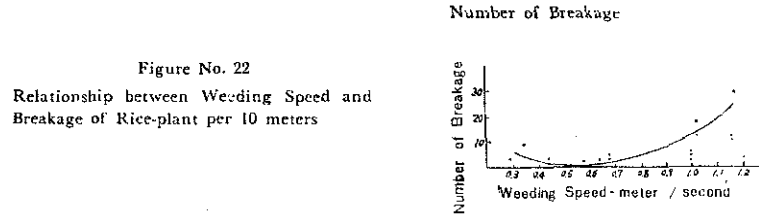

Figure No. 21  
 Adjustment of distance between Rotary



The most suitable condition of depth of water for weeding is about 3cms. indicate that soils at high portions of the field could be seen just at the surface of water.

The speed for weeding shall be about 0.5 to 0.6 meters per second, while a faster speed will increase the damages of rice plant. And this is clearly explained in the Figure No. 22.



The first stage weeding is usually done about 14 to 15 days after the transplanting when the rice-plants or roots are still young and small. In this connection, the weeding speed of the machine must be slow enough so that it will not damage those young plants. However, speed can subsequently be increased from the second stage when rice plants grow up stronger and larger.

There are three turning methods of operating machine at the end of levee as shown in the Figure No. 23. If there is a farm road existing, then it is the best to run the machine up on the road for turning.

However in this case, one must watch the height, and the angle of levee and the direction for turning.

Figure No. 23 - Turning Method

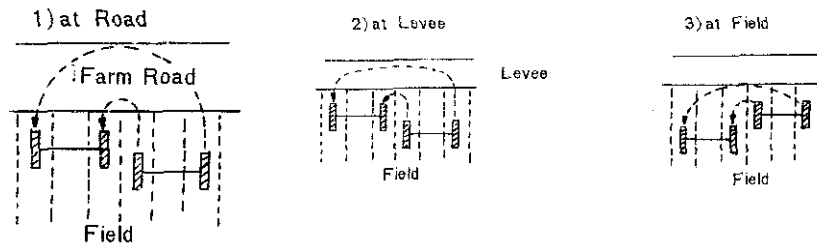

As per the Figure No. 24, in using a tiller, the height of levee should be about 30 cms. and the angle should be about 43 to 45 degrees. And in the case of using a universal type (driving and trailing) tractor, the height should be 17 to 20 cms. while the angle should be about 42 degrees so that the tiller is turned or maneuvered easily. If the farm levee or the dike of the field is too high or too soft, and the turning of the tiller in the field is necessary, a special care must be taken to avoid damages to rice plants.

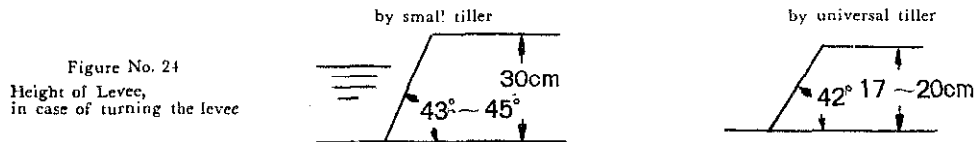

Watching the result of works done by a power weeder, one can firstly notice that there are damages to rice plants at the time of turning. But these damages can be avoided greatly by the care and skillness of the operator. As per the Table No. 3, the percentage of plants damages is actually rather small, and it shows between a maximum of 0.42% and a minimum of 0.14% against the total plant standing. Further, in considering the revival of these damaged plants, the total damage at the maximum would be less than 0.5%, so the effect on the rice yield is quite unconsiderable.

Table No. 3 Occurrence of Plant Damages per 10 ares at Aichi Pref., Japan

	Brand of Machine	Breakage roots		Damage roots		Remark (Spacing)
		development	ratio	development	ratio	
1st weeding	'M'	23.8 roots	0.14%	31.0 roots	0.18%	39×15 cm
	'H'	58.8 "	0.36%	51.8 "	0.31%	- do -
	'K'	70.0 "	0.42%	79.8 "	0.48%	- do -
	'M'	38.0 "	0.21%	33.0 "	0.18%	30×18 cm
2nd weeding	'M'	25.2 "	0.15%	29.4 "	0.17%	39×15 cm
	'H'	44.9 "	0.29%	50.4 "	0.30%	- do -
	'K'	26.6 "	0.15%	53.2 "	0.32%	- do -
	'M'	27.0 "	0.20%	48.0 "	0.26%	30×18 cm

The effectiveness of power weeding is extremely high, and twice operation as per the No. 25 will eliminate almost of all weeds in the field. The efficiency of work done is depending upon the shape of the field, method of planting and also the skill of the operator. However at the first stage weeding, 40 to 50 minutes per 10 ares, and at the second stage, 30 minutes per 10 ares are usually required.

Figure No. 25 Effect of Weeding by Weeder

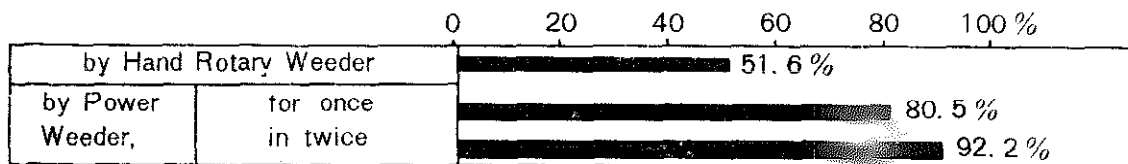

c) CHEMICAL WEEDING :

There are so many kinds of chemicals available for weeding in paddy fields, and it is necessary to choose the most suitable one for own field. The machines for applying these chemicals are available as follow :-

For spray liquid

- c-1. Hand Sprayers Shoulder, Hand types, (with or without pressure type).
- c-2. Powered Sprayer.
- c-3. Power Mist sprayer.
- c-4. Medium and Large Type Tractors' sprayer (trailed and mounted type).

For Broadcast granular

- c-5. Hand granular/broadcaster
- c-6. Power granular broadcaster mounted on small tractor
- c-7. Liquid and granular spraying by helicopter.

Those liquid sprayers - item c-1 and c-2 - are manufactured specially for weeding purpose only, and items c-3, and c-4 are for universal purposes.

Hand operated sprayers are shown as per the Figure No. 26. Shoulder type liquid sprayers without pressure is operated by the gravity of the liquid, and liquid is sprayed from a nozzle, while the same with pressure type is operated by a pressure pump of about 0.3 kg. per sq. cm., and able to spray liquid out from 2 to 4 nozzles at a time. These types are fitted with small liquid tank, and their working capacity 40 to 50 minutes per 10 ares.

The power sprayer is shown available as per the Figure No. 27. Power sprayer is attachable to the front portion of a small tiller - having a pressure capacity of 10 to 25 kgs. per sq. cm. - and it is operated by the main power of the tiller to 5 meters in parallel spraying. This type is quite suitable for weeding during the field is dry, and nozzles are fitted to those spray-nozzle-pipes as per the Figure No. 28 and being adjustable for suitable height and width. The diameters of nozzles are about 7 to 8 mm.

Figure No. 26 Knapsack Type Sprayer

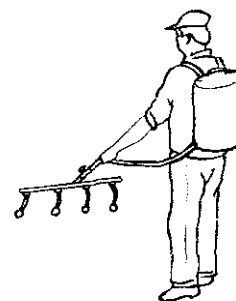

Figure No. 27 Power Sprayer attached on Tiller

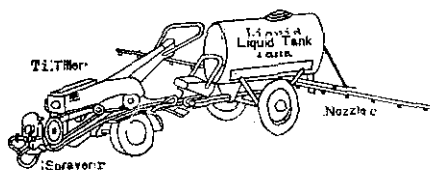
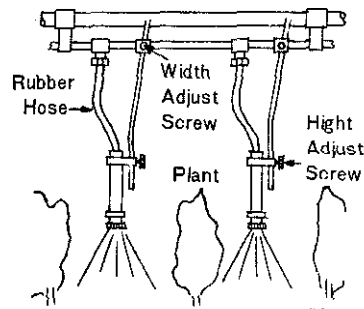

Figure No. 28



The most important problem in spraying liquid chemical for weeding is to adjust the height of spraying, so that spray should not cover the rice plants themselves but only to cover those weeds on the surface of soil. The details of this method is shown in the Figure No. 29. In this case, one must consider to use a proper nozzle-size suitable to the plant spacing etc.



Figure No. 29 Height and the State for spraying  
1) good condition

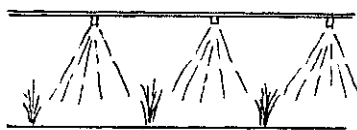

2) lower condition



3) higher condition

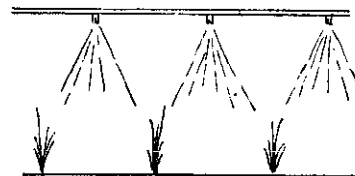

To use those sprayers for spray liquids, it is necessary to see that the machine and the liquid-tank are well cleaned after the uses, so that the liquid would not affect the next use of the same sprayer for different purposes.

The method to use a high presser sprayer with long nozzle beam, mounted on a tractor is highly efficient, and it is expected that this method will become more popular for spraying wide areas in a near future.

Granular type chemical spreading method became popular because of weeding chemicals showing a trend to be manufactured in granular type. This form is so easy to handle and requires no water. While, a small quantity will be adequate for use when compared with other forms.

A type of hand operated granular spreader/broadcaster are shown in the Figure No. 30. The construction of this type is so simple. By turning the handle of the machine, the chemical or fertilizer in the upper tank is pushed out by the vibration of a propeller, and spreaded by a subsequent rotor. The effective spread distance or area is about 4 meters in width, and operators walking speed is about 25 meters per minutes. Therefore, the working capacity of this spreader is about 15 minutes per 10 ares.

Power granular broadcaster, as described in the Figure No. 31, is a type by installing a chemical tank or hopper and spread unit on the front portion of a small type tiller, and advance in the rice field to spread from its 2 nozzles. Its tank capacity is about 10 kgs., when to apply 3 kgs. of "PCP" granular per 10 ares, 30 ares of field could be spreaded without further reloading. In this type, there are "parallel" and "up-right" cranking impellers. The construction of parallel cranking type is shown in the Figure No. 32. Granular come down from the tank or hopper to the impeller case through two pipes, while the power from the tiller rotates the impeller and spread out to the both sides of the tiller. The quantity of spreading can be adjusted by the regulating shutter located just below the hopper. All the handling and controlling of this machine can be operated at a remote from the handle of the tiller. The efficiency of this machine is about 5 minutes per 10 ares with spreading width of 10 meters.

Figure No. 30  
Hand Granular Broadcaster

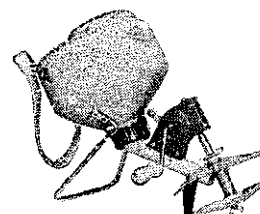
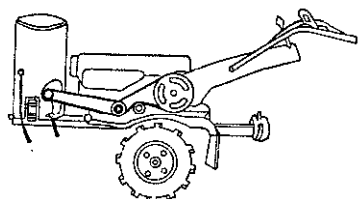
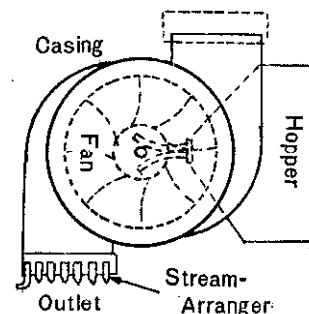

Figure No. 31

Power Granular Broadcaster  
attached on Small Tiller



Construction of Horizontal  
Shaft drive Power Granular Broadcaster



In the use of liquid or granular chemical for weeding spray, the most important problem is to spray evenly on the surface of the field, and therefore the spraying and spreading speed should be always in an average.

The spraying and spreading speed can be calculated as below ; -

$$V = 1000 \times \frac{q}{L \times Q}$$

V = Spraying/Spreading speed in meter per minute.

L = Effective spraying width in meter.

Q = Quantity of chemical to spray/spread on 10 ares in liter or kg.

q = Spraying capacity of nozzles per minute in liter or kg.

### 6-3. RECENT WEEDING METHOD IN PADDY FIELD:

Weeding in paddy fields are usually done by the above mentioned methods and machines in accordance with the conditions of the fields. Recently weeding are popularly done by a combination of chemical and mechanical control.

The fundamental weeding systems are shown in the Table No. 5, and they are all related to the time of rice plant growth and kinds and quantities of weeds.

In the transplanting fields, weeding are done just before or after the trans-plantation, by using "PCP" granular chemical for eliminating annual weeds. After that in those fields where plenty of weeds are to be found, use weeding machine for once or twice, and spray "MCP" and its analogues 30 to 45 days before heading time of rice plants.

The above are the fundamental system of weeding. In the direct sowing method on dried field, the growth of weeds are so great during the soil is still in a dry condition, so that the problem of weeding at this period is so important. DCPA (stump emulsion) is quite effective against barnyard grass etc. though not injurious to rice plant in the fields. However this specific chemical is not effective against those small weeds which will emerge after spraying the above, and therefore when the period of dry condition is prolonged, it requires to spread the same chemical more than twice. However, in this case there is a problem of economy for the cost of chemical soil so that it is suggested to irrigate water into the field about 5 days after the first spraying.

For weeding in dry fields, use "PCT" liquid immediately after the seeding, and about 20 to 25 days later spray DCPA when barnyard grass etc. start to grow. After about 5 days later then fill the field with water. After 5 days of submergence, further spray PCP granular, and thereafter take such methods similar to the case of transplanting method. Should weeds still remain after the above spray, then finally use power cultivator or a weeder.

The above are fundamental weeding system for direct sowing on dry fields. However, it is necessary to employ investing-ploughing in the soil preparation and to establish a wide and various suitable weeding methods.

In the direct sowing on the submerged fields, the first stage weeding is very important. In the case of submerged fields whether the field is able to control the level of water or not the weeding systems for these fields are explained in the Figure No. 33.

The labours required for weeding 10 ares are listed in the Table No. 5.

Figure No. 33 Weeding System for Direct Sowing on Submerged Fields.

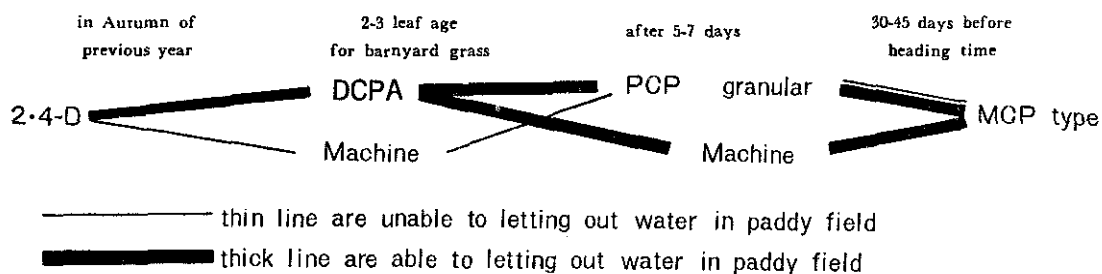

Table No. 5 The Fundamental Weeding System according to kinds and quantities of annual weeds.

#### 1) Transplanting Cultivation

Kind and Quantity of Weeds		Weeding System	Labour input per 0.1 hectare	
barnyard grass	other weeds		Hand Weeder	Power Weeder
a few	a few	PCP granular	0.5 hr.	0.2 hr.
a few	much	PCP granular+Weeder (machine)	3-5 hr.	1.2 hr.
much	a few	PCP granular+MCP and its analogues (2.4-D)	1.5 hr.	0.5 hr.
much	much	PCP granular+Weeding machine+MCP and its analogues (2.4-D)	4-6 hr.	1.5 hr.
very much	much	PCP granular+Weeder+MCP and its analogues (2.4-D)	6.5-8	2.5 hr.

#### 2) Direct Sowing on Dry Paddy Fields

Quantity of weeds (annual-life weed)		Weeding System			Labour input per 0.1 hectare		
drying period	after fill the water	drying period	immediately after submergence	20-25 days after submergence	30-45 days before heading time	Hand Weeder	Power Weeder
a few	a few		PCP liquid+DCPA+PCP granular			2.5 hr.	0.8 hr.
a few	much		PCP liquid+DCPA+PCP granular	+MCP		3.5 hr.	1.0 hr.
much	a few		PCP liquid+DCPA+PCP granular	+Weeder		6-8 hr.	2.0 hr.
	much		PCP liquid+DCPA+Weeder+PCP granular	+MCP and its		6-8 hr.	2.0 hr.
	much		PCP liquid+DCPA+Weeder+PCP granular	+MCP		8.5-12	3.0 hr.
	much		PCP liquid+DCPA+Weeder+PCP granular	+Weeder	+MCP analogues		

**OFFERING SERVICE OF TECHNICAL-TIE-UP:  
MANUFACTURING AUTHODOX PLOWS THAT YOUR MARKET DEMANDS  
HUNDREDS OF THOUSANDS UNITS**

A sharp sword and a dull sword looks alike outside but fundamentally different in technics: Your tie-up with the sharp-sword-side will realize you monopoly of this technics and eventual big sales & profits in your region!

A plow is a simple innocent looking tool, but once you come to know it is really inviting, you will find out delicate elements that comprise a plow, such as specific angle of each parts and curvings, material and balancing, because a plow unlike other general commodity, has unlimitedly varied conditions to work on: hard clay soil, sticky soil, soil with subtle shifting water percentage, hard-dried soil, stony soil, sandy soil, etc. etc.

In present stage, most countries use 2 animals to pull a plow, this is extra expenses to raise more cattles, and still cannot realize right harvest due to poor efficiency of plowing capacity. Some nations have single-animal-drawn plows but still people do not recognize difference between a sharp efficient plow and a dull slow working plow.

Imagine, you offer to your market a plow that can be drawn by a single animal, (this means saving in extra cost of raising two cattle instead of only one) and yet farmers can increase their profits by 30-50%, because the efficiency of plow is so superb, farmers in your market will be very happy; it will mean not only increased sales and consequently increased profits to you, but it is an act of nationalistic combined efforts. No doubt, you will achieve a success, not competed by any other party.

"CeCoCo"s Co-ordinator has started it's business in 1863 as a manufacturer of animal-drawn farming implements. During these 100 years of progress, tireless study gained thousands of patents from plow to radio-controlled tractor, our markets cover over the globe, handling factors and tillers. We are the only one complete-line manufacturer in Japan of plow, soil-crushers, riggers, seeders, potato diggers, fertilizer distributors, tobacco rooters, mowers. Our machines suit any difficult soil conditions or any different working methods applied in overseas countries.

Eventually, your market will also shift into using of tractors but for the transient period plows still enjoy a good market in your farmingv illages. Your technical tie-up with us will never fail you to bring in more profits.

We firmly believe that no other technical tie-up for plows can complete with that of with us, and your plow-technical-tie-up with us will eventually lead to a tie up for tractor business as well. Please submits us your plan with detailed specification for your requirements with the sketches and drawings showing the shape, size and weight to suit your market stating the kind of soil and condition of soil, soft, hard, sandy, steeky, wet or dry. "CECOCO" P.O. Box 8, Ibaraki City, Osaka Pref., JAPAN.

**NEWLY INVENTED "CECOCO" "SUZUE" POWER AUGER, One Operator Enough**

Usually motivated Auger requires 2 men in handling and operation, but this special and unique type power auger can easily be operated by one man only which is the specialy of this particular auger with many patents applied for.

Because due to a newly invention in the entirely different construction of the most important part of screw from other conventional auger, that is the screw is composed of two parts instead one body, namely the upper and lower parts of screws, which work in the opposit direction each other giving a counter-action, thereby entirely absorbe the shocks of vibration movement during operation, that is why only one operator can dig any required sizes of holes into the earth freely, speedily and easily as well as uniformly.

There are many usages, especially digging holes in setting posts for telegraph, telephone, fening especially when constructing simple house and shack, fertilizing and loosing the soils around the roots of fruits and trees etc. "CeCoCo" strongly recommend you to adapt to save time and labor as you will be surprised to lear it's wonderful efficiency.

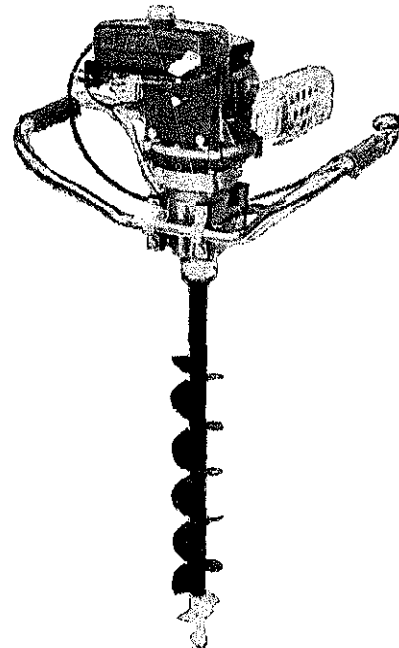

Specification of "CeCoCo" "Suzue" Power Auger

Type	Mounted Engine		R.P.M. of Drill	Dia. of Drill	Dimension			Net Weight	
	Model	H.P.			R.P.M.	Height	Width		Length
D-50	KF 20AR	1.5-2.2	1500-6000	336 & 126	90, 60 & 150mm	1110mm	350mm	550mm	19 kg

## "CECOCO" TRACTOR IMPLEMENTS

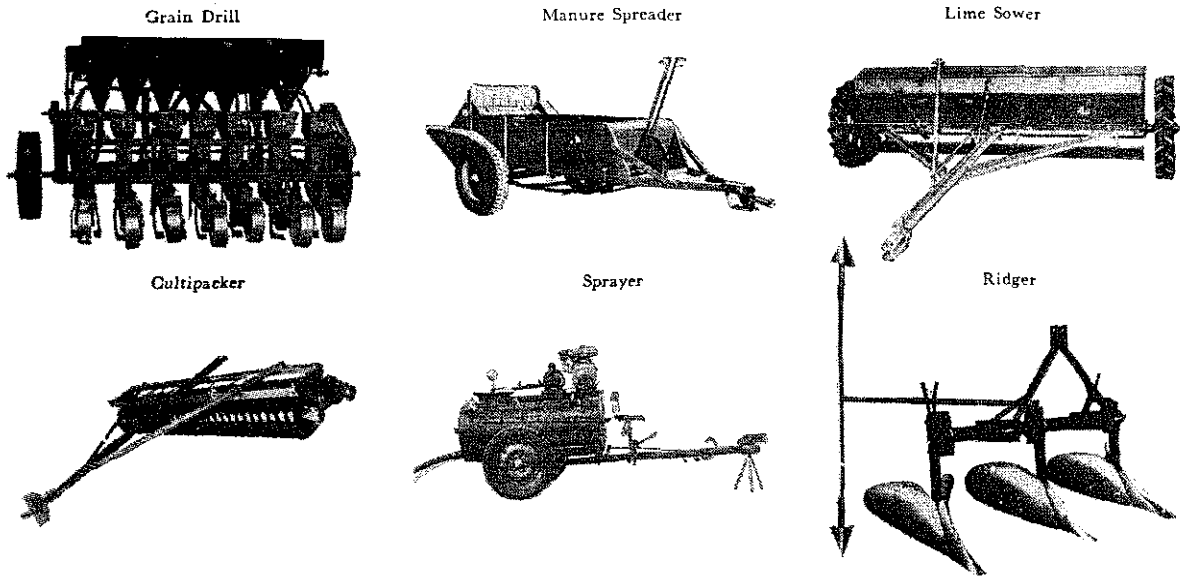

Specification of "CeGoCo" Tractor Implements (Subject to change without notice)

Name of Implement	Linkage	Model	Size	Working Width	H. P. of Tractor	Capacity per hour	Net Weight
Bottom Plough	Trailed	TPA 122	12 × 2	610mm	30—	25-30 ares	680kg
	—do—	TPA 142	14 × 2	720mm	40-50	30-35 ares	730kg
	Mounted	MPA 121	12 × 1	305mm	15-20	14 ares	113kg
	—do—	MPA 141	14 × 1	360mm	15-20	16 ares	117kg
	—do—	MFA 122	12 × 2	640mm	21—	30 ares	170kg
Brush Breaker	—do—	MPA 142	14 × 2	740mm	21—	35 ares	180kg
	Trailed	TPE 181	18 × 1	460mm	30—	20-23 ares	730kg
	—do—	TPE 201	20 × 1	510mm	40-50	22-25 ares	750kg
Disk Plough	—do—	TPE 221	22 × 1	670mm	50—	25-27 ares	800kg
	Mounted	MPG 241	24 × 1	240mm	15-20	12 ares	153kg
	—do—	MPG 267	26 × 2	540mm	21—	25 ares	240kg
Disk Harrow	—do—	MPG 263	26 × 3	750-810	21—	40 ares	380kg
	Trailed	TD 1824	18 × 24	2140mm	30—	70-80 ares	730kg
	—do—	TD 2024	20 × 24	2670mm	40-50	70-80 ares	750kg
Cultipacker	—do—	TD 2224	22 × 24	2670mm	50—	70-80 ares	750kg
	—do—	TD 2424	24 × 24	2670mm	50—	70-80 ares	950kg
	Mounted	MD 1824 A	18 × 24	2260mm	21—	65-75 ares	420kg
	—do—	MD 1828 P	18 × 28	2580mm	21—	75-80 ares	450kg
	—do—	MDO 1612	16 × 12	1150mm	15-20	40-50 ares	240kg
Manure Spreader	—do—	MDO 1814	18 × 14	2260mm	21—	60-70 ares	300kg
	Trailed	TCP 6	6 feet	1805mm	15—	65 ares	450kg
Lime Sower	—do—	TCP 8	8 feet	2375mm	30—	77 ares	555kg
	Trailed	TMS 100	1.4 m <sup>3</sup>	920mm	15—	100 ares	490kg
Grain Drill	—do—	TMS 200	2.2 m <sup>3</sup>	1060mm	25—	150 ares	620kg
	Trailed	TLS 6	6 feet	1830mm	15—	75 ares	200kg
Potato Digger	—do—	TLS 8	8 feet	2400mm	25—	100 ares	260kg
	Mounted	MGD 7	7 rows		17—	20-30 ares	230kg
Hay Mower	—do—	MGD 13	13 rows		30—	30-50 ares	430kg
	Mounted	MPD 1	1 row	666-727	30—	30 ares	460kg
Ridger	Trailed	TPD 1	1 row	750-810	25—	25 ares	470kg
	Trailed	TFH 120	120	1200mm	20—	15 tons	950kg
Sprayer	Mounted	MR 20B	R5	1525mm	15—	60 ares	195kg
	—do—	MR 24B	R6	1820mm	25—	70 ares	200kg
Bottom Plough	Mounted	MR 12-L	2 rows		10-14	20 ares	90kg
	—do—	MR 13-D	3 rows		25—	35-40 ares	185kg

Besides shown in the above pictures and specification, we can supply other kinds of tractor's implements and when enquiry, please inform us of brand of your tractor, required horse power, linkage and also details of implements required.

## JAPANESE FARMING STUDENTS ARE VERY ACTIVE

Prospects of agriculture in Japan do not look gloomy here in agricultural high school where hundreds of farmers-to-be are eying their bright future as agrarian leaders.

The school is Tawaramoto Agricultural High School, at Tawaramoto Town, Shiki-gun, Nara Prefecture, some 20 kilo-meters southwest of the ancient capital of Nara.

When this reporter visited the school, a group of third-year students were operating a power-cultivator in cold rain, their eyes sparkling with hopes.

One of them said, however, "We are not so interested in farming itself as we are in its modernization and improvement of farm products through our own efforts."

They said they plan to spend a few years as salaried men before becoming full-fledged farmers. Principal Kakichi Hinatsu of the school explained, as a reason, the inveterate concept among aged farmers in this area to regard a bride as a source of man-power in the family.

"Graduates of this school, except a few entering universities, usually work outside the home until they get married, because, otherwise, they can hardly find their brides. Girls know well how they will be treated when they marry farmers." He also added, "It is important to build up their character through general education. I am putting more stress on this point rather than technical education alone, so that they may bring about a change in the way of thinking of the older generation."

The geographical position of Nara Prefecture bordering on the mammoth consuming area of Osaka makes agriculture a profitable enterprise with an average yearly income of ¥ 1 million for a two-acre land owner. The fact is a good incentive for students here, the principal added. Among the school's graduates, Tahei Fujimoto at Miyake-mura, Shiki-gun grows mushrooms; Zentaro Hagihara, Tawaramoto-cho has succeeded in improving water-melon; and Jinmatsu Tsujimura at Gose City has increased milk production threefold. They are said earning up to ¥ 10 million a year.

There are about 550 students including 20 coeds in the school. They are in three major fields of study—agriculture with 221, horticulture with 134 and agricultural chemistry with 198 students. Sixty-six students of agriculture and 29 students of horticulture are graduating this spring. Besides basic curricula common to ordinary high schools, all the three divisions give cultivation of grains, vegetables, flowers and fruits and animal husbandry. Mechanized farming is taught the agriculture majors and enterprising technique besides cultivation and industrial processing of agricultural products the horticulture majors.

All students are engaged in extra curricula activities through home projects and clubs to put to practice what they have subjects of interests dealt with by such clubs include fruits, vegetables, flowers, animal husbandry, food-processing, machinery, auto, meteorology, and applied microbiology. Home projects are carried out according to circumstances of their farming homes. For instance, a third-year students belonging to the animal husbandry club work is trying to find out which is better for dairy, hillside or flat ground. He also studied how to check cow's disease in the early stages and mate milk cows.

Their home projects also cover raising of tangerines, strawberries, onions, carnations, and mushrooms, all enjoying increasing demand from both domestic and foreign markets. While others are studying the improvement of straw-berry-seeds and how to increase per-acre yields of potatoes and pears.

## FIELD CULTIVATION AND SOIL CONTROL

### "CECOCO" JAPANESE PLOUGH

The plowing should first be done in the preparation of the field. Time and method of plowing vary with the single or double cropped fields. In most of the single cropped fields the first plowing is done in early spring to stimulate the drying of earth which is quickened and the second plowing will be done just before harrowing in order to break the clods. In some districts the first plowing is usually done in late in fall in order to speed up the decomposition of organic matter. In most of the two cropped fields, a simple plowing is done for the additional purpose of breaking down the ridges of previous crops, because plowing has already been done after harvesting of rice plants in autumn to prepare the soil for winter crops. Before plowing the manures such as compost, green manure, lime and part of the chemical fertilizers are generally distributed and plowed them under the whole fields. Depth of plowing varies according to the soil conditions from about 10 to 20 centimeters the average.

The Japanese plow is pulled by a draft animal and is used for building up ridges as well as inverting the soil, because second crops are grown on the ridges of fields. It is small and light, and can plow deeply, so it can be used on a small farm. Types are as follows:

- a. Fixed type — The Japanese plow, same as the foreign plow, throws the plowed earth on one side only. In Japan, the earth is thrown on the left side. Another type, throwing the earth on the right side can be made.
- b. Reversible type — With the use of the handle, the plow-share and the moldboard can be turned either to the right or to the left. So that the land can be plowed both ways, i.e. to and from a given point, and gradually plow the soil successively. The working of the mechanism is similar to the hill-side plow but the construction is different.

c. Double type — This is recently designed to plow deeply. The big and small shares are fixed in front and behind, so that with one stroke, the soil can be plowed deeply and shallowly. Its capacity depends on the nature of the soil, the depth to be plowed, and the speed of the pulling power.

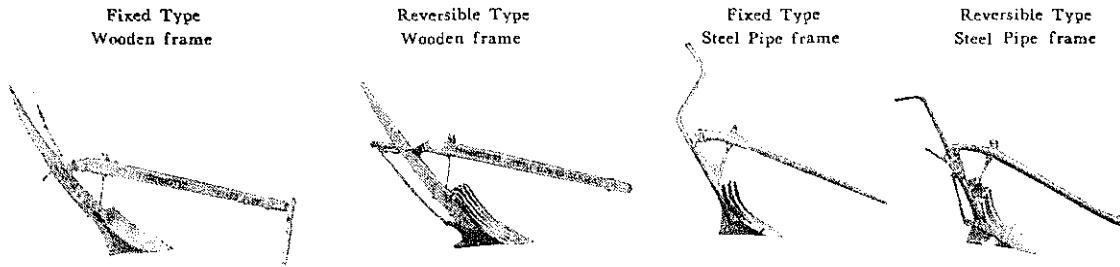

Specification of "CeCoCo" 'Japanese' Plow

Type	Construction	Furrow Width	Capacity per 8 hours	Dimension in mm			Net Weight	Gross Weight	Ship'g Meas't
				Height	Width	Length			
Fixed	Wood frame	20 cm	1.2 acre	1067	508	1625	@ 18.5 kg	130 kg	15 cft
Revers.	Wood frame	21 cm	1.4 acre	1092	787	1470	@ 19 <sup>1</sup> / <sub>2</sub> kg	136 kg	15 cft
Fixed	Steel pipe	20 cm	1.4 acre	1030	510	1800	@ 17 <sup>1</sup> / <sub>2</sub> kg	110 kg	14 cft
Fixed	Steel pipe	15 cm	1.0 acre	1030	300	1800	@ 17 <sup>1</sup> / <sub>2</sub> kg	110 kg	14 cft
Revers.	Steel pipe	21 cm	1.4 acre	1040	310	1700	@ 18 <sup>1</sup> / <sub>2</sub> kg	120 kg	14 cft

Note: packed 4 sets in a strong seaworthy wooden case.

### "CECOCO" ANIMAL DRAWN BREAK HARROW

This implement is drawn by a draft animal equipped with the rotating teathed blade attached in front and slices up, invert and pulverize the soil and no pressure is needed to be exerted from the handle.

Leveling plate is attached in the rear, and the lifting of the adjusting lever attached to the handle opens the plate to act and does the smooth leveling action even on the cloddiest ground.

This adjusting mechanism gives you a comfortable operation in isolating the pitching caused by operations on cloddy and rough soil by handle.

This model is the most suitable one for the job in paddy field and shows an amazing efficiency and incurs no trouble caused by weed, straw, etc. tangled with the framework.

Specification of "CeCoCo" Break Harrow

Type		6-teeth	8-teeth
Capacity per 8 hours		2.5 acres	3.0 acres
Dimension	Height	710 m/m	710 m/m
	Width	1040 m/m	1270 m/m
	Length	1230 m/m	1230 m/m
Net Weight		@22 kg.	@26.5 kg
Gross Weight	2 sets in a case	80 kg.	84 kg.
Ship'g Meas't		30 cft	36 cft

"CeCoCo" Break Harrow  
8-teeth type

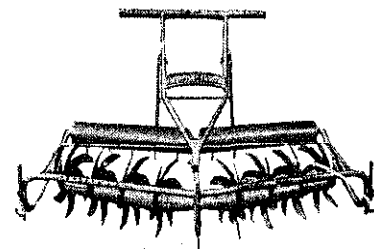

### "CECOCO" ANIMAL DRAWN CULTIVATOR

Smallness in size and made adjustable to cultivate soil either deep or shallow, it cuts the roots of grass and weed thoroughly, and such roots and stubbles are buried into soil by inversion.

Height of wheel and width of plowing space by means of small plow and depth of plowing can easily be adjusted by "Round Handle" Adjuster.

By exchanging the attachments, almost of all kinds of plowing and cultivation can easily be done.

Does not require much power, and only one animal can draw it, if it is well adjusted for your requirement.

"CeCoCo" Cattle Drawn Cultivator

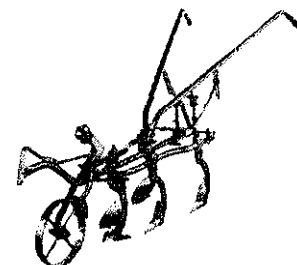

Specification of "CeCoCo" Animal Drawn Cultivator

Type	Capacity per 8 hour	Working Width	Furrow Depth	Dimension in mm			Net Weight	Gross Weight	Ship'g Meas't
				Height	Width	Length			
Animal drawn	3 acres	450 mm	120 mm	750	450	1650	23 kg	50 kg	11 cft

**"CECOCO" POWERED WALKING TILLER AND TRACTOR**

A small-size tractor in Japan is equivalent to garden tractor in the U.S.A., with an combustion engine of less than 15 H.P. There are many types of tractors and are divided into various categories depending on size, construction, design and use. The ones in most common use in Japan are the 3 to 5 H.P. tiller tractors and the 5 to 6 HP double-duty tiller-cultivator tractors. Tiller Tractor—This type of tractor is equipped with rotary, which serves as the cultivating device as well as the wheel to facilitate both purposes of cultivation and advancement. The rotary is also exchangeable to wheels to serve the purpose of a tractor drawing plows, harrows, cultivators, trailers and other farming machinery. Its construction and use are almost similar to that of a garden tractor. It is small in size, light in weight, easy to handle and also inexpensive and therefore most suitable for small-scale individual farming use. It has rapidly become popular in Japan. The tiller tractor is mainly used for cultivation and harrowing of dry rice and vegetable fields, harrowing of rice paddies and transport of crops and equipment, but its use has gradually extended also to other farming routine works.

Double-duty Tractor—The garden tractor was originally designed to be used for drawing duties, but in Japan this tractor is also equipped with a rotary cultivation device to serve as a power tiller. Due to this factor the tractors and the power tillers are difficult to differentiate.

It is a conventional type tractor, and its efficiency should be judged by the different uses but the main and most important point is its tractive force. It normally has a pulling capacity of 40-60 per cent of its dead weight. Its working capacity differs by the type of work, size of the tractor, condition of the land or field and skill of the operator. Speciality: Due to lightness of weight exhibits more drawing power than a larger powered tractor.

Tilling Dry Field with Rotary set

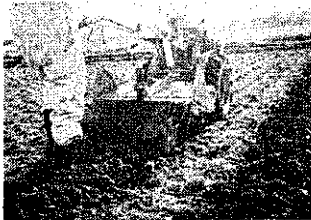

Plowing hard soil with Plough and Harrowing Knife



Ridging Dry Land with Ridger

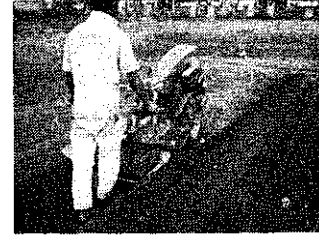

Seeding and Fertilizing with Seeder & Fertilizer Applier



Transportation with Trailer

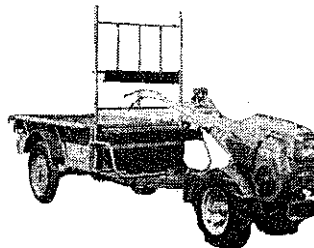

Harvesting with Potato Digger

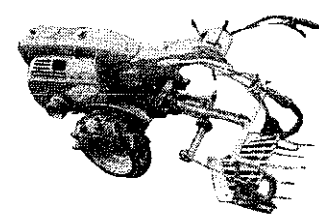

"CeCoCo" Power Cultivator Type H-25 with Weeding-rotor

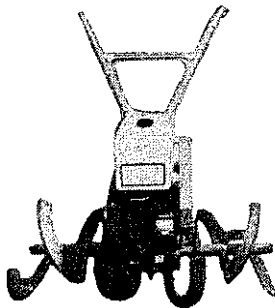

**A) "CECOCO" POWER CULTIVATOR**

This small-sized Power Cultivator Model 'H' series is an all-season, all-purpose tool which can be used for preparing the soil prior to planting and for cultivating or used control work throughout the season.

The Power Cultivator meets almost every rotary tillage need: home gardening, crop cultivating, vegetable growing, lawn and landscape work, nursery use.

"CeCoCo" Power Cultivator Type H-25W with Rotor-blade

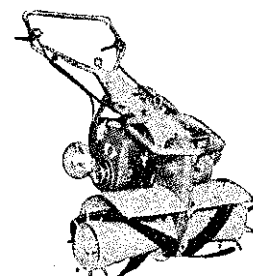

Specification of "CeCoCo" Power Cultivator Model 'H' series

Type	H-25	H-25W
Engine	Type R-II, Vertical Single Cylinder, 2-cycle, Air-cooling Gasoline Engine, 1.8-2.5 HP/2000-2400 RPM, 60 cc.	
Tyre	Pneumatic Rubber Tyre Wheel 3.50-5 size, 2 P	
Dimension	125 cm L × 40 cm W × 75 cm H	110 cm L × 33 cm W × 55 cm H
Transmission	A-type V-belt from engine to main shaft and 1/2" Chain and Sprocket from main shaft to axle.	
Speed	2-forwards only, 1st - 4.2 km/h; 2nd - 10 km/h	1 forward and 1 reverse, 9.6 km/h and 5.7 km/h
Net Weight	32 kg. with engine only	39 kg. with engine only
Export Packing	60 kg. and 13 cft.	70 kg. and 15 cft.

B) "CECOCO" MULTI-PURPOSE HAND TILLER :

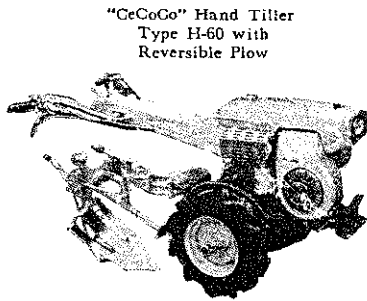

"CeCoCo" Hand Tiller  
Type H-60 with  
Reversible Plow

Thorough rotary-tillages surely satisfy you with the wider tilled-width 40 to 60 cm. On the other hand, in your plowing, perfectly soil up-setting with unique soil pulverizing mechanism speeds up your farming. The above facts helps you understand the strongest power and multi-purpose of this tiller.

In the past, the equipping with new implements to tiller was used to trouble with chain mechanism. But now, in a moment, interchange of implement for next operations can be made only with a pin, instead of troublesome chain removing.

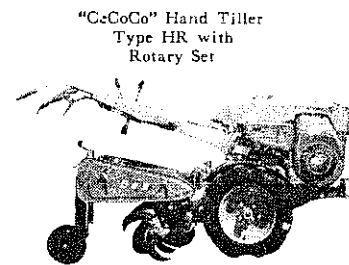

"CeCoCo" Hand Tiller  
Type HR with  
Rotary Set

Specification of "CeCoCo" Hand Tiller

Type	H-60	HR
Engine	Type TE-40, Vertical Single-Cylinder, 4-cycle, Air-cooling Gasoline Engine, 5-6.3 HP/3600-3800 RPM, 1/2 reduction,	Type TE-80, Vertical Single-Cylinder, 4-cycle, Air-cooling Kerosene Engine, 6-8 HP/1600-1700 RPM,
Tyre	Pneumatic Rubber Wheel 4.00-10, 2 ply	Pneumatic Rubber Wheel 5.00-12, 2 ply
Dimension	174 cm L × 67 cm W × 95 cm H	200 cm L × 91 cm W × 111 cm H
Tread	47 cm-62 cm	45 cm-77 cm
Transmission	V-belt from engine to main pulley and Sliding Spur Gears from main pulley to axle, and/or Chain for rotary work	
Speeds	6-forwards and 2-reverses	6-forwards and 2-reverses
Main Clutch	Dry, Single Disc, Friction Type by Belt Tension Pulley	
Side Clutch	Sliding dog-clutch by gear driven in constant mesh.	
Working Capacity	Plowing - about 6-10 ares/hour	Plowing - about 10-14 ares/hour
	Tilling - about 10-13 ares/hour	Tilling - about 12-20 ares/hour
	depending upon soil condition and working purpose	
Net Weight	250 kg. with engine & rotary set	280 kg with engine & rotary set
Export Packing	250 kg. and 40 cft.	400 kg. and 65 cft.
Specialized working implement at extra cost	Plow, Harrow, Ridger, Mower, Potato and Peanut Digger, Seeder & Manurer, Trailer, etc. Pictures on page 21 show the working views of Hand Tiller Type HR-80 attached with various implements.	

C) "CECOCO" DIESEL ENGINE DRIVE HAND TILLER :

This Hand Tiller represents the medium class of the two-wheeled agricultural tractor powered by 4 to 8 H.P. diesel engine and is the most ideal general-purpose tiller of the better capacity in maneuverability, economy, versatility, durability and stability.

The tiller is equally available both for rotary work and trailing work in combination with a wide range of its working implements.

The attaching and detaching of working implements can be done very easily and swiftly; no more than a single pin on the universal boxed hitch is required to attach any trailing attachments and neither is required more than a pair of nuts on the splined rotary shaft for any rotary implements.

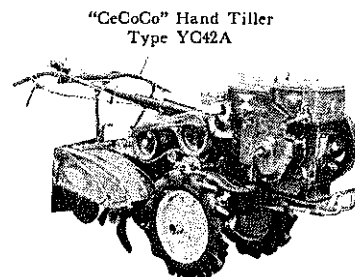

"CeCoCo" Hand Tiller  
Type YC42A



"CeCoCo" Hand Tiller  
Type KL-600B

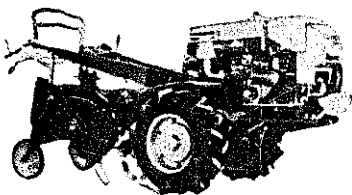

The roto-tiller stops rotating automatically when the gears are put in the reverse for the prevention of danger as in the case of operating in sticky fields.

For the employment of engine power for another jobs, such as threshing, pumping, grinding, spraying, hulling, etc., the power-take-off (P.T.O.) shaft is readily available together with a special flat pulley.

Specification of "CeCoCo" Diesel Engine Hand Tiller

Type	YC42A	KL-600B
Engine	Model NT75K, Single Cylinder, Water-cooled Diesel Engine, 4-6 HP/1,400-2,000 RPM, "YANMAR" Brand	Model NT95K, Single Cylinder, Water-cooled Diesel Engine, 7-8HP/1,400-1,800 RPM, "YANMAR" Brand
Tyre	Pneumatic Rubber Tyre Wheel 5.00-12 size (550 mmφ), 2 P	Pneumatic Rubber Tyre Wheel 6.00-12 size (620 mmφ), 2 P
Dimension	2,100 mm L × 680 mm W × 1,000 mm H	2,320 mm L × 805 mm W × 1,100 mm H
Transmission	V-belts from engine to main-pulley, All sliding spur-gears in internal transmission and Chain & Sprocket for rotary work	sliding spur-gears in internal transmission
Speeds	4-forwards and 2-reverses	8-forwards and 4-reverses
Main Clutch	Dry Friction Type by Belt tension pulley	
Rotary Set, standard implement	Tilth ..... 150-200 mm	Tilth ..... 130-210 mm
	Tilling width ..... 420-600 mm	Tilling width ..... 600 mm
	Circle Dia. .... 410mm	Circle Dia. .... 500 mm
	Nos. of tine ..... 14-18 Pcs.	Nos. of tine ..... 18-20 Pcs.
	Capacity ..... 5-7 ares/hour	Capacity ..... 8-12 ares/hour
Net Weight	287 kg. with engine & rotary	415 kg. with engine & rotary
Export Packing	400 kg. and 80 cft.	550 kg. and 115 cft.
Specialized implements	Plow, Ridger, Mower, Roto-puddler, Harrowing Rotor, Cultivator, Trailer, Drum Roto-tiller, etc.	

D) "CECOCO" 4-WHEEL RIDING MINIATURE TRACTOR :

This 4-Wheel Tractor is equipped with Engine, Pneumatic Rubber Tyre Wheels and Two-Furrow Plow with Harrowing Knife as shown in pictures. When turning or steering to the right or left, the mechanism of Automatic Slide Clutch interlocks with steering-wheel, and stops the wheels on one side of the tractor automatically.

For transmission, all enclosed gear drive constant-mesh system is adopted; and for side clutch, an original device of Automatic Clutch is provided.

"CeCoCo" 4-Wheel Tractor  
Type MB-D with Diesel Engine

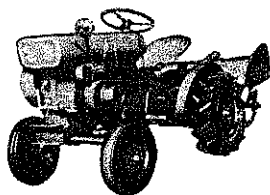

Unique and excellent design of all the implements are the essential factor of the strong trailing power of "CeCoCo" Miniature 4-Wheel tractor.

This 4-wheel tractor is not hydraulic system 3-point linkage type as a large tractor but hand lever system box type hitch and therefore, various implements can be easily attached with a single pin.

The tractor is equipped with universal hitch to attach and detach any trailing implements, such as Rotary Blade, Cultivator, Potato & Peanut Digger, Ridger, Rake, Trailer, Seeder & Fertilizer Applier etc. and P.T.O. pulley for belt work on Sprayer, Pump, Thresher, Feed Grinder, Rice Huller, Cutter, etc.

"CeCoCo" 4-Wheel Tractor  
Type MB with Kerosene Engine

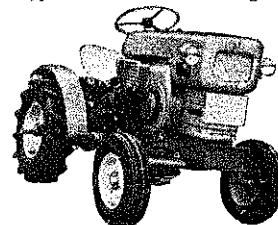

Specification of "CeCoCo" 4-Miniature Tractor

Type	MB	MB-D
Engine	Type TE-80, Single Cylinder, 4-cycle, Air-cooled Kerosene Engine, 6-8 HP/1,600-1,700 RPM, 377 cc.	Type KD-101, Single Cylinder, 4-cycle, Air-cooled Diesel Engine, 9-11 HP/1400-1500 RPM
Tyre	Front ..... Pneumatic Rubber Tyre Wheel 4.00- 9 size 2 ply Rear ..... Pneumatic Rubber Tyre Wheel 6.00-12 size 2 ply	
Dimension	2,400 mm L × 1,070 mm W × 1,100 mm H	2,400 mm L × 1,070 mm W × 1,100 mm H
Transmission	V-belt from engine to main pulley and enclosed all gear in internal transmission, Fully geared speed shifter, Reduction Constant Mesh,	

Steering	Steering-wheel interlocked with side clutch, constant mesh system	
Speeds	6-forwards and 2-reverses for tractor, and 5-steps for rotary drive	
Linkage	Box type hitch connected with pin on rear or front	
Brake	Foot pedal operate	Foot pedal operate
Turn Radius	min. 1.6 meter	min. 1.6 meter
Working	Rotary tilling, in standard, also specialized working available to plowing cultivating, levelling, ridging and transporting at any farming conditions.	
Working Capacity	Plowing ..... about 10-15 ares/hour	Plowing ..... about 10-15 ares/hour
	Tilling ..... about 12-20 ares/hour	Tilling ..... about 12-20 ares/hour
	depending upon soil condition and working purpose	
Net Weight	410 kg. with engine & rotary set	500 kg. with engine & rotary set
Export Packing	650 kg. and 110 cft.	750 kg. and 110 cft.

The working views of "CeCoCo" 4-Wheel Riding Tractor Type MB attached with various implements

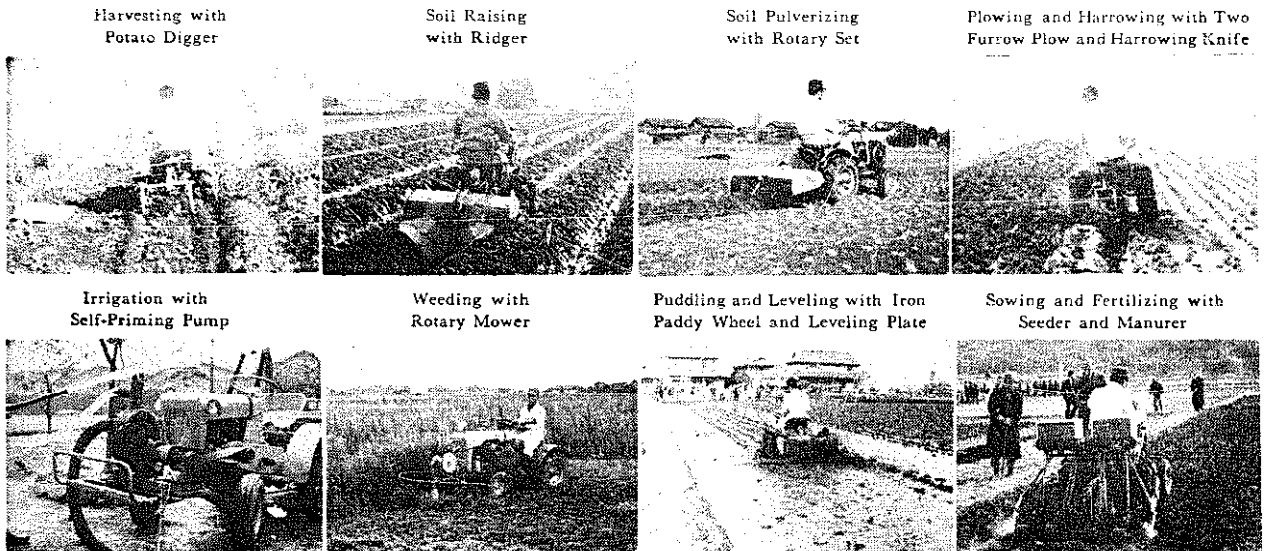

NEW "CECOCO" 4-WHEEL RIDING TRACTOR MEDIUM TYPE

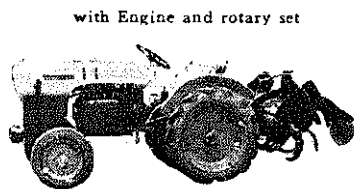

with Engine and rotary set

- Engine :- Air-cooled Kerosene Engine Type TE-82, Horizontal Opposed Piston, 4-cycle, Twin Cylinder, 12-15 H.P., 754 cc.
- Tyre :- Pneumatic Rubber Tyre Wheel,  
Front ..... 4.00-12 size  
Rear ..... 7-20 size
- Dimension :- 1,200 mm H × 1,450 mm W × 2,020 mm L
- Weight :- approx. 460 kgs. (Without Implement)
- Speeds :- 8-forwards and 2-reverses, and 4 steps for implement
- Working Width (Tilth) :- 1,000-1,200 m/m
- Clutch :- Dry, Single Disc, Friction Type.
- Transmission System :-  
Engine is combined with transmission as a united structure.

"CECOCO" ROTARY-PLOW: Three in function Simultaneous Operation

Inverts (1), Breaks Up (2), and Levels Soil (3) Ready for Sowing

Advantage: Reason why Japanese tiller and tractor are becoming very popular for rice cultivation is because that they are efficiently equipped with the Japanese characteristic plow which saves weeding a great deal, as it buries noxious grasses by inverting and turning them into the soil as a natural fertilizer.

It can be attached to any models of the walking tiller and riding tractors at once and 2, 3 and 4 bottoms can also be adapted in a row or parallel, which saves a considerable labour and time.

Japanes Rotary Plow Become Very Popular Throughout the World: Since Japan is noted as the best rice yielding country for the ever increasing productivity, due to the Japanese characteristic peculiarity of its cultivating efficiency, because almost of all tillers and tractors made in Japan are equipped with the same, many of the Japanese Rotary Plow are now being exported not only into the South and Middle Fast Asia and

Africa but also to England, France, Germany, Netherland, Sweden and South America where the various kinds of tillers and tractors are manufactured to equip it with their own makes.

"CeCoCo" is always ready to supply Japanese Rotary Plow together with various types of the tines. For further particulars, write to "CeCoCo" P. O. Box 8, Ibaraki City, Osaka, Japan with the detailed specifications and quantity required for the price and delivery.

Specification of "CeCoCo" Rotary-Plow

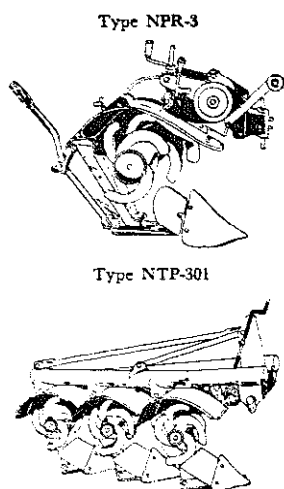

Type		NPR-3	NTP-201	NTP 301	NTP-401
Overall Dimension	Height	670mm	1,150mm	1,150mm	1,150mm
	Width	550mm	1,050mm	1,290mm	1,590mm
	Length	740mm	1,520mm	1,930mm	2,450mm
Nos. of Plow		one	twin	triple	four
Plowing Width		180-210mm	600mm	900mm	1,200mm
Plowing Depth		150-180mm	150-200mm	150-200mm	150-200mm
Breaking Depth		80-100mm	60-100mm	60-100mm	60-100mm
Adaptable Power		4-6HP	25-30HP	30-45HP	more 40HP
Capacity per hour		5-6 ares	13-20 ares	20-24 ares	30-40 ares
Adaptable Speed		0.8-1.1m/s	1-1.5m/s	1-1.5m/s	1-1.5m/s
Net Weight		43kg.	240kg.	300kg.	380kg.
Gross Weight		80kg.	350kg.	450kg.	610kg.
Ship'g Measurement		12cft	60cft	85cft	105cft

Remarks: -- Type NPR-3 can easily be attached to 4-6HP small power tiller of any brand or mark by connecting pin. Plow is reversible type and capable of doing the jobs of hilling, interculturing, weeding, furrowing, ridge breaking etc. by replacing various attachment at extra cost.

## TINES OF ROTARY TILLER AND TRACTORS

Various kinds of tines will be supplied to be attached to any brand and type of tillers and tractors of different makers and prices will be quoted if type of tiller or tractors, type and number of tine, and quantity are intimated to "CeCoCo" P.O.Box 8, Ibaraki, Osaka-fu Japan.

A) Ordinary Tines

A) Ordinary Tines  
left--No. PF for 'FUJI' Tractor,  
right--No. 91 for 'KUBOTA' Tractor

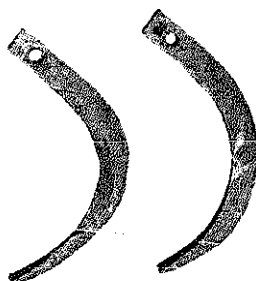

B) Hatchet Tines

B) Hatchet Tines  
left--No. K7 for 'ISEKI' Tractor  
right--No. 17 for 'KUBOTA' Tractor

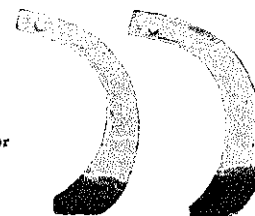

"CECOCO" can supply any kind of Tines: Upon the receipt of the specification stating the kind of your tiller and tractor and quantity required, will quote competitive price.

## E) "CECOO" SCREW TILLER:

The "CeCoCo" Screw Tiller has a pair of screw blades placed by side and rotating about vertical axes like drills, so that this system is most suitable for hard soil, deep-tilling and power economy, and display a peculiar efficiency not comparable with any system or type available.

There are various kinds of screw blades according to the soil condition, soil quality, cultivation crops and operations. It goes without saying that the capacity will considerably vary depending upon the proper selection of the screw blades, however, it is an advantage that the rough or minute crushing of the soil can be adjusted by even only standard 3-blades by the change of revolution and it can also be extensively applied to many other particular operations as desired.

Screw Tilling System

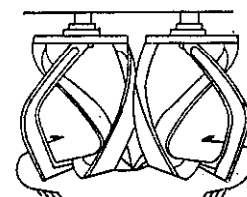

Model L-D14



Model V-D16

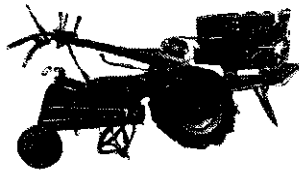

Model S-D25



2-blades for soft-soil

Various Screw Blades  
3-blades, standard      open 2-blades for plough minute

4-blades for hard-soil



Specification of "CeCoCo" Screw Tiller

Model		L-D14	V-D16	S-DK	S-D25
Dimension	Length	1,865 mm	2,140 mm	2,340 mm	2,350 mm
	Width	700 mm	680 mm	746 mm	800 mm
	Height	1,155 mm	1,160 mm	1,180 mm	1,180 mm
H.P. and Weight of Engine to be mounted		3.5-5.5 H.P. max. 70 kg.	4.0-6.0 H.P. max. 100 kg.	5.0-7.0 H.P. max. 120 kg.	7.0-10.0 H.P. max. 150 kg.
Size of Tyre		Pneumatic Rubber Tyre 5-12		Pneumatic Rubber Tyre 600-12	
Transmission		V-belts from engine to main pulley and enclosed all gear			
Main Clutch		Dry, Friction Type by Belt Tension Pulley			
Speeds		4-forwards & 1-reverse	6-forwards & 2-reverses	4-forwards & 1-reverse and with Sub-change of 2-steps	
Efficiency with a pair Standard 3-blades Screw	Tilth	max. 160 mm	max. 210 mm	max. 210 mm	max. 210 mm
	Width	485 mm standard	480 mm standard	540 mm standard	600 mm standard
	Angle	50°, 5-steps	55°, multiple	60°, multiple	60°, multiple
	High/Low	320/255 rpm	275/215 rpm	249/188 rpm	228/171 rpm
	Output	4-6 ares/hour	5-7 ares/hour	6-10 ares/hour	8-12 ares/hour
Road Clearance		min. 180 mm	min. 295 mm	min. 320 mm	min. 353 mm
Rev. of Main Pulley		960 rpm	800 rpm	850 rpm	950 rpm
Weight without Engine		160 kg.	175 kg.	190 kg.	320 kg.
Export Packing		220 kg. 45 cft	250 kg. 50 cft	300 kg. 60 cft	450 kg. 75 cft

#### F) "CECOCO" AUGER FOR IMPLEMENT OF SCREW TILLER :

The "CeCoCo" Auger can be attached as special implement of "CeCoCo" Screw Tillers above mentioned.

"CeCoCo" Auger will display an admirable efficiency in making the hole for fertilization in orchards, holes for pile or post, digging hole for tree-planting, and will dig at any direction of holes.

The Auger can be adjusted up and down by lever and the operation is so simple and wonderful in its performance. Various sizes of hole can be digged by replacment of auger.

"CeCoCo" Auger attached on "CeCoCo" Screw Tiller

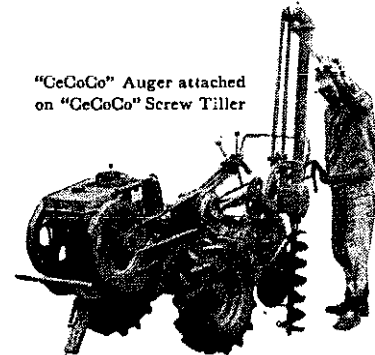

Specification of "CeCoCo" Auger

Type	Overall Height	Revolution		Boring Depth	Boring Speed	Size of Auger Standard	Weight in kg.		Ship'g Meas't
		Shaft	Auger				Net	Gross	
S-A	1,900 mm	260 rpm	105 rpm	max. 90 cm	0.9 m/min.	170mmφ×650mmL	30	60	20 cft

Remark :- Capacity is depending upon diameter of hole and boring depth.

## “CECOCO” SEED AND GRANULAR SPREADER

This particular spreader became popular because of weeding chemicals and fertilizer show a trend to be manufactured in granular type, as this form is so easy to handle and requires no water, and while a small quantity will be adequate for use when compared with other forms, and also can spread all kinds of small seeds evenly.

The hand operated granular spreader Type FG-2 is so simple and only to put the chemical or seed in the hopper of the said machine. By turning the handle of the machine, the material is pushed out by the vibration of a propeller, and then to be spreaded by a subsequent rotor.

The battery power granular spreader Type FG-1 is motived by two small batteries 1.5V set in cell with 2,000 revolution per minute.

“CeCoCo” Spreader Type FG-1



### Specification of “CeCoCo” Spreader

Material to be spread — seeds, and granular chemical etc.

Type.....	FG-1	FG-2
Spreading Radius.....	4 - 7 meters	5 meter
Power Required .....	1.5V × 2 batteries	Hand
Capacity of Hopper .....	10 liters, plastic made	7 litre, plastic made
Spreading Capacity .....	20 - 40 ares per hour	20 - 40 ares per hour
Overall Dimension.....	700mm × 430mm × 330mm	285mm × 275mm × 230mm
Net Weight .....	2 kgs. per set	2.3 kg. per set
Gross Weight .....	25 kgs. } 8 sets in a case.	30 kg. } 8 sets in a case
Ship'g Measurement .....	10 cft. }	10 cft. }

## “CECOCO” DIRECT PADDY SEEDER

It is very important to grow the seedling properly to be germinated and stabilized in the position where the seed is sown, weed out all noxious grasses and prevent unscrupulous divergency. Consequently, care should be taken not to sow too deep into the soil with a heavy cover-soil on, so that set the face of the paddy field even to keep it always level and firm enough to insure an easy and correct seeding in straight line. An ideal depth is about 3cm. In case if the temperature raises too high, an oxygen will become scarce eventually preventing a proper germination of seed. Therefore, it is recommended to keep the water deep enough to keep the temperature about 180°C. If the water is shallow it will tempt to raise temperature. Never raise the temperature more than 250°C.

So called barnyard grass will liable to grow when the water in the field is shallow. In order to prevent it from growing about 10cm deep of water it should be kept to kill such noxious grass. Furthermore, if the water is shallow, it will stimulate many unscrupulous divergencies which will hinder the growth of a strong and stout seedling in case of the direct sowing, so that by keeping the water deep enough prevent such divergencies to make it success.

The purpose of fertilizing with the nitrogen after about one month when the seed is sown, is to prevent it's flow out and eliminates the unscrupulous divergence to have the seedling grow strong for better and larger rice. Don't worry about the seeding grown very thin after 40 days when sown as it shows crop of a correct and perfect growing.

The Seeder is constructed all metal throughout. By adjusting the Brush in the seeder up and down at the outlet of seeds in the bottom of the Seed-Hopper, the number of paddy to drop into the seeding line can be adjusted to your requirements. The durability of Brush is about 25 acres of paddy field and the spare parts can be supplied, so that it is recommended to include some extra when ordering.

For the use on the dry-field the seeding upland paddy and wheat, take off the Float type Line Marker and replace it with the Furrow Opener by equipping it in the original holes setting tight, and with Soil Coverer equipped on behind at a extra charge.

Type ST-100W  
for watered-field

Type ST-100D  
for dry-field

Type ST-200W  
for watered field

Operation in Watered Field

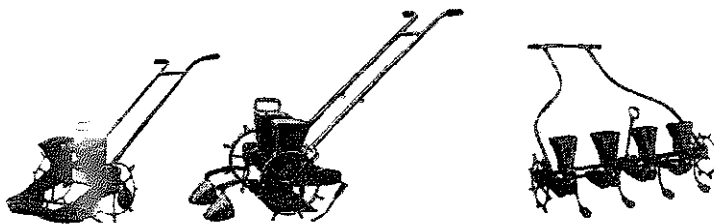

### Specification of “CeCoCo” Direct Paddy Seeder

Type	Seeding Rows	Seeding Width between Row	Furrow Depth	Capacity per hour	Hopper Capacity	Dimension in mm			Net Weight	Meas't Ship'g
						Height	Width	Length		
ST-100	2	240-360mm	30mm	10 ares	1kg × 2	430	820	1400	12 kg.	6cft
ST-A	4	240-360mm	30mm	20 ares	1kg × 4	300	1280	780	21 kg.	10cft
ST-200	4	240-360mm	30mm	20 ares	1kg × 4	430	1280	1600	19 kg.	10cft

Note— Seeding Width means between from center to center of Line Marker or Openers.

Type ST-A can be attached to 2-wheeled Power Tiller

## “CECOCO” HAND SEED PLANTER for exclusively dry-land

The “CeCoCo” Seed Planter Model FK-37 has been designed as the main purpose of labor-saving and non-tiller growing. This planter is available for many different seeds such as barleys, paddy-rice, rape-seed, radish, beet, millet, red beans, soybean, etc. The main handling is illustrated as follows :

Seed Planter  
Model FK-37

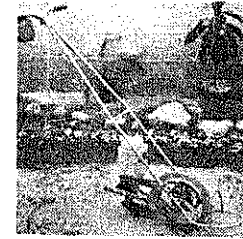

- 1) After available seeds are put into seed hopper, the planting work is performed by pushing the seed planter forward. The front furrowing wheel makes furrow for sowing. The furrow is good for the depth of 20mm - 30mm. This machine has a weight of 10 kgs., but, in case the furrow cannot smoothly be made suited owing to dry land, some suitable weight is to be put on weight receiver.
- 2) When the wheel goes ahead, seeding roller connecting with wheel and chain goes round and spreads seeds. Regulation of sowing quantity is made by loosening seed-regulating-screws with brown color which is inserted into seeding roller. A grain is not always even in size, so that operator needs calculation of the quantity of the fallen seeds per turn. Further, the two screw-regulators should be adjusted in the same graduation.
- 3) These seeds which gone down from the seeding roller fall between the working apparatus and come to the furrow. The working apparatus has been designed for falling the seeds into furrow without fail, even though this machine takes more or less the zigzag course, but adequate attention should be paid on going straight ahead the working apparatus in the furrow.
- 4) This planter will sow the seeds at the distance of about 15cm. between the spots where they are planted, but cannot adjust anymore. However, for shorter distance, speed up the planting. Try several time for your required experimentation.
- 5) This machine is available for planting of barley, wheat, paddy, rape-seed, radish, beet, etc. In case of rape-seed, the seed regulator should be replaced with another regulator due to the smallness of seeds.
- 6) The furrowing subsidiary wheel for dry land, seed-regulator for rape-seed and pressing-roller for dry land are prepared with the special parts and should be ordered separately at extra charge.

### “CECOCO” PADDY FIELD WEEDER

When transplanting the seedlings in the paddy fields. Try to grow them strong, healthy and stout by paying best attention in weeding and intercultivating in the nursery-bed to insure the best and large crop.

In order to save time from drudgery of weeding and intercultivating, it is recommended to adapt “CeCoCo” Paddy Field Weeder as the operation is easy and efficient.

It is very important, that, in order to facilitate the weeding and intercultivating, the seedlings should be planted in straight regular lines in the paddy field accurately.

The irregularity of rice-planting may cause the weeding and interculture very difficult and gives damages to the roots of rice-plants. Since most of grasses grow between rows, weed and intercultivate them regularly by using “CeCoCo” Paddy Field Weeder which is U-shaped with float and two claw wheels and a wood slanting handle. The depth of the weeding varies according the end float moved up and down to adjust the depth of the claw wheels. The handle can be adjusted in accordance with the operator's height. The width of planted rows, which is from 5<sup>3</sup>/<sub>8</sub>" to 7<sup>3</sup>/<sub>4</sub>" every 5<sup>1</sup>/<sub>8</sub>", and from 4.8kg to 5.6kg every 0.2kg in weight.

“CeCoCo”  
Paddy Field Weeder  
Single type

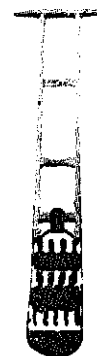

Specification of “CeCoCo” Paddy Field Weeder

Size or Width	Effective width	Capacity per day	Packing for 30 sets in 2 cases		
			Net Weight	G. Weight	Measure't
5 <sup>3</sup> / <sub>8</sub> "	18 cm	0.8 acre	@ 4.8 kg.	200 kg.	31 cft.
6"	21 cm	0.8 acre	@ 5.0 kg.	220 kg.	33 cft.
6 <sup>3</sup> / <sub>8</sub> "	22.5 cm	1.0 acre	@ 5.2 kg.	230 kg.	35 cft.
7 <sup>1</sup> / <sub>8</sub> "	24 cm	1.0 acre	@ 5.4 kg.	240 kg.	37 cft.
7 <sup>3</sup> / <sub>4</sub> "	27 cm	1.0 acre	@ 5.5 kg.	250 kg.	40 cft.

### “CECOCO” RIDGER OR MULCHER

Two weeks after transplanting, seedlings, the first, and 10 or 15 days thereafter, the second mulchings is to be done by furrowing between rows by ridger or hiller, covering 2 inches deep in all so that the roots of plant will be well covered with soils at least 4 inches deep. This special process will immeasurably nourish and help them grow very strong, stout and healthy and will withstand any sudden severe wind and help them from lodging and shattering when they are ripened.

Specification of “CeCoCo” Ridger

Type	Capacity per day	Furrow Width	Dimension in mm			Net Weight	Gross Weight	Ship'g Meas't
			Height	Width	Length			
B	1 acre	350mm	770	480	1,840	@ 8kg	80kg	20cft

“CeCoCo”  
Ridger

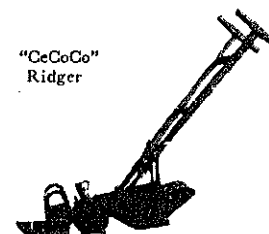

## "CECOCO" BIRD & ANIMAL SCARER BANG

Care should be taken to scare the bird when the seedling is being nursed in bed and when the rice is becoming matured in the paddy field to prevent a great damage caused by ravages. Acetylene gas with air mixture is automatically ignited at short intervals in 'T'-type explosion pipe which goes with a 'Bang'.

"CeCoCo" Bird and Animal Scarer is equally effective against sparrow or any other birds, rodent rabbit, wild boar, monkey, bear and other ravages of paddy field, orchard and field crops of food such as rice, wheat, fruits, radish, sweet potatoes, vegetable, nuts etc. It is a most ingenious apparatus, producing deafening reports at intervals of 3, 5, 10 and 20 minutes which can easily be adjusted and operated with low operational cost of 120 times of explosions with one pound of carbide. It is reliable in operation and is not dangerous to handle even by young folks, and is strongly recommended to adapt during the night for animal.

"CeCoCo" Scarer 'Bang'



Specification of "CeCoCo" Bird & Animal Scarer Bang

Overall Dimension		Capacity of Carbide	Net Weight	6 sets in two cases	
Height	Diameter			Gross Wt.	Meas't
930 mm	140 mm	350 gm	@ 7kg.	60 kg.	5 cft

## "CECOCO" SPRAYER

This is used for spraying insecticide and germicide solution to protect farm products from insects and disease. Formerly it was used only for orchard and horticulture, but now used as preventive and prophylactic measures by farmers especially in paddy and wheat fields.

The Japanese sprayer, in order to prevent erosion from the spraying fluid, is made of brass or bronze. Resistance to internal pressure and endurance is good. Hanging, Knapsack and Automatic types have been decided by J.I.S. (Japanese Industrial Standard).

No special requirements are necessary while in use, but when used, it is very important to wash out the spray container as well as the spraying pipe and hose with water. When preparing the solution, solid particles, such as sand, undissolved particles, etc. should not be in the solution.

A) POWERED SPRAYER—power is transmitted from engine to driving pulley on main shaft by V-belts, and is further transmitted to crankshaft by gears inside crankcase, and, through connecting rod, causes plungers to reciprocate. By this reciprocating motion of plungers, drug liquid is sucked in through strainer and suction hose, from the liquid tank to suction chamber, and through delivery chamber, service cocks, delivery hose, filter and nozzle extension, ejected from nozzle. To keep on spraying in no fluctuation of discharge pressure, vertical triplex plunger type is adopted. The vertical plunger sprayers are free from the defects proper to horizontal plunger type. With horizontal motion of piston, impurities in the liquid are

Model S-T

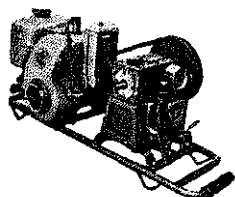

Model S-S

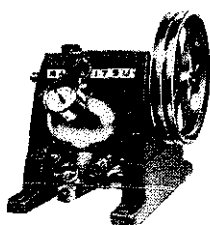

Model S-M

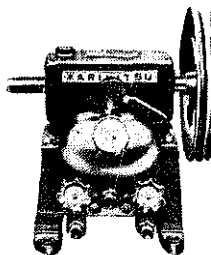

Model S-L

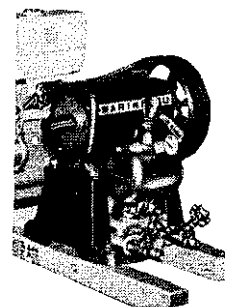

Model SK-A



sucked up into the inside of cylinder according to the law of inertia and then stick to the packings; therefore packing and piston, particularly lower parts of them are worn out excessively. In vertical plungers, however, impurities are pushed through vertical motion of plunger so that defacement of piston and packing is reduced remarkably. Besides this, it is absolutely safe that no liquid flows back to mix with mobil oil in crank case. After the use of machine, remaining liquid can be dripped out completely through drain plug and consequently metal parts are free from corrosion.

Plungers are of high grade stainless steel, which strongly withstands high speed revolutions, wholly and protected from injury by dust or dirt. Piston Packings are enclosed of Special Synthetic V-type packing which are highly wear-resistant.

Specification of "CeCoCo" Power Sprayer

		Model R-T	Model S-S	Model S-M	Model S-L
Plunger (Dia. x Stroke)		18mm x 12mm	22mm x 22mm	30mm x 20mm	40mm x 35mm
Pressure	Normal	21 kgs./cm <sup>2</sup> (300psi)	21 kgs./cm <sup>2</sup> (300psi)	21 kgs./cm <sup>2</sup> (300psi)	21 kgs./cm <sup>2</sup> (300psi)
	Maximum	30 kgs./cm <sup>2</sup> (425psi)	35 kgs./cm <sup>2</sup> (500psi)	35 kgs./cm <sup>2</sup> (500psi)	35 kgs./cm <sup>2</sup> (500psi)
R. P. M.	Spraying	500—1400	500—800	500—80	300—600
	Irrigating	.....	1000—1200	10000—13000	1000—1300
Discharge per hour	Spraying	273-768 liter	753-1205 liter	1266-2028 liter	2370-4746 liter
	Irrigating	.....	1506-1807 liter	2535-3582 liter	7080-10290 liter
Power Required		0.5—1.5 H.P.	2—3 H.P.	2—3 H.P.	4—8 H.P.
Dimension in mm, H x W x L		200 x 210 x 233	248 x 282 x 312	292 x 330 x 280	380 x 408 x 402
Net Weight, without engine		6.8 kgs.	15.3 kgs.	15.8 kgs.	35.0 kgs.
Packing with Engine	Net Weight	34 kgs.	42 kgs.	70 kgs.	150 kgs.
	Gross Weight	64 kgs.	76 kgs.	120 kgs.	220 kgs.
	Measurement	8 cft	10 cft	13 cft	25 cft

B) AUTOMATIC KNAPSACK SPRAYER — Insecticide contained gushes out by one air compressing before operation. Therefore the operator can devote himself to his work by using long nozzle (s) by one or both hand (s) with this sprayer on his back. The inside of this sprayer is so designed as to keep spraying in perfect and uniform condition. Materials used being nickel plated brass plates and brass tubes of good quality. This sprayer is entirely free from corrosion against a long-term use.

Specification of "CeCoCo" Automatic Knapsack Sprayer

Model	SK-A	SK-B	SK-C
Tank Capacity	11 litres	14 litres	18 litres
Liquid Capacity	7 litres	9.3 litres	12 litres
Discharge/hour	50 litres	70 litres	100 litres
Empty Weight	5.5 kg.	6.2 kg.	7.7 kg.
Max. Pressure	10 kg/cm <sup>2</sup>	10 kg/cm <sup>2</sup>	10 kg/cm <sup>2</sup>
Final Pressure	2 kg/cm <sup>2</sup>	2 kg/cm <sup>2</sup>	2 kg/cm <sup>2</sup>
Contents a case	12 sets	12 sets	6 sets
Gross Weight	100 kg.	110 kg.	72 kg.
Ship'g Meas't	18 cft	20 cft	14 cft

Model SK-B

Model SK-C

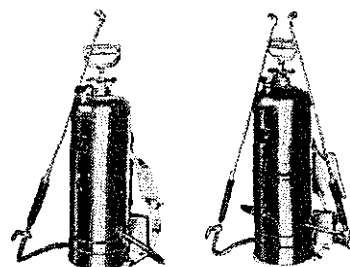

C) "CeCoCo" SEMI-AUTOMATIC KNAPSACK SPRAYER—Invariable pressure is kept in operation. Therefore spraying is performed uniform and sprinkling of insecticide perfect. A special care was taken in manufacturing the handle and repeated improvements have succeeded in making it very easy and handy to operate.

Our own design is adapted to strengthen the pressure and the bottom section can freely be disassembled for cleaning and washing.

Specification of "CeCoCo" Semi-automatic Knapsack Sprayer

Model SAH

Model SA

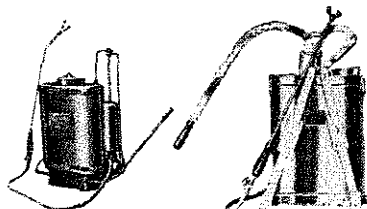

Model	SAH	SA	SA-8
Tank Capacity	17.5 litres	17.5 litres	13 litres
Liquid Capacity	17 litres	17 litres	12 litres
Discharge/hour	110 litres	110 litres	75 litres
Empty Weight	7.0 kgs.	6.5 kgs.	4.9 kgs.
Pressure	10 kg/cm <sup>2</sup>	10 kg/cm <sup>2</sup>	10 kg/cm <sup>2</sup>
Contents a case	6 sets	6 sets	6 sets
Gross Weight	70 kgs.	68 kgs.	50 kgs.
Ship'g Meas't	19 cft	16.5 cft	14.5 cft

D) "CoCoCo" CARRYING-OVER-SHOULDER SPRAYER — This sprayer can easily be operated by one man and therefore is very convenient and useful for farming of minor scale.

The semi-automatic pumping operation is extremely easy and comfortable. Packing is easy to be replaced with new one. Cleaning and washing can be done very simple. All chrome plated brass made.



Specification of "CeCoCo" Carrying-Over-Shoulder Sprayer

Model	CS-1	CS-2
Tank Capacity	9 litres	9 litres
Liquid Capacity	8.5 litres	8.5 litres
Empty Weight	3.5 kgs.	3.0 kgs.
Pressure	7 kg/cm <sup>2</sup>	7 kg/cm <sup>2</sup>
Contents a case	12 sets	12 sets
Gross Weight	67 kg.	60 kg.
Ship'g Meas't	14 cft	14 cft

Model CS-1



Model CS-2

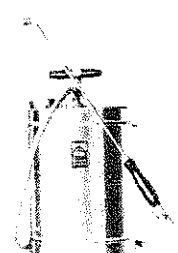

E) "CeCoCo" SEMI-AUTOMATIC HAND SPRAYER—Owing to light weight, this can be operated in 15 to 16 rotations per minute and can also be moved around easily, and is most suitable for disinfecting orchard and barn yard. The structure simple and is very convenient for cleaning. The piston-rod is specially made to operate smoothly. All nickel plated brass made.

Specification of "CeCoCo" Semi-automatic Sprayer

Model S-2



Model S-1

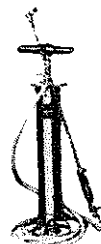

Model	S-2	S-1
Dia. of Pump	62.5 mm	87.5 mm
Discharge/hour	100 litres	130 litres
Empty Weight	3.2 kgs.	5.0 kgs.
Pressure	10 kg/cm <sup>2</sup>	10 kg/cm <sup>2</sup>
Content a case	30 sets	12 sets
Gross Weight	140 kgs.	100 kgs.
Ship'g Meas't	23 cft	12 cft

F) "CeCoCo" DIAPHRAGM TYPE SEMI-AUTOMATIC KNAPSACK SPRAYER—

Specification of "CeCoCo" Diaphragm Type Knapsack Sprayer

Model	SD-10	SD-8
Construction	All brass made	Galvanized steel
Dimension m/m	178×350×470	180×350×420 mm
Tank Capacity	17.0 litres	15.0 litres
Liquid Capacity	16.7 litres	14.4 litres
Pressure	10 kg/cm <sup>2</sup>	10 kg/cm <sup>2</sup>
Empty Weight	6.2 kgs.	5.9 kgs.
Contents a case	6 sets	12 sets
Gross Weight	60 kgs.	90 kgs.
Ship'g Meas't	13 cft	16 cft

Model SD-10



"CECOCO" POLYETHYLENE MADE TANK HAND SPRAYER

The unit is made of corrosion proof and dent resistant polyethylene plastic. Light in weight, long life and durable. Suited for all agricultural pest-controlling works and for sanitary use.

"CeCoCo" Semi-automatic Knapsack Sprayer 'SAP'

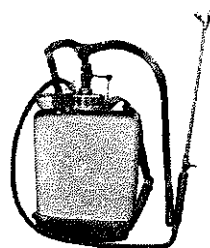

Specification of "CeCoCo" Poly. Tank Sprayer

Model	SAP	CSA
Capacity of Tank	19.5 liters	9.0 liters
Liquid Capacity	17.5 liters	7.5 liters
Net Weight	5.8 kg.	2.0 kg.
Dimension in mm	350×170×570	280×130×480
Pressure	10 kg/sq.cm.	5-7kg/sq.cm.
Packed in a case	6 sets	12 sets
Export Packing	60 kg. 14 cft	45 kg. 14 cft

"CeCoCo" Carrying-Over Shoulder Sprayer 'CSA'

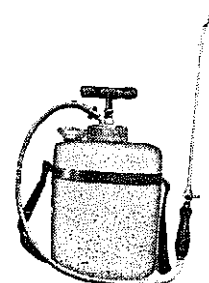

## "CECOCO DUSTER"

As the farmers are keen and attentive to the welfare of the crops against insects and infection by disease, and also due to the encouragement by the government, this apparatus has become one of the most useful farming implements.

The important point is that the powder should be dry. The machine is so simple that it requires no special direction to use it.

- A) "CeCoCo" HANDY BABY DUSTER Model A — Painted in a beautiful colour, small but efficient performance. Popular for dusting gardens, small farms and the disinfection of livestock etc.

Specification :- Hopper Capacity 0.4 litre; Wind Velocity 3.0 - 4.0 m/sec.; Discharge range 3 meter; Weight 0.7 kg. per set; Packing 60 pcs. in a case, G.W. 76 kgs. Measurement 12 cft.

"CeCoCo" Baby Duster Model A

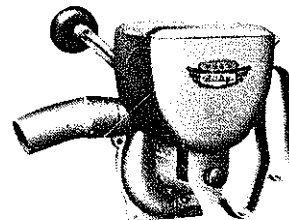

- B) "CeCoCo" BREAST HAND DUSTER Model B — With an quick-acting agitator and strong blast valve, the equipment is designed to scatter even the wet powder evenly and completely further than usual. Gear cases and ball supporting plug are all set in the air-tight box with grease lest the "CeCoCo" Breast Hand Duster Model B powders should enter into it.

Specification :- Hopper Capacity 5 litres; Wind Velocity 12 - 17 m/sec.; Discharge range 8 meter; Weight 3.1 kg.; packing 6 pcs. in a case G.W. 57kgs. and Measurement 11 cft.



- C) "CeCoCo" POWERED DUSTER MODEL PD-C — It has strong efficiency to dust the powder, so you can use even wet powder adjusting delicately. The velocity and the quantity of the dusted powder are comparatively large, so you can scatter the powder evenly and widely. We adopted the turbo-fan type.

The efficiency of air blast is greatly increased. The tank of the powder can be inclined to 20 degree. So, by carrying it on the back, you can dust the powder competently.

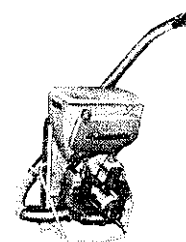

Model PD-C

### Specification of "CeCoCo" Power Duster Model PD-C

Body :-

Dimension ..... 380×390×520 mm  
 Weight ..... 10.9 kgs.  
 Air Blast ..... 4,000 - 4,500 rpm  
 Tank Capacity ..... 10 litres  
 Wind quantity ..... 4 - 4.5 m<sup>3</sup>/min.  
 Wind velocity ..... 48 - 55 m/sec.  
 Discharge Range ..... 20 meters

Engine :- Air-cooled, Gasoline engine  
 Single-cylinder, 2-stroke/cycle type.  
 Displacement Volume ..... 37 cc  
 Cylinder ..... 35×38 mm  
 Output ..... 1 H.P.  
 Vaporizer ..... Amal M-11  
 Ignition ..... Flywheel magnet  
 Starting ..... Hand rope

- D) "CECOCO" POWER MIST DUSTER

The "CeCoCo" Mist-Duster can be used without using tools in two ways, namely as a Power Duster and as a Mist Sprayer.

The vibration of the engine is completely eliminated by four well dimensioned rubber components, so the operator does not feel any fatigue or unpleasantness during long time operation. The engine can be started simply by pulling a recoil starter. In case of a break-down of the recoil starter, it can be started with an aid of a starter pulley provided with every machine.

Liquid sprays directly to the nozzle with shut on and off type spraying gun and calibration device attached to the nozzle with four jets which are adjustable and has a liquid output of 0.5 to 2.5 litres per minute. High pressure air is forced into the tank by blower in order to form an air cushion inside the tank for even delivery of the nozzle.

Powder is pulverized and agitated enough owing to a Ventilation distributor unit, equipped and therefore dusting is kept always uniform.

"CeCoCo" Mist Duster

### Specification of "CeCoCo" Mist Duster

Dimension ..... 400 mm × 200 mm × 600 mm  
 Air Volume ..... 6.5 m<sup>3</sup>/min.; Air Velocity ..... 84 m/sec.  
 Capacity of Tank ..... 10 litre of liquid; 5 kg. of powder.  
 Discharge per minute ..... 0.5-2.5 litres for spray, 0.6-1.2 kg. for powder.  
 Discharge Range ..... 8 m at horizontal, 6 m at vertical.  
 Engine ..... Air-cooled 2-cycle Gasoline engine, 2.0-2.6HP/7,000 RPM, 35cc, with Auto. recoil starter.  
 Net Weight ..... 7.5 kg.; Gross Weight ..... 25 kg.; Meas't - 7 cft.

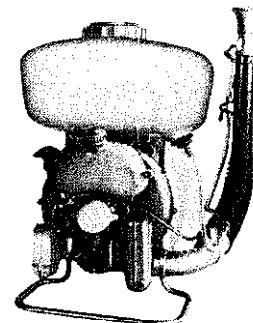

## THE ROLE OF COPPER SULPHATE IN RICE GROWING

First recorded use of copper sulphate as a fungicide was in Europe in 1761 when Schultze soaked wheat in a weak copper sulphate solution to combat seedborne fungi. Today, two centuries later, it is one of the most widely used chemicals in agriculture. World production is around 300,000 tons per annum, the bulk of which is used mainly in the form of Bordeaux mixture (a mixture of copper sulphate, lime and water), to protect plants against a host of fungus diseases, ranging from downy mildew of vines in Europe to black pod of cocoa in Africa, and from coffee rust in India to potato blight in Ireland.

Until quite recently little use has been made of copper sulphate in the growing of rice. Prosperity and rapidly increasing populations, however, have within the last decade or so begun to focus the urgent need for increasing yields of rice, and the role this simple, cheap and easy-to-handle chemical is likely to play in combating some of the scourges of this important cereal is only now beginning to manifest itself.

### SCUM IN RICE FIELDS.

This scum which is largely made up of a number of different species of green and brown algae, shuts out light and heat to the young plants and impedes their development in the early stages. Scum is easily and rapidly controlled with copper sulphate and in Egypt the following method has been successfully employed:

A calico bag containing a predetermined weight of copper sulphate crystals is suspended from a branch of a tree or a wooden stake in such a manner that the bag is only partly submerged in the water at the intake channel. It is important that the bottom of the bag, although immersed in the irrigation, water, should not touch the bed of the canal. In this manner the copper sulphate is dissolved at a regular speed according to the inflow. One application at appr. 5 lb copper sulphate per acre generally suffices, but where the scum is severe a second or third application may be needed. In addition to destroying scum, copper sulphate is believed to stimulate the growth of the rice, and yield increased of up to 750 lb or more per acre have been recorded from fields so treated with copper sulphate.

### COPPER SULPHATE AS A FERTILISER.

Gopala Rao and Govindarajah working in south India studied the manurial effect of copper sulphate on the yield of grain and straw over a period of four years.

Applying up to 10 lb. copper sulphate per acre along with the usual manures, they were able to record increased yield for both grain and straw, as much as 820 lb. grain and 2,400 lb. straw per acre over the control plots being recorded in some instances. Joshi, N.V. and Joshi, S.G., studying the effects of copper sulphate on rice, started by conducting plot experiments with poor soil. The addition of copper sulphate alone to the soil gave them a 35 per cent increase in the yield of grain over the control, but when they added copper sulphate along with manures, they were able to obtain a 77 per cent increase in yield over that obtained by the use of the manure alone. Encouraged by these results they proceeded to conduct large-scale field trial, as a result of which they found that soils in a number of districts in the Bombay State of India responded well to copper, and as little as 1 lb copper sulphate per acre applied to the soil in which rice seedlings were grown for transplanting gave an increase of 27.5 per cent in the final yield of grain as compared with the untreated area.

### CONTROL OF SNAILS.

The problem of water snail damage to germinating rice appears to have been largely overlooked in the past, and it was not until 1955 when de Wit and van Gilst were investigating the failure of some 300 acres of paddy to germinate that the ravages of the water snail *Pomacea Lineata* were brought to light. These researchers, observing snails traces in the soft muddy seedbed when the water from a field which had completely failed to germinate was drawn off, set about sowing seeds in cages with the bottom and sides made of mosquito-netting. In some they introduced snails and in other not. Within 48 hours the growing points of the seed in the snail containing cages had been devoured, whereas the seeds in the blank cages germinated normally.

Snails, as is well known, are extremely susceptible to copper and a few parts per million of copper sulphate are sufficient to kill a water snail. It is not surprising, therefore, that it was one of the control measures successfully tried by de Wit and van Gilst. They were actually able to control *Pomacea Lineata* with one application of 5 lb copper sulphate per acre to the irrigation water. The timing of the application is, however, rather critical and it may sometimes be necessary to make more than one application if a satisfactory control is to be achieved.

### SEED-BORNE AND OTHER FUNGUS DISEASES.

Hoshioka working in Formosa on rot disease (also known as cold injury) of rice seeds and seedling, which is known to cause heavy damage to the crop in the seedbeds, isolated a number of species of fungi from the affected seedlings and also from the soil.

He was able to control the disease either by desolving copper sulphate in the irrigation water so as to obtain a concentration of 25 parts copper sulphate per million parts of water, or by spraying 2 per cent solution of copper sulphate on the soil before sowing at the rate of 100 gallons per acre.

Nisikado and his co-workers in Japan, studying methods of testing the effectiveness of fungicides, grew rice seedlings and mature plants in pots which they infected with leaf spot disease by spraying the plants with a spore suspension of *Helminthosporium Oryzae*. They then proceeded to test the effectiveness of 13 fungicides by spraying them on the infected seedlings and mature rice plants. Of all the fungicides tried Bordeaux mixture proved the most outstanding, being effective even at as low a concentration as 0.05 per cent.

In Indonesia Schure demonstrated that it was possible to prevent Kresek disease (*Xanthomonas Kresek*) by dipping rice seedlings in an 0.05 per cent solution of copper sulphate. The seedlings which had been dipped in the copper sulphate solution failed to develop the disease when inoculated with the casual bacterium *Xanthomonas Kresek*.

In India, where Blast Disease (*Piricularia Oryzae*) is of considerable economic importance, it has been found that seed treatment cannot alone be expected to give an adequate control, as the disease is largely airborne. Seed treatment must be supplemented by at least one spraying with a 3:3:50 Bordeaux mixture when the seedlings are 2-3 weeks old and again with a 5:5:50 Bordeaux mixture before emergence of the ear heads.

“CeCoCo”’s Policy is to Contribute Through the Efficiencies  
of Products Not to sell Machine Itself

“CECOCO” Service; “CECOCO” do not intend to sell their products merely to earn profit, but are always considering to promote for increasing native products through the efficiency of “CECOCO” products to the advantage of the end-users by solving the difficult problems confronting them. So that do not hesitate to command “CECOCO” for any question or inquiry as you will find “CECOCO” at your disposal with a great pleasure replying promptly.

### JAPANESE RICE CROP AND TYPHOON

Many must have took another look at the Estimated Rice Crop of this year of 1965 published by the Cabinet yesterday. It shows a figure almost identical to the last year, the fifth largest harvest on the record. Where has gone that fear of this apring, people said it would be the leanest year of the worst imaginable.

It was the Weather Bureau who gave warning that the position of black spots on the sun are exactly after the pattern of those in Tenmei leanest harvest year and gave precution to people of damage by unseasonable cold climate. Then the warning was mistaken? No, it was not the Weather Bureau. In fact, until July the low climate persisted, here and there were cases of farmers suicides because of damage on crop by cool weather.

Since August, it came back to ordinally climate, however, we can still say the long-period forecast of the Weather Bureau was very much near to the point. With this kind of weather, it were happened in pre-war days, surely results was as poorest crop as we experienced in 1933 and 34. Despite of the fact, in Hokkaido, where the effect of poor weather was most apprehended, they gathered crops bigger than last year.

Affected by unseasonable cold weather and typhoon, this could have been a bad year for rice crop, but after all it turned out alright. As the biggest reason for it, we can count improved agricultural technics. Years ago, rice flower bloomed around typhoon season, but now, thanks to the utilization of vinyl spreading over seed bed, transplanting period have been speeded up, so that by the time typhoon visited us rice plants are already bearing ears, and damage be kept to the minimum.

Fertilizer played also another big part in marking rice stalk stronger. Against cold climate, it has stronger resistance. Rural areas have fewer and fewer male hands these days. It is generally told agriculture operated by granpa, elder brothers of a family and a woman’s labour is now further shifting into hands of housewives only. Under adverse weater condition, operated by farmer’s housewives, still rice crop of this year yield quite near to an average of any ordinally year.

Maybe we can possibly say ‘A lean crop’ is no more a fact in agriculture. Our future problems are to develop lands like volcanic ashy soil which is so far considered not suitable for farming, and further strength roots of rice plants. Victory of rice crop against unfavorable weather conditions is significant indeed.

We are already suffering from depression and slack business, suppose rice crop was poor this year, it would have made the bad days worse. Danntless against typhoons and unseasonable cool climate, rural community is now harvesting it’s fruits of labour, to whom the Japanese people sincerely send the words of appreciation. Village festivals for harvest will beat rythm of drum this harvest year. ‘Good bye, Lean year’, ‘Thank you, Mrs. Housewives!

# HARVESTING AND DRYING

## "CECOCO" HAND-PUSH RICE PLANT CUTTER

The rice-plant cutting is one of the most tiresome and drudgery job in rice harvesting. The Push-on type will cut rice-plant in the area of 0.12 acre of paddy field for one hour, about five times faster than by hand sickle or reaping-hook cutting, even plant is lodged, it cuts easily by women or young folks. It can be adjusted to any height desired for operator.

Specification :- Dimension 735 mm H x 585 mm W x 1,490 mm L ;  
Net Weight 9 kg. per set; 6 sets in a wooden case for export  
Gross Weight 90 kgs. and Measurement 20 cft.

"CeCoCo" Rice Plant Cutter

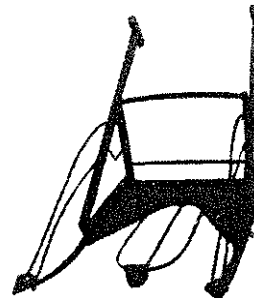

## "CECOCO" POWER REAPER

The "CeCoCo" Power Reaper is made of steel pipe and metals and simple in construction, compact, rigid and very light in weight and can reap the stalks of rice and also wheat easily in the fields. The reaper is powered by a 1.5HP Air-cooled gasoline engine which is mounted on steel pipes frame.

Specification :- Dimension 760 mm H x 635 mm W x 1,940 mm L ; Net weight 30 kgs.; Reaping Capacity is 0.25 acre for rice plant and also 0.3 acre for wheat stalk and upland rice-plant per hour ; Gross Weight 70 kgs.; Measurement 20 cft.

"CeCoCo" Power Reaper



## "CECOCO" HAND RICE-PLANT CUTTER

Operation of "CeCoCo"  
Hand Rice Plant Cutter



Type :- SM-11  
Capacity :- 0.12 acre per hour  
Cutting Blade :- a pair of serrulated shape blade and a piece of thin sickle  
Dimension :- 650 mm H x 265 mm W x 1,300 mm L  
Net Weight :- 2 kg. per set  
Export Packing :- 10 sets in a carton box and measurement 10 cft.

This handy Rice-plant Cutter is metal made throughout and very simple in construction with a steel pipe form handle and sharp cutting blades which can easily be detached and sharpened instantly. Therefore it is very strong and durable and can be used for years when kept dirt free and greased thoroughly. As you will see in the picture, operation is very easy and speedy with a least labour and even when the rice-plant are lodged, and cropped plants are ready for sheaves in group. In order to save a tiresome labour and time, strongly recommend you to adapt at once without any hesitation as the price is moderate.

## "CECOCO" MIDGET COMBINE HARVESTER

for Rice, Wheat & Barley

Reaping and preparing sheaves are usually done by women and men around the paddy field; threshing out the sheave by swinging them over their shoulder and beating them down into a tub or by treading by buffaloes and oxes. However, this results in high grain losses due to shedding, incomplete threshing and the incidence of damage is also very high.

The need for simple and efficient rice Combine is essential. Because the shortage of labour has made it difficult to reap and thresh sufficiently fast, creating a bottle-neck at harvesting time. Furthermore, loss and damage incurred by traditions of harvesting and threshing could not be afforded in view of the

Combine in operation



rapidly increasing population and its inherent food problem.

In order to overcome the above difficult problem, we are happy to announce you that, after many years of assiduous experiences, we have finally succeeded in presenting a unique designed "CeCoCo" Midget Combine with our sincere hope that the rice and wheat growers in the world will save the time and labour and raise the level of total productivity by increasing or doubling the crop especially by preventing the losses of shedded grains.

"CeCoCo"  
Midget Combine



Speciality of this particular Combine is portable, light in weight and easy to carry around for operation and leaves the straw on the spot in the field where the crops is harvested as a fertilizer, thus it saves time and labour and is very economical. Under the unique design, no straw rack, agitator and sieve are adapted, because, reaping and threshing are accomplished efficiently by the utilization of air current. All metal throughout and simple in construction, thus, eliminates any faulty mechanical troubles and is sturdy and durable. Always maintains a smooth running, gives no damage and no waste of grains left on field, because all grains which usually scattered around during operation are sucked into Combine by the air current. Requires a very small space in installing and only a small power to operate.

Combine with Caterpillar for shallow watered field

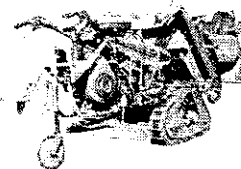

Specification of "CeCoCo" Combine Harvester

Type	Capacity per hour	Power Req'd	Speeds	Reaping Width	Dimension in mm			Weight in kg.		Ship'g Meas't
					Height	Width	Length	Net	Gross	
C-K	approx. 5 ares	6-9HP Engine	6-forwards 2-reverses	680mm ±50mm	1240	850	3080	400	626	145 cft

Remarks: Caterpillar wheel to option at extra charge.

"CECOCO" VENTILATORY DRYER

For Grains, Seed, Grass, Vegetable, Fish & other materials

Prefabricated view of "CeCoCo" Ventilatory Dryer with a Oil Heating Equipment. It can be operated either by electric motor or by kerosene or diesel engines of small power when additional heat is required.

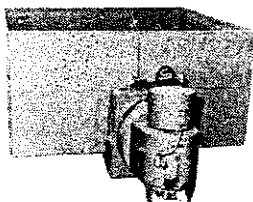

In order to speed up the ventilation, we can supply a heating unit as above explained.

Speciality of this particular dryer is this, that it does not require any of heating sources such as oil, coke, wood, briquet or fuels but evaporates the MOISTURE contained in the materials by means of changing air. Although it varies according to the climates, usually when temperature is 20°C and humidity 80% it evaporates the moisture contents of 10.4 kg., through the circulation of air which is abundant and no cost for heating. It does not deteriorate the nature and character of the materials to be dried, keeping intact their original colors, flavour and taste.

It is very economically and conveniently used for drying rice, wheat, barley, paddy and other grains, fodder, mushroom, sliced potato, hay and other grasses and tea leave etc.

A quantity of materials up to 1,650 kg. of paddy or 800 kg. of grass in volume, can be dried in one operation even in rainy season. It requires small power of 1/4 to 1 HP electric motor according to the volume of contents, and sizes of material contained.

Specification of "CeCoCo" Ventilatory Dryer, whole set comprises Material Container, Air Blower and Oil Burner(Heater)

1) Specification of Material Container and Capacity in Paddy (rice in husk) —

Type & Area of Container	Charging Quantity in paddy	Horse Power and Revolution of Blower			Drying Time Required	
		1/4 HP/ 1200 RPM	1/2 HP/ 1500 RPM	1 HP/ 1800 RPM	Hot Air by Oil Burner	Normal Air by Blower
HS-10 36 sq. ft.	550 kg	most suit.	suitable	suitable	5 - 8 hours	12 - 20 hours
	720 kg	suitable	most suit.	suitable	- do -	- do -
	830 kg	unsuitable	suitable	most suit.	- do -	- do -
HS-20 54 sq. ft.	830 kg	most suit.	most suit.	suitable	- do -	- do -
	1,100 kg	suitable	most suit.	most suit.	- do -	- do -
	1,250 kg	unsuitable	unsuitable	most suit.	- do -	- do -
HS-30 72 sq. ft.	1,100 kg	most suit.	most suit.	most suit.	- do -	- do -
	1,450 kg	suitable	suitable	most suit.	- do -	- do -
	1,650 kg	unsuitable	unsuitable	most suit.	- do -	- do -

Remarks :- Drying time and charging capacity vary according to materials, moisture contents, degree of dryness, temperature, humidity, climate, weather and drying method either Hot Air supplied by Heater or Normal Air by Blower.

2) Specification of Blower Type FN-47 —

Horse Power	H.P.	1/4	1/2	1
Revolution	R.P.M.	1,200	1,500	1,800
Static Pressure	M/M	44	33	29
Wind Quantity	M <sup>3</sup> /S	0.5	1.0	1.4

Dimension ... 580 mm × 405 mm × 690 mm; Blade of Fan ... 480 mm dia. × 8 blades

"CeCoCo"  
Blower and Oil  
Burning Equipment

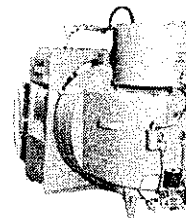

3) Specification of Oil Burning Equipment Type R60CK —

Dimension ... 585 mm × 470 mm × 685 mm; Capacity of Oil Tank ... 9 litres;  
Oil Consumption ... 0.5 - 1.5 litres/hour; Fuel to be used ... Kerosene oil;  
Electric Source ... Single-phase AC

### "CECOCO" AUTOMATIC CONTINUOUS GRAIN DRYER

This Grain Dryer is specially designed and constructed to dry for preservation of paddy and barley to be dried by means of a hot air. The moistures contained in the materials are evaporated by heat given to air properly.

No agitation of materials by hand is necessary as they are automatically agitated rotor and is dried gradually and uniformly exhausting the vapor by fan while they are conveyed, drying them to any degree desired. The thermometer are equipped to take care of the temperatures at glance, so that even woman and young folks can adjust air properly and operate the dryer satisfactorily.

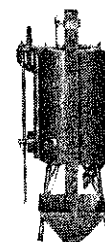

Specification of "CeCoCo" Automatic Continuous Grain Dryer

Type	Size of Drum		Stage Nos.	Power Req'd		R.P.M.	Capacity Per hour	Dimension in mm			Net Weight	Ship'g Meas't
	Dia.	Height		Drive	Heater			H	W	L		
AE	2 ft.	3 ft.	7	1/4 HP	3 KW	3000	60 kg.	1850	1120	1195	230 kg.	80 cft
BE	3 ft.	5 ft.	10	1/4 HP	4.5 KW	3000	130 kg.	2460	1413	1506	530 kg.	210 cft
CE	4.4 ft.	5 ft.	10	1/2 HP	6 KW	3000	260 kg.	2460	1840	1925	1000 kg.	280 cft

### "CECOCO" AUTOMATIC THROUGH-FLOW DRYER

Excellent Characteristics:

1. Reduction of Drying Period.
2. The Best Quality Product.
3. Uniform Drying.
4. Free Controls for Drying Period, Temperature and Air.
5. High Efficiency and Required no Labour.
6. Drying costs reduce to 50%.
7. Strongly Built and no Trouble in Operation.
8. Suitable Drying materials as Granular, Flakes, Fibre-form, Tips, Moulding (Chemical, industrial materials, foodstuffs, feed stuffs, manure or fertilizer, etc.)

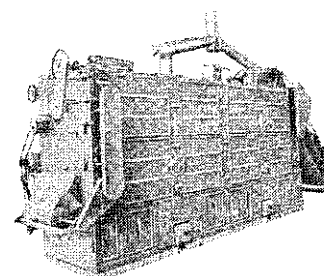
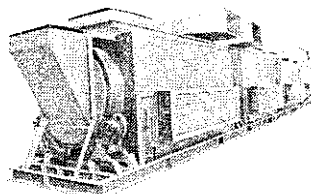

We are producing many dryers besides the machine explained here, so that we can supply the most suitable dryers you are looking for.

In case of order or inquiry, please inform "CeCoCo" the following items.

- |   |   |
|---|---|
| a. Names of drying materia's.                         | g. Permissible temperature.                               |
| b. Nature, Shape and Size of materials before drying. | h. Desired drying quantity per hour (material & products) |
| c. Moisture content before drying.                    | i. Heat source, (Oil Burner, Steam, Gas, Heater, etc.)    |
| d. Moisture content after drying.                     | j. Capacity of available heat source.                     |
| e. Desired shape & colour after drying.               | k. Samples, materials & dried products.                   |
| f. Use of dried materials and shape of final product. |   |

## "CeCoCo" CUBICAL TYPE VENTIRATORY (DRAUGHT) GRAIN DRYER

These specialities of ventilatory dryer lies in (1) high air temperature (2) air is dry and low humidity (3) fresh air is continuously supplied in volume quantity and this machine is used for drying the materials by practical application of these 3 specialities and if the air temperature is low with high humidity, the oil burner is used together.

If the blowing air has a high percentage of humidity, the moisture content of materials will not drop and not well dried no matter how air is supplied, so that oil burner is used together. If air temperature is raised 1 C, the humidity will drop some 4% and drying efficiency will increase.

The humidity is found less than 60%, don't use Oil Burner and the drying normal temperature by Blower only is recommendable. On the contrary, even if the humidity is more than 60%, if the moisture contents of raw materials is very high, Oil Burner must not be used at the beginning and the moisture content is reduced to less than 20% by normal temperature of air by Blower, Oil Burner can be used.

This cubical type ventilatory dryer is such type of dryer that a certain amount of materials is fed into this dryer and the materials are removed after well dried and blower, oil burner and moter are stored inside of dryer, so that installation space is only 1/3 of plain type dryer.

Specification of "CeCoCo" Cubical Type Ventilatory Grain Dryer

Type	TV-29	TV-36	TV-48
Capacity/charge	12-19 bush.	18-36 bush.	36-72 bush.
Dimension	Length	1,170 mm	1,440 mm
	Width	1,020 mm	1,330 mm
	Height	2,010 mm	2,010 mm
Blower	Bore	290 mm	360 mm
	H.P.	1/2	1/2
	R.P.M.	2,300	2,300
Fuel Consumption per hour	+15°C	480 cc	800 cc
	+25°C	800 cc	1,300 cc
	+30°C	1,100 cc	1,800 cc
Thrower	H.P.	1/2-1	1/2-1
	R.P.M.	900-1,200	900-1,200
	Output	1.2-2.4 T/H	2.0-3.6 T/H
Net Weight	97 kg.	165 kg.	276 kg.

"CeCoCo" Cubical Type Ventilatory Grain Dryer

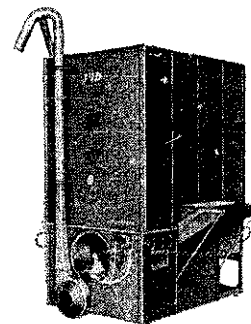

## "CECOCO" GRAIN MOISTURE METER

"CeCoCo" Grain Moisture Meter Model PB-1

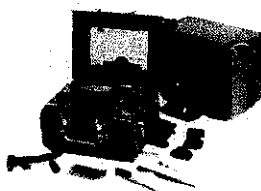

This meter is as electrical resistance type and can be applied for rice, barley, wheat, rye, flour, soy bean, maize, and other grains. After crushing sample with hand mill, fill sample into sample-dish in the electrode stand and press down or turn on handle and moisture content is indicated on the meter. This instrument can be used by anyone with very simple instruction. An accurate percentage of moisture content is shown on the meter within one minute testing. The meter itself, including the auxiliary parts, are all packed compactly in a single case so that it can easily be carried about with ease. An absolutely essential meter for people who are engaged in growing, selling, buying, inspection and storing of grains.

Specification of Grain Moisture Meter

Model	PB-1k, standard	Riceter, Pocket size
Measuring Range	10 - 20%	12 - 20%
Electric Power Source	Single-phase AC 80 - 110 V or desired	DC Dry cell 45 V × 2 pcs.
Accurate	0.3% or 0.5%	± 0.5%
Dimension in mm	160 × 210 × 280	140 × 60 × 70
Application	all kind of grains	Rice, Wheat & Barley
Net Weight	8.0 kg.	1.0 kg.
Gross Weight	6 sets in a case 80 kg.	10 sets in a case 25 kg.
Measurement	15 cft.	5 cft.

"CeCoCo" Grain Moisture Meter Model Riceter

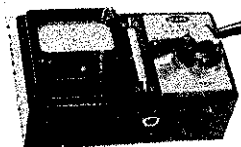



# "CECOCO" MANUALLY OPERATED RICE PROCESSING MACHINES



"CECOCO" FOOT THRESHER



"CECOCO" TWO-MAN HAND RICE HULLER



"CECOCO" HAND GRAIN WINNOWER

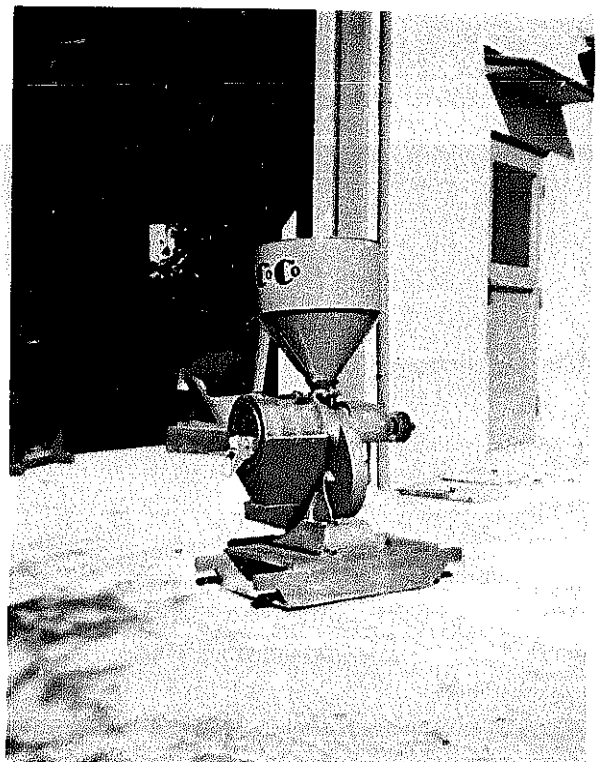

"CECOCO" SMALL POWER RICE POLISHER

# MANUALLY OPERATED RICE PROCESSING MACHINES

Adapted Not Only for Rice-Grower But Also for Cottage Industry in General

To-day great many natives work in shops and factories, and even farmers themselves, get their milled rice from hundreds and thousands miles away; and the rice that comes from such a distant place must be milled at certain few mills centered in the port of export so that it will be full of weevils before it reaches the consumers. In Japan many little rice mills operated in every neighborhood and no women had to walk more than a quarter of mile to get their day's supply. Of course, she get it fresh. An inferior and improper method of hulling and polishing rice is robbing you of a perfect rice turning into broken and crushed and most of them disappear as a mere powder with a perfect rice. Start to mill rice with "CeCoCo" Rice Processing Machines, and eat a fresh rice and increase your nourishment by eliminating the waste, and further utilize husk, bran and broken rice for feeding cattle in order to earn a petty cash by milling paddy rice for your neighbours.

## "CECOCO" FOOT THRESHER

(1) Operating Instruction and Result:

Eliminate mixing with mud, sand, stone, piece of metal and other foreign substance contained in paddy by adapting "CECOCO" Light and Handy Foot Thresher.

Spread a straw mat, burlaps or any fibre sheeting underneath the base of Thresher instead of setting it directly on the ground so that you can save the drudgery work of paddy separation from foreign substances after threshing.

Many of paddy rice imported into Japan are mixed with mud, sand and other foreign substances which is caused by threshing paddy directly on the ground even on cement-rendered floor by a primitive method. Thresh off paddy grains on the ear of rice-plant-stem by Foot Thresher by holding bundle of sheaves firmly by hands. It is conveniently used in the paddy-field where rice-plant was cut in saving time and labour to carry threshed paddy home as it can be carried around easy.

"CeCoCo" Light Handy, Portable Foot Thresher

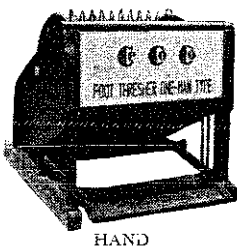

Specification of "CeCoCo" Foot Thresher

Code Word	Construction	Nos. of Operator	Capacity per hour in paddy	R.P.M. approx.	Dimension in mm			Net Weight	Gross Weight	Ship'g Meas't
					Height	Width	Length			
TAKRS	Iron Frame	1 man	115 kg	450	650	655	740	50 kg	90 kg	15 cft.

"CECOCO" GRAIN WINNOWER for cleaning Paddy, Hulled-Rice, Wheat, Barley and Other Grains & Seeds:

"CeCoCo" Winnower is useful to blow off the chaff, dust and other impurities from paddy rice when threshed. It can be operated at any time by even woman and young folks with output of 70 to 80 bushels per hour and hence can replace the old and primitive method which is depended on wind current. There are three outlets for (a) paddy (b) immature dead rice and husk; (c) chaff and dust. The construction is semi-steel made with well dried wood and can be used for years.

Before proceeding to next procedures, it is recommended to clean the paddy threshed, as explained in (1) to up-keep a smooth and speedy operation and also in preventing an accidental damage to Hulling Machine when they are hulled due to many foreign substances mixed with rough paddies.

(2) Operating Instruction and Result:

Feed rough paddy into Hopper of Winnower and operate Air-Blast-Fan by right hand and gradually open Air-Flow-Adjusting-Board set underneath of hopper of Winnower by left hand. Care should be taken to adjust eddies of passing air-flow so that grains should not be thrown away to-together with chaff and dust. Thus, you will obtain (a) cleaned paddy from (b) chaff, dust and (c) dead and immature rices.

"CeCoCo" Hand Grain Winnower



Specification of "CeCoCo" Hand Grain Winnower

Code Word	Type	Capacity per hour	Overall Dimension			Net Weight	Gross Weight	Ship'g Meas't
			Height	Width	Length			
FUKTK	A-1	650 kg	1090	470	820	25 kg	50 kg	11 cft.

## "CECOCO" TWO-MAN HAND HULLER

The construction of "CeCoCo" Small and Handy Huller is metal made sturdy. It is operated with revolution of 3,500 to 4,000 r.p.m. and paddy is instantly hulled regardless of size and shape without giving damage to grain. Output capacity of this machine is 800 to 1,000 lbs. per hour with 90 per cent of hulling. This particular huller is efficiently used also in hulling millet, buckwheat, ducan grass and hulled-peanut pearling.

"CeCoCo"  
Two-man Hand-  
Operated Huller

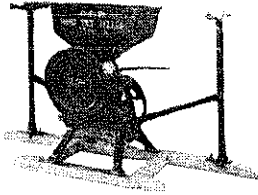

### (3) Operation and Result:

At first, close up Paddy Adjusting Plate and feed the cleaned paddy in Hopper, and at the time when the rubber cushion ring is accelerated at 3,500 to 4,000 r.p.m., by pulling and pushing the Operating Handle back and forth vigorously by hand and open Feeding Plate little by little and finally up to a full extent and continuing operation more vigorously.

Thus, hulled rice together with still unhulled rice comes out from the outlet on front side. It is strongly recommended to clean the rough paddy in advance using Winnower before hulling, because when paddy is mixed with dust and dirt it will retard hulling efficiency and shortens the life of rubber cushion.

Specification of "CeCoCo" Hand Huller

Code Word	TYPE	Capacity per hour in paddy	Dimension in mm			R.P.M. of Gear	Hulling Efficiency	Net Weight	Gross Weight	Ship'g Meas't
			Height	Width	Length					
AKIYA	A	250 kg	900	585	1715	50 - 60	90 - 97%	60 kg	100 kg	17 cft.

### "CECOCO" PADDY SEPARATOR

No Rice Huller can hull every paddy completely by one operation due to its different size and shape and also degree of maturity of grain and any attempt to hull all of paddies will result in an excessive breakage. "CeCoCo" Paddy Separator, by simple and easy hand operation, separates the hulled rice from unhulled one by its ingenious devise. It is very simple in construction and design and is durable being made of well dried hard wood and can be dismantled and folded down for storing. Wire screens of different sizes are furnished to meet suitable sizes of paddies. It will separate paddies about 70 bushels per hour and grade brown rice.

In order to ascertain proper size of screen, sample of your paddy and brown or cleaned rice should be sent to "CeCoCo" or advise shape and size.

(4) Operating Instruction and Result: This Separator is also recommended in grading polished rice.

When the mixture of hulled and unhulled paddies are fed into the hopper of Separator they will glide down along the surface of multistaged inclined wire screen and separates them into four kinds (a) completely cleaned hulled rice, (b) unhulled-rice, (c) unripened-and-imperfect-rices and (d) broken one with mud-sand-dust in four groups in all. It is also used for assorting the polished rice for grading.

"CeCoCo" Paddy Separator

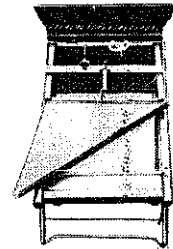

Specification of "CeCoCo" Grain Separator

Code Word	Type	Capacity per hour	Working Width	Dimension in mm			Net Weight	Gross Weight	Ship'g Meas't
				Height	Width	Length			
FKZAB	14	600 kg	330mm	850	510	965	17 kg	30 kg	6' - 6"
FKZCD	16	720 kg	395mm	850	578	965	19 kg	33 kg	7' - 3"
FKZEF	18	840 kg	450mm	850	630	965	21 kg	36 kg	7' - 7"
FKZGH	20	960 kg	510mm	850	690	965	23 kg	40 kg	8' - 2"

### "CECOCO" HANDY RICE POLISHER

(5) Operating Instruction and Result:

Speciality of this machine is that it can be operated by man power to polish the rice with capacity of about 10-15 kg. per hour producing a white clean polished rice but no broken rice whatever. Repeat the polishing when it is not enough white until you are satisfied. In case it you are too tired for polishing rice the machine is so made that it can easily and instantly be started polishing again at its original stage of processing even after resting for some time.

Specification of "CECOCO" Handy Rice Polisher

Code Word	Type	Capacity per hour	Req'd Power	R.P.M.	Dimension			Net Weight	Gross Weight	Ship'g Meas't
					Height	Width	Length			
HODEN	E	10-15kg	Hand	Proper	745	450	595	22 kg	40 kg	10'-0"

"CeCoCo" Handy Rice Polisher

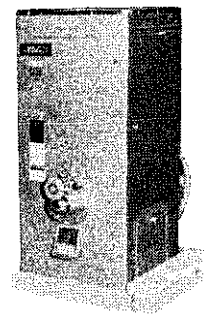

# POWERED RICE THRESHING, CLEANING, SEPARATING, SHELLING AND POLISHING

## "CECOCO" PORTABLE THRESHER for short-cut-stems with grain ears

The problem of threshing rice and wheat is a constant source of worry to the agriculturists in the rice and wheat areas of the world. With this in view, "CeCoCo" has developed a unique designed, handy, light-weight, portable and economical thresher suitable for small scale rice and wheat growers.

The price of the machine is very low. Construction is all metal throughout and durable. Efficiency is high giving no grain broken, because it is developed and accomplished with success after many years of tiresome experiences in the fields.

"CeCoCo" Portable Thresher with 1.2HP Gasoline Engine

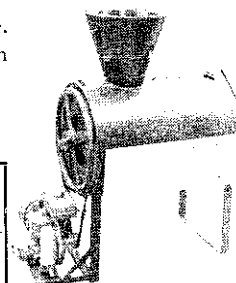

Specification of "CeCoCo" Portable Thresher

Type	Power Req'd	Revolution of Main-shaft	Capacity in paddy Per hour	Dimension in mm			Net Weight	Gross Weight	Ship'g Meas't
				Height	Width	Length			
PT	1.5HP	570 - 760 R.P.M.	180 kg	825	582	840	58 kg.	90 kg.	13 cft.

Equipped with Air-cooled gasoline Engine in unit.

## "CECOCO" SELF-FEEDING POWER THRESHER

The "CeCoCo" Self-Feed Thresher is made for the purpose of threshing rice and wheat which is reaped full stalks and gathered in orderly bound in sheaves. The old method of threshing is done by stamping on with the feet of farm animals or by striking with flails at the disadvantages of bad efficiency, taking a longer time and more labor, very often mixing the paddy grains with sand, stone, mud, grass seed, dirt or any other foreign substances which should be eliminated before proceeding to the next hulling stage. Save such troubles by adapting "CeCoCo" Self-Feed Power Thresher.

"CeCoCo" Self-feed Thresher

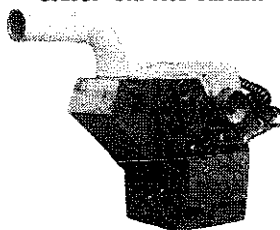

Paddy stalks to be threshed are placed on Feed Table attached to the left end of the machine, and be inserted continuously by small quantities by hands into the feeding end of the rotating Chain as to the method of insertion, the stems with ears must first be taken into Threshing Chamber and then make the chain grip the lower part of stems. Inserted stems are carried to the right being tightly gripped between Stalk Push Bars and are guided through the machine by Straw Guide Pipe.

Inserted paddy straws are threshed while being shifted by the moving Chain under the rotating Threshing Drum. When threshed paddy passed screen, dust or other foreign mixtures are separated by fanning, and only the completely threshed paddy is carried through first Screw Conveyor over to Thrower and discharged outward through Finished Paddy Outlet.

Specification of "CeCoCo" Self-Feed Power Thresher

Type	Capacity in paddy/hour	Power Req'd	R.P.M.		Dimension in mm			Net Weight	Gross Weight	Ship'g Meas't
			Rice	Wheat	Height	Width	Length			
No. 1	500-1,000 kg.	3-4 HP	570	670	1380	1010	1350	150 kg.	295 kg.	60 cft.
No. 2	400- 800 kg.	3-4 HP	570	670	1380	922	1350	115 kg.	255 kg.	57 cft.
No. 3	300- 600 kg.	2-3 HP	570	670	1374	842	1350	90 kg.	220 kg.	54 cft.

## "CECOCO" POWER THRESHER for long or short-cut stems

There are many places in vast areas over the world, where farmers have their traditional methods of harvesting rice, wheat or barley, that is, cropping short stem with ears on upper part of the rice plant by hand knife, when the rice is ripened, depending solely upon the uncertainty of fine weather.

The "CeCoCo" Power Thresher is especially made and intentionally designed for threshing the Paddy, no matter how the stalk was cut long or short in stems.

"CeCoCo" Power Thresher  
Type No. 1 Double Drum  
All Metal Construction



"CeCoCo" Power Thresher  
Type Nos. 2, 3 & 4, Single Drum  
Semi-steel made

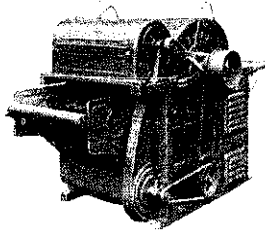

"CeCoCo" Power Thresher  
Type No.2 attached with  
gasoline engine

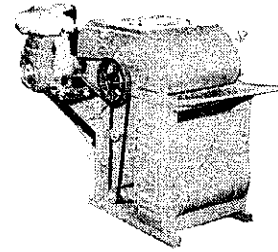

How to operate: Feed the crops by hand into the threshing chamber and a perfectly cleaned grain will come out from the outlet of side of conveyor-elevator after being completely threshed. The machine is specially designed after the western type thresher being modified and constructed with throughout and equipped with winnower, conveyor, thrower and speed adjuster which controls the air velocity to prevent the over flow of grain but blows out straw, chaffs and dusts far away.

Specification of "CeCoCo" Power Thresher

Type	Capacity in paddy/hour	Power Req'd	R.P.M.		Dimension in mm			Net Weight	Gross Weight	Ship'g Meas't
			Rice	Wheat	Height	Width	Length			
No. 1	300-1000 kg.	3-5 HP	720	750	1046	1070	1287	144 kg.	260 kg.	60 cft.
No. 2	approx.350kg.	1/2-2HP	530	630	1090	875	1370	80 kg.	115 kg.	35 cft.
No. 3	approx.450kg.	1/2-2HP	530	630	1090	950	1370	95 kg.	130 kg.	38 cft.
No. 4	approx.500kg.	1-2 HP	530	630	1090	1000	1370	100 kg.	140 kg.	40 cft.

"CECOCO" PADDY CLEANER

"CeCoCo" Paddy Cleaner

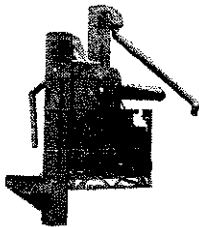

In order to save troubles in separating paddy from dust, mud, sand, grit and other foreign matters and also for cleaning paddy by getting-rid-off chaff and dust, "CeCoCo" Paddy Cleaner is used very efficiently. Uncleaned paddy when supplied for rice hulling, gives damage to machine by clogging and hinders a smooth operation and shortens the life of rubber rolls of rice huller. This paddy cleaner is luxuriously provided with two elevators, one for intake of rough paddy and the other for turnout of pure, cleaned paddy and can also be combined with "CeCoCo" Rice Huller Model Automatic KL-A for operational or layout requirements. The interchangeable triplex screens, upper, middle and lower, are easily replaced when the screen is worn out or when a screen of different mesh is necessary.

Specification of "CeCoCo" Paddy Cleaner

Type	Capacity per hour	Power Req'd	R.P.M.	Dimension in mm			Net Weight	Gross Weight	Ship'g Meas't
				Height	Width	Length			
No. 1	1,400-1,800 kgs.	2-3 HP	550	2547	1282	2251	453 kg.	648 kg.	120 cft.
No. 2	750-1,100 kgs.	1-2 HP	550	2536	946	2097	276 kg.	500 kg.	90 cft.

"CECOCO" PADDY CLEANER (POWER WINNOWER)

To eliminate 40% of incomplete paddies, 40% of complete paddies will diverge in a conventional hand winnower. By this machine, only 0.4% will go astray. After making a proper adjustment, even women or young folks can continuously do a uniform assorting of paddies with ease and as efficiency is so admirable that few complete paddies will come out to the 2nd outlet as immature paddies. The 3rd outlet can revolve every 45° and is turnable to the outdoors preventing the dusts and chaff, and the operation can be performed in a most sanitary condition. Pieces of sand, mud, stone and grit even small in size than paddies are completely passing through the screen.

"CeCoCo" Power Winnower

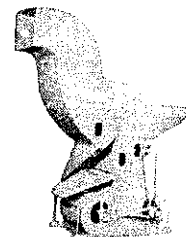

Specification :- Dimension ..... 1800 mm H x 610 mm W x 1100 mm L  
 Floor Space ..... 520 mm x 1000 mm ; Power Required ..... 1/4 HP ;  
 Revolution ..... 1,000 - 1,200 R.P.M. Capacity ..... 600 - 700 kgs. per hour  
 Net Weight ..... 66 kgs. Gross Weight ..... 120 kgs.  
 Ship'g Meas't ..... 50 cft.

## "CECOCO" GRAIN & SEED CLEANER

Construction of the machine is very rigid and dependable and will separate grains and seeds from mud, stone, sand, chaff, dirt, grit and other foreign substances by means of oscillating screens device and efficient winnower with fan. At the first time, winnower will separate rather light-weight substances such as dust, chaff, etc, and at the second stage, an eccentric oscillation of Sifting Device will separate the heavy materials such as stone, sand, mud, grit, small metal and other foreign matters. In addition to rice, wheat and other grains, the seeds can also be cleaned admirably by changing the screens suitable to the size of objectives. Extra screens are furnished at extra cost upon receipt of such samples of your grain or seed. Write to "CeCoCo" for additional information.

## START RUBBER ROLL HULLING RICE AND FEEL THE DIFFERENCE

After using our "CeCoCo" Rubber Roll Rice Huller, you will notice the volume of output of your shelled rice to be increased at least 15 to 20 per cent more than you are now processing by your own huller. More output means more profit for your income of your rice mill industry. An inferior and improper method of hulling rice is rubbing you of perfect rice turning it into broken and crushed rice, most of them disappearing as mere rice powder and brans being. From today you can start using "CeCoCo" Rubber Roll Rice Huller in increasing the quantity of your rice and protect your profit from waste and rubbing.

To our knowledge, we understand that in processing the rice, most of the mills adapt the steel rolls and do not care for the rice broken because the same can also be cooked as usual. However, our Rubber Roll Rice Huller which is made under the unique principle and construction from those made in other countries, can eliminate such broken rice and increase the output recovery by 15 to 20 per cent more in volume when finished by polishing, because it will give no damage to the grains. "CeCoCo" Rice Polishing Machine will check the broken rice and also crushed and becoming-powdered-rice mixed to be with the rice bran. When the paddy is hulled by the steel huller the percentage of broken rice will be very great and the crushed and powdered rice will dissappear entirely since same is changing the appearance as the intimate-rice-bran. To this important saving, most of mill people is ignorant, and it is evident that cost of our machine and parts will be reimbursed within two or three months easily. Since such difference in the final output capacity of volume, should not be neglected from the standpoint of the valuable national resources to be reserved, we believe it is well worthwhile for you to investigate thoroughly. The fact is appreciatively proved. Because the rice millers in the United State of America have fully recognized the merit of Japanese Rubber Roll Huller and demand is increasing day by day.

## ADVANTAGE OF RUBBER ROLL FOR RICE HULLER

By adapting "CeCoCo" Rubber Hulling Machine, the hard and coarse outer husk of paddy is instantly removed, giving no bruise, crack and breakage, preventing hulled brown rice from noxious insects so that it can be stored for a long time without fear of deterioration by the friction caused by different rotations of two rubber rolls at the point where paddy reaches to the contacting point. High revolving elastic friction rubber rolls move paddies rapidly without bruising them but squeeze the hulled or brown rices out from the husks. Consequently the output recovery of hulled rice increases 15 to 20 per cent, and if "CeCoCo" Rubber Roll Rice Huller is adapted in milling rice, a prodigious, almost legendary amount of polished rice will eventually be saved.

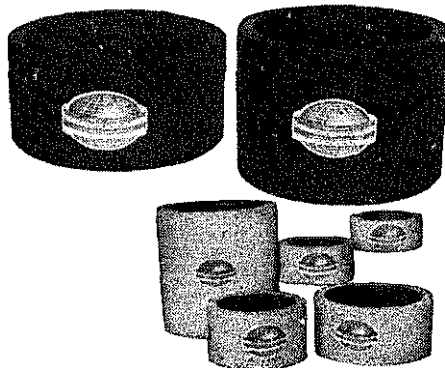
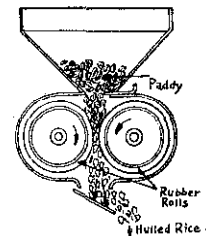

"CeCoCo" Rubber Rolls, Insert Steel type lined  
with thin iron plate  
Upper-black colour  
Lower-white colour

It is strongly recommended to store the brown rice hulled by rubber roll instead of "polished and white" to insure it from deterioration regardless of climate and season especially for export, as brown rice will give better taste when polished at the destination and will be accepted with a good reputation. Transportation of hulled brown rice will save a shipping space about three-quarter to four-fifths over paddy.

It comprises a rubber cylinder lined up with a thin iron plate bearing numbers of perforations. The rubber projections when squeezed into those perforations set in position tightly catching lining plate so as not to get loose and deviate during the operation.

Five sizes either in black or creamish white color are obtained with the track width varying from the gigantic 10-inches to the minimum 2 $\frac{1}{2}$ -inches according to the capacities and types of huller required.

Specification of Rubber Roll, Insert Steel type lined with thin iron plate

Size	Diameter		Track Width	Suitable Type of Rice Huller	Durability per a pair	Net Weight	Contents in a case	Ship'g Meas't
	Outside	Inside						
10"	10"	8"	10"	No. 10	150-250 tons	7.5 kg	16 pcs.	14 cft
6"	8 <sup>3</sup> / <sub>4</sub> "	7 <sup>1</sup> / <sub>4</sub> "	6"	No. 1	60-100 tons	2.9 kg	30 pcs.	12 cft
4"	8 <sup>3</sup> / <sub>4</sub> "	7 <sup>1</sup> / <sub>4</sub> "	4"	No. 2	40- 60 tons	1.9 kg	30 pcs.	9 cft
3"	6 <sup>1</sup> / <sub>16</sub> "	4 <sup>9</sup> / <sub>16</sub> "	3"	No. 3	25- 40 tons	1.0 kg	50 pcs.	6 cft
2 <sup>1</sup> / <sub>2</sub> "	6 <sup>1</sup> / <sub>16</sub> "	4 <sup>9</sup> / <sub>16</sub> "	2 <sup>1</sup> / <sub>2</sub> "	No. 25	20- 30 tons	0.8 kg	50 pcs.	5 cft

In order to save the shipping charge, ocean freight and other unnecessary expenses, the shipment should be executed together with the machine ordered with the extra spare rubber rolls so that you may not lose valuable time in hulling when worn out and save expense and time in transit for waiting for new arrival.

PATENTED "HI-F" PRESSED STEEL DRUM TYPE RUBBER ROLL FOR RICE HULLER

This is pressed steel-drum-type rubber roll with a highest precision and eliminates the trouble of inserting the drum unlike the conventional insert-type-roll and the weight is lighter than the cast-iron-drum-type-roll but cost is cheaper.

Specialities comparing with insert type rubber roll :

1. Durability is increased 20 per cent.
2. Even if used to the last, it will never produce broken rice.
3. The trouble of inserting the drum is eliminated and replacement became easy. (shown in pic. 2)
4. Like the cast iron drum type. the both sides of roll are polished which ensures no "side-shaking" of roll. The precision is admirable due to the special press method and the quality is uniform.

Speciality comparing with cast iron drum type rubber roll :

The weight is lighter than cast iron made drum type roll and handy for carrying and causes less burden to the revolving parts which increase the durability.

Pictures for explaining the differences :

- 1 and 3—Patented New 'Hi-F' pressed steel drum type rubber roll.
- 2—Conventional cast iron made drum type rubber roll.
- 4—Showing that the drum of rice huller is being inserted into the conventional insert type rubber roll.

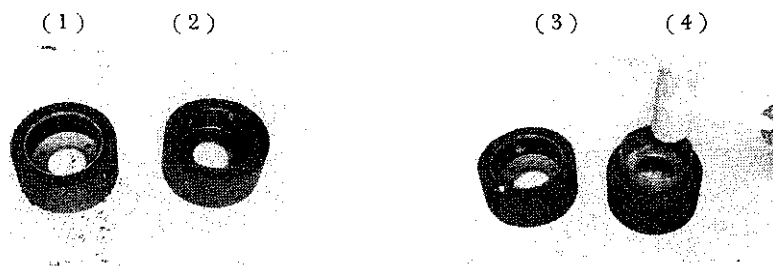

Specification of Rubber Roll, Drum type with Pressed steel Iron Rim

Size	Diameter		Track Width	Suitable Type of Rice Huller	Durability per a pair	Net Weight	Contents in a case	Ship'g Meas't
	Outside	Inside						
6"	8 <sup>3</sup> / <sub>4</sub> "	7 <sup>1</sup> / <sub>4</sub> "	6"	No. 1	60-100 tons	4 kg	30 pcs.	12 cft
4"	8 <sup>3</sup> / <sub>4</sub> "	7 <sup>1</sup> / <sub>4</sub> "	4"	No. 2	40- 60 tons	2.5 kg	30 pcs.	9 cft
3"	6 <sup>1</sup> / <sub>16</sub> "	4 <sup>1</sup> / <sub>16</sub> "	9"	No. 3	25- 40 tons	1.5 kg	50 pcs.	6 cft
2 <sup>1</sup> / <sub>2</sub> "	6 <sup>1</sup> / <sub>16</sub> "	4 <sup>1</sup> / <sub>16</sub> "	2 <sup>1</sup> / <sub>2</sub> "	No. 25	20- 30 tons	1.0 kg	50 pcs.	5 cft

In order to save the shipping charge ocean freight and other unnecessary expenses, the shipment should be executed together with the machine ordered with the extra spare rubber rolls so that you may not lose valuable time in hulling when worn out and save expense and time in transit for waiting for new arrival a long time in transit.

"CeCoCo" Rice Huller Model 'Original'

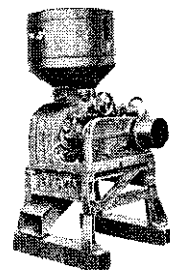

"CECOCO" RUBBER ROLL RICE HULLER

- 1) Model "ORIGINAL" is the fundamental unit of all our rice huller models, consisting of "Rubber Roll" Hulling head and the installation bed. The paddy selected and cleaned by paddy cleaner is processed by this huller, and a mixed mass of brown rice, some of paddy and husks come out which should be separated from each other by the separator. The standard hulling rate varies from 85 to 95 per cent of the brown rice according to the conditions of the paddy hulled keeping the breakage down to its minimum percentage.

Specification of Rice Huller, Model "Original"

Type	Size	Hourly Capacity in paddy	Power Req'd	R.P.M.	Dimension in mm			Net Weight	Gross Weight	Ship'g Meas't
					Height	Width	Length			
No. 1	6"	1,200-2,000 kg	4-5HP	1050	1105	666	720	115 kg	160 kg	12 cft
No. 1M	6"	- ditto -	V-belt drive		1300	666	720	160 kg	200 kg	15 cft
No. 2	4"	800-1,400 kg	3-4HP	1050	1105	666	695	100 kg	120 kg	10 cft
No. 2M	4"	- ditto -	V-belt drive		1300	666	695	150 kg	180 kg	11 cft
No. 3	3"	500- 800 kg	1-2HP	1150	745	598	549	70 kg	100 kg	8 cft
No.10	10"	3,000-4,000 kg	7½-10	920	1368	780	898	300 kg	405 kg	30 cft
No.10M	10"	- ditto -	V-belt drive		1513	780	898	345 kg	465 kg	32 cft

2) Model "COMBINATION" is one of the series of our rice huller models consisting of "Rubber Roll" Hulling Head and Husk Winnower.

"CeCoCo"  
Model "Combination"  
with Suction Husk  
Exhauster Nos. 1S, 2S and 3S

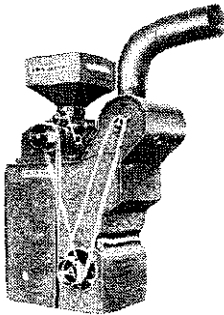

"CeCoCo" Rice Huller with Husk Winnower has two combination models, one with the suction husk-exhauster and the other without it. The ordinary model is equipped with a large husk outlet opening for ejecting husks and dust into the open space outside, therefore rather suitable for the operation outside a building. The suction exhauster model is equipped with a suction-husk-exhauster which can lift air current by dint of suction fan and deliver husk through piping in whatever direction required. Therefore, the suction-exhauster model is the most ideal for the operation inside a building and gives a lot of conveniences to the operator with regard to proper disposition of the husks and a hygienic work in operation. The function of Husk Winnower is to eliminate and separate husk and other impurities from the brown rice (hulled rice) and paddy, and still unhulled also to separate dead or unripe paddies from the selected and cleaned brown rice and paddy.

"CeCoCo"  
Model "Combination"  
Open outlet  
Type Nos. 1, 2 & 3

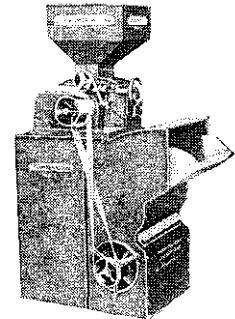

Specification of "CeCoCo" Rice Huller, Model "Combination"

Type	Size	Hourly Capacity in paddy	Power Req'd	R.P.M.	Dimension in mm			Net Weight	Gross Weight	Ship'g Meas't
					Height	Width	Length			
No. 1	6"	1,200-20,00 kg	4-5 HP	1050	1690	740	1076	188 kg	318 kg	40 cft
No. 1S		with Suction-husk-exhauster			1700	740	1081	215 kg	375 kg	50 cft
No. 2	4"	800-1,400 kg	3-4 HP	1050	1690	683	1076	173 kg	290 kg	35 cft
No. 2S		with Suction-husk-exhauster			1700	683	1081	203 kg	345 kg	43 cft
No. 3	3"	500- 800 kg	2-3 HP	1150	1400	540	1076	90 kg	170 kg	34 cft
No. 3S		with Suction-husk-exhauster			1670	540	1081	115 kg	235 kg	40 cft

3) Model AUTOMATIC "KL-A" is a fully automatic, self-contained unit, exclusive to "CeCoCo". The whole unit is disassembled into separate compartments as follow :

a) Hulling Head — Two rubber rolls of different rotations (approx. 10 to 7 in ratio) are set with a slight clearance in between them. When passing through this clearance, paddy is given a gentle twisting action thereby husk is stripped off. (Processing stage by Model "Original")

b) Winnower — By means of fans, Winnower separates husks and unripe paddy from the mixture of hulled brown rice and paddy after they are hulled. (Processing stage by Model "Combination")

c) Double Elevator — One section of this elevator conveys paddy to Hulling Head and the other section conveys mixture of bulk of paddy and brown rice to Auto-Separator.

d) Auto-Separator — By means of 6 or 10 pieces of separating screens which are oscillating side-ways, separates brown rice and paddy to turn out only pure brown rice. Variety in size, shape and weight practically makes no difference in this amazingly efficient Auto-separator that has been disposed on market first time by the "CeCoCo" utilizing slight differences between rice and paddy in the smoothness and specific gravity. Adaptation of Auto-separator will no longer have to classify or grade the paddy and the hulling operation is simple and easy.

e) Rice Elevator — This elevator conveys out the separated pure brown rice into container or rice polisher.

"CeCoCo"  
Model Automatic  
"KL-A"

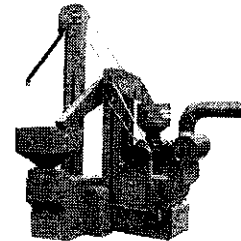



Specification of "CeCoCo" Rice Huller, Model Automatic "KL-A"

Type	Size	Hourly Capacity in paddy	Power Req'd	R.P.M.	Dimension in mm			Net Weight	Gross Weight	Ship'g Meas't
					Height	Width	Length			
No. 1	6"	1,000-1,200 kg	5-6 HP	1050	3322	2226	2412	594 kg	994 kg	170 cft
No. 2	4"	600- 700 kg	4-5 HP	1050	3022	2216	2412	523 kg	910 kg	155 cft

- 4) Model AUTOMATIC "AM" and "ME" are a miniaturized compact unit to turn paddy into brown rice, including all the necessary sections- hulling, winnowing, separating in one-body construction. This automatic huller is virtually intended to be used in every farming household or group of farmers where rice is cultivated.

Specification of "CeCoCo" Rice Huller, Model Automatic "AM"

Type	No. 3	No. 25
Size	3"	2 1/2"
Hourly Capacity	350-500 kg	300-400 kg
Power Required	2-3 HP	1-2 HP
Revolution	1,200 rpm	1,200 rpm
Overall Height	1,155 mm	1,155 mm
Overall Width	677 mm	603 mm
Overall Length	1,200 mm	1,200 mm
Net Weight	140 kg	120 kg
Gross Weight	275 kg	227 kg
Ship'g Meas't	48 cft	43 cft

"CeCoCo" Rice Huller Model Automatic "AM"

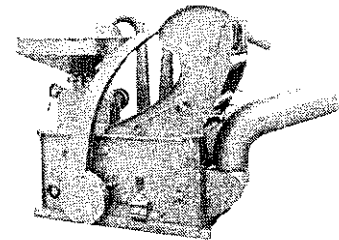

Specification of "CeCoCo" Rice Huller Model Automatic "ME"

Type No.	25	30	40
Size of Roll	2 1/2"	3"	4"
Hourly Capacity	10-24 bush.	20-30 bush.	30-40 bush.
Power Required	1/2-1 HP	1 HP	1-2 HP
Revolution	1,200 rpm	1,200 rpm	1,200 rpm
Overall Height	1,160 mm	1,160 mm	1,160 mm
Overall Width	310 mm	380 mm	460 mm
Overall Length	850 mm	850 mm	850 mm
Net Weight	93 kg	98 kg	112 kg
Gross Weight	160 kg	180 kg	220 kg
Ship'g Meas't	30 cft	35 cft	40 cft

"CeCoCo" Rice Huller Model Automatic "ME"

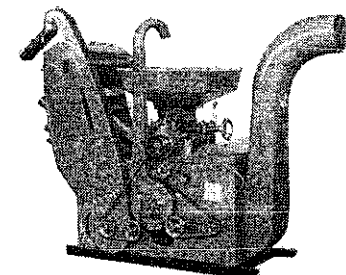

REMARKS: Capacity of hulling varies according to variety, nature, shape, size, degree of dryness, condition of climate and weather, skill of operation. Strongly recommended for small farmers.

NEWEST "CECOCO" RUBBER ROLL RICE HULLER

- 5) Model ORIGINAL NOR-10:—This model NOR-10 has, as optional equipment, the pneumatic roll controlling system with control panel that works completely automatically. In the pneumatic control instead of the standard spring control, the rubber rolls are kept closed by the constant pressure whenever the paddy is passing through between rubber rolls and are opened up automatically the moment the flow of paddy is suspended. This pneumatic roll control diminishes laboring time and damage on rice, and augments hulling rate and durability of rubber rolls. Naturally enough, when any foreign substance bigger than the grain, the rubber rolls automatically withdraw so as to allow it to pass through not giving any damage to the rolls and relative parts.

This unit is available in four different types according to (1) Spring roll control or pneumatic roll control and (2) V-belt motor drive or flat-belt line shaft drive.

- 6) Model COMBINATION HW-6:—The Hull Winnower of this model HW-6 has a very unique construction enabling the whole size to be compact and handy. Unlike the ordinary aspirator, in which a booster fan must be installed either inside or outside of the machine for blowing hulls to a separate chamber this Hull Winnower has the suction-blower fan that performs both as an aspirating fan and blower fan, making it highly convenient similar capacity, this combination huller makes a handy rice mill which can easily be available to any rice miller or private user.

7) Model COMBINATION 'HC' and 'NC':—This model has the 'CLOSE-CIRCUIT' Hull Winnower is completely designed to be most suitably combined with the hulling head (Rice Huller). In this special winnower the winnowing air circulates inside the closed air circuit, made of a particular cyclone fan, winnowing chamber and settling chamber. The hulls separated from grains are carried over with air current chamber where they are dumped off the current by natural fall into the hull screw conveyor to be carried out of the machine through the hull outlet provided with the air-lock valve. The hulls thus taken out of the machine can be conveyed to whatever distance required by means of outside booster fan or similar equipment such as belt conveyor or elevator. Because of this particular mechanism, there hardly occurs any wearing inside the fan and air channel. Few wearable parts are protected with replaceable steel to guarantee long durability of the machine. The model NC-10 has pneumatic roll controlling system with control panel is optionally available as special attachment instead of standard spring control system.

"CeCoCo" Combination Rice Huller Model NC-10 with Pneumatic Roll Adjustment

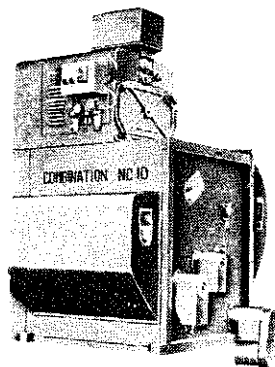

and settling chamber. The hulls separated from grains are carried over with air current chamber where they are dumped off the current by natural fall into the hull screw conveyor to be carried out of the machine through the hull outlet provided with the air-lock valve. The hulls thus taken out of the machine can be conveyed to whatever distance required by means of outside booster fan or similar equipment such as belt conveyor or elevator. Because of this particular mechanism, there hardly occurs any wearing inside the fan and air channel. Few wearable parts are protected with replaceable steel to guarantee long durability of the machine. The model NC-10 has pneumatic roll controlling system with control panel is optionally available as special attachment instead of standard spring control system.

Diagram

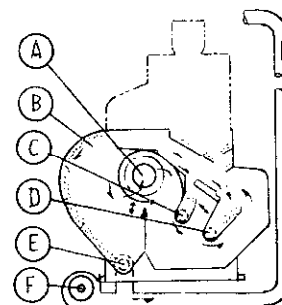

- A) Cyclone Fan
- B) Settling Chamber
- C) Immature Paddy Outlet
- D) Whole Grain Outlet
- E) Hull Outlet with Air-lock valve
- F) Booster Fan

Specification of Newest "CeCoCo" Rubber Roll Rice Huller

Model	Hourly Capacity in paddy	H. P. Req'd	Size	R.P.M.	Dimension in mm			Export Packing		
					Height	Width	Length	N.W.	G.W.	Meas't
NOR10	3,000-4,000kg	7½-10	10"	920	1455	824	813	430kg	540kg	50cft
HW6	1,200-2,000kg	4 - 5	6"	1,050	1320	770	1220	140kg	290kg	35cft
HC-10	3,000-4,000kg	7½-10	10"	920	2018	1352	1555	325kg	585kg	120cft
HC- 6	1,200-2,000kg	5 - 6	6"	1,050	1930	1158	1555	300kg	500kg	100cft
NC-10	3,000-4,000kg	7½-10	10"	920	1995	1555	1352	500kg	800kg	140cft

### "CECOCO" AUTOMATIC CIRCULATING RICE POLISHER

Speciality : No Rice Broken During Processing.

"CeCoCo" Auto. Circulating Rice Polisher

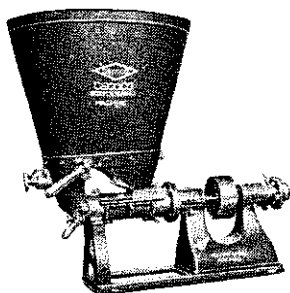

For a home use and a small household cottage industry, this small and compact rice polishing machine is appropriately recommended and will solve the problem of rice polishing which takes time and hand pounding drudgery work. When the brown rice is fed into hopper and the operation is started, and the upper part of rice is gradually slides down into the cylinder by means of the screw conveyor set in bottom toward the resisting plate, whereby it is polished by being rubbed each other, and the rice bran is shifted out through the wire netting and rubbed rice is pushed up-ward against the inner wall of the hopper stimulating the further polishing. By repeating such circulating action during operation, the rice is automatically and perfectly polished. As you can observe the progress of polishing very easily you can adjust the degree of the whiteness of polished rice during operation, and it is to ascertain the rice to be whole-polished or half polished as to your wishes. It is absolutely guaranteed that the polished rice retains its original shape and produces no broken rice whatever. It is made of metal throughout, simple in construction and is very easy in handling.

Specification of "CeCoCo" Automatic Circulating Rice Polisher

Type	Hopper Capacity	Efficiency per hour	Power Req'd	R.P.M.	Dimension in mm			Net Weight	Gross Weight	Ship'g Meas't
					Height	Width	Length			
NB60	60 kg	90 kg	1 HP	750-850	915	546	850	55 kg	110 kg	25 cft
		140 kg	2 HP							
NB30	30 kg	45 kg	½ HP	750-850	820	457	635	40 kg	80 kg	20 cft
		70 kg	1 HP							
NB15	15 kg	22 kg	¼ HP	750-850	710	394	457	25 kg	60 kg	18 cft
		35 kg	½ HP							

## “CECOCO” AUTO-CIRCULATING PADDY POLISHER

This is newly invented Automatic Circulating Paddy Rice Polishing Machine and the speciality of this machine is to hull the paddy without using of hulling machine. Paddy fed into the hopper gradually slides down into Polishing Chamber and carried by a screw conveyor toward the resistant plate and automatically hulled and polished by means of rubbing action of each other. The paddy begins to be hulled and polished pushed on along the sides of hopper in upward direction and again slide into the polishing chamber, meanwhile the husks and brans sifted out through the screen. Repeat such actions automatically until the paddy rice is completely polished.

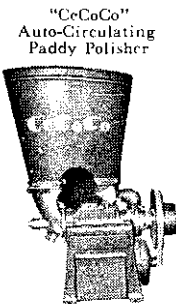

Specification of “CeCoCo” Auto-Circulating Paddy Polisher

Type	Hopper Capacity	Efficiency Paddy rice	Per hour Brown Rice	Power Req'd	R.P.M.	Dimension in mm			Net Weight	Gross Weight	Ship'g Meas't
						Height	Width	Length			
3-FR	1 bushel	45 kg	60-90 kg	1/2 HP	600-800	930	546	635	40 kg	65 kg	18 cft
		70-90 kg	120-180 kg	1 HP	1,000-1,500						
4-FR	2 bushel	140-180 kg	240-360 kg	2 HP	1,000-1,500	1200	200	900	70 kg	110 kg	35 cft

## “CECOCO” ABRASIVE ROLL (EMERY ROLL) RICE POLISHER

The production of better quality of white cooking rice and economy of rice processing definitely depend upon the treatment of hulled brown rice. The milling process for the treatment of rice is universally known as polishing or whitening.

Before modern polishing methods have been introduced, people have been long familiarised with an old-fashioned single-stage-method that means a simultaneous operation of hulling and polishing, wherein a rough abrading action has milled both husks and bran, layer out of rice kernel.

Nowadays it has become established practice for overwhelming majority of rice millers over the world adopt the double-stage milling method, viz., the paddy is hulled to brown rice first and in the second stage the brown rice is polished and pearled into white rice.

The white rice when polished is further processed to remove the bran and any fine particles adhering to the grain for the purpose in obtaining the thoroughly clean white rice with a glossy appearance for attaining the market value increased. There are two kinds of the Abrasive Roll Rice Polisher, i.e. Vertical Type and Horizontal Type.

“CeCoCo” Vertical Cone type Abrasive Roll Rice Polisher with Bran Cyclone  
Type No. 05                                  Type VP-3

“CeCoCo” Horizontal Abrasive Roll Rice Polisher  
Type RK-15                                  Type F

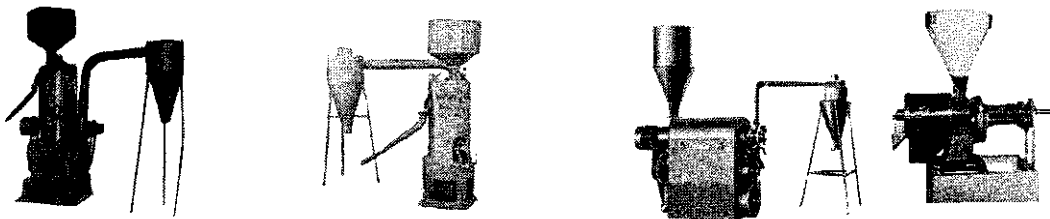

Specification of “CeCoCo” Abrasive Roll Rice Polisher

Type		Hourly Capacity in brown rice	Power Req'd	R.P.M.	Dimension in mm			Net Weight	Gross Weight	Ship'g Meas't
					Height	Width	Length			
*Vertical Cone Type	No. 10	800-1,000 kg	15-16	750	2287	1270	840	805 kg	980 kg	65 cft
	No. 5	500-600 kg	7 1/2 - 8	1000	2115	950	670	350 kg	450 kg	40 cft
	VP-3	250-300 kg	3-5 HP	1400	1480	510	490	130 kg	225 kg	25 cft
*Horizontal Type	RK15	approx. 2,000 kg	20 HP	1100	2135	615	1630	650 kg	850 kg	90 cft
	SD	approx. 1,000 kg	10 HP	1100	2000	1100	1000	350 kg	520 kg	80 cft
	SE	approx. 600 kg	7.5 HP	1200	2000	550	915	200 kg	280 kg	35 cft
	E	approx. 300 kg	5 HP	1300	1730	460	810	140 kg	200 kg	25 cft
	F	approx. 200 kg	3HP	1500	1240	450	950	90 kg	130 kg	20 cft
	D	approx. 150 kg	2 HP	2100	960	420	775	55 kg	80 kg	10 cft

### "CECOCO" STEEL CYLINDER TYPE RICE POLISHER

The Steel Cylinder Type Rice Polisher is a marvelously efficient rice polishing machine based on the unique design and superb quality backed by more than three decades of specialized devotion to rice polisher manufacturing. can produce perfect white rice in its natural brilliance accompanied with high total yield and minimum milling damage to rice kernel because of its perfect bran eliminating and rice cooling system for the whole polishing and pearling process fully conducted amidst strong blast air inside the polishing chamber. **SPECIAL FEATURES:**

- 1 The constant air injection into the polishing chamber during the whole process guarantees the total elimination of bran and at the same time maintains the rice at low temperature avoiding possible broken rice upkeeping a fine taste.
- 2 Paddy can also be hulled in this polisher, therefore the possibility that the paddy may appear with white rice is completely eliminated.
- 3 The durability of consumptive parts is greatly high. The polishing screen is given a special treatment and the cylinder is made of extra-hard steel.
- 4 The pressure inside the polishing chamber is maintained constant by means of the adjustable balance-weighting section.
- 5 The Model MG are equipped with a special apparatus which can increase or decrease the diameter of polishing cylinder for harder or milder friction to the rice grain.
- 6 The bran which is discharged through the polishing screen may be collected downward and conveniently disposed of by way of, if available, an outside booster fan and piping.

Specification of "CeCoCo" Steel Cylinder Type Rice Polisher only, without Angle Stand and Motor-Inclusive-Bed

Model	Hourly Capacity in hulled rice	Power Req'd		R.P.M.	Dimension in mm			Export Packing		
		Motor	Engine		Height	Width	Length	N.W.	G.W.	Cft
MS-4H	900-1,200kg	15HP	20HP	550-600	755	450	1505	290kg	440kg	30
MS-3H	500- 600kg	10HP	12HP	550-600	665	430	1240	175kg	310kg	20
MG-4H	900-1,200kg	15HP	20HP	550-600	755	450	1665	295kg	445kg	30
MG-3H	500- 600kg	10HP	12HP	550-600	665	430	1380	180kg	320kg	20

Remark:—We can supply Iron make Angle Stand and V-belted Motor drive equipment for above machine with extra cost.

### "CECOCO" AUTOMATIC HULLED RICE SEPARATOR

For a long time in the past, the separation of paddy from hulled rice was a toughest problem posed to many rice millers throughout the world. Sometimes, rice millers had to install a big-size paddy separator which occupies large space in a mill where smaller one should come, very often such paddy separators being rather difficult to handle. And some other times, they had to dispense with any paddy separator at all, which would bring about rather unfavorable results on finished white rice. The Auto-Separator eliminates all this inconvenience, but offers every advantage of compact size, easy operation, low maintenance cost, small driving power and high adaptability to any kinds of grain in stable performance. The Auto-separator Model DS-20 is a compactly built "Double-Unit" paddy separator of amazingly high capacity and performance, consisting of two similar blocks of separating tables symmetrically oscillating sideways for a reliable separation of hulled brown rice from paddy. Each oscillating block accommodates ten pieces of separating tables which possess a rough surface, slightly slanting frontward and drivable by means of a special "Symmetric-Drive" shakes two separating blocks symmetrically at the fixed constant speed.

"CeCoCo" Auto Separator

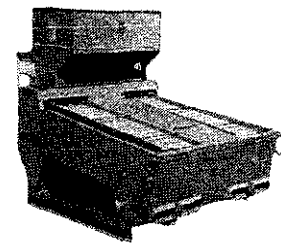

Specification of "CeCoCo" Automatic Hulled Rice Separator

Model	Capacity per hour		Power Req'd	R.P.M.	Dimension in mm			Export Packing		
	short grain	long grain			Height	Width	Length	N.W.	G.W.	Meas't
DS-20	2,000 to 3,000 kg	1,700 to 2,550 kg	2-3HP	300-315	1380	1276	1613	340kg	670kg	100cft

### "CECOCO" CYLINDRICAL POLISHED RICE GRADER MODEL 'CRG'

When the white rice is prepared for market sale, the broken and stunted rice contained greatly deteriorate its market evaluation. In order to avoid such, the broken or small immature rice must be separated from the bulk of whole rice.

The Cylindrical Grader Model CRG is capable of sizing and separating various grains into 2 to 4 groups subject to number of cylinders, including the head rice and some grades of broken rice.

Available for single, double and triple vertical arrangements in either one-unit or two-unit setup and also for two different sizes of cylinder length so as to more economically and efficiently match the required separating needs.

The special reduction gear box and motor base are optionally available for direct motor drive.

Type of Cylindrical Grader:

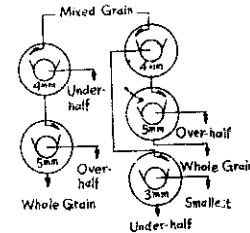
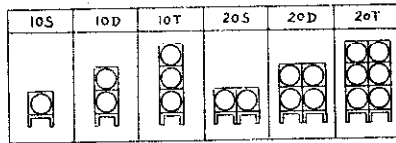

Specification of "CeCoCo" Cylindrical Polished Rice Grader Model 'CRG'

Type	Capacity per hour	Power Req'd		Revolution per min.		Dimension in mm			Export Packing		
		Motor	Engine	with Gear	w/o Gear	Height	Width	Length	N.W.	G.W.	Cft
10SS	500kg	1/2HP	1.0HP	710rpm	97rpm	1075	550	1644	200kg	285kg	40
10SL	700kg	0.6HP	1.0HP					2254	230kg	330kg	50
10DS	800kg	1.0HP	2.0HP	710rpm	97rpm	1530	550	1644	360kg	475kg	60
10DL	1,000kg	1.2HP	2.0HP					2254	410kg	570kg	80
10TS	800kg	1.5HP	2.5HP	710rpm	97rpm	1985	550	1644	515kg	650kg	90
10TL	1,000kg	1.8HP	3.0HP					2254	590kg	730kg	120
20SS	1,000kg	1.0HP	2.0HP	710rpm	97rpm	1075	1020	1644	390kg	540kg	75
20SL	1,400kg	1.2HP	2.0HP					2254	440kg	650kg	105
20DS	1,600kg	2.0HP	3.0HP	710rpm	97rpm	1530	1020	1644	700kg	885kg	120
20DL	2,000kg	2.4HP	3.5HP					2254	805kg	1050kg	160
20TS	1,600kg	3.0HP	4.0HP	710rpm	97rpm	1985	1020	1644	1010kg	1240kg	155
20TL	2,000kg	3.6HP	4.5HP					2254	1160kg	1510kg	205

- Remarks:—a) 'S' at the end of type name stands for 'Short size' (1,300mm) for the length of separating cylinder, and 'L' for 'Long size' (1,910mm).  
 b) The machine is available for two types in regard to main drive transmission, that is, 'With Gear Box' for direct motor drive by way of Speed Reduction Gear Box and 'Without Gear Box' for line shaft drive.  
 c) The capacities show the standards for mixed rice containing maximum 30% of broken rice.

### "CECOCO" POLISHED RICE GRADER

"CeCoCo" Rice Grader

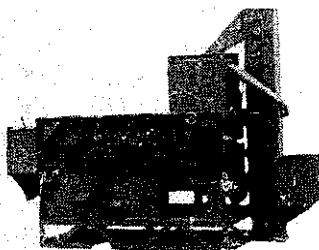

When the white rice is prepared for market sales, if the broken and stunted rice contained will greatly deteriorate its market evaluation. In order to avoid such, the broken and small immature rice should be separated from the bulk of whole rice. This "CeCoCo" Rice Grader Model 'RG' will classify the rice grain into 5 grades, viz. whole rice and 4 kinds of broken according to its size by means of oscillation screens.

When polished rice in Rice Tank is conveyed into Rice Hopper by means of Elevator, open Lever gradually to run it on oscillating 1st Screen. While polished rice flows hopping on 1st Screen, broken rice passes down through 1st Screen and then only 'White Rice' is tossed into Whole Rice Outlet at end of 1st Screen. The broken rices (4 kinds of over half, under half, small unmatured, broken and powdered) are discharged out of several outlets.

Specification of "CeCoCo" Rice Grader

Type	Hourly Capacity in white rice	Power Req'd		R.P.M.	Dimension in mm			Net Weight	Gross Weight	Ship'g Meas't
		Motor	Engine		Height	Width	Length			
No. 1	1,000 kgs	2 HP	2 HP	600	1758	682	2311	324 kg	464 kg	75 cft
No. 2	500 kgs	1 HP	2 HP	600	1758	560	2311	280 kg	450 kg	70 cft

## "CECOCO" WHITE RICE CLEANER

For the purpose of separating pure grains from sand, dust, stone, grit and other foreign substances and in cleaning grains thoroughly

"CeCoCo" Grain Cleaner completely selects a pure rice from unseen impurities in less a minute, by passing through this machine only once. A new principle of the difference of the specific gravity between cereals and impurities is adapted.

By adopting the slant up-and-down movement applied to the law of inertia, and it is surprising that perfect rice free of sand is obtained. The weight of machine is very light and needs only small horse power. The construction is very simple and operation is easy. The polished white rice with bran attached even small pieces of sand grit included, only pure white rice is obtained. In fact, this machine can both function as a rice sand-separator and an aspirator.

"CeCoCo" White Rice Cleaner

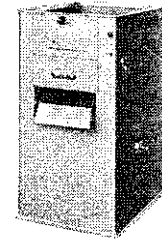

Specification of "CeCoCo" Polished Rice Cleaner

Type	Capacity per hour	Hopper Capacity	Power Req'd	R.P.M.	Dimension in mm			Net Weight	Gross Weight	Ship'g Meas't
					Height	Width	Length			
AA-1	480 kg	60 kg	1 1/2 HP	1400	920	500	500	35 kg	70 kg	15 cft
BA-2	1,200 kg	60 kg	1 1/2 HP	1400	920	500	500	37 kg	70 kg	15 cft
AA-2	1,800 kg	30 kg	1 1/4 HP	1200	920	550	700	51 kg	100 kg	20 cft
AA-3	4,200 kg	70 kg	1 1/2 HP	1260	1000	710	945	110 kg	200 kg	35 cft

## "CECOCO" RICE MILLING UNIT

Cleaner — Huller — Polisher — Grader Combined in one operation

The whole unit comprises four machines, i.e. Paddy Cleaner (see page 42), Rubber Roll Rice Huller, Model Automatic KL-A (see page 45), Vertical Type Abrasive Roll Rice Polishers (see page 48) and Rice Grader (see page 50) is fully automatic and continuous system in one stage.

Paddy is hulled by means of the rubber rolls giving no bruise and breakage to the grain and perfectly separated from paddy. Brown or hulled rice is polished by an vertical abrasive roll equipped in the polishing chamber. The whiteness of grain is adjusted by a Feed-in-Adjuster and Resisting Plate and is tenderly pearled by an air velocity, and the rice bran is collected into Bran Cyclone. Thus polished and pearled rice is graded into 5 grades, viz. whole rice, and 4 kinds of broken (over-half, under-half, small immatured, broken and powdered) according to the sizes by means of oscillation screens. The percentage of the whole rice is much greater than by any other conventional rice milling machine and it will increase the output recovery at least 20 percent which will easily reimburse you to replace your present machines. If required, each of Paddy Cleaner, Rice Huller, Rice Polisher and Rice Grader is supplied separately.

"CeCoCo"  
Rice Milling Unit  
Model KRM-A, Type 05

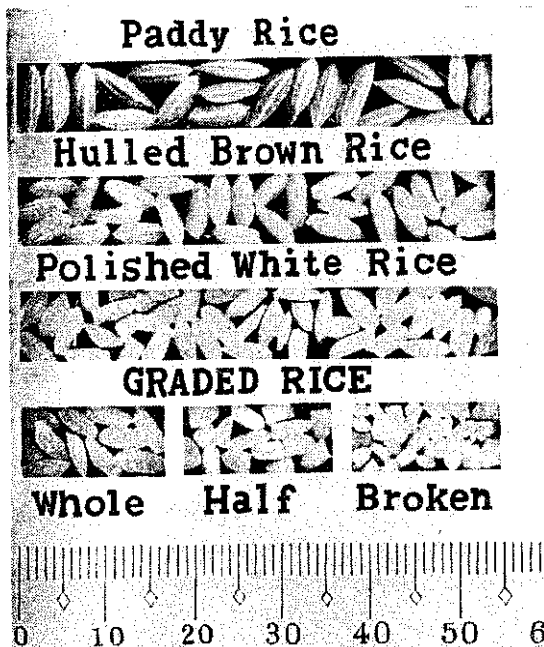
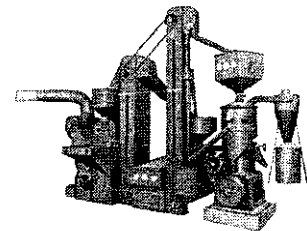

In order to separate further a small piece of the polished rice out of the pure rice-bran, "CeCoCo" Bran Grader is also supplied. ADVANTAGE and SPECIALITY of this unit is that it will take only a very small floor space in installing and once set in order it will require no attention.

Arrangement of "CeCoCo" Rice Milling Unit Model 'KRM-A'

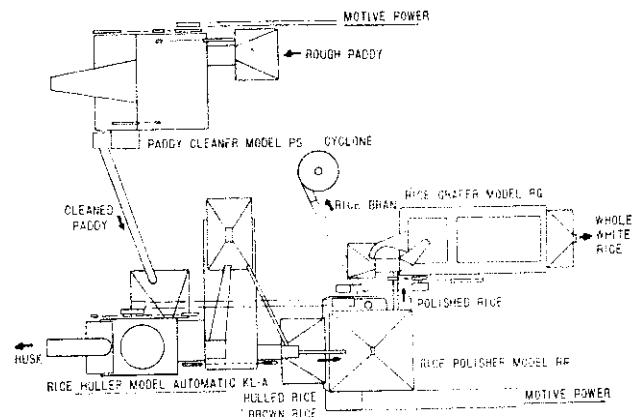

Specification of "CeCoCo" Rice Milling Unit, Model KRM-A

Type	Capacity in paddy per hour	Machinery installed				Floor Space in meter	Power Req'd		Weight in kgs		Ship'g Meas't cft
		Paddy Cleaner	Huller KL-A	Vertical Polisher	Rice Grader		Electric Motor	Diesel Engine	Net	Gross	
10P	1,000 to 1,200 kg	No. 1	No. 1	No. 10	No. 1	5.0×3.5	20 HP	25 HP	2236	3190	441
10R		.....	No. 1	No. 10	No. 1	2.0×3.5	18 HP	22 HP	1763	2543	321
10		.....	No. 1	No. 10	.....	2.0×2.8	17 HP	20 HP	1459	2079	246
05P	600 to 750 kg	No. 1	No. 2	No. 5	No. 2	5.0×3.0	12 HP	16 HP	1504	2415	365
05R		.....	No. 2	No. 5	No. 2	1.5×3.0	11 HP	14 HP	1228	1915	275
05		.....	No. 2	No. 5	.....	1.5×2.5	10 HP	13 HP	948	1465	205

"CECOCO" SMALL COMPACT RICE MILL UNIT

"CeCoCo" Rice Mill Unit Type SM-25K

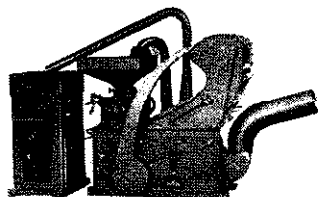

The "CeCoCo" Rice Mill SM-25K type is a small type rice mill composed of Rice Huller Model Automatic 'AM' Type No. 25 (see page 46) and Steel Roll Rice Polisher Model Marumaster Type MK-2, has the highest running economy and the simple but sturdy construction for home-use.

It is also to be clearly distinguished from the primitive rice-mill as it is based on a well balanced "paddy to polished rice" straight and simple milling method.

One of the many advantages of this Rice Mill SM-25K Type is that it can be employed either as a whole complete unit for a continual milling of paddy into polished white rice or separately as a rice huller and a rice polisher. Therefore, the brown rice, not as white rice, can be obtained if so preferred for market requirement at customer's choice.

Specification of "CeCoCo" Small Compact Rice Mill

Type	Hourly Capacity in brown rice	Power Req'd		R.P.M.	Floor Space Required	Net Weight	Gross Weight	Ship'g Meas't
		Motor	Engine					
SM-25K	170 to 200 kg	3 HP	5 HP	550	1×2 meter	175 kg	330 kg	65 cft

"CECOCO" LARGEST RICE MILLING PLANT

The "CeCoCo" Rice Milling Plant Model KRP, Type 20 is an incorporated as complete unit of rice milling that has been combined together with the relative machines and equipment installed compactly, but with a sufficient operational room employing two-storey set-up in system.

The "CeCoCo" Rice Milling Plant Model KRP, Type 20 performs an automatic and thorough milling process of turning out pearled white rice out of rough paddy, featuring extra-high efficiency, extra-high recovery, fool-proof simplicity of operation and handling, small installation space required for installation, low maintenance costs, etc.

The whole plant includes Rough Paddy Elevator, Paddy Cleaner No.1 type, Cleaned Paddy Elevator, Rice Huller with Winnower Model Combination 'NGO' Type No. 10, Hulled Rice Elevator, Auto-separator DS-20 type, Rice Polishers Type No. 1, White Rice Elevator, Cylindrical Rice Grader CRG-20 type, together with Tanks, Bran Collector, Piping materials, Plat-form materials, Countershafting materials and Motive Power, either Electric Motors or Diesel Engine.

"CeCoCo" Rice Mill Plant KRP-20

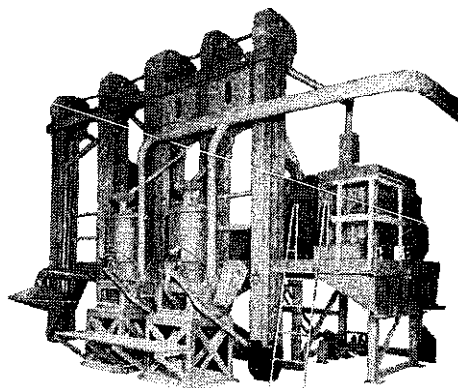

Specification of "CeCoCo" Largest Rice Milling Plant

Model	Type	Hourly Capacity in paddy	H.P. Required		Revolution of Main Countershaft	Floor Space Required
			Motor	Engine		
KRP	20	2,000-2,300 kg	5 & 50	65-80	400 r.p.m.	7×6 or 9 meters

# WHEAT AND BARLEY PROCESSING MACHINERY

## "CECOCO" FLOUR GRINDING MACHINE CHILLED BURR TYPE

The construction is all metal made with first workmanship, and finished in attractive appearance. Due to the simple design, it is easy to handle and the working parts can be dismantled without any trouble for cleaning. They are enclosed to ensure the sanitation of the finished products. The meshes could be easily adjusted by turning the Adjusting Handle, opening or closing the space between the stationary burr and rotating burr. The burr is the most important part, and its quality decides the superiority of mill. Manufactured with chilled casting and its hardness reaching 57 degrees on Rockwell hardness tester ensures smooth revolution and good resistances to wear, and the frictional surface is finely and carefully finished.

Adaptable in flour grinding of all kinds of grain and other materials such as wheat, rice, meal, buckwheat, soy-bean, dried fish, etc. and also for chemical industry. For an example, black lead, naphtharin, tark, dry-stuffs, cream, pigment, celluloid, sulphur, drugs, lime, carbide, etc. can be pulverized to any degree of meshes up to 20.

"CeCoCo" Flour mill  
Type D

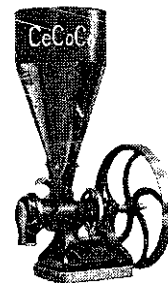

Specification of "CeCoCo" Chilled Burr Type Flour Grind Mill

Type	Capacity of Hopper	Capacity per hour		Power Req'd	R. P. M.	Net Weight	Gross Weight	Ship'g Meas't
		Coarse Crinding	Fine Pulverizing					
A	30 kg	500 to 1000 kgs.	250 to 500 kg.	2-3HP	200-500	70 kg.	100 kg	20 cft
B	20 kg	250 to 500 kgs.	120 to 240 kg.	1HP	200-500	36 kg.	60 kg	15 cft
C	10 kg	180 to 360 kgs.	90 to 180 kg.	1/2-1HP	200-500	27 kg.	45 kg	10 cft
D	10 kg	90 to 180 kgs.	60 to 120 kg.	1/4-1/2HP	200-500	19 kg.	30 kg	7 cft

- Remarks:- 1) Grinding capacity varies according to the material, condition of dryness and grinding size or meshes.  
2) Type D is equipped with flywheel and handle, and can also be manually operated.

## "CECOCO" FLOUR MILLING MACHINE CHILLED ROLL TYPE

Speciality of this flour milling machine is aimed for use in rather small flour industries. Since we have introduced this particular machine of the chilled rolls, it grinds wheat in a very short time without losing no gluten and produce a good quality of fine flour (129 or 144 meshes), therefore the ground materials possess better taste than any other machine on market. This machine is made with first class workmanship and equipped with two complete chilled rolls of 75-80 degree in hardness. It is constructed with a selected metal, and durable and electric power consumption is very small. The gears with precision cogs and air-tightly sealed, producing no sound. The operation and interchange of the spare parts are very simple, and it takes a small space for installation. There are many other advantages as to the sifter and shaking device. We strongly recommend to adapt this particular flour milling machine for your flour mill industry.

Flour milling unit  
Type R-3

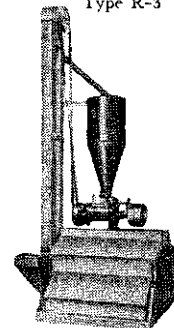

"CeCoCo" Chilled Roll Type Flour Milling Machines are economically adapted not only for flour grinding wheat but also all kinds of grain and other materials such as rice, buckwheat, dried potato, soy-bean, corn, kaoliang, red pepper, fooder, stuff for drugs, stuffs for toilet good, perfume and chemical industry, etc. By installing "CeCoCo" Flour Milling Machines together with Wheat Selecting Machines, you can elevate the value of wheat flour and increase your profits.

Specification of "CeCoCo" Chilled Roll Type Flour Milling Machine

Type	Capacity of Hopper	Capacity in wheat/hour	Size of Roll	Power Req'd	R. P. M	Floor Space	Weight kg.		Ship'g Meas't
							Net	Gross	
R-3	180kgs.	60 kgs.	8"φ×10"	3HP	220	2 × 1.5m	600	1200	250cft
B	60kgs.	45 kgs.	7"φ×10"	3HP	260	2 × 1.5m	520	860	185cft
K	60kgs.	20 kgs.	5"φ×10"	1HP	300	1.5×1.2m	290	410	150cft



In order to promote the quality standard of the flour, it is essential that the wheat should be processed through excellent flour milling machines, but it is still more important that before the wheat is put through the process, it should be separated or sorted thoroughly for eliminating undesirable impure substances.

#### Specification of "CeCoCo" Wheat Selecting Machine

Type	Capacity of Hopper	Capacity per hour	Power Req'd	R. P. M	Floor Space	Net Weight	Gross Weight	Ship'g Meas't
A-3	60 kgs.	250 kg.	1HP	450	0.7×1.5m	117 kg	248 kg	56cft
Y-G	60 kgs.	120~180 kg.	1HP	450-500	1.0×1.5m	216 kg	324 kg	50cft

#### "CECOCO" NOODLE MAKING MACHINE

In Japan, rice is the staple food among the people. However we use a fair amount of various kinds of wheat. Wheat flour was chiefly used as bread but it is also used as noodles. This is the machine for making it.

There is no difficulties of operating this machine according to mechanism and efficiency. Usually one set consists of the three machines, (a) Mixing machine, (b) Rolling machine and (c) Cutting machine. There is another set consisting of the rolling and the cutting part equipped in one unit.

It is said to be a unique Japanese machines. In Japan, noodles are not only made from wheat flour, it is also made from buckwheat flour. The size of noodle is about  $\frac{1}{16}$ " to  $\frac{3}{16}$ " in thickness. There are more than 15 different cutters. When ordering, please specify the thickness of the noodle you require to produce.

- (a) Mixing Machine — This is a machine which mixes flour and salt-water. Time required for is 5 to 10 minutes.
- (b) Rolling Machine prepared by the above Mixer is then rolled into a belt or band form. When it is well rolled, wind-up it with a wooden bar. The quality of a noodle band has a direct influence upon noodle lines.
- (c) Cutting Machine — The noodle band is further rolled and is cut into fine noodle-lines by cutting machine. It is replaceable at desired thickness and then dry for finish.

"CeCoCo" Noodle Making Machine  
Type E-1

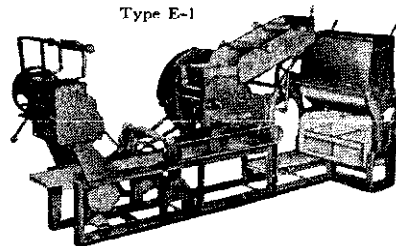

Type No. 2

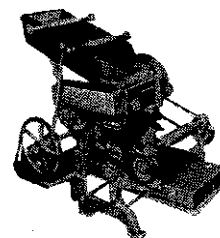

#### JAPANESE SOBA (KIND OF NOODLE) MACHINE USED BY TIBETANS

NEW DELHI (AP) — Japanese know-how and American wherewithal have turned hundreds, perhaps thousands, of Tibetans into noodle-eaters. Tibetan refugees here are "taking noodles like hot cakes," says Travis Fletcher of the American Emergency Committee for Tibetan Relief. Fletcher was faced with helping India feed more than 40,000 Tibetans who fled their homeland under Chinese Communist oppression. Most were rice or barley eaters. The food most available here was American surplus gift wheat.

A Chinese refugee noodle making project in Hongkong gave Fletcher the idea of introducing noodles to Tibetans. He bought a machine in Japan to mix wheat dough, roll it flat and cut it into long strips. It was set up here in the basement of an old British luxury hotel which is now a Roman Catholic school. Tibetan refugees quickly taught themselves to run the machine and make up to 1,000 pounds of noodles a day. The noodles are dried in the cool of the basement, packed in plastic bags, sealed and distributed by Indian officials to Tibetan relief camps. The experiment is working so well that Fletcher is buying another machine from Japan. All he needs is another basement room.

#### Specification of "CeCoCo" Noodle Making Machine

Type	Capacity in flour hour	Power Req'd	Size of Machine		Floor Space	Net Weight	Gross Weight	Ship'g Meas't
			Mixer	Rolling machine				
E-1	50 - 70 kg.	2 HP	22 kg	210mmφ×230mm	4.5sq. mt.	600 kg	800 kg	130 cft
E-2	40 - 60 kg.	1 HP	12 kg	150mmφ×230mm	4 sq. mt.	500 kg	700 kg	120 cft
E-3	40 - 50 kg.	1/2HP	8 kg	120mmφ×230mm	3 sq. mt.	400 kg	600 kg	100 cft
No. 1	20 - 30 kg.	1/2HP	Without	120mmφ×230mm	1.5sq. mt.	220 kg	330 kg	25 cft
No. 2	15 - 20 kg.	1/2HP	—do—	105mmφ×210mm	1.3sq. mt.	160 kg	240 kg	16 cft
No. 3	10 kgs.	1/4HP	—do—	90mmφ×150mm	1 sq. mt.	100 kg	150 kg	11 cft

- Remarks:- 1) Type Nos. 1, 2 & 3 can be operated manually, if desired, by equipping with a flywheel & driving handle instead of motor driven apparatus.
- 2) In case you require a large capacity than above machine, Please indicate the details: (a) type and material to be used, (b) required capacity per hour, (c) desired thickness of noodle, (d) driving method, (e) character of electric motor etc.

### "CECOCO" BAKERY MACHINES & EQUIPMENT

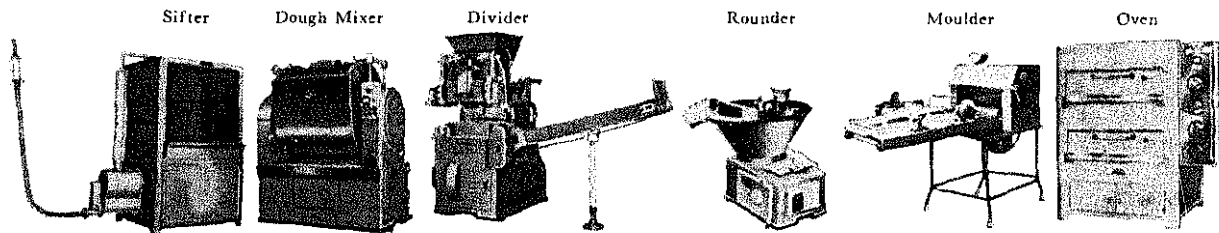

When enquiring, please state your requirements for (a) name of machine or equipment you are in need, (b) kind of products, (c) weight of product, (d) capacity per hour, (e) local temperature and humidity, (f) working hours per day, (g) electric power supply available etc.

- 1) **SIFTING** — Sifter is used to remove the foreign substances and loosen the powder to allow the oxygen in the air penetrates evenly into the powder and equalizing water-absorption of the powder.
- 2) **MIXING** — Mixer is used to compound the sifted powder and make the 'dough' and disperse evenly by kneading, and rolling to raise the productive efficiency of gluten.
  - a) Kneading action:— Add water, yeast and other materials to the flour, mix them uniformly and make the dough.
  - b) Forming bubble action:— Put as much air into the dough as possible, which promotes the fermentation of yeast.
  - c) Rolling punch action:— Roll, stretch and hit the dough brings good development to gluten. The complete absorption of the water, gluten together with the action explained above, give the dough good expansion, softness, elasticity, and viscosity, and equalize the 'dough' very much.

The most proper temperature for finishing of the dough is 24 to 26 degree centigrade, as this is the most suitable temperature for the yeast to start efficient activity to fermentation.
- 3) **FIRST FERMENTATION** — After final kneading, the 'dough' is put in the ferment tank and placed in ferment room. It is an ideal to keep the temperature in ferment-action-room at 26.6°C and humidity to be 75%  
Now, as to the box containing the dough, although it seems very popular to practice the fermentation not in the fermentation-room but in the work room and use the wooden tank for keeping warm, but this method is apt to become unclean because of moisture. Therefore, it is desirable to use a 'metal tank box' in the fermentation-room and the size of the box must be 3 to 4 times as large as the capacity of the dough.
- 4) **DIVIDING** — Divider are designed to divide automatically and accurately the fermented dough mass into pieces of required volume for making up loaves. It mechanically utilizes self-weight of dough and the action of vacuum suction without hurting dough.
- 5) **ROUNDING** — The divided dough surfaces will considerably be injured, so it must be restored with certain time of rest. The Rounder is, therefore, used to let the dough take a rest and restore by sealing the tear-end and spreading thin membrane on the surface which prevents the gas from going out of the tear-end. Intermediate Proofing — The dough pieces, as delivered by the rounder, are rather dense and heavy, having lost much of their gas during the dividing operation. To facilitate the next major physical operation, they must be given a brief rest. In order to achieve the above, we have two types; overhead and floor type. It is adjustable for changing the proofing temperature, time and so on. Usually the proofing time is 8 to 20 minutes. The most proper temperature is at 29.4°C and humidity 75 to 80%. If the temperature is raised to more than 32°C, the proofing work is performed too fast and the capacity of keeping gas inside the dough reduces on the contrary.
- 6) **MOULDING** — Moulder is to sheet, cure and seal the individual dough pieces, imparting them to their final loaf shape, and at the same time, subject them to a manipulation that will serve to improve the grain and texture of the finished bread.

- 7) **PROOFING** — The moulded loaf will be much injured and gluten becomes stiff when the gas is gone. It is necessary, therefore, to let the carbonic acid gas be produced to recover the gluten to the restored conditions by giving a moderate temperature and humidity. This is the second fermentation stage, and the operation is done in a proofing-room by inserting a burn-plate in which the moulded loaf is put. The ideal temperature is 35 to 36.5°C and 80-85% in humidity.
- 8) **BAKING** — The loaf properly swollen after the second fermentation, is baked in an oven. The heat penetrates into the loaf from the surface and raise the inside temperature stimulating the activity of yeast, and will produce the carbonic acid gas. The gas in the loaf will swell up. Fermenting should be done to the maximum extent for the starch quickly changing into paste and saccharifying is acted by causing the change of gluten. Thus, the gas and fermenting are simultaneously done and yeast-cell be destroyed as the temperature rises. This will stop the bread not to swell without limits.
- 9) **BREAD' S COOLING AND SLICING** — The bread should not be sliced if still warm, because if it was sliced, the form will be damaged and will show a very coarse surface. If wrapping is made while it is still warm, it tends to have fungus easily and spoiled early. By these reasons, slicing and wrapping are to be done after cooled off properly. As to the proper temperature of these treatments, 29° to 32°C is generally regarded as the good temperature. But, this temperature differs more or less according to the kind of bread or the hardness of bread. When hard bread is required, the method of making and cooling must be lowered to 26° to 29°C. on the contrary, when softer bread is needed, should be made in a comparatively high temperature of about 37° to 46°C. Further, these temperature is to be measured at the center part of the bread.

### “CECOCO” BARLEY POLISHING AND WHITENING MACHINE

The “CeCoCo” Barley Polishing Machine consists of Polisher with Stand, Bucket Elevator, Cyclone, Blower and Hopper. It is equipped with a taper shape of abrasive cone type roll in which numerous air blowing holes are in a slant way facing downwards. When the grain is fed into hopper through feed box and bucket elevator, they are polished by abrasive roll and completely white polished grain will come out of outlet forcing the bran out through the screen and will be collected into bran collector. The same operation will be automatically repeated and three to four circulations.

“CeCoCo” Barley Polishing & Whitening Machine Type “E”

This polisher is also used for wheats, rice, millet, sorghums etc. by simply changing the Abrasive roll and screen accommodately.

Specification of “CeCoCo” Barley Polishing Machine

Type	Capacity per hour	Power Req'd	R. P. M.	Dimension in mm			Net Weight	Gross Weight	Ship'g Meas't
				Height	Width	Length			
E	60-120kgs.	3-5 HP	1300-1500	2745	865	1350	250 kg.	430 kg.	75 cft
SE	240 kgs.	7.5 HP	1300-1500	3350	890	1400	300 kg.	500 kg.	90cft



### “CECOCO” HANDY ELECTRIC GRIND MILL

“CeCoCo” Handy Grind Mill

#### Specification

Grinding Size.....any mesh, replaced by interchangeable screen.  
 Capacity of Hopper.....0.1 bushel  
 Power Required .....350 watt, attached  
 Dimension .....510mmH×240mmW×240mmL  
 Applicable to.....Rice, Wheat, Beans, Dried fish, peppers, dried herbs, chemicals, dye stuff, and other crushable materials.  
 Grinding Capacity .....varies depending upon material, grinding size, dryness, etc.  
 Net Weight.....6.7kg.  
 Packing .....10 sets in a wooden case.  
 Shipping Measurement...30 cft.

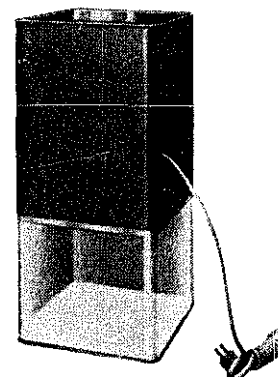

## BEANS PROCESSING MACHINE

### "CECOCO" BEAN THRESHER

The "CeCoCo" Beans Thresher is made for threshing various beans and seeds in full length or cut in short-stalks. Feed the materials into threshing chamber, and they will be threshed by the threshing drum with multi-teeth. The materials which were released by threshing are separated from stalk, chaff, unripe materials, and shell, etc., by force of a blow fan during falling through the screen. As a result, only the pure and complete beans or seed is carried by the Screw Conveyor to the vertical screw elevator, and then to outside through the outlet of elevator. This machine can thresh seeds by changing the screens which are easily replaceable.

The threshing capacity in rape-seed is 10 ares per 30 minutes of high efficiency.

"CeCoCo" Beans Thresher

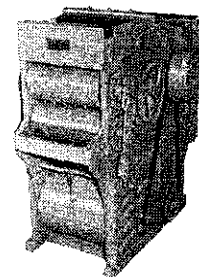

Specification of "CeCoCo" Beans Thresher

Type	Capacity per hour	Power Req'd	R. P. M	Dimension in mm			Net Weight	Gross Weight	Ship'g Meas't
				Height	Weight	Length			
M	30 ares in soybean	2-3HP	600-650	1010	860	1010	110 kg	160 kg	50cft

### "CECOCO" BEAN SEPARATOR & GRADER

This machine will automatically separate and clean the bean from dust, grit, stone, mud, sand, seed or any other foreign matters and classify them into three grades, viz. small, medium and large sizes according to sizes required, by means of interchangeable screens. Made of well seasoned wood, strong and durable.

"CeCoCo" Bean Separator & Grader Type No. 2

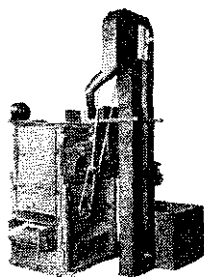

Specification of "CeCoCo" Bean Separator & Grader

Type	Hourly Capacity	Power Req'd	R. P. M.	Floor Space	Weight in kg		Ship'g Meas't
					Net	Gross	
No. 1	50-60 bushels	1/2-1HP	330-350	5x5ft	450	650	230cft
No. 2	40-50 bushels	1/4-1/2HP	350-400	4x4ft	380	530	185cft
No. 3	8 bushels or 12-16 bushels	Hand 1/4HP	70-100	3x4ft	100	150	60cft

### "CECOCO" BEAN CLEANER & SEPARATOR

— Adapting Gravity and Inertia —

(The red bean and any other round shaped beans can also be processed)

1) **MATERIAL SUPPLY FUNNEL:** Agitating Roll is equipped to obtain an even quantity flow of beans, and the Adjusting Plate is to adjust the required quantity of dropping.

2) **FIRST SEPARATING DEVICE:** This is the first stage where the perfect-whole-beans are separated from the bean-husks, dust and other impurities through the action of different speeds by rambling down by the angle of inclination of Separating Plate by adapting the principles of it's inertia and gravity. Thus, defective and imperfect beans are dropped out because of the gravity and low speed, the-whole-perfect beans are being carried to the second stage jumping over the gap between the first and second stage plates. In order to prevent the trouble of the low speed-beans from interrupting the whole perfect beans, this device gives an oscillation toward the right angle against the smooth running of the whole perfect beans. Adjusting Handles is equipped for changing the angle of inclination to any degree to adjust for jumping. (This machine is meant for handling only the round beans, please indicate the sizes of beans and also send us sample beans you wish to treat.)

3) **SECOND SEPARATING DEVICE:** The second beans-separating-plate is equipped for the job. The job of separating the whole perfect beans from the worm-eaten or immatured beans, through the different distance of jumping spaces caused by the ability of their jumping action. In pursuing this object, this device is equipped with adjustment for setting a proper inclination and distance between the first and second plates.

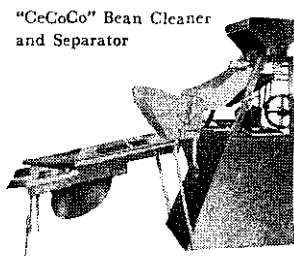

"CeCoCo" Bean Cleaner and Separator

- 4) **SEPARATING FUNNEL** : A partition is equipped inside of the Funnel to adjust the distance between the first and second stage plates to separate the whole perfect beans from the worm-eaten beans and other impurities.
- 5) **SEPARATOR FOR DIFFERENT SHAPES OF BEAN** : This is made with 2 different sizes of vertical Lined-Separators to assort the whole perfect beans to be separated by Separating Funnel into 3 different grades of standard.

Specification of "CeGoCo" Bean Cleaner & Separator

Type	Elevator	Power Req'd	R. P. M.	Capacity per hour		Dimension in mm			Weight in kg		Ship'g Meas't
				Soy-bean	Red-bean	Height	Width	Length	Net	Gross	
N 1	without	1/8HP	250	12-16bus.	4-8bus.	1520	560	1940	110	230	65 cft
N 2	with	1/4HP	250	12-16bus.	4-8bus.	2120	560	1940	135	255	90 cft

### "CECOCO" BEAN SPLITTING AND DEHUSKING MACHINE

This machine will split bean into 2 pieces and peel off the skin of beans by abrasive emery roll without shaving the beans and at the same time, when the beans are peeled off, the skins will be separated from the beans by the function of a blower. If some beans cannot be peeled off by one operation, depending upon the shapes and kinds of beans, repeat the same operation twice or three time for complete peeling, since the beans will never break. When enquiring, please send us some sample of your beans to enable us to study the capacity and revolution of machine to fit. The space between the abrasive roll and screen is adjustable according to the size of beans and an air force of blower can also be adjusted.

"CeGoCo" Bean Splitting and Dehusking Machine



Dehusking efficiency and revolution will vary according to the degree of dryness, kind of bean and size etc.

The shape of abrasive roll varies according to the kind of bean and therefore, please send us samples of your bean for order.

Specification of "CeGoCo" Bean Splitting and Dehusking Machine

Type	Capacity per hour	Power Req'd	R. P. M.	Dimension in mm			Net Weight	Gross Weight	Ship'g Meas't
				Height	Width	Length			
E	240 kg. in soy-bean	5 HP	various (1000-1500)	1250	800	1050	90 kg.	140 kg.	25 cft
SE	360 kg. in roy-bean	7.5 HP	various (1000-1500)	1500	900	1200	130 kg.	200 kg.	40c ft

### "CECOCO" UNIVERSAL GRAIN THRESHER

The Universal Grain Thresher Type T 25H is capable of threshing various kinds of rice, wheat, beans and cereals by replacing the pulley between Threshing-Drum-Shaft and Winnower-Shaft, and operation is so simple and high efficiency is ensured.

"CeGoCo" Universal Grain Thresher Type T-25H

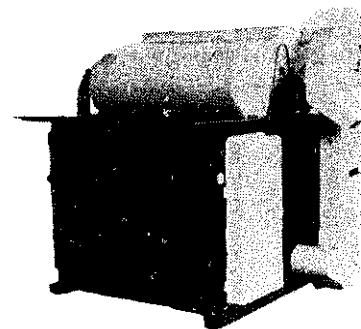

Separation is so admirable and no winnowing is necessary. Second separation of the grain and stalks scattered at the second outlet is also possible and therefore, complete separation can be made without wastage. Another speciality is this that the interchangeable separating screen can easily be replaced according to the size of grain in order to prevent the breakage,

The machine is so simply constructed and movable from place to place due to its light weight and most suitable machine for operation outdoors. Grain Conveyor can be equipped as desired.

Specification of "CeGoCo" Universal Grain Thresher

Type	Capacity per hour	Power Req'd	R.P.M.	Size of Screen	Dimension in mm	Size of Drum	Weight in kg.		Cft
							Net	Gross	
T25H	rice 500kg.	2-3HP	550-600	750x595mm	1,100H	756mmW x 364mmφ	115	220	80
	wheat 500kg.		650-700		1,300W				
	beans 1,500kg.	3-5HP	250-550		1,500L				

Remarks:— Capacity and revolution is depending upon material and horse power.

## MOST MODERN IMPROVED & ECONOMICAL TAPIOCA AND POTATOES STARCH PRODUCING METHOD

The object this particular method, by means of a technical and mechanical processing, is to raise the quality and increase the output production and decrease the cost of production.

The advantage of this processing is to save the time and labour and alleviate the wastes which is the defect of the conventional method. Because the automatically improved method of the unique processing merits the adaptation for your profit.

Fig. 1 "CeCoCo" Disintegrator

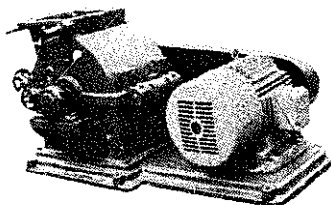

Fig. 2 "CeCoCo" Jet-Extractor

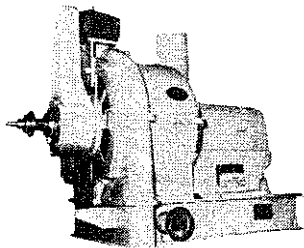
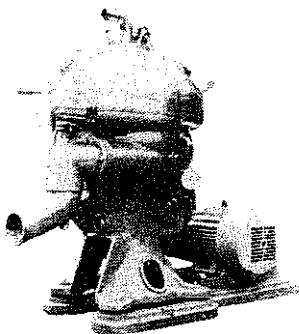

Fig. 3 "CeCoCo" Nozzle Separator



The Nozzle Separator is designed in utilizing the principal of centrifugal force as a centrifugal separator. The speciality of this particular separator is to instantly and completely separate 100% pure starch from protein and any other impurities. The efficiency of separation is very high and accurate. It's output capacity is astonishingly great. It does not require a big area to install, but only a small space. not such as in case of settle tanks, and the excellency of the yield percentage by eliminating many losses while setting together with the ability in producing a high grade of starch is the most attractive and valuable factor in adapting this unique device of "CeCoCo" Nozzle Separator.

#### 4. Dehydrate and Drying Process:—

Fig. 4 "CeCoCo" Dehydrator and Starch Dryer

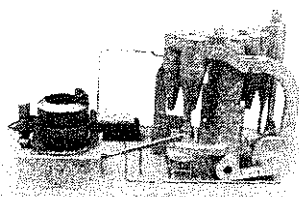

Remarks:—It is recommendable to adapt our particular item of the above machineries to get better and larger output of better grade of starch in conjunction with other machines now installed in your plant.

Of course it is most desirable to convert your present plant with entirely new processing machinery and devices, but it is also advisable to adapt some of them in conjunction with your already installed ones, thus we are confident that you will enjoy a great benefit in increasing the output efficiency to your surprise. It is worth-while for you to investigate at once.

#### 1. Pulverization Processing of Material:—

Although the appliance is about same as usual, by means of this particular pulverizer, the percentage of the yields is very great, as it will pulverize the material much more finer, which is very important at the first processing.

#### 2. Sifting process:—

Usually it is unnoticed that there is still a great quantity of starch left, in the pulp or dreg when the materials are sifted by means of a horizontal-shock-sifter or by a rotary-sifter. However, "CeCoCo" small and compact JET-EXTRACTOR will completely extract such starch still remained by the centrifugal force, thus increases the output of starch considerably.

#### 3. Concentration and Refining Process:—

The starch milk produced after sifting process, should be separated into starch and protein. Conventionally, the static-settle-method is being adapted, which will take a considerable period of time. Furthermore, beside this old method it requires to repeat the processing several times, thus gives an unforeseen loss which greatly retards the yields of starch and protein. In addition it necessitate a big area in installing several settle tanks as mentioned above.

In a modern starch industry, in place of the static-settle-method, this unique system of Nozzle Separator is now attracting a great deal of attention to the producers of starch as an epoch making plant from the stand point of an efficiency and economy.

Although the separated starch milk was usually dried out by a Rotary-Drum-type Vacuum Dryer or a Belt-type Dryer, both the dryers themselves and the efficiency of heat to dry out starch are not good enough in exhibiting a full energy and efficiency. However, by adapting "CeCoCo" Dehydrator and Starch Dryer, the starch milk produced by "CeCoCo" Nozzle Separator is dehydrated up to 37% and further up to 13%, which no other method can accomplish.

"CeCoCo" Dryer is based on the low-temperature flash-drying system heated by the steam of boiler by utilizing an utmost heat energy, and furthermore there is no fear of the dried starch is to be pasted liable to become mucilage.

### Flow Sheet of Tapioca and Potatoes Starch Producing Process

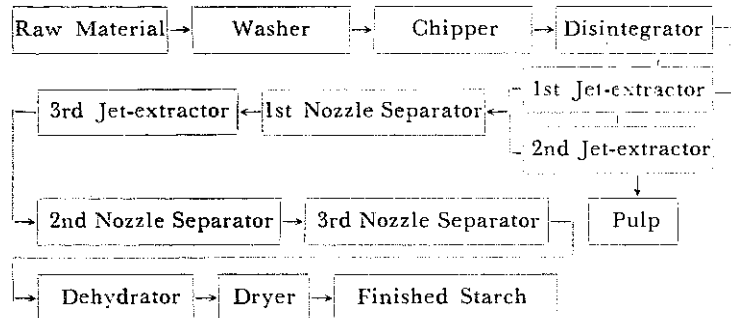

Interior View of Modern Factory of Starch Producing Plant



## COFFEE-BEAN PROCESSING MACHINERY

### "CeCoCo" COFFEE PULPER

The Coffee Pulper Type "S" is a hand-operated machine specifically designed to provide owners of small coffee plantations with an efficient unit of modern design, rugged construction, and simple operation.

This machine consists of a steel cylinder to which a copper screen with special perforations for coffee pulping is attached. The cylinder is revolved by means of cut tooth gearing and gear guards provide safety to the operator. If desired, this small unit can also be arranged for 1/4HP power drive by replacing the hand crank with a pulley of suitable size.

"CeCoCo" Coffee Pulper



Specification of "CeCoCo" Coffee Pulper

Capacity per hour	Power Req'd	R.P.M.	Size of Drum	Dimension cm			Net Weight	Ship'g Meas't
				H	W	L		
100 kg cherry	Hand 1/4 HP	50	165mm × 165mm	47	36	37	30kg	3cft.

### "CECOCO" ROASTER

— For Coffee-bean, Peanut-bean, Cacao-bean, etc. —

Roasting is accomplished by hot air from Blower through the drum. Exterior heating is avoided. Roasting period is approximately 15 minutes for small roaster and 7-8 minutes for Thermal-Expresso-Roaster. The "CeCoCo" Roaster can be furnished for use with city gas, and propane gas heating or with oil heating at extra cost. This Roaster are equipped with forced air gas burner or oil burner device with exhauster for roasting and cooling.

"CeCoCo" Roaster Model R27-A

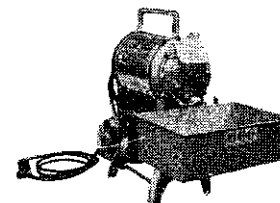

Specification of "CeCoCo" Roaster

Model	Power Req'd	Capacity in coffee		Fuel Consumption		Dimension in mm			Net Weight	Ship'g Meas't
		per charge	per hour	Gas	Kerosene	Height	Width	Length		
R26-S	1/20HP	1.5 kg.	4.5 kg.	0.5m <sup>3</sup> /h	1/4-1/3l/h	550	235	625	30 kg	7cft
R27-A	1/12HP	3.5 kg.	10.5 kg.	2.5m <sup>3</sup> /h	1/8-1/2l/h	780	390	800	64 kg	15cft
R26-A	1/4HP	7.5 kg.	22.5 kg.	3.0m <sup>3</sup> /h	1/2-3 l/h	1145	550	1170	130 kg	35cft
R28-A	1/4HP	12 kg.	36 kg.	4.0m <sup>3</sup> /h	1/2-3 l/h	1190	760	1510	190 kg	45cft
R31-A	1/2HP × 2	15 kg.	60 kg.	8.0m <sup>3</sup> /h	1/2-3 l/h	2500	950	2255	780 kg	220cft
R31-B	1 & 2HP	30 kg.	120 kg.	12m <sup>3</sup> /h	1 1/2-6 l/h	2650	1430	2810	1300 kg	380cft

Remarks: — Model Nos. R31-A and R31-B Thermal-Expresso-Roasters are equipped with Cooler, Stone Collector, Cyclone and Thermometer.

## "CECOCO" COFFEE MILL

The electrically driven coffee-mill is designed for grinding coffee-beans at high speed and is convenient for uses by household, grocery, restaurant, hotel, coffee-parlor, etc.

The main parts of this apparatus are an electric motor, a grinding part, hopper, receiving can, etc. The motor is high efficiency, durability and reliability and runs smoothly without giving any vibration and noise. Both stationary and revolving burrs are made of special cast metal and are treated to maintain proper hardness so as to prevent abrasion, while the grinding teeth are annealed to regain suitable softness.

Feeding coffee-beans into the hopper is all you have to do for operating the mill. The properly ground coffee-beans are gathered in the receiving can made of almite (electrically treated proof aluminium).

The required mesh of the ground coffee-bean may be selected by turning the adjusting wheel. The coffee mill is provided with an automatic release. In case some hard substance accidentally gets into the coffee, the rotating burr automatically stops turning to prevent the breakage of the machine. The cut-off plate is to be used to stop running down when exceed quantity of the coffee-beans remains in the hopper or when to adjust feeding quantity of the beans.

"CeCoCo" Coffee Mill  
Model #51

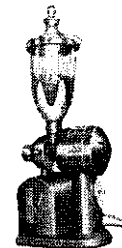

Granulation of Coffee Powder by "CeCoCo" Coffee Mill;

Type of Pot	Graduation Number of Adjusting Wheel	Granulation	Grinding Size
Siphon type	indicated 1 - 2	fine	20 - 25 mesh
Drip type	" 3 - 5	medium	15 - 20 mesh
Percolator	" 6 - 8	medium	10 - 15 mesh
Pot	" 8 - 9	coarse	10 mesh

Specification of "CeCoCo" Coffee Mill

Model	Capacity in Hopper	Capacity per hour		Power Req'd	Dimension in mm			Net Weight	Ship'g Meas't
		Granulating	Pulverizing		Height	Width	Length		
# 51	2.5 kg	30 kg	—	1/4HP	880	240	340	26 kg	10 cft
# 151	0.7 kg	30 kg	—	1/4HP	600	210	300	20 kg	5 cft
# 153	2.5 kg	60 kg	30 kg	1/2HP	880	240	375	35 kg	13 cft
# 52	2.5 kg	80 kg	40 kg	1HP	960	430	740	85 kg	20 cft
# 55	15 kg	80 kg	40 kg	1HP	1350	500	500	75 kg	15 cft
# 54	15 kg	180 kg	90 kg	2HP	1580	330	670	110 kg	35 cft
# 58	15 kg	230 kg	120 kg	3HP	1500	410	650	130 kg	35 cft

## SUGAR-CANE PROCESSING MACHINERY

### "CECOCO" SUGAR CANE MILL

This is a most improved type sugar-cane mill with special attachment of rubber roller, so that even the last drop of sugar yields will completely be extracted in a high percentage at a final stage, after sugar-cane is crushed, rolled and pressed. With a specially wrought turner, no waste will remain while in operation. To ensure the solidity and durability of machine, it was made of special steel, and the frame is strongly welded (not cast iron) to stand against breakage. The rollers-axles and the gears are made of nickel-chrome steel with precision workmanship and noiseless. All sugar-cane bagasse is automatically carried out by steady belt conveyor, thus cost of handling labor is surprisingly reduced by half or less. The pumping system is perfect that sugar-juice is conveniently carried out to Boiling Pan without any loss, and this also eliminates labor cost.

'K' and 'KR, Type Mill: There are very small and powerful machines of the latest type which are driven by 6 - 8HP diesel engine, and can be used in small scale factories which produce about 1 ton of black sugar from 8 tons of cane in 24 hours operation. It is also suitable for domestic and small co-operative societies. It is quite a portable and be used in the remote location of any country.

'A' and 'AR' Type Mill: Have perfect construction as a small type, and is popularly used. It is driven by a Diesel Engine of 15 - 16 HP, and can produce about 2 tons of black sugar from 15 tons of canes in 24 hours operation. It is most suitable for local factories.

"CeCoCo" Sugar Cane Mill  
Type 'AR'

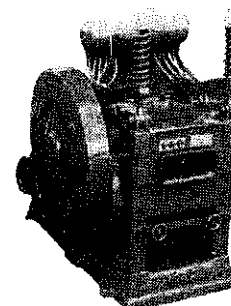



**Black Sugar Making:** For refining the sugar-juice into black sugar, it is most recommendable to build the fire brick kiln for condensing the sugar contents to the higher percentage because it will pay as small industry in rural districts by adapting our 'grate arrangement', as it will save a considerable amount of fuels by utilizing bagasse (cane waste) as fuel. This is an ideal plant for lowering production cost of black sugar.

White Sugar Making Plant — Minimum cane treating quantity is 500 tons per day (1,500 tons per day for economical basis) or 50 tons per day of brown sugar. Write to "CeCoCo" for detailed information.

Specification of "CeCoCo" Smaller Sugar Cane Mill

Type	Number of Rolls	Power Req'd	R. P. M. of Main Shaft	Capacity in 24 hr.	Extract Yield	Floor Space	Net Weight	Ship'g Meas't
K	Cast Iron 4-pcs Rubber 1 pc.	6-8HP	12 - 15	6- 8 ton	85%	32" x 39"	500 kg	30 cft
KR	Cast Iron 1 pc.	6-8HP	12 - 15	6- 8 ton	80%	30" x 36"	400 kg	28 cft
A	Cast Iron 4 pc. Rubber 1 pc.	15 - 16 H P	13 - 15	10-15 ton	85%	42" x 49"	1200 kg	50 cft
AR	Cast Iron 4 pcs.	15-16HP	13 - 15	10-15 ton	85%	38" x 47"	1000 kg	50 cft

"CECOCO" SMALL BLACK SUGAR MILL WORKS EXTREMELY WELL

Mr. J. J. vander Goes, F. A. O. Marketing and Processing Officer has installed "CeCoCo" Small Sugar Mill Type 'AR' at Apia, Western Samoa with diesel engine which did extremely well, and has found trials in black sugar making promised excellent results as picture shows.

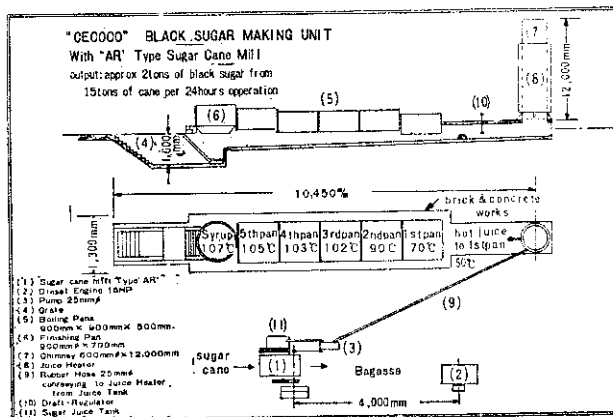

SUPPLY OF TANK AND BOILING PANS FOR BLACK SUGAR REFINING

Having found the combustion heat of the fuel is escaping through chimney, Mr. J. J. vander Goes in Samoa has succeeded in correcting this shortcoming by building a tank around the chimney for preliminary juice-heating and also for the boiling pans by a special arrangement which is common and the material especially of the finishing pan is mostly copper in every stage of "big scale sugar making" in the countries like Java. The chimney of lighter material of 1/4"t plate will do, since a heavy chimney, to be put up by a crane, might be very inconvenient.

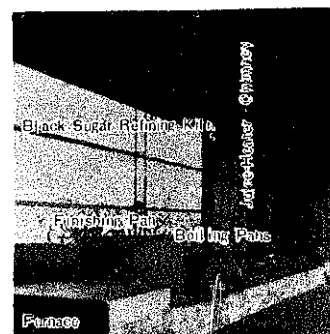

"CECOCO" HAND SUGAR CANE SQUEEZER

This is a small type of Sugar Cane Squeezer and can be operated by hand or by 1/2 HP power. It is very handy to be used individually where the sugar cane is available as it can be easily crushed and squeezed for home consumption, and also can be adapted for small industry for selling the sugar juice at the street stalls. This will quite a good income to those who sell fresh sugar-juice. The Sugar-cane is squeezed by 3-rolls.

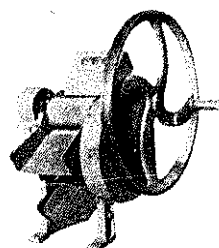

Specification of "CeCoCo" Hand Sugar Cane Squeezer

Type	Capacity per hour	Power Req'd	Size of Roll	Dimension in mm			Net Weight	Gross Weight	Ship'g Meas't
				Height	Width	Length			
B	115 kg.	Hand	3" x 5 1/8"	515	430	510	40kg.	65kg.	10 cft
	160 kg.	1/2HP							

FISH PROCESSING MACHINERY

"CECOCO" FISH-MEAT-CAKE (BOILED FISH PASTE) MAKING MACHINES

In Japan, a well prepared fish-meat-paste mounted on a small piece of wood, steamed and baked ready for table is called 'Kamaboko'. It has a fine flavour, indeed. The process of the said 'Kamaboko' is as follows:

1) Fish Washing Machine Type 'B' ;

Wash the fresh fish with a clear water by Fish Washing Machine.  
Specification —

Overall Height .....	1,320 m/m
Overall Width .....	1,300 m/m
Overall Length .....	720 m/m
Power Required.....	1/2 H. P.
Revolution .....	120 r.p.m.
Net Weight .....	180 kgs.
Gross Weight .....	300 kgs.
Ship'g Measurement .....	80 cft

"CeCoCo" Fish Washing Machine

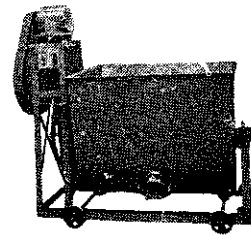

2) Fish Meat Extracting Machine Type No. 5 ;

After washing the fish, a Fish Meat Extracting Machine will extract the fish meat out by separating from bones and skins. The meat is put into Tank with a clean water and drain out the water after exposing the meat. Then, the moisture and oil contents remained in the meat are extracted by a Press.

Specification —

Overall Height .....	1,300 m/m
Overall Width .....	950 m/m
Overall Length .....	650 m/m
Power Required.....	1 H.P.
Diameter of Screen .....	175 m/m
Revolution .....	130 r.p.m.
Capacity .....	300 kg. per hour
Net Weight .....	235 kgs.
Gross Weight .....	300 kgs.
Ship'g Measurement .....	50 cft

"CeCoCo" Fish Meat Extracting Machine

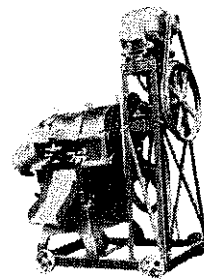

3) Fish Meat Chopping Machine Type No. 42 ;

Mince already extracted meat by a Fish Meat Chopping Machine.  
Specification —

Overall Height .....	450 m/m
Overall Width .....	320 m/m
Overall Length .....	850 m/m
Power Required.....	1 H.P.
Revolution .....	160 r.p.m.
Capacity .....	200 kg. per hour
Net Weight .....	200 kgs.
Gross Weight .....	300 kgs.
Ship'g Measurement .....	40 cft

"CeCoCo" Fish Meat Chopping Machine

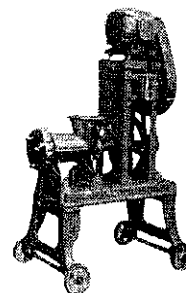

4) Fish Meat Grinding Machine Type No. 11;

Grinding the minced meat into paste by a Fish Meat Grinding Machine.

Specification —

Overall Height .....	1,500 m/m
Overall Width .....	800 m/m
Overall Length .....	1,500 m/m
Size of Container .....	665mmφ x 320mm depth
Capacity of Container.....	78 litres (135 litres with frame)
Grinding Capacity.....	68-75 kg./charge
Power Required .....	2 H.P.
Revolution .....	70-80 r.p.m.
Net Weight .....	560 kgs.
Gross Weight .....	700 kgs.
Ship'g Measurement .....	80 cft

"CeCoCo" Fish Meat Grinding Machine

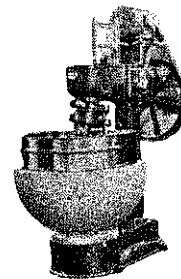

5) Fish Paste Mounting Machine Type No. 12;

Fish Paste Mounting Machine is to attach a required quantity of the fish paste on a wooden board, and the quantity can be adjusted as required by a handle and also by replacement of metallic mould.

Specification --

Capacity of Tank.....	14 & 5 litres
Capacity of Wooden board in guide: ---	65 pcs. of 9mm thickness
Mounting Capacity.....	1,000 pcs. per hour in 200gm cake
Adjusting Range of wooden board: —	
Length.....	120~180mm
Width .....	40~65mm
Thickness .....	6~18mm
Adjusting Range of Fish-paste: .....	100 to 400 grams
Net Weight .....	470 kgs.
Gross Weight .....	650 kgs.
Ship'g Measurement .....	80 cft.

"CeCoCo" Fish Paste Mounting Machine

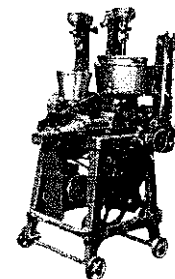

6) Steam Cauldron Type No. B;

The fish paste mounted on wooden board is then steamed in the stainless box by Steam Cauldron, thus a fish cake is produced.

Specification —

Construction .....	Iron sheet made
Dimension: .....	
Height.....	760 m/m
Dia. of Body .....	465 m/m
Dia. of Chimney.....	125 m/m
Sub Tank .....	320 x 320 x 290 m/m
Net Weight .....	140 kgs.
Gross Weight .....	250 kgs.
Ship'g Measurement.....	20 cft.

"CeCoCo" Steam Cauldron

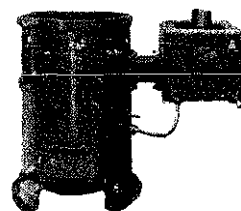

"CECOCO" FISH SAUSAGE MAKING MACHINE

1) Fishmeat Mixer;

This machine is used for mixing the fish meat paste already ground by Fish Meat Grinding Machine.

An even mixing can be obtained by the stainless steel made mixing blades which were specially designed by our company for a high-efficiency operation.

The stainless steel tub is specially welded to make it absolutely trouble-free and sanitary.

Ranging 30 kg., 50 kg., 75 kg., and 120 kg. in capacity per knead or charge.

"CeCoCo" Fishmeat Mixer

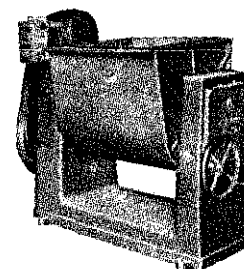

2) Fish Sausage Stuffer ;

The unique design and construction which characterise our new stuffer make it an ideal machine for stuffing sausage by screw and spiral roll. Equipped with Cooling Jacket.

- Capacity of Hopper..... 18.5 kg.
- Casing Capacity ..... 1,000 pcs./hour
- Power Required ..... 1 H.P.
- Overall Height ..... 1,440 mm
- Overall Width ..... 450 mm
- Overall Length..... 920 mm
- Net Weight ..... 210 kg.
- Gross Weight ..... 270 kg.
- Measurement ..... 40 cft

"CeCoCo" Sausage Stuffer

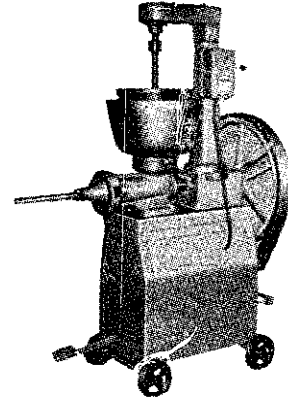

"CECOCO" FISHMEAL PLANT

In treating large fishes such as tuna, cod-fish, etc., it is required to cut and crush them into smaller pieces by Fish Cutter and Roll Crusher, and then to feed into a Cooker by a Bucket Elevator for cooking process. In dealing with relatively small fishes, i.e., herring and sardine, etc., fishes are fed into the Cooker directly through the Bucket Elevator without putting through the said cutter and crusher. After the cooking process, they are discharged from the end of the machine and pressed by Screw Press for separating fishmeal-press-cake from oil and water. While the oil and water are transferred to the fish-oil processing shop for extracting fish-oil, the pressed cake is conveyed by Screw Conveyor to a Crusher for crushing. From the crusher, the crushed meal is delivered through Screw Conveyor to Rotary Dryer where they are dried. While the meal is being conveyed by Bucket Elevator to Disintegrator, they will be cooled off in the air. The disintegrator reduces the meal into fine powder to the required meshes. The fishmeal powder is then blown by means of Blower through Cooling Pipe to the Packing Room where the finished product is packed after being accumulated in the Dust Collector.

The table at right represents the results of analysis of the products processes by "CeCoCo" fishmeal plant. It is particularly shown the substantial and valuable protein contents.

From past experiments, it was well recognized that domestic animals such as milk cow, store cattle, pig and poultry showing remarkable results of quicker and better growing by giving rich fishmeal fodder which contains protein and phosphoric acid which are produced by this plant.

For feeding chicken in poultry-farms, the fishmeal fodder is the most suitable. It may be difficult to have chicken grow perfectly without giving the fishmeal. In addition to such advantages as above, cattles such as milk cow and pig also require this kind of fodder because it is available at very low cost.

Remarks:— When you make enquiries of fishmeal plant, please inform us the following data to determine the most suitable model for your requirements:

- 1) Kinds of raw material (Name of Fish)
- 2) Capacity to be required
- 3) Operation hours per day
- 4) Climate condition where the plant is to be established
- 6) Electric power supply and details
- 7) Other details

Particular	A	B	C
Water content	7.33%	4.10%	5.3%
Oil	7.37%	7.17%	6.62%
Nitrogen	10.51%	10.26%	10.00%
Phosphoric Acid	7.18%	7.62%	7.04%
Salt	0.87%	0.35%	—
Sand	0.39%	1.36%	—
Isolated Fatty Acid	1.24%	1.37%	0.42%

Flow Chart of "CeCoCo" Fishmeal Plant

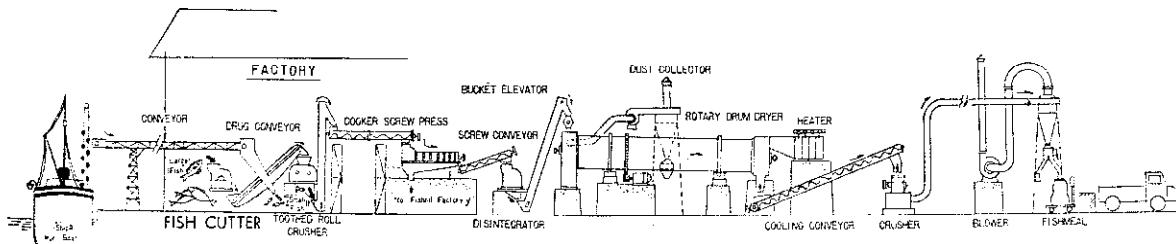

"CeCoCo" Standard Fishmeal Plant

Model No.	R-10	R-15	R-25	R-50	R-100
Capacity per 24 hours operation in raw fish	10 tons	15 tons	25 tons	50 tons	100 tons
Finished fishmeal	2 tons	3 tons	5 tons	10 tons	20 tons
Total Power Required	35 HP	42 HP	53 HP	75 HP	108 1/2 HP
Req'd Quantity of Steam	300 kg/h	500 kg/h	800 kg/h	1,500 kg/h	3,000 kg/h
Area of Factory sq. mt.	508 m <sup>2</sup>	532 m <sup>2</sup>	632 m <sup>2</sup>	844 m <sup>2</sup>	948 m <sup>2</sup>

"CeCoCo" Fishmeal Plant

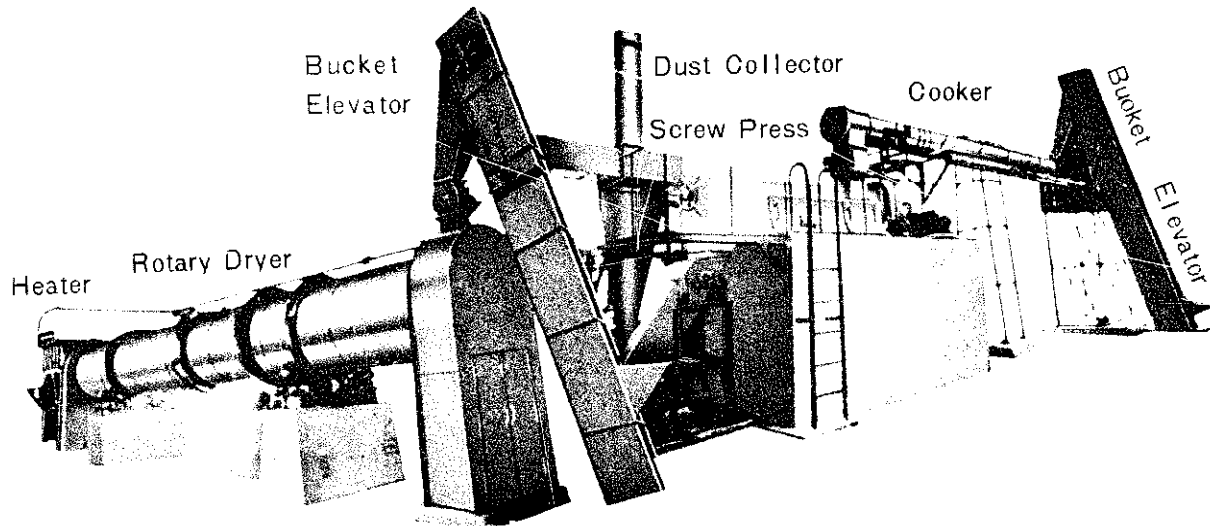

"CECOCO" FISH DRYER

- 1) Ventilation is more than enough and uniform ventilation is ensured.
- 2) Preliminary drying can be freely made which prevents the materials becoming steamy or scorched during the drying.
- 3) Hot air generator is used and direct-flame-gas will be exhausted outside through the chimney. Absolutely free from fire and the materials will never be infected with the smell of heavy oil.
- 4) Temperature, wind force, quantity of circulating hot air can be freely adjusted depending upon the kinds of fish and miscellaneous conditions.

SPECIALITIES

- 1) A large quantity of materials can be continuously dried.
- 2) With the process, the most suitable condition for drying is given
  - 1st process: Preliminary drying by normal temperature and big wind force.
  - 2nd process: Drying by hot air of low temperature.
  - 3rd process: Drying by hot air of high temperature.
- 3) The hot air will blow upon the surface of the materials placed on the transfer car only and no waste of hot air is left.
- 4) The speciality of this dryer is this that the most suitable drying method can be taken according to the kinds of materials and operation cost or other expenses can be minimized to the least.
- 5) Transfer car is so easy and operation of whole unit is completely easy handling.
- 6) Heavy oil or steam is used as fuel and fuel consumption is so economical.
- 7) Transfer car can also be automatically moved from place to place as occasion requires by the time switch at any time.
- 8) Applicable for raw laver, sea weeds, shellfish, etc. (sea products) or agricultural products such as vegetable, fruits, et.

### Arrangement of "CeCoCo" Fish Dryer Model FH-4 with Pre-Dryer Model FN-4

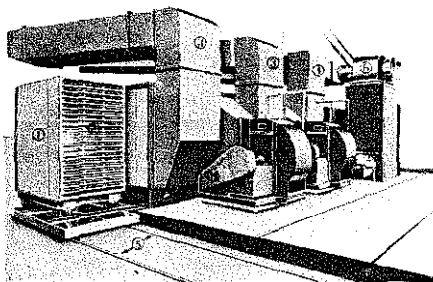

- Unit in mm
- 1) Transfer Car
  - 2) -do- with Fish Tray
  - 3) Pre-dryer Model FN-4
  - 4) Dryer Model FH-4
  - 5) Rail
  - 6) Blower
  - 7) Oil Burner
  - M) Electric Motor

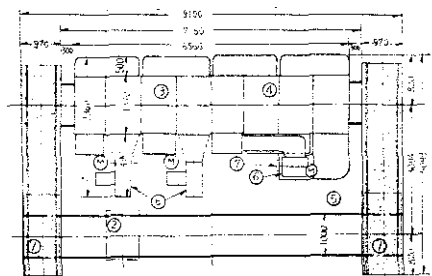

### "CECOCO" FRUIT AND BULB ASSORTING MACHINE

— For Citrus, Onions & Potatoes etc. —

5 pieces of hollow drums made of multi-holed vinyl boards are attached on both sides of an iron ring which is maintained by Rollers. If the rotation is given to the V-pulley to the marked direction by V-belt, the citrus will be carried on at a low speed to the marked direction. And when they reach the position of Rollers, those having bigger sizes than the holes will be expelled out by Roller. While small sizes will pass through the holes and will be expelled out through the funnel. The specific feature of this machine is the method of arrangement of these Drums, and it ensures a highest efficiency for which a patent was accorded. This machine classifies the fruits and bulbs into 6 grades or sizes, by means of hollow drums. The Type "B" are equipped with elevator.

"CeCoCo" Fruit and Bulb Assorting Machine Type A

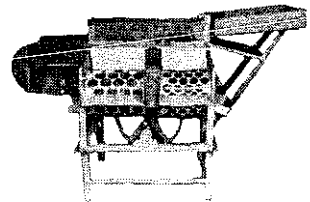

#### Specification of "CeCoCo" Fruit & Bulb Assorting Machine

Type	Capacity per hour	Power Req'd	Revolution of Drums	Dimension in mm			Net Weight	Gross Weight	Ship'g Meas't
				Height	Width	Length			
A	max. 3 ton in citrus	1/4 HP	15 r.p.m.	1,300	1,020	2,000	90 kg.	135 kg.	90 cft
B	—do—	1/4 HP	15 r.p.m.	1,380	1,200	2,900	140 kg.	255 kg.	145 cft

### "CECOCO" FRUIT JUICE EXTRACTING PLANT

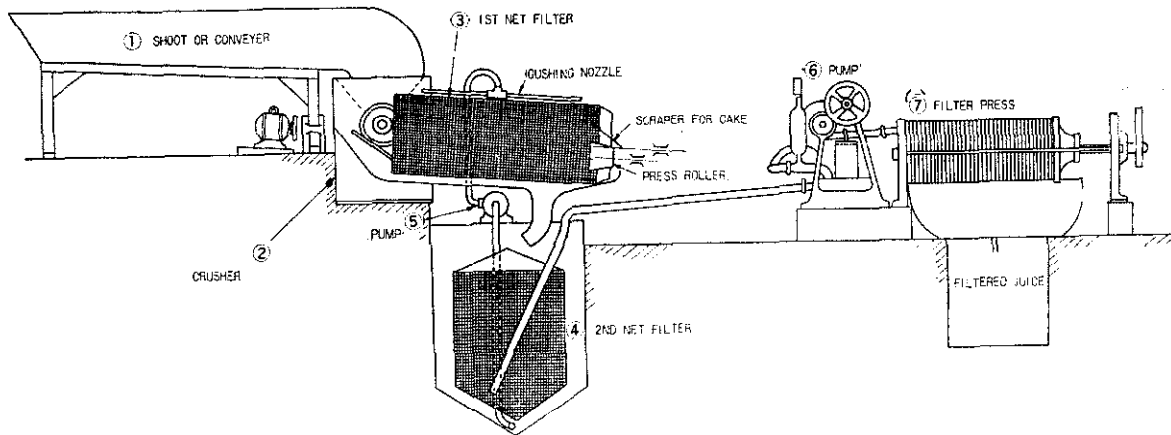

# COTTON PROCESSING MACHINERY

## "CECOCO" COTTON GINNING MACHINE

The cotton ginning machine consists of a revolving hide-coated roller, a doctor knife and a beater blade which perform ginning the cotton and deposit the finished product in the foreground and separate seeds aside.

- 1) "CeCoCo" cotton gin has a wide and versatile methods of processing different kinds of cotton regardless of their staple lengths. As anyone in cotton business knows there is wide range of differences in fibre, the length of fibre and tensile strengths, but they do not effect the "CeCoCo" machines' performances, because the blade and knife of the gin can be adjusted at the most suitable position in accordance with fibres to be ginned.
- 2) "CeCoCo" cotton gin releases cotton seeds that are most convenient for expelling cotton seed oil. It is a well known fact that a large quantity of lint remaining on the seeds always create troubles in oil expelling; but with "CeCoCo", lint remaining on those ginned seeds is kept at the lowest possible quantity, and this attributes to a great convenience in oil expelling.
- 3) Special action of hide-coated Roller always performs at its best. Stripped buffalo hides that are wound on ginning roller is a decades of our experiments and has superb utilities with highest efficiency which surpass any other substitutes. Whenever hide-coating shows wears by friction, there will be slight deviation of roller shaft toward the knife, and this keeps the ginning performance at the best and will last until friction wears out almost of all thickness of the hide.

"CeCoCo" Cotton Gin

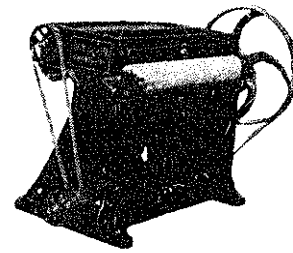

Specification of "CeCoCo" Cotton Gin

Type	Capacity per hour	Power Req'd	Revolution	Size of Roller	Dimension in mm			Net Weight	Gross Weight	Ship'g Meas't
					Height	Width	Length			
A	70 kgs. of pick cotton	1 HP	500-550rpm	38" x 5 1/4"	1120	970	1070	220kg	300kg	50 cft
B	15 to 20 kg. pick cotton	Foot 1/2 HP	60 or 600rpm	14.5"	890	840	915	110kg	180kg	25 cft

## "CECOCO" COTTON DELINTEr

The Cotton-Seed which is discharged from the Cotton Gin or Saw Gin has numerous linters (fibres) attached to its husks, so that prior to expelling oil, this husk must be separated from the kernel to obtain the most efficient oil extraction.

The "CeCoCo" Super Delinter not only performs the separation thoroughly, but also separates a part of the linters from the husk simultaneously.

Thus three kinds of end-products will be discharged from separate outlets of this machine, and these end-products are the oily kernels, slightly lintered husks, and a good part of the total linters present. If the lintered husks obtained after the first running and again passed through the same machine, the separation between husks and linters will be much better. When Cotton-Seeds Oil Mill is equipped with this machine, it will be able to obtain the kernels which have oil content of more than 30 %, and therefore they could be utilized as raw material for extracting oil. In this case, the efficiency of extracting oil would be much higher than the unhusked kernels. Furthermore, the oil-cake obtained in this processing retains higher value as a fertilizer and cattle feed. 95%-98% husking efficiency can be obtained.

"CeCoCo" Delinter

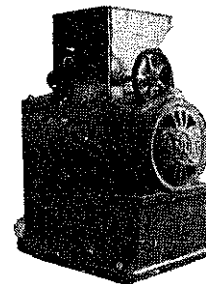

Specification of "CeCoCo" Cotton Delinter

Type	Capacity per hour	Power Req'd	R. P. M.	Net Weight	Gross Weight	Ship'g Meas't
A	100kg.	3HP	1,700	134 kg	195 kg	21 cft
B	250kg.	7.5HP	1,500	263 kg	365 kg	32 cft

- a) Hourly Capacity refers to amount of ginned cotton-seeds.
- b) Generally the weight of kernels occupies about 55% of total weight of cotton seeds.

## "CECOCO" ABSORBENT SURGICAL COTTON MAKING PLANT

This plant produces Absorbent Surgical Cotton from raw cotton and also from waste cotton. A plant to produce 800 lbs. in 8 working hours per day is the most economical unit.

### THE MANUFACTURING PROCESS OF ABSORBENT SURGICAL COTTON

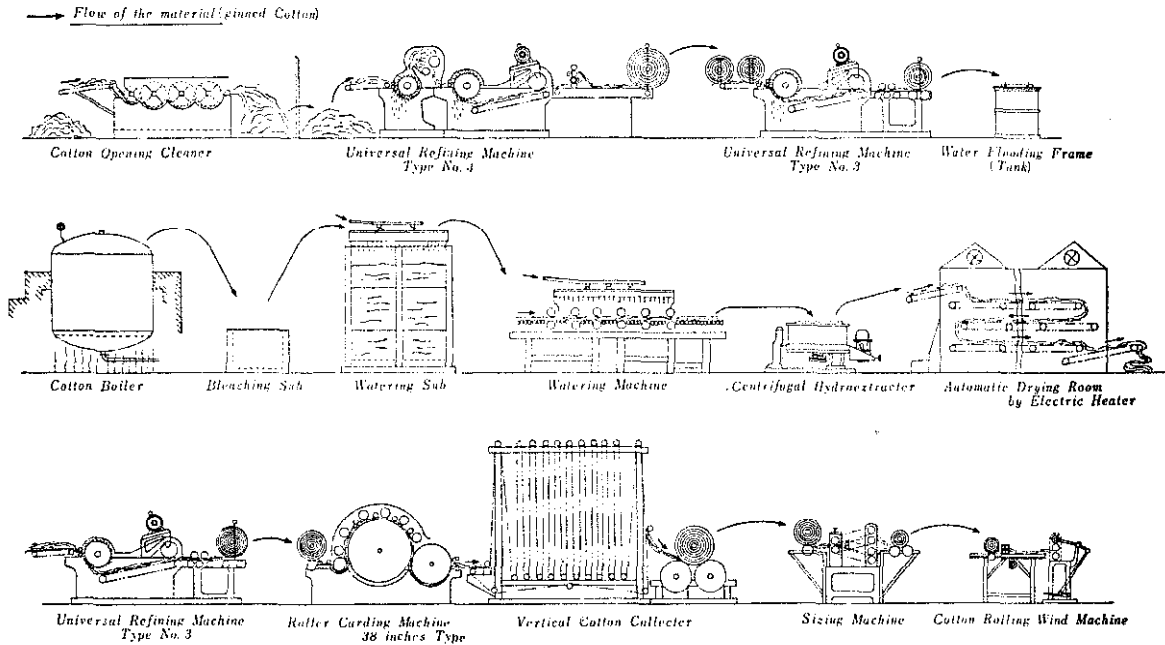

- 1) **COTTON OPENING CLEANER:** This machine is used to unravelling pressed, packed and ginned cotton in bale (seedless cotton) and at the same time to eliminate foreign matters containing for convenience to refine and bring up the efficiency of Refining Machine. Daily Capacity is 1,000 lbs. per 8 hours. Power Required 1 H. P.
- 2) **COTTON REFINING MACHINE TYPE NO. 4:** This machine is a combination of Rough Beater and the Finishing Machine. It has a special 'grid bar' which helps to further remove foreign matters. Daily Capacity is 530 to 880 lbs. per 8 hours. Power Required 3 H. P.
- 3) **COTTON REFINING MACHINE TYPE NO. 3:** This machine is to be used for further refining the product after finished with the above Type No. 4 machine into 'Lap Cotton'. It is also required for use just before the cotton is put into the Carding Machine, and it makes uniform lap cotton belts. Daily Capacity is 530 to 880 lbs. per 8 hours. Power Required 3 H. P.
- 4) **WATER FLOODING MACHINE (TANK):** The materials refined by the previous process are to be put into a flooding tank to absorb water thoroughly. This process enables product to easily be baled and step up the required job. The quantity of water required is about 15 liters to 20 kgs. of cotton. Daily capacity is 1,000 lbs. per 8 hours.
- 5) **COTTON BOILER:** This boiler is exclusively made for the important part-extracting oil part from cotton in the process of absorbent cotton. This boiler is equipped with a safety-valve and pressure gauge, and either coal or firewood can be used as the fuel. Daily capacity is 400 lbs. per 8 hours.
- 6) **COTTON WASHING MACHINE:** The most important point in the process of absorbent cotton is 'water washing'. The cotton should be treated by this machine and then it will be very hygienic and finished absorbent cotton will not change in quality and colour. Those water-drops from the numberless pin-holes of the plain type basin of this machine make the finished cotton advance on the small roll, and the water is wrung out by pressing intermittently on the large roll. When the cotton advanced further more in front, the process is finished. Power required is 1 H.P.
- 7) **CENTRIFUGAL HYDRO-EXTRACTOR:** The washed cotton is to be removed to the drying room after eliminating water thoroughly, otherwise it takes a long time for drying. This machine serves the purpose speedy in short time. Daily Capacity is 1,000 lbs. per 8 hours. Power required is 5 H.P.
- 8) **ROLLER CARDING MACHINE 38" TYPE:** This machine is used for the production of absorbent surgical cotton and thin refining cotton-specially possible to produce thin and perfect sanitary pad



cotton etc. It is possible to use fallen cotton in the spinning mill and short cotton fibre combined to finish up in good quality. It is equipped with 'Varnishing Roller' to increase the efficiency, and to be able to produce good quality cotton. The diameter of cylinder is 38" and the diameter of doffer is 24". Daily capacity is 160 lbs. per 8 hours. Power required is 2 H.P.

- 9) **VERTICAL COTTON COLLECTOR**: The cotton comes out of Roller Carding Machine is automatically collected to this machine. The collecting belt of this machine is revolving at all time. The thin layer of cotton flows on the surface of this belt will be automatically cut when it reaches a certain required thickness. And then, removes the same to a lap table for preparing 'Lap Cotton'. This 'Lap Cotton' is about 180 to 190 feet in length.
- 10) **COTTON CUTTING AND ROLL-WINDING MACHINE**: This machine allows a cotton belt to be cut by Size-Cutting Machine in the size and width required. After this, rolled Absorbent Surgical Cotton is completed by Roll-Winding Machine, which is able to wind 36" width cotton belt. The Rolled Absorbent Surgical Cotton is cut at appropriate size by a circular knife of band knife. The total length can easily be controlled by this machine.

### "CECOCO" GARDEN AND ORCHARD TOOLS

"CeCoCo" Garden & Orchard Tools

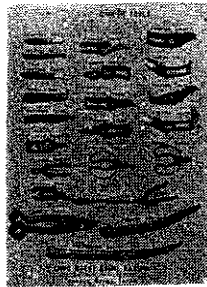

"CeCoCo" Garden Tools Set

1. Trowel
2. Transplanter
3. Hand Cultivator
4. Rake
5. Fork
6. Weeder
7. Hoe & Rake
8. Hoe



### "CECOCO" PORTABLE CUTTING SAW (POWER SCYTHE CUTTER)

The "CeCoCo" Cutter-Scythe is powered by a light weight gasoline engine of 1.2 HP which is designed to shoulder or knapsack. It is very convenient for:

- a) Mowing grasses at orchard, fields, slopes, hill and cutting rice, wheat stalks.
  - b) Cutting sugar-cane, bamboo, twig, grove, small tree and bush etc. at fields, forests and hillsides, etc.
- It executes a work with 10 to 15 times quicker than hand cutting by a sickle or reaping hook. Its capacity is 5 to 15 ares per hour according to the planting and growing condition.

When overloaded by hitting stones or other obstacles, the circular blade automatically stops rotating without affecting the revolution of the engine. When released from overload, the circular blade starts its performance again.

The speciality of this cutter is this that the engine is separately and independently suspended by unique design, as that vibration and heat of the engine does not affect the operator's health, and as the result, the machine can comfortably be operated for a long period of time giving no fatigue.

The engine is 'TAS' brand J-12 type Single-cylinder 2-stroke/cycle Air-cooling type gasoline engine: Output 1.2HP/4,500rpm; Cylinder 33mm $\phi$ ×38mm stroke and 37cc; Fuel consumption 0.5kg. per hour; Hand rope starting.

Used throughout the world for rice and wheat plants cutting, brush clearance and control in maintenance of timber stands, coffee, fruit and rubber plantations, pipelines, transmission lines, highways, rail-roads, airports, public parks, etc.

Model BC-20

Straight Shaft driven Shoulder Type

Dimension in mm :-  
1700×540×380  
Size of Blade :-  
255 mm in dia.  
Revolution :- 2,700 rpm  
Weight :- 11kg.  
Engine is directly fixed  
on driving-shaft.  
Ship'g Meas't- 7 cft.



Model 'K'

Flexible Shaft drive Knapsack Type

Dimension in mm :-  
1,800×350×220  
Size of Blade :-  
230 mm in dia.  
Revolution :- 4,000 rpm  
Weight :- 10 kg.  
Engine is freely movable  
to any direction.  
ship'g Meas't :- 3 cft.

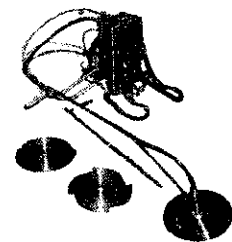

## "CECOCO" CIRCULAR WIRE BLADE FOR POWER CUTTER AND SCYTHE

A special material of piano wire is inserted into a disk and fastened by bolts, and this blade can be attached to the various types of power scythe.

- 1) This circular wire blade does not require any of sharpening during operation.
- 2) If the conventional saw blade wears, the whole blade was to be replaced. With particular this circular blade, the piano wire will only wear and the blade can be used 3 times if the piano wire is pulled stretch by loosening the bolt. If piano wire wears completely, it can be replaced at once without any difficulty.
- 3) The blade will not be heated even after a long operation by special cooling device and the sharpness will never change at all times.
- 4) The piano wire is special heat-treated and never broken.

## NEWLY INVENTED "CECOCO" PORTABLE ELECTRIC CUTTER

for cutting grass, bush, sugar-cane, bamboo, tree branches etc.

### Main Features :

1. The motive power of this particular Portable Cutter is electricity. So that it is operated by connecting cord to your home light socket. Otherwise, in case such power is inaccessible, you can operate by getting power from a small light and compact gasoline generating set herein described. which can easily be carried around any place where work is done.
2. Due to the light in weight, the operation and handling are very easy giving no fatigue to operator. Cutting and mowing on slope of hill-side dose not take much labour and is easily and smoothly done.
3. Vibration, noise and weight are very much less as compared with so-called other portable power cutter or scythes equipped with gasoline engine, so that even women and young folks can handle safely.

"CeCoCo" Portable Electric Cutter Model FC-2

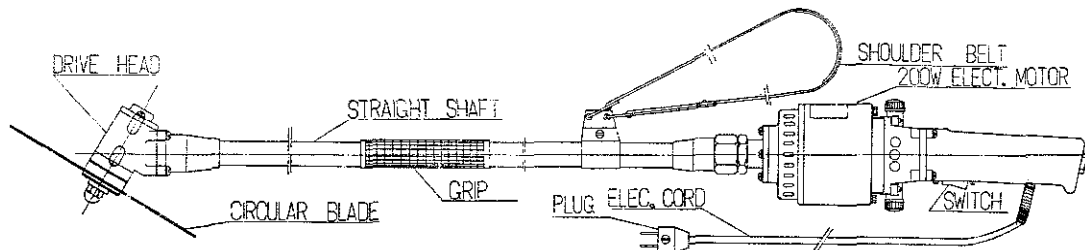

### Specification of "CeCoCo" Portable Electric Cutter

1. Type..... This portable cutter is driven by 200W electric motor cutting and mowing weeds, grass, bush, sugar-cane, bamboo tree branches etc.
2. Construction ..... It is composed of main parts of electric motor, straight shaft and driving head. Overall length with circular blade 1,720mm, Overall width at electric motor part 94mm, Net weight with circular blade 4.9kgs.
3. Circular Blade ... Two kinds, one Cutting Circular Saw 203mm dia. 70-teeth and another Grass mowing circular blade 230mm dia. 8-teeth. Reduction ratio of revolving speed 23:16.4.
4. Electric Motor ... Single-phase commutator motor, Output 200Watts/12,000RPM, 100Volts, 3.5Ampere (standard), Input 350VA (standard), Rotator 40mm in dia. Core thickness 41mm, Forced air ventilation cooling type.
5. Packing ..... Each set of Portable Electric Cutter packed in carton box consisting of electric motor, straight shaft with drive head, Cutting circular saw, Grass mowing circular blade, 30m electric cord with plug, Shoulder belt and Spanner. Net Weight 6.9kgs., Gross weight 8.5kgs., Measurement 2cft.

Advantage and usefulness of small, light and portable compact gasoline generating set: It can be utilized for lighting purpose and many other routine works as an independent and reliable portable small power source.

### Specification of Portable Gasoline Generating Set Model EPG-100:

"TAS" Air-cooled gasoline engine model P-72, Single cylinder 2-cycle type, 0.8P.S./6,500R.P.M. with recoil starter, Replacement volume 50mm bore×30mm stroke 22c.c., Fuel tank- 1.6 litres for 1.8 hours continuous operation on loaded, Net weight 8.4kgs., Gross weight 9.8kg., Measurement 1.5cft., Packed in carton box.

## “CECOCO” POWERED TEA-LEAVES PICKING MACHINE

The trend in Japan through the years is an increasing tea-leaves production while picking labour force is becoming very short. This fact had led tea growers and equipment manufacturers in Japan to think an adaptation of mechanical picking methods. It is currently started as the evaluating and developing economical equipment related to the long-hoped mechanization of tea-leaves picking. “CeCoCo” has finally succeeded in turning out the most ideal machine.

From the severe experiments in the field for tea processing and preparation for drink, it is proved that the grade of tea thus picked is becoming much higher than by hand and scissor picking and is now successfully adapted in picking so called “Ceylon Tea” or “Red Tea” at Makurazaki, tea growing village, in the southwestern part of Kyushyu Island in Japan. The tea leaves which were picked by the machine will not leave the black spot but very fine same as they were picked by hand and scissors, so that it will not give any damage to the buds of tea tree and thus picked tea can well stand for storing. It can easily be used by women and young folks even the school children.

“CeCoCo” Units exactly answer such purposes, so that you will understand how it is operated conveniently, economically and easily by performing the 10-labourer work by only one operator. The blades can be adjusted by screws to set them in proper position when worn out. One of the tea growers has used for 5 succeeding tea picking seasons in Japan: first picking season begins at the end of April and 2nd, 3rd & 4th about 40 days thereafter consecutively and another in the autumn, and reaped 9100 lbs. of tea leaves for a whole season successfully without any troubles of the machine.

It is made of a special metal throughout and durable powered by a very small and light 2-cycle gasoline engine; total weight approx. 8 kgs. only.

The blades are made of special steel preventing the tannin of tea to blunting the sharp edges. The leaves picked with this machine, whether crude or processed, sell at a higher market price than those sheared or hand-picked. It can also be used as Grass-and-Shrub mower and rice plant cutting by attaching a special cutting attachment instead of tea picker blade with extra cost.

Tea-Picker  
with Engine

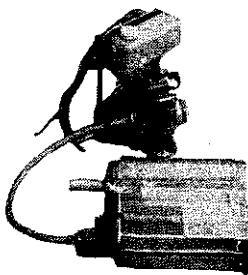

mower  
attachment



Specification

Commodity	Tea Picker Type 'S'	Mower Type 'L'
Blade	330 mm in length	255 mmφ×40-teeth, 1.4 t
Revolution	850-recipro., 4500 rpm	4,500~700 rpm
Weight	2 kg.	3 kg.
Flexible Shaft	8 mm in dia.	9 mm in dia.
Capacity	30-50kg. per hour	13 ares per hour
Engine	Single-cylinder, 2-stroke/cycle, Air cooling type Gasoline engine; Output-1.0 HP/7,500 RPM; 25 cc; Hand rope starting (can be attached recoil-starter with extra cost); Fuel Tank 1.8 L	

## “CECOCO” POWERED TEA-LEAF PLUCKING AND TEA-FIELD SUPERVISING MACHINE

1. This machine is equipped with a 6-10 HP riding type 2-wheel tractor for plucking the tea-leaves and supervising over the tea-field.
2. Operation can be done while riding on the machine with no fatigue. And only necessitates a driver and picking helper.
3. Operation is safe in the tea-field without damaging the plants due to the special skirt cover.
4. The adjustment of driving and plucking blades are very easy and the appearance of tea trees when picked is very beautiful.
5. The plucked leaves are automatically sacked into bags and save the labour. Manipulation of leaves receiving bags is simple and convenient for transport. After some 30 kg. leaves is sacked, take out the bag and leave it in the tea-field tying up the mouth and replace with a new bag.
6. The machine will completely collect the leaves by a special device and the leaves will never be left or scattered in the field.
7. Operation for plucking can be accomplished even in the inclined tea field some 10°, as the whole machine can be lifted up by the oil pressure jack attached.

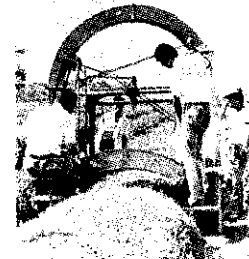

8. According to the width of tea plants, the wheel tread is freely variable by spline, shaft with gutter and pipe etc.
9. The tea-picking at the skirt of plants can be made at the same time by using the skirt spread trimming attachment can be processed with 30 times of output capacity and speed.
10. The depth-pruning is also possible by using the deep-pruning attachment at the same speed with an ordinary tea plucking capacity.
11. It is very easy to cut the leaves from the roots or middle with the special attachment and no fatigue (If the back cutting is made, the new spout will come out).
12. The soil space at the both sides are minimum (less than 2.5 m) for a large type machine, as the machine can be turned to the sharp angle. The good quality of tea can be plucked, as the picking is made by clipper blade.

Specification of "CeCoCo" Power Tea-leaf Plucking and Tea-Field Supervising Machine

Type of Tractor can be attached .....	6-10 HP Riding type 2-wheel tractor
Overall Length .....	2,700 mm
Overall Height .....	2,400 mm
Overall Width .....	depending upon row or ridge spacing,
	In case 1.8 m ridge spacing, outer side 2.32 m inner side 1.25 m.
Minimum Turning Radius .....	depending upon headland and
	In case of 1.5 m ridge spacing, right turn 2.20 m, left turn 1.85 m
	In case of 1.8 m ridge spacing, right turn 2.45 m, left turn 2.15 m
Tea-leaf Plucking Blade .....	Arch shape Clipper type blade, 1.0 m
Height of Tea-plant can be plucked .....	0.35-1.50 m
Plucking Capacity .....	5-7.5 ares per hour (1,300 kg. per day)*
Plucked leaves Receiving Method .....	Automatic sacking (30 kg. per bag) by conveyor and fan (blowing thrower)
Special Attachment Spread plucking .....	approx. 8 ares per hour, 0.3 m in width
Deep Pruning plucking...	5-7.5 ares per hour, max. 8 mm of plant
Pruning capacity .....	3-5 ares per hour,

"CECOCO" POWERED BARROW (UNIVERSAL ROTOR)

The "CeCoCo" Power Barrow is a small almighty rotor equipped with 2-3HP 4-cycle Air-cooled Gasoline Engine, and used as the portable power source for routine works.

- 1) This machine not only powers the barrow for the works, but also is used as a good tracting power on a slope as well.
- 2) This machine is equipped with the dump-bucket of the load with stand, so that it can be used in conveyance within the compounds of the factory and the storehouse.
- 3) The attachment for all kinds of farming equipments such as the cultivator, mulching rotor, weeding rotor, ridger, small plough and levelling rotor with rake can be installed at ease.
- 4) This machine also functions perfectly as sprayer when equipped with a tank-set on it.
- 5) With the mowing attachment installed in the front, it becomes the cheapest independent power mowing machine.
- 6) With the small trailer installed, it becomes an efficient small conveyance with the load at the front and the back.
- 7) As it equipped with an brake, it can be used on the hill side and slope without anxiety.

Specification of Standard Powered Barrow equipped with 2-3HP Gasoline Engine and Dump-bucket only, without any farming attachment.

Type .....	'U'	"CeCoCo" Powered Barrow	
Dimension .....	840 H x 600 w x 1,650 L m/m		
Transmission: .....			
Revolution of Intake shaft .....	1,150-2,260 r.p.m.		
Reduction .....	Gears and Roller chain, 1:18		
Crusing: .....			
Front wheels .....	Pneumatic tyre 3.00x8 2-ply		
Tail wheel .....	Solid tyre 2.50x4 2-ply		
Distance between wheels.....	113.5~58.7 c/m; Net Weight.....		65 kgs.
Revolution of Wheelshaft.....	64- 125 rpm; Gross Weight .....		100 kgs.
Forwarding Speed.....	3.6~7.0 km/h; Ship'g Measurement.....		35 cft.

# IRRIGATION PUMP

## "CECOCO" MOTORLESS HYDRO-HI-LIFT PUMP

This particular pump will raise water by the power caused by means of declivity of water-flow up to the height 30 times of water head and operates automatically without any motive power such as gasoline, other fuel oils and electricity and no attendance for operation is necessary. It is extensively used in Japan for water supply at home, and field for irrigation, spraying and water reservoir on the top of mountain and hill.

### MOTORLESS HYDRO-HI-LIFT PUMP

It operates automatically in means of water-flow, an attendance necessary. For cooking and bath at home situated on top of mountain and irrigating and water spraying on hill also high in mountain. Delivery 1 ft. Three subjects items of Water-Head, Discharge: -17 to 13,140 Imp. gallons per hour.

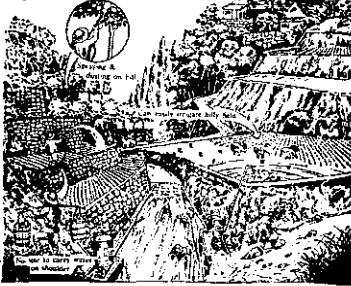

**PRINCIPLE:** In order to raise the water automatically by multiplied power of (1) the water hammer pressure leading pipe installed with a slight inclination and (2) the specific gravity with effectivity of the air in the delivery pipe taken in by the negative pressure (Vacuum) caused by the reactional flow of the water hammer pressure.

**HOW TO INSTALL:** Although it is motorless, it has to have a flow of water as the source of power to operate the pump and the "Head" is absolutely necessary. During operation, proportionate amount of water to be delivered, therefore it must have drainage. The gist of such parts are:

- (1) Head 0.5—4 meter for small type and 1—8 meter for large type, is considered to be the best for practical use.
- (2) Leading Water Pipe: The length of leading pipe is, for practical use, approximately 8 times of the Water Head and the pipe must be kept straight. It needs to be hard, therefore it is advisable to use steel pipe.
- (3) Delivery Pipe: The size of the delivery pipe is half in diameter of the leading pipe.
- (4) Drain Well: In order to cause counter current at the moment Drain Valve opens, it is necessary to install Drain Well. Also, in order to take the air, make the water level of drain well equal to red line marked on discharging mouth.
- (5) Discharging Water: It may be drained out into well or culvert or any other suitable equipment.

### HOW TO OPERATE:

- (1) After the pump is installed, shut the drain valve by hand and have water flow into the leading pipe. Then push back the drain valve to let the water drain and then take your hand off to let the valve closes. Repeat this action 5 or 6 times. After that the valve operates automatically. The above is the first operation and its purpose is to help the pump operation until sufficient amount of water is stored in the tank. For the second time, no such operation is necessary because the pump will start to operate just by a single push of the drain valve.
- (2) In order to take the proper amount of air into pump at the moment when drain valve opens, it is necessary to make the drain water level unique. For this purpose it is best to install the drain well at the base of the pump.
- (3) The number of beating of the drain valve is controlled by adjusting the control screw which is set on the drain valve. In case more water is needed, select the beating number to around 30 to 45 times beats per minute. In case the drained water has to be saved because of insufficient water flow, change the beats to around 60-90 per minute.
- (4) To stop the pump, pull the drain valve handle and close the valve and hold it for 5 to 6 seconds to lock the water comes still in the pipe.
- (5) While the pump is operating, even though any of delivery pipe is shut out, pumping operation of pipe will not stop.

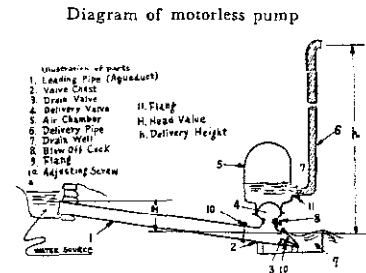

Motorless pump  
Type No. 4



Standard Specification of "CeCoCo" Motorless Hydro-Hi-Lift pump

Type	No. 1	No. 2	No. 3	No. 4	No. 6	No. 12
Bore of Suction	1½"	2"	3"	4"	6"	12"
Bore of Discharge	¾"	1"	1½"	2"	3"	6"
Practical Head value	0.5-4m	0.5-4m	0.5-4m	1-10m	1-10m	1-10m
Net Weight	40 kg	55 kg	68 kg	167 kg	300 kg	1300 kg
Gross Weight	60 kg	85 kg	110 kg	220 kg	400 kg	1800 kg
Ship'g Meas't	3 cft	5 cft	10 cft	20 cft	40 cft	230 cft

Standard Discharge Capacity per minute in litres

Type	No. 1	No. 2	No. 3	No. 4	No. 6	No. 12
2 times of Water Head	13.0	23.6	55	100	210	960
4 " " " "	9.1	18.2	40	76	160	800
6 " " " "	7.1	14.2	35	60	126	640
8 " " " "	5.5	11.0	30	46	98	460
10 " " " "	4.5	9.0	25	38	80	380
15 " " " "	3.3	6.6	20	28	56	240
20 " " " "	2.2	4.4	12	18	40	140
25 " " " "	1.9	3.3	11	16	36	120
30 " " " "	1.3	2.6	8	11	30	100

Upon receipt of the detailed specification of your requirements with condition of environment of the place the pump to be installed as well as discharge per minute or per day, head value, or water head, delivery lift (vertical height, between the level of pump to discharge end), and usages etc., "CeCoCo" will send you at once our proforma invoice with the best prices together with the illustrated literatures.

"CeCoCo" is ready to welcome to guide you to many places where the pumps are functioning for homes, villages, spas and reservoirs near in Tokyo and never miss to call on us while you are in Japan.

HIGH HILL IRRIGATION at the Shizuoka Citrus Experiment Station,  
Inatori, Izu Peninsula of Japan.

"CeCoCo" Special No. 3 Type Motorless pump is installed at the above place to take care for citrus fruits for obtaining the best qualified varieties of Japanese Orange.

The reason why the prefectural Government has decided to install "CeCoCo" motorless pump is that if they adapt usual electrically operated pump in order to lift the water up to 150 meters and about 80 meters further in extension above the seashore where spring water is flowing, it will surely require at least 2 or 3 pumps and the cost of maintenance will be very high. However, by installing "CeCoCo" Motorless pump, the cost of installation is greatly saved and no operating expense is necessary in running water all day and night and no attendance required.

Attention: When operating, be sure that no air creeps in the pump, otherwise pump will stop running at once. Due to a strong vibration given to the pipes which lead the water from a water tank and to the pump. In order to prevent the leakage at the outlet and inlet connections, the shock absorber such as rubber pipe should be connected in between the incoming water pipe and the pump or the water-tank and the said pipe. Pay attention listening to the noise which can be heard at a far distance where and when pump is satisfactorily working. But when the pump fails to make such noise, the pump is in trouble, so that examine if an air is leaked in or valve is out of order or worn out, if so displace it with a new one.

At Tukuda village. Akagimura, Setagun. Gunma Prefecture, about 110 kilos north east Tokyo, Japan, "CeCoCo" Motorless pump of Type No. 4 (4-inch suction and 2" delivery) was installed about 7 years ago and is now supplying a pure water to 100 households for their drinking, bathing, laundry etc. up to the hill about 75 feet above the water spring at the base.

The water is first pumped up into two large water-reservoir-tanks upon the hill and is distributed into each household by means of vinyl-pipes installed individually. Mr. Kyuhei Kanon, the supervisor of the village Water Supply Section said that during the last 7 years, there was no mechanical trouble in the operation at all, no attendance in looking after oiling etc. is necessary but only in replacing the valve in pump which wears out once a year. Therefore, no maintenance expense required, however he is collecting about 20 to 30 yen, equivalent of U. S. \$ 0.08 from each family per month as a reserve fund to purchase a new pump when present one becomes too old.

Before installing the said pump, they have adapted a ready-made-water-reservoir lifting up the water from stream down and they have suffered a trouble when an epidemic of dysentery has spread over. However, since they have installed "CeCoCo" Motorless pump, they have succeeded to get a quite fresh water, and they have not experienced such miserable troubles since then.

Installed at the Shizuoka Citrus Experiment Station



Type of pump Special No. 6 with Pressure Gauge.  
Head Valve-6 meters;  
Delivery Lift-150 meters;  
Length of Delivery pipe-700 meters;  
Length of Leading pipe-32 meter.

Installed at the Tukuda Village, Type No. 4

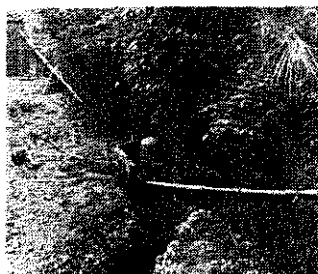

## HOME WATER SUPPLIED 100 METERS HIGH And 940 Meters Delivery In Mountain By "CeCoCo" Motorless Pump

The municipality of Shuzenji, Shizuoka Pref., near Tokyo, Japan, is supplying water through the day and night with no cost for operation to some of its inhabitants of about 560 families with the water raising 100 meters vertically high in the mountain and leading water about 1,530 meters from the original water spring by means of "CeCoCo" Motorless Automatic Hydro-Hi-Lift Pump Type No. 6 (for high delivery and high pressure, 6 inches pipe in suction and 3 inches pipe in delivery).

550 meters from Water Source to Intermediate Reservoir (8 tons in capacity); 54 meters from Intermediate reservoir to Motorless pump; and 940 meters from Motorless pump to Water Reservoir (50 tons in capacity) in mountain. Discharge capacity is 116,200 litres per day for 24 hours.

This scene shows how "CeCoCo" Motorless pump is functioning as above explained.



### "CECOCO" SELF-PRIMING PUMP

It is not necessary to have foot valve, because vacuum pump, that is it fills up pump-casing with priming-water at first time only, then by pump, action of priming-valve discharges air of suction line automatically and then begins discharge water by pumping up.

It will function well even the suction pipe is not straight or it is set much higher place than the pump is operating continuously.

The pump is air-tightly enclosed with mechanical seal. Specially designed semi-open impeller is well tempered so that it can lift up and

deliver any of dirty, and muddy water and also water mixed with foreign substances.

Equipped with a high grade of ball bearings which air tightly protects the shaft with the best grease inserted, so that no oiling is necessary and no dusts can come in. Consequently, it can be used for many hours continuously without any attention. Used for construction, marine, food industry, chemicals, mining and irrigation.

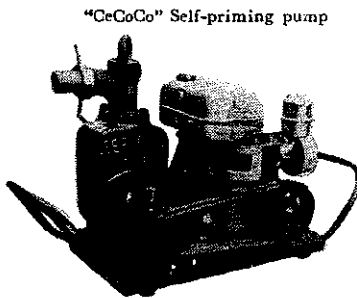
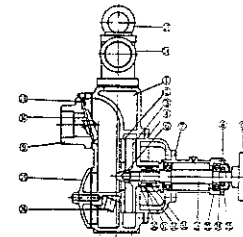

Diagram of pump



- |                                |                    |                      |
|--------------------------------|--------------------|----------------------|
| 1. Casing                      | 2. Friction Disc   | 3. Impeller          |
| 4. Case-Cover                  | 6. Impeller Nut    | 7. Bearing Case      |
| 8. Bearing Case Cover          | 9. Suction Mouth   |                      |
| 13. Set Piece Of Suction Valve |                    |                      |
| 14. Discharge Bend             | 15. Discharge Plug |                      |
| 16. Scavenging Port Cover      | 19. Shaft          |                      |
| 22. Ball Bearing               | 24. Washer         | 25. Shaft Nut        |
| 26. Priming Valve              | 30. Suction Mouth  |                      |
| 50. Seal Washer                | 51. Seal Ring      | 57. Seat Ring        |
| 53. Spring                     |                    | C. Flexible Coupling |

### "CECOCO" VERTICAL PUMP

These particular pumps are precisely constructed with many years of experience in the laboratory and field works and built with a first class workmanship under the unique design, and every one pass through the severe and rigid inspection and test before packed for export. There are many kinds of types according to the requirements, such as axial flow pump, lateral sand pump, under-water sand pump, multiple-stage push up vertical pump etc. Speciality of "CeCoCo" vertical pump is this that it is very handy to install when drawing water in very high degree and the operation is very easy and economical and can endure the rough handling in agricultural irrigation, construction works and chemical industry.

Vertical pump Model TDL is for agricultural irrigation and general work. It is conveniently used in irrigation to the farm field where the water is available near to a pond, bank and reservoir up to the lift of 4 to 14 feet in depth and also for the drainage work in construction for pumping out the waste water very easily. To make it handy, it can be used in set in conjunction of a small and light combustion engine or an electric motor as a portable unit.

The construction is all metal made throughout and very durable.

Vertical pump Model 'TDL'



Standard Specification of "CeCoCo" Vertical Pump Model TDL

Type	Dia. of Barrel	Discharge per hour	Horse Power Required and Revolution per minute					
			4 ft.	6 ft.	8 ft.	10 ft.	12 ft.	14 ft.
7 L	178 mm (7 inch)	81 M <sup>3</sup> 17,820 gal.	0.90 HP	0.96 HP	1.16 HP	1.45 HP	1.75 HP	—
			850 rpm	1000rpm	1200 rpm	1300 rpm	1400 rpm	—
9 L	228 mm (9 inch)	126 M <sup>3</sup> 27,720 gal.	1.30 HP	1.60 HP	1.90 HP	2.30 HP	2.75 HP	—
			770 rpm	840 rpm	960 rpm	1100 rpm	1200 rpm	—
10 L	254 mm (10 inch)	154 M <sup>3</sup> 33,880 gal.	1.50 HP	1.80 HP	2.28 HP	2.68 HP	3.23 HP	—
			650 rpm	790 rpm	920 rpm	1010 rpm	1100 rpm	—
11½ L	292 mm (11½ inch)	200 M <sup>3</sup> 44,000 gal.	1.80 HP	2.43 HP	2.75 HP	3.50 HP	4.12 HP	—
			550 rpm	680 rpm	770 rpm	850 rpm	900 rpm	—
13½ L	342 mm (13½ inch)	290 M <sup>3</sup> 63,800 gal.	2.40 HP	3.60 HP	4.00 HP	5.12 HP	6.30 HP	—
			540 rpm	580 rpm	620 rpm	600 rpm	700 rpm	—
15 L	380 mm (15 inch)	360 M <sup>3</sup> 79,200 gal.	2.94 HP	4.40 HP	5.00 HP	5.90 HP	7.40 HP	8.80 HP
			450 rpm	500 rpm	540 rpm	580 rpm	620 rpm	670 rpm
19 L	482 mm (19 inch)	631 M <sup>3</sup> 138,820 gal.	4.90 HP	7.10 HP	8.50 HP	11.60 HP	13.00 HP	14.90 HP
			370 rpm	400 rpm	430 rpm	460 rpm	490 rpm	515 rpm
25 L	635 mm (25 inch)	1,262 M <sup>3</sup> 277,640 gal.	11.60 HP	16.50 HP	17.4 HP	21.0 HP	24.60 HP	29.00 HP
			350 rpm	340 rpm	350 rpm	380 rpm	400 rpm	415 rpm

Multi-Stage Push-up Vertical Pump Model TVM is for construction work, mining, factory drainage, agricultural irrigation etc.

These pumps are chiefly intended for the operation under the conditions of a high lift and a narrow space of work.

They are installed with the pump axis directly coupled with the electric motor, and are easy to operate. The pump for fixed installation is particularly suitable for use in case where the lift is relatively large and the distance between the sites of drainage is very large.

Standard Specification of "CeCoCo" Vertical pump Model TVM

Bore	Dia. of Barrel	Discharge per hour	Character of Motor		Single Stage Type		Two Stage Type	
			Frequency	Revolution	Total Lift	HP Req'd	Total Lift	HP Req'd
75mm (3 inch)	140 mm (5½ inch)	40.5 M <sup>3</sup> 8,910 gal.	60-cycle	1,750 rpm	9.10 meter	2.3 HP	18.2 meter	4.6 HP
			50-cycle	1,450 rpm	5.15 meter	1.32 HP	10.3 meter	2.64 HP
125mm (5 inch)	228 mm (9 inch)	126 M <sup>3</sup> 27,720 gal.	60-cycle	1,750 rpm	9.10 meter	8.8 HP	18.2 meter	17.6 HP
			50-cycle	1,450 rpm	5.15 meter	5 HP	10.3 meter	10 HP
150mm (6 inch)	254 mm (10 inch)	154 M <sup>3</sup> 33,880 gal.	60-cycle	1,750 rpm	10.60 meter	11.0 HP	21.2 meter	22 HP
			50-cycle	1,450 rpm	6.05 meter	4.72 HP	12.1 meter	12.6 HP
200mm (8 inch)	292 mm (11½ inch)	200 M <sup>3</sup> 44,000 gal.	60-cycle	1,750 rpm	15.20 meter	18.0 HP	30.4 meter	36 HP
			50-cycle	1,450 rpm	9.10 meter	10.5 HP	18.2 meter	21 HP

"GECO CO" SUBMERSIBLE MOTOR PUMP

Specification

- Bore..... 40mm of Submersible Motor Pump
- Suction Capacity ..... 7,000 litres/hour
- Total Head ..... 6m (max. 7m)
- Motor ..... 4-poles, 250-watts Condenser motor with Cabyre cord 8 meters
- Revolution ..... 1,440 rpm at 50-cycle  
1,720 rpm at 60-cycle
- For the use ..... Civil Construction Works, Cable Laying Works, Drainage, etc.

Diagram of submersible motor pump

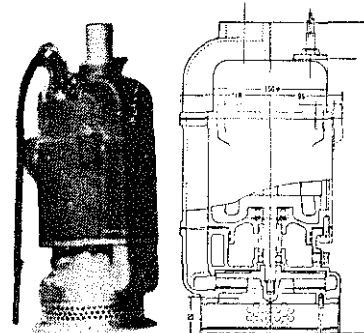



## "CECOCO" HAND WELL PUMP

"CeCoCo" Hand pump No. 5

for home use

Materials are of casted with best pig iron, and steel used in main parts.

Vertical motion of hand-operated piston draws up the ground water.

Availability is good for every existing dug well and fit for a driven well.

Most suitable for general home use and sucking etc.

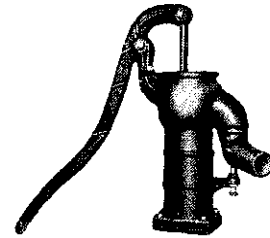

### Specification of "CeCoCo" Hand Well Pump

Sort of well	Model No.	Type	Bore	Capacity per hour	Suction lift	Pushing lift	Net Weight	Contents per case	Gross Weight	Ship'g Meas't
Driven	No. 2	C	1 1/4"	800 gallon	9 meter	20 meter	@ 20kg	4 sets	100 kg	6.5 cft
Dug		D	1 1/4"	800 gallon	9 meter	20 meter	@ 25kg	4 sets	115 kg	8.5 cft
Driven	No. 4	G	1 1/4"	800 gallon	9 meter	20 meter	@ 26kg	4 sets	125 kg	9 cft
Driven		H	1 1/2"	1000 gallon	9 meter	20 meter	@ 27 1/2 kg	4 sets	130 kg	9 cft
Dug		I	1 1/4"	800 gallon	9 meter	20 meter	@ 31kg	4 sets	145 kg	12 cft
Dug		J	1 1/2"	1000 gallon	9 meter	20 meter	@ 32 1/2 kg	4 sets	150 kg	12 cft
Dug		K	1 1/4"	600 gallon	8 meter	18 meter	@ 14kg	8 sets	130 kg	10 cft
Dug	No. 5	L	1 1/2"	800 gallon	8 meter	18 meter	@ 15 1/2 kg	8 sets	140 kg	10 1/2 cft
Driven		N	1 1/4"	600 gallon	8 meter		@ 9.5kg	8 sets	90 kg	6.5 cft
Driven		O	1 1/2"	800 gallon	8 meter		@ 11kg	8 sets	110 kg	8 cft

## "CECOCO" CENTRIFUGAL PUMP

This Pump has "CeCoCo" special and superior efficiency, and therefore, is utilized widely to various kinds chemical and manufacturing industries, built equipment, mines, agriculture and etc. owing to simple construction and easy handling.

Construction :—

Casing ..... Dense cast iron, designed to produce a smooth flow with gradual change in velocity.

Impeller ..... The bronze or cast iron impeller is of single suction closed type, outside machine finished and inside hand or grinder finished well balanced by Balancing machine.

Shaft ..... Hard steel ground to accurate dimension.

Bearing ..... Two ball type bearing, grease lubricated. For large size thrust ball bearing is equipped additionally.

Stuffing Box Gland ..... Bronze, bolted type with ample room for adjustment of repacking.

Coupling ..... A flexible coupling of the rubber bushing and pin type is supplied for direct connected unit.

Base ..... Standard base plate are of cast iron, in special case structural steel may be used.

Direct Coupled Diesel Engine Drive Centrifugal Pump

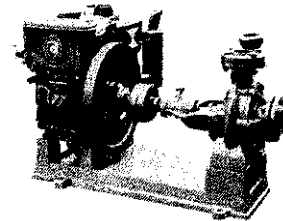

### Standard Specification of "CeCoCo" Centrifugal Pump

Size of Bore		Capacity per minute		1750 rpm/60 cycle		1450 rpm/50 cycle	
mm	inch	in litre	in US gall.	Total Head	H.P.	Total Head	H.P.
32	1 1/4"	80	21	6 m 20 ft	0.4	4 m 13 ft	0.3
40	1 1/2"	150	40	6 m 20 ft	0.7	4 m 13 ft	0.4
50	2"	260	69	8 m 28 ft	1.0	5 m 16 ft	0.6
65	2 1/2"	410	108	9 m 30 ft	2.0	6 m 20 ft	1.5
75	3"	790	208	10 m 33 ft	4.0	7 m 23 ft	3.0
100	4"	1,280	338	12 m 39 ft	7.5	9 m 30 ft	5.0
125	5"	1,890	499	14 1/2 m 48 ft	10.0	10 m 33 ft	7.5
150	6"	2,420	640	16 m 53 ft	15.0	11 m 36 ft	10.0

## "CECOCO" ELECTRIC (CONDENSER MOTOR) PUMP

for Shallow and Deep Well Uses

Model PA-112

Model PA-124

Model PA-216

Model PF-400

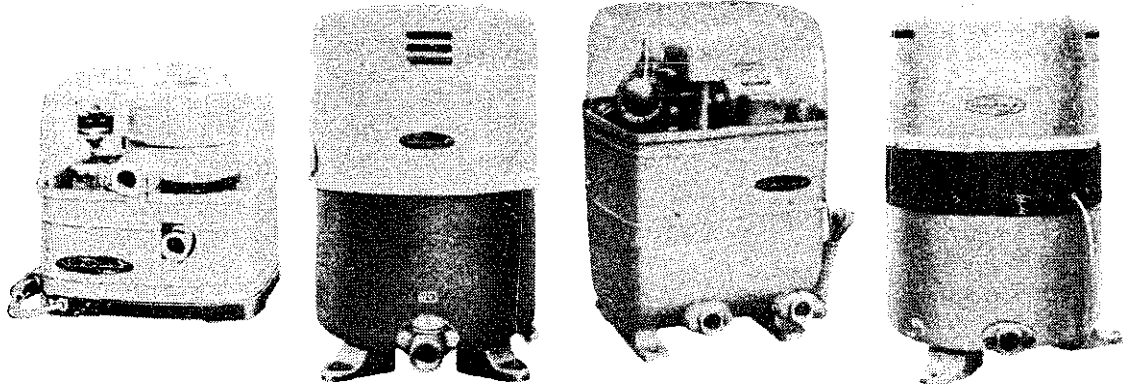

Specification of "CeCoCo" Electric Home Water Pump

Model		PA-112	PA-80	PA-124	PA-216	PA-401	PF-150	PF-400
Motor	Type	Condenser	Condenser	Condenser	Condenser	Condenser	Condenser	Condenser
	Output	70 Watts	80 Watts	125 Watts	250 Watts	400 Watts	150 Watts	400 Watts
	Cycles	50/60	50/60	50/60	50/60	50/60	50/60	50/60
	Revolution per min.	2860/3430 r.p.m.	2850/3450 r.p.m.	2850/3450 r.p.m.	2880/3460 r.p.m.	2850/3450 r.p.m.	2800/3350 r.p.m.	2850/3450 r.p.m.
Pump	Suction head	6 m (20ft)	7 m (23ft)	7 m (23ft)	7 m (23ft)	7 m (23ft)	12m(39½ft)	19 m (63ft)
	Delivery head	4 m (13ft)	5 m (16½ft)	6 m (20ft)	11 m (36ft)	13 m (43ft)	5m(16½ft)	11 m (36ft)
	Total head	10 m (33ft)	12m(40½ft)	13 m (43ft)	18 m (59ft)	20 m (66ft)	17 m (56ft)	30 m (99ft)
	Standard capacity	820 L/h (180 Gallon)	660 L/h (145 Gallon)	960 L/h (211 Gallon)	1800 L/h (396 Gallon)	2400 L/h (528 Gallon)	840 L/h (185 Gallon)	1140 L/h (250G allon)
Pipe	Suction pipe	3/4"	3/4"	3/4"	1"	1¼"	1"	1¼"
	Delivery pipe	3/4"	3/4"	3/4"	1"	1¼"	3/4"	1"
Capacity of Tank		2.5L(0.55G)	6.5L (1.4G)	12 L (2.6 G)	20 L (4.4 G)	33.6L(7.4G)	12 L (2.6G)	33.6L(7.4G)
Height of Pump		265 mm	370 mm	460 mm	547 mm	600 mm	510 mm	650 mm
Base dimensions mm		290×220mm	260×260mm	300×300mm	380×280mm	480×522mm	300×300mm	480×512mm
Net weight (approx.)		10 Kgs (22 Lbs)	13 Kgs (28.6 Lbs)	20 Kgs (44 Lbs)	25 Kgs (55 Lbs)	32 Kgs (70 Lbs)	24 Kgs (53 Lbs)	48 Kgs (106 Lbs)
Meas't per set		2.2 cft	3.5 cft	4.3 cft	5.2 cft	10.0 cft	5.0 cft	10.0cft

Please Note: We are producing many kinds of pumps besides explained above. For your requirements, we wish you will let us know your detailed specification on the following points.

1. Kind of pump; Self-priming pump, Vertical pump, Sand pump, Centrifugal pump, Cascade pump, Turbin pump, Borehole pump, and etc.
2. Discharge Capacity; How many cubic meter (or gallons) of water or liquid to be delivered per minute or hour are required. If, however, the pump is intended for use in irrigation or draining work, etc. In case if it is difficult to specify the volume of water exactly, state the estimated increase and decrease of water during to be filled for 24 hours to the total area and the level of water.
3. Head and lift; Required vertical distance between the level of water and maximum height of water to lift or to the place where the water should be delivered. However, for construction works, specify the vertical distance between the bottom of the soil dug and level of point or place where be lifted.
4. Quality and Use of liquid; kind of liquid to be delivered, state whether it is clear, muddy, sandy or salty waters. For chemical purpose, mention whether it is acid or alkali origin.
5. Adaptation of the motive power; State whether the pump is intended to be operated by the combustion engines or an electric motor and it is connected with a flat belt, v-belt, or direct couple, stating the number of the revolution per minute and the diameter and width of pulley equipped on them, and the character of electric motor.

Upon receipt of the above detailed specification, "CeCoCo" will send you at once the proforma invoice with the best and competitive prices together with the individually illustrated literatures.

# DOMESTIC ANIMALS AND POULTRY EQUIPMENT

We are able to divide the type into classes by usefulness as follows;

- A. Chaff cutter has cylindrical spiral edge and its structure is simple, so secure, easy to operate and cheap price. The structure delivers the crops for fodder, that is, Straws, Chinese Milk Vetch, Sweet Potato Vines and Dent-corns, etc. by roll and cuts them at certain length.
- B. Ensilage Cutter has cutting edge of Fly-wheel type and it delivers the crops for fodder by conveyor. It is cut at certain length and the structure is blowing-up-type so as to preserve easily into Silo.
- C. Chopper is a general term for Grater-Masher, Hammer-Mill, Chopper Mill, Feed-Grinder, Root-Cutter, etc. And we ought to choose proper machine by usefulness. Although cutters are instruments which cut at certain length, the choppers are instruments that crush a fiber more minutely to smash for kneading feed fodder.

They're effective for poultry raising or hog raising and are able to work upon such all fodder crops as Pasture, Weed, Sweet Potato Vines, Dent-corn, Chinese Milk Vetch, Straw, Vegetable Trash, Duckweed, Sort of Root or Tuber Vegetables, Indian Corn, Wheat and Barley, etc.

- 1) "CECOCO" CHAFF CUTTER: The cutter is able to cut every forrages for domestic animals. It requires only small motive power, because both revolving spiral knife and the fixed knife are very sharp so that can cut chaff very nicely and lightly.

The sharpness and long life of the knives are assured, because superior shear steel is welded on mild steel with highly advanced technique of heat treatment, which ensures the uniform quality of the blade. Cut is freely adjustable by a simple device.

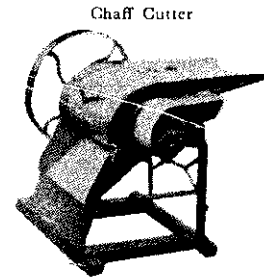

Specification of "CeCoCo" Chaff Cutter

Model	Powe Req'd	R.P.M.	Capacity per hour	Dimension in mm			Cutting Length	Weight/kg.		Ship'g Meas't
				Height	Width	Length		Net	Gross	
FC-10	1/4-1HP	800	450 kgs.	640	737	580	13, 20, 33, 50mm	40	50	6 cft
Y 2	1-2HP	650	800 kgs.	820	600	1050	13, 25, 75, 145mm	70	110	28 cft
PL	1/2 HP	250	300 kgs.	810	530	760	5 to 120 mm	53	80	18 cft
P 2	1/2 HP	250	300 kgs.	720	530	800	5 to 50 mm	40	60	15 cft

- 2) "CECOCO" ENSILAGE CUTTER: It is designed in blowing-up speedily the chopped materials to high place and is highly recommended for use in filling vertical silos, as well as pit silos, semi-pit silos and trench silos. Even late in the evening, two or three minutes is enough to prepare a day's feed for cows and horses.

"CeCoCo" Ensilage Cutter

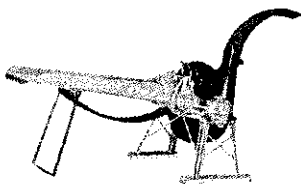

Long straw and grass mixed with barn manure are difficult to ripen, and tangle with the blades of rotary tillers in the field and disturb its operation. By chopping straw for bedding material it ripens quicker and increases the value of the barn manure.

The Ensilage Cutter is specially designed to cut, chop, and smash the hardest of stalks, cobs and cores in dent-corn, grass, hay, rice-straw, wheat and beans stalks and other fodder materials, and make ideal ensilage without waste or loss.

The knife is made of high grade special steel and assures a long life. It is easy to attach or detach the knives to and from the machine and also is easy to sharpen them. The fixed shear-cutter-bar has double cutting edges which can be reversed when one side is worn out.

Specification of "CeCoCo" Ensilage Cutter

Model	Width of Inlet	Power Req'd	R.P.M.	Capacity ton/hour		Cutting Length in m/m	Net Weight	Gross Weight	Ship'g Meas't
				Corn	Straw				
Large	250mm	5-6 HP	800	6.0-8.0	1.8-2.3	10, 16, 22, 32, 41, 76	265 kg	350 kg	60 cft
No. 1	200mm	3-4 HP	770	3.5-4.5	1.3-1.7	-ditto-	180 kg	250 kg	45 cft
No. 2	170mm	2-3 HP	770	2.5-3.5	0.9-1.3	6, 13, 19, 32, 54, 84	145 kg	200 kg	35 cft
No. 3	150mm	1-2 HP	750	1.5-2.5	0.9-1.1	13, 22, 35, 64, 102	115 kg	160 kg	30 cft
Pet	150mm	1-2 HP	750	1.0-1.5	0.8-0.9	8, 21, 38, 110 mm	100 kg	135 kg	25 cft

- 3) "CECOCO" FEED GRINDER is an ideal machine for grinding corn, oats, soybean, green peas and wheat, also crushed coarse fish meal and shells. Over 30% of feed can be saved by feeding the livestock with suitable ground-up-grains which contribute for well being of the livestock from nutritious point of view.

"CeCoCo" Feed Grinder

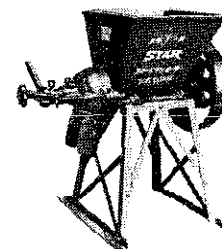

Specification of "CeCoCo" Feed Grinder

Model	Power Req'd	R.P.M.	Capacity of corn, per hour	Dimension in mm			Net Weight	Ship'g Meas't
				H	W	L		
No. 5	1-2 HP	250-350	150-230 kg	830	570	810	50 kg	18 cft
No. 6	2-4 HP	350-500	180-720 kg	930	530	830	65 kg	22 cft

- 4) "CECOCO" HAMMER MILL is the most efficient machine to grind shelled corn, ear corn, green soybean, clover, lucerne, pea pods, chinese milk-vetch, hay, dried grass and grains. This machine is equipped with many hammers, feed rolls and a screen underneath. Capacity varies according to the material to be milled, mesh of screen and horse power of motive power. The screen shall be supplied according to the customer specifications in among 3, 5, 6, 10, 13, 19 or 25mm dia. of perforation.

"CeCoCo" Hammer Mill

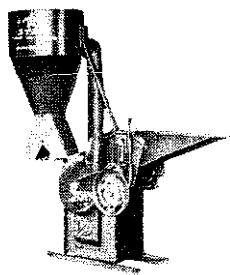

Specification of "CeCoCo" Hammer Mill

Model	Power Req'd	Revolution	Capacity with 19mm per hour	Dimension			Net Weight	Ship'g Meas't
				H	W	L		
No. 1	5-10 HP	2000-2400rpm	650 kg. corn 500 kg. hay	2160	1580	1180	280kg	60 cft

- 5) "CECOCO" ROOT CUTTER is a handy machine for cutting the tuber or root vegetables such as cattle beet, turnips and pumpking. It cuts roots into crescent-shaped pieces, which are much desirable for feeding animals and to make silage.

"CeCoCo" Root Cutter

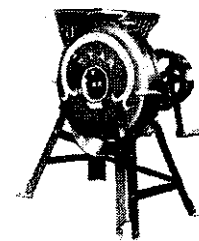

Model	Power Req'd	Capacity per hour	Dimension in mm			Net Weight	Gross Weight	Ship'g Meas't
			H	W	L			
M	1/2 HP or Hand	500 to 700 kg	930	610	810	60 kg	100 kg	25 cft

- 6) "CECOCO" CHOPPER MILL: It is a versatile machine that acts as a grinder-crusher, mill, cutter and mixer at the sametime by changing a few minor parts. It cuts, crushes and grinds the soft and hard vegetables, also mills cereals and sea shells and is very handy for preparing an ideal feed for poultry, pig and cattle.

"CeCoCo" Chopper Mill

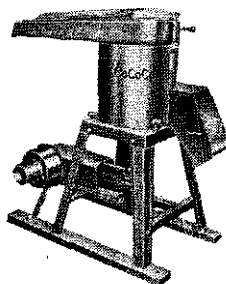

Specification of "CeCoCo" Chopper Mill

Type	Power Req'd	R.P.M.	Capacity in kgs./hour			Dimension m	Net Weight	Ship. Meas.
			Potato	Cabbage	Clover			
ML	1/4-1/2 HP	2000	700-1000	600-800	350-500	620×320×480	14 kg.	10 cft
MC	1-2 HP	600-2000	1,400	750	160	850×560×720	39 kg.	20 cft

\*Capacity for Grinding part 'A' 100 to 200 kgs. per hour

\*Capacity for Breaking part 'B' 60 to 120 kgs. per hour

- 7) "CECOCO" GRATER-MASHER : Not only with all kinds of grass, but this grater-masher performs well also with greens, potato, fruits, fish, seaweed, beans, and various other materials. The principal uses are for poultry feed increasing starch yield, sodium alginate production, peanut-butter production, manufacturing sause, soybean-milk and other usages, and the machine also is adapted for many more uses in accordance with the purchaser's wishes.

"CeCoCo" Grater-Masher

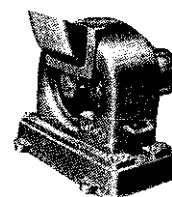

For making Peanut-butter, soybean-milk and sause etc.

Specification of "CeCoCo" Grater-Masher

Type	Power Req'd	R.P.M.	Hourly Capacity depended on material	Dimension mm			Ship'g Meas't
				H × W × L	Net	Gross	
MA-30	1/2-1HP	2400	30- 80 kg.	400×470×360	50	70	5 cft
RM-6	1-2HP	2800	55-110 kg.	360×420×460	50	70	5 cft
RM 10	3-5HP	2800	150-900 kg.	570×620×620	110	150	10 cft

"CeCoCo" Breaker type "S"

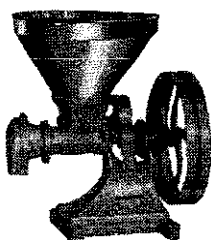

- 8) "CECOCO" CEREALS BREAKER : It can be used very effectively and efficiently for crushing corn, bean, rice, barley and almost of all of other materials for poultry and cattle feed. It is built very sturdy using the chilled-case-metal with a first-workmanship under a unique design.

Specification of "CeCoCo" Cereals Breaker

Type	Power Req'd	R.P.M.	Hourly Capacity			Dimension mm H × W × L	Net Weight	Ship'g Meas't
			Barley	Soybean	Corn			
S	1/4 HP	350	40 kg	60 kg	60 kg	330×410×500	20 kg	5 cft
M	1/2 HP	350	80 kg	120 kg	100 kg	1000×360×530	25 kg	9 cft
L	2 HP	350	150 kg	240 kg	240 kg	1070×600×400	38 kg	12 cft

\* Typs 'S' can be either driven by hand or by motor.

- 9) "CECOCO" CORN SHELLER : The purpose of this machine is to remove kernels from corn-cobs in a short time. Type Nos. 1, 2 & 4. The cob of corn is inserted into the Inlet hole upside down and by turning crank or flywheel the cob is stripped of it's maize and comes out from the outlet. The machine will shell cobs of any size without giving any damage to the kernel corns as the Shelling Disk equipped with a Compression Spring which adjusts in taking care of all sizes of cobs.

The Corn Sheller Type No. 3 is equipped with the twin holes inlet so that two cobs are shelled at a time and the output efficiency is more than double and the operation is much speedier than other types. Kernels are positively stripped from the cobs and the machine can be adjusted suit to shell any sizes of cobs. The completely stripped cobs are automatically ejected at the opposite outlet of Sheller. The blower attachment will thoroughly clean kernels from the chaffs and trash during operation and the perfectly cleaned corns are ready for market.

"CeCoCo" Corn Sheller Type No.3

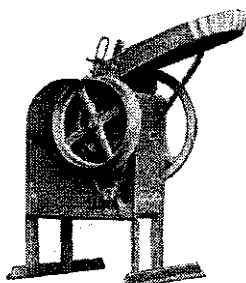

"CeCoCo" Corn Sheller Type No 2

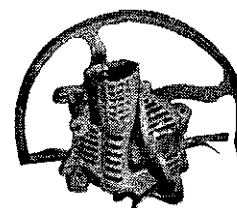

Specification of "CeCoCo" Corn Sheller

Type	Capacity per hour	Drive method & Power Required	R.P.M.	Dimension in mm			Weight in kg		Ship'g Meas't
				Height	Width	Length	Net	Gross	
No. 1	100-150 kg	Manual drive	Proper	300	180	254	@ 6	40	4 cft
No. 2	250-300 kg	Hand or 1/2 HP	100-200	610	180	254	@ 8	55	12 cft
No. 3	750-1,125 kg	1-2 HP	300-500	1100	480	735	100	140	25 cft
No. 4	300-350 kg	Treadle or 1 HP	250	850	480	820	40	65	15 cft

- 10) "CECOCO" FEED MIXER : This machine is an ideal feed mixer with its simple construction and high efficiency for preparing the cattle feed and recommendable for the self-supply of feeds.

A vertical screw conveyor is equipped with from the lower part to the top of machine and various kinds of feeds will circulate inside of the machine and well mixed by the vertical screw conveyor. Owing to this merit, the materials regardless of the weight are well mixed and an uniform mixing can be ideally achieved.

"CeCoCo" Feed Mixer

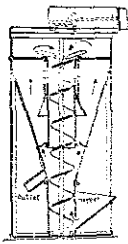

The feeds supplied into the hopper will be conveyed up to the top by the vertical screw conveyor and enter the tank. After mixing, prepare a bag or receptacle to the outlet to take out the mixed materials and operation is very simple.

Specification of "CeCoCo" Feed Mixer

Type	Hopper Capacity	Per hour Capacity	Power Req'd	R.P.M.	Dimension m/m	Net Weight	Ship'g Meas't
					H x W x L		
S	270 liters	1,000-2,000 kg	1-2 HP	800	2350 x 1100 x 950	250 kg	95 cft

11) "CECOCO" FODDER AND FERTILIZER PLANT: The whole plant comprises of Bucket Elevator, Grinder, Screw Conveyor, Hexagonal Sieve, Mixer, Weighing Apparatus, Bag Closer and Power Transmission Apparatus.

"CeCoCo" grinder

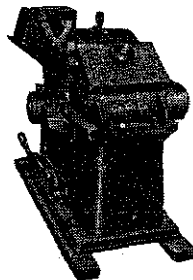

a. GRINDER is a beating type and the machine will smash the raw materials flowing from the hopper by the several smashing beaters equipped on a rotating shaft by a high-speed rotation and discharge the finished materials outside through the lattice fitted in the lower part.

The mesh of lattice can be freely exchanged widely or narrowly which enable the machine to smash the materials to any desired grain. Even only one mesh can be changed and durability of machine is so admirable.

b. MIXER is most simply designed and sturdily constructed and very easy to handle, and what is better, it seldom goes wrong with excellent durability. Thanks to our unique devices, the minute mixed powder never causes when it drops from the slits of the mixing tank, and it is suitable for various sorts of materials including superphosphate or materials which contains moisture. And moreover, such cases as the materials stick to the inner part of machine, or a funnel is choked with packed materials, never happens to our Mixer. The operation is so easy and every unskilled man or woman can handle the machine with ease requiring no special technique or training.

The mixer are classified into 3 types, that is, Single-Type, Double-Type and Stand-Type according to the space and location for installation of machine.

c. BUCKET ELEVATOR In the modern factory, it is most advantageous and convenient to use the bucket elevator for conveyance of raw materials and the manufactured goods.

d. HEXAGONAL SIEVE: is a hexangular sieve for arrangement of fertilizer and fodder. This device is made after long experiences and research and absolutely incomparable in its precise sorting and excellent efficiency.

e. SCREW CONVEYOR: is also made after special research and used for sideway conveyance in arranging fertilizer and fodder etc.

"CeCoCo" Mixer

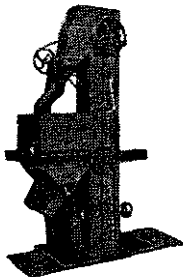

## "CECOCO" INCUBATOR

**EVERYBODY can use INCUBATOR EASY:** If the instrument is complete well about the artificial incubation, wherever everybody may use, it is never difficult to incubate about 90 per cent without fail. It is all the more ordinary to incubate above 90 per cent, and particularly it is the most certain as to the incubation of chicks. "Incubator" may, also, be used for the incubation of domestic duck, goose and quail etc. and it has brought about the excellent results. You need not bother any knowledge of incubation and acquirement of incubatory technique for application of this instrument. If you read the directions for use of incubation attached to this instrument once at least, you are able to acquire a basic technique for the artificial incubation. Those who have never seen especially the incubator are able to obtain the incubative rate above 95 per cent from the first time. The incubator hatches even if any pattern to gain the incubative rate to some extent. But, you should investigate it from every angle whether the incubator is the incubation of any ratio in the numbers of egg entering into the instrument or the using operation is trouble. If the incubative ratio of 10 per cent, 5 per cent or 3 per cent is anyhow frequent, the use is able to withdraw early the instrument price. The user also can reduce the production cost and sell the sound chick in lots, and then he can redouble the reputation in hatchery.

### THE CHARACTERISTICS OF 'K'-TYPE INCUBATOR:

1. The difference of partial temperature is very few: The most important point in plain incubator is to be a equal temperature even in any parts upon egg frame. In the type using electric and both of electric and

petroleum over K-10 type, as the regular heat piping based on certain system is done sufficiently, the difference of temperature in each parts is very few. Therefore, the growth of germ is equal and you can gain sturdy chicks.

2. It installs the excellent temperature regulator: First of all, the temperature regulator plays an important part in incubator. K-type incubator is highly efficient plain instrument adopted the very capable Bellows to temperature regulate first in the world. Various regulators of electric heating, petroleum heating and ventilation are always formed this Bellows mainly, simply and few trouble and then sure effect of temperature regulation.
3. As the heat source and other principal parts are all screw-assemble-type, overhauling and assembling are so simple without any technical knowledge.
4. As it may be piled up and set up cubically, it needs not any floor-space: As K-type incubator has very strength and has no obstacle to upper surface, it may be piled up two-steps or three-steps and set up cubically.
5. It is equipped so as to control the size of lamp automatically according to the temperature in the machine in the lamp burner of the standard hot water (petroleum) type.
6. The iron spiral stands are equipped at the legs of the standard type for over K-40 type and it can be controlled vertically.
7. The egg chamber consists of one chamber or several ones. It is equipped with the temperature controller in every chamber and moreover in hot water (petroleum) type the temperature controller is also equipped at the heating part and it prevents the disorder of temperature in the machine occurred by the whole heating.
8. As the union joint are used in the connection with boiler and iron pipe of hot water (petroleum) type, it can easily be worked in changing the incubator for petroleum to one for both electricity and petroleum in future and to its capacity desired.

"CeCoCo" Incubator

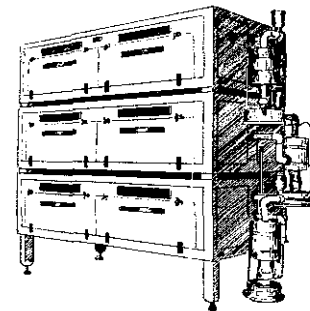

Specification of "CeCoCo" 'K'-type Incubator

No.	Type	Set No. of egg	No. of Chamber	Source of Heat	Auto. Controller No.			Dimension m/m H × W × L	Net Weight	Ship'g Meas't
					Lamp	Vent.	Electric.			
21	K-6	60-70	1	E			1 pc.	430×510× 670	35 kg	10 cft
22			1	E & P	1 pc.	1 pc.	1 pc.	430×520× 670	40 kg	10 cft
23			1	P	1 pc.	1 pc.		430×520× 670	40 kg	10 cft
24	K-10	100-120	1	E			1 pc.	730×730× 760	65 kg	15 cft
25			1	E & P	1 pc.	1 pc.	1 pc.	730×730× 970	75 kg	20 cft
26			1	P	1 pc.	1 pc.		730×730× 970	75 kg	20 cft
27	K-20	200-250	1	E			1 pc.	790×850×1150	100 kg	25 cft
28			1	E & P	1 pc.	1 pc.	1 pc.	790×850×1250	110 kg	28 cft
29			1	P	1 pc.	1 pc.		790×850×1250	110 kg	28 cft
30	K-20W	170-200	2	E			2 pcs.	790×850×1150	100 kg	25 cft
31	K-40	400-500	2	E			2 pcs.	760×850×1820	140 kg	35 cft
32			2	E & P	1 pc.	2 pcs.	1 pc.	760×850×1970	160 kg	40 cft
33			2	P	1 pc.	2 pcs.		760×850×1970	160 kg	40 cft
34	K-60	600-750	3	E & P	1 pc.	3 pcs.	1 pc.	760×850×2700	280 kg	50 cft
35			3	P	1 pc.	3 pcs.	1 pc.	760×850×2700	280 kg	50 cft
36			4	E			4 pcs.	1220×850×1820	280 kg	70 cft
37	K-80	800-1,000	4	E & P	2 pc.	4 pcs.	2 pcs.	1220×850×1970	320 kg	80 cft
38			4	P	2 pc.	4 pcs.		1220×850×1970	320 kg	80 cft

Remarks: - Source of Heat - 'E' - electricity, 'P' - petroleum.

### "CECOCO" BUTTERY BROODER

The all fresh air is indispensable to the growth of life. If the chick breathes dirty air in case of the first chick especially, the chick will suffer from indigestion and is bound to fall dead. 21% of oxygen, 7% of nitrogen and 0.04% of carbonic acid gas are contained in fresh air, but the chick breathes this fresh air and its breathed out air results in large quantity of 4% (hundred times quantities in fresh air) of carbonic acid gas. In the weight of air, the ratio is as follows; carbonic acid gas is 14, nitrogen is 7 and oxygen is 8. As the carbonic acid gas is heavy vapor, it is always inactive depressed in the substratum and almost of carbonic

acid gas fills in the lower place than the height of chick head. It is a great mistake to breed the chick under such a condition.

The circumstances in accordance with the principle of growth in life, that is, in chick-raising-instrument "Buttery Brooder" making out the complete chicken-raising circumstances kept the warmth by fresh air with proper temperature and humidity it has strong point that chick is bred up completely by anybody.

Specification of 'T-Type "CeCoCo" Buttery Brooder (All metal made) (a combination of electricity and petroleum unit, when electric supply stops, the electric unit can be switched to the petroleum unit)

Type	Capacity in chick	Dimension in m/m			Heating Source		Thermo-stat	Brood meter	Feeder	Water Trough
		Height	Width	Depth	Electric	Oil lamp				
ER 22	250	790	1820	910	500 W	2 pcs.	2 pc.	2 pc.	6 pc.	2 pc.
ER 23	250	790	2730	910	500 W	2 pcs.	2 pcs.	2 pc.	10 pc.	2 pc.
ER 33	400	1130	2730	910	750 W	3 pcs.	3 pc.	3 pc.	15 pc.	3 pc.
ER 43	500	1460	2730	910	900 W	4 pcs.	4 pc.	4 pc.	20 pc.	4 pc.
ER 53	600	1770	2730	910	1000 W	4 pcs.	5 pc.	5 pc.	25 pc.	5 pc.

Remarks: Smaller or Larger type will be manufactured upon request.

### "CECOCO" POULTRY SLAUGHTER EQUIPMENTS

"CeCoCo" Poultry treatment machines are very efficient equipments which enable automatically to dispose poultries in scalding and picking feathers. With these machines one can execute a job of 10 person. Thus save much labors and cost of production.

"CECOCO" SCALDER: This machine is to softening the killed poultries in hot water after their blood are thoroughly taken off. The constructure of this machine is basically steel frame work, and stainless steel plates are being utilized for the tank itself as well as for those outside pannels, for hygienic point of view. This machine can automatically be controlled to operate or stop and even control the temperature of water required for softening in accordance with the varieties of poultries to be treated by means of an 'automatic time switch'.

"CeCoCo" Scalding

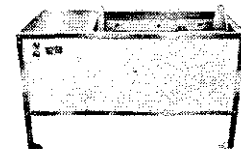

Specification of "CeCoCo" Scalding

Capacity per charge	Treating Time per charge	Temperature of Hot Water	Power Req'd	Heating Source	Dimension in mm	Net Weight
					H x W x L	
20 chicks	40-60 seconds	64°C standard	1/2 HP	Kerosene Burner	760x700x1490	120 kg

"CeCoCo" Feather picker

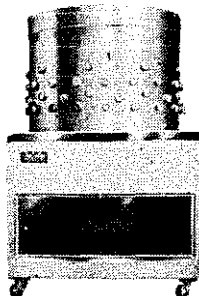

"CECOCO" FEATHER PICKER: This machine will pick off feathers of poultries which are already scalded, and three sizes - small, medium and large - are available. The moter and the main parts were carefully designed in 'total sealed' type to prevent water or moisture and also to stand for a permanent uses. The picking-rotor-board is made of hard aluminium alloy metal which is free from oxidization and fat or grease. Picking rubber is made of a special material which is finalized by our long experiences and researches. It is also equipped with 'automatic time switch' for easy operation..

Specification of "CeCoCo" Feather Picker

Type	Capacity per charge	Treating Time per charge	Power Req'd	Dimension in mm			Net Weight	Gross Weight	Ship'g Meas't
				Height	Width	Length			
A-1000	15-20chicks	20-40seconds	3 HP	850	1100	1600	200 kg	300 kg	65 cft
B-2000	5-8 chicks	40 seconds	1 HP	1000	900	900	100 kg	170 kg	40 cft
C-3000	2-5 chicks	30 seconds	1/2 HP	1000	900	650	60 kg	110 kg	30 cft



## AUXILIARY EQUIPMENTS FOR POULTRY SLAUGHTER :

Blood extracting table, 11 chicks

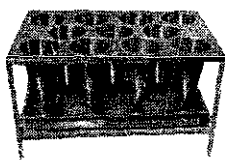

Trimming table with faucets & pipe

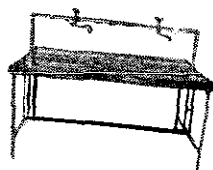

Chill Vat 100 chicks

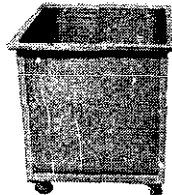

Wrapping and Working Table

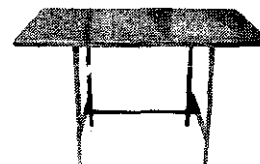

**“CECOCO” BULB OR TUBER CROP PEELING MACHINE:** This machine can peel and wash at the same time various root crops such as potato, sweet-potato, taro, carrot, radish, burdock, etc.

The loss in peeling by this machine could be saved within 3 to 5% only. The two pieces of revolving emery discs can be replaced suitably according to freshness and sizes of bulbs to be peeled.

The operation is; with the revolution of disc and water current from water fountain, a suitable quantity of bulbs is taken into peeling chamber and these bulbs are scrubbed by their own frictions by which their outer skin and mud are cleanly peeled off and washed away with water running. Therefore, peeling and washing of bulbs can easily and speedily be operated. When the door of the peeling chamber is opened, the cleaned bulbs will come out even while the disc is revolving.

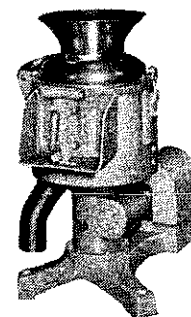

Specification of “CeCoCo” Bulb Peeling Machine

Type	Capacity of Hopper	Peeling Capacity per hour	Power Req'd	Dimension in mm			Net Weight	Gross Weight	Ship'g Meas't
				Height	Width	Length			
P-10	8-10 kg.	200-300 kg. depended on material	1/4 HP	870	500	700	96 kg.	140 kg.	20 cft

### “CECOCO” TUBEROUS VEGETABLE CUTTING & SLICING MACHINE :



This machine can cut and slice such vegetables as potato, onion, radish, carrot, burdock, cucumber, cabbage, white cabbage, etc. and even fish-sausage, boiled-fish-paste, boiled amorphophallus-paste, cracknel, etc. in sizes and shapes desired according to each cooking purposes. The disc type revolving cutter is made of aluminium alloy. There are four different shaped cutters, i.e. round-flat slicing cutter has many usages and can be adjusted in desirable sizes up to thickness 15 mm by screws, slender slicing cutter is used for thickness 5mm × width 12mm, fragment-slicing cutter for regular size thickness 3mm × width 6mm and needle-shape slicing cutter for cutting into small pieces.

Specification of “CeCoCo” Vegetable Cutting & Slicing Machine

Type	Capacity per hour	Power Req'd	Dimension in mm			Net Weight	Gross Weight	Ship'g Meas't
			Height	Width	Length			
AV	100-300 kgs depended on materials & cutting shape	1/4 HP	560	360	750	62 kg.	105 kg.	15 cft

# "CECOCO" PEANUT OR GROUNDNUT PROCESSING MACHINES

In order to facilitate the digging, threshing and shelling unshelled peanut and grading the peanut in shell and also roasting and peeling off outer-thin-skin of shelled peanut, as well as peanut-butter making, very compact, simple and durable "CeCoCo" machines are recommended for peanut growers and enterprisers.

## 1. PEANUT DIGGER ATTACHMENT:

Peanut Digger Type 'C'

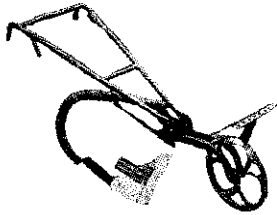

From many years of tiresome experiences, with it's special construction of digging blade with a certain curve, it can dig the peanut-plants keeping an average depths of 4 to 5 inches under the earth uniformly and steady, and leaving the digged-peanut out on the surface of earth from their original position planted. So that it helps them easy to get-rid-of mud and dirt attached to the nut and also to have them dry out speedily.

Construction is simple and sturdy and can be used for years from our experiences. Light in weight and easy in handling. The operation is so easy that it can be handled with only one hand giving no weary feeling and can be adjusted by the bolt and nuts for desired depth and curve. This Peanut Digger attachment is two types for Cattle Power and Small Power Tiller uses.

Peanut Digger Type 'T' equipped on 2-Wheeled Power Tiller



Specification of "Cecoco" Peanut Digger

Type	Capacity per hour	Description	Power Required	Dimension in mm			Net Weight	Gross Weight	Ship'g Meas't
				Height	Width	Length			
C	0.3 acre	With hitch	Animal draught	940	480	1380	20 kg	40 kg	6 cft
T	0.45 acre	Digger only	Small Power Tiller	500	500	620	7 kg	14 kg	3 cft

For large sizes of digger to be used for tractor, "CeCoCo" will be pleased to quote upon the receipt of your specification.

## 2. PEANUT THRESHER:

This machine will thresh peanuts out of peanut-plants with vines harvested from fields, and cuts off vines and stalks into pieces of about 4 to 5 inches in length and throw the foreign substance away by means of winnower equipped, leaving the threshed peanut as shown by picture, Fig. 1. Care should be taken to give proper speed of revolution to the machine. If it is too speedy, it will give damage not only to the husks but also to the kernels. If it is too slow, it will mix with stalks, because imperfect separation will retard the threshing efficiency.

"CeCoCo" Peanut Thresher

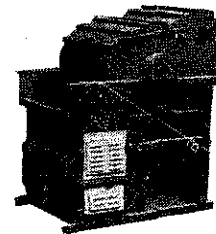

Specification of "CeCoCo" Peanut Thresher

Type	Capacity per hour	Power Req'd	R.P.M.	Dimension in mm			Net Weight	Gross Weight	Ship'g Meas't
				Height	Width	Length			
No. 1	0.37 acre	2 HP	350	1400	1000	1260	150 kg.	280 kg.	80 cft
No. 2	0.25 acre	1 HP	350	1380	830	1230	115 kg.	200 kg.	65 cft

## 3. PEANUT WASHING MACHINE:

This machine is used in producing the best cleaned peanuts.

Type..... 'W'  
 Capacity ..... 600kgs. per hour  
 Power Required ..... 2 H.P.  
 Revolution of Drum ..... 20 r.p.m.  
 Dia. of Drum ..... 810 m/m  
 Length of Drum ..... 3,000 m/m  
 Net Weight ..... 260 kgs.  
 Gross Weight ..... 500 kgs.  
 Ship's Meas't..... 130 cft.

"CeCoCo" Peanut Washer



Fig. 1-  
Threshed Peanut

Fig. 2-  
Shelled Peanut

Fig. 3-6  
Graded Peanut

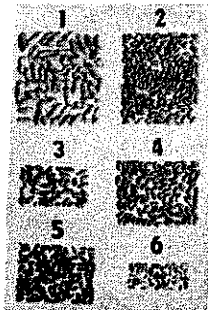

4. PEANUT SHELLER: The threshed peanuts are shelled by the revolving wing-beater and separated by means of screen and fan into perfect-shelled-peanut-beans and unshelled peanut. The unshelled peanut should be repeated in refeeding into the machine for a perfect shelling. Fig. 2 in picture will show the shelled peanut.

Adjust the speed properly according to the power given to machine by checking 'Feeding Adjusting Plate'. In case if it is too speedy, it will produce broken ones, liable to be mixed with the perfect ones, and half-shelled ones which will come out from outlet liable to be blown off together with piece of stalks. If it is too slow, the output efficiency will retard, becoming unable to get-rid-of stalks. If threshed stalks accumulate in chamber, push forward the handle lever to get-rid-of them and they will be blown far away.

"CeCoCo" Peanut Sheller

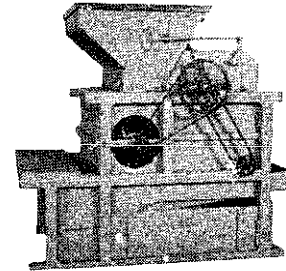

Specification of "CeCoCo" Peanut Sheller

Type	Capacity per hour	Power Req'd	R.P.M.	Dimension in mm			Net Weight	Gross Weight	Ship'g Meas't
				Height	Width	Length			
No. 1	40-50 kg	Hand	30 - 35	920	580	750	75 kg	110 kg	20 cft
S - E	420 kg	5 HP	200	1700	1290	1830	280 kg	430 kg	180 cft
1 - E	300 kg	3 HP	200	1620	1170	1800	225 kg	350 kg	140 cft
2 - E	180 kg	2 HP	200	1420	1100	1550	190 kg	300 kg	80 cft
3 - E	120 kg	1 HP	200	1420	870	1550	160 kg	250 kg	70 cft

5. PEANUT GRADER: This machine will take care of grading the shelled peanuts into four grades, viz. large, medium, small in sizes and imperfect ones as shown in the picture Fig. 3 to 6.

If the impurities are found mixing with peanut, pick them up by finger. Feed perfect peanut beans in the machine and they will be assorted by triple oscillating screens.

Specification of "CeCoCo" Peanut Grader

"CeCoCo" Peanut Grader

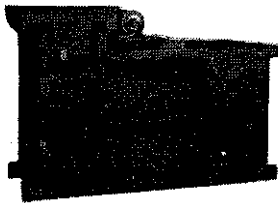

Type	No. 2	No. 1
Capacity per hour	350 kg.	500 kg.
Power Required	1/2 HP	1/2 HP
Revolution	230 rpm	150rpm
Dimension in m/m	Height	1,140 mm
	Width	720 mm
	Length	1,740 mm
Net Weight	130 kg.	180kg
Gross Weight for export	200 kg.	300kg
Ship'g Measurement	65 cft	80 cft

6. PEANUT ROASTER: This machine is used for preparing peanut beans for materials of peanut butter and confectionary and also for a washed unshelled peanut with husk. Roasting drum is big enough with special agitating blades which ensures an excellent mixing of the materials to be roasted by coke or smokeless coal. This machine can be heated by gas or oil. "CeCoCo" can furnish you Gas Burner or Oil Burner at extra cost.

"CeCoCo" Peanut Roaster V-belt drive with motor

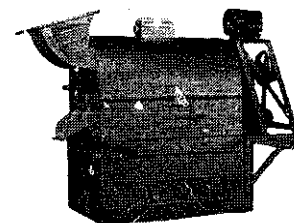

Specification of "CeCoCo" Peanut Roaster Flat Belt Drive Type

Type	Capacity per hour	Power Req'd	R.P. M.	Dimension in mm			Weight/kg.		Ship'g Meas't
				Height	Width	Length	Net	Gross	
No. 1	225 kg.	1 HP	26	1400	1460	2400	415	550	100 cft
No. 2	120 kg.	1/2 HP	28	1180	1150	1850	210	350	60 cft
No. 3	75 kg.	1/2 HP	28	1180	1150	1550	195	300	50 cft

7. PEANUT-BEAN-THIN-SKIN PEELING MACHINE: This machine is used for peeling off the brown thin-skin of peanut beans for making peanut butter and confectionary.

Specification of "CeCoCo" Peanut Bean Thin Skin Peeler

Type	No. 1-D	
Capacity per hour	70 kgs.	
Power Required	1 H.P.	
Revolution	240 r.p.m.	
Dimension in m/m	Height	1,080 m/m
	Width	635 m/m
	Length	940 m/m
Net Weight	130 kg.	
Gross Weight	200 kg.	
Ship'g Measurement	40 cft	

"CeCoCo" Peanut Bean Thin Skin Peeler

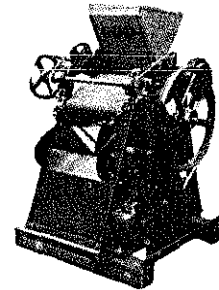

8. PEANUT BUTTER MAKING MACHINE: Feed the parched skin-free-peanut-beans into the hopper, and the machine will do the work of producing the fine and medium quality of the pasted bean for making the peanut-butter instantly.

Specification of "CeCoCo" Peaunt Butter Making Machine

Type	Capacity per hour	Power Req'd	R.P.M.	Net Weight	Ship'r Meas't
RM-6	90 kg.	2 Hp	2800	80 kg	15 cft
RM10	270 kg.	5 HP	2800	150 kg	25 cft

"CeCoCo" Peanut Butter Making Machine

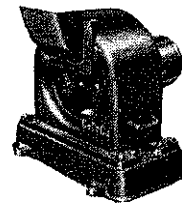

9. PEANUT CRUSHER :

- The construction of this machine does not require any screen and the cutting blade type crusher will instantly pulverize the raw peanut by speed-change-revolution of cutting blade-roll, and the operation is quite free from heat, noise and the machine can stand for long use.
- The machine can freely separate the powder and grains by adjusting the space, and the separation into 4, 6, 8 pieces desired is automatically possible.
- The blade is made of special hard steel with maximum durability and high class bearings are also used to main shaft which ensures a smooth operation.
- A high class magnetic is equipped to the machine for protection of blade and no iron scraps will cause the breakage of blade.

Capacity.....360kg./hour Power Required .....2HP Revolution.....2,500RPM  
 Dimension.....182cmH×76cmW×127cmL Net Weight.....130kg.  
 Gross Weight...200kg. Ship'g Measurement.....80cft.

"CeCoCo" Peanut Crusher

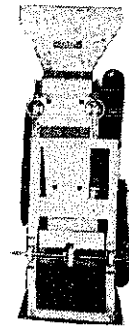

Speciality of "CeCoCo" Small and Compact Machines with Large Efficiency :

Due to each of an unique and special construction as the result of many years of tiresome, practical and commercial experimentations, they are very popularly accepted among the peanut growers in the world with praising reputation. Because, by comparing with large scale equipments, "CeCoCo" machines, though small in scale, gives more of the output recoveries producing much better qualified whole peanuts inflicting no damages to kernels whatever. Consequently, "CeCoCo" strongly recommend you to adapt to increase your profits.

## RICE STRAW & ITS UTILIZATION

The Japanese people have learned since early days the value of **wara** or rice-plant stalks left after rice threshing as material for making things for their daily use. No other rice-growing people in the world have used **wara** so extensively and efficiently as the Japanese.

The Japanese people and particularly those of farming villages cannot live a single day without the use of many things made of the straw. The making of things with rice straw has been the night-work of farmers and their households. Of course, some straw products have recently been made by machinery, but still farming people love to make them at home during long evenings.

First in importance is the making of the straw rope which is invariably used in tying up farm products. In packing and shipping various goods, the rope is absolutely necessary. **Mushiro** or straw matting comes next. They are made generally in a size of three by six feet, but vary in thickness. Farmers use **mushiro** for spreading cereals and other things to dry. The mats are also widely used in wrapping up boxes and other things for shipment. The base of **tatami** or floor mats is made of straw, pressed hard to a thickness of about two and a half inches. **Zori** and **waraji** or Japanese sandals made of straw are worn by the rural people. The snow-shoes of Japan are made of straw, and very warm and comfortable. **Noren** or straw screens are also made, but they are gradually going out of fashion.

A peculiar custom of sleeping in straws is still popular among the rural people of the cold northern regions. The straw is first beaten well to make it soft. The bedroom which has only the bare wooden floor is filled with the beaten straw to a depth of two to three feet and when the sleeping time comes, the people take off their day clothes, and bury themselves in the straw. It is said that under the straw covering they are warm and comfortable. On sunny days, the straw is taken out of the room, and aired in the sun, so that it will dry. Many of the people prefer the primitive covering of loose straws to ordinary **futon** or quilt thickly padded with cotton. The straw is also extensively adapted as a most nourishing food for cattle and poultry raising by cutting it into various sizes with "CeCoCo" chaff cutter of manual and powered types.

### "CECOCO" RICE STRAW SOFTENING MACHINE

For Better Qualified Rope and More Nourishing as Cattle Feed

For making a rice-straw rope, it is essential to break and soften the hard character of stem of straw first. Because a rice-straw is very stiff and hard to twist in its original shape. This special machine will break and soften not only the hard part of straw stem but also leaves to make them all very tender for producing a very fine rope of a high commercial value to make the handling easy and comfortable for tying up the articles. Therefore, when adapting any kinds of straw rope making machines, "CeCoCo" Straw Softening Machine should be used in advance. It softens not only rice-straw but all kinds of fibre, leaves of fruits and bark. "CeCoCo" straw Softening Machine will help feed cattles with softened straw cut in pieces. As it will give them more nourishment than a hard and stiff straw giving no harm to their stomach but stimulates the digestion.

"CeCoCo" Straw Softening Machine

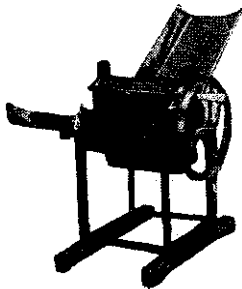

It is metal made throughout and durable. Operation is very simple and easy. When the straws are fed in machine it will automatically break and soften them repeating the action by going back and forth between the rollers equipped with many spiral grooves cut in face of rollers.

Specification of "CeCoCo" Straw Softening Machine

Type	Capacity per hour	power Req'd	Length of Rolls	Diameter of Roll			Dimension in mm			Weight kg.		Ship'g Meas't
				Upper	Middle	Lower	H × W × L			Net	Gross	
Special	25—35 kg.	Hand	370 $\frac{m}{m}$	170mm	100mm	170mm	915	840	1730	70	120	15 cft
Regular	15—25 kg.	Hand	265 $\frac{m}{m}$	170mm	100mm	170mm	915	710	1470	60	100	12 cft
PM	40—60 kg.	$\frac{1}{2}$ HP	370 $\frac{m}{m}$	170mm	120mm	170mm	915	900	1730	80	140	20 cft

### "CECOCO" STRAW ROPE MAKING MACHINE

"CeCoCo" Rice Straw Rope Making Machine

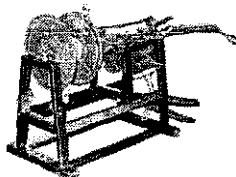

Rice straw has few resistance for external force of tensile strength or bending. It is not liable to use in that condition as the length is also short. By twisting several rice straws to-gether, a piece of straw rope is made and enhances the practical value. As the rice straw rope is composed with several rice straws and embraces each other and frictional force works upon it, the weak parts for tension is covered with symmetrical strength and simultaneously becomes intense.

Rice straw if extensively utilized not only as fertilizer and cattle feeds but also for making straw rope and mat which are indispensable articles in a daily life for tying up farming products and general merchandise and also as the containers. So that it is one

of the most lucrative cottage industries for farm folks to make money during their leisure times. There are many types: pedal, power and automatic feeding of straw. Operation is simple and easy even by young folks and woman.

The "CeCoCo" 2-ply Rope Making Machine is so simple that any person can operate easily after a few minutes' practice. This is very durable and the parts can be replaced easily, so that you can use it for a long time. Rope of different diameter (12 kinds from  $\frac{3}{8}$ " to  $\frac{19}{32}$ " or 4 to 15 mm) and various twists may be made by changing the parts or feeding mouth, springs, eyed-fid, combining pipes and change gears.

The "CeCoCo" 2-ply Rope Making Machine type 'F' is exclusively used for making warp-rope of straw matting from 3 mm to 8 mm in diameter.

Specification of "CeCoCo" 2-ply Rope Making Machine

Type	Construction	Capacity per hour	Hair Shaver	Power Req'd	R.P.M.	Dimension mm			Weight in kg.		Ship'g Meas't
						H	W	L	Net	Gross	
E	All metal	800 to 1,800 ft.	with	Pedal	200-300	940	670	1630	95	140	30 cft
A	Wood frame		with	Pedal	200-300	940	670	1630	85	130	30 cft
G	Metal frame	900-1,800ft.	with	pedal	170-380	940	730	1620	70	110	20 cft

Power operation — The above machines can be operated with electric motor of  $\frac{1}{4}$ HP with at extra cost.

PLEASE SUBMIT SAMPLE: Since there are various kinds of fibre, when writing us for prices, please send us sample of your native fibres for our study and investigation.

### "CECOCO" STRAW ROPE FINISHING MACHINE

There is a rice straw rope machine with fuzz or hair cutter, when the production on a large scale is required, since the rice straw rope core is hard and a coarse straw rope has a lot of fuzz, it is necessary to soften the hard straw rope with straw rope finisher and eliminates the fuzz, and improve the lustre, correct the twisty, produces the round straw rope of regular length and weight. Thus produce a first grade of finished rope which gives a higher commercial value as it facilitates handling with easiness in packing and tying without giving no fatigue to hands in operation.

"CeCoCo" Straw Rope Finishing and Dressing Machine

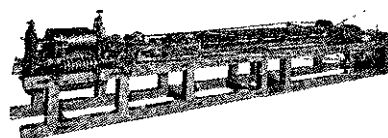

Specification of "CeCoCo" Straw Rope Finishing & Dressing Machine

Type	Capacity per hour	Dia. of Rope to be finished	Power Req'd	R.P.M.	Nos. of cutter	Nos. of roller	Dimension mm			Weight in kg.		Ship'g Meas't
							H	W	L	Net	Gross	
E2-6	90~200 kg.	8~15 mm ( $\frac{5}{16}$ ~ $\frac{10}{16}$ " )	2-3HP	280	6 pcs.	12 pcs.	1100	1100	5850	955	1,400	250 cft

Remark: Capacity will vary according to the diameter or thickness of rope and also feeding speed.

### "CECOCO" STRAW MAT MAKING MACHINE

For Straw Matting, and Straw Bag Making

The principle of this machine suspends 16 to 20 pcs. or more small straw ropes or fibre twines and removes warps mutually back and forth by HEALD. Then the rice straw is carried by rollers and is tightened to reed, and straw-mat is continuously and repeatedly produced. Straw-mat is also stitched for bag, and there is a larger demand for straw-bag or packing materials. Straw mat is different in number of warp, width, length, thickness according to specification. Since the character of the rice-straw is very hard, it should be broken to make it soft, tender and flexible by adapting "CeCoCo" Straw softening Machine. "CeCoCo" Straw Rope Making Machine Type Regular Small for making ropes of a small sizes to be used to make mat as warp.

The straw bag can be made of a rice-straw which is usually left on paddy-field and wasted when rice is harvested. It is very strong and durable and demand is unlimited throughout the world for packing fertilizer, rice, wheat, pea, beans and other cereals, salt, coal, etc. The straw-bag making is an ideal village household cottage industry providing many idle hands with employment giving a lucrative jobs to the natives. It is necessary to cut the stalks of ric-straw about 2 to 3 inches above the soil to keep the straw intact in length.

For making the straw mats, a plenty supply of the rice-straw and small sizes of straw rope  $4\frac{1}{8}$ " for the warp and stitching and  $6\frac{1}{8}$ " or  $10\frac{1}{8}$ " for bag edge protecting purposes is required.

Due to the heavy thickness of straw-mat set in layer and peculiarity of the shape, there is no machine which can weave and stitch the straw-mat automatically, therefore it should be done by hands.

## HOW TO FINISH UP THE STRAW BAG FROM STRAW-MAT :

The straw mat is continuously made by "CeCoCo" Automatic Selvaged Straw Mat Loom Type AS-3 in endless length with 3 feet in width. In order to make the straw bag, cut it out into 6 feet of mat in length with 5 inches of the warp-ropes attached. Therefore, when weaving the endless straw mat leave 10 inches apart in space with the warp-ropes intact between the next mat to weave. Although it's both edges are well automatically selvaged in order to protect the both ends of mat from becoming loose, it is essential to weave them into bag with hands by stitching with a straw rope of  $4\frac{7}{8}$  in diameter.

### METHOD OF WEAVING BOTH ENDS OF STRAW MAT — see Fig. 1

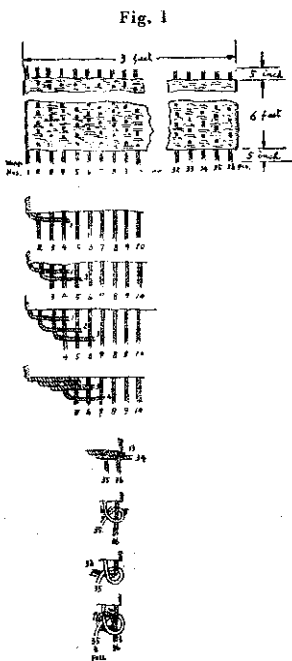

- 1-a) The first and extreme left warping ropes should be bended toward to the right by passing over the second under the third and again over the fourth warping ropes pressing firm and tight.
- 1-b) Bend the second rope and pass over the third, under the fourth and again over the fifth warping ropes toward to the right. In this instance, hold the third and fourth ropes by the right hand fingers whereby the bended first and second ropes by the left hand fingers.
- 1-c) Bend the third rope and pass through the fourth under the fifth and again over the sixth warp-ropes, By holding the fourth and fifth ropes with the right hand fingers pressing firm and tight the next second and third ropes by the left hand fingers.
- 1-d) Thus proceed the bending and passing the ropes consecutively untill all of the warp-ropes are bended, passed, and pressed firm and tight by repeating the process. Be sure that the warp ropes bended should always pass over the next first rope under the second rope and again over the third rope, but no more. That is all. Don't go further.
- 1-e) In tightening up the warp-rope at last stage, copy the same method as ordinarily adapted in packing and tying bag, sack and package as shown in the 4 processing pictures described at the left.

Remarks:— The straw mat made by "CeCoCo" non-automatically selvaged Straw Mat Loom is completely finished for weaving one-end requiring hand weaving, and another end should also be woven by hand.

Fig. 2. The both edges (E) of the straw-mat made by "CeCoCo" Automatic Selvaged Straw Mat Loom are selvaged. However, in order to prevent the ends (L) of mat from becoming loose for convenience of filling and handling the same should be finish-woven by hands as mentioned above Fig. 1.

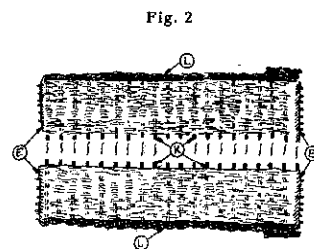

Fig. 3. Finished Straw Bag ; It shows how to fold it in double leaving enough space (I) of about 2.5 inches—a length of the index finger—for cover. List of numbers of parts in processing.

- A) Stitching Straw Rope,  $1\frac{7}{8}$  dia.
- B) Edge Protecting Rope, 5 or  $10\frac{7}{8}$  dia.
- C) Width of Mat or Bag
- D) Fold, 5cm ( $2\frac{1}{2}$ ) in depth
- E) Selvaged Edge
- F) Length of Bag, inside
- G) Length of Bag, outside cover
- H) Length of Bag, overall 6 ft. in standard
- I) Left cover mat for cover, (G) minus (F)
- K) Straw warp-ropes,  $4\frac{7}{8}$  in dia. 36 pieces or 18 pairs in standard
- L) Finished End of Mat
- M) Inside of Bag,
- N) Outside of Bag, longer  $2\frac{1}{2}$  or 5cm than (M)

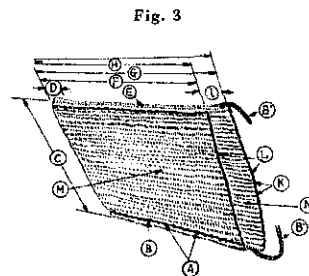
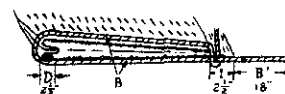

Fig. 4. When you fold the mat in double, care should be taken to make another short double folding of 5cm in center in shape of an opposite direction as indicated by (D) to make this particular part of bottom strong and enough to hold the contents in full. Do not fold the mat in just in center but make one side little longer than other side (I). The Edge Protecting Rope of 6mm or 10mm is tightly stitched in by the straw rope wide of 4mm in

Fig. 4 Side-view of Bag with Edge Protecting Rope



dia. all over around between the second and third warp-ropes (K) of the mat from the edges in order to strengthen the bag to hold the heavy weight materials such as salt, coal, sand, stone etc. Leave about 45cm (18") in length of the Edge Protecting Rope (B) for closing and hemming the mouth.

Fig. 5. Prepare with small rope of 4mm in dia. (A). Make a knob by knotting at it's end which will protect it from escaping when stitched tight and start stitching the Edge Protecting Rope of 6mm or 10mm in dia. (B) weave by the needle (Fig. 7) from the bottom toward to the mouth. When it comes to 2.4cm (1") from the bottom where two pieces of cover mat and the doubled mats (D) come together 4 in layers stitch through them tight and firm. Stitch twice or more around the bottom to insure the durability of the finished mat as shown by Fig. 5. The length of straw rope is required about three times of (F), or 9 to 10 feet for one bag.

Remarks — There are two kinds of the Stitching Needles — One with a hole to pass the rope through and another with a grip at the end.

Fig. 6. In closing and hemming the mouth of bag, stitch with small straw rope (A) pointing the needle from under to upside between the Edge Protecting Rope (Fig. 6-ii) and wind it around tight (Fig. 6-iii) and finally crossing twice between the Protecting Ropes (B) as indicated Fig. 6. When the bag is filled up with substances, stitch over with small straw rope (A) by hemming the mouth.

Fig. 5 Bottom of Bag

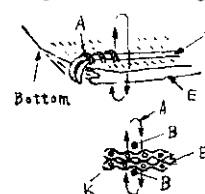

Fig. 6 Mouth of Bag

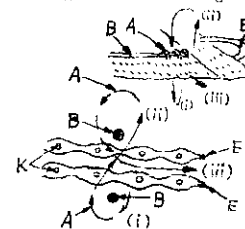
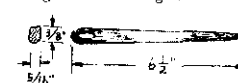

Fig. 7 Stitching needle



#### A) AUTOMATIC STRAW MAT LOOM TYPE AS-3 for exclusively Straw Bag Material —

The "CeCoCo" Automatic Selvaged Straw Mat Loom, constructed entirely of steel, is designed and operated on the automatic roller feeding system. Supplied at the straw supporters fitted on both sides, straw is automatically fed piece by piece between rows of warp-ropes and woven into shape smoothly in regular succession. The machine is very simple and easy of operation. Straw needs no moistening with water when used as material, while even undersized and soft straw can be processed into fine matting in a highly efficient way so that labour and time are greatly saved and economical.

By virtue of pressing drum arrangements, the texture of the fabric is finished with smooth effect with very few stray fringes. For production of fine matting the machine is of unparalleled superiority. The selvaging equipment is of very simple arrangement by which selvaging work is automatically effected in a highly efficient labour saving function.

This machine are equipped with (a) Selvage Trimming Device for automatic selvaging and trimming work, (b) Automatic Gauging device for laying intervals automatically without stopping as planned length is reached, (c) Automatic Stopping Device in case of warp-rope breaking.

Specification of "CeCoCo" Automatic Straw Mat Loom Type AS-3

Type	Capacity Per hour	Power Req'd	R.P.M.	Weaving Width	Dimension mm			Net Weight	Gross Weight	Ship'g Meas't
					H	W	L			
AS-3	48~66 ft. (15~20 m)	1/4~1/2 HP	160-180	Max. 37" (1 meter)	1300	2000	1070	600 kg.	900 kg.	165 cft

"CeCoCo" Automatic Straw Mat Loom Type AS-3

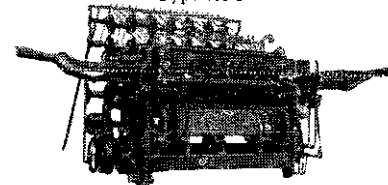

#### B) AUTOMATIC STRAW MAT LOOM TYPE AP-3 for exclusively Packing-material

The demand for packing mat made of rice-straw has considerably increased with the development of industry and supplies with various kinds of package.

For the production of packing mat, it held to make the fine quality of manufactured goods and the large production quantity. Automatic Packing Mat Loom Type AP-3 has been made after long study and research, and its remarkable ability is widely recognized.

"CeCoCo" Automatic Straw Mat Loom Type AP-3, is constructed entirely of iron steel, is designed and operated on the automatic roller feeding system. Supplied at the straw supporters fitted on both sides, straw is automatically fed piece by piece between rows of warp-ropes and woven into shape smoothly in regular succession. The machine is intended to produce matting of under 19 grains and by simple adjustment of the handle, the desired thickness of the matting is obtainable in a highly efficient manner, and it can be equipped with Automatic gauging device.

"CeCoCo" Automatic Straw Mat Loom Type AP-3

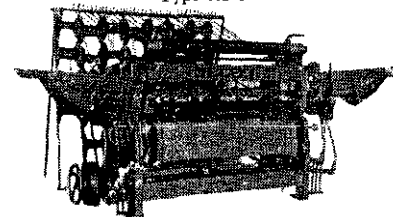



Specification of "CeCoCo" Automatic Straw Mat Loom Type AP-3

Type	Capacity Per hour	Power Req'd	R.P.M.	Weaving width	Dimension in mm			Net Weight	Gross Weight	Ship'g Meas't
					H	W	L			
AP-3	140~160 ft. (43~49 m)	¼ HP	140~170	Max. 4ft. (1.2 meter)	1350	2000	1700	510 kg.	800 kg.	165 cft

Remarks:— The Straw Softening machine and Warp-Rope making machine Type E-1 are necessary.

"CECOCO" STRAW MATTRESS (TATAMI) MAKING MACHINE:

It is used for straw pressed tight in form as a base of mattress and sowed together with rush-mat-covering and is called "Tatami" Standard size of "Tatami": Width 3 ft.; Length 6 ft.; Thickness ½" to ¾".

"CeCoCo" Straw Mattress Making Machine

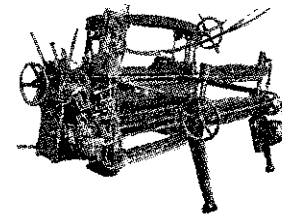

Specification of "CeCoCo" Straw Mattress Making Machine

Type	Capacity per hour	Power Req'd	R.P.M.	Dimension in mm			Net Weight	Gross Weight	Ship'g Meas't
				Height	Width	Length			
Auto	12-15 sheets	1 HP	100	1600	2180	7900	1050 kg	1350 kg	180 cft

"CECOCO" THREE-PLAITED ROPE BRAIDER:

Automatic and Semi-automatic types are used for flat-plaiting of straw, grass, any kinds of fibre, pandanus and coconut leaf, stalk and arrow root strips of prepared kanave bark, "agar-agar" leaves for making floor matting and sandal etc.

"CeCoCo" Three-Plait Rope Braider

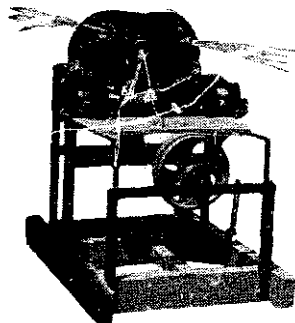

Specification of "CeCoCo" Three-plaited Rope Braider

Type	Capacity per hour	Power Req'd	Size of Pulley	R.P.M.	Dimension in mm			Net Weight	Gross Weight	Ship'g Meas't
					Height	Width	Length			
M100	200 ft.	¼ HP	8" φ × 1½"	100-150	760	840	660	95kg.	125kg.	22 cft

RUSH-GRASS CULTIVATION IN JAPAN

The rush-grass in Japan is manually cultivated in a certain rush field. It is used in Japan as an indispensable rush-matting strewn as "TATAMI" cover in an ordinary Japanese room, which used in a parlor and also in a living room where the sleeping mattress and quilt is spread over, and is extensively used as a beautifully designed and coloured ornaments floor carpet and wall hanger in both Japanese and western styled rooms and houses. But the rush grass grown in wet and marshy places is used for chair bottom, mats and thatch as well as floor carpets. It belongs to the series Liliiflorae of the class Monocotyledons widely distributed in temperate and cold regions and generally perennial herb with a creeping under-ground stem and erect, unbranched, aerial stems, bearing slender leaves which are grass-like or reduced to membranous sheaths.

THE CHARACTER OF THE JAPANESE RUSH is very strong and durable. If properly cultivated it will produce about 4 to 5 feet in length with 5 to 7 cm. in diameter. But usually becomes smaller in size about one foot up to top of stalks. The small inconspicuous flowers are generally more or less crowded in terminal or lateral clusters and are numerous and will bear the fruits with 8 to 20 or 12-13 pieces of tiny seeds in average in each fruit.

It usually begins to bloom at the end of May, some time in June which causes the plant becomes rather weak. It is not recommended to have many inflorescence as they will give much inconvenience in cleaning and grading the plant when cropped. When the plant is well nourished the flower is less but in contrary it bears more flowers and it also varies according to the natures of varieties of rush.

BEST SEASON FOR RUSH CULTIVATION IN JAPAN is beginning of June and also July when the climate is mild and warm with almost of all clear days and toward the middle of July when it becomes much warmer and hot, thus stimulate the brisk growing of plant by drying. However, at the beginning when planted in June the warm climate and sun-ray together with the timely raining will give vigorous stimulation to it's roots diverge. The high temperature and dryness when it matured at the end of July, will considerably help to make the plant much more strong and durable and thus speedy drying is highly recommended in reaping a best quality of crop.

**THE SUITABLE SOIL:** It is desirable to select the place where the irrigation is convenient with well matured and manured deep fertile soil in order to have the fertilizer to be distributed and penetrated thoroughly and speedy. Thus will help grow the plant in a long length producing the best grade of rush.

**VARIETIES OF JAPANESE RUSH & CHARACTERS:** There are three kinds of Japanese rush grass graded according to the sizes, lengths, evenness of stems, divergences of roots, number of clusters of flowers as the small-rush, medium bulrush and large bulrush. Although a large bulrush is easy to yield with a big crop, its character is coarse and bears too many flowers so that quality is inferior. But the small-rush has less flowers so that it produces a very tender and beautiful rush and it will not grow too long in length and crop is rather small. Therefore, it is very important to select the best and most suitable variety in consideration of the climate and soil of the local condition.

In looming it into the mat one with too many flowers is not recommendable as it will disturb in producing best grade matting during operation.

**METHOD OF CULTIVATION:** There are 3 ways of replanting the ratoon, the sprout or shoot from the root of a rush-plant calling them as wet-field seedling, dried-field seedling and fall seedling. In Japan, the fall or autumn seedling is usually adapted in yielding a new seedling in a nursery bed. It is separated from the ratoon left in the field when the rush is cropped in July during next January or beginning or middle of February by digging them out and tying 10 pieces of rush-seedling in a bundle and cut off the superfluous top stems into about 8 inches in length and ready for transplanting. The seedling is transplanted in the nursery bed two to three pieces on a spot with 4 inches apart around.

**RUSH-FIELD PREPARATION:** As explained in the above, under the title of "The Best Season of the Rush Cultivation in Japan", plow under thoroughly mixed with manures such compost, green manure, lime and part of chemical fertilizer distributing them evenly into the field.

**METHOD OF TRANSPLANTING & FERTILIZING:** Plant 2 to 3 pieces of rush-seedlings on a spot in the flat field of every 5 to 6 feet width so that you can easily plant it within the reach of your hand in row of 4 to 5 inches apart in square. Replant the seedling in watered field in a straight direction with depth of one-half inches in deep into soil and press hard the soil when planted and distribute cut-straw or paddv-husk covering well around the seedling and give light fluid fertilizer of any kind. It is also practiced in Japan that at the time when replanting the seedling by separating it from ratoon in winter, the seedling is also grown in the nursery bed.

Weed out whenever it becomes necessary. During the dry season of May and June give the light fluid fertilizer to keep the roots wet to diversify and distribute the ammonia sulphate and superphosphate of lime and other proper fertilizer at the end of June. Ratio of the seedling to grow in the nursery bed and the area of field to transplant seedling is 1 to 50.

For a convenience in replanting the rush seedling in August, if desired, leave one stump of rush in field by cutting off in length of 6 to 7 inches in high to plant it in a nursery bed.

### "CECOCO" GRASS SPLITTING MACHINE

This machine splits automatically and speedily the rush grass or any other similar grass into half. Almost of all kinds of sizes and shapes of grass are separated into 2 pieces and removing core at same time, say 400 whole pieces or 800 splitted pieces per minute in length of up to 5 feet long.

The speciality of this particular machine does not cut across the fibre of grass with the knife or blade but separate the original or natural fibre of grass by means of the thin piano wire into two, thus, not only it retains lustre but also, when it was dried out, withers or turns into rather round-shape leaving no cut-edge, as when it was cut by blade or by other machine. Therefore, after it was weaved or loomed, it will produce a fine matting with a smooth touch.

It will take care of not only 4 to 5 feet of grass in length but even shorter ones such as 10", 20", 30" in length for operation will be adjusted by the spring lever. The machine requires only ¼HP and one operator is easy to attend and any woman even young folks can safely and efficiently handle it. The nature of grass is usually straight in line, but some time, it is crooked or twisted, so that it is dangerous to cut it straight into two by blades, as it will cut the fibre line. However, this machine will split the grass by tracing along the line of grass fibre giving no damage to the fibre when splitting.

The grass is clipped at first stage and automatically splitted by the Revolving Wheel (11½ inches in dia., 400 revolution per minute) until it comes to the point where the clipped end is cut out automatically and the splitted grass dropped into the receiving box in order to be ready to be woven.

### "CECOCO" RUSH AND GRASS MAT LOOM

"CeCoCo" Rush and Grass Mat Loom is constructed entirely of metal, designed and operated on the automatic roller feeding system. The material supporters fitted on both sides, splitted material is automatically fed piece by piece between rows of warps and woven into smoothly in concerted speed and regular succession. The selvages at both ends can be woven into shape automatically and stray fringes are cut-off by trimming device. In case warps are broken or loosened in course of operation, the loom is automatically brought

"CeCoCo" Automatic Rush Grass Splitting Machine Type "A"



to a stop. The thickness of matting can easily be adjusted as desired.

Specification of "CeCoCo" Rush Mat Loom, Type R-2

"CeCoCo" Rush Mat Loom,  
Type R-2

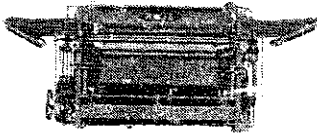

Capacity :—  
 Room matting ..... 6—7.5 meters per hour  
 Seat matting ..... 6—7.5 meters per hour  
 Plain Fancy mat ..... 10—13 meters per hour  
 Weaving Width ..... 37" (1 meter)  
 Power Required ..... ¼ H.P.; Revolution ..... 160—190 r.p.m.  
 Overall Dimension ..... 1,200m/mH × 2,100m/mW × 1,020m/mL  
 Floor Space ..... 4 × 2 meters  
 Labour Required ..... 2 looms per a operator  
 Packing ..... N.W. 540kg.; G.W.800kg.; Meas't 165cft.

"CECOCO" FANCY DESIGNED GRASS MAT LOOM

"CeCoCo" Fancy Mat Loom is constructed entirely of iron and designed and operated on the automatic roller feeding system. The material suppliers fitted on both sides, splitted material is automatically fed piece by piece between rows of warps and woven into smoothly in concerted speed and regular succession. The selvages at both ends can be woven into shape automatically and stray fringes are cut-off by trimming device. In case warps become broken or loosened in course of operation, the loom is automatically brought to a stop. The thickness of matting can easily be adjusted as desired. The loom is capable of weaving mats in a variety of striped patterns by replacing pattern cards. Basically two different colours are available for patterns, but by combining the two colour schemes, four different colours are made possible for a single mat. Weaving being effected in long continuous succession, finished matting can be cut into single pieces of any desired length.

Specification of "CeCoCo" Faucy Mat Loom, Type R-F3

Weaving Width	94 cm(36")	108 cm(42")	122 cm(48")
Revolution r.p.m.	150	140	130
Capacity per hour	5—6m	5—5.5m	4.5—5m
Power Required	¼ HP	¼ HP	½ HP
Overall Height	129cm	129cm	129cm
Overall Width	1339cm	378cm	420cm
Overall Depth	106cm	106cm	106cm
Net Weight	540 kg	560 kg	590 kg
Gross Weight	800 kg	840 kg	900 kg
Ship'g Meas't	165 cft	190 cft	215 cft

"CeCoCo" Fancy Mat Loom Type R-3F

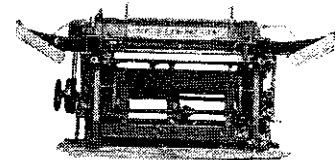

PLEASE SUBMIT SAMPLE: Since there are various kinds of grass, when writing to "CeCoCo" for prices, please send us sample of your native grass for our study to fill your requirements.

"CeCoCo" is ready to offer a high grade of the plain or colored and patterned matting made of rush grass as follow :

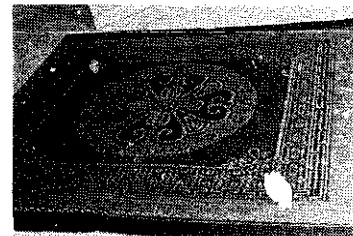
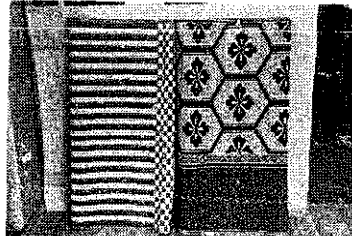
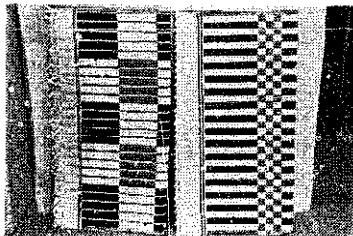

BOX BOARD MAKING WITH RICE-WHEAT STRAW,  
GRASS, AND PAPER WASTE AND FIBROUS FIBERS

The straw and paper boards boxes are extensively used for packing medicines, bottles, biscuits, cake, sweet-meats, electrical goods, hosiery shoes, leather goods, hardwares and almost of all kinds of articles and materials in our life.

The Pakistan Government has recently set a small industrial estate in a rapidly flourishing district of Gujranwala, West Pakistan, having 1,200 small industrial units. Among them, Mr. C.D. Chaudhri, Managing Director, Packers Company, 53-C, Satellite Town, Gujranwala is maintaining very successfully the manufacturing plant of the paper board to be used in packing various materials and articles as above mentioned. In view of the fact, that many valuable materials are laying idle being thrown away as wastes in many other countries, we strongly recommend you to utilize them to the advantage not only to yourself but to your great nation.

## JAPAN'S COIR COTTAGE INDUSTRY ROPES AND TWINES

Coir Twine for Fishing Nets and Ropes for Fishing Boats  
"Cordage, Canvas and Jute World", London

Little seems to be known about Japan's flourishing coir cottage industry. In fact, it has a long history and has recently attracted favourable attention from Pandit P. R. S. Chettiar, chairman of Virakesari Ltd., Colombo. It has also been suggested that an industry of this type would be highly suitable for the Philippines and a study was prepared a short time ago by CeCoCo, or Chuo Boeki Goshi Kaisha, the well-known Japanese machinery manufacturers. The study, the work of the president, Mr. T. Kagawa, takes the form of an outline plan for the development of such an industry, with a training programme.

However, this article is mainly concerned with the older Japanese industry, material having been supplied by CeCoCo.

For hundreds of years, hemp palm trees grew in the Wakayama province of Japan, where the climate is warm and mountainous. In fact, cultivation of this tree provided the staple means of livelihood for the inhabitants. A household rope-making industry was started to improve the standard of living and offer security and by 1857, little over a century ago, it had already grown considerably. The entire population of some villages was engaged in it with almost every member of certain families working. Such a big labour force was needed because there were, as yet, no machines.

About 1912, increased demand meant that local raw material was practically exhausted. Imports from abroad were started, but total output was still produced by hand. The first machines were introduced in 1922. They were somewhat primitive and have been greatly improved since then. During the years after the first world war, large quantities of coconuts were imported into Japan and the village industries enjoyed a golden age. Demand expanded at the same time, owing to many new uses being discovered for coir fibre products. They were made into fishing net twine and twines for all sorts of packaging.

Today, in almost all farmhouses, people work at processing coir fibre, not only for ropes and twines, but for brushes and mats. CeCoCo machines are widely used. About 450 tons of imported coir from either Ceylon or China comes in every month. The monthly value of the finished materials totals 200,000,000 yen. Machinery is installed in sheds and is adapted for operation by one or two horsepower electric motors or they may be worked by means of a treadle. Better machines have led to greater security and to a higher standard of living, so that many of the peasants have purchased even more equipment and rationalised their production.

The number of small cottage factories in the area is estimated at 10,000 or more. Coir and hemp together are valued at 200,000,000 yen monthly or 2,400,000,000 annually. Coir output only has a monthly value of 100,000,000 yen and an annual value of 1,200,000,000 Yen.

A typical rope factory visited by Mr. Kagawa is the Ebara coir rope factory at Misato-cho in Wakayama, where the bristle coir of the third grade and first grade mattress coir are used to make ropes of from half to one inch in diameter.

Equipment consists of a rope making machine, four stranders, three automatic yarn spinning machines, a rope packing machine and a carding machine.

The rope making machine produces three-strand rope and has been specially designed for simplified operation with reduced wastage of raw materials. It has a capacity of 280 ft. of  $\frac{7}{16}$  in. rope per hour, 1,300 ft. 1 in. rope per hour or 656 ft.  $\frac{7}{8}$  in. rope per hour. The strander has been evolved to produce coir strand consisting of any number of yarns made by the spinning machine to any desired thickness. Its capacity is 950 ft. of  $\frac{7}{32}$  in. diameter strand or 1,450 ft. of  $\frac{1}{2}$  in. diameter strand per hour. The yarn spinning machine will turn out 4,000 ft. of  $\frac{7}{32}$  in. diameter yarn in every hour, while the packing machine handles four to eight coils hourly. The carding machine handles combed coir, as well as short fibres of coir. It will deal with 60 lb. per hour.

The production capacity of the whole plant is 680 metres of  $\frac{7}{16}$  in. three strand rope, 1,600 metres of  $\frac{7}{8}$  in. three-strand rope or 2,300 metres of 1 in. rope three-strand also. Seven people are employed. The materials come from Ceylon and the family pay 66 yen per kg. for the mattress coir and 80 yen per kg. for bristle coir. Products for which the mattress coir is used are sold for 92.40 yen and those of bristle coir for 112 yen. The per capital income of those engaged is 400 yen per day of eight working hours. The rate of exchange is about 1,017 yen to £1 sterling and does not fluctuate greatly.

The marketing system is that raw materials are obtained from the wholesale dealer in Kainan City, who in turn obtains them from an importer. An alternative method is for the wholesale dealer to bear responsibility for raw materials, paying the costs of manufacture to the makers in the cottage industry. Finished products are supplied to wholesalers, who undertake distribution. There are no Government controls in operation and no subsidy is given to this industry.

A report is also given of the twine factory at Misato-cho in the same province. Like the rope factory, this is part of the cottage industry complex and turns out  $\frac{3}{32}$ ,  $\frac{5}{32}$  in. twine, using coir fibre. The machinery consists of a coir carder, an automatic coil spreader and 10 two-ply twine spinning machines. The carding machine has the same capacity as that of the rope factory, namely 60 lb. per hour. The spreader handles 66 lb. of raw materials in an hour and the spinning machine will turn out 1,300 ft. approximately of  $\frac{3}{16}$  in. diameter every hour. The production capacity of the factory is 28,000 meters every eight hours of  $\frac{5}{32}$  in. twine or 19,600 meters of  $\frac{3}{32}$  in. twine. Six people are employed in the plant, raw materials come from Ceylon and

they cost 120 yen per kg. Each labourer receives 15,000 yen per month. Marketing conditions are the same as for the rope side of the industry. Here again, there is neither restriction nor subsidy in operation.

While the cottage industry is undoubtedly on a very small scale compared with rope industries of the United Kingdom or Europe or America, it is suggested that it is highly suitable for the conditions prevailing in Japan and that it could have many advantages in other tropical countries, where there is an urgent need to provide more work and to stabilize their livelihood and raise living standards.

## **"CECOCO" COCONUT-FRUITS PROCESSING MACHINERY**

Coconut-fruit



### **COCONUT FRUITS**

Almost too well known no need description, this 'universal provider' comes from a long-lived palm growing sometimes to a height of 100 ft. It is found on most tropical and subtropical shores, but is of particular importance in such regions as Polynesia, Indonesia, Malaysia, Ceylon and Philippines. Flowering follows the usual pattern in palms, the single nuts being carried at the top of the tree in clusters. The coconut palm, sometime known as the 'King of Palms', and its various parts can be put to so many uses that they read like a page from *The Swiss Family Robinson*. The flowers, leaves and nuts between them provide in varied form food and drink, roofing material and coir yarn from which is made string, rope and matting. The dried flesh or 'meat' of the nut is well known in international trade by the name of copra. Coconut oil extracted from this is used for a whole variety of purposes from cooking to the manufacture of candles. In addition, desiccated coconut has a world-wide market while the 'milk' in the nut can be made into various forms of syrup. An important factor which, however, detracts from further development of large-scale cultivation of the coconut is the relatively low income obtained in some areas in comparison with other estate crops.

### **COCONUT TODDY VINEGAR**

Laboratory, pilot plant and factory scale experiments, on the 'Generator' process have clearly revealed the potential possibilities of producing a high grade vinegar from the sap of the coconut palm. It has shown promise of removing the principal disabilities of the existing industry by combining speed of action with economy of labour and ease of operation.

A new vinegar factory has been erected at Nainamadama with a Generator and is now in full scale commercial production. Analytical checks kept over a period of several months at this factory, have shown that the quality of vinegar produced there is very good with acetification efficiencies in the region of 85 per cent and over.

Every country in the world has its own distinctive liquor industry, and in Ceylon coconut toddy the base for the manufacture of arrack. In considering the economics of vinegar production, it is important to note that hitherto this industry has been of subsidiary importance in comparison with arrack manufacture.

With the introduction of the continuous generator process, there is every possibility of producing a vinegar from coconut toddy of a standard comparable with the expensive imported proprietary vinegars. For detailed information in producing the above vinegar, write to Mr. W.R.N. Nathanael, Coconut Research Institute Lunuwila, Ceylon.

### **UTILIZATION OF COCONUT-HUSK and COIR DUST & SHELL**

Although the coconut is used in many ways such as the wood for building, furniture and firewood; the leaves for cajan fan, basket when plaited and for thatching the roof of house; the shell of nut for utensil, coco flour for plastic industry and charcoal; the sap as fermented liquor and coconut-milk, the tender flesh of young nut for food; the coconut meat for coconut oil and the kernel as copra when dried for making soap, candle and margarine, the external husk or rind yield in many occasions is thrown away as waste.

The coconut husk can be utilized for producing an elastic fibre material called coir for manufacturing coarse brush, curled fibre and yarn for making twine, rope, cordage and fishing net, the coir-wool for matting for lobby and passage and door-mat and fibre for upholstering and mattress.

Mr. T. Kagawa President of "CeCoCo" has noticed during his fact-finding-trip in various tropical countries in 1962 - 1963 that an abundant supply of coir dust was laying idle in mountainous quantities everywhere taking large areas becoming a nuisance to the inhabitants. In order to produce something out of such wastes he has researched strenuously since his return to Japan by utilizing the coir dust and finally succeeded in producing the pipe-form solid fuel by briquetting coconut-dust and also saw-dust, groundnut-shell, etc., without using any of glutinous ingredients, and further in making a hard wall board for house building with the coconut-dust or chipped-wood by adding cement in a very simple method.

## "CECOCO" COCONUT CRACKER (DEHUSKER)

The old method used generally even now of cracking coconuts to separate its husk and core (shell) are very primitive and inefficient, whereas, in other fields of industry, far more modernized methods are used now-a-day. In view of this fact, we have long been trying to improve the method of cracking coconut, that is to say, the invention of an efficient coconut cracking implement. Our aim is at last achieved.

By using the "CeCoCo" Coconut Cracker, our invention, you will get the highest efficiency (approx. 100 to 200 pcs. per hour) in the process of cracking the nut, and you can save the labour considerably in its work.



### How To Operate the "CeCoCo" Coconut Cracker :

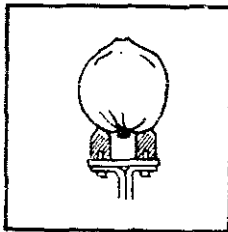

Fig. 1.  
Take a coconut in hands and strike it against the blades of the implement as shown in the sketch. In this case, set the stem of the nut between the blades and let the blades pierce the coconut in parallel to its fibre.

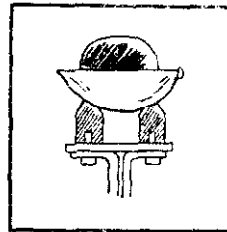

Fig. 3.  
The core of the nut will be attached to one of the blades. Strike this piece against the blades as in the picture. Keep the blades in parallel to its fibre of the nut. Then, turn the handle round and you may have the piece split into a quarter.

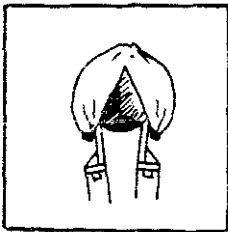

Fig. 2.  
Next, turn the handle round, and you may get the coconut cracked into two pieces which will snap off naturally and then turn the handle in reverse way so that the blades are closed together.

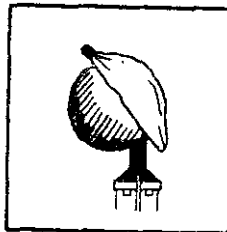

Fig. 4.  
Finally, thrust the blades between the core and husk. Turn the handle, the core will be found entirely snapped off the husk.

## A) COCONUT FIBROUS HUSK PROCESSING

1) COIR EXTRACTION — The first step of husk processing is to extract the thick fibrous mass found between the hard shell and the leathery outer skin of the coconut. The whole nut is rammed against a sharp iron spike and is split into three to five pieces by hatchet. The husk is then separated from the hard shell.

RETTING — The split husk is then seethed or soaked in water. This process is known as wetting or retting, which lasts for a month or longer, depending upon the climatic conditions and the machines being used. Bacterial action during the soaking process helps the separation of the fibre from the dust. In order to facilitate the retting process, the husks are crushed or softened before they are soaked in fresh water or sea shore.

CRUSHING AND SOFTENING — In softening, "CeCoCo" Coconut-husk Crusher is easy and convenient. The purpose of this machine is to soften and crush the husk. The machine has a pair of fluted cast iron rolls arranged in a very rigid frame. One of the rolls is elastically mounted on shock-absorbing springs. The husks are fed into machine at front side, and come out of the opposite side, passing through the rolls.

DECORTICATING OR DEFIBERING — This is the process for extracting the bristle coir from softened and crushed husks and the coir wool or short coir and powder dust are separately combed. "CeCoCo" Coconut Husk Defibering Machine is equipped with balanced rotating drum. All hackling spikes needles are made of tough steel and embedded on cross pieces of rotating drum.

HAND FEEDING MACHINE — In the case of ordinary hackling, the husks are inserted, holding them by both hands, between the two iron rolls and combed by the rotating drum. The spike tends to comb and removes the mixed coir wool and dust, and they will be splashed out at the opposite end. After one half-part was combed, the other half is inserted to the rolls again and the same operation is repeated.

AUTOMATIC FEEDING MACHINE — The husks are fed into the belt conveyors for crosswise and the rotating drum(s) will take care of the hackling action for lengthwise, and the coir wool and powder dust will discharge chute under the drum(s). When they are discharged underneath the drum, are fed into a MATTRESS COIR CLEANING MACHINE or DUST REMOVING MACHINE to remove the coir dust. SINGLE-DRUM AUTO. DEFIBERING MACHINE will card only one half-part of husks and the half-partly combed husks, coming from the belt conveyor, and should be fed again into the machine for further combing of the unfinished-half. DOUBLE DRUMS AUTO. DEFIBERING MACHINE will perform a complete combing

process of whole or both parts of husks simultaneously and economically and the bristle coir will come out at the end of belt conveyor.

DUST REMOVING — "CeCoCo" MATTRESS COIR CARDING MACHINE combined with DUST REMOVING MACHINE will separate the coir wool from dust produced during decorticating process, and coir wool will be used as raw material of low grade of rope, twine, rubberized rope or cushion and hard board etc. and dust can be utilized as raw materials for making briquetted fuel and hard wall board.

"CeCoCo" Coconut-husk Crusher  
Type OKQ-D

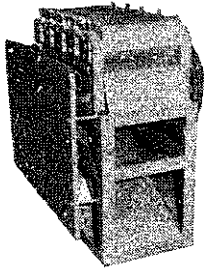

"CeCoCo" Auto. Coconut-husk Defibering  
Machine, Type OLD-D, Double drums

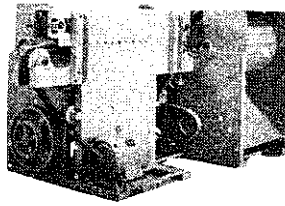

"CeCoCo" Auto. Coconut-husk Defibering  
Machine, Type OKL-D, Single-drum

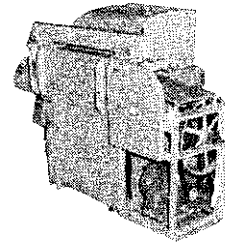

"CeCoCo" Mattress Coir Carding Machine combined with  
Dust Removing Machine Type 3-N

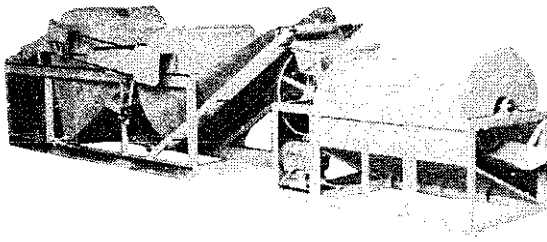

Ⓔ Split Husk



Ⓕ Crushed Husk



Ⓖ Coir Bristle



Ⓗ Coir wool



Specification of "CeCoCo" Coconut-husk Crusher

Type	Capacity in husk per hour	Power Req'd	R.P.M.	Dimension in mm			Net Weight	Gross Weight	Ship'g Meas't
				Height	Width	Length			
OKQ-D	100-200kg. (500 pcs.)	2 HP	240	1,080	480	750	300kg	480kg	45 cft
OKAS	20- 40 <sup>+</sup> g. ( 80 pcs.)	2-men	proper	1,120	940	760	225kg	330kg	45 cft

Specification of "CeCoCo" Coconut-husk Defibering Machine

Type	Capacity in husk per hour	Power Req'd	R.P.M.	Dimension in mm			Net Weight	Gross Weight	Ship'g Meas't
				Height	Width	Length			
OKL-D	100-170kg. (300 pcs.)	2HP×2	280	1,100	940	1,800	500kg	840kg	115 cft
OLD-D	200-250kg. (600 pcs.)	3HP×3	280	1,100	1,120	3,350	1000kg	1750kg	280 cft
OKBM	3- 5kg. ( 10 pcs.)	Foot	proper	940	910	1,000	120kg	200kg	56 cft

Specification of "CeCoCo" Mattress Coir Carding Machine

Type	Capacity in short coir per hour	Power Req'd	R.P.M.	Dimension in mm			Net Weight	Gross Weight	Ship'g Meas't
				Height	Width	Length			
3 N	100 to 150kg.	2 & 1HP	650	1,330	1,030	4,910	300kg	660kg	350 cft

\* For the decorticating plant desired, please let us know the average weight of your coconut-husk (without meat and hard-shell), percentage of bristle coir and coir wool, and capacity; the details of electric source as phase, voltage, frequency and current.

Remark: Capacity in weight varies according to average weight of a husk and percentage of bristle coir and coir wool and dust contained in a husk, etc.

The method of calculating the capacity in weight as follow;

Average weight of a whole-husk × hourly capacity in pieces × working hours × bristle (or coir wool, dust) containing percentage × 80% efficiency = decorticated products weight

For example, if the weight of husk is 300 grams and bristle coir containing percentage is 10% - 15%,—

300 g × 550 pcs. × 8 hours × 10-15% × 80% = 100 to 150 kgs. per day by Coconut-husk Crusher Type OKQ and Coconut-husk Defibering Machine Type OLD one set each.

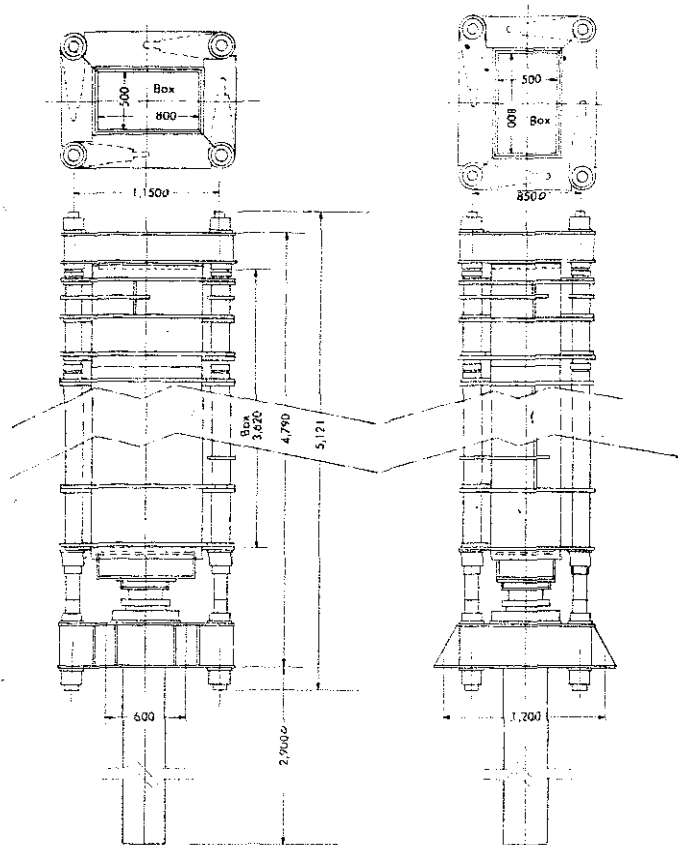

### "CECOCO" FIBRE BALING PRESS

Consists of Press, 40HP Hydraulic Pump, and Oil Circuit

- 1) Press :
  - Type.....Four column Upright Type Hydraulic Press
  - Capacity.....100 tons
  - Size of Ram.....250mm dia. x 3,500mm stroke
  - Working Pressure.....200 kg/cm<sup>2</sup>
  - Size of Material Box.....3,620mm x 800mm x 500mm
  - Size of Bale to be pressed.....680mm x 800mm x 500mm per bale
  - Weight of Bale...150kgs. per bale, about 10cft.
  - Speed...ascent...1,460mm/min. at 0-30kg/cm<sup>2</sup> pressure:  
220mm/min. at 31-200kg/cm<sup>2</sup> pressure
  - descent... 3,000mm/min.
  - Erection.....On fully concrete area
  - Space Required.....4 x 3 meters to house baler and pumping unit and within this area a pit 1.5 x 1.5 x 5.5 meter deep to house ram and base of press.
  - Output.....approx. 10 to 15 bales per hour
- 2) Pump :
  - Type.....Hydraulic L-P pressure pump
  - Power Required.....40 HP x 6 P motor; Revolution.....1,160 R.P.M.
  - Volume...72 litres/min. at 30kg/cm<sup>2</sup> pressure  
11 litres/min. at 200kg/cm<sup>2</sup> pressure
  - Pressure.....200kg/cm<sup>2</sup>

### "CeCoCo" DRY COCONUT FIBROUS HUSK DEFIBERING MACHINE

No Crushing Machine and Retting Necessary

Since we have announced as "Advance Notice" in page 84 of our "CeCoCo" 6th edition booklet "Providing the world with more Food & Employment", we have finally succeeded in accomplishing a new epoch-making dry coconut husk defibering and powdering machine after 3 years of weary and untiring efforts.

The advantages of this new machine is that it does not require crushing machine as hitherto used and eliminate the retting process and can be carried around from place to place in coconut estates and all of the products, that is, thoroughly cleaned fibre, short husk-coir and powder corks (upto 300 mesh) are well dried ready to be used for different purposes of industrial and chemical uses, therefore, the time and labour in carrying and collecting for retting and crushing husks are entirely saved. The machine can easily feed splitted-in-half-husks in a second by hand. That is about 200 pcs. of whole husk or 600 - 1,000 pcs. in splitted husks per hour or 2,000 pcs. of whole-size husks per a day of 10 hours and output is admirable and excellent.

The 7-8H.P. combustion engine or electric motor will operate the machine and the same can easily be carried around on the trailer and due to compactness of construction, light weight and maneuverability, it is strongly recommended to be adapted in every coconut estates in the tropical countries.

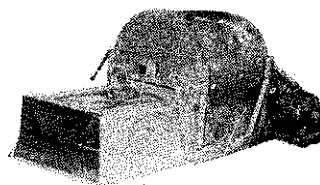

### COMBING NEEDLES (STEEL SPIKE)

This is used for Defibering Machine, Coir Carding Machine, Coir Spreader, Automatic Twine Making Machine and Automatic Coir Yarn Making Machine, etc, and the price will be quoted if you will let us know the type of machine and required quantity.

Combing Needle (Steel Spike)

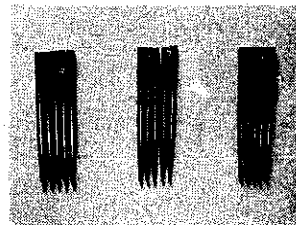

Specification of Combing Needles

Diameter of Shank	4.2 mm	4.3 mm	5.0 mm	5.5 mm	6.0 mm
Weight per 1,000 pcs.	6.6 kg	9.2 kg	11.6 kg	15.0 kg	17.0 kg



2) COIR TWINE & HOW TO MAKE IT — The twine processed by our "CeCoCo" machines is suitable for fishing net, and mat manufacture. The first stage is coir carding, and sliver making, then twine making.

**CARDING** — "CeCoCo" **CARDING MACHINE** is used for unravelling and scattering the bristle coir and short cut hard-fibres of about 10 inches long for combed condition so that the fibres can all be unravelled and prepared in a proper condition for making Sliver and Yarn.

**SLIVER** — "CeCoCo" **SPREADER (SLIVER MAKING MACHINE)** takes the Sliver from the Carding and produces the fine sliver into further proper size suitable for **AUTOMATIC TWINE MAKING MACHINE** and **YARN MAKING MACHINE**.

**TWINE MAKING MACHINE** — This machine is used for twisting the 2-ply or 3-ply twine from Sliver automatically without any special skill and technique and the twine is made in uniform sizes and of even thickness required by replacement and adjustment of the parts (Crow-Mouth, Eyed-Twist Metal, Pull-Roller, Worm Gear and Worm Wheel) for producing from 3 mm to 6 mm in 2-ply and from 5 mm to 12 mm in 3-ply.

**FINISHING** — "CeCoCo" Twine Balling Machines will wind the ball style of thinner twine (up to 5 mm in dia.) as finished products, from 2.5kg. to 4 kg. in weight per a ball.

"CeCoCo" Carding Machine  
Type OKR-D

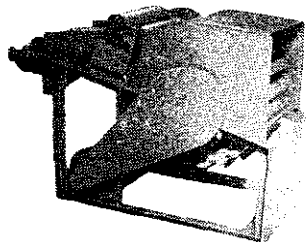

Finished Coir Twine

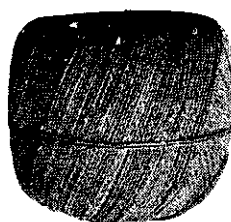

"CeCoCo" Spreader  
Type OKS-D



"CeCoCo" Automatic Twine Making Machine  
Type M-D 2-ply  
Type N-D 3-ply

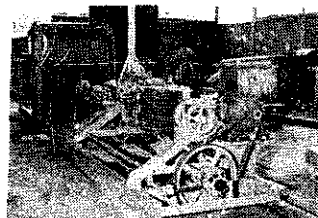
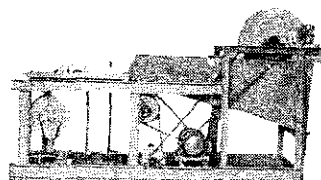

"CeCoCo" Twine Balling Machines  
Type P-D 2-ply  
Type O-D 3-ply

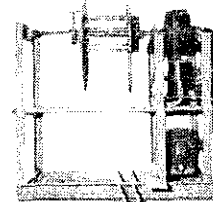
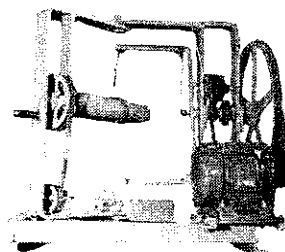

Specification of "CeCoCo" Twine Making Machine

Name of Machines	Carding Machine	Spreader	Auto. Twine Making m/c		Balling Machine		
			2-ply	3-ply	2-ply	3-ply	
Type	OKR-D	OKS-D	M-D	N-D	P-D	O-D	
Dia. of Twines			2 to 6 mm	5 to 12 mm			
Capacity per hour	70 kg.	15 to 30 kg.	3 mm-300 m 4 mm-420 m 5 mm-450 m 6 mm-360 m	5 mm-450 m 8 mm-380 m 10 mm-360 m 12 mm-300 m	3 to 10 km	1 to 2 km	
Power Required	1/2 HP	1/2 HP	1/2 HP	1 HP	1/4 HP	1/4 HP	
Revolution per min.	220 r.p.m.	180 r.p.m.	410 r.p.m.	220 r.p.m.	100 r.p.m.	180 r.p.m.	
Dimension in m/m	Height	910	1,450	1,180	1,170	780	910
	Width	640	670	660	870	670	635
	Length	1,285	3,580	2,130	4,660	835	765
Net Weight	140 kg.	400 kg.	200 kg.	550 kg.	100 kg.	80 kg.	
Gross Weight	270 kg.	750 kg.	350 kg.	1,000 kg.	180 kg.	180 kg.	
Ship'g Measurement	75 cft	210 cft	95 cft	220 cft	30 cft	40 cft	

**HAND FEED TWINE MAKING MACHINE** — This machine will easily and instantly produces twine out of bristle coir and also long fibres, such as Sisal, Abaca, Hemp and hard-plant-fibres etc., provided they

should be cut short about 2 to 3 feet in length, also with the dropped short fibre. The speciality of this machine is to handle any kind of raw materials of fibre and does not require a special processing in making a yarn and strand separately, thus eliminates a great deal of time and troublesome labour of making and prepare them in advance.

Adjustment of the thickness of twine can be made by changing four parts: viz. crow-mouth, plate spring, eyed twist metal and change gear.

Specification of "CeCoCo" Hand Feed Twine Making Machine

Type	'A'	'B'	'C'	'D'
No. of Ply	3-ply	3-ply	2-ply	2-ply
Capacity per hour	60—120m	100—160m	60—120m	100—160m
Dia. of Twine	3/16" to 1/2"		1/8" to 1/4"	
Power Required	Foot	1/4 HP	Foot	1/4 HP
Revolution. R.P.M.	Proper	70—100	Proper	100—150
Dimension in m/m	Height	900	900	860
	Width	600	600	540
	Length	1,900	2,100	1,750
Net Weight	75 kg	120 kg	60 kg	100 kg
Gross Weight	150 kg	200 kg	120 kg	170 kg
Ship'g Meas't	35 cft	40 cft	30 cft	35 cft

"CeCoCo" Hand Feed Twine Making Machine  
Type 'B' 3-ply, Powered

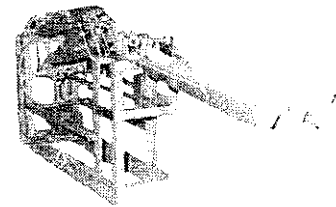

Type 'D' 2-ply, Powered

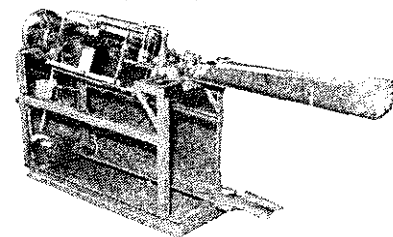

**SAMPLE OF FIBRE REQUEST**— Since there are various kinds of fibre, when writing us please send us sample of your native fibres for our study to fill your requirements.

**GURLED COIR FIBRE ROPE**— Rubber Coir Mattress is made by spinning the bristle coir fibre by means of producing the curled rope which is unravelled on a wide conveyor where it is sprayed with a prepared latex and cut into desired sizes, and placed in the vulcanizing chambers to be finished.

Short coir fibre is also utilized for making automobile cushion and upholstery stuff by spinning and curling, latexed and vulcanized in a same process as above.

For above purpose "CeCoCo" Coir Spinning & Curling Machine is extensively adapted with a good result. "CeCoCo" Coir spinning Machine will produce the curled rope consisting of one single strand only from coco fibre of any length including coir wool. The machine is fully automatic by feeding material in a hopper and automatically stops when the spun and curled rope is fully fed in a bobbin. It is exported to foreign countries as there is a great demand in turning the material into the shape of spun, and curled rope can be pressed by the baling press. The curled rope will be carded in a carding machine as a second process in the upholstery factory.

Specification of "CeCoCo" Coir Spinning & Curling Machine

Type ..... OKU-D  
 Capacity ..... approx. 50—60 kg. per hour  
 Power Required ..... 3 HP  
 Revolution, Bobbin ..... 230r.p.m.  
     Drum ..... 180r.p.m.  
 Dimension, Height ..... 1,030m/m  
     Width ..... 1,170m/m  
     Length ..... 4,100m/m  
 Net Weight ..... 1,000kg.  
 Gross Weight ..... 1,700kg.  
 Ship'g Measurement..... 350 ft.

Curled Fibre Rope



"CeCoCo" Coir Spinning and Curling Machine

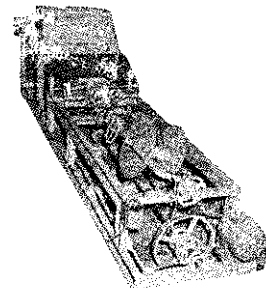

For unlimited demand for all kinds of upholstery industry

3) UTILIZATION OF 2-PLY TWINE —

**FLOOR MAT & DOOR MAT**— The "CeCoCo" Floor Mat Making Machine and Door Mat Making Machine are made of the well dried hard-wood and can be operated by hand and foot in manufacturing almost of all kinds of fibre matting by arranging 2-ply twine in various ways.

**FISH NET MAKING MACHINE**— The purpose of semi-automatic Flat-knot (Homme) Fish netting which has hitherto been made by man-power. In case of netting by man-power, it has used to pedal a board at the right end of machine by right foot and springing off needles by revolving the spiral shaft. Such operation is now done by motive power. It requires a great deal of labour for manual operation of the machine especially it was too heavy work for large machine. By employment of motor, however, the fastigue for the operation comes to nothing and save a great deal of time and is possible to weave the 200 mesh

width of net which is 2 times the width of conventional net.

"CeCoCo" Floor Mat Making Machine

Floor Mat

"CeCoCo" Door Mat Making Machine

Door Mat

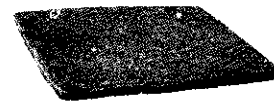
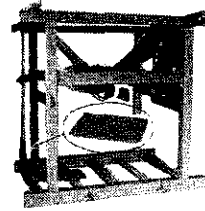
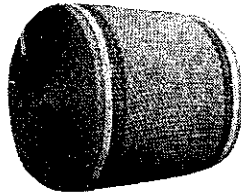
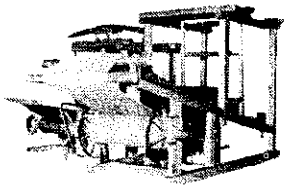

Specification of "CeCoCo" Mat Making Machines

Name of Machine	Type &	Approx. Capacity per hour	Dimension in mm			Net Weight	Gross Weight	Ship'g Meas't
			Height	Width	Length			
Floor Mat Loom	Treadle	3 ft. x 7 ft. long	2,230	1,350	4,050	250kg	410kg	200 cft
Door Mat Loom	Hand	2 ft. x 2 ft.	1,650	1,250	1,820	100kg	200kg	150 cft

Specification of "CeCoCo" Fish Netting Machine

Type	Semi-automatic 'Otsu'
Power Required	1/4 HP and Treadle
Revolution	200 r.p.m.
Netting Depth	150 meshes
Capacity per hour	150" long in 2" mesh
Stretch Range of Mesh	6" - 1 1/4"
Type of Knot	Flat-knot 'Homme'
Net Weight	100 kgs.
Gross Weight	160 kgs.
Ship'g Meas't	45 cft

"CeCoCo" Fishing Net Making Machine

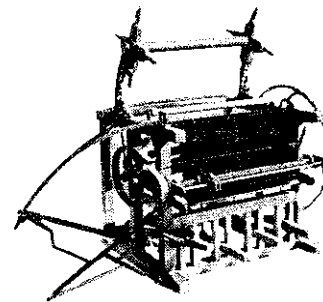

- 4) **COIR ROPE** — In finishing of coir fibre series of machines are utilized. The first stage is coir carding, 2nd sliver making and yarn making, then strand making and finally rope twisting. The final rope can then be rolled on a standard coil by Rope Packing Machine ready for market.

**CARDING & SLIVER** — same as above-mentioned in Coir Twine.

**YARN MAKING** — In the yarn making process, a spinning principle is adopted. "CeCoCo" Automatic Yarn Making Machine is used for spinning the unravelled fibre or sliver. The yarn is produced automatically by scattering uniformly unravelled fibre on the conveyor, and fibre is fed and smoothly conveyed to spun into yarn with an equal thickness of 5.5 m/m or 7/32" (standard diameter) and wound on the two bobbins simultaneously.

**STRANDING** — Take out the yarn bobbins spun by Yarn Making Machine and set them to the bobbin stand of Strander and produce the strands automatically. The number of yarn is decided upon according to the desired diameter of rope (as shown in following table), and the strand is made in uniform sizes and even thickness required by replacement of the Twist Table and Change Gear.

**STRAND RE-WINDING** — The Strand Rewinder is used for re-winding of the strand prior to proceeding with Rope Twisting Machine in order to furnish the strand in a correct form of direction for twisting.

**ROPE TWISTING** — By setting 3 pcs. of strand bobbins (take out Strander) to "CeCoCo" Rope Twisting Machine, the strands will automatically be twisted into 3-ply rope. We can also supply a machine for twisting 4-ply or 4-strands rope. Rope of different diameter from 3/8" to 1 3/8" every 1/8" and various twists can be made by simply changing the eyed-twist metal and change-gears.

**ROPE FINISHING** — By taking out the bobbin of rope produced by Rope Twister, "CeCoCo" Rope Packing Machine will finish the rope into the shape of roll ready for market.

Specification and Table of Coir Rope in 3-ply, Produced by the "CeCoCo" machines above mentioned (per roll of 200 meters long in standard)

Dia. of Rope	3/8"	1/2"	5/8"	3/4"	7/8"	1"	1 1/8"	1 1/4"	1 3/8"	inch.
Nos. of Yarn used	12	18	24	30	33	36	40	45	52	pcs.
Approx. weight per roll in kg	6.5	15	26	33	50	59	80	105	120	kgs.
Tearing Strength	0.27	0.45	0.78	0.93	1.30	1.55	1.80	2.20	2.50	ton
Dia. of Strand	7/32"	1/4"	5/16"	3/8"	7/16"	1/2"	9/16"	5/8"	11/16"	per ply

"CeCoCo" Automatic Yarn Making Machine  
Type G-D  
(2-spindle Spinner)

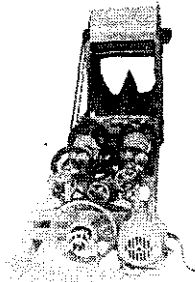

"CeCoCo" Automatic Strand Making Machine  
Type OKD-D

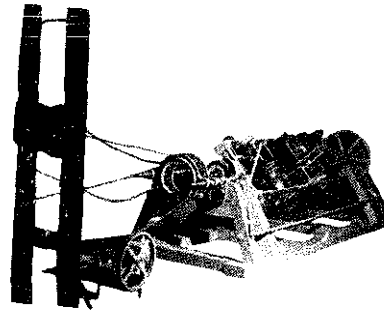

"CeCoCo" Automatic Rope Making Machine  
Type OKF-D

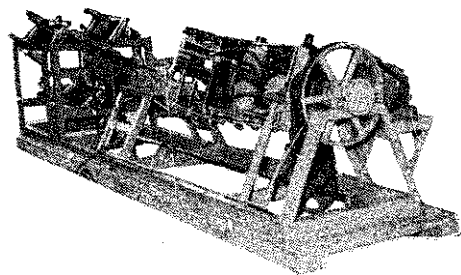

"CeCoCo" Rope Packing Machine  
Type J-D

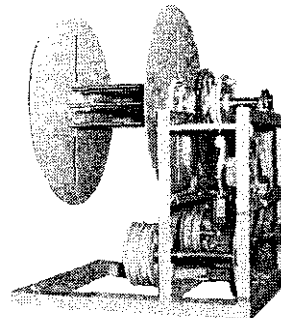

Finished Rope for market

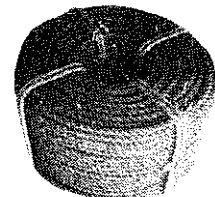

Specification of "CeCoCo" 3-strand Rope Making Machine

name of machine type	Auto. Yarn making m/c	Automatic Strand Making Machine		Automatic Rope Making Machine		Rope Packing Machine	
	G-D	OKC-D	OKD-D	OKE-D	OKF-D	J-D	
Produce Diameter	Aver. $7/32$ " (5.5mm)	$3/8$ " to $3/4$ "	$7/32$ " to $1/2$ "	$3/4$ " - $1 3/8$ "	$3/8$ " - 1"		
Hourly Capacity	2,000 meters	200-550m	350-550m	300 - 500 meter		500 - 1,000 mt.	
Power Required	1 HP	2 HP	1 HP	3 HP	2 HP	$1/2$ HP	
Revolution	310 r.p.m.	120 r.p.m.	220 r.p.m.	120 r.p.m.	150 r.p.m.	100 r.p.m.	
Dimension in m/m	Height	1,100	930	880	1,300	1,080	1,280
	Width	900	910	850	1,190	1,100	1,050
	Length	4,850	5,080	4,130	5,980	4,250	960
Net Weight	550 kg.	470 kg.	350 kg.	1,300kg.	850kg.	300 kg.	
Gross Weight	1,230 kg.	770 kg.	620 kg.	1,900kg.	1,300kg.	500 kg.	
Ship'g Meas't	220 cft	160 cft	100 cft	350cft	250cft	120 cft	

\* For twine and rope plant desired, please let us know the condition of fibre, desired diameter of products and capacity per day each diameter, kind of motive power, and if motor driven, also specify phase, voltage, frequency and current.

### 5) COIR KITCHEN BRUSH MAKING PROCESS —

1st stage — The "CeCoCo" Wire Cutter is used for nipping wrought iron wire of BWG # 14 to # 16. It is possible to adjust the length of the wire according to the size of the swab.

2nd stage — The "CeCoCo" Bristle Coir Cutter is used for cutting a bundle of coir bristle of about 2 inches in length by tying-up with a rubber band.

3rd stage — The "CeCoCo" Brush Twister is used for twisting the cut coir bristle and wires. By putting the bristle evenly with fingers into a pair of nipped wire held in the machine, turn the handle of machine to the right to produce a cylindrical brush.

Finished — The "CeCoCo" Brush Shearing Machine is used for finishing the cylindrical products. The finished cylindrical product will be U-shaped, which is bound with a piece of 2-ply twine and the ends of the wire are twisted. Thus, the swab is completed.

Specification of "CeCoCo" Kitchen Brush Making Machine

Name of Machine	Type	Approx. Capacity per hour	Power Req'd	Dimension in mm			Net Weight	Gross Weight	Ship'g Meas't
				Height	Width	Length			
Wire Cutter	BW	2000 to 3000 pcs.	Hand	250	900	1,800	5 kg.	10 kg.	2 cft
Bristle Cutter	BC	120 to 250 pcs.	Hand	2,100	200	300	4 kg.	8 kg.	2 cft
Brush Twister	BT	60 pcs.	Hand	250	280	1,100	6 kg.	15 kg.	4 cft
Shearing m/c	BS	600 pcs.	1/4 HP	550	380	930	60 kg.	100 kg.	20 cft

"CeCoCo" Wire Cutter  
Type 'BW'

"CeCoCo" Bristle Cutter  
Type 'BC'

"CeCoCo" Brush Twister  
Type 'BT'

"CeCoCo" Shearing Machine  
Type 'BS'

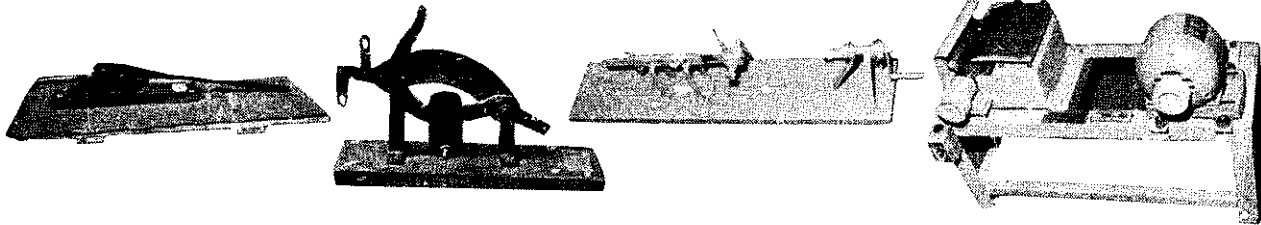

COIR TWINES AND ROPE MANUFACTURING PLANT

Output:— approx. 100 tons of twines and approx. 100 tons of ropes total 200 tons per year of 2,400 hours working (8 hours/day × 25 days/month × 12 months/annum)

Quantities of Coconut-husk to be treated:—

4,500,000 to 6,000,000 husks per annum

Output of Long Bristle Coir to be defibered:—

200,000 to 300,000 kgs. per annum

Output of Short Cois/Mattress to be defibered:—

105,000 to 255,000 kgs. per annum

Output of 2-ply Twine in 3 to 6mm dia. (1/8"-1/4"φ):—

45,000 to 60,000 kgs. per annum

Output of 3-ply Twine in 5 to 12mm dia. (3/16"-1/2"φ):—

30,000 to 90,000 kgs. per annum

Output of 3-ply Rope in 20 to 35mm dia. (3/4"-1 3/8"):—

96,000 to 180,000 kgs. per annum

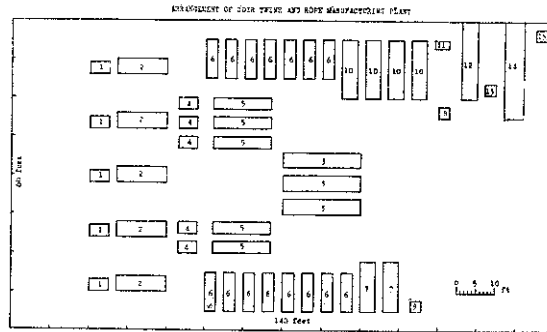

No.	Name of Machine	Type	Quantity	No. of Worker	Total H.P.
1	Coconut-husk Crusher	OKQ-D	5 sets	5	10
2	Auto. Defibering Machine	OLD-D	5 sets	5	45
3	Mattress Carding Machine	3N	3 sets	3	9
4	Coir Carding Machine	OKR-D	5 sets	5	2 1/2
5	Sliver Making Machine	OKS-D	5 sets	5	2 1/2
6	Auto. 2-ply Twine Making Machine	M-D	15 sets	3	7 1/2
7	Auto. 3-ply Twine Making Machine	N-D	2 sets	1	2
8	2-ply Twine <sup>3</sup> Balling Machine	P-D	1 set	1	1/4
9	3-ply Twine Balling Machine	O-D	1 set		1/4
10	Auto. 2-spindle Yarn Making m/c	G-D	4 sets	2	4
11	Yarn Re-winding Machine	K	1 set		1/4
12	Auto. Strand Making Machine	OKG-D	1 set	1	2
13	Strand Re-winding Machine	H-D	1 set		1/2
14	Auto. Rope Twisting Machine	OKE-D	1 set	1	3
15	Rope Packing Machine	J-D	1 set		1/2
	Odd-jobs			10	
	Total			42 persons	89 1/4 H.P.

## MANUFACTURING PROCESS OF COCONUT-FIBROUS-HUSK (COIR) PRODUCTS

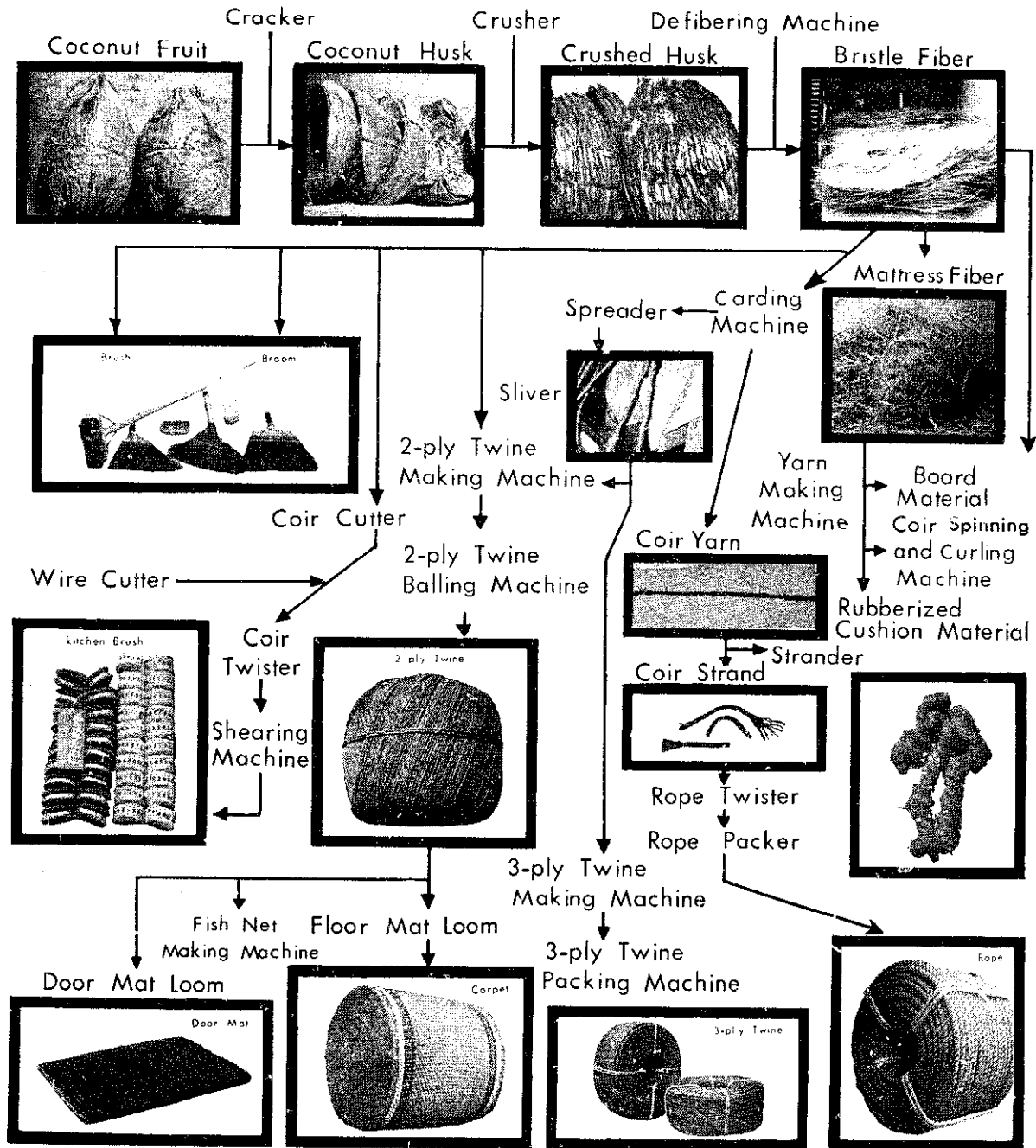

### HOW TO EXTRACT COPRA-MEAT FROM DEHUSKED COCONUTS

The most economical and popular way of extracting meat section from husks, which will be dried and made into copra is the manual method of extraction. The dehusked nuts are cut into halves then smoked and when partly dried, the meat is removed and cut into smaller sizes before further drying them. Coconut shell and husk is direct or indirectly heated from 8 feet distance from below the burning fire for about 10 hours until moisture content reduced to 20%, heat is regulated with fresh husk added one by one, thrown from afar, because the heat is so intense that they cannot approach the heater. In southern Philippines like Visaya and Mindanao, instead of heat, people just day under the sun, leaving husk for 3-4 days in the open field, on condition no rain comes.

# "CECOCO" COIR-WOOL (AND/OR WOOD-WOOL) BOARD MAKING PLANT

Output:- approx. 640 to 800 sheets of 3 ft. width×6 ft. length per 8 hours

Required Workers:- 17 to 20 persons (including 4 to 5 persons for making wood-wool)

Area of Factory:- approx. 216 sq. ft. (2 ares) Area of Site:- approx. 8 to 10 ares

Material to be used:- Wood-wool and/or coir wool and cement.

## Arrangement of "CeCoCo" Coir-wool (or Wood-Wool) Board-Making Plant

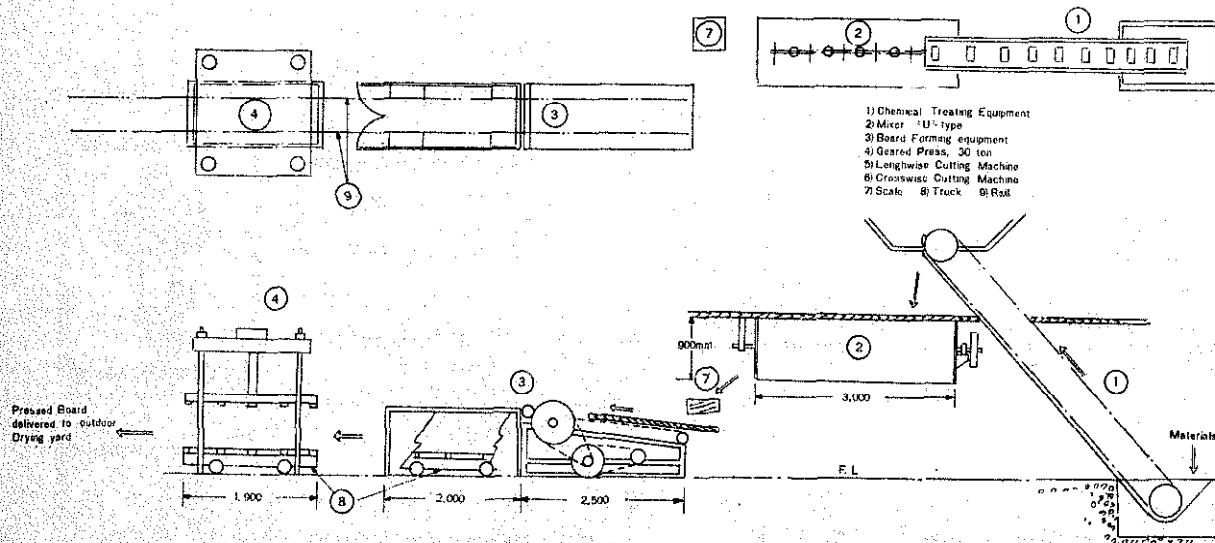
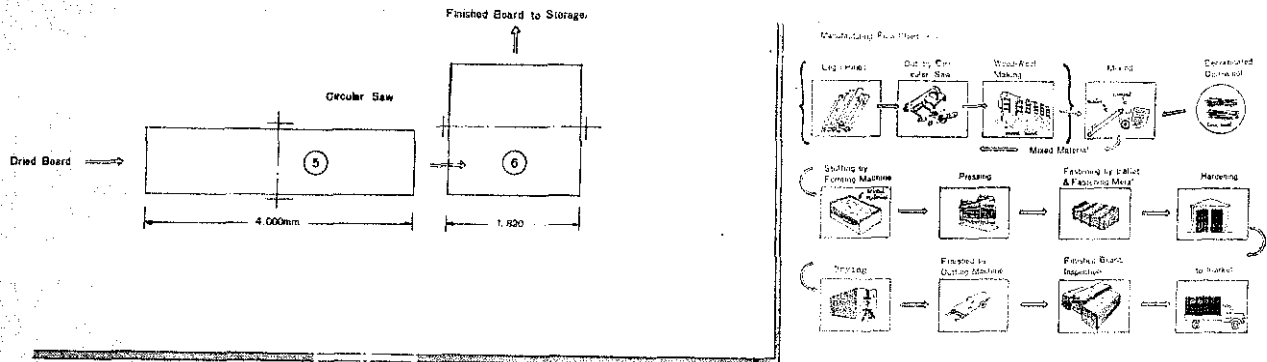

Wood-Wool Making Machine



Chemical Treating Equipment



'U' Type Mixer

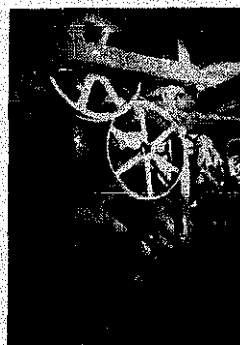

30 Ton Press



Pressed-board for drying

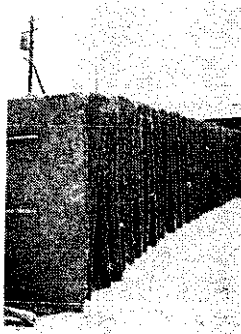

Lengthwise Cutting Machine

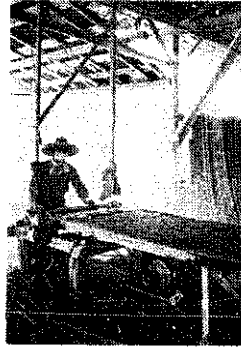

Crosswise Cutting Machine



Product (Finished board)

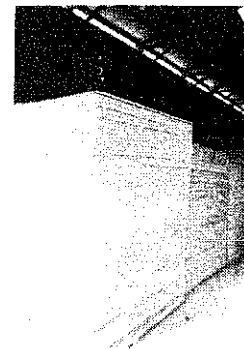

## B) COCONUT HARD SHELL PROCESSING

### COCONUT HARD SHELL CHARCOAL GAS PRODUCER UNIT FOR MOTIVE POWER —

Many countries are unfavorably confronted with the problem of insufficient supply of fuel oil which is expensive, irregular and a heavy item in imports. While it costs high when delivered to far-away area where Coconut is grown, Coconut-shell-charcoal gas can be produced very economically on-the-spot, and have a considerable advantage that the power produced by said charcoal gas with certain gas engine can be used without regards to geographical conditions where an electricity is inaccessible. During the war, Japan has suffered very seriously since a fuel oil could not be imported and obliged to adapt the charcoal gas for automobile, truck and all other means of motive power for industries, farming, especially for irrigation and saw-milling. A portable set of 10 H.P. Gas Engine and Charcoal Gas Producer were very conveniently and economically used for saw milling in the mountain to save an unnecessary transportation expense to the congested towns to cut down the overhead expenses, thus it can be adapted for optimum efficiency and economy in many branches of production.

"CeCoCo" Gas Producer



Coconut Hard Shell



Demonstration in the Philippines



Specification of "CeCoCo" Gas Producer Unit

Type	Suitable Horse Power	Net weight	Gross Weight	Ship'g Meas't	Calorific Value (Cal./kg.)
S	8~12 HP	250 kg	350 kg	45 cft	Coal .....4,500-7,500
M	15~20 HP	350 kg	500 kg	55 cft	Charcoal .....6,700-7,500
L	30 HP up	400 kg	580 kg	75 cft	Cokes .....6,000-7,000
					Saw-dust Briquette 7,500-8,000

## C) WHITE MEAT & COPRA PROCESSING

1) COCONUT MILK EXTRACTING — The "CeCoCo" Coconut Milk Juicer or Extractor is used for extracting coconut-milk out of fresh white meat or kernel for drinking and cooking in the tropical countries. The extracting yield is from 80% to 95% in efficiency. The construction is hard aluminium alloy (Duralumin) and rust-proof.

Specification of "CeCoCo" Coconut Milk Juicer

Type	Capacity per hour	Power Req'd	R.P.M.	Dimension in mm			Net Weight	Ship'g Meas't
				Height	Width	Length		
H	20-30 kg	Hand	Proper	270	75	330	1.4 kg	0.5 cft

Coconut-milk Juicer Type 'H'

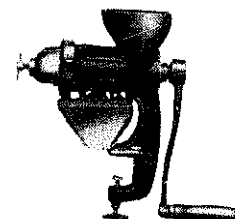



2) **COPRA OIL EXTRACTION** — Copra is a dried kernel or meat from which coconut oil is obtained. Fresh kernel contains about 50% water and 30-40% oil. Its oil content ranging from 50% to 75%, and averaging around 65%. Owing to the fact that copra itself is not a plant seed, the quality of the resulting coconut oil varies considerably depending upon the degree of dryness of raw material, the length of time elapsed before expelling, etc. The coconut oil of average quality has fatty acid ranging from 4% to 6%, but for inferior-quality oil it may be as high as 10% - 14%. After de-acidizing and refining, the coconut oil can be used for human consumption, soap-making and grinding oil.

**Expelling-Process**:- A well dried copra is crushed into small fragments by Seed Crusher, then drying to reduce the copra's moisture content to 4% - 5% by Seed Scorcher or Dryer. The oil expelling is done by screwing of worm screw, which is considered as a most reasonable method. Accordingly it is possible to expell the raw material in one passage of expelling to such an extent that oil content of oil cakes produced from the raw material is remained only 5% - 6%. Finally, Filter Press is used for filtering raw crude oil after expelling, which are equipped with filter cloths, filter papers, and also with pump for conveying oil. This oil milling machines can also extract the oil from many kind of seeds, rape seed, mustered seed, sesame seed, cotton seed kernel, palm-pericarp, peanut, castor-beans, etc. as well as copra.

"CeCoCo" Small Oil Mill Unit, combined with Crusher, Expeller, Filter Press, and Motor Mounted on Trestle

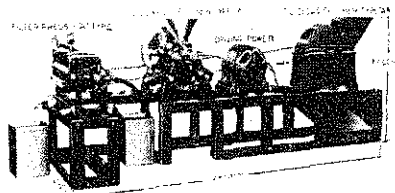

"CeCoCo" Oil Expeller Type New 52

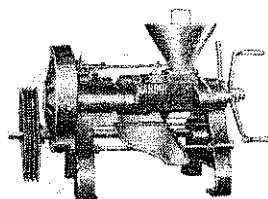

"CeCoCo" Hand Oil Expeller Type H-3

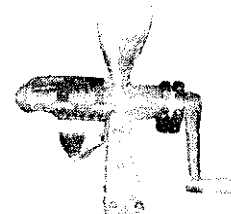

Specification of "CeCoCo" Oil Mill Machinery

Machine's Name	Type	Capacity per hour	Power Req'd	R.P.M.	Dimension in mm			Net Weight	Gross Weight	Ship'g Meas't
					Height	Width	Length			
Crusher	AA	600 kg	2 HP	1,400	560	395	640	75 kg	115 kg	10 cft
Seed Scorcher	L	5 bushel	1 HP	150	1 ft. x 4 ft. $\phi$ Vessel			436 kg	633 kg	57 cft
	S	3 bushel	1/2 HP	150	1 ft. x 3 ft. $\phi$ Vessel			115 kg	160 kg	31 cft
Oil Expeller	H-3	3- 6 kg	Hand	Proper	520	260	600	27 kg	43 kg	4 cft
	New 52	45- 55 kg	3 HP	300	630	520	1000	150 kg	200 kg	14 cft
	New M	120-140 kg	5 HP	350	700	560	1050	170 kg	220 kg	22 cft
	H-54	150-180 kg	7 1/2 HP	600	700	700	1250	430 kg	520 kg	31 cft
	HX-200	250 kg	10 HP	450	980	800	1920	880 kg	1080 kg	90 cft
Filter Press	C	600-800 kg	15- 20	1000	1180	960	3000	3600 kg	4000 kg	120 cft
	A	12 gallons	1/2 HP	170	7" x 7" x 10 chamber			125 kg	175 kg	9 cft
	B	40 gallons	1 HP	200	12" x 12" x 14 chamber			340 kg	500 kg	25 cft

\* When enquiring Oil Mill plant, please let us know (a) name of raw material to expel oil (b) desired capacity per hour or 24 hours in raw material (c) usage of oil produced (d) group driven or individual driven and if motor driven, also specify phase, voltage, frequency, current and other details.

## D) BRIQUETTED FUEL MAKING PROCESS

**UTILIZATION OF WASTE PRODUCTS** — For many years we have studied, and drawn up plans for the manufacture of devices or appliances for making useful products, materials for other products, or fuel for one's own workshop by properly processing wood-waste or coir dust namely, all kinds of waste materials that have been considered as useless hitherto. In order to raise the productivity of manufacturing workshops that produce chipped-dust, saw-dust, wood waste, bamboo waste, chaffs, bagasse, coir-dust, and peanut shell, the briquetted fuel in brick form are being made from each of them to be sold in the market.

PLAN OF "CECOCO" BRIQUETTE MAKING PLANT Model SD-III  
available for materials of saw-dust and coir powder dust

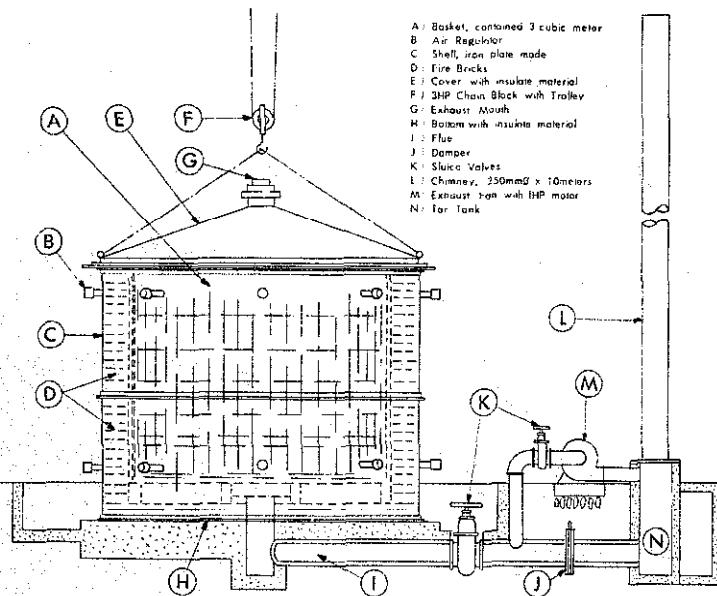
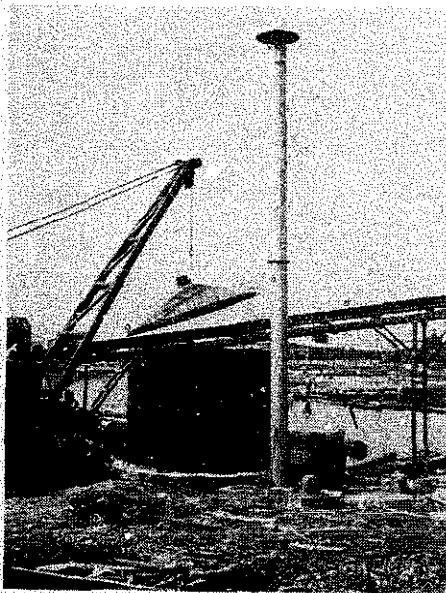
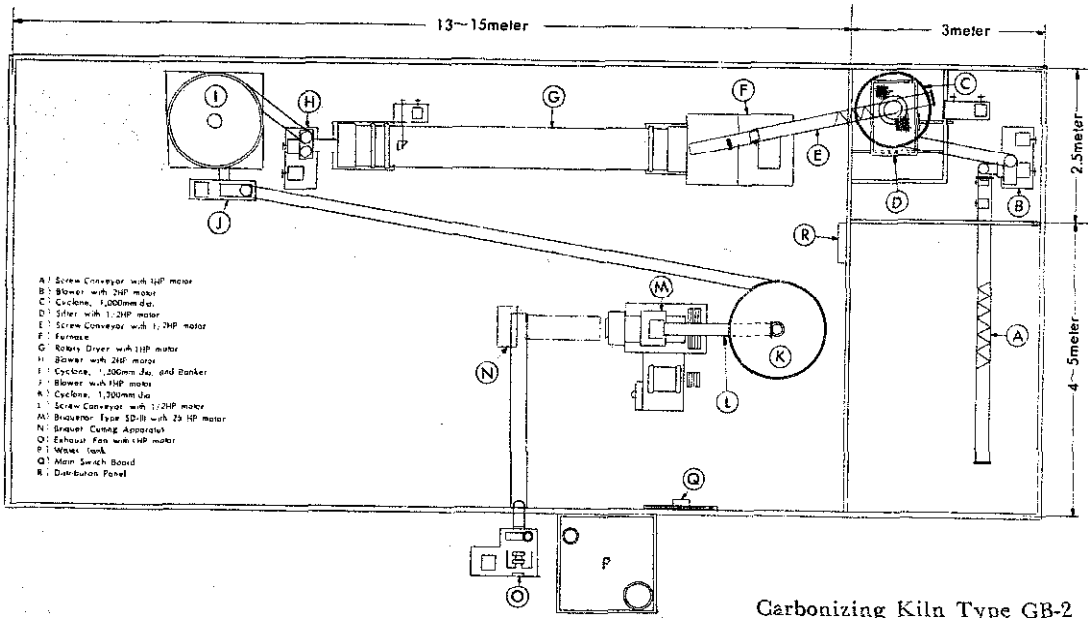

**CARBONIZING KILN FOR BRIQUETTE, BARK, AND COGO-SHELL:-** This equipment is made of steel plates and the interior firebrick finished with castor hull. It can be handled so easily that even unexperienced persons can produce excellent carbonized charcoal and is in such a shape as it can be moved easily.

Material which can be contained ..... 700 kg.  
 Weight ratio of finished product to raw material ..... 40%  
 Time from carbonization to cooling ..... 36 hours.  
 Calorific Value ..... 7,500-8,000 cal./kg  
 Carbonized ..... 99.5% carbon

"CeCoCo" Carbonizing Kiln  
Type GB-3

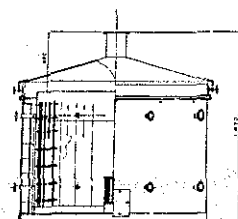

"CeCoCo" Screw Conveyor,  
Dryer and Furnace



"CeCoCo" Dryer and Blower

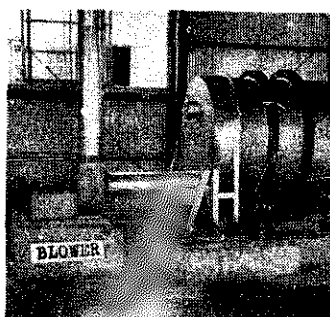

Briquetter, Screw-Conveyor  
& Dried material Pool



Product of Briquetted  
pipe form brick fuel

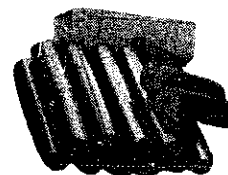

APPROXIMATE ESTIMATE OF MANUFACTURING COST OF SAW-DUST AND BARK BRIQUET  
PROCESSED BY "CECOCO" BRIQUETTING PLANT PER MONTH OF 200 HOURS WORKING IN JAPAN

(A) Income Per Month

Plant Model	SD-I Saw-Dust Briquet Plant	SD-III Saw-dust Briquet Plant	SH Bark Briquet Plant	Carbonized Briquet Kiin
Monthly Production	24 tons 1,600 bags	48 tons 3,200 bags	60 tons 4,000 bags	1.6 tons @2.5 kg 640 boxes
Total Amount of Sales (A) Income	£227-10-0 \$ 637.00	£455-0-0 \$ 1,274.00	£560-0-0 \$ 1,568.00	@ £0-2-0 £64-0-0 @\$ 0.28 \$ 179.20

(B) Cost Per Month

Depreciation	£32-0-0 \$ 89.60	£54-0-0 \$ 151.20	£83-0-0 \$ 232.40	£1-0-0 \$ 2.80
Wages man woman	1 £43-10-0 1 \$ 121.80	1 £58-0-0 2 \$ 162.40	1 £75-0-0 3 \$ 210.00	1 £10-0-0 \$ 28.00
Electric power	£13-0-0 \$ 36.40	£20-0-0 \$ 56.00	£35-0-0 \$ 98.00	
Repairs expense (Oil, parts etc.)	£5-0-0 \$ 10.00	£10-0-0 \$ 28.00	£15-0-0 \$ 42.00	
Maintenance expense (Bearing, Belt, & etc.)	£4-0-0 \$ 11.20	£8-0-0 \$ 22.40	£4-0-0 \$ 11.20	
Administration expense	£4-10-0 \$ 11.20	£6-0-0 \$ 16.80	£8-0-0 \$ 22.40	£1-0-0 \$ 2.80
Insurance on Plant	£0-10-0 \$ 1.40	£1-0-0 \$ 2.80	£1-0-0 \$ 2.80	
Transportation expense	£15-0-0 \$ 42.00	£25-0-0 \$ 70.00	£25-0-0 \$ 70.00	£3-0-0 \$ 8.40
Packing materials	£11-10-0 \$ 32.20	£23-0-0 \$ 64.40	£28-0-0 \$ 78.40	£10-0-0 \$ 28.00
Miscellaneous expense	£20-0-0 \$ 56.00	£30-0-0 \$ 84.00	£66-0-0 \$ 184.80	
Area of Factory	7.0×14.0m 98.0 Sq. m.	7.2×14.0m 100.8 Sq. m.	£7.2×16.2m \$ 116.64 Sq.m.	
Amount of materials	27tons of Saw-dust £42-10-0 \$ 119.00	82tons of Saw-dust £85-0-0 \$ 238.00	90 tons of Chips £20-0-0 \$ 56.00	4 tons of Briquett £21-0-0 \$ 58.80
Total Cost (B) Outlay per plant Per Month	£191-0-0 \$ 534.80	£320-0-0 \$ 896.00	£360-0-0 \$ 1,008.00	£41-0-0 \$ 114.80
Difference Profit (A) - (B)	£36-10-0 \$ 102.20	£135-0-0 \$ 378.00	£200-0-0 \$ 560.00	£18-0-0 \$ 50.40
Market Price in Japan, 15kg. Net in Bag	£0-2-6 to £0-3-6 \$ 0.35 to \$ 0.49	£0-2-6 to £0-3-6 \$ 0.35 to \$ 0.49	£0-2-6 to £0-3-6 \$ 0.35 to \$ 0.49	2.5kg. net per box £0-3-0 \$ 0.42
Calorific Value, Calories/kg.	4,500 - 5,000	4,500 - 5,000	4,500 - 5,000	7,500 - 8,000

# LONG HARD FIBRE PROCESSING MACHINERY

## "CECOCO" HERBACEOUS PLANT DECORTICATOR

Adapted for Ramie, Abaca, Jute, Sisal, Hemp, Kenaf, Banana, Aloe, & other herbaceous plants

### 1) "CECOCO" HAND FEED DECORTICATOR for ramie processing only —

Although the decortication of ramie and other hard fibres was considered very hard work, since "CeCoCo" Decorticator was introduced the operation became very easy, simple, speedy and economical. Not only it eliminates the cutting wastes but also yields are much larger quantity than by any other conventional machines added with more long fibres decorticated. It can perfectly process the short raw stalks which other conventional decorticators are hard to handle, and can also produce more uniformed fibre of much better quality. It also can process the stalks with leaves, therefore the tiresome operation of removing the leaves is eliminated.

Any accidents in handling decorticator is practically eliminated because of careful attention was paid to cover with the safety devices. It is strongly recommended to adapt both of Hand Decorticator together with Brushing Machine in pair.

Because the Brushing Machine (Finisher) removes pith, cuticle and gum etc., of the coarse fibres already processed by Hand Decorticator. Brushing machine was completed as the result of strenuous efforts and repeated experiments carried out in connection with the Hand Decorticator. We are confident that "CeCoCo" Hand Decorticator and Brushing machine will contribute most effectively in improving the yield percentage in the ramie processing.

"CeCoCo"  
Hand Decorticator



Specification of "CeCoCo" Hand Feed Decorticator

	Hand Feed Type Decorticator	Brushing Machine (Ramie Finisher)
Capacity per hour	approx. 25 kgs.	10 to 20 kgs.
Power Required	2—3 H.P.	1—2 H.P.
Revolution of Drum	800 r.p.m.	280 r.p.m.
Size of Main Pulley	200 mm $\phi$ $\times$ 82 mm	500 mm $\phi$ $\times$ 85 mm
Overall Height	1,100 $\frac{m}{m}$	1,135 $\frac{m}{m}$
Overall Width	750 $\frac{m}{m}$	820 $\frac{m}{m}$
Overall Length	1,060 $\frac{m}{m}$	1,077 $\frac{m}{m}$
Net Weight	177 kg.	290 kg.
Gross Weight	324 kg.	430 kg.
Ship'g Measurement	45 cft	52 cft

"CeCoCo"  
Ramie Finisher  
(Brushing Machine)

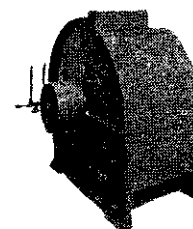

### 2) "CECOCO" AUTOMATIC RAMIE DECORTICATOR for ramie processing only —

"CeCoCo" Automatic Ramie Decorticator is made durable and very economical from a standpoint of power required and constructed as a full automatic decorticator minimizing the need for workers attending to the machine. The continuous feed system of raw materials makes it extremely efficient. This particular Automatic Ramie Decorticator is equipped with centrifugal pump for cleaning the products.

Functionally, this machine comprises three parts A, B and C; The raw stalk, except 30cm from the root, is processed in Part A and the remaining root part is processed in Part B. The operator selects a number of stalks (one to five according to thickness) grasp them approximately 40cm from the root, lines up the stalks on the side cover of the toothed roller and feeds them into the rollers with the angle of 30 degrees to the toothed roller. After the stalks are in the rollers they are then sent between the two endless belts. Upon being pulled through, the stalks are simultaneously decorticated at the leafy part by the beater. When the raw stalk has been decorticated and pulled out far enough, the fibres are caught by the saw-tooth plate from the side and are led into the endless belts. When the Part A processing is finished, the undecorticated part is sent into Part B and is led between the beater and the pressure plate. The endless belts pull up the stalks vertically around the pulley, thus decortivating the stalk and completing the process. The projections on the large pulley and the V-belt are designed to catch the fibres and to give sufficient grasp for decortivating material. The decorticated fibre then goes through the stopper and is sent directly into Part C which conveys it out. The

belts, which sends it out, grasp the fibres, transmit it to the end and place it on the hook when a sufficient quantity is on the hook. It is bundled and sent to the drier.

Specification of "CeCoCo" Automatic Ramie Decorticator

Capacity per hour in dried fibre:—

over 6 ft. long stalk ..... 25—37 kg.

less 6 ft. long stalk ..... 15—22 kg.

These may differ according to the species, handling skill and condition of climate and dryness.

Power Required:— 5 H.P. electric motor or 7 H.P. oil engine

Revolution of Main-shaft ..... 500 r.p.m.

Size of Main Pulley ..... 300mm $\phi$   $\times$  100mm

Overall Height..... 1470 $\frac{m}{m}$

Overall Width ..... 1490 $\frac{m}{m}$

Overall Length..... 3890 $\frac{m}{m}$

Net Weight..... 995kg.

Gross Weight..... 1655kg.

Ship's Measurement ..... 167cft

"CeCoCo" Automatic Ramie Decorticator

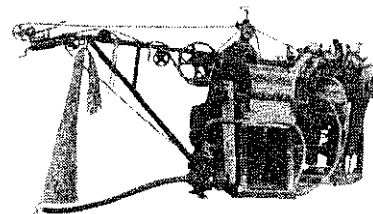

3) "CECOCO" DECORTICATOR TYPE S-50 for ramie and other plants of 3 to 4 feet in length.

This particular machine is designed and built after many years of the tiresome experiences and a high technique for the field use especially in the small plantation. A specially designed Feeding Cover enables to decorticate to the last end and there is left only a small portion of the root to be re-decorticated at the second stage. The machine is small in size, simple in structure, and portable.

Decortication by taking a handful stalks (leaves removed) at the butt end and gradually feed them into the feed-trough; those stalks are crushed and decorticated between the beater blade and the breaker plate, thus butt ends also are decorticated.

Specification of "CeCoCo" S-50 Type Decorticator

Capacity..... 6 to 12 kgs. of ramie

fibre per hour, depended on kind of material, length of stalk, and condition of material, etc.

Power Required ..... 2—3 H.P.

Revolution ..... 850 r.p.m.

Size of Beater ..... 400mm $\phi$   $\times$  270mm width with 12 blunt blades.

Overall Height..... 950 $\frac{m}{m}$

Overall Width ..... 665 $\frac{m}{m}$

Overall Length..... 775 $\frac{m}{m}$

Net Weight..... 150kgs.

Gross Weight..... 210kgs.

Ship'g Measurement ..... 20cft

"CeCoCo" Plant Fibre Decorticator Type S-50

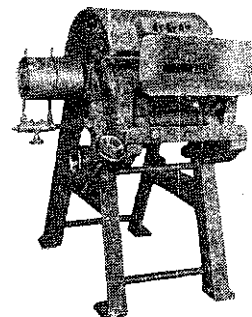

4) "CECOCO" DECORTICATOR TYPE 10IN for ramie and all other kinds of fibres such as hemp, kenaf, sisal, banana, jute, & etc.

Essential improvement comparing to the conventional machines is attachment of a pair of fluted rollers for drawing the decorticated fibre mechanically in place of manual work converting a heavy labor required to a light and safe in handling.

Because, it is so made to save the labour of drudgery works of decortication required by the obsolete machines. The output recovery of clean fibres is very good and it produces the better qualified fibres. Because, with Receiving-Press-Plate is set on top of the Beater and the rotating beater blades with sider beating space will efficiently beat out the stalks more frequently than any other types and they are gradually and completely decorticated with a minimum loss of genuine fibres. A specially designed Feeding Cover enables to decorticate to the last end and there is left only a small portion of the root to be re-decorticated at the second stage.

It is well known fact that one can obtain more of the better grade of fibre and find it much easier to operate the machine to decorticate while the raw materials are fresh than they are dried out. Since a special care is paid in lowering the center of gravity of this particular decorticator in the rigid construction and built as small, simple and compact as much as possible with less motive power, it is very convenient to carry it around safely and easily to the place where the crop is harvested for an instant decortication while they are still fresh in the fields where the machine will automatically throw away all wastes after the properly processed clean fibres are produced, thus it will save a considerable labour and time to dispose of them elsewhere.

The machine is durable and, as it is equipped with first class ball-bearings, it requires no oiling and insures no oil leakage while it is operated.

With many advantages, this particular machine will help reduce the cost of production of the first grade fibres with more output recovery than any other types.

It is not only a portable Semi-automatic Decorticator, but also will be a Washing type Decorticator when attached with a centrifugal pump at extra cost.

Specification of "CeCoCo" Decorticator Type 101N

Capacity ..... 6—15 kgs. of dried ramie fibre per hour.  
 Power Required ..... 2—3 H.P.; Revolution.....800 r.p.m.  
 Overall Dimension ..... 1085<sup>mm</sup>H × 890<sup>mm</sup>W × 720<sup>mm</sup>L  
 Net Weight ..... 195kgs.; Gross Weight ..... 300kgs.  
 Ship'g Measurement ..... 30cft  
 Special Washing Attachment ... 1½" bore Centrifugal Pump with  
 (With Extra Cost) hose, nozzle, foot valve & stop  
 valve. Total head 30 feet;  
 Discharge 45 litres per minute;  
 Approx. weight 25 kgs.

Operation of "CeCoCo" Plant Fibre Decorticator Type 101N, in Ecuador, S. A.



5) "CECOCO" RASPADOR TYPE DECORTICATOR for all kind of hard-fibres --

The "CeCoCo" Raspador Type Decorticator can easily process sisal, hemp, jute, ramie, kenaf, and almost of all hard plant fibres, which is accomplished as the result of the many new improved features designed and adapted.

In case of the jute or kenaf decortication, it should be used with the Pressing Roller to crush the sticks of the stalks, thus recommended to make the decortication much easier.

Due to the softening action of water during decortication, the beating on the fibre is made to be more smooth, insuring to save it from any damage making it possible in retaining its original inherent color and other excellent characteristics as a fine fibre. The quantity of water is determined by the conditions of fibre to be decorticated and source of water supply. It is regulated by the stop valve. The nozzle is designed to give sufficient water at proper pressure.

Specification of "CeCoCo" Decorticator Type Raspador

Capacity ..... approx. 13 kg. per hour depended  
 on raw materials.  
 Power Required..... 5 H.P.  
 Revolution ..... 280—320 r.p.m.  
 Size of Main Pulley..... 450mmφ × 90mm  
 Overall Height ..... 1280<sup>mm</sup>  
 Overall Width ..... 1240mm(or 1870mm)  
 Overall Length ..... 1310<sup>mm</sup>  
 Net Weight ..... 680kgs.(or 800kgs.)  
 Gross Weight ..... 1090kgs.(or 1180kgs.)  
 Ship'g Measurement..... 106 cft (or 120 cft.)

"CeCoCo" Decorticator Type "Raspador" with Press Roll and Pump

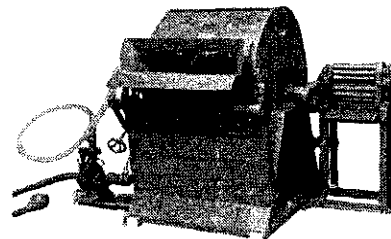

in the bracket  
 are with Press  
 Roll for Jute  
 or kenaf

6) "CECOCO" DECORTICATOR, LARGEST "RASPADOR" TYPE :

This "CeCoCo" Decorticator, having the notable feature of its simple operation as well as being capable of decortivating short stalks is used for producing clean mechanically decorticated best fiber from leaf fibers such as ramie, kenaf and sisal, etc.

Special Feature:—

1. This machine is two men feed type and can decorticate considerably short stalks.
2. Micro-adjustable breaker plate—Regarding the minute adjustment of gap between the Breaker Plate and Rotor Blades, the ordinary type requires careful checking before operation and have to be adjusted by stopping the operation. However, with the attachment of this eccentric shaft, the adjustment of gap can freely be carried out during operation without danger.
3. The shape of the Breaker Plate is designed to facilitate its filing and setting process. It also has the advantage of completing filing and setting in short time.

Specification of "CeCoCo" Decorticator Largest "Raspador" Type

Capacity .....approx. 20 to 30kg. per hour depending  
 upon kind of fiber and length of stalk, etc.  
 Power Required ..... 6-8H.P.  
 Revolution ..... 600-750R.P.M.  
 Drum ..... 610mm dia. × 760mm width with 12 mild  
 steel knives 10mm × 75mm × 760mm  
 Overal Height ..... 1,200mm  
 Overal Width ..... 1,300mm (1,780mm)  
 Overal Length ..... 1,073mm  
 Net Weight ..... 700kg. (980kg.)  
 Gross Weight..... 1,000kg. (1,400kg.)

"CeCoCo" Decorticator Largest Raspador' Type with 'Yanmar' Diesel Engine Model NT95K 7-8.5HP

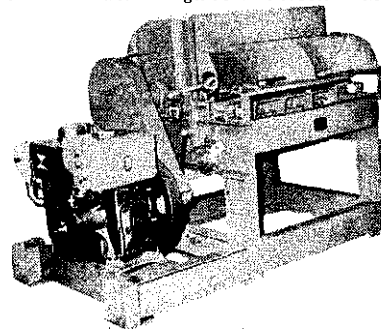

Ship'g Meas't ..... 100 cft (130 cft)

Remark: In the brackets are with Diesel Engine, Clutch and Channeled Bed.

7) "CECOCO" ABACA SPINDLE MACHINE TYPE AS-300 for abaca processing only

This machine is built with steel throughout and durable for hard and rough use. The operation is very simple and easy. Only one operator is necessary for just feeding the splitted raw abaca (abaca tuxy). It increases the output capacity of stripped abaca minimizing the waste. As primitive machine it gave many incidents in cutting hand and bruising the body, but since it is equipped with the safety device is absolutely safe in operation and handling in order to prevent the closing of the stripped abaca. The comb shaped device is set underneath so that the stripped abaca will come out in ribbon strips.

The machine consists of a stripping knife and taper spindle with added advantage including; coil type top tension double springs, safety clutch, improved spindle tapered to handle short length of abaca with balanced fly-wheel, sealed-ball-bearings, strong angle frame and many others. Moreover, there is the cracking equipments of the fibre in front of the knife which is one of many best specialities. Directions—Open the stripping knife by pressing the foot lever and place splitted raw abaca between the knife and block. Release the foot lever and wind the end of the abaca around the turning spindle. Pull with a moderate strength so that the abaca will bind on the spindle and will thus be stripped.

Specification of "CeCoCo" Abaca Spindle Machine Type AS-300

Capacity.....	11 to 22 kgs. of abaca per hour by 2 men.
Power Required .....	3 H.P.
Revolution of Spindle .....	480—550 r.p.m.
Stripping Speed .....	580 feet per minute at 480 r.p.m.
Pressure on Stripping knife .....	500—700 lbs.
Overall Height .....	1,250 <sup>m</sup> / <sub>m</sub>
Overall Width.....	1,375 <sup>m</sup> / <sub>m</sub>
Overall Length .....	1,250 <sup>m</sup> / <sub>m</sub>
Net Weight .....	326 kgs.
Gross Weight .....	575 kgs.
Ship'g Measurement .....	105 cft

"CeCoCo" Abaca Spindle Machine Type AS-300

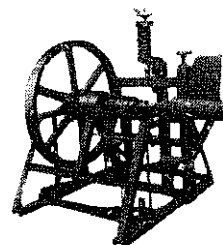

8) "CECOCO" AUTOMATIC ABACA STRIPPER for processing abaca only

Manila hemp industrial fields have been wholly reformed by the appearance of this Abaca Automatic Stripper.

High efficiency of stripping by this machine against human power: Adaptation of beater and knife produces much better and larger output of fibre recovery than that of the spindle machine, that is about 50% higher.

In order to exhibit the essential nature of Manila hemp, a special knife is used in this machine in order to make the fibre bright producing superior qualified fibre same as "CeCoCo" A-300 Spindle machine.

In the past, this kind of work required very skillful and hard labours, but since this machine was introduced the work became very easy even for women, because no hand work necessary except for feeding of raw material, any length of sheath can be stripped up to about 5 meters, and fibre are automatically laid on hanger without any hand works.

Specification of "CeCoCo" Automatic Abaca Stripper

Capacity .....	46—63kg. per hour
Power Required .....	16 H.P. diesel engine
Revolution.....	600 r.p.m.
Overall Height.....	2340 <sup>m</sup> / <sub>m</sub>
Overall Width.....	1770 <sup>m</sup> / <sub>m</sub>
Overall Length .....	5470 <sup>m</sup> / <sub>m</sub>
Net Weight .....	3150 kgs.
Gross Weight .....	4700 kgs. in 2 cases
Ship'g Measurement .....	330 cft

"CeCoCo" Automatic Abaca Stripper

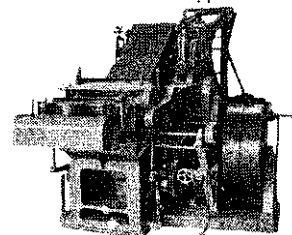

"CECOCO" LONG HARD FIBRE 3-PLY TWINE MAKING MACHINES

Adapted for: Manila and Sisal hemp

"CeCoCo" Fibres Twine Making Machines is specially made for the uses in the village and home industries so that it can be purchased at comparatively low prices requiring practically no knowledge of engineering and only small space to install. Because the construction is very simple and compact and handling is very easy so that even women and young folks can operate without any difficulty.

The fibre yarns are produced by the Hand Spinner, and make 3-strand twine by the Twine Layer, shave off nap of twine by the Shearing Machine and make a twine ball by the Balling Machine by winding fibre-twine by the right hand and producing Twine Ball by left hand to any shapes desired by changing the Angle Adjusting Lever, which is equipped with saw type chopped and marked first to eight, to any desired position of a Ball of twine to make. These four processes are also done by the following individual machines.

PLEASE SUBMIT SAMPLE: Since there are various kinds of herbaceous plants when writing us for prices, please send us sample of your native herbaceous plant for our study to fill your requirement.

"CeCoCo" Hand Spinner

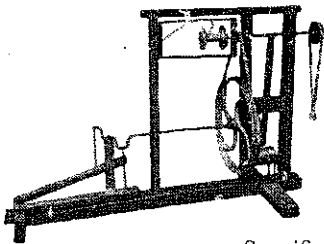

"CeCoCo" Twine Layer

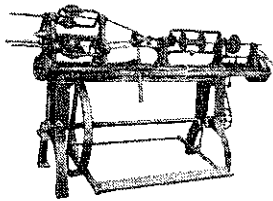

"CeCoCo" Shearing Machine

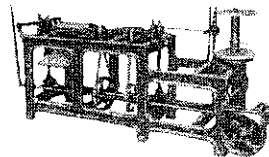

"CeCoCo" Balling Machine

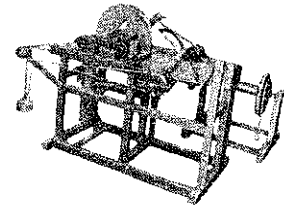

Specification of Hard Fibre 3-ply "CeCoCo" Twine Making Machines

Name of Machine	Power Req'd	R.P.M.	Dimension in mm			Capacity	Net Weight	Gross Weight	Ship'g Meas't
			Height	Width	Length				
Hand Spinner	Treadle	proper	960	635	1550	as follow- ing table	50 kg	90 kg	20cft
Twine Layer	Foot or 1/3 H.P.	200/500	1060	510	2280		260 kg	350 kg	65cft
Shearing m/c	2 H.P.	200	915	660	2400		650 kg	800 kg	75cft
Balling m/c	Hand	proper	915	660	1120		80 kg	120 kg	36cft

Table of Approximate Capacity per day of 10 hours in conjunction with "CeCoCo" Fibre Twine Making Machines in case of 3-ply Manila twine

Weight of 5 feet (Metsuke)	Circumference	Length per ball of 6 lbs. weight	Capacity by Hand Spinner Foot drive	Capacity by Twine Layer Power drive	Capacity by Shearing m/c Power drive	Capacity by Balling m/c Hand drive
0.7 monme	5 $\frac{m}{m}$	1660 meter	1 lbs.	3 lbs.	10 lbs.	4 lbs.
1.0 "	5.8 $\frac{m}{m}$	1160 meter	3 lbs.	10 lbs.	35 lbs.	12 lbs.
1.1 "	6 $\frac{m}{m}$	978 meter	4 lbs.	15 lbs.	50 lbs.	16 lbs.
1.3 "	7 $\frac{m}{m}$	836 meter	7 lbs.	25 lbs.	85 lbs.	30 lbs.
1.6 "	8 $\frac{m}{m}$	678 meter	10 lbs.	40 lbs.	140 lbs.	45 lbs.
2.0 "	9 $\frac{m}{m}$	545 meter	13 lbs.	50 lbs.	150 lbs.	55 lbs.
2.3 "	10 $\frac{m}{m}$	466 meter	18 lbs.	60 lbs.	200 lbs.	70 lbs.
3.0 "	11.5 $\frac{m}{m}$	360 meter	26 lbs.	70 lbs.	220 lbs.	80 lbs.
4.0 "	12.5 $\frac{m}{m}$	270 meter	35 lbs.	100 lbs.	300 lbs.	110 lbs.

Note: — 1.0 monme is 3.75 gm or 0.00825 lbs.

### "CECOCO" SMALL SCALE HARD FIBER ROPE MAKING MACHINE

Adapted for Manila-hemp, Sisal, Kenaf, Ramie, and other hard fibers

- 1st Stage..... "CeCoCo" Fiber Comber is used for hackling and combing the hard fibers to fine sliver, which is consisted of uniform fiber for fine rope.
- 2nd Stage..... "CeCoCo" Hand Spinner takes the fine sliver from the Comber and spins in uniform into  $\frac{1}{8}$ " (3mm) dia. of rope yarn on bobbin.
- 3rd Stage..... "CeCoCo" Strander makes strand which is twisted yarns, this strand is under twist for rope, and number of yarn for strand is decided according to diameter of rope. The strand of uniform sizes and even thickness required is made by replacement of the twist tube and changing gear.
- 4th Stage..... "CeCoCo" Rope Twister will twist the rope which is 3 or 4 strands, and rope twist direction is opposite for the same of strand. The rope of different diameter from  $\frac{3}{8}$ " to  $1\frac{3}{8}$ " every  $\frac{1}{8}$ " and various twists may be made by simply changing the eyed-twist metal and change gear.
- 5th Stage..... "CeCoCo" Rope Packer is used for finishing rope into the shape of coil ready for market.

"CeCoCo" Comber

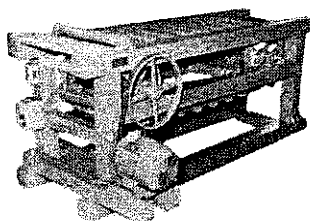

"CeCoCo" Hand Spinner Type F-D

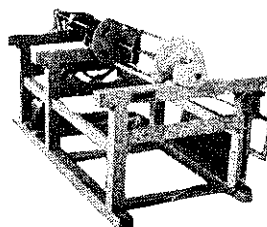

"CeCoCo" Strander Type OKD

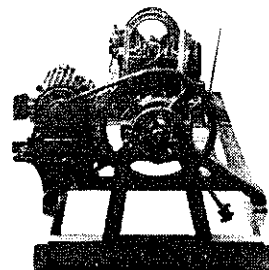

"CeCoCo" Rope Twister Type OKF

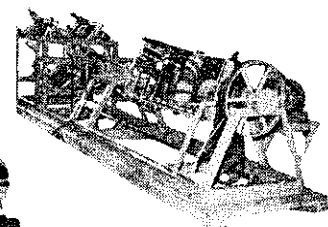



Specification of "CeCoCo" Hard Fiber Rope Making Machine

Name of Machine	Type	Capacity per hour	Dia. of Product	Power Req'd	R.P.M.	Dimension in mm			Weight in kg.		Ship'g Meas't
						Ht.	Wth.	Lgth	Net	Gross	
Comber	OKH	30-40 kg.		1HP	300	1000	910	2200	250	450	150 cft
Hand Spinner	F-D	450m	5/64" to 15/64"	1/2 HP	300 to 400	980	1140	1700	130	250	80 cft
	F2-D	900 m				980	1600	1700	180	350	130 cft
Strander	OKC	300- 550m	3/8" - 3/4"	2HP	120	930	910	5080	470	770	160 cft
	OKD	350- 550m	7/8" - 1 1/2"	1HP	220	880	850	4130	350	620	100 cft
Twister in 3-ply	OKE	300- 500m	3/4" - 1 3/8"	3HP	120	1300	1190	5980	1300	1900	350 cft
	OKF	300- 500m	3/8" - 1"	2HP	150	1080	1100	4250	850	1300	250 cft
Packer	J-D	500-1000m		1/2 HP	100	1280	1050	960	300	500	120 cft

"CECOCO" LARGE SCALE HARD FIBRE ROPE MAKING MACHINES

Upon receipt of the detailed information and specification of your requirements as well as the character of fibre such as sisal, abaca, maguey, hemp, cotton, synthetic fibre or any other kinds, size of rope or twine, output capacity per day of each size in length or weight, number of strands, method of driving as individual motor drive or group drive by counter shafting, availability of an experienced engineer together with samples of your fibre, "CeCoCo" will quote best prices with further illustrated literatures.

"CeCoCo" Spreader  
Output-1,700kg. Per day

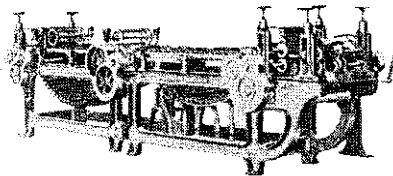

"CeCoCo" 4-spindle Spinner for twine  
Output-40kg. Per day

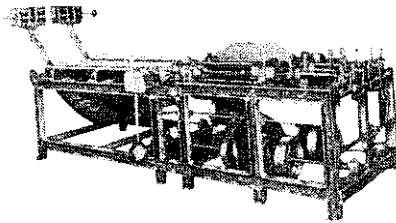

"CeCoCo" Rope Closer, 4 to 100 mm  
in 3ply and 6 to 120mm in 4ply

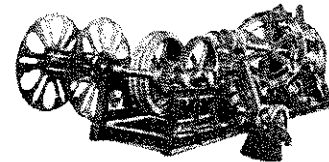

"CeCoCo" Finisher  
Output-1,200kg. Per day

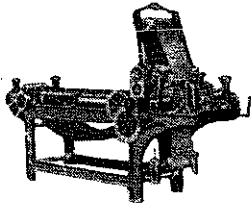

"CeCoCo" Twine Laying Machine  
for 2 to 4 ply

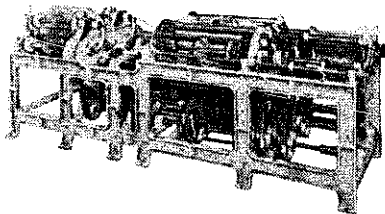

"CeCoCo" 2-spindle Spinner for rope  
Output-120kg. Per day

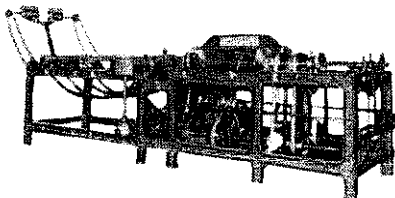

"CeCoCo" Strander  
Set Nos. 1 to 10

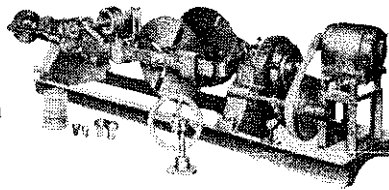

WORKING PROCESS

1. Sliver from materials

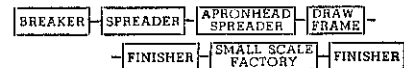

2. Rope from Sliver



3. Twine from Sliver



## "CECOCO" RATTAN (CANE) PROCESSING MACHINES

- 1) "CECOCO" RATTAN (CANE) SPLITTING MACHINE: This machine is used for peeling off the rattan bark and extrude round core on mass production, and at the same time, for splitting the rattan bark into 3 to 5 pieces an equal width, which are used for manufacturing rattan made articles in general.

Specification of "CeCoCo" Rattan Splitting Machine

Split Nos.	$\frac{3}{16}$ " - $\frac{1}{4}$ " dia. into 3 pieces $\frac{5}{16}$ " - $\frac{7}{16}$ " dia. into 4 pieces $\frac{1}{2}$ " - $\frac{9}{16}$ " dia. into 5 pieces
Splitting Speed	approx. 100 meters per minute
Width of Split Rattan	3.0 mm - 8.0 mm
Capacity per hour	$\frac{3}{16}$ " dia. .... approx. 14 kgs. $\frac{1}{4}$ " dia. .... " 27 kgs. $\frac{5}{16}$ " dia. .... " 42 kgs. $\frac{3}{8}$ " dia. .... " 50 kgs. $\frac{7}{16}$ " dia. .... " 65 kgs. $\frac{1}{2}$ " dia. .... " 80 kgs. $\frac{9}{16}$ " dia. .... " 115 kgs.
Power Required	3 H.P.
Net Weight	500 kgs.
Gross Weight	700 kgs.
Ship'g Measurement	50 cft.

"CeCoCo"  
Rattan Splitting Machine

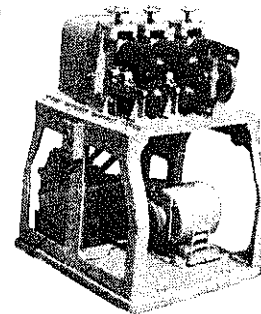

- 2) "CECOCO" RATTAN SLICING MACHINE: This machine is used for removing the flesh of the rattan and for finishing the splitted rattan into even thickness as the second processing machine.

Specification of "CeCoCo" Rattan Slicing Machine

"CeCoCo"  
Rattan Slicing Machine

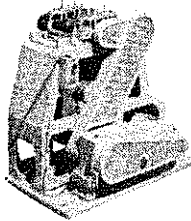

Width of splitted rattan to be sliced	2.5 mm to 7.5 mm
Slicing Thickness	0.5 mm to 1.8 mm
Slicing Speed (Capacity) per minute	90 meters
Capacity in weight per hour	8 to 35 kgs.
Power Required	1 H.P.
Net Weight	350 kgs.
Gross Weight	450 kgs.
Ship'g Measurement	35 cft

- 3) "CECOCO" RATTAN WIDTH SIZING MACHINE: This machine is used for making the width of sliced rattan into uniform sizes as the last processing machine.

Specification of "CeCoCo" Rattan Width Sizing Machine

Thickness of Sliced rattan to be used	0.5 mm - 1.8 mm
Sizing Width	2.0 mm - 6.5 mm
Sizing Speed (Capacity) per minute	90 meters
Capacity in weight per hour	2 - 25 kgs.
Power Required	$\frac{1}{4}$ H.P.
Net Weight	85 kgs.
Gross Weight	130 kgs.
Ship'g Measurement	15 cft

"CeCoCo"  
Rattan Width  
Sizing Machine

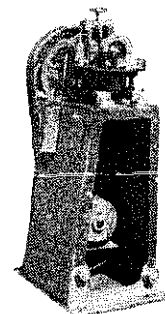

## "CECOCO" BAMBOO PROCESSING MACHINERY

for manufacturing Bamboo Curtain, Blind, Matting, Fish-trap, Tooth-pick, Baskets, Joss-stick and Bamboo article in general.

Bamboo is produced in many countries in the world. Although it's weaving takes time, labour and patience, it is processed by craftsmen who work in their own small workshops. It is now becoming profitable small-scale

cottage industries for making bamboo basket, paper lantern, screen and furniture which are extensively used in modern household with art and comfort. Consequently there is a great demand for ready-made bamboo strips. "CeCoCo" Bamboo processing machines are filling such demand not only domestically but also from abroad.

Bamboo and reed or common cane (*Arundo donax*) is of widespread distribution and has played an important role in the culture of the western world through its influence on the development of music. Reeds for wood-wind musical instruments are still made from the culms, and no satisfactory substitutes have been developed. This has also been used as a source of cellulose for rayon and is considered as a source of paper pulp. In Japan, bamboo is used in making the flute.

### FLOW CHART OF BAMBOO PRODUCTS PROCESSING

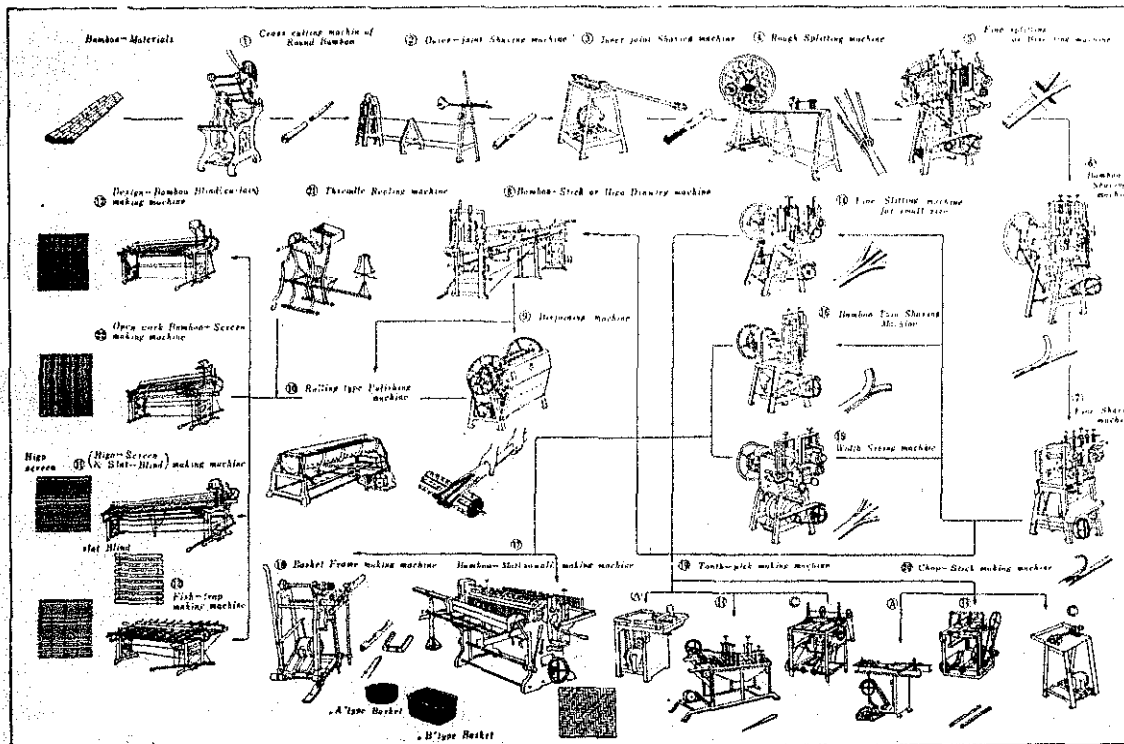

#### 1) "CECOCO" CROSS CUTTING MACHINE :

This machine is to cut round bamboo crosswise by movement of Circular Saw into a certain length (8 ft. long in standard)



"CeCoCo" Cross Cutting Machine

1)

Dia. of Bamboo to be cut	1" to 5"φ
Dia. of Circular Saw	16 inches
Capacity per hour	120 pcs.
Power Required	1 H.P.
Revolution	2,000 rpm
Net Weight	180 kgs.
Gross Weight approx.	250 kgs.
Ship'g Measurement	30 cft

#### 2) "CECOCO" OUTER-JOINT SHAVING MACHINE :

This machine is used to take off the outside knots of round bamboo by special Hand Planes.

"CeCoCo" Outer Joint Shaving Machine

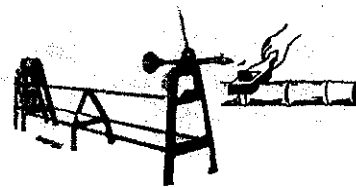

2)

Effective Length of Bamboo	8 feet
Capacity per hour	720 knots
Power Required	1/2 H.P.
Revolution	350 rpm
Net Weight	210 kgs.
Gross Weight, approx.	300 kgs.
Ship'g Measurement	70 cft

3) "CECOCO" INNER-KNOT REMOVING MACHINE:

This machine will bore out the inside knot of round bamboo by auger into a pipe-form.

"CeCoCo Inner-knot Removing Machine"

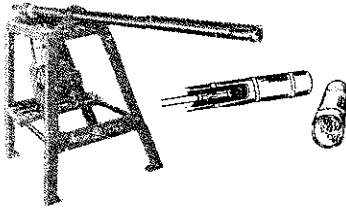

3)

Effective Length of Bamboo	Max. 8 feet
Capacity per hour	800 knots
Power Required	1/2 H.P.
Revolution	2,000 rpm
Net Weight	150 kgs.
Gross Weight, approx.	210 kgs.
Ship'g Measurement	30 cft

4) "CECOCO" ROUGH SPLITTING MACHINE:

This machine will split a round bamboo into equal width of about 2" by a tough blade varying from 2 to 10 pieces at a time. Hand Splitter is also available.

"CeCoCo" Rough Splitting Machine

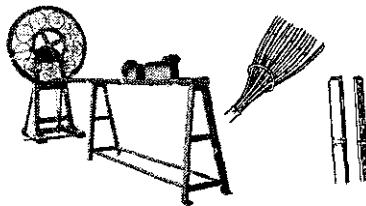

4)

Effective Length of Bamboo	Max. 8 feet
Capacity per hour	100 - 120 pcs.
Dia. of Bamboo can be split	1" to 5"φ
Width of Bamboo to be split	2" equal
Power Required	Hand
Net Weight	350 kgs.
Gross Weight, approx.	500 kgs.
Ship'g Measurement	110 cft

5) "CECOCO" FINE SPLITTING MACHINE: (FINE SPLITTER)

This machine is used for further splitting of the materials already splitted by 4) Rough Splitter into 2 pieces.

"CeCoCo" Fine Splitting Machine

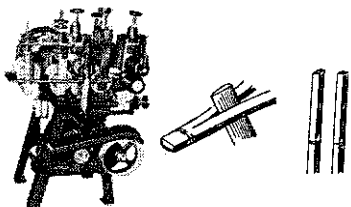

5)

Capacity per hour	8,400 feet
Width of Material	1" - 2"
Splitting Width	1/2" - 1"
Power Required	1 H.P.
Revolution	200 rpm
Net Weight	200 kgs.
Gross Weight, approx.	260 kgs.
Ship'g Measurement	30 cft

6) "CECOCO" BAMBOO SLICING (SHAVING) MACHINE:

This machine is used for slicing the splitted bamboo into uniform pieces of any thickness over 1/16".

"CeCoCo Bamboo Slicing (Shaving) Machine"

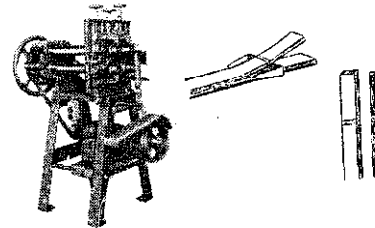

6)

Capacity per hour	6,300 feet
Width of Material	1/4" - 1 1/4"
Slicing Thickness, adjustable	1/16" up
Power Required	1 H.P.
Revolution	280 rpm
Net Weight	150 kgs.
Gross Weight, approx.	200 kgs.
Ship'g Measurement	25 cft

7) "CECOCO" FINE SLICING MACHINE:

This machine is used for precise slicing of materials into beautiful uniform thickness. Any thickness is adjustable for mass-production of blind, curtain, fish-trap, mat, basket, tooth-pick, chop-stick, etc.

"CeCoCo" Fine Slicing Machine

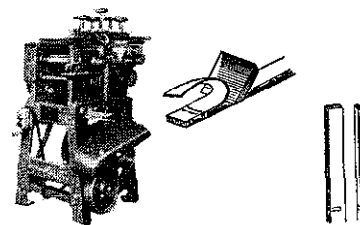

7)

Capacity per hour	6,000 feet
Width of Material can be sliced	1/4" - 1 1/4"
Slicing Thickness, adjustable	3/64" up
Power Required	1 H.P.
Revolution	350 rpm
Net Weight	190 kgs.
Gross Weight, approx.	240 kgs.
Ship'g Measurement	20 cft

8) "CECOCO" BAMBOO STICK DRAWING MACHINE :

This machine is used for drawing the sliced materials into round or square stick which are used for manufacturing curtain, fish-trap, high class basket, etc., and the drawn size is adjustable from  $\frac{3}{16}$ " to  $\frac{1}{4}$ " thickness by changing the comb-shape blade.

"CeCoCo" Bamboo Stick Drawing Machine

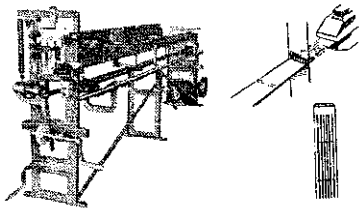

8)

Effective Length of material	8 feet
Capacity per hour	1,200 pcs.
Width of material can be drawn	$\frac{1}{2}$ inches
Power Required	1 H.P.
Revolution	230 rpm
Net Weight	300 kgs.
Gross Weight, approx.	400 kgs.
Ship'g Measurement	70 cft

9) "CECOCO" DIS-JOINING MACHINE :

This machine will separate or disjoin the end of drawn material into several pieces.

"CeCoCo" Dis-Joining Machine

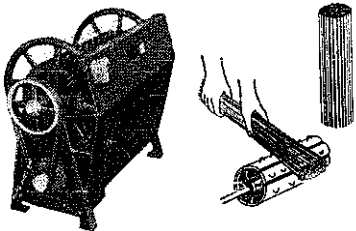

9)

Capacity per hour	20,00 pcs.
Power Required	$\frac{1}{2}$ H.P.
Revolution	500 rpm
Net Weight	130 kgs.
Gross Weight, approx.	170 kgs.
Ship'g Measurement	25 cft

10) "CECOCO" POLISHING MACHINE :

This machine is used to polish the sticks and remove off the rough parts.

"CeCoCo" Polishing Machine

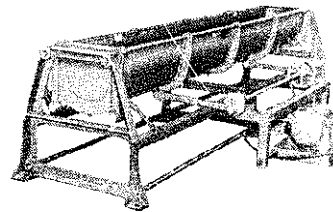

10)

Capacity per hour	20,000 pcs.
Effective Length of sticks	Max. 8 feet
Power Required	1 H.P.
Revolution	350 rpm
Net Weight	450 kgs.
Gross Weight, approx.	600 kgs.
Ship'g Measurement	110 cft

11) "CECOCO" BAMBOO BLIND OR CURTAIN MAKING MACHINE :

This machine is for weaving Blind or Curtain with cotton thread. It is semi-automatic equipped with a Material Feeder and is operated by  $\frac{1}{4}$  HP motor. Weaving efficiency is 8 feet & 12ft. in width standard and also 3, 6, 10 according to the requirement.

"CeCoCo" Bamboo Blind or Curtain Making Machine

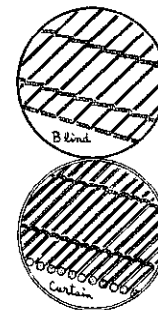
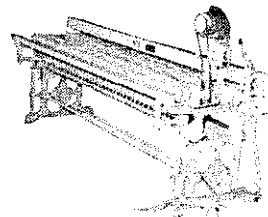

11)

Power Required	$\frac{1}{4}$ H.P.	
Capacity per hour	blind	40 feet
	curtain	20 feet
Size of material	blind	$\frac{1}{8}$ " - 1" width
	curtain	$\frac{1}{16}$ " - $\frac{1}{8}$ " dia.
Revolution	blind	1,000 rpm
	curtain	3,000 rpm
Net Weight	450 kgs.	
Gross Weight, approx.	600 kgs.	
Ship'g Measurement	110 cft	

12) "CECOCO" DESIGN BLIND OR CURTAIN MAKING MACHINE:

This machine is used for weaving four types of designed blind and curtain with cotton thread and also used for ordinary blind.

"CeCoCo" Design Blind or Curtain Making Machine

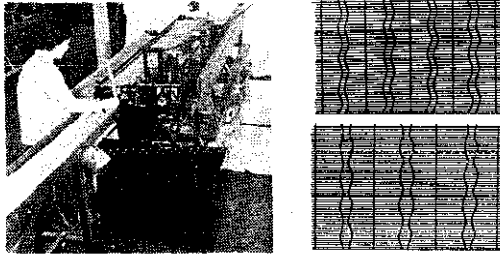

12)

Weaving Width	3 feet
Capacity per hour	15 feet
Power Required	1/4 H.P.
Net Weight	180 kgs.
Gross Weight, approx.	250 kgs.
Ship'g Measurement	70 cft

13) "CeCoCo" FISH TRAP MACHINE:

The machine is for weaving fish-trap with palm or hemp twine or other such materials. It is operated by foot, and when equipped with Material Feeder. Weaving width is 8 feet in standard and also 6ft., 10ft. and 12 ft. if required.

"CeCoCo" Fish Trap Machine

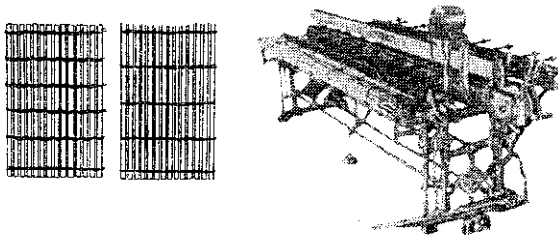

13)

Weaving Width	8 feet
Capacity per hour	32 feet
Dia. of Material	1/4" - 1 1/4"
Power Required	1/4 H.P.
Net Weight	480 kgs.
Gross Weight, approx.	620 kgs.
Ship'g Measurement	110 cft

14) "CeCoCo" FINE SLITTING MACHINE:

This machine is used to slit the material into equal parts of 2 or 4 pcs. for production of high-class basket, and blind, etc.

"CeCoCo" Fine Slitting Machine

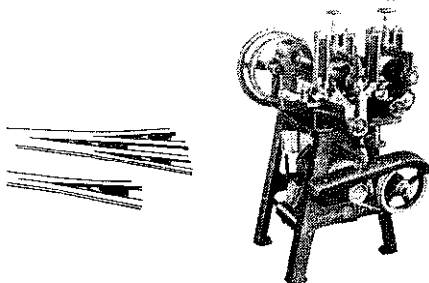

14)

Capacity, per hour	17,000 feet
Width of material	1/2 inches
Slitting Width	1/8" - 1/4"
Power Required	1/2 H.P.
Net Weight	170 kgs.
Gross Weight, approx.	220 kgs.
Ship'g Measurement	30 cft

15) "CeCoCo" WIDTH SIZING MACHINE:

This machine is used for sizing the thinly sliced materials into a uniform width which can be adjusted by the handle and the products are suitable for manufacturing mats, basket, etc.

"CeCoCo" Width Sizing Machine

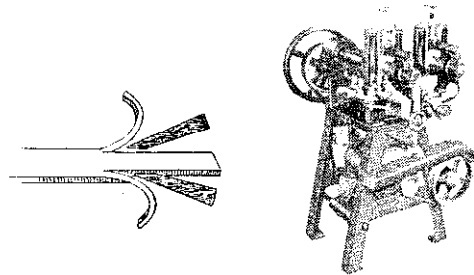

15)

Capacity per hour	6,000 feet
Sizing Width	1/8" - 1 1/4"
Power Required	1/2 H.P.
Net Weight	180 kgs.
Gross Weight, approx.	230 kgs.
Ship'g Measurement	27 cft

16) "CeCoCo" THIN SLICING MACHINE:

This machine will slice the fine sliced materials produced by Fine Slicing Machine (7) into a uniform thickness. This is suitable for production of fine mat, high class basket etc.

"CeCoCo" Thin Slicing Machine

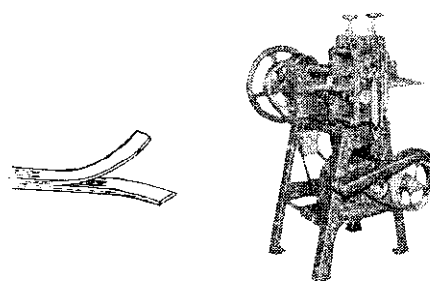

16)

Capacity per hour	6,000 feet
Width of Material can be used	1/4" - 1 1/4"
Slicing Thickness, adjustable	min. 3/128"
Power Required	1/2 H.P.
Net Weight	140 kgs.
Gross Weight, approx.	190 kgs.
Ship'g Measurement	26 cft

17) "CeCoCo" BAMBOO MAT MAKING MACHINE:

This is a semi-automatic bamboo-mat-weaving machine, and appearance of product is more beautiful than woven by hands.

"CeCoCo" Bamboo Mat Making Machine

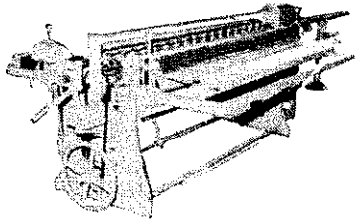

17)

Capacity per hour	100 sq. ft.
Weaving Width	6 feet only
Material width each piece	3/4" only
Power Required	1/2 H.P.
Net Weight	700 kgs.
Gross Weight, approx.	1000 kgs.
Ship'g Measurement	250 cft

"CeCoCo" Sizing Machine

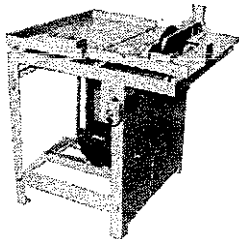

"CeCoCo" Polishing Machine

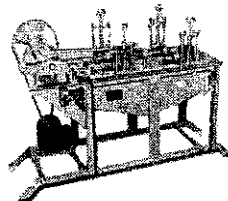

"CeCoCo" Shaving Machine

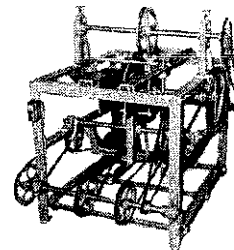

18) "CeCoCo" BASKET FRAME MAKING MACHINE:

This machine is used for shaving the bending parts of frame and bamboo bone of basket so as to be easily bent.

"CeCoCo" Basket Frame Making Machine

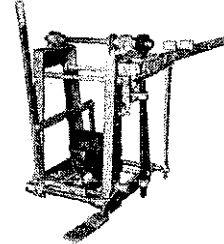

18)

Capacity per minute	7 places
Width of material	3/4" - 2"
Power Required	1/2 H.P.
Net Weight	180 kgs.
Gross Weight, approx.	260 kgs.
Ship'g Measurement	45 cft

## BAMBOO LACE PRODUCTS & TOOTH-PICK

Bamboo Lace, a unique product of Japan which earns about ¥15 million a year from the United States, Britain, France, West Germany and Italy, is made in the small town of Muko-machi about 10 minutes train ride away from Kyoto and 40 minutes from Osaka.

Bamboo lace is a brainchild of Satoshi Otsuka, 41, president of the Toyo Chikko K.K. who derived his inspiration from hexagonal fishing rods for export.

This is how the bamboo lace is made: Bamboos rods cut from the thickets are boiled for about five minutes in a length of eight to 18 meters in a pourful of washing soda.

This process removes oil from the bamboo and when dried in the sun, the bamboo is bleached white. The rods are then cut into lengths of about 12 centimeters and glued side by side inside steel frames of different shapes. The bamboo and frame are then processed in an electric drier to make the bamboo moth-proof. The processed product is sawed into the desired thickness. Finishing touches with sand paper and lacquer complete the bamboo lace.

The whole process takes about one month: Bamboo-ware making has long remained a cottage industry, resisting mass production despite the rising Western demand for the products rich in Oriental flavor.

Unlike similar products, like those once produced in Taiwan, Otsuka's invention, trademarked "Ohtsu Cut lace", is completely insect-proof and is far richer in variety. He uses only three-year-old bamboo to ensure good quality of the products, because bamboo is stoutest and most elastic in that stage of growth. According to Otsuka, exports of bamboo screens, tapes and desk, which are made in combination with wood, are also on the gradual rise.

19) "CeCoCo" BAMBOO TOOTH-PICK MAKING MACHINES: The first stage is to cut the material of 25 mm  $\phi$  round drawn-stick into 120 mm length by Sizing Machine, then clean and polish the materials by Polishing Machine and sharp the ends of materials by Shaving Machine and final cutting of the sharpened materials into one-half length of 60 mm by first sizing Machine. Production Capacity is approx. 20,000 pcs. per hour.

## SMALL-SCALE COTTAGE INDUSTRY IS DYNAMIC FORCE IN THE MODERN ECONOMY

Small-Scale Cottage Industry belies its name by providing a large proportion of all industrial employment and accounting for the great majority of all industrial establishments. However, it is often asked whether such industry can survive and perform a useful function in the highly industrialized regions of the world, and what its place should be in the economic plans of developing countries. Analysis of the exact nature of the problems facing small-scale industry and of the way in which it is adapting itself to meet them. Far from being moribund, small-scale industry is a dynamic force with a valuable role to play in the modern economy of both highly industrialized regions and developing countries.

In almost of all developing countries in the world, there are determined efforts to achieve material economic progress, and emphasis is being carried out to induce a shift in the structural pattern of the economy from one basically agricultural to one that is agro-industrial in character to assure an increasing level of national production within the framework of economic and social stability which does not require much of foreign exchange to insure its growth. That is very important to select such industries which do not need foreign exchange in obtaining raw materials.

The high cost of living in the urban areas, nevertheless reduces the workers real income. Money incomes in the rural areas is lower than those in cities but the cost of living is equally lower compared with urban living. The full development of cottage industry in the rural areas, can provide additional forms of incomes on the part of rural families, which could reduce the influx of population to cities in quest for employment. Thus ultimately would minimize social problem in urban centers.

### “CECOCO” WIRE PRODUCTS AND METAL FABRICATING MACHINERIES

#### 1) “CECOCO” AUTOMATIC GEM CLIP MAKING MACHINE:

This machine at first straighten as the raw material wire and then proceed to the cutting die to cut the wire into desired length. Then the cut wire is bent into required shape. All of above processes are done automatically.

Deformed type clips such as “Center-up” or “Triangle head” can also be made by using the special attachments at an extra cost. Unless already plated-raw-material of wire is used, the finished clips should be plated after fabricated.

*Different size and shape clips can be made by changing the “Replacement parts” such Bending Pipes, Bending axles and also frame.* It is, however, recommended to use one machine for manufacturing one specific size and shape only.

#### Specification of “CeCoCo” Automatic Gem Clip Making Machine

Capacity of production	:..... 120 to 150 pcs. per minute	
Size of products	:..... 24 — 35 mm	
Power Required	:..... ¼ H.P. electric motor	
Material to be used	:..... Iron Wire BWG #19—22 hardend at BWG #16, not plated. Sometimes, copper or tin plated wire is used.	
Material to be consumed	:..... 25 kg. in 24 mm clip; 31 kg. in 28 mm clip or 47 kg. in 35 mm clip per day of 8 hours.	
Net Weight:-	150 kg.	Gross Weight:- 220 kg. Ship'g Measurement:- 25 cft.

“CeCoCo” Automatic Gem Clip Making Machine

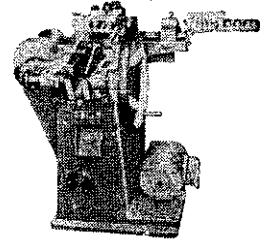

#### 2) “CECOCO” AUTOMATIC PAPER PIN MAKING MACHINE:

The raw material wire is fed into Wire Guide Hole to be straightend first, and then led into forwarding chuck. In this stage the wire is forwarded by a chuck which will adjust the forwarding length by a cam. Then proceeded to second stage by forwarding chuck and finally to the Double Forwarding Die. Then the wire is cut into required length and forwarded to Heading Part where pins' head is prepared.

After the heads are fabricated, those pins are sent to Sharping Device and perfect paper pins are finished and plated. The length of pin can be adjusted by a cam (within the limit of plus and minus ¼”) )

#### Specification of “CeCoCo” Automatic paper Pin Making Machine;

Capacity of production	:..... 300 to 350 pcs. per minute	
Size of products	:..... 5/8” to 1½” in length	
Power Required	:..... 1 H.P. electric motor	
Material to be used	:..... Iron wire BWG #22, hardened at BWG #16, not plated.	
Material to be consumed	:..... 15 kg. in 1” pin per 8 hours	
Net Weight:-	350 kg.	Gross Weight:- 450 kg. Ship'g Measurement:- 70 cft.

“CeCoCo” Automatic Paper Pin Making Machine

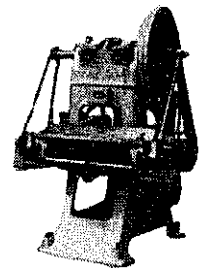



### 3) "CECOCO" AUTOMATIC STAPLE PIN MAKING MACHINE:

The paper staple pin is made from flat wire by pressed Mild Steel Round wire, and is finished in nickel or copper plated. Quite a high technique is required to produce such flat wire and it also requires a good and long practice. Therefore, we recommend you to purchase the raw material at the start. Firstly pass the flat wire through the straightening rollers and feeder, cut by the Cutting die, at the same time it is bent by Bending die. Then transferred along a guide rail and are stucked together into a long piece by glue which comes out from a glue tank. Then, the staples will run on a drying rail and being heated until it reaches the end-plate. Finally when the edge of staple touches the end-plate, the cutter cuts down into a piece of 50 staples unit automatically.

"CeCoCo" Automatic Staple Pin Making Machine

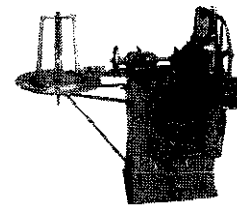

#### Specification of "CeCoCo" Automatic Staple Pin Making Machine;

Capacity of production :..... 150 to 200 pcs. per minute  
 Size of product :..... No. 1, 2, 3, 9 or 10, recommendable for use one machine for making one specific size only.  
 Material to be used :..... Tin or copper plated flat mild steel wire, originally BWG #24-26 and adhesive glue.  
 Material to be consumed :..... 6 kg. in Size No. 3 or 4 kg. in Size No. 10 per day and 150-250 grams of glue per day of 8 hours.  
 Net Weight: 200 kg. Gross Weight: 300 kg. Ship'g Measurement: 50 cft.  
*Note: The deformed types can also be made by interchanging the replacement parts at an extra cost.*

### 4) "CECOCO" AUTOMATIC HAIR PIN MAKING MACHINE:

This particular machine is equipped with a special roller which automatically rolls a round wire into half-round or flat shape. Consequently it enables to produce a considerably high output efficiency than those which have to bend the wire after wave-shape-corrugating. When processing is over, the pins are usually polished by Tumbling Barrel with leather scrap, enamel-coated in a dip-bath or by the spray gun (Air compressor) and dried by an electric furnace (at 150°C-200°C about 30 minute). This machine is capable in producing Hair Pins of different shapes by replacing the pressing moulds. The length of pin can be adjusted with the limit of 5 mm. For the convenience of operation, it is recommendable to beginners who will use this machine to confine to a single length first.

Hair Pin Making Machine Model KS-61

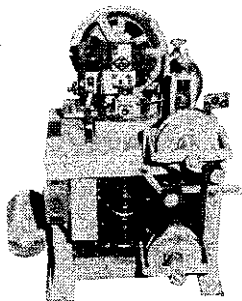

Air Compressor for enamelling

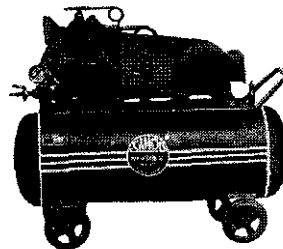

Electric Furnace for drying

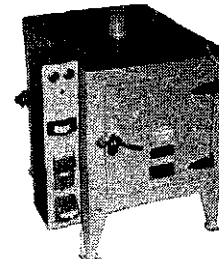

#### Specification of of "CeCoCo" Automatic Hair Pin Making Machine Model KS-61;

Capacity of production :..... 200 to 250 pcs. per minute  
 Size of product :..... 40 - 60 mm in length can be adjusted with the limit of 5 mm by a machine.  
 Power Required :..... 1 H.P. electric motor  
 Material to be used :..... 60 carbon round steel wire (means of annealed at BWG # 6 carbon content 0.55-0.65%) BWG # 19 - 21. Selection of wire of the proper quality is most important. If carbon content is too much, wire will be broken or cracked during the processing, and if carbon is too less, pin will not be elastic enough.  
 Material to be consumed :..... 60 kg. in 45 mm length per 8 hours.  
 Net Weight:- 300 kg. Gross Weight :- 380 kg. Ship'g Measurement:- 45 cft  
 Remarks: For the manufacturing of flat and fastener types of hair pins, other types of machines are required.

### 5) "CECOCO" AUTOMATIC SAFETY PIN MAKING MACHINERY:

Raw material wire for pin is firstly straightend and cut into the required length by Wire Straightening &

Cutting Machine Model SC-1. The cut ends are sharpened by Wire Sharpening Machine Model WS-1, to be bent and coiled by Wire Bending & Coiling Machine Model BC-1. Hoop is punched out and the heads are shaped by Pin Head Making Machine Model HG-1. Finally, the pins and heads are fastend by Assembling Press Model ED-5. These five processes are done by the following individual automatic machines. The finished pins are usually nickel plated.

Raw Materials Required for 400 gross of Safety Pin

Size of Pin		Iron Wire		Iron Hoop		
No.	Length	Gauge	Weight	Thickness	Width	Weight
0	24 mm	23 mils	9.2 kg.	0.25 mm	10 mm	12 kg.
1	28 mm	28 mils	12 kg.	0.25 mm	10 mm	16 kg.
2	33 mm	32 mils	20 kg.	0.25 mm	10 mm	20 kg.
3	39 mm	35 mils	30 kg.	0.3 mm	15 mm	30 kg.
4	46 mm	38 mils	38 kg.	0.3 mm	15 mm	40 kg.
5	55 mm	40 mils	44 kg.	0.3 mm	15 mm	50 kg.

"CeCoCo" Automatic Safety Pin Assembling Press

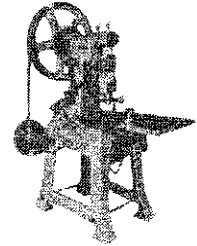

Specification of "CeCoCo" Automtic Safety Pin Making Machines;

Model of Machine	SC-1	WS-1	BC-1	HG-1	ED-5
Capacity per minute	120 pcs.	1,000 pcs.	40 pcs.	60 pcs.	60 pcs.
Power Required	½ H.P.	1 H.P.	¼ H.P.	1 H.P.	1 H.P.
Net Weight	120 kg	220 kg	40 kg	170 kg	220 kg
Gross Weight	180 kg	300 kg	60 kg	250 kg	300 kg
Ship'g Meas't	35 cft	36 cft	5 cft	35 cft	35 cft

#### 6) "CECOCO" NICKEL PLATING EQUIPMENTS:

The users prefer to have a pin, clip and other articles nickel plated in better appearance, even to pay a little higher in price. Nickel Plating Equipments are comprising of 1 set of tumbling barrel for polishing; 2 sets of water washing bath; 1 set of acid washing bath; 1 set of selenium rectifier; 1 set of rotary plating bath, 1 set of dehydrator and filter. A standard capacity of 120—150 kgs. per day is corresponding to the manufacturing capacity of 8 sets of Paper Pin Making Machine, 4 to 6 sets of Gem Clip Making Machine, 800 gross of Safety Pin Making Unit.

"CeCoCo" Rotary Plating Bath

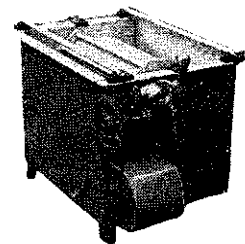

#### 7) "CECOCO" AUTOMATIC SNAP BUTTON MAKING MACHINES:

After female-die are fitted up in a Press, a brass strip is to be fed into die. By the working of the Press, the brass strip is automatically sent into the die by the strip-sending-graduation. After the brass strip is pressed and cut here, it is automatically wound up. This strip is called a "Semi-manufactured material." This semi-manufactured material is then placed into the Automatic Spring Inserting & Finishing machine. At the same time, a phosphor-bronze-wire, for a spring, is also placed into them. This wire, as a spring, is automatically formed and sent into the semi-manufactured material which is being pressed and shaped, to be finished as complete female snap buttons. In the same way as above, after the male die is fitted up in an Press machine, the brass strip is fed into it by the action of the press machine, and this brass strip is automatically sent into the die by the speed of the strip sending graduation. This brass strip is pressed and shaped, by means of die so that complete male buttons are cut out, and the scrap is automatically wound up.

Press Machine  
Capacity 100 to  
120 pcs./minute  
row or lime Per

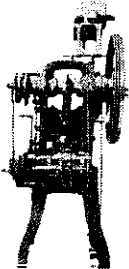

Finished products are usually tin plated.

Remarks: One Press machine can be used both for female and male parts, therefore, in case of a small production it is suggested to have one Press machine to produce female and male parts by changing dies. In case it is required to produce more than two sizes of snap-buttons, one set of Press machine can do the work by changing the different size of dies, but it needs a skillful technique and long time for adjusting.

"CeCoCo"  
Spring Inserting & Finishing  
Machine, Capacity 80 to 100  
pcs./minute

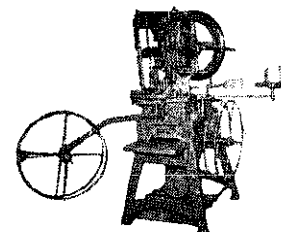

Raw Material to be consumed for 1,000 gross of Snap-button

Size of Button	Material and Size	Quantity
No. 00 7 mmφ	Brass strip 0.2 t × 49 mm width	26.0 kg.
	- ditto - 0.2 t × 37 mm width	13.4 kg.
	Phos. Bronze Wire 0.425 mm dia.	6.5 kg.
No. 0 8 mmφ	Brass strip 0.2 t × 54 mm width	32.0 kg.
	- ditto - 0.23 t × 43 mm width	21.5 kg.
	Phos. Bronze Wire 0.5 mm dia.	9.0 kg.
No. 1 10 mmφ	Brass strip 0.2 t × 59 mm width	45.5 kg.
	- ditto - 0.23 t × 48 mm width	30.0 kg.
	Phos. Bronze Wire 0.55 mm dia.	15.4 kg.

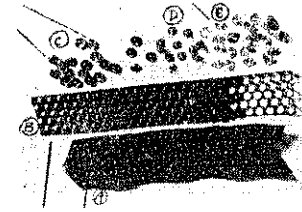

- Semi Products  
 (A) Brass strip for female  
 (B) Brass strip for male  
 (C) Female buttons  
 (D) Male buttons  
 (E) Springs

### 8) "CECOCO" AUTOMATIC METALLIC TAPE AND WIRE FORMING MACHINE:

Model PG-1

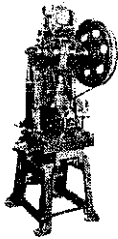

This particular machine is suitable for mass-productions of every kind of small metallic articles, such as eyelet, snap button, trouser hook, zipper parts, badge, metallic ornament, etc.

The sizes and shapes can be altered by interchanging the moulding dies. The products are finished in various ways in accordance with materials. The machine and dies will be estimated in accordance with your samples and specification of size, shape, capacity, etc. Materials to be used are all kinds of metallic tapes such as iron hoop, steel hoop, aluminium hoop etc.

Model TVN-1102

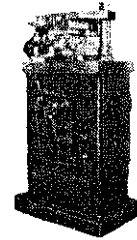

#### Specification of "CeCoCo" Metallic Tape Working Machine

Model of Machine	PR-3	PG-1	TVN-1030	TVN-1102	UF-1	TS-UF1
Revolution	150 rpm	280 rpm	700 rpm	500 rpm	120 rpm	variable
Capacity per minute	150 pcs./row	280 pcs./row	700 pcs./row	500 pcs./row	120 pieces	24 to 195 pieces
Power Required	1 HP	½ HP	1 HP	3 HP	1 HP	2 HP
Max. Material Size	2rows/lines	5rows/lines	0—25 mm	0—60 mm	1.5φ × 70mmL	2φ or 14mmW
Floor Space	90 × 100 cm	75 × 80 cm	35 × 46 cm	46 × 70 cm	100 × 150 cm	100 × 80 cm
Net Weight	1100 kg.	* 400 kg.	380 kg.	850 kg.	350 kg.	1200 kg.
Gross Weight	1100 kg.	550 kg.	480 kg.	1000 kg.	460 kg.	1500 kg.
Ship'g Meas't	120 cft	60 cft	40 cft	80 cft	70 cft	60 cft

### 9) "CECOCO" AUTOMATIC WIRE NAIL MAKING MACHINE:

Although there are various sizes and shapes of panel-pins, rivet and nails which were made of iron, steel, copper brass and aluminium, most of them are manufactured by "CeCoCo" machine, and finished generally by a polishing tumbler.

Operation: The wire is drawn from a coil and fed between straightening rollers into Feeding Roller. Chuck feeds the wire into die and then the head of the nail is formed with one blow of heading punch. After heading, the punch goes back to its former position according to the revolution of crankshaft. Wire feeding roller moves forward to make required length of the nail and both ends of cutter make the point of the nail. There are suitable blank between Cutters and Dies that the wire is left outside of the face of Dies after cutting off. The blank is to make the head of the next nail.

When the heading Punch goes to hit the head by next process, it blows off plate under the punch, thus, effects the nail off and these processes repeat continuously and automatically. *The longer and shorter nails they are manufactured easily according to the adjustment of feed-rod-connection that is equipped on the side of frame. Different gauge nails can be done by interchanging the parts.*

"CeCoCo" Automatic Wire Nail Making Machine

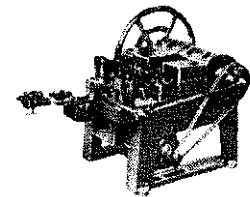

Specification of "CeCoCo" Automatic Wire Nail Making Machine

Model	Wire Gauge to be used	Length of Nail	R.P.M.	Capacity per min.	Power Req'd	Floor Space	Net Weight	Gross Weight	cft
AN-A	BWG #22-15	1/4"-1 1/2"	500	500 pcs.	1 HP	1.4x1.0 m	810 kg	900 kg	65
AN-B	" #19-13	1/4"-2"	450	450 pcs.	2 HP	1.9x1.1 m	1220 kg	1500 kg	90
AN-C	" #15-10	1/2"-3"	350	350 pcs.	3 HP	2.0x1.3 m	1710 kg	2200 kg	125
AN-D	" #14-8	1/2"-4 1/2"	300	300 pcs.	5 HP	2.7x1.5 m	2440 kg	3000 kg	180
AN-E	" #12-6	1/2"-5 1/2"	250	250 pcs.	7 1/2 HP	3.1x1.6 m	3730 kg	4500 kg	275
AN-F	" #11-4	1/2"-6 1/2"	200	200 pcs.	10 HP	4.0x2.0 m	4660 kg	5500 kg	370

Remarks: If the nail making plant is desired, please let us know the (a) size of nail gauge and length, (b) output capacity per day of each size, (c) working hours per day (d) details of electric source as phase, voltage, frequency and current.

Auxiliary Machine for Making Nail ;

9-a) Nail Polishing Machine: This is a hexagonal iron barrel in which the nails are put together with small amount of dried saw-dusts and turned round for about four consecutive hours, and the nails come out fully polished and lustrous.

When the polishing is completed, replace the cover of Barrel with Holed Cover, and drive the machine again by the rotation of Barrel the saw-dusts will be ejected through the small openings of Holed Cover, and only polished nails will remain into Barrel.

9-b) Nail Packing machine: This machine is used for charging nails over 2 inches into the cask. (Not necessary for nails less 2 inches), and is constructed with Funnel fixed to the upper part of the iron stand. Vibrator is directly connected with Motor at the lower part.

9-c) Cutter Grinder: This machine is precisely manufactured specially to suit for surfacing and finishing work for cutter and other tools.

Grinding stones furnished with the grinding machine have fine and coarse grain. Coarse stone is for rough grinding for forming after annealing punch to be replaced, and oil stone is for finishing work.

10) "CECOCO" AUTOMATIC BARBED WIRE MAKING MACHINE:

The barbed wire is produced by fabricating #12 - #14 galvanized iron wire. The barbed wire making machine is constructed in such mechanism that; firstly, 2 lines of core wire and 2 lines of barb are loaded in the machine. Secondly, the barb lines are twined round the core wire in the upper portion of the machine. As the result, barbed wire is being twisted in the lower portion of the machine. The barbed wire thus twisted into strand and finally wound and taken-up onto the take-up frame.

"CeCoCo" Automatic Barbed Wire Making Machine

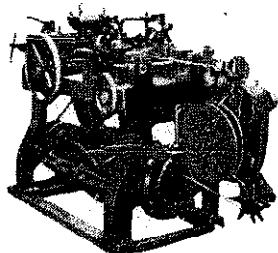

Specification of "CeCoCo" Automatic Barbed Wire Making Machine

Material to be used	:..... Galvanized Mild Steel Wire, carbon content approx. 0.16%.
Power Required	:..... 7.5 H.P.
Wire Gauge to be used	:..... BWG #12 to #16; pitch:..2 1/2 to 6 inch.
Capacity of Production	:..... 100 to 185kg. per hour, varies according to wire gauge, barb pitch and revolution.
Length & Weight of Barbed Wire wound on frame:	:..... 100 feet. 45 - 50 kg. per roll, standard
Floor Space	:..... 1.4x2.5meter
Net Weight	:..... 2,160 kg.
Gross Weight	:..... 2,800 kg.
Ship'g Measurement	:..... 230 cft

11) "CeCoCo" AUTOMATIC 'U' SHAPE WIRE STAPLE MAKING MACHINE:

Specification of "CeCoCo" Wire Staple Making Machine

Model	Length of Staple max.	Wire Gauge to be used	Capacity per minute
AU-1	1" (25 mm)	BWG # 16	2 5 0 pcs.
AU-2	1 1/2" (38 mm)	BWG # 12	2 0 0 pcs.
AU-3	2 1/2" (63 mm)	BWG # 8	1 0 0 pcs.

Model	Power	N. Weight	G. Weight	Meas't
AU-1	1/2 HP	8 0 kg	1 3 0 kg	1 5 cft
AU-2	1 HP	2 7 0 kg	3 5 0 kg	3 0 cft
AU-3	3 HP	4 0 0 kg	5 0 0 kg	5 0 cft

"CeCoCo" Automatic Wire Staple Making Machine

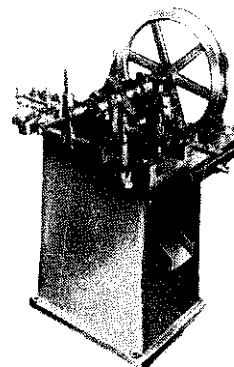

### 12) "CECOCO" AUTOMATIC SHEET TACK MAKING MACHINE :

This particular machine is capable of making sheet tacks for shoes, furnitures, agricultural tools, pins for card and clothing and also many other materials. Ordinary Mild steel cold-rolled sheet 3 ft. x 6 ft., is to be cut into a required width by Shearing Machine. These narrowly sheared pieces are fed into a Tack Making Machine.

The smaller end parts of these sheared plates are to be cut in oblique shapes. And the larger ends of those pieces are to be finished as nail-heads through heading action automatically. The finished tacks are to be polished by

"CeCoCo" Automatic Sheet Tack Making Machine

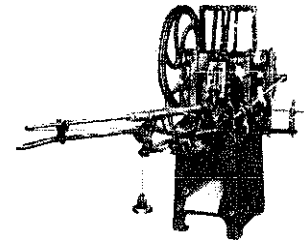

Polishing Barrel.

Blue Tack: Tack nails are to be put in a cylindrical or dish-like container, and heated evenly while stirring them.

But the heat must be strong enough to affect tacks speedily. When the tacks are heated up to about 320 degree C, they turns into light-indigo color, and if they reach to 330 degree C, they become deep indigo. While heating, pick them up now and then to inspect the degree of color, and when the desired color is obtained, take out to be cooled.

Table of Size and Capacity

Size of Tack		Size of material	Capacity
mm	inch	thick. x width	per 8 hours
6 mm	1/4"	0.9 mm x 9 mm	4 — 6 kg.
8 mm	5/16"	1.0 mm x 11 mm	5 — 8 kg.
9.5 mm	3/8"	1.0 mm x 12 mm	6 — 9 kg.
11 mm	7/16"	1.1 mm x 14 mm	7 — 11 kg.
12.5 mm	1/2"	1.2 mm x 16 mm	8.5—13 kg.
14.5 mm	9/16"	1.2 mm x 17.5 mm	10 — 15 kg.
16 mm	5/8"	1.2 mm x 19 mm	13.5—20 kg.
19 mm	3/4"	1.6 mm x 23 mm	20 — 30 kg.
22.5 mm	7/8"	1.6 mm x 27 mm	28 — 40 kg.
25.4 mm	1"	1.6 mm x 30 mm	35 — 50 kg.

Specification of "CeCoCo" Automatic Sheet Tack Making Machine

Model	Thickness of Material	Length of Tack	Power Req'd	R.P.M.	Floor Space	Net Weight	Gross Weight	Ship'g Meas't
AST-1	1.0—1.6 mm	6—25 mm	1 HP	200—220	1.0x2.5 m	750 kg	850 kg	80 cft
AST-2	1.2—2.0 mm	12—33 mm	2 HP	180—200	1.3x2.6 m	950 kg	1100 kg	100 cft

### 13) "CECOCO" BIFURCATED RIVET MAKING MACHINE :

The head part is moulded by the Cold Header similar in the case of manufacturing machine-screw and wood-screw. The forked-shank-part is cut by an Automatic Rivet Bifurcating machine and finished up by Tumbling barrel.

Specification of "CeCoCo" Rivet Bifurcating Machine

Model	Diameter of Shank	Length of Shank	Capacity per minute	Power Req'd	Dimension mm H x W x L	Net Weight	Gross Weight	Ship'g Meas't
MBR	upto 5/32"	upto 1"	35 pieces	1 HP	1320 1020 1420	790 kg	950 kg	85 cft

### 14) "CECOCO" AUTOMATIC MACHINE-SCREW MAKING MACHINE :

The rivets made firstly by the Cold Header, is slotted and threaded by a Fully Automatic Machine-screw Making machine. Then polished by Tumbling barrel to obtain good finish and finally cleaned by an Oil Separator.

The "CeCoCo" Fully Automatic Machine-screw Making Machine is a combination of conventional type Slotting Machine and Thread-rolling machine. It is so elaborately designed that rivets are slotted and threaded on the machine, thus the high quality machine screws are made. The construction is simplified and facilitates easy operation, and enables an operator to look after at least 10 to 15 sets at same time. Production cost will come down approximately half of the conventional types.

"CeCoCo" Automatic Machine-Screw Making Machine

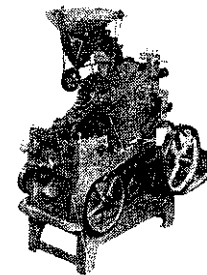

Specification of "CeCoCo" Automatic Machine-Screw Making Machine

Type	Size of Machine-screw to be made	Capacity per minute	Power Req'd	Net Weight	Gross Weight	Ship'g Meas't
M-1	upto 1/8" φ x 1" length	100 pcs.	1 HP	1000 kg	1200 kg	125 cft
M-2	" 3/16" φ x 1 1/2" "	75 pcs.	2 HP	1000 kg	1200 kg	125 cft
M-3	" 1/4" φ x 2" "	50 pcs.	2 HP	1000 kg	1200 kg	125 cft
M-4	" 5/16" φ x 2 1/2" "	35 pcs.	3 HP	1450 kg	1700 kg	190 cft
M-5	" 3/8" φ x 3" "	25 pcs.	5 HP	1450 kg	1700 kg	190 cft

15) "CECOCO" COACH SCREW THREADING MACHINE :

Coach screws are made by the moulds of the Cold Header in rivet making, and the Thread Rolling Machine is used for threading.

Specification of "CeCoCo" Coach Screw Threading Machine

Type	Size of Screw		Power Req'd	R.P.M.	Capacity per minute	Dimension in mm			Net Weight	Gross Weight	Ship'g Meas't
	Dia.	Length				Height	Width	Length			
No. 1	5/16"	3"	2 HP	1080	10 pcs.	1350	740	1400	550 kg	650 kg	85 cft
No. 2	3/8"	4"	3 HP	1080	8 pcs.	1420	915	1680	750 kg	900 kg	130 cft
No. 3	1/2"	5"	5 HP	980	6 pcs.	1475	965	1800	900 kg	1100 kg	145 cft
No. 4	5/8"	6"	5 HP	980	5 pcs.	1525	1016	1905	1100 kg	1350 kg	160 cft

16) "CECOCO" FULLY AUTOMATIC WOODSCREW MAKING MACHINE :

The manufacturing process of woodscrew is same as machine-screw making method up to the stages of heading and slotting; but threading has to be done by woodscrew threading machine. The thread of woodscrew is cut by the bite. This is opposite to the cold working by the rolling machine as in the case of machine-screw making. It requires to repeat the thread cutting 3-8 times: consequently this is low in efficiency and so that it is necessary to equip with 3-4 sets of threading machine for each one set of heading machine and slotting machine. For finishing, it is advisable to apply the tumbling barrel and the oil separator similar to that of machinescrew making.

"CeCoCo" Fully Automatic Woodscrew Making Machine

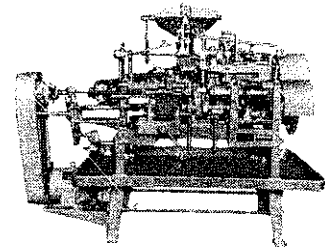

The conventional type Woodscrew Making Machines consist of Head shaving and Slotting machine, Threading machine and Scrap-separator. As this method has gone out of fashion when the "CeCoCo" Fully Automatic Woodscrew Making Machine, which is so perfectly designed that one single machine performs 5-processes of headshaving, slotting, pointing, threading and scrap-separating, is marketed with great popularity. "CeCoCo" machine is deemed very highly as a most up-to-date, efficient and most economical Woodscrew Making Machine which is an epochmaking invention in the Woodscrew Making Industry.

Specification of "CeCoCo" Fully Automatic Woodscrew Making Machine

Type	Size of Woodscrew Gauge No. x Length	Capacity per min.	Power Req'd	R.P.M.	Dimension in mm			Weight in kg		Ship'g Meas't
					H	W	L	Net	Gross	
No. 1	# 3 x 3/8" to # 6 x 3/4"	27 pcs.	1 HP	980	1270	890	1400	750	900	95 cft
No. 2	# 5 x 7/8" to # 9 x 1 1/4"	20 pcs.	1 HP	1080	1270	890	1400	750	900	95 cft
No. 3	# 8 x 1 1/2" to # 10 x 1 3/4"	15 pcs.	2 HP	1080	1320	890	1550	800	960	105 cft
No. 4	# 8 x 2" to # 14 x 2 1/2"	12 pcs.	2 HP	1080	1320	890	1550	800	960	105 cft
No. 5	# 12 x 3" to # 16 x 3"	9 pcs.	2 HP	980	1370	915	1680	900	1070	125 cft
No. 6	# 18 x 3" to # 24 x 3"	7 pcs.	2 HP	980	1370	915	1680	900	1070	125 cft

Remarks: If the woodscrew making plant is desired, please mention (a) size of woodscrew, gauge and length, (b) output capacity per hour or per day of each size, (c) kind of material to be used and (d) supply electricity stating the phase, voltage, frequency and current, etc.

WOODSCREW MAKING PLANT

Capacity of 1000 gross per day of 8 hours working

Factory

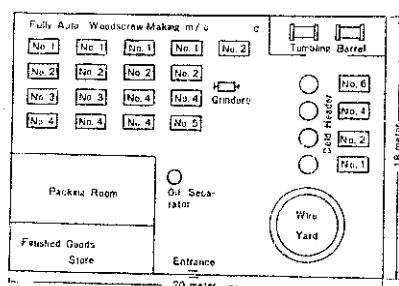

1. Area of Site ..... 6.6 ares
2. Area of Building ..... 3.6 ares
3. Area of Office ..... 0.5 ares
4. Oil Required per day ..... 20 litres
5. Water Required per day ..... 1.5 cbm
6. Electric Power per day ..... 241 KWH
7. Labour Required .....
  - Skilled worker..... 3 mens
  - Assistant worker..... 1 man
  - Odd-job..... 1 man
  - Packing worker ..... 3 womens
  - Clerk & Manager ..... 4 persns

	Type	Quantity	Size of Woodscrew	Output	Material Req'd Mild Steel Wire	Electric Consumption
Automatic Woodscrew Making Machine	No. 1	1 set	Gauge No. 3 × 3/8"	90 gross	5.9 kg.	6.0 KW
	No. 1	1 "	" No. 4 × 1/2"	90 "	10.1 kg.	6.0 KW
	No. 1	1 "	" No. 5 × 5/8"	90 "	15.8 kg.	6.0 KW
	No. 1	1 "	" No. 6 × 3/4"	90 "	23.7 kg.	6.0 KW
	No. 2	1 "	" No. 6 × 7/8"	66 "	19.7 kg.	6.0 KW
	No. 2	1 "	" No. 7 × 7/8"	66 "	25.0 kg.	6.0 KW
	No. 2	1 "	" No. 7 × 1"	66 "	28.0 kg.	6.0 KW
	No. 2	1 "	" No. 8 × 1"	66 "	31.7 kg.	6.0 KW
	No. 2	1 "	" No. 8 × 1 1/4"	66 "	39.0 kg.	6.0 KW
	No. 3	1 "	" No. 9 × 1 1/2"	50 "	42.3 kg.	12.0 KW
	No. 3	1 "	" No. 10 × 1 3/4"	50 "	57.7 kg.	12.0 KW
	No. 4	1 "	" No. 9 × 2"	40 "	44.9 kg.	12.0 KW
	No. 4	1 "	" No. 12 × 2"	40 "	68.0 kg.	12.0 KW
	No. 4	1 "	" No. 10 × 2 1/4"	40 "	60.2 kg.	12.0 KW
	No. 4	1 "	" No. 12 × 2 1/4"	40 "	85.3 kg.	12.0 KW
	No. 4	1 "	" No. 14 × 2 1/2"	40 "	105.7 kg.	12.0 KW
	No. 5	1 "	" No. 16 × 3"	30 "	112.0 kg.	12.0 KW
	Total	17 sets	17 sizes	1020 gross	775 kg.	150 KW
Cold Header	No. 1	1 set	upto No. 6 × 3/4"	366 gross	} 775 kg.	6.0 KW
	No. 2	1 "	upto No. 8 × 1"	333 "		6.0 KW
	No. 4	1 "	upto No. 14 × 2"	250 "		18.0 KW
	No. 5	1 "	upto No. 24 × 3"	183 "		30.0 KW
		Total	4 sets	17 sizes	1132 gross	
		2 sets	Tumbling Barrel			24 KW
		1 set	Oil Separator			6 KW
		1 set	Bite & Cutter Grinder			1 KW

Auxiliary Machines for manufacturing Bifurcated Rivet, Machinescrew, Coach Screw making and Woodscrew making machines,

"CeCoCo"  
Double Stroke Cold Header  
Type Nos. 1 to 6

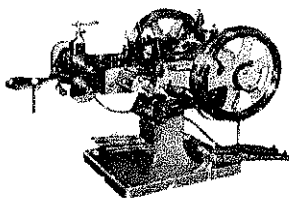

"CeCoCo"  
Tumbling Barrel

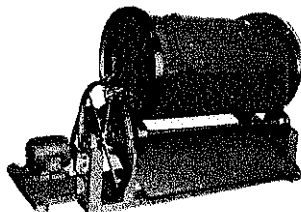

"CeCoCo"  
Oil Separator

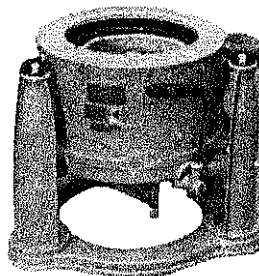

"CeCoCo" Grinder

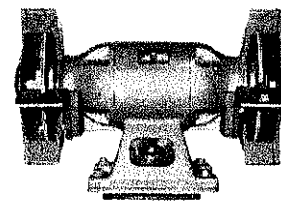

17) "CECOCO" COLD PROCESS BOLT MAKING MACHINES:

The head of rivet material made previously by the Double Stroke Cold Header is formed by the Trimming Machine into hexagon or square, and the rugged parts from the head left in this process are taken off by Pointing & Shaving Machine. The materials are to be fed into the Rolling Machine to be threaded, and finished by Polishing Barrel and Oil Separator.

17-a "CeCoCo" Double Stroke Cold Header.

The rivets which have a wide range of usage in industrial circle, are manufactured mainly by Automatic Heading Machine and finished by Polishing Barrel. The Cold Header can produce any kind of rivets out of mild steel wire and also from iron, brass, copper, aluminium, stainless steel wire etc.

Operation : The wire is straightened by the Straightening Rollers. By means of Feeding Rollers, the said wire is sent to Stopper which is adjusted to cut it into any desired length through Cutting Die. At the same time the Cutter cuts the wire, and Chucking Lever will pick it up and send it to the center of the Die. Then, Punch-box, connected with Crankshaft by Connecting-rod, advances. When the first-punch provided, it will push the cut wire into a die. at the same time, the wire end is struck to form the first head without becoming eccentric. By means of the up-down sliding cam, Punch-case will go up, and when the punch-box advances again, the second punch will form the final and perfect rivet head. As the punch-box goes back, the pushing lever moves to push the rivet out by the push-out-pin which is set in the Die. When the wire for the next rivet has already been sent to the stopper, the punch-case is pushed down, and the first-punch will be prepared for a next rivet.

"CeCoCo" Double Stroke Header

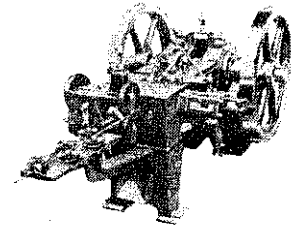

Specification of "CeCoCo" Automatic Double Stroke Cold Header

Model "AH"	Diameter of Shank	Length of Shank	Capacity per min.	Power Req'd	Max. R.P.M.	Dimension in mm			Weight in kg		cft
						Height	Width	Length	Net	Gross	
A	1/8" 4 mm	1 1/4" 32mm	120 pcs.	2 HP	240	965	890	1675	800	900	65
B	3/16" 5 mm	2" 50mm	100 pcs.	3 HP	200	1065	1015	1780	1380	1700	100
C	1/4" 7 mm	2" 75mm	80 pcs.	5 HP	160	1200	1220	1900	2200	2600	140
D	5/16" 8 mm	3 1/2" 88mm	70 pcs.	7 1/2 HP	140	1220	1450	2800	3000	3600	200
E	3/8" 11 mm	4" 100mm	60 pcs.	10 HP	120	1320	1830	3050	4100	4800	350
F	1/2" 13 mm	5" 125mm	50 pcs.	15 HP	100	1520	2030	4060	7500	8800	550
G	5/8" 16 mm	6" 150mm	40 pcs.	20 HP	80	1730	2200	5840	11500	13200	800
H	3/4" 20 mm	7" 178mm	35 pcs.	30 HP	70	1900	2290	6600	19500	22000	1250

Remark : It is recommended to use one machine for manufacturing one specific size and shape only. But any other size can be made by interchanging the Adaptable Parts and Consumption Part at extra cost. Consumption of Spare Parts for one year of 300 days running; 10pcs.-Alloy made Die, 36 pcs.-push-out pin, 6pcs.-Cutting Die, 6pcs.-Flat Cutter, 12pcs.-1st punch, 12pcs.-2nd punch.

17-b) "CeCoCo" Head Trimming Machine: This Machine is used for forming the hexagonal or square head of the cheese bolt which has been produced on the above mentioned header. Put the cheese bolt blanks in the hopper, a grooved dipper that moves up and down serves to arrange in a row with their head parts to face up and stems downward, and deliver them onto the chuck.

The chuck grasps them one by one and carries them one after another to the center of the mold. There is a hexagonal (or square) hole bored in the mold, into which each one of them is pushed in by a snap, and the hexagonal head is formed on the cheese bolt-blanks. One hexagonal bolt is produced at one turn of the machine.

"CeCoCo" Head Trimming Machine

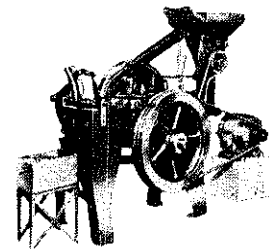

Specification of "CeCoCo" Head Trimming Machine

Model "AT"	Max. Size of Bolt-blank	Power Req'd	Capacity per minute	Net Weight	Gross Weight	Ship'g Meas't
C	1/4" φ × 3"L	1 HP	70 pcs.	500 kg	650 kg	95 cft
D	5/16" φ × 4 1/4"	1 HP	55 pcs.	900 kg	1080 kg	100 cft
E	3/8" φ × 5"	3 HP	50 pcs.	1500 kg	1700 kg	130 cft
F	1/2" φ × 5 1/2"	5 HP	45 pcs.	2000 kg	2780 kg	150 cft
G	5/8" φ × 7"	7.5 HP	40 pcs.	4000 kg	4800 kg	200 cft
H	3/4" φ × 8 1/2"	10 HP	35 pcs.	9000 kg	10400 kg	5200 ft

Consumption of Spare parts for one year;  
 12 pcs. ... Trimming Mold  
 6 pcs. ... 1st Punch  
 6 pcs. ... 2nd Punch



17-c) "CeCoCo" Pointing & Head Shaving Machine: This is also an automatic machine which is to shave the backside of the hexagonal head which has been formed on the semi-finished hexagonal bolt-blank, and at the same time makes pointed end on the stem.

"CeCoCo" Pointing & Head Shaving Machine

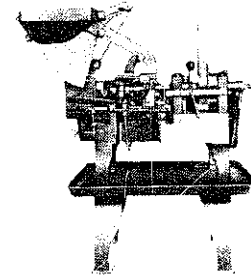

Specification of "CeCoCo" Pointing & Head Shaving Machine

Model "APS"	Max. Size of Bolt-blank	Power Req'd	Capacity per minute	Net Weight	Gross Weight	Ship'g Meas't
C	1/4" φ × 3"L	1 HP	45 pcs.	400 kg	500 kg	60 cft
D	3/8" φ × 3"	1 HP	40 pcs.	500 kg	620 kg	75 cft
E	3/8" φ × 3"	1 HP	40 pcs.	650 kg	790 kg	80 cft
F	1/2" φ × 4"	1 HP	30 pcs.	700 kg	880 kg	90 cft
G	5/8" φ × 5"	1 HP	25 pcs.	950 kg	1200 kg	120 cft
H	3/4" φ × 6"	2HP	20 pcs.	1200 kg	1500 kg	150 cft

Consumption of Spare Parts for one year 12 pcs. ... Pointing Cutter; 12 pcs. ... Shaving Cutter.

17-d) "CeCoCo" Thread Rolling Machine: At first, load the trimmed bolts into the bucket which has a hopper to move up and down. The bolts chute along the plate cutter by their own weight, and then are pushed away toward Dic-plate by the push-out-plate. After receiving of the bolt, one pair of Die-plates will thread rolls the same.

Specification of "CeCoCo" Thread Rolling Machine

Model "AR"	Size of Screw Dia. × Length	Power Req'd	Capacity per minute	Net Weight	Gross Weight	Ship'g Meas't
A	upto 1/8" φ × 1 1/4"	1 HP	120 pcs.	300 kg	400 kg	60 cft
B	" 3/16" φ × 2"	2 HP	100 pcs.	550 kg	700 kg	100 cft
C	" 1/4" φ × 3"	3 HP	80 pcs.	830 kg	1000 kg	120 cft
D	" 5/16" φ × 3 1/2"	3 HP	70 pcs.	1200 kg	1500 kg	200 cft
E	" 3/8" φ × 4"	5 HP	60 pcs.	2200 kg	2700 kg	300 cft
F	" 1/2" φ × 5"	7.5 HP	50 pcs.	3150 kg	3800 kg	500 cft
G	" 5/8" φ × 6"	10 HP	40 pcs.	5100 kg	6000 kg	750 cft
H	" 3/4" φ × 7"	15 HP	30 pcs.	7000 kg	8200 kg	900 cft

"CeCoCo" Thread Rolling Machine

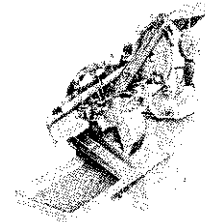

Consumption of Spare Parts for one year of 300 days running; 6 pairs of Die-plates

17-e) Auxiliary Machines are necessary such as Polishing Barrel, Oil Separator & Grinder.

18) "CECOCO" COLD PROCESS NUT MAKING MACHINE:

"CeCoCo" Nut Making Machine

18-a) "CeCoCo" Nut Cutting Machine: This machine is used for automatically making hexagonal or square nut blanks through the process of drilling, chamfering and cutting from cold-drawn bars of hexagonal or square by means of cold process.

A bar fed into the machine is chucked, and a hole is drilled at the center of the bar. The nut-face is chamfered, and then the nut is cut from the bar. The above processes are repeated automatically with every nut. The change in sizes can be made by interchanging the parts at extra cost.

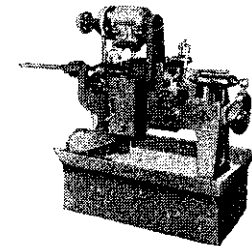

Specification of "CeCoCo" Nut Cutting Machine

Model 'ANC'	Diameter of Screw	Diameter of bar to be used	Capacity per minute	Power Req'd	Net Weight	Gross Weight	Ship'g Meas't
1	1/4"	10 × 11.5 mm	max. 13 pcs.	2 HP	700 kg	900 kg	90 cft
	5/16"	14 × 16.2 mm	max. 11 pcs.				
	3/8"	17 × 19.0 mm	max. 8 pcs.				
2	1/2"	21 × 23.6 mm	max. 7 pcs.	3 HP	750 kg	970 kg	120 cft
	5/8"	26 × 29.7 mm	max. 5 pcs.				
3	3/4"	32 × 36.5 mm	max. 3 pcs.	5 HP	800 kg	1300kg	150 cft

Consumption of Spare parts for one year of 300 days running; 20 pcs. each ..... Cutting bite; Shaving bite and Twist drill.

18-b) "CeCoCo" Nut Tapping Machine: This machine is designed for tapping nut, hexagonal, square and sheet into nut-blanks, which have been cut or punched by a cold process. By the bent tap system, nuts pass along the top of the tap fully automatic and non-reversible.

Nut blanks are filled in the hopper and pass down through the feeding chute to the ejector which feeds the blanks one at a time into the tap, and are ejected off at the end and fall into the basket. *The change in sizes can be done by interchanging the parts at extra cost.*

Specification of "CeCoCo" Nut Tapping Machine

Model 'ANT'	Diameter of Screw	R.P.M. of Main shaft	Capacity per minute	Power Req'd	Net Weight	Gross Weight	Ship'g Meas't
1	1/8"	700	max. 60 pcs.	1/2 HP	200 kg	300 kg	36 cft
	3/16"	600	max. 50 pcs.				
	1/4"	450	max. 40 pcs.				
	5/16"	350	max. 30 pcs.				
	3/8"	250	max. 18 pcs.				
2	1/2"	200	max. 12 pcs.	1 HP	350 kg	490 kg	42 cft
	5/8"	150	max. 8 pcs.				
	3/4"	100	max. 6 pcs.				

"CeCoCo" Nut Tapping Machine

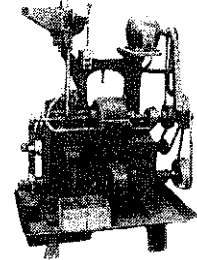

Remarks: If the bolt & nut working plant is required, please inform (a) size of products, (b) output capacity in pieces per hour or per day of each size (c) details of electric source as voltage, frequency and current.

19) "CECOCO" UNIVERSAL SPRING COILING MACHINE:

The raw material wire supplied from Wire-guide-hole is firstly straightened by Wire-Straightening-Rollers and is carried forward Forwarding-Rollers. When the wire is strucked at the end-plate then it will start to make a curve by the feed-compression of the forwarding-rollers, and finally becomes a coil-shape around mandrel or axis.

Unless the forwarding rollers comes to a stop, the process will continue. When a spring is coiled to a required length, it is automatically cut and drops out of the machine.

Specification of "CeCoCo" Universal Spring Coiling Machine

Type		105C	305C
Dia. of Wire to be used		0.3—1.5 mm	1.0—3.5 mm
Outer Dia. of Spring to be coiled		2.5—20 mm	5.0—40 mm
Capacity per minute		35—70 pcs.	40—120 pcs.
Power Required		1/2 HP	3 HP
Feeding Speed of Wire		0.6—40 m/min.	3—20 m/min.
Dereel opped Length		800 mm	50—4,000 mm
Overall Dimension	Height	1,100 mm	1,250 mm
	Width	350 mm	875 mm
	Length	500 mm	750 mm
Net Weight		250 kg.	900 kg.
Gross Weight		300 kg.	1,100 kg.
Ship'g Measurement		15 cft	50 cft

"CeCoCo" Universal Spring Coiling Machine

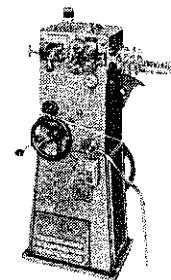

20) "CECOCO" AUTOMATIC SPRING COILING MACHINE:

To ensure the precision of all main spindle gears and feed rollers they are made of special steel and are hardened and ground. For the guides and components, subject to heavy stress extra-hard metal alloys, are used in order to reduce wear and the main parts are treated against corrosion.

The motor is equipped with three-speed change and the pulley with stepless variation and the speed of wire feed can freely be adjusted by the handles on both sides of the machine.

Developing length can readily be adjusted from 100 mm to 5,500 mm by means of the internal change-gear and clutch-cam. To facilitate adjustment of pitch, spring-shape and cutters, the relative cam is fitted externally.

Specification of "CeCoCo" Automatic Spring Coiling Machine

1. Type ..... ST-1
2. Dia. of Wire to be used ..... 0.2 — 1.0 mm
3. Dia. of Spring to be coiled ..... 1.7 to 15 mm
4. Capacity of production ..... 25 — 450 pcs./minute
5. Feeding Speed of Wire ..... 6 to 45 meter/minute
6. Power Required..... ½ H.P.
7. Dimension of Machine ..... 1,140 × 500 × 460 mm
8. Net Weight ..... 300 kg.
9. Gross Weight ..... 350 kg.
10. Ship'g Measurement..... 15 cft

"CeCoCo" Automatic Spring Coiling Machine



21) "CECOCO" AUTOMATIC TORSION COILING MACHINE:

This machine rotates the core-shaft by reciprocal movement of a rack-gear. Wire is wound on this core-shaft to produce springs automatically and continuously. The number of turns is determined by adjusting the eccentricity of the rod that moves the rack-gear attached to the turn number controlling pulley. When the winding of a spring is completed, the core shaft starts a reversed rotation. The cutter functions when the spring-back is completed, and cuts the spring. The material wire passes through the corrector when the core-shaft returns to its original position by the guide. Then the wire-feed-device works and the wire will jump into the claws of the core-shaft.

Thus wire feeding, winding and cutting are performed automatically and continuously by the cam attached on the shaft.

Specification of "CeCoCo" Automatic Torsion Coiling Machine

Type		NT1-24	NT2-30
Dia. of Wire to be used		0.2 — 1.4 mm	0.5 — 2.0 mm
Number of Coil		max. 24 T	max. 30 T
Length of Leg		max. 30 mm	max. 50 mm
Outer Dia. of Spring		max. 15 mm	max. 25 mm
Free length		max. 50 mm	max. 80 mm
Capacity per minute		40 — 80 pcs.	20 — 60 pcs.
Power Required		¼ HP	½ HP
Overall Dimension	Height	460 mm	1,050 mm
	Width	900 mm	1,150 mm
	Length	980 mm	1,200 mm
Net Weight		110 kg.	280 kg.
Gross Weight		150 kg.	350 kg.
Ship'g Measurement		20 cft	35 cft

"CeCoCo" Automatic Torsion Coiling Machine

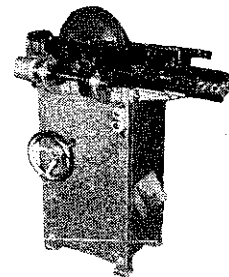

22) "CECOCO" AUTOMATIC CHAIN MAKING MACHINE:

- Fig. 1 ..... Baby Chain Produced by Model BC-63 Machine
- Fig. 2 ..... 8-shape Chain Produced by Model 8SC-63 Machine
- Fig. 3 ..... Fluorescent Lamp Chain Produced by Model FC-63 Machine
- Fig. 4 ..... Oval-shape Chain Produced by Model OS-63 Machine
- Fig. 5 ..... Dog Chain Produced by Model DC-63 Machine

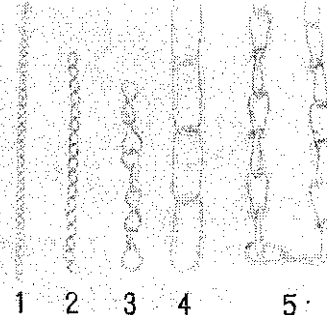

Specification of "CeCoCo" Automatic Chain Making Machine

Model	BC-63	8BC-63	FC-63	OS-63	DC-63
Dia. of Wire	0.6 — 1.2 mm	0.7 — 1.6 mm	0.8 — 1.5 mm	1.0 — 3.0 mm	2.0 — 3.0 mm
Capacity per minute	100 links	70 links	60 links	50 links	45 links
Net Weight	100 kg.	180 kg.	500 kg.	1500 kg.	1600 kg.
Gross Weight	150 kg.	250 kg.	650 kg.	1900 kg.	2000 kg.
Ship'g Measurement	20 cft	35 cft	40 cft	85 cft	120 cft

### 23) "CECOCO" UNIVERSAL WIRE WEAVING LOOM:

This equipment is used to fabricate a netting of a small square designs depending upon the size of mesh required in the final finishing of product. By varying size of mesh or type of material, many different types of netting can be produced. The gauge of wire must not be too large. On the contrary, a netting having a mesh size as # 120 per inch may be fabricated on this machine from wires of small gauge. The popular material for this type of netting are galvanized iron, brass, bronze, copper, stainless steel, and aluminium wires and synthetic fibres such as vinyl, nylon, polyethylen, etc.

In principle, warp wires are alternately grouped into the upper and lower sections, and weft wires are being shot through these sections to form up a netting. The fundamental mechanism is that the warp wires leading through the reeds are raised or lowered by the healds to fall into two groups, thereby making a passage for a weft wire to go through. The shuttle, which looks like a miniature boat and containing weft wires, streaks through this passage, but in return trip, they pass through a new passage which has been formed by exchange positions of two groups of warp wires.

In the meantime, the reeds advance to gather up the weft wire in one end of the loom. The vertical motion of healds to make a passage for weft wires is called the "shedding motion" and the reciprocating motion of a shuttle is called the "picking motion", while the "beating motion" denotes the motion of reeds. A wire netting is fabricated through a combination of these three motions.

**Woven Wire Netting:** The netting is, mostly, of a square design, and if warp and weft wires which run within a square inch, say, 16 x 16, the product is classified as a 16 mesh per inch netting.

The production may include various mesh sizes, which range from #2 mesh or 2 wires in an inch square to #120 mesh or 120 wires in an inch square.

The netting is usually made to measure 3 feet wide x 100 feet length per roll. The auxiliary machines require the Bobbin Winding Machine, Bobbin Stand and Beaming Carriage.

Different mesh nettings can be manufactured by changing the reed, and then various wire gauge can be used by changing the reed.

Specification of "CeCoCo" Universal Wire Weaving Loom

Type	Mesh of Netting per inch	Size of Wire to be used	Power Req'd	R.P.M.	Capacity of Length in inch	Net Weight	Gross Weight	Ship'g Meas't
A	2 to 20	BWG #18 — 26	3 HP	50	70RPN x operating time in minute x mesh per inch	3600 kg	4500 kg	500 cft
B	10 to 30	BWG #25 — 36	2 HP	70		2200 kg	3150 kg	400 cft
C	30 to 120	BWG #35 — 47	1 HP	70		1800 kg	2000 kg	360 cft

Output per day of 8 hours in use galvanized iron wire

Type of Loom	Wire Gauge	Mesh of Netting	Capacity per day	Material per day
A	#18	2	800 ft	348 kg
	#18	4	400 ft	346.8 kg
	#18	6	300 ft	390.6 kg
	#18	10	200 ft	434.4 kg
	#20	10	250 ft	280.5 kg
B	#25	20	150 ft	109.8 kg
	#25	10	250 ft	86.0 kg
	#28	14	200 ft	50.0 kg
	#30	16	200 ft	39.2 kg
	#33	20	130 ft	29.406 kg
C	#35	40	80 ft	25.440 kg
	#30	18	120 ft	25.8 kg
	#35	50	40 ft	10 kg
	#40	80	20 ft	3.4 kg
	#42	100	15 ft	2.25 kg
	#42	120	12 ft	2.16 kg

"CeCoCo" Universal Wire Weaving Loom

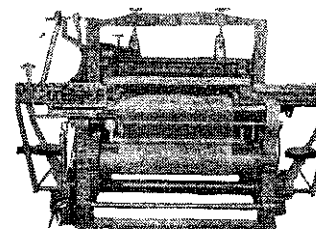

### 24) "CECOCO" HEXAGONAL WIRE NETTING MACHINE:

The honeycomb wire netting is produced on a hexagonal wire netting machine. This machine, however, can make only one mesh type of netting.

Thus, as suggested in the introductory chapter, it requires nine types of machinery to produce nine mesh types of hexagonal wire netting. The gauge of wire material preferably ranges from #18 to #24 B.W.G. This type of netting can be fabricated in any desired width such as 1.5 ft., 2.0 ft. etc., up to 6 ft.

The length may be as long as 200 feet. In operation, a wire supplied from a wooden bobbin is twisted together with another wire from a spiral coil rod. The former wire will be supplied to the bobbin by means of a Bobbin Winding Machine, while the latter will be supplied to the spiral coil rod through a Spiral Coiling Machine.

The wires supplied from a number of bobbins and also from the corresponding number of spiral rods travel through the holes provided in the semi-circular pinion gear, which rotates alternately to entwine with one another, and this process is continued to weave a netting of the hexagonal design.

Specification of "CeCoGo" Hexagonal Wire Netting Machine

Type (Mesh)	Capacity per 8 hours	Width of Netting	Wire Gauge to be used	Number of Parts		Net Weight	Ship'g Meas't
				Spiral Rod	Pinion Gear		
3/8"	800 feet	4 feet	BWG #24-21	100 pcs.	30 pcs.	1200 kg	250 cft
1/2"	1,000 feet	6 feet	" #22-20	100 pcs.	30 pcs.	1500 kg	320 cft
5/8"	1,200 feet	6 feet	" #22-19	90 pcs.	30 pcs.		
3/4"	1,350 feet	6 feet	" #22-18	75 pcs.	30 pcs.		
1"	1,650 feet	6 feet	" #22-18	65 pcs.	30 pcs.		
1 1/4"	2,000 feet	6 feet	" #22-18	50 pcs.	30 pcs.		
1 1/2"	2,500 feet	6 feet	" #22-18	40 pcs.	30 pcs.		
2"	3,000 feet	6 feet	" #22-18	25 pcs.	30 pcs.		

Power Required: 2 H.P. for every types

25) "CECOCO" ZIP FASTENER MAKING MACHINES:

The Name of Zipper Parts

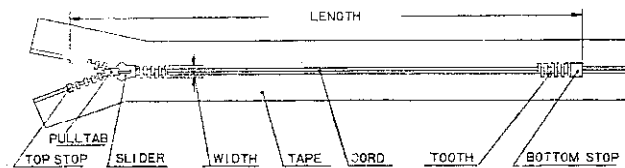

Model Plan for Making Zip-Fastener

Name of Machines	Model KP-1	Model KP-2	Model KP-3	
Zipper Chain Making Machine	1 set	6 sets	10 sets	
Chain Polishing Machine	1 set	1 set	1 set	
Chain Rolling Machine	1 set	1 set	1 set	
Waxing & Mangle Machine		1 set	1 set	
Zipper Teeth Cutting Machine	1 set	2 sets	2 sets	
Top-Stop Attaching Machine	1 set	1 set	2 sets	
Bottom-Stop Attaching Machine	1 set	1 set	1 set	
Surface Grinder	1 set	2 sets	2 sets	
Tape & Cord Stitching Machine	1 set	3 sets	5 sets	
Slider Making Machine (Dieing Machine).....			1 set	
Pull-Tab Making Machine (Dieing Machine) ...			1 set	
Top-stop Making Machine (Dieing Machine) ...			1 set	
Bottom-stop Making Machine (Dieing Machine).....			1 set	
Slider & Pull-Tab Assembling Machine.....			2 units	
Labour Required	Skilled	1	2	5
	Unskilled	3	3	8
	Female worker	2	5	18

Size of Zip-Eastener

Size No.	Width
No. 1	3.0 mm
No. 2	3.5 mm
No. 3	4.5 mm
No. 4	5.0 mm
No. 5	6.0 mm
No. 7	6.5 mm

The materials of Zip-Fastener to be used :-

- a) Tape & cord  
..... Cotton
- b) Teeth  
..... Aluminium or Brass Flat Wire
- c) Slider, Pull-tab, Top-stop and Bottom-stop parts  
..... Brass Flat Wire

Model KP-1 ..... This is a model unit to start a new factory of zip-fasteners as the minimum scale obtainable. Therefore, this is not always economical. In this plan, one to three sets of the 'Zipper Chain' making machines will be adopted. (already manufactured materials such as top-stop, bottom-stop, slider, pull-tab and cotton tape parts are used.)

Model KP-2 ..... This plan is made to start as minimum scale factory which will be profitable as an industry. For the advancement of your factory, it is recommended to adopt the additional sets of machine. (already manufactured materials such as top-stop, bottom-stop, slider, pull-tab and cotton tape parts are used.)

Model KP-3 ..... This plant is made to start as an ordinary scale factory judging from the economical point of views. In case when more sets of the machines be adopted, the cost of the products will be reduced. Further, when more than 10 sets of 'zipper chain' making machines are adopted, it is recommended to adopt

the machines to manufacture the component parts of zip-fasteners such as 'slider', 'pull-tab', 'top-stop', 'bottom-stop' and 'cotton tape stitched with cord' etc. as additional, being economical than to purchase these parts made by the other factory.

**a) Zipper Chain Making Machine :**

The teeth planting is most important in zip-fastener making process. This chain machine is made so simple as 3 to 5 sets being attended by a person. Teeth making and planting teeth onto the cotton tape are automatically done at a time. Being equipped with the automatic planting-length control device means of sizing apparatus, it can adjust freely the zip-fastener in length, enabling continuous operation.

Capacity : ..... 2,000 — 2,500 single yards per day

Revolution : ..... 2,100 — 2,600 r.p.m.

Power Required : ..... 1/2 HP for machine & 1/4 HP for Vacuum pump.

Material to be consumed : .....

Size No. 3 ... 7.2 kg. of Aluminium Wire and 15.6 gross yards of Cotton Tape per day.

Size No. 5 ... 16 kg. of Aluminium Wire and 18 gross yards of Cotton Tape per day.

Net Weight: 480kg.; Gross Weight: 600kg.; Meas't: 60 cft.

"CeCoCo"  
Zipper  
Chain  
Making  
Machine

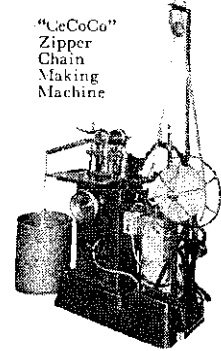

**b) Chain Polishing Machine :**

This machine is used for polishing and brushing the planted teeth, doing the work on three sides of teeth at a single operation. This is the first step of the finishing process of high-quality zip-fastener.

Capacity : 28,000 double yards/day

Power Required : 1/2 H.P.

N.W. 95kg.; G.W. 145 kg.; Meas't 30 cft.

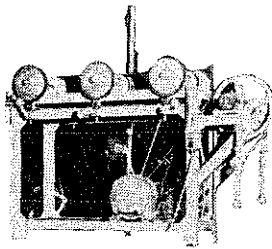

**c) Chain Rolling Machine ;**

This machine is used for flattening and tightening the planted teeth as a stop of finishing operation, and is also available for different sized zip fasteners by adjusting the gap between the upper and lower roller.

Capacity : 16,000 double yards/day

Power Required : 1/4 H.P.

N.W. 320 kg.; G.W. 370 kg.; Meas't 30 cft.

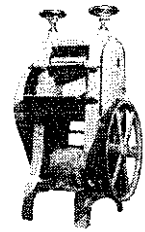

**d) Waxing & Mangle Machine :**

This machine consists of 3 parts, i.e the upper, middle and lower. The upper part has 3 automatic transformers, an ammeter and a guide controller for finished zipper chain and a delivery roll. The middle part has 6 rotating irons in two rows and 3 pressing rolls along with the tape reversing roll and waxing devices with which both sides of the zipper chain can be waxed while running through this machine.

The lower part consists of a reduction gear, delivery roll (100rpm) and motived direct with 1/2 HP motor.

Every top-quality fastener manufacturer installs this machine in the plant.

Capacity : ..... 24,000 double yards per day; Heater : ..... 2.4 K.W.

Net Weight : ... 400 kg.; Gross Weight : ... 500 kg.; Ship'g Meas't : ... 130 cft.

Waxing & Mangle  
Machine

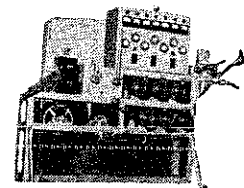

**e) Zipper Teeth Cutting Machine :**

This machine is designed for removing zipper teeth of the tape at any required interval so as to cut the slide fastener in required lengths, by ateping on the pedal installed on the lower left side.

Capacity : ..... 12,000 pcs. per day

Power Required : ..... 1/4 H.P.

N.W. : 140kg. G.W. : 185kg. Ship'g Meas't : 30 cft

Zipper Teeth  
Cutting Machine



**f) Surface Grinder :**

This machine is used for correcting and sharpening the dies of zipper chain making machine, etc. Size of wheel: 100-200mm; Req'd 1/2HP mtroo; Net wt. 260kg.;

Surface Grinder

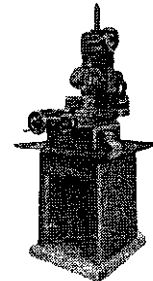

**g) Top-stop and Bottom Stop Attaching Machines :**

Both machines are recently completed by conquering the difficulty to set Top and Bottom stops automatically.

"CeCoCo" Top-stop  
Attaching Machine

"CeCoCo" Bottom-stop  
Attaching Machine

Name of Machine	Top-stop Attaching Machine	Bottom-stop Attaching Machine
Capacity per day	14,000 pcs.	15,000 pcs.
Power Required	1/4 HP	1/4 HP
Net Weight	120 kg.	130 kg.
Gross Weight	170 kg.	180 kg.
Ship'g Meas't	30 cft.	30 cft.

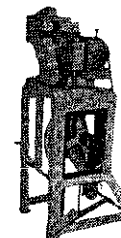

27) "CeCoCo" AUTOMATIC RIVET DRILLING MACHINE :

This drilling machine is used generally for drilling vertical holes of tubular rivets and lining rivets; in most cases it is operated in combination with the cold header.

Max. diameter to be drilled—3/16"; Max. depth to be drilled—1/2"; Capacity—35 pcs. per minute; Attached 1/2HP motor; Net Weight—400kg.; Gross Weight—450 kg.; Meas't 35 cft.

"CeCoCo" Automatic Rivet Drilling Machine

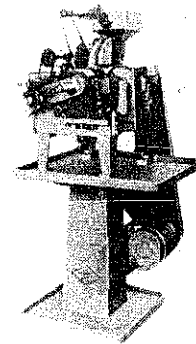

28) "CeCoCo" AUTOMATIC BOLT HEAD HOLLOWING MACHINE: for making 'Allen' Socket Screw.

This machine is used for hollowing the head of bolt blanks by interchangeable Hollowing Punch; in most cases it is operated in combination with the cold heading machine and thread rolling machine.

Specification of "CeCoCo" Bolt Head Hollowing Machine

Model	Max. Dia. of Shank		Max. Length of Shank		Capacity per minute
SOC-1	3/8"	10mm	2"	50mm	45 pieces
SOC-2	5/8"	16mm	4 3/4"	120mm	35 pieces

Model	Power	N. Weight	G. Weight	Meas't
SOC-1	3 HP	1500kg.	1700kg.	130cft
SOC-2	7 1/2 HP	4000kg.	4800kg.	200cft

"CeCoCo" Automatic Bolt Head Hollowing Machine

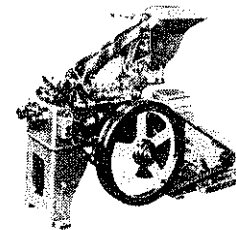

26) "CeCoCo" SINGLE STROKE COLD HEADER :

The header is a machine to be used for shaping a part of lineal material into head-form, applying strong mechanical pressure on it, the single stroke pressing will be enough in general for making rivets or steel balls.

Specification of "CeCoCo" Single Stroke Cold Header

Model	Max. Dia. of Shank	Max. Length of Shank	Capacity per minute	Power Req'd	Net Weight
ASH-A	3.5mm	3/4" 20mm	300 pcs.	1 HP	500kg
ASH-B	5.2mm	1 1/2" 38mm	250 pcs.	2 HP	950kg
ASH-C	7.2mm	2" 50mm	230 pcs.	5 HP	2200kg
ASH-D	9.6mm	3" 75mm	200 pcs.	7 1/2 HP	3000kg

"CeCoCo" Automatic Single Stroke Cold Header

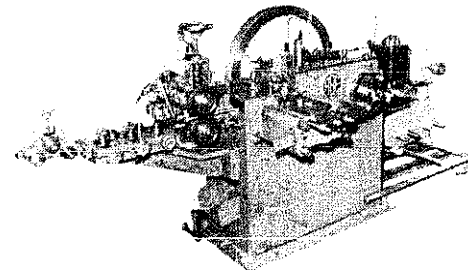

29) "CeCoCo" DRAWING PIN (THUMB TACK) OR CHAIR NAIL MAKING UNIT :

Daily Output :—50,000 pieces per 8 hours

Required Machines :—

1. Head Cutting-out Machine..... 1 set
2. Push Pin Making Machine ..... 1 set
3. Caulking Machine..... 2 sets
4. Hand Assembling Tool ..... 8 pcs.

Size of Pin or Nail :—any size is possible by changing the "Replacement part" or "Die" at extra cost.

How to Make :—

1. Please push in the pins which were made by the Push Pin Making Machine into the holes of die on the rotary table of Caulking Machine.
2. Put the Head-disks which were made by Head Cutting-out Machine on the above-mentioned push pins.
3. According to the operation of the Caulking Machine, semi-automatically it caulks pins and the finished product comes out of the hole successively.

Specification of "CeCoCo" Drawing Pin or Chair Nail Making Machine

Name of Machine	Type	Power Req'd	Capacity per minute	Net Weight	Gross Weight	Ship'g Meas't
Head Cutting-out m/c	Auto.	2HP	120 pcs.	400 kg	500 kg	60 cft
Push Pin Making m/c	Auto.	1HP	450 pcs.	400 kg	520 kg	50 cft
Caulking machine	Semi-Aut.	1HP	60pcs.	220 kg	300 kg	40 cft

30) "CeCoCo" INTERLINK WIRE NETTING MACHINE:

The diamond wire lath is fabricated on this machine. Usable for reinforcing basket, fence or barrier, backstop, concrete reinforcement, lathing and PVC covered fancy net.

Mesh size may be made by only changing the part of 'Giraffe' at extra cost. Available mesh are 13 sizes of 1/2", 5/8", 3/4", 1", 1 1/4", 1 1/2", 2", 2 1/2", 3", 4", 5" and 6".

Diagram of "CeCoCo" Interlink Wire Netting Machine

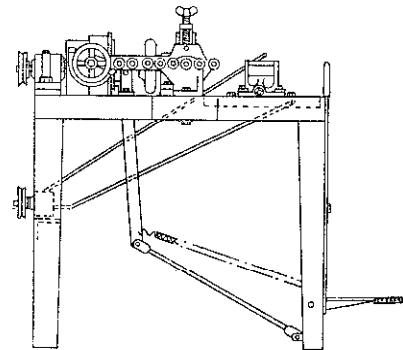

Specification of "CeCoCo" Interlink Wire Netting Machine

Type	A	B
Wire to be used	BWG #6-#132	BWG #14-#20
Mesh available	1/2" to 6"	1/2" to 2"
Capacity per hour	70 kg.	23 kg.
Power Required	3 HP	1/2 HP
Net Weight	500 kg.	250 kg.
Gross Weight	800 kg.	350 kg.
Measurement	110 cft	55 cft

1) Table of Legal Wire Gauges

No.	B.S. m/m	S.W.G. m/m	B.W.G. m/m	No.	B.S. m/m	S.W.G. m/m	B.W.G. m/m
#0000		10.159	11.532	# 19	.9144	1.016	1.067
#000		9.448	10.795	# 20	.8128	.9144	.889
# 00		8.839	9.652	# 21	.7239	.8128	.8128
# 0		8.23	8.636	# 22	.6428	.7112	.7112
# 1	7.341	7.620	7.620	# 23	.574	.6095	.635
# 2	6.553	7.010	7.214	# 24	.5105	.5588	.5588
# 3	5.817	6.40	6.579	# 25	.4547	.508	.508
# 4	5.182	5.893	6.405	# 26	.4039	.458	.458
# 5	4.623	5.385	5.588	# 27	.3607	.4166	.4064
# 6	4.115	4.887	5.156	# 28	.315	.3759	.3556
# 7	3.658	4.470	4.572	# 29		.3454	.3302
# 8	3.251	4.065	4.191	# 30		.3150	.3048
# 9	2.896	3.658	3.759	# 31		.2946	.254
# 10	2.591	3.251	3.404	# 32		.2743	.2286
# 11	2.311	2.948	3.048	# 33		.2540	.2031
# 12	2.057	2.642	2.769	# 34		.2337	.1777
# 13	1.828	2.337	2.413	# 35		.2134	.127
# 14	1.626	2.032	2.108	# 36		.1930	.1016
# 15	1.448	1.828	1.828	# 37		.1727	
# 16	1.295	1.626	1.651	# 38		.1524	
# 17	1.143	1.422	1.473	# 39		.1321	
# 18	1.016	1.219	1.245	# 40		.1219	

2) Table of Legal Weights

Gauge m/m	Sectional Area mm <sup>2</sup>	Weight in grams per meter			
		Steel	Copper	Brass	Alum.
0.50	0.1963	1.54	1.75	1.65	0.53
0.55	0.2376	1.87	2.11	2.00	0.64
0.60	0.2327	2.22	2.52	2.37	0.76
0.65	0.3318	2.60	2.95	2.79	0.90
0.70	0.3848	3.02	3.42	3.23	1.04
0.80	0.5027	3.95	4.47	4.22	1.36
0.90	0.6362	4.99	5.66	5.34	1.72
1.0	0.7854	6.17	6.99	6.60	2.12
1.6	2.011	15.79	17.90	16.89	5.43
2.0	3.143	24.66	27.96	26.39	8.48
2.6	5.309	41.68	47.25	44.60	14.33
3.5	9.621	75.52	85.63	80.82	25.98
4.0	12.57	98.67	112.0	106.0	33.94
4.5	15.90	125.0	142.0	134.0	42.93
5.0	19.63	154.0	175.0	165.0	53.0
5.5	23.76	187.0	211.0	200.0	64.15
6.0	28.27	222.0	252.0	237.0	76.33
6.5	33.18	260.0	295.0	279.0	89.65
7.0	38.48	302.0	342.0	323.0	104.0
8.0	50.27	395.0	447.0	422.0	136.0
9.0	63.62	499.0	566.0	534.0	172.0
10.0	78.54	617.0	699.0	660.0	212.0



# "CECOCO" PULVERIZING-GRINDING MACHINES

## "CECOCO" PULVERIZING-GRINDING MACHINES

### a) "CECOCO" UNIVERSAL IMPACT PULVERIZER :

This is most widely used as a impact mill, which pulverize any materials, i. s. food, food-supply, fertilizer, ores, chemicals and others, in 5 to 200 mesh (2.0 0.1 mmφ) size range by interchanging the perforated metal screen.

The feed material reserved in Hopper, is regulated by feed rate by damper, and then enters into grinding chamber by shaker through magnet box. The feed material is pulverized by shock and tearing action between rotor and stator revolving at high speed, and then moves to the inter periphery of grinding chamber, where the screen frame with perforated metal screen is placed. The powder able to pass through this screen is discharged into chute and collected as a product. Air causing whirling wind is expelled through the bag filter.

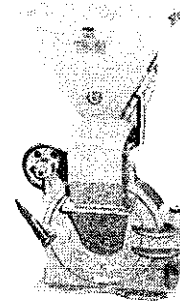

Specification of "CeCoCo" Universal Impact Pulverizer

Type	Power Req'd	Dia. of Rotor	R.P.M.	Size of Screen mm	Dimension in mm			Net weight	Gross Weight	Ship'g Meas't
					Height	Width	Length			
No. 0	1/2-1HP	152 <sup>7</sup> / <sub>16</sub> "	7000	37× 570	550	250	260	25 kg	35 kg	5 cft
T1	1-2HP	180 <sup>7</sup> / <sub>16</sub> "	6000	56× 750	710	300	330	55 kg	70 kg	11 cft
No. 1	2-3HP	220 <sup>7</sup> / <sub>16</sub> "	5000	56× 850	800	340	420	82 kg	98 kg	13 cft
No. 2	3-5HP	299 <sup>7</sup> / <sub>16</sub> "	4500	85×1200	1030	400	560	165 kg	210 kg	27 cft
2 1/2	5-7.5	299 <sup>7</sup> / <sub>16</sub> "	3800	100×1200	1320	600	735	230 kg	280 kg	35 cft
No. 3	10HP	472 <sup>7</sup> / <sub>16</sub> "	3200	94×1750	1370	1000	960	400 kg	600 kg	60 cft
No. 4	15-20	533 <sup>7</sup> / <sub>16</sub> "	2800	115×1960	1700	820	1050	680 kg	930 kg	75 cft

Table of Capacity in kgs. per hour

Example in kg.

Type	Rice	Soybean	Sugar	Corn	Starch	Dry-fish	Mica	Coal	Talc
No. 0	20	35	30	20	55	20	10	10	20
T1	30	50	65	50	100	50	20	20	40
No. 1	40	70	90	55	150	55	30	30	50
No. 2	80	130	190	150	375	150	80	40	140
2 1/2	100	160	220	200	420	200	100	60	160
No. 3	160	260	300	300	700	300	150	100	200
No. 4	500	800	900	900	2100	900	400	300	600

Remarks: Capacity varies according to the material, condition pulverizing size or screen mesh, revolution, etc.

Size of Screen

Perf. mmφ	Mesh
0.1	150-200
0.2	140-170
0.3	120-140
0.4	100-110
0.5	80-100
0.6	60- 80
0.7	50- 60
0.8	40- 50
0.9	30- 40
1.0	20- 30
1.5	10- 20
2.0	5- 10

### b) "CECOCO" HAMMER CRUSHER :

This is widely used for grinding minerals, rocks, fertilizer, food and fibres, etc. in coarse or medium grinding up to 1mm or 50 mesh size.

The material is to be pulverized by many hammers placed around the interior main shaft for a high-speed revolving, and the powdered product is which being collected through the interchangeable screen. (The screen can be replaced when the mesh is to be changed.)

The wearing parts are the hammer, screen, screen frame & lattice frame which are to be replaced and should be kept on hand.

"CeCoCo" Hammer Crusher

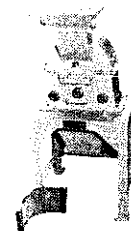

Specification of "CeCoCo" Hammer Crusher

Type	H.P. Req'd	R. P. M.	Nos. of Hammer	Capacity per hour	Net Weight	Gross Weight	Ship'g Meas't
No. 1	½-1	2500-4000	12	100- 150 kg	60 kg	85 kg	10 cft
No. 2	2-3	2000-3000	16	300- 400 kg	120 kg	160 kg	25 cft
No. 3	5-7.5	1600-2000	16	500-1000 kg	230 kg	280 kg	30 cft
No. 4	7½-10	1500-2000	16	1500-2000 kg	320 kg	390 kg	35 cft
No. 5	10-20	1100-1500	12	3000-4000 kg	480 kg	600 kg	45 cft
No. 6	15-30	900-1300	28	5,000 kg	730 kg	900 kg	50 cft

Remarks: Capacity, Horse Power and Revolution are varied according to material, hardness, dryness etc.

c) "CECOCO" ATOMIZER (HIGH SPEED HAMMER MILL):

12 to 48 beaters are fixed around the rotor which rotates at high speed (6,000 to 10,000 r.p.m.). Every beater has tip on its extreme end which is made of hard alloyed materials.

The axis of rotor is supported at both sides by high speed bearings which run in the chamber filled with high speed lubricating oil. The ball case is totally enclosed.

After raw materials are fed into hopper, they are conducted towards mill chamber through screw feeder. In the mill chamber, materials supplied are beaten, cut, frictioned between beaters and lining plate or lining pieces and ultimately discharged through outlet screen.

Lining Plate is made of various kinds of material in accordance with the materials to be pulverized. Lining piece system, instead of lining plate, can also be provided, so that only the abraded parts could be replaced.

For main housing, either air or water cooling system, is supplied according to the user's desire.

The desired fineness of particles can be obtained by adjusting the speed of rotation of the main shaft, feeding quantity, clearance between hammer and lining plate, as well as number of hammers and radius of meshes of the outlet screen.

Machine is made of such materials as Stainless Steel, Forged Iron or Gun Metal, Brass if required according to your grinding purposes.

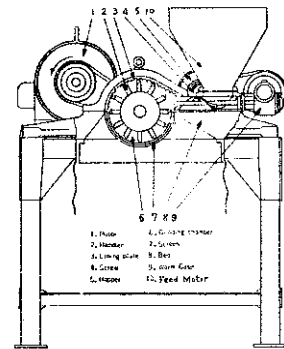

Specification of "CeCoCo" Atomizer

Type	Power Required		Capacity per hour	Floor Space	Height of Machine	Net Weight	Gross Weight	Ship'g Meas't
	Main	Feeder						
K	1HP	¼HP	various	75× 75 cm	90 cm	150 kg	210 kg	40 cft
E	5-7½HP	¼HP	various	100×100 cm	150 cm	450 kg	550 kg	95 cft
U	10HP	½HP	various	125×125 cm	170 cm	600 kg	750 kg	120 cft
C	15-20HP	½HP	various	150×200 cm	170 cm	800 kg	1000 kg	150 cft

Remarks: The material of lining-plate are nickel chrome steel for standard type, manganese steel, molybdenum steel, tungsten carbide, sinterkorund etc. for special type.

d) FOR INQUIRY OF THE PULVERIZING-GRINDING MACHINES:

Please let us have the following information in details in order to enable us to offer the machine best suiting to your requirements:

1. Designation of the material intended for grinding. (kind, size and condition as dry, wet, moist, greasy, etc.)
2. Desired particle size of product. (required degree of fineness and mesh.)
3. Desired capacity per hour, in kg.
4. Product uses.
5. Hardness (Mohs hardness) and Maximum size of original material.
6. Other physical properties i. e. density, melting point, decomposing point, softening temperature, bulk density, other pertinent datas which will help to produce a more comprehensive report.
7. Send us 10-50kg. sample for our research work if possible.

## “CECOCO” CONCRETE BLOCK MAKING MACHINE :

This machine is used for producing the ordinary block, colour face block, screen wall block and colour face brick by a machine interchanging the moulding box and pallet.

The coloured blocks are ideal for bathrooms, flooring, walls, ceilings, and decorative features.

Concrete Block Making Unit,  
combined with Pan Mixer and Skip Hoist

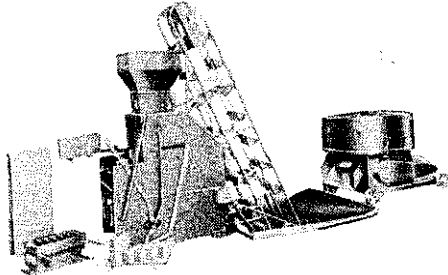

Concrete Block Making Machine  
Type No. 108

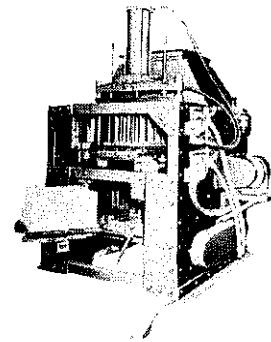

Specification of “CeCoCo” Concrete Block Making Machine

Type	Power Req'd	Capacity per day in pieces				Dimension in mm			Net Weight	Gross Weight	Ship'g Meas't
		Bldg. Block	Color Block	Screen Block	Color Brick	Height	Width	Length			
108	11 HP	3,000	—	—	—	2,100	1,360	1,650	1100 kg	1400 kg	215 cft
No. 9	4 HP	2,000	500	1,000	1,200	1,630	1,050	1,350	800 kg	950 kg	140 cft
No. 7	2 HP	1,500	400	800	1,000	1,450	1,050	1,350	600 kg	800 kg	80 cft
No. 8	1 HP	1,000	300	500	1,800	1,030	1,000	900	400 kg	550 kg	60 cft

Remark: Type No. 108 for exclusive building blocks, Equipped with 2 sets of 3 HP motor and 5 HP Air Compressor. Production Capacity is varies according to size and design of products.

## “CECOCO” CONCRETE BRICK MAKING MACHINE TYPE NO. 4 :

Place the board-receptacle on the machine-board-receptacle-bed and pull the handle to the left. The board-receptacle and the machine-receptacle will stick closely to the lower part of the moulding frame.

Next, put a measureful material prepared into the funnel, pull out the handle of the measure as far as it passes over the upper part of the moulding frame, and at the same time step the pedal on the front lower part.

After 5 seconds of vibration, step off the pedala and place back the frame to the original position, and press the handle on the right, and step the pedal again on the front lower part and let vibration go on for 2-3 seconds to finish up the upper part of the tile. Thus accomplish the product.

Return the handle on the left to its original position and the product will be pulled out at the lower part of the machine. The time required for production is 7-8 seconds for 5 bricks at a time.

Specification: Vibration 5,400 per minute, Dimension 1500×850×1000 mm, Power Required 1 HP, Net Weight 300 kg., Gross Weight 400 kg., Meas't 60 cft.

## “CECOCO” CHALK MOULDING MACHINE

**Construction :** Base is made of Cast Iron. Cylinder and moulds are made of thick brass plate. Pistons are moved up and down by turning pushing handle to push chawks out. The upper part of machine rotates 90 degree.

**Operation :** Wipe the inside of moulds with oiled brush. Pour material into cylinder and sweep the surface of cylinder with a plate of tin or board.

Material in moulds solidifies 10-15 minutes later. Then, rotate the upper part of machine, turn pushing handle, and chawks are pushed into chalk receiving frames. Pull frames out one by one, and put chawks on drying shelf without using hand. Either heat drying or air drying will do. All manual operation.

**Materials to be used :** Calcined Cypsum (CaSO<sub>4</sub>, ½H<sub>2</sub>O) and Water 50%

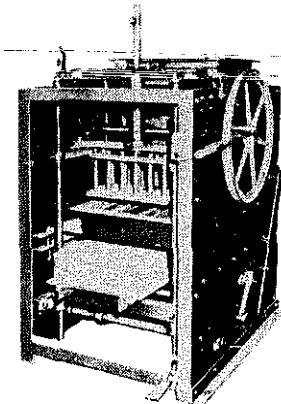

“CeCoCo” Chalk Moulding Machine

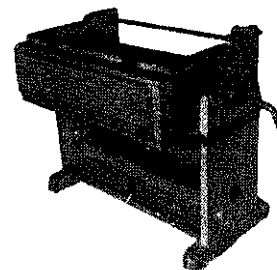

to 50% Prepare material for one time pouring. Material should be poured ½ minute after preparation when it gets sticky a little.

**Important:** It is a quality of gypsum that it heats (40°) when it gets solid. Volume then expands. It is therefore very important to push chucks out at a little premature time, otherwise they can hardly be pushed out.

If you miss the right time to push, you will find that chucks cannot be pushed out, and you should break up pistons and get rid of chucks one by one. Gypsum once used is not reclaimable and cannot be used again.

**Capacity:** 42 moulds × 12 rows × 4 operation × 90% efficiency — approx. 1,800 pcs. per hour.

**Oiling:** Wipe the inside of moulds often with brush oiled (animal oil 50% and mineral oil 50%).

**Size of Chalk:** 78mm length × 9mmφ tip × 11.5mmφ base and 5.6 grams per piece.

**Dimension of Machine:** 90cm height × 54cm width × 93cm length.

**Packing for export:** Net Weight.....150 kg.; Gross Weight.....220kg.; Meas't.....32 cft.

**Note:** One operator can take care of 3 to 6 machines, not including preparation of material.

### “CECOCO” MANUAL TYPE CANDLE MOULDING MACHINE

**Construction:** Base and Gear Supporting Poles are made of malleable cast iron. Bobbin stand is made of hard wood. Moulds are made of thick tin plate and covered with brass plate so that water for codling may not rust them.

**Operation:** Wicks start from Wick Bobbins and are led through Pressing Boards to Piston and Moulds, and the ends of wicks are pulled out of the tips of Moulds an inch or so. Cooling water must always be flowing among Moulds. Pour melted paraffin into moulds. Push up pistons by turning handle after a certain time elapsed, and candles are pushed out of moulds. Candles are fastened with Chucks and pushed out entirely by turning Lifting Handle. This is one operation, and it should be repeated. Capacity varies according to size of candle. One operator can take care of 3 machines.

**Materials:** Paraffin.....95%-98% ; Stearine.....2%-5% ; Wick .....varies according to size of candle

**Cooling Water:** About 12 cubic meter a day for one machine. Water of 17°-18°C is very suitable.

**Melting Pots:** One paraffin pot for melting paraffin to 60°-70°C.

One paraffin pot is for heating the melted paraffin further to 120°-130°C approx.

One Paraffin storage tank made of aluminium for keeping 60°-70°C paraffin constantly.

**Model of Machine and Capacity:** Use one machine or a model for manufacturing one specific size and shape only therefore please specify your desired size and shape of candle.

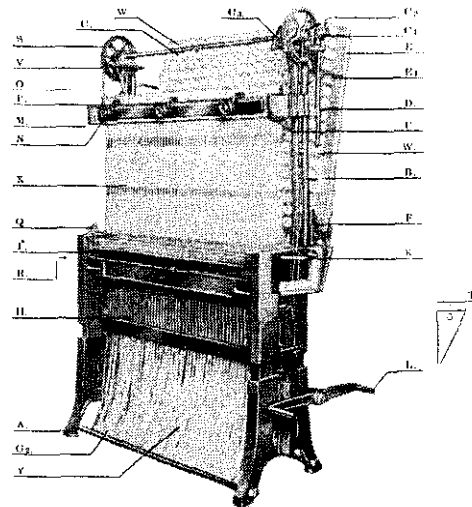

### “CECOCO” WOODEN TOOTH-PICK, ICE CREAM SPOON & STICK MAKING MACHINES

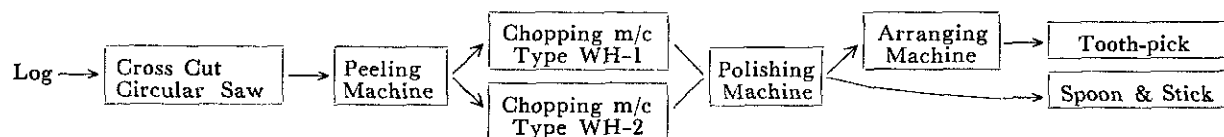

- Cross Cut Circular Saw Type WS-1;** This machine is to cut log cross-wise by movement of circular saw into a certain length. The best material is the white birch tree, but pine and cypress can be used.
- Peeling Machine Type WP-2:** After barked-off the boiled log by the hand knife, put it on the table of planing equipment and hollowing, splitting and peeling into band-form-strips by the knives. The thickness of band-form-strips can be adjusted into the required size by exchanging the gears at extra cost.
- Chopping Machine Type WH-1 for Tooth-pick:** This machine is used for chopping out the tooth-pick. Put the three-piles band-form-strips on holder, and fed to the machine by rollers, then stamp-out by a chopping knife that moves up and down.
- Chopping Machine Type WH-2 for Stick or Spoon:** A band-form-strip fed to the machine by rollers, and then stamp-out by a chopping knife at successive operation. Ice-cream spoon or ice-candy sticks can be made by interchanging the chopping knife.

- e) Polishing Machine Type WB-1: This machine is designed for Polishing and attaining the lustrous finished tooth-pick, spoon or sticks.
- f) Arranging Machine Type WA-1: This machine is used for assorting the tooth-picks.
- g) Grinder Type WG-2: This machine is used for setting and sharpening the knives.

"CeCoCo" Peeling Machine



"CeCoCo" Chopping Machine  
Type WH-1 for tooth-pick      Type WH-2 for Spoon and Stick

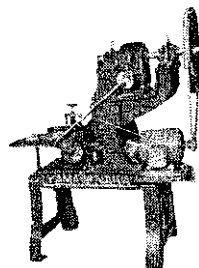
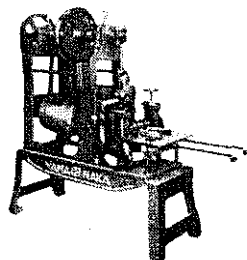

"CeCoCo" Polishing Machine

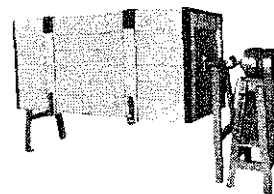

Specification of "CeCoCo" Wooden Tooth-Pick, Ice Cream Spoon & Stick ding Machines

Type	Power Req'd	R.P.M.	Capacity	Dimension in mm			Weight in kg		Cft
				H	W	L	Net	Gross	
WS -1	5HP	800-900	Dia. of Blade 1070mm	2800	1333	1100	450	600	110
WP -2	3HP	70	Peeling Width max. 320mm	1010	2400	2800	950	1,200	140
WH-1	¼HP	800	240,000 pcs. in 3-plyed per hour	915	355	863	160	220	20
WH-2	½HP	200-250	24,000-45,000 pcs. in a ply/hour	1270	535	1098	250	330	40
WB -1	1HP	30-40	54cft., wooden made barrel	1780	1275	2720	440	600	170
WA-1	1HP		115kg. of tooth-pick per hour	1400	1320	1980	700	900	170
WG-2	1HP	200	Grinding Wheel 764×127mm	815	915	1098	310	400	75

#### "CECOCO" SHELF TYPE VENTILATORY DRYER

Application :- All kinds of vegetables, and grains, such as mushroom (shiitake), medicinal grass and root, sliced potato, sweet potato, shrimp, various seeds and beans, etc.

#### Specification :

Size of Shelf: -95cm×180cm×8-stages

Power Required: -1/4H.P.-1/2H.P.

Fuel to be used: -Lamp oil (kerosene oil)

Capacity: -depending upon material, moisture contents, etc.

Net Weight: -155kg. complete Blower, Oil Furnace & Shelves

Gross Weight for export: -225kg.; Shipping Meas't: -85 cft

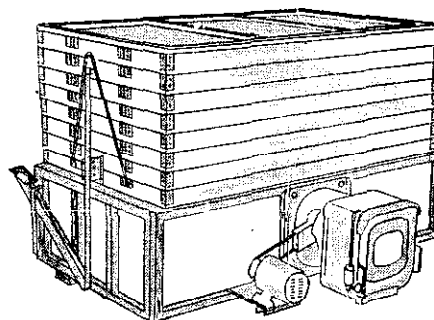

#### "CECOCO" PAPER BAND (FOR PACKING) MAKING MACHINE

1. Rewinding Machine Model AW-2: This machine is used for rewinding rolled kraft paper (approx. 700mm dia., 6,000 meter length, 1,000-1,200mm width, 200kgs. weight, type 33-38 gm per square cm.) into small roll (approx. 150-180mm outer dia., 30mm inner dia., 1,000-1,200mm width, 1,200 meter length).  
Daily Capacity is approx. 50,000 to 80,000 meter per 8 hours
2. Cutting Machine Model AC-2: This machine is used for cutting small roll rewinded by Rewinding machine into narrow width tapes (approx. 20mm width × 150 mm outer dia.) which are to be twisted by twisting machine.
3. Twisting Machine Model BT-2: This machine is used for making kraft string by twisting from small tapes cut by cutting machine. Size of paper string, diameter of string, are adjustable by changing width of tapes, gears and porcelain nozzle. 20 spindles type at a operation.
4. Paper Band Making Machine Model BD-2: This machine is used for starching, fixing drying paper strings which are to be made into paper band. The number of paper strings to be starched is 2-20. Steam Heating system.
5. Winding Machine Model AEW-1: This machine is used for winding up paper band. The standard length of coil is about 1,000 meter.
6. Glue Mixing Pan: This machine is used for mixing polyvinyl alcohol as starch for paper band. Steam Heating System.
7. Steam Boiler Model 'SVC': The heating source for paper band making machine and glue mixing pan.

## "CECOCO" PAPER BOX MAKING MACHINE

### A) WIRE-STITCHED BOX :

1. **Hand Shear** This machine cut paper (straw, white, brown or chip board) to the required size.
2. **Rotary Scoring & Bending Machine** This machine is used for bending (or scoring) the cut paper.
3. **Rotary Cutting & Bending (Scoring) Machine** In Model No. 60, the inserted paper is at first cut into 7 pcs. and each cut sheet is bent by two pairs of bending tools set in between the width of cut sheet. In Model No. 61, the paper is at first scored and after that cut into desired sheets. (Bending tool cannot be applicable.)
4. **Corner Cutting Machine** ... These machines are provided to corner the sheet of board which has previously been creased and cut. The blade forms (A- plain cut), (B & C- wrapping cut) and (D- slot). Originally, one machine for one cutting form is ideal and preferable, but upon request the machine for combined use among (A), (B) & (C) being equipped with interchangeable blades can be arranged, when extra charge is paid, but with others (D) is impossible.
5. **Wire Stitching Machine** The corners of a box which have previously been cut or slotted are now erected and stitched on this machine instead of being glued.

Hand Shear No. 66-1

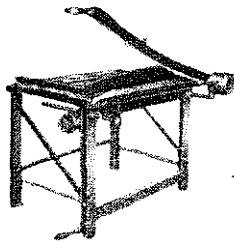

Rotary Cutting & Bending Machine No. 60

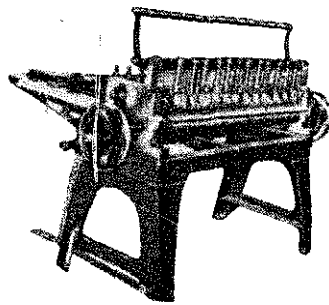

Corner Cutting Machine No. 63



Straight Wire Stitcher No. 67 A-1



In processing the card-board, card-board cutting, scoring or bending, corner cutting and wire stitching machines are used.

a) Straight stitched usual card-board boxes for tumblers, toys, chinawares, and other small articles.

Process- Cutting into the required size

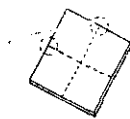

Required Machines Model 66-1 or Model 60

Bend-lining

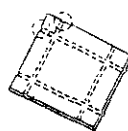

Model 58-2 or Model 60

Wrap-form corner cutting

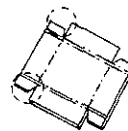

Model 63-C or Model 64-MC

Straight corner stitching

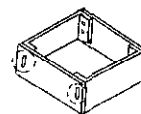

Model 67-1 or Model 67A-1

b) Corner stitched fancy boxes like souvenir boxes, candy boxes, sandal or shoe boxes, etc.

Process- Cutting into the required size

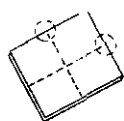

Required Machines Model 66-1 or Model 61

Scored-lines

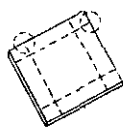

Model 58-2 or Model 61

Plain-form corner cutting

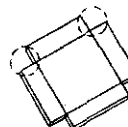

Model 63-A or Model 64-MA

Bent corner stitching

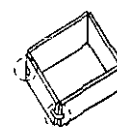

Model 66

Specification of "CeCoCo" Wire-Stitched Box Making Machine

Model	Name of Machine	Power Req'd	Work Size	Capacity per day	Net Weight	Gross Weight	Ship'g Meas't
66-1	Hand Shear	Hand	42" width	5,000	190 kg	250 kg	80 cft
58-2	Rotary Scoring & Bending m/c	Treadle	42" width	5,000	240 kg	350 kg	70 cft
63	Corner Cutting machine	Treadle	4¾" depth	2,000	80 kg	140 kg	35 cft
67-1	Straight Wire Stitching m/c	Treadle	14" arm	4,000	100 kg	170 kg	36 cft
66	Corner Wire Stitching machine	Treadle	12" arm	4,000	100 kg	170 kg	36 cft
60	Rotary Cutting & Bending m/c	½HP	50" width	20,000	900 kg	1130 kg	150 cft
61	Rotary Scoring & Cutting m/c	½HP	50" width	20,000	900 kg	1130 kg	150 cft
64-M	Corner Cutting machine	¼HP	4¾" depth	2,000	200 kg	280 kg	24 cft
67A-1	Straight Wire Stitching m/c	¼HP	14" arm	8,000	140 kg	220 kg	40 cft

B) CORRUGATED PAPER BOX: Corrugated-board boxes fall into an entirely new category of packing boxes. Light weight, strong, and economical corrugated-board boxes are now fast replacing other packing materials. It is significant that some fifteen corrugated-board boxes can be produced out of the pulp equivalent to a wooden box. It is said that paper consumption parallels the nation's culture, and the higher living standards stimulate the higher paper consumption ratio.

A standard regular slotted type being most widely used as a general packing corrugated-board box, usually printed outside.

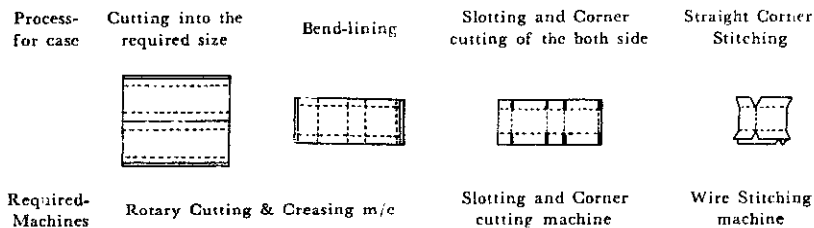

Specification of "CeCoCo" Corrugated Carton Box Making Machine

i) Rotary Cutting & Creasing Machine cuts the corrugated board to specified size and crease it as specified.

Model	Working Width	Power	N. Weight	G. Weight	Meas't
609	60" (1,525 mm)	1HP	1200 kg	1500 kg	90 cft
610	72" (1,830 mm)	1HP	2000 kg	2230 kg	110 cft
611	84" (2,135 mm)	2HP	2200 kg	2500 kg	125 cft

ii) Corrugated Paper Printing Press is used printing on the corrugated board cut to specified size.

Model	Maximum Paper Size	Printable Size Max.	No. of Color	Power Req'd	Capacity per minute	Net Weight
CP-1	56" x 72"	47" x 72"	One	2HP	16-64sheet	4500kg
CP-2	56" x 72"	47" x 72"	Two	3HP	adjustable	6000kg

iii) Rotary Slitting, Creasing, Slotting and Corner Cutting Machine are used to slot the printed corrugated board as specified, forming a finished product in an open state.

Model	Max. Size of Paper	Slotting Depth	Slitting Width	Power Req'd	Capacity per minute	Net Weight
M-200	54" x 83"	Max. 14"	Max. 6½"	3HP	50-80 sheet	4500kg

iv) Wire Stitching Machine: The slotted corrugate board is then wire stitched to form a complete finished corrugated board Box.

Model	Arm Length	Power	Stitch	N. Weight	G. Weight	Meas't
607	36" ( 915 mm)	¼HP	doudle	490 kg	660 kg	85 cft
608	48" (1,219 mm)	¼HP	double	550 kg	760 kg	106 cft

## "CECOCO" FULLY AUTOMATIC ROTARY PAPER BAG MAKING MACHINE

This machine is comprised of the Paper roll stand, Guide roller, Pasting part, Tube forming part, Cutting part, Bottom pasting part, Stacking & Counting device and Speed control device, etc.

This machine produces paper bag of flat of Japanese gusset type having flat bottom fully automatically and directly from the rolled paper, which is folded, cut, pasted and the finished bags are stacked by every 50-100 bags through a drum delivery system. This machine can be operated in conjunction with the Anilin Printing press which is being offered by "CeCoCo".

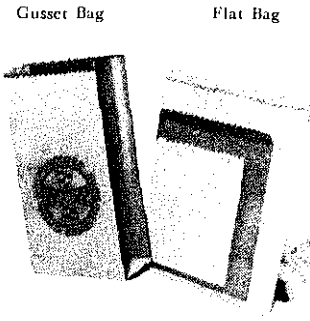
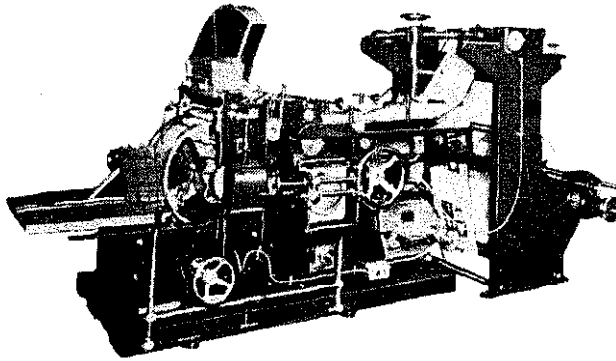

Specification of "CeCoCo" Fully Automatic Rotary Paper Bag Making Machine

Model	Size of Bag to be made		Power Req'd	Power Req'd with Print	Size of Paper Roll installed	Net Weight	Gross Weight	Ship'g Meas't
	Minimum m/m	Maximum m/m						
FR-1	75W × 120L	260W × 365L	2HP	3HP	800φ × 700mmW	2000 kg	2300 kg	320 cft
FR-2	100W × 200L	365W × 455L	3HP	5HP	800φ × 900mmW	2500 kg	2900 kg	480 cft
FR-3	60W × 90L	130W × 190L	1HP	2HP	800φ × 500mmW	1500 kg	1700 kg	180 cft

Remarks: There are some differences in capacity of production depending upon the size and the quality of paper. The size of bag can produce different by interchanging the change gear for length and forming plate for width.

## "CECOCO" TWO-COLOUR ANILIN PRINTING PRESS

Suit to Fully Automatic Rotary Paper Bag Making Machine.

"CeCoCo" Two-color Anilin Printing Press prints the rolled paper with the Rubber Printing Blocks and Anilin Printing Ink, and it is used for general printing purposes. This machine is also geared with "CeCoCo" Fully Automatic Rotary Paper Bag Machine as its Printing Press. Model FPA-1 is used with FR-1 type machine and FPA-2 is with FR-2 or FR-3 Type machine.

As printing of two colors is performed on the same Press Roll, the color matching of two colors is assured. The Infra-Red Drying component of 1KW is installed to enable to operate the machine under all conditions.

The Rubber Printing Blocks are fitted on the Basic Steel Printing Cylinder with both sides adhesive film. The diameter of the printing cylinder must be selected in accordance with the printing size, but the design of print is changed simply by replacing the Rubber Printing Block on the Basic Cylinder.

Specification of "CeCoCo" Two-color Anilin Printing Press

Model	Max. Printing Size	Dia. of Press Roll	Power Req'd	Printing Speed per minute	Net Weight	Gross Weight	Ship'g Meas't
FPA-1	500mmW × 730mmL	240 mm	1HP	40-60 meter	1800 kg	2000 kg	280 cft
FPA-2	630mmW × 860mmL	240 mm	2HP	40-60 meter	1900 kg	2100 kg	320 cft



## "CECOCO" SEAL & LABEL PRINTING PRESS

Model SD-B

Elaborate artificial Seals and Labels can be printed, embossed and punched out by this machine, viz. first printing, second embossing and third punching out are done successively in one combined operation automatically.

It is the three kinds of One, Two and Three colour. And it has the upper and lower chase of two planes. Setting the different forme on these chases, putting the different-coloured ink into each ink-box, and beginning to run it, it can produce continuously the beautiful multi-coloured print by operating each rubber roller. Three process of printing, embossing and punching are done concurrently. Its subject is a vertical motion of the forme chase bed and the special rubber belt, and they make a perfect from 45 to 80 turns per minute with the speed control arrangement. Responding to increased demand on self-adhesive label awaked all over the world, "CeCoCo" Seal & Label Printing, Embossing & Punching Machine Model Nos. SD-A, SD-B and SD-D are especially designed to have Rewinding attachment and to get perfect cut of self-adhesive label. Slitting Machine Model SD-83 will be coupled to the presses for production of self-adhesive labels in reels upon request. The stripping and rewinding unit (intermittent motion) with disc cutter gurantees perfect slitting in hairline registration.

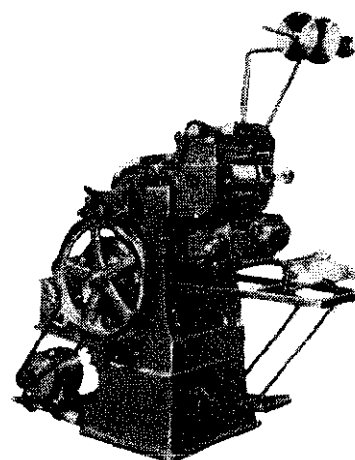

### Specification of "CeCoCo" Seal & Label Printing Press

Model	Color	Max. Width of Paper	Printable Size mm	Capacity per minute	Power Req'd	Dimension in mm			Weight in kg		Ship'g Meas't
						H	W	L	Net	Grost	
SD-A	One	6 $\frac{1}{16}$ " 170 mm	170×150	80-90 rpm	$\frac{1}{2}$ HP	1780	900	1145	1000	1100	110 cft
SD-B	Two	6 $\frac{1}{2}$ " 195 mm	195×90	80-90 rpm	$\frac{1}{2}$ HP	1800	900	1160	1350	1450	115 cft
SD-D	Three	9" 230 mm	230×110	30-90 rpm	1HP	1800	1750	950	3000	3200	150 cft

## "CeCoCo" PAPER STRING MAKING MACHINE

This machine is used for making one ply paper string by twisting 2-5 pcs. of coiled paper tapes and to 8mm dia. of string is produced depending upon the width and numbers of paper tape.

### Specification of "CeCoCo" Paper String Making Machine

Dimension of Machine .....	83cmL×55cmW×91cmH		
Power Required .....	1/8HP		
Revolution .....	300RPM		
Diameter of String .....	2 to 8mm, depending upon width and set number of paper tape.		
Material to be used.....	coiled paper tape		
Capacity .....	3 to 4 kg. in 3mmφ per hour		
Net Weight.....60kg	Gross Weight.....90kg;	Meas't.....20cft	

"CeCoCo" Paper String Making Machine

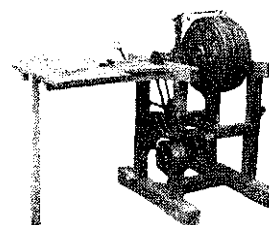

## THE FORD FOUNDATION

7, Sharia Latin America,  
Garden City, Cairo, U.A.R.

November 10, 1965

I am connected with the Assewan development project and my area of responsibility and interest is industrial development. We are making studies relating both to large and small industries, and your equipment might make possible the establishment of many small industries on a much more efficient and rapid basis.

Thanks for your cooperation in this matter. The concept of your line of products sound wonderful to me, and I look forward to working with you.

Sincerely,

- Signed -

John A. Ritchey  
Senior Consultant  
Asswan Industrial Development Center

## "CECOCO" FILTRAMATIC HOME WATER CONDITIONER

for drinking water, coffee, tea, cooking, aquariums, hygiene and beauty care

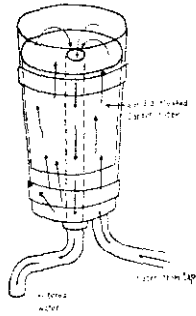

The municipal waterworks use alum, ferrous sulphate, lime or chlorine to purify and disinfect the water supply. This imparts a disagreeable taste and odor to your tap water which, under certain conditions, are strong enough to be utterly objectionable. For people who appreciate the clean, pure taste of their drinks, coffee or tea, this situation is the cause of constant aggravation. The new Filtramic Home Water Conditioner is the perfect answer to this problem. This easily installed, non-electric device incorporates a fine activated carbon filter and will remove all undesirable dissolved substances in the water which are the cause of the unpleasant taste and odor. All disease causing organisms, such as bacteria, are also caught in the filter. The result is a clean tasting, healthy kind of drinking water obtained.

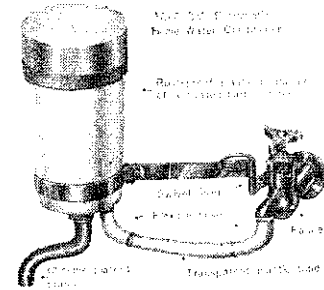

The Filtramic Home Water Conditioner is a new, inexpensive home appliance which should be a necessity in every home. You tap water can be instantly filtered into clean tasting, hygienic drinking water by simply attaching this handy device to the faucet. Attractively designed in two-tone plastic and chrome, the Filtramic measures only 5½ inches high and 3 inches in diameter and can be installed easily in a minutes. The solid, neutral (PH 6.5) activated carbon filter, made of specially processed, refined coconut shell carbon will be effective for approximately 100 days of normal daily use. Spare filters are available.

## "CECOCO" PORTABLE SACK AND BAG CLOSING-SEAMING MACHINE

- \* Portable, Durable, Handy Operation!
- \* The highest efficiency and the lowest price in the world!
- \* Instant seaming jute, multi-wall paper, cotton bags and waterproof bags for feed, grain, fertilizer, chemicals, flour, cement, sugar, coffee, salt, beans, rice, plaster, seed, powder paste, etc.
- \* Cutting down cost of packing and production!

Closes 280 bags per hour:

For any kind bags that is multiplied paper bags, waterproof bags, jute and cotton bags, etc., this machine closes 280 bags per hour in average speed extremely easy, and is guaranteed no damage and no mechanical trouble.

Adjusts speed freely with the transformer:

High capacity electrical transformer is furnished for each machine with which the operator can adjust speed of machine freely in accordance with the condition of the packing work, and furthermore this transformer will keep efficiency of the machine by dropping of electrical pressure giving no trouble at all.

Furnishes with installation for soft cotton yarn:

For damp-proof, fine-grain and liquid materials, this machine entitle with the peculiar installation for soft cotton yarn which completely fill-up the needle holes without changing parts of machine.

"CeCoCo" Portable Sack and Bag Closing-Seaming Machine

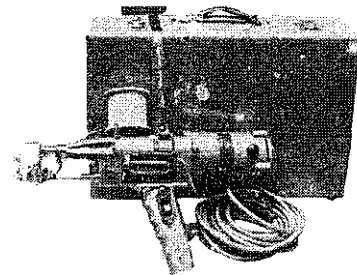

Specification ;

Net Weight.....3.4 kg.  
 Current Source..... Single-phase,  
 100/110 V, or 200/220V  
 Motor..... 1/12HP, 8,500 RPM  
 Thread to be used..... Ramie, flax,  
 cotton & chemical  
 Gross Weight..... 12.0 kg.  
 Ship'g Meas't..... 2 cft.

## "CECOCO" PORTABLE CIRCULAR CUTTING SAW

Specification of "CeCoCo" Portable Circular Cutting Saw

Type	Bed	Clutch	Dimension	Dia. of Blade	Cut Dia.	Power Req'd	RPM	Dia. of Pulley	Weight
A	Steel	with	Height- 850mm	405mm	max. 180 mm of log	3-5HP	1400 to 1600	3½"	25kg
B	Wood	with	Width- 350mm						25kg
E	Wood	without	Length- 850mm						22kg

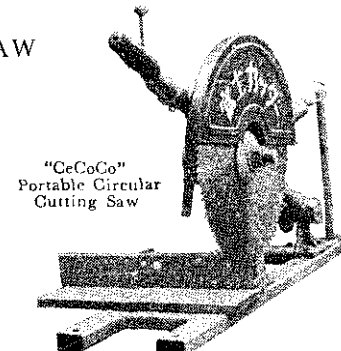

## "CECOCO" MAN-POWER MOTIVE UNIT, TREADLE TYPE UTILIZE YOUR MAN-POWER FOR ROUTINE WORKS PORTABLE

"CeCoCo" MAN-POWER MOTIVE UNIT can be used as motive power in place of small Electric Motor and Engine and it can also be used handy on mounting.

Operation is very easy without any trouble. It is very convenient and appreciable to use where an electricity is unaccessible.

Oilless Metals and Ball Bearings are adapted for all moving parts of this unit, so that the trouble for oiling is eliminated at least for a year.

Type "TM-1" for 1 man

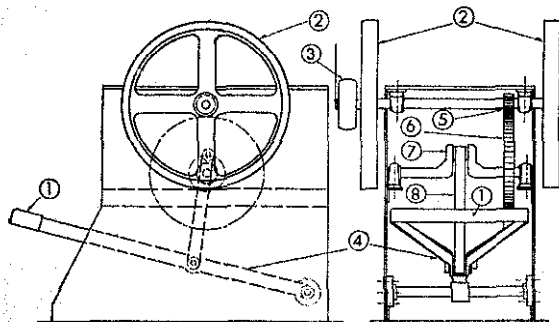

Type "MT-2" for 2 men

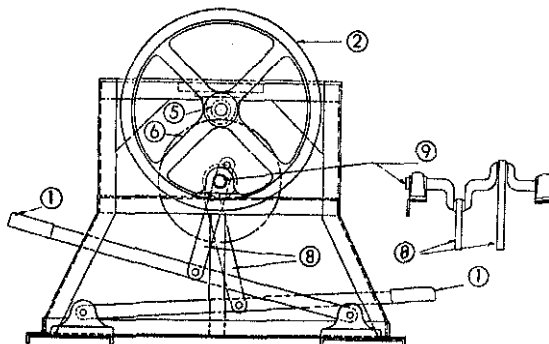

Names of Parts: 1. Treadle Plate      2. Fly Wheel      3. Pulley      4. Treadle Lever      5. Small Gear  
6. Large Gear      7. Crank      8. Crank Rod      9. Crank Shaft      10. Pedal Shaft

### Specification of "CeCoCo" Man-Power Motive Unit

Type	Revolution at 2 steps per second			Horse Power	Dimension in mm			Gross Weight	Ship'g Meas't	
	Gear Ratio: 1 : 4    1 : 5    1 : 6				H.	W.	L.			
TM-1	Approx.	500 rpm	600 rpm	720rpm	up-to 2 H.P.	736 mm	560 mm	760 mm	140 kg	16 cft.
TM-2		500 rpm	600 rpm	720rpm		up-to 3 H.P.	736 mm	600 mm	860 mm	160 kg

### "CECOCO" BUCKET BARROW

All steel made, light weight, designed for construction, agricultural and home use. The "CeCoCo" Bucket Barrow can be assembled and collapsible to make them compact for reducing ocean freight charge and for easy-handling, so they are a most fitable for hauling merchandise for long-distance.

Specification:— Dimension 1,460mm length × 680mm width × 511mm height; Bucket size 680mm × 600mm × 750mm on top and 420mm × 390mm × 350mm on bottom, 19 gauge plate; Wheel 13 × 5 pneumatic rubber type with oilless bearing.

"CeCoCo" Barrow



### LUMBER INDUSTRY - SMALL & MEDIUM SCALE SAW MILLS

In Japan, not only in city but also in every town and village especially in the rural districts, you will be surprised to find a small scale of saw mill which is enjoying a lucrative business.

In view of the fact that when a small scale saw mill is established near to the place where the wood or log can easily be carried out, the log is processed very easy and instantly into lumber in any desired sizes. It will considerably eliminate transportation expenses, handling charges and labour in turning out the finished products of lumber of high value with unlimited market, essential for house building and furniture.

"CECOCO" is very much anxious to help encourage in establishing any desired plants of small and medium scale of saw mills and will be pleased to submit a plan and make an estimation upon receipt of detailed informations stating the kinds and sizes of wood, volume of supply, source of motive power available.

"CeCoCo" Electric or  
Engine Chain Saw

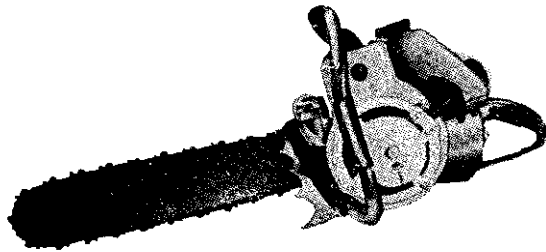

"CeCoCo" Table  
Band Saw Mill

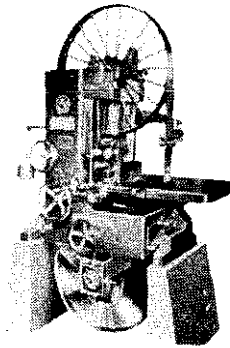

"CeCoCo" Universal  
Woodworker, 8 in one

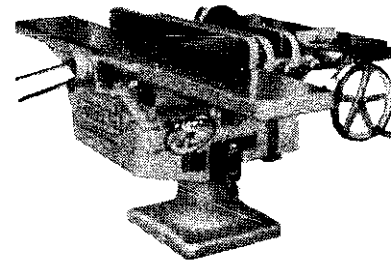

## COTTAGE INDUSTRY AND MECHANICAL TRAINING

The world over famous 'Yanmar' diesel engines are built at their NAGAHAMA plant at the northern tip of the famous Lake Biwa, Japan and in its neighbouring green surrounding village with healthy fresh air, there is ISHIMICHI village where many cottages, shown in the pictures, are built to plane roughly the various small, not too much complicated parts of the engine.

The said cottage machine shop is built in the individual compound of farmers' yard by the noble, benevolent and respectable spirit of the late Mr. Magokichi Yamaoka, the founder of the great 'Yanmar' Diesel Engine of the world, not only for their own profits but also to stabilize and raise their standard of living about 20 years ago, because they were very poor at that time but they are now enjoying very moderate living with a deep thanks to him.

The rough plane work is performed by the farmer's wife in day time and night also by husband and other members of family at their leisure time and every family is earning ¥15,000- to ¥25,000- (about \$40 to \$60) per month which help them a great deal financially.

It is specially noted that they need not pay any fare to reach the factory thus losing no valuable time while she can attend the housekeeping, cooking and caring for children. After a while not only she but also her husband together with their children unintentionally are accustomed by familiarizing with the machine, thus they are trained simultaneously becoming a skillful mechanics later.

One will wonder how their machines are kept clean and bright, thus help prolong the life of machines and tools used and prevent the repairing and break-down.

Consequently, "CEGOCO" strongly recommend you to adapt such cottage industrial system in your country to develop and encourage your mechanical cottage industry to benefit your farmers and further to train your young folks fundamentally. "CeCoCo" are pleased to guide you to the above place for your further study when you come to Japan.

## OUTLINE OF MACHINE SHOP AND SUCCESSFUL RESULT

1. Size of Farmer's machine shop:- 12 ft.×12 ft. and 18 ft.×12 ft.
2. Equipment: Each of Drilling Machine, Grinding Machine, Milling Machine and Lathe which are specially made by 'Yanmar' to fit for the rough plane the parts of 'YANMAR' ENGINES, such as valve lever, valve-lever supporter, pushrod etc.
3. Degree of Processing: Of course they are not completely finished but only rough plane thereby they are delivered to the neighbouring mother plant of 'Yanmar' at Nagahama for final finishing precisely. The processing is very simple and easy requiring a short period of mechanical experience, so that the housewives and young folks can function satisfactorily. Indeed, this is the key-point of success of cottage industry.
4. Raw Material: All materials are furnished by the main factory of 'Yanmar' Foundry at Nagahama situated nearby just about 10 miles (16 km) in distance.
5. Before: ISHIMICHI VILLAGE was a remote and secluded place in the mountains and the farmers income was very small as each of the own only 0.5 acre (20 ares) of the arable land. Furthermore, in a winter season, as the snow is very heavy, there was no means to earn, therefore their living was exceedingly poor and miserable, of course, having no electricity for lightening electric lamp to enjoy modern living and night works.
6. After: Since after the introduction of the above ideal cottage industry by the noble, wise and far-sighted idea of the late Mr. Magokichi Yamaoka, the environments of the village became very bright and active. Because each of household has radio even television and bicycle and is now earning quite a pretty cash income to their great enjoy. Consequently, they have saved enough money not only in taking care of the education of their children but also for incidental expenses in case of matrimony and sickness, in addition to sizeable depositing funds with the Farmers Co-Operatives and Saving Banks.

general View of The Ishimichi Village, Japan

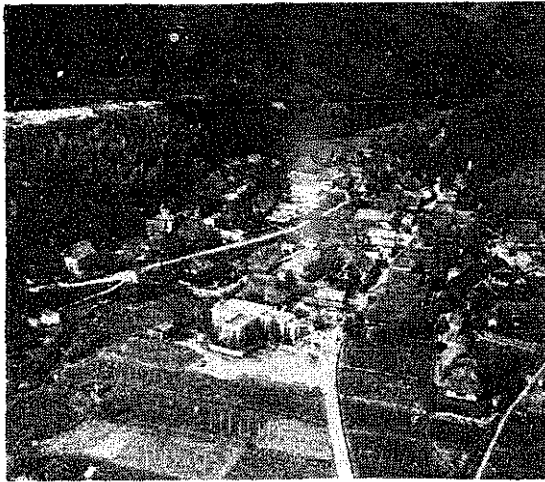

'Yanmar' Cottage Industrial  
Small MachineShop in Farmer's Compound

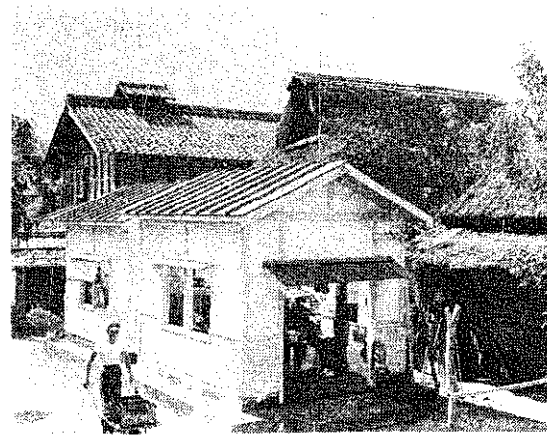

'Yanmar' Portable Diesel  
Generating Set 3KVA

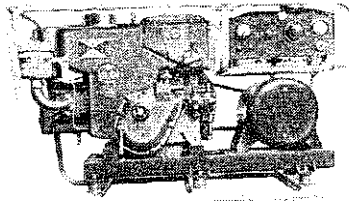

'Yanmar' Portable  
Diesel Welder 6KW

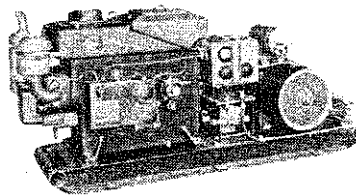

'Yanmar' Portable Self-Priming  
Diesel Pumping Set

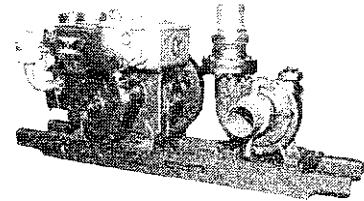

"CeCoCo" will be pleased to quote you above 'Yanmar' Diesel sets.

### MOST UNIQUE INVENTION IN DISPOSING USED CAR AS SCRAP

The current method of scrapping the used cars, even in the United States, is to press by a heavy power, and cut into pieces for melting as ingot. However, due to the fact that it contains not only iron-steel but also paint, glass, lead, aluminium, copper and wood; the scrap thus obtained is to be separated again into, at least, iron and non-ferrous metals before melting, which takes quite a trouble of labour and time causing the cost very high.

Mr. Kunitoshi Tezuka, President of Tezuka Kosan Co., Limited, Tokyo, in consideration that the imported used car scrap is not very popular to the iron manufactures in Japan where the scrap is very scarce but in a big demand, because such scrap is not pure as mentioned above, has patiently researched by spending millions of capitals for many years in the past, and finally has succeeded to overcome difficulties in inventing a most unique processing method for which he has entitled many patents in the key industrial countries in the world.

The plant is called "Barbecue Plant" and consists of Melting Furnace, Scrap Baling press and Guillotine Press and Shear. In each individual chamber, non-ferrous materials are burned and melted and accumulated separately by centrifugal forces; glass and lead by the heat of 400°C, aluminium part by 600°C, copper by 1,000°C and iron-steel by 1,600°C, and finally pressed as steel-sheet and sheared according to the requirements.

There is an immense advantages in utilizing this unique plant although it requires a big capital and is essential to install at least one plant in principal cities in the world, thus enterprises can enjoy good profit exclusively and permanently.

The unique feature of this particular plant is its processing method which is designed, when scrapping the old used car, to separate and dispose of individually the different substances such as paint, glass, lead, aluminium, copper and iron steel instead of merely crush it by pressing and produce as a so called "scrap", through the conventional method adapted in the States and other major countries in the world at present. This is the first time in the world that this unique method has been incorporated in disposing troublesome old used car turning into the 100 percent pure iron steel of a high value speedily and most economically.

1. It will burn out used automobile completely, leaving pure scrap iron and steel sheet, aluminium, copper and glass of a high quality intact.
2. The power of pressing is very small about one-tenth of current method because the subject is well annealed and can be disposed very easy and profitable.
3. Ordinarily 3 workmen are required in dismantling a car a day. By this method, same number of workers can easily handle 20 cars a day. For particulars write to "CeCoCo", P.O. Box 8, Ibaraki, Osaka-fu, Japan.

Revolutional Invention "CeCoCo" "Barbeque Plant"

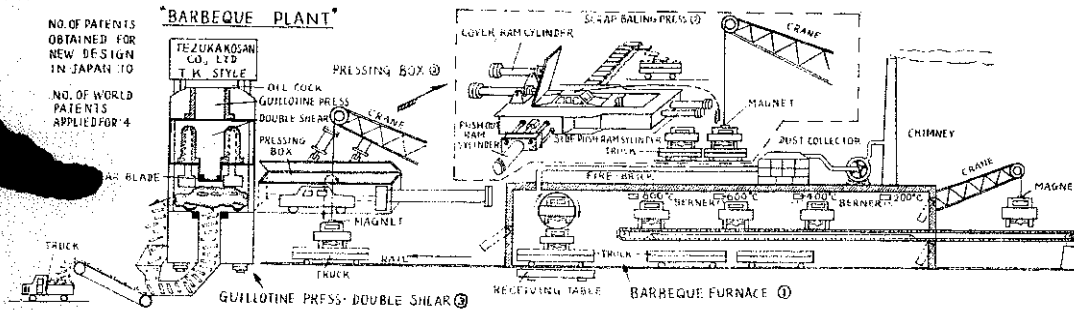

"CeCoCo" ELECTRIC MOSQUITO KILLER LAMP  
ADAPTED SPECIALLY MADE COLORED LAMP

Kill 100% mosquito. For productions of much more Milk, Egg and Meat by keeping away mosquitos out of the houses of Milk Cow, Poultry and Cattle.

Enjoy a pleasant living and sound sleeping. Promote a good health by adapting "CeCoCo" ELECTRIC MOSQUITO KILLER LAMP at Home, Hotel, Hospital, Beach House, Villa and Camp etc.

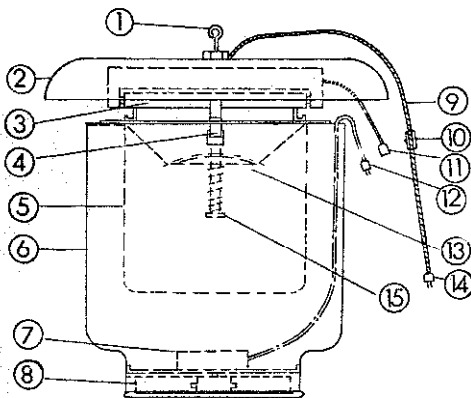

Names of Parts:

1. Hanging Eye-bolt
2. Cover
3. Special Colored Lamp 6-watt
4. Tightening Hook
5. Screen Catcher
6. Body Shell
7. Electric Motor 2-watt
8. Fan
9. Electric Cord
10. Intermediary Switch
11. Cord Connector
12. Motor Plug Cap
13. Escape Protecting Cap
14. Plug Cap to Electric Source
15. Cap Holder with Spring

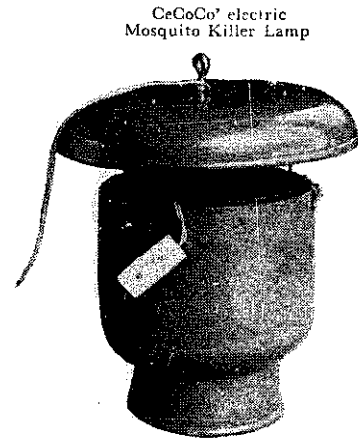

Operation :

1. "CeCoCo" ELECTRIC MOSQUITO KILLER LAMP can be used by hanging the Eye-bolt (1) and also as the Stand Type by using the special made Stand at extra cost.
2. Couple Motor Plug Cap (12) with Cord Connector (11) and connect Plug Cap (14) to the electric source.
3. Set Intermediary Switch (10) to the "ON". Colored Lamp (3) is lighted and Fan (8) is started.
4. Escape Protecting Cap (13) is pushed down by the vacuum force of Fan (8). Mosquitos are induced by the attraction of Special Colored Lamp (3) and caught and dropped down into Screen Catcher (5) by the vacuum operation of Fan (8).
5. When mosquitos are gathered in Screen Catcher (5) after passing a night, set Intermediary Switch (10) to the "OFF", thus, Escape Protecting Cap (13) will be closed by the spring force.
6. Take off Screen Catcher (5) from Body Shell (6) after loosing Tightening Hooks (4) and put Screen Catcher into the water for perishing mosquitos.
7. Wash out cleanly Screen Catcher (5) thoroughly for protecting Electric Motor (7) after washing it (5) by water.
8. Set Screen Catcher (5) into Body Shell (6) for preparing the next operation.

Specification of "CeCoCo" Electric Mosquito Killer Lamp

Type	Size of Screen Catcher	Overall dimension		Packed 6 sets in a case		
		Height	Diameter	Net Wt.	Gross Wt.	Ship'g Meas't
No. 1	16 cm dia. x 15 cmm depth	38 cm (15")	32 cm (12½")	@2.5 kg 15 kgs.	25 kgs.	10 cft.

Please inform us of the numbers of Cycle and Voltage required in Single-Phase when your inquiring us.

## QUESTIONARY

All Inquiries for Importing "CeCoCo" Machinery or Plant into Your Country:

1. Inquiry should be sent to us on your own letter-head.
2. Furnish us detailed informations when inquiring.

(1) GOVERNMENT LICENCE AND LETTER OF CREDIT:

1. Do you posses an Industrial Licence?
2. Do you posses Import Licence? If not, can you obtain it, when?
3. Can you establish an Irrevocable Letter of Credit in our favor?

(2) PARTICULARS OF THE DESIRED MAGHINERY or PLANT:

1. Description of the required machinery or plant. (mention in your inquiry the number of pages in this Booklet)
2. Desired production capacity (per hour or per day) or expected amount of your invesment to import machinery or plant.
3. Voltage, phase, current and frequency of electricity used for the machinery or plant.
4. Working hours per day.
5. Outline of project.

(3) PRODUCTS TO BE PROCESSED or MANUFACTURED:

1. Name and detailed specification (type, size, weight, shape, etc.)
2. For what purposes are these products required.
3. If possible, send us drawing, sketch, sample or picture of your products of meterials.

(4) KINDS RAW MATERIAL and components to be purchased in manufacturing or processing your products.

1. Name and Specification (type, size, weight, shape, specific gravity, analytical table, dryness, moisture content, etc.)
2. Send us drawing, sketch, sample or picture of materials.
3. Miscellaneous informations as much as possible.

(5) MISCELLANEOUS INFORMATION:

Temperature, Humidity, Water supply, Kind of motive power available at your side, etc.

(6) TECHNICIANS FROM ABROAD:

Any necessity for Japanese technicians to be dispatched for installation the machinry or plant and to impart knowledge for operation and training etc.

(7) YOUR BANK REFERENCE:

(8) YOUR SPECIAL WISHES, IF ANY:

(9) PLEASE ADDRESS: "CECOCO" CHUO BOEKI GOSHI KAICHA

Technical & Engineering Consultants. Established 1916 with 50 years of experimnts  
226 Shimohozumi, Ibaraki City, Osaka-Pref., JAPAN  
Cable Address:- "CECOCO" Ibaraki, Japan P.O. Box 8, Ibaraki City, Japan

(10) "CECOCO" MAINTAINS:

"CECOCO" EXHIBITION & DEMONSTRATION CENTER

Only one place in Japan, where agricultural and small scale, rural cottage and other various machineries and equipment are systematically displayed and demonstrated within an hour that you can save your valuable time to go arround all over Japan. Your visit is heartily with sincerity.



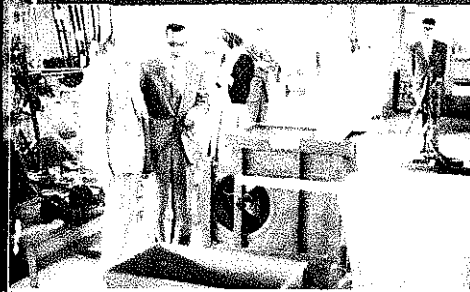

H.E. ECUADOR Ambassador Castavo Larrea is inspecting "CECOCO" Hand Grain Winnower Rice Huller and Separator.



H.E. B. Rachaiah, Minister of Forests, Fisheries & Sericulture, INDIA Mysore Government is inspecting "CECOCO" Poultry Equipments.

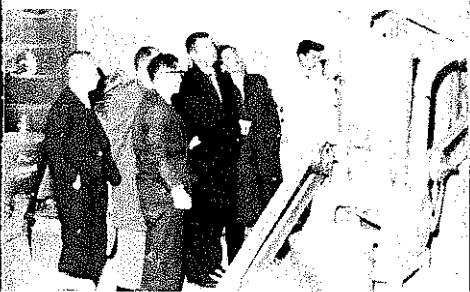

H.E. Mario Abdres Sol, EL SALVADOR Former Minister of Agriculture is inspecting "CECOCO" Rice Milling Unit.



Mr. A.K. del Rosario, Administrator, PHILIPPINE Coconut Administration is discussing "CECOCO" Coir Curled Rope Making Machine.

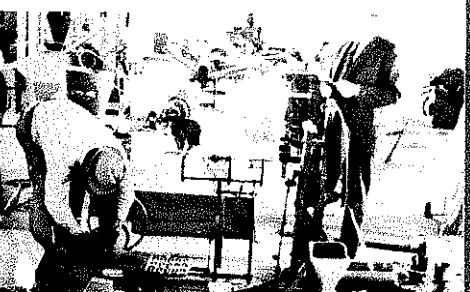

Mr. O.F. Wright, Director, Department of Agriculture, SARAWAK Government is inspecting "CECOCO" Flour Mill.

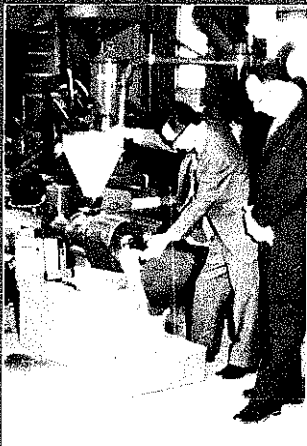

Dr. Max Milner, Senior Food Technologist, UNICEF, United Nations, U.S.A. is inspecting "CECOCO" Rice Polishing Machine.



Mr. S.A. Heale Smith, Technical Officer, Ministry of African Agriculture, TANGANYIKA Government is checking "CECOCO" Handy Agricultural Machines.



Mr. William M. Ramlow, United Nations Industrial Engineer, COLOMBIA is detaching "CECOCO" Hand Rice Huller.

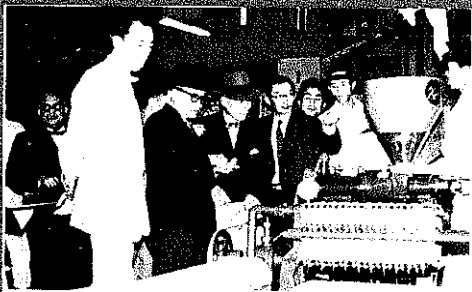

H.E. Dr. Mohammad Hatta, Former Vice President of INDONESIA Government is inspecting "CECOCO" Oil Expelling Unit.

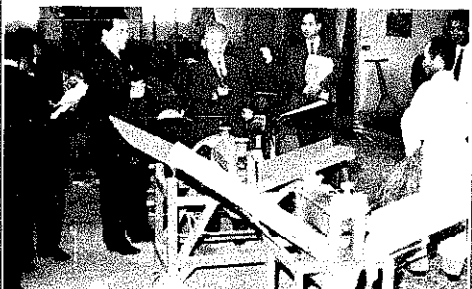

Hon. H. S. Khadivi, Undersecretary, Ministry of Agriculture, IRAN Government is inspecting "CECOCO" Straw Processing Machines.

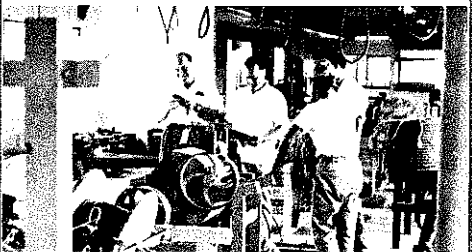

Mr. Arthur J. Prandle Chief of Purchasing Section, International Labour Office, SWITZERLAND is inspecting "CECOCO" Coconut Processing Machines.



Inspection Team Officers, Industrial Development Corp., BURMA Government are inspecting "CECOCO" Straw & Rush Mat Looms.



Mr. B.C. Teerink, Agriculture Officer, Dept. of Agriculture, Stock & Fisheries, PAPUA NEW GUINEA Government is inspecting "CECOCO" Hollow Block Making Machines.



Well Known All  
**CeCoCo**  
Over The World



Home of "CECOCO" Exhibition & Demonstration Farm Center  
"Japanese Rice Cultivation Method"

Trade Mark  
**CeCoCo**  
Established 1916

FOREIGN DIGNITARIES AND MANY DISTINGUISHED GUESTS have visited "CECOCO" EXHIBITION AND DEMONSTRATION FARM CENTER of Agricultural and Small Scale and Medium Scale Enterprises and Village Household Cottage Industrial Machineries, Equipment and Implements at Ibaraki, Osaka Prefecture, Japan, situated between Kyoto and Osaka on the main line of the National Railway of Japan. We extend you our warm and cordial welcome to visit us as we believe you can grasp at the spot a general idea of their adaptation which you can find no-where in Japan, so completely assembled at one place.

CORNERS OF "CECOCO" EXHIBITION & DEMONSTRATION FARM CENTER, IBARAKI, OSAKA, JAPAN.

Corner of Exhibition Room

Demonstration Hall

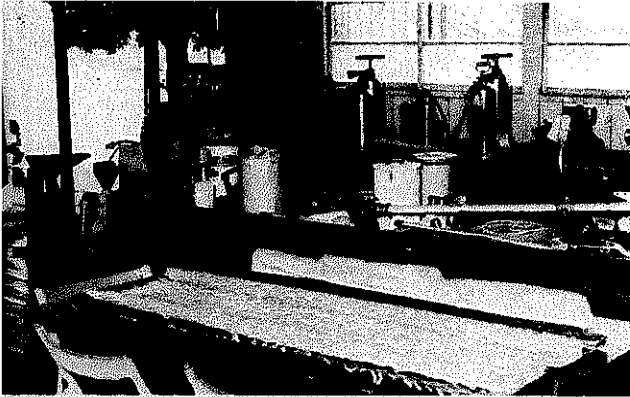

Agricultural Implements Corner



Straw Processing Machines Corner

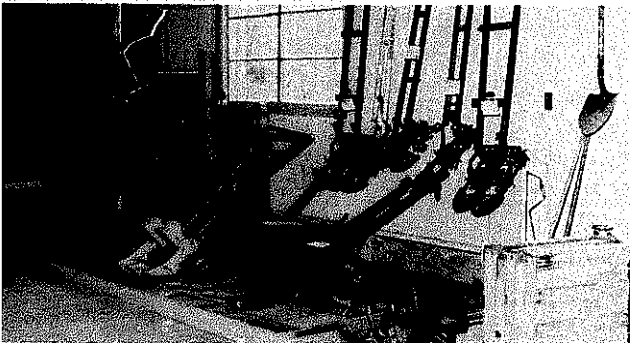

Rice Processing Machines Corner



Coir Processing Machines Corner

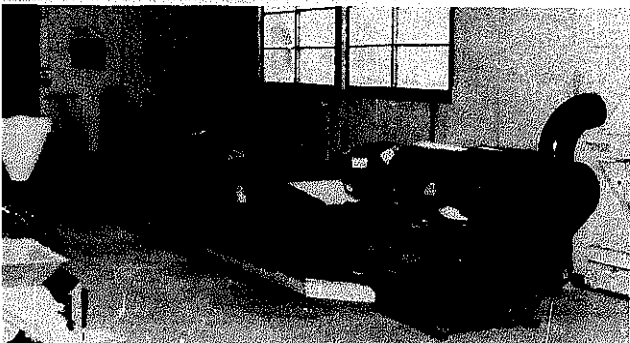

**CeCoCo** CHUO BOEKI GOSHI KAISHA (Central Commercial Co.)

Specializing in

AGRICULTURAL & INDUSTRIAL MACHINERIES & EQUIPMENT ENGINEERING CONSULTANTS

Published By

"CeCoCo" Exhibition Demonstration Center

Ibaraki City, Osaka Pref., Japan

(Cost US \$5.00 per Copy, Mailing Charge \$0.50)