

AT MICROFICHE
REFERENCE
LIBRARY

A project of Volunteers in Asia

Electric Motor Test and Repair

by: Jack Beater

Published by:

TAB Books

Monterey Avenue

Blue Ridge Summit, PA 17214 USA

Paper copies are \$ 7.00.

Available from:

META Publications

P.O. Box 128

Marblemount, WA 98267 USA

Reproduced by permission of TAB Books.

Reproduction of this microfiche document in any form is subject to the same restrictions as those of the original document.

T-97
\$6.95

ELECTRIC MOTOR TEST & REPAIR

SECOND EDITION

by Jack Beater

A guide to maintenance practices
for small horsepower motors



TAB BOOKS

BLUE RIDGE SUMMIT, PA. 17214

SECOND EDITION

FIRST PRINTING—JUNE 1966
SECOND PRINTING—JANUARY 1968
THIRD PRINTING—DECEMBER 1969
FOURTH PRINTING—MARCH 1970
FIFTH PRINTING—AUGUST 1972
SIXTH PRINTING—MARCH 1974
SEVENTH PRINTING—MAY 1976
EIGHTH PRINTING—APRIL 1977

ELECTRIC MOTOR TEST & REPAIR

Copyright © 1966 by TAB BOOKS

Printed in the United States
of America

Reproduction or publication of the content in any manner, without express permission, is prohibited. No patent liability is assumed with respect to the use of information contained herein.

International Standard Book No. 0-8306-6097-6

Library of Congress Card Number: 66-24043

PREFACE

While many of the larger motor repair shops find it more expedient to replace low horsepower units, the rewinding of small electric motors is still a widespread and profitable business. Thus, there is a distinct need for a practical guide-book on the subject. A quick review of the Table of Contents indicates that this is the purpose of this book.

This is not a college-level, theory-ridden textbook. It is a workshop handbook, written in style every motor repair technician will appreciate. It contains a wealth of useful information on testing and rewinding small horsepower motors of every type.

The Publishers

May, 1966

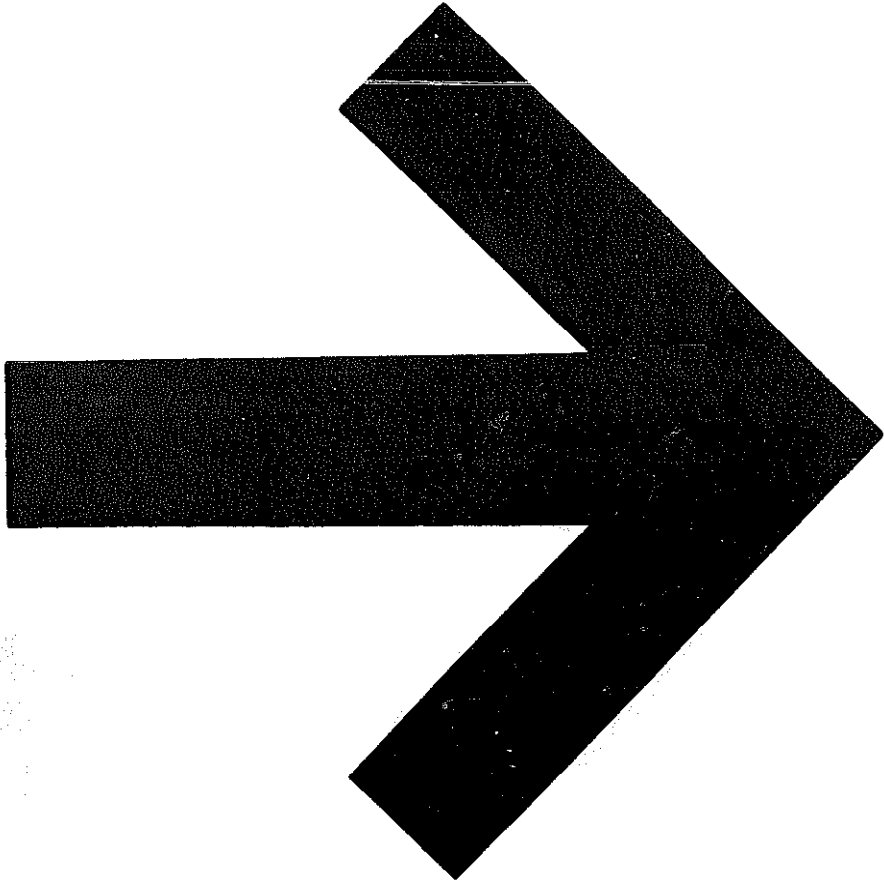

Table of Contents

	Page
Chapter 1 A Practical Motor Test Panel	7
Chapter 2 Tools for the Motor Rewinding Shop	17
Chapter 3 Time-Saving Coil Winding Machine	28
Chapter 4 Armature Testing	37
Chapter 5 Equipment for Testing Stators	48
Chapter 6 General Classification of A-C Motors	59
Chapter 7 Split-Loop Armature Winding	70
Chapter 8 Loop Windings for Small Armatures	81
Chapter 9 Rewinding Fan Motors	91
Chapter 10 Rewinding Automotive Armatures	103
Chapter 11 Rewinding Small Polyphase Motors	111
Chapter 12 Capacitor Motors	123
Chapter 13 Reversing Rotation of Motors	135
Chapter 14 Brush Troubles and Their Remedies	146
Chapter 15 Varnishes for Electrical Work	154

Chapter I

A Practical Motor Test Panel

A MOTOR test bench is almost a necessity for the shop doing even a very moderate amount of motor rebuilding or repairing. Even aside from its utility value, which it certainly has, it is a good investment from an advertising angle. The average customer coming into the shop will in all probability not know what this and that gadget is for, but you can trust him to look around and note that you use more than a hammer and a pair of pliers to install a bearing or wind an armature.

The word of mouth advertising of satisfied customers is at once the best and cheapest kind of advertising for the service shop. For this reason many shops having better than average equipment find that it pays to invite customers back into the shop and to spend a few minutes explaining some of the operations, and pointing out some of the special equipment necessary to do a good job.

This is the kind of advertising most needed by service men and service shops and it is the kind of advertising that can not be bought with any sum of money. A few satisfied customers can do more for a shop than hundreds of dollars in advertising.

A good motor test bench is as essential in a motor shop as a lathe is in a machine shop, and the up-to-date motor shop should have both. The test bench described in this article is in daily use in the motor department of an electric service* organization where it paid for its cost in increased volume of business within two months. This test bench is not an expensive, elaborate affair, but is a practical outfit designed by a service man for use in his own shop, and with one eye kept on the cost. Certain additions and refinements to the test bench shown in the photo would undoubtedly be in order for laboratory or experimental work, but for ev-

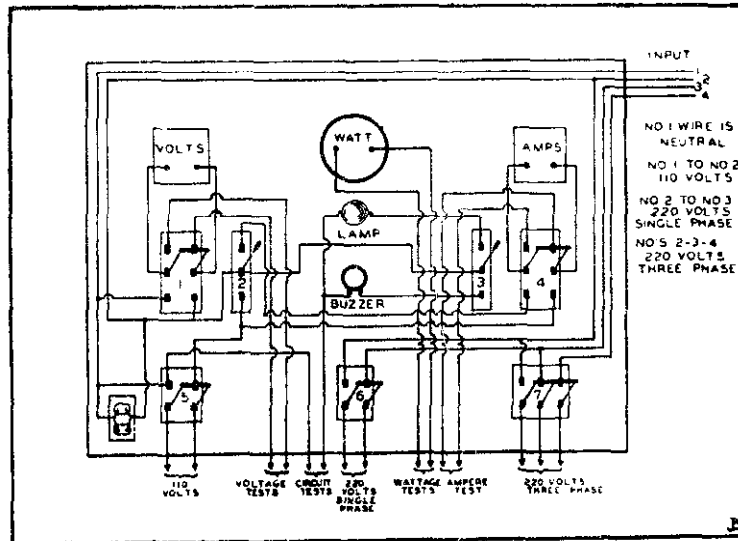

Fig. 1. Wiring diagram of complete test panel . . .

eryday use in the small shop there is but little room for improvement.

Figure 1 shows a wiring diagram of the motor bench test panel suspended from the ceiling above. By suspending the panel the surface of the bench is free from uprights, and motors can be pushed back and forth along the top of the bench without hindrance of obstructions. The feed wires enter the test panel through the conduit from above.

The bench is over 15 feet long and is used for repairing motors and winding stators as well as for testing. Only one section of the bench is reserved for actual testing, a section about 4 feet long near the center. Small and medium sized motors are serviced on this bench without having to be carried from place to place for different operations.

The meters used on the panel consist of an a-c voltmeter, an a-c ammeter and a wattmeter. In making up such a panel it may be possible to use such meters as are already available in the shop. However, if only one set are on hand it would probably be better to keep them for outside testing and purchase a new set of identical design for the panel board. New meters of the proper ranges for this work need not be too

expensive. Satisfactory instruments for shop testing of this nature can be had for about \$8 or \$10 each.

The seven switches used on the test panel described here can be of any type, just so they make a neat appearance and have ample capacity for the work. Most electric shops have on hand an assortment of switches salvaged from old work or discarded switchboards, and there should be little expense from this angle. The buzzer for circuit testing is an automobile generator cutout or relay. 110 volt a-c current, when passed through the shunt winding of the cutout, will give a loud buzz. The connections for this are from the generator terminal of the cutout to a ground on the base of the instrument. When used in this manner for intermittent testing they will hold up for a long period.

The following tests can be secured from this test outfit:

Voltage of shop power lines, 110 volts and 220 volts, single and three phase.

Line voltage with motor under test in operation.

Ampere reading with motor running or stalled.

Torque or brake horsepower tests.

Circuit or continuity tests, by test light or buzzer.

Voltage drops on any part of a circuit.

Ampere readings on any individual circuit.

Power consumption in watts.

Figure 1 shows a detailed drawing of the layout of the instrument panel. Obviously, this can be changed to suit the builder's particular requirements but it will be difficult to obtain a more symmetrical arrangement than that shown. Switch No. 1 is the voltmeter switch, a double-pole double-throw type. In the upper position, it connects the voltmeter with the voltmeter test leads only, and the voltmeter is then available for various tests independent of other switchboard circuits. When in the down position the voltmeter switch connects the voltmeter across the 110 volt line where it can be used to check line voltage and variations of the same when motors are being tested. Line voltages on the 220 single and three phase circuits can be tested from the voltmeter test leads when the voltmeter switch is on the "TEST" position.

Switch No. 2, a single pole double throw switch, is

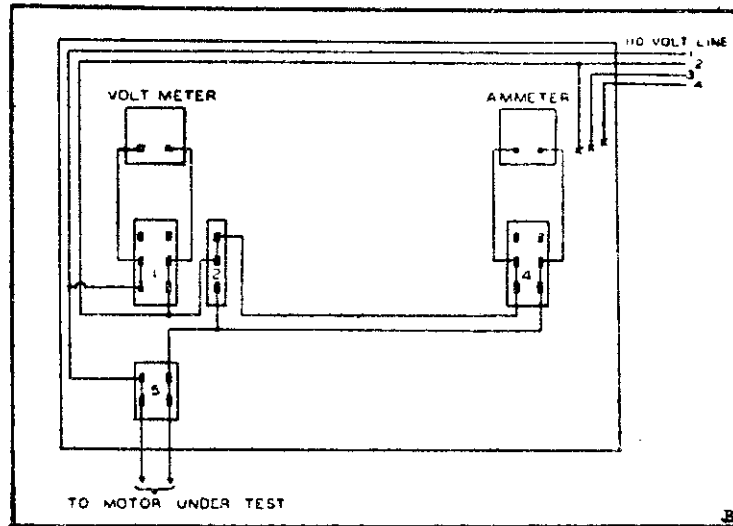

Fig. 2. Portion of test panel devoted to testing 110 volt motors and appliances. Switch No. 2 in "up" position places ammeter in line; "down" position cuts ammeter out of the circuit

used to shunt the ammeter in or out of the 110 volt circuit. When the switch blade is in the lower position current is by-passed direct to the motor under test so that in case of serious trouble in the motor under test the ammeter will not be damaged. Motors brought into the shop for repairs, or those not known to be free of shorts should always be tested with the ammeter OUT of the circuit the first time. Throwing this switch UP—when switch No. 4 is in the right position—places the ammeter in series with the 110 volt line.

Switch No. 4 is the ammeter switch. It is double pole, double throw, and when in the lower position places the ammeter in series with the 110 volt line as mentioned above. This switch, when in the upper position, connects the ammeter to the ammeter test leads so that various readings can be taken. By placing these leads in series with one leg of the 220 single phase line, or any one of the three phase leads, an amperage reading can be obtained on 220 volt motors.

Switch No. 3, a single pole, double throw knife switch, is used only with the continuity tests. In the down position this switch connects the buzzer in se-

ries with the test prods, while in the up position the panel light is brought into use. This testing circuit is connected permanently to the 110 volt line. The test leads from this circuit, like those from the voltmeter, ammeter and motor switches are fastened to the panel on the inside and cannot be removed. Hence there is no time wasted in hunting for loose test leads that have become lost, strayed or stolen.

Switch No. 5 makes or breaks the circuit to any 110 volt motor undergoing test. Switch No. 6 does the same for the 220 volt single phase line, while Switch No. 7 handles the 220 volt, three phase motor leads. A three pole single throw switch can be used here, but one two pole and one single pole switch placed side by side will make for handier testing. The reason for this is that the one single pole switch offers an easy means of inserting the ammeter into any one of the three phases for testing purposes.

When using the 220 three phase for operating a motor the single switch can be closed first, and the double pole switch will then control the motor the same as though it were a three pole switch. In other words, connecting but one phase to the motor will allow no current to flow, and a circuit can only be made when the second, or two pole, switch is closed. We can, then, clip the ammeter leads to the upper and lower contacts of this single pole knife switch on the face of the panel, leaving the knife open. Then when the two pole switch is closed we will get a reading of the amperes in the motor phase connected to the single pole switch. To obtain readings of the other two phases we have merely to switch the test board leads where they join the motor leads so that first one of them and then the other is connected through the single pole switch and hence through the ammeter.

The watt meter shown at the top of the panel is not connected with any circuit on the board. This instrument has independent leads and clips so that it can be placed in series with a motor under test. The duplex receptacle on the panel is wired to the 110 volt circuit and is used for plugging in small motors, fans and the like that are provided plug connections.

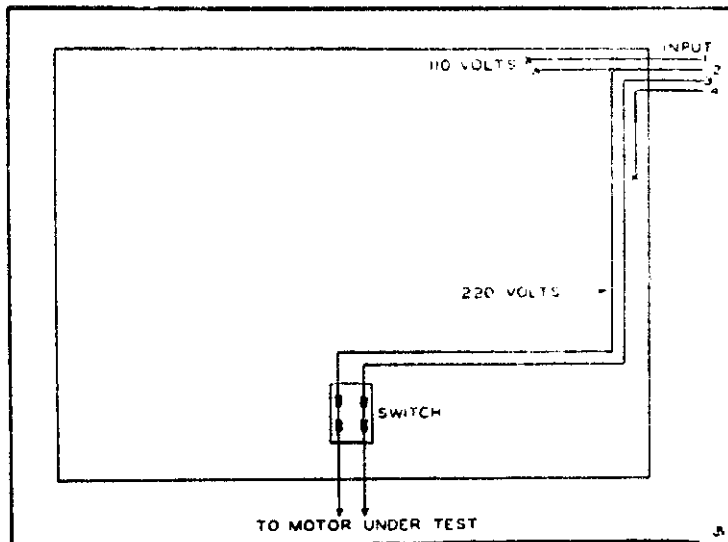

Fig. 3. Portion of panel used for testing 220 volt single phase motors. The voltmeter and ammeter can be used with this circuit for testing by making proper connections at motor terminals

The circuits shown on the test panel can be fused or not as desired. In the case of the particular panel mentioned in this article no fuse blocks are provided, as the fuse cabinet of the shop entrance is but a few steps away and should provide ample protection. However, it would do no harm to fuse the test bench on the reverse side of the panel.

To make the operation of the various tests clearer, several drawings are shown in which the individual circuits of the test panel are shown without the other parts of the test outfit. Figure 2 shows the 110 volt circuit; Figure 3 shows the 220 volt single phase circuit, and Figure 4 gives the diagram on the 220 volt three phase circuit. The complete circuit for the test lamp and test buzzer is indicated in Figure 5.

The foregoing covers the electrical testing of motors but the testing for mechanical efficiency is equally, if not more important. Hence the test bench must be equipped with some device for measuring both the starting torque and the full load torque of motors. There are several methods, simple in application, that are often used by the small shop to obtain these read-

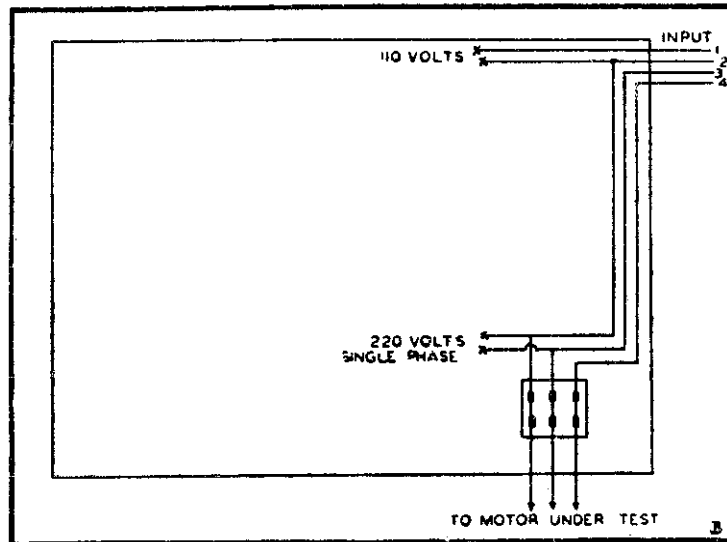

Fig. 4. Diagram of the 220 volt three phase circuit on the test bench panel. Voltmeter and ammeter can be connected in or between phases for testing motors under running conditions

ings. Figure 6 shows the setup for torque tests.

The drawing indicated as 6-A gives the details of the Prony Brake test. In the past, at least, this has been the most popular method of determining the power of motors. It requires the use of a pulley, brake arm and some form of spring or balance scale, one provided with small enough calibrations to secure readings on very small motors. The scale should, of course, be accurate within reasonable limits.

The brake arm used with this test should measure exactly 12 inches between the center of the pulley position and the end of the arm where the load is measured. The readings will then be in pounds-feet directly from the scale. The brake arm is made in the form of a clamp at the pulley end, and provided with thumb screws so the tension can be regulated at will. Hard maple makes a good material for the arm, but when it is not available some other material lined with brake lining at the pulley surface can be used. For the most accurate results the brake arm should be counterbalanced at the short end. Fairly stiff compression springs around the through bolts, and be-

tween the two sections of the arm, will make for more critical adjustments.

Before starting to make tests first be sure of the rotation of the motor, or some sort of serious damage may result. The rotation of the motor should, of course, either push down on a platform scale or pull down on a spring scale. In order to measure starting torque clamp the arm to the motor pulley so that the motor turns very slowly and read the scale.

To measure the pull-in torque release the thumb nuts on the clamp until the motor is just able to throw out the brushes in a repulsion-induction motor, or to cut out the starting winding in a split phase motor, and pull up to speed. The reading should be secured at the moment when the brushes leave the commutator, or in the case of a split phase motor, when the centrifugal switch clicks out. The true pull-in torque is the highest scale reading for which the brushes will throw off and stay off the commutator.

The second method of testing motor torque utilizes a rope and spring scale. The scale is suspended from the ceiling and the cord or rope is attached to the hook. This cord, incidently, should be small in diam-

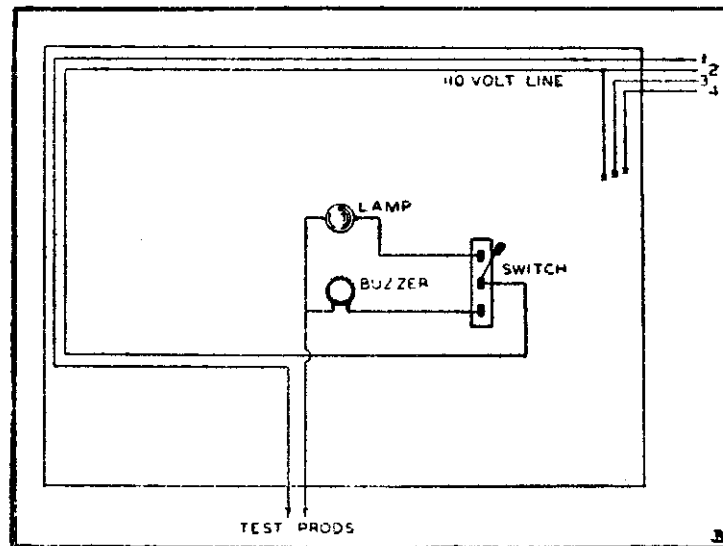

Fig. 5. Diagram of continuity test circuit. Either the Lamp or buzzer can be used for testing by means of the double throw switch

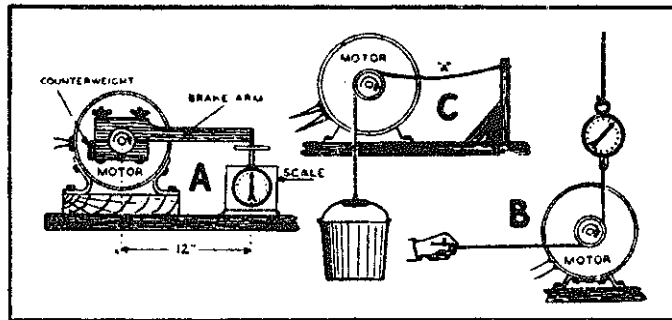

Fig. 6. Shop methods of measuring starting and full load torque on small motors. In method "A", tighten thumb nuts until motor turns slowly, then take reading from scale. In "B", pull on rope until motor turns slowly, read scale, and compute starting torque according to rule. "C", add sand to bucket until motor turns slowly and takes up slack in rope at A. Weigh bucket and sand to find pounds, then calculate starting torque according to formula

eter and tough, such as a woven linen line about 1/8 inch in diameter. The cord is wrapped around a flat, flanged pulley on the motor shaft and the other end is held in the hand. By pulling on the cord a load is applied to the motor and readings can be had from the scale. In some cases it will be necessary to bolt or clamp the motor to the bench to hold it in place while making the tests. Figure 6-B shows the arrangement for making this test.

Diagram 6-C shows the rope and weight test. This method gives satisfactory results without the use of a brake arm or a spring scale. Like the test above it does require a smooth flanged iron pulley of known size. Tie a rope to a bracket at one side of the motor, wrap the rope around the pulley a few times and attach a weight to the lower end of the rope. Oil or wax the rope slightly to prevent grabbing. As the weight must be adjusted to suit the power, or torque, of the motor and some means of regulating the weight must be provided. A simple way to do this is to use a bucket partially filled with sand. Add or take away sand until the motor will just start. The bucket and the remaining sand can then be weighed.

Example. To test a 1/4 H. P. motor, 1725 R. P. M.,

using a 4 inch pulley and a 1/8 inch diameter rope,
figure according to the following formula:

$$\begin{aligned} \text{Brake arm} &= \frac{\text{Pulley dia. in inches} + \text{rope dia. in inches}}{12 \times 2} = \frac{4 + .125}{24} \text{ ft.} \\ \text{Starting torque in Lb. Ft.} &= \text{Brake arm} \times \text{wt. hung on rope} = \frac{4.125 \times W}{24} \\ \text{Full load torque in Lb. Ft.} &= \frac{\text{Full load H.P.} \times 5250}{\text{Full load R.P.M.}} = \frac{.25 \times 5250}{1725} = .76 \text{ Lb. Ft.} \\ \text{Starting torque in percent of F L. torque} &= \frac{\text{Starting torque}}{\text{Full load torque}} \end{aligned}$$

Caution must be exercised by the service man in making these tests or bodily injury may result. Until the operator is thoroughly familiar with the making of torque tests he should be on the alert for flying weights, spinning cords, lashing brake arms and motors jumping off the bench.

Chapter 2

Tools for the Motor Rewinding Shop

AS IN any other trade the right tools play an important part in the success of a rewinder or motor repair man. Men long in the business have developed special tools for certain operations, and have acquired others by purchase. To turn out work efficiently—and at a profit—requires the use of labor-saving equipment and production methods. The need for special tools in the small motor shop is as great as it is in the factory, although the kind of tools needed for the motor shop will be simpler and less expensive than those needed in the process of manufacture.

We have all known mechanics who seem to take pride in the fact that they can get by with only a screw driver, hammer and pliers. And “get by” is about all they can do. The late Thomas Edison is once said to have remarked to this effect: “It is surprising to see what a good mechanic can do without tools, it is surprising to see what a poor mechanic can turn out with the aid of good tools, but when you get a combination

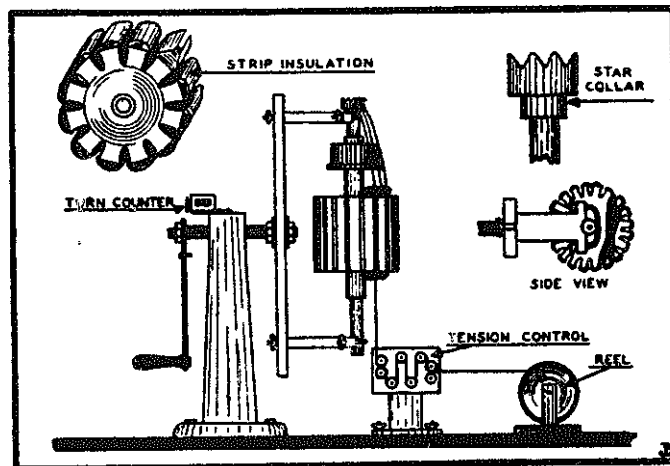

Fig. 1. Detail of a simple hand-operated armature winding machine

of a good mechanic and good tools—well, there's no limit to what he can do."

The winder or motor repair man in the small shop need not go without the necessary tools to do good work and speed up his output. Many of the most necessary tools can be built right in the shop in spare time, and the others can be purchased at reasonable cost. Many a man starting in the business with little capital has built up a good part of his tool equipment himself, and with the money earned from it has gone out and bought more and better equipment as his business grew.

The purpose of this article is to acquaint beginners in the winding and motor repair business with a few of the tools that are almost indispensable for the small shop. These are in addition to other equipment, such as testing outfits, armature and stator holders, winding benches, etc., that have been mentioned in previous articles. Many of the items listed here can be bought from jobbers or manufacturers of shop equipment, such a course being recommended where possible. The illustrations are typical of the kind of special tools that have been found practical for the shop specializing in the repair of the smaller types of motors.

Probably every winder has thought about the use of an armature winding machine at some time or other. Large electrically operated armature winding machines are on the market, and are being used with success in many a shop. They are practical and well worth their cost where there is sufficient volume of business to justify their use. Such machines, with a capacity of over 100 armatures per day, would be out of place in the small shop where the daily average of rewind jobs might be as low as two or three.

On the other hand, a simple hand-operated winding machine is a very useful fixture for the small shop, and also in the large shop for special work. One great advantage of the hand winding machine over plain hand winding lies in speed. Another is the fact that, with a suitable tension device, the coils can be wound with an even tension and the turns accurately counted. The latter is particularly important where the coils consist of a very large number of turns.

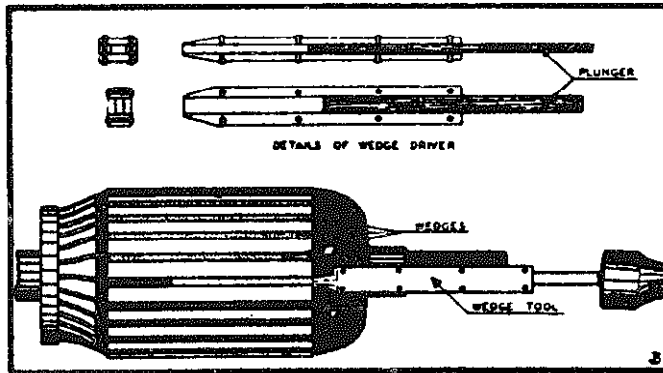

Fig. 2. Wedge driving tool for pegging armature slots

Figure 1 shows a diagram of a shop-constructed hand winder. The base can be made from an old standard of some sort, pipe, a large connecting rod from a discarded motor, or from wood. The shaft and handle can easily be made or salvaged from junk. The face plate should be $\frac{1}{2}$ " by 2", either iron or steel, and about 18" long. From each end a slot runs almost to the center so that the armature shaft holding brackets can be adjusted to fit armatures of all lengths. The armature to be wound is held in notches and fastened with U clamps. By turning the machine around it can be made to suit right or left handed operators. The turn counter registers each revolution of the armature.

As indicated in the upper left hand corner of the illustration, strip insulation is best for use on this kind of winding. Individual slot insulation can be used but is likely to cause the operator a great deal of trouble, as the wire has a tendency to catch on the corners of the paper. Strip insulation has another advantage in that it tends, because of the support from adjoining slots, to remain in place while the slot is being filled instead of sliding out at one end.

In operation the wire is first looped over the star collar on the upper end of the armature shaft, is then fed into the first slot, around the drive end of the shaft to the other side of its span, and so on until the full quota of turns has been placed. The end of the wire is now looped over another notch in the star col-

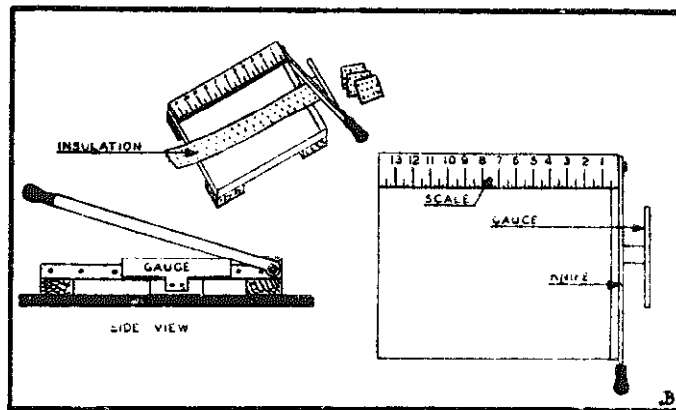

Fig. 3. Cutting and gauging board for trimming slot insulation

lar and the second coil is wound. This is repeated until all coils have been wound. At the completion of the winding it will be found that all commutator leads are over the star collar under tension and of ample length. The wedging should be done before cutting the leads. Bringing out the beginning ends of the lower coils on top can be done by cutting the wire and placing as the winding progresses.

As the wire is wound into the slots the tension is regulated entirely automatically, the free hand being used merely as a guide to see that the wire enters the right slot. In making a tension device care should be used to see that the enamel covering of the wire is not cracked by bending too sharply. If a device similar to the one shown in Figure 1 is used, the grooved wheels over which the wire passes should not be of too small diameter. Some rewinders use a brake shoe with spring adjustment that applies pressure directly on the rim of the reel. The object of any device of this type is to maintain a constant and even tension at all times, and to prevent backlash.

When winding armatures with more than one wire in hand, additional tension devices will be needed, one for each reel. The tension should be exactly the same on all wires, otherwise the wire with the greater tension will tend to pinch and bind the sides of the looser coil. When winding with more than one wire in hand, the additional wires should have a tracer so that the

proper coil ends can be located without trouble. After some practice the rewinder, with the aid of the hand winding machine, should be able to double his output over the straight hand winding method.

Another great aid to the winder is in the use of a wedge driving tool. Many of the smaller, and some of the larger, cores were designed for fibre wedges. Fibre wedges, being flat, take up less space than do the usual maple wedges, and as a consequence it is sometimes difficult to insert the wooden wedges over a full winding in the space allowed. It is also true that fibre wedges are brittle and tend to buckle and break when driven without the aid of a tool. In very tight spaces the wedge tool is a big help in driving home wooden wedges also.

Figure 2 shows the details of a serviceable wedge driver in cross-section and in use. Several sizes will be needed to accommodate the various wedge sizes. The body of the tool is made up on brass or steel strips riveted together. The sides of the tool should be slightly thicker than the thickness of the wedges to be

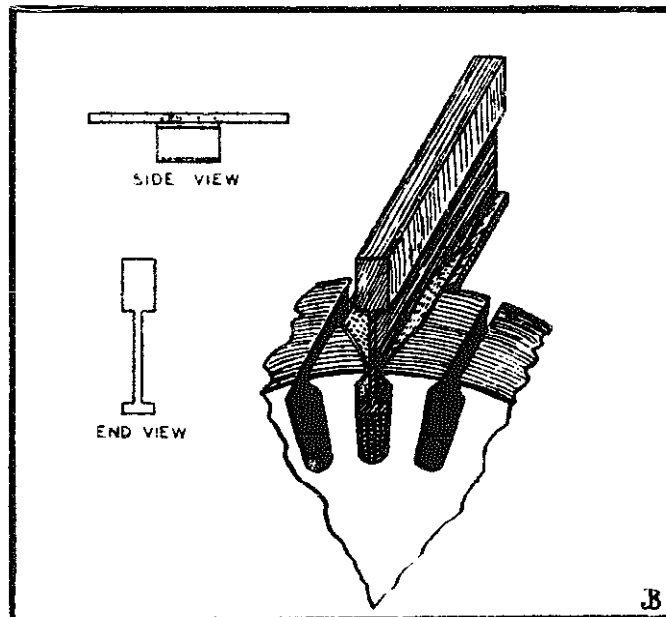

Fig. 4. Metal drift for packing coils in slots with narrow openings

used, while the top and bottom of the tool can be cut from $\frac{1}{8}$ " stock. Small steel pins, about $\frac{1}{16}$ " in diameter, are used to rivet the parts together. After assembly the working end is ground down thin so that it can be held close to the core without cutting or chafing the winding. The plunger or driver should be a free running fit in the slot and about $\frac{1}{2}$ " longer than the body of the tool. In using, a wedge is inserted in the slot of the tool and the tapered end of the driver is held close to the slot entrance. A few light hammer blows on the plunger head will force the wedge into the slot without spreading, breaking or buckling.

Another great time saver for the rewinder is a cutting and gauging board for preparing the cell insulation for the slots. A board of the type shown in Figure 3 enables the winder to easily and accurately trim up a set of insulation to the desired size in a few moments' time. The adjustable gauge at the cutting end, when once set to the right length, allows the operator to do the cutting at high speed without error. The scale, marked off in inches across the top of the board, makes for quick measurements.

The foregoing cutting board can readily be adapted as a machine for forming slot cell insulation to shape. To do this a sheet of thin metal is folded once around a section of the cutting knife, leaving the edge slightly rounded instead of sharp. The slot paper is creased

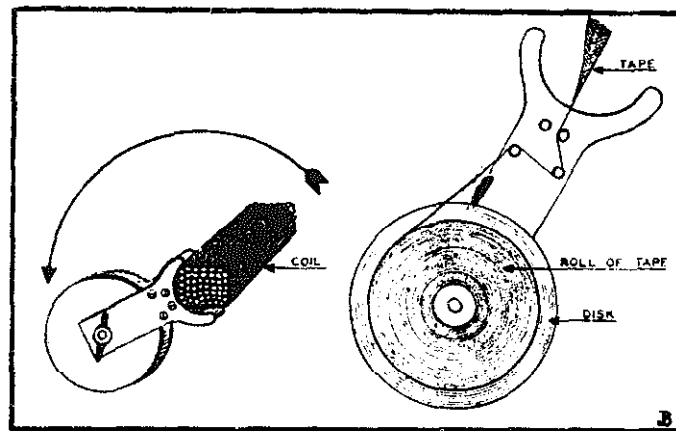

Fig. 5. A device to aid in hand taping of armature and field coils

between this dulled portion of the blade and the edge of the board. Only one crease can be made at a time, but it can be made accurately and quickly.

Every winder knows how hard it is to pack down the wires in slots having very narrow openings so that the full quota of turns can be put in place. On slots having wide openings a square of fibre board can be used to press down the wires, but on many armatures and stators the slot openings are too narrow to make good use of such a method. To overcome this difficulty it will be worth the winder's time to make up a set of drifts such as the one pictured in Figure 4.

Drifts in the shape shown may be hard to obtain, but the winder can have them milled from a solid bar at any machine shop. To cut down on expense have a twelve-inch length of $\frac{1}{2}$ " cold rolled steel milled to the indicated shape, leaving the shank a little less than $\frac{1}{8}$ ". Have the footing, or working edge, left about $\frac{1}{8}$ " thick. After the bar has been milled it can be sawed into three 4" pieces, each piece being riveted or bolted to a handle of some sort. The handle will make it possible to use the drift inside small stators and a good job can be done without the use of hammer or mallet.

After the three drifts have been supplied with suitable handles the foot, or working end, can be ground or

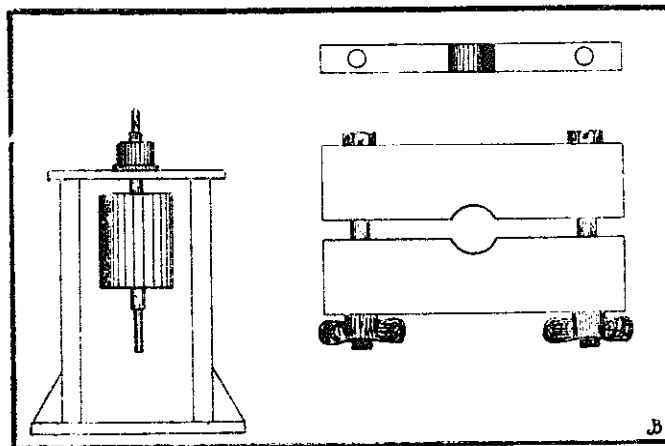

Fig. 6. Puller plate for removing commutators and, at the left, a stand for using the puller in a press

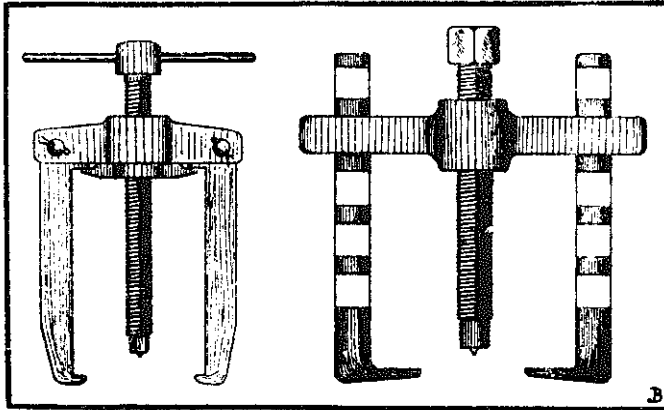

Fig. 7. At the left is a puller for gears, V-pulleys and other small parts. At the right is a puller for large leather, composition and steel pulleys

filed down to any desired width. For work on small motors, $\frac{1}{4}$ " , $\frac{5}{16}$ " and $\frac{3}{8}$ " will be the most useful widths. By means of a small, fine file the edges and corners should be slightly rounded and smoothed so that there will be no danger of damage to insulation of wires or slot paper. A set of these drifts will save a lot of time and make for a neater and more compact winding.

Covering armature coils and field coils with insulating tape is a job that takes considerable time if done with the bare hands. In the larger shops where there is a considerable volume of this work a motor driven coil taping machine is often used. Operating on the same principle as the machines which wind the paper wrappings on automobile tires, a coil taping machine can make a lot of money for the shop if volume permits. However, there are few shops that have sufficient work of this kind to justify the outlay for a taping machine.

Figure 5 pictures a device for use in the hand taping of motor and generator coils. With this tool the taping job is speeded up considerably as there is no time lost in drawing through a long length of tape each time a turn is made, or else in chasing over the floor after a runaway roll that has escaped the winder's hands. A

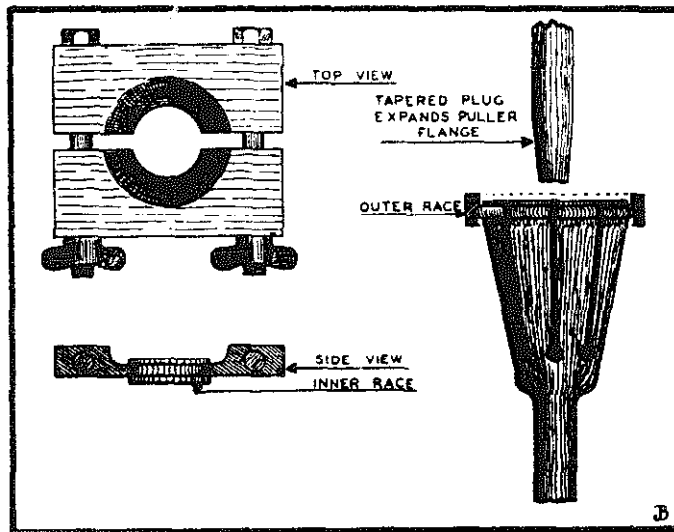

Fig. 8. At the left is a puller plate for removing inner ball races from shafts, while at the right is a tool for removing outer ball races from recessed holders

tape winder such as described will not work with coils having a center opening of less than about 4", for the obvious reason that the tape winder will not go through the hole.

Essentially, the tape winder is a means of holding a roll of tape under the proper tension, so that as the winder is rotated around a side of the coil it distributes the tape both evenly and firmly. After the first turn or two the operator has only to flip the winder around the coil, handling it only once per revolution, and seeing that as it progresses the right overlap is made with each turn.

In making a winder such as is shown in the cut, the two side pieces can be cut from thin sheet brass and sawed or filed to shape. Four brass machine screws hold the two sides the proper distance apart and also act as guides for the tape. The roll of tape is centered on a through bolt which, by the use of a wing nut, acts as a tension regulator. Two thin fibre washers, slightly larger in diameter than a full roll of tape, are placed one on each side of the roll for support. The overall

length should be kept as short as is possible for the reason that this measurement is what determines the minimum size of the coil which can be taped.

Another group of tools needed by the motor repairman consists of a set of pullers. No one type of pulier is satisfactory for all purposes. Roughly, the puller needs of the average small motor shop can be classed as follows: Puller for small flat and V pulleys, puller for large flat leather, steel or composition pulleys, puller for small bronze bushings and a puller for commutators.

Figure 6 shows a puller plate for removing commutators from armature shafts. The plate is in two parts, held together by two wing bolts, and notched in the center to fit closely to armature shafts. This plate can be used in conjunction with several types of pullers, and finds its best use in its ability to pull commutators without subjecting the bars and insulation to strains. The plate should contact the inner commutator sleeve and apply the pressure at that point where it joins the shaft. On the left side of the figure is shown a wooden stand to be used with the puller plate when the commutator is to be pressed off in a screw press, or when it is necessary to remove the commutator by hammer blows. The same plate can be used to press commutators on the shaft.

Figure 7 shows two common types of pulley and gear pullers. The one on the left is best suited to the smaller types of pulleys and gears, and is well adapted to removing V pulleys similar to those used on most refrigeration motors. Pullers of this type can be had that are self locking when under pressure. Note that the puller jaws have projections which extend under similar projections from the sides of the central nut. It can readily be seen that as soon as the screw presses against the nut, the nut in turn presses against the jaw projections, thus forcing the jaws in toward the work they are holding. The greater the force needed to move pulley or gear the greater is the holding ability of the jaws.

The puller illustrated at the right is particularly useful on the larger flat pulleys used on multi-horsepower motors. The jaws are adjustable for width by

sliding in the slot of the puller head, and they are adjustable for length by making use of any of the notches provided in the sides of the jaws. The lips of the jaws should be long enough to reach over the leather or composition surfaces of built-up pulleys and to reach the metal hub. The jaws on this type of puller can be reversed, making the tool available for inside work, such as pulling rings and working in recesses.

Figure 8 gives some details of a common type of puller plate used in removing ball bearings of the three-piece type (magneto type). The plate, similar to that shown in Figure 6, has a thin lip around the center opening that will clamp tight in the ball groove of the inner race. This plate can be used in a press or with a puller of conventional type. A tool for pulling outer ball races is also shown. The construction of this outer race puller is more complicated than is that of the inner race puller. While such a tool could be turned out by a good lathe man, it would probably be cheaper in the long run to purchase such a tool from the service tool list of some manufacturer. A tool of this kind will only fit one size of bearing, but adapters for larger sizes can be turned out and used in connection with it.

There are many other tools that are equally handy for the rewinder and motor repair man. Many of these are made from old hacksaw blades, wood, fibre, bits of brass or steel, and fashioned to suit the user and to fit some particular job or operation. In fact, the good workman who takes pride in his job is always making something, and sometimes the result of an hour's experimentation will result in a labor-saving gadget that, in the course of time, will return big dividends for the time and effort spent on it.

Chapter 3

A Time-Saving Coil Winding Machine

THIS business of repairing motors is rapidly becoming specialized into two divisions. There are those larger shops that service the needs of the industrial field, and there are thousands of smaller shops whose main source of business comes from refrigeration motors and other domestic and commercial appliances. The larger organizations specializing in industrial motors have little interest in fractional horsepower motors because of the small sum in dollars involved in such work. In fact, many of the larger shops refuse to accept small single-phase motors for repair.

The opposite is true of the small shop. They have neither the skill nor the equipment to handle the large work. They do a good job, however, with the fractional horsepower motors with only a reasonable amount of equipment and a minimum of overhead. And the number of these small motors is growing rapidly, affording prospects of increasing business for years to come.

The profits to be made from the repairing or re-winding of small motors is limited by several fac-

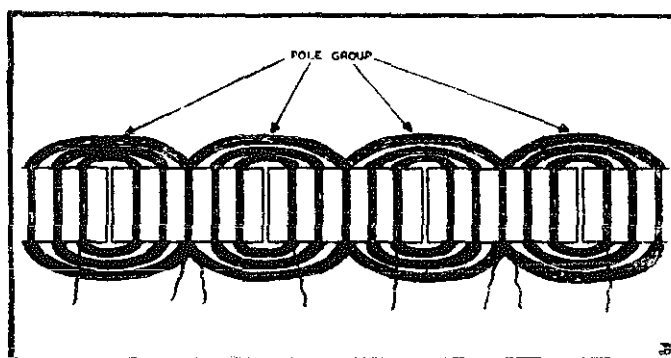

Fig. 1. Appearance of four pole stator projected on a plane surface. Note coil groups.

tors. Competition establishes the price that can be charged. Two forms of competition face the small motor shop. One form of competition comes from the winding shops in the larger cities who handle such work on a flat rate basis, the other comes from the present low price of new motors. It is obviously unreasonable to charge a customer \$15 for a repair or re-winding job when a new motor of the same kind can be purchased for a dollar or two more.

Recognizing this, some shops make it a rule never to allow the repair costs to exceed 65% of the original or replacement cost of the motor. If they can not see their way clear to handle the job at this figure they recommend the purchase of a new motor. Freight or express charges should be included when figuring the ratio of a repair job to the total cost of a new motor.

In exceptional cases, such as in emergency work, the customer may be willing to pay even more than the cost of a new motor if there is a considerable saving in time.

Since the price that can be obtained for repairing or rewinding small single-phase motors is more or less standardized in each district, the profit available depends upon the ingenuity of each individual shop. The shops that are making money include not only those most aggressive in obtaining business but also those who have developed methods of turning out the work with the least labor.

Since labor is the most expensive item entering into the average motor job, the method of handling the work will usually be the determining factor in the profit or loss that results. The labor going into motor repairs can be conserved in two ways: by the use of labor saving equipment to speed up the operations, and by doing the work in odd and otherwise unprofitable hours. A combination of the two yields the greatest margin of profit.

Let us consider first the utilization of spare time. Every shop will receive some motors that require complete rewinding. The cost of supplying new stator and rotor windings, commutator, bearings, brushes, etc., will be approximately that of a new motor. In such cases, the logical way to handle the matter is to

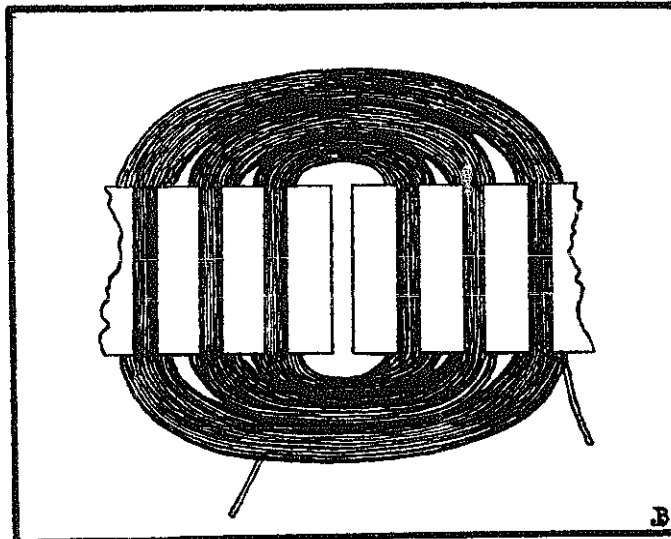

Fig. 2. This drawing shows a coil group wound by hand. Unless spacing blocks are used coils will rest on each other

minimum of expense. A representative stock of reconditioned motors, ready for immediate use, is one of the best assets, from both a profit and advertising point of view, that any motor service shop can have. Quick and dependable service is one certain way of retaining good customer relations, and this can be accomplished best by maintaining an assorted stock of new and reconditioned motors.

The other method of reducing labor costs, the use of time saving equipment, has been mentioned in this series many times before. A large number of special tools and jigs which simplify motor work have been described from time to time. Although nearly every tool and fixture required in motor work can be obtained from equipment manufacturers, many small motor service shops, limited in capital, find it necessary to either construct for themselves such labor saving tools as they require or else continue the use of hand methods.

The coil winding machine, a tool that cuts hours into fractions when winding stators of the popular types of refrigeration motors, is one of the most valuable

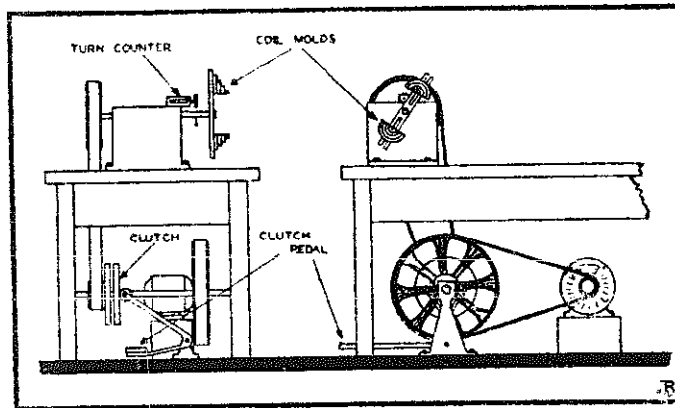

Fig. 3. Two views of a practical and easily constructed coil group winding machine . .

labor saving devices. By the use of this machine, the repairman can form a complete set of starting or running coils and have them ready for assembly in the stator in only a few minutes. The tedious grind of feeding the wire back and forth through the slots is eliminated. The remaining operations consist of fitting the coils into the slots, inserting the wedges, and making the connections.

For the assistance of those men who are new to the business, we will describe the stator windings of the two types of motors most generally used in connection with electric refrigeration: the repulsion-start, induction-run motor, and the condenser or capacitor motor. In the former there is but one winding on the stator, the main or running winding, while on the condenser motor the stator field consists of two windings, the main or running winding and the starting winding. In this respect the condenser motor is like the split-phase motors which also have two windings.

In motors of these types, the section of the stator laminations surrounded by one group of coils becomes a pole. For example, if the total winding is wound in the form of two groups, the motor is a two pole machine; if wound in four groups the motor becomes a four-pole machine, and so on. All the coils that form one pole of a motor are known as a pole group. If we cut a stator through on one side and roll it out flat,

with the windings still in place, it will appear as shown in Figure 1. Here the pole groups are easily identified, and we see that each pole group consists of three, four, or more concentric coils. The first coil is in the center of the group and each additional coil surrounds the smaller coils as shown in Figure 1.

Each pole group of coils is wound with a single continuous wire, the starting point being at the inside coil. When winding by hand, the proper number of turns are wound into the slots to be occupied by the inner coil, then the wire is carried into the adjacent slots on each side and the second coil is wound. The wire is then carried to the slots adjacent to the second coil and the third coil is wound. This is repeated until the full number of coils required in the group has been completed, and the group ends with the wire coming from an outside slot. The proper polarity of each coil group is determined by the direction of rotation during the winding. The first group, for instance, may be wound in a clockwise direction; the second group should then be wound in an anti-clockwise direction; the third group, clockwise; the fourth, anti-clockwise; and so on, according to the number of poles.

In many cases, the hand winding of stators is tedious work because of the "spring" of the wire, the smallness of the opening, sharp edges, or the difficulty of maintaining the right tension at all times. The use

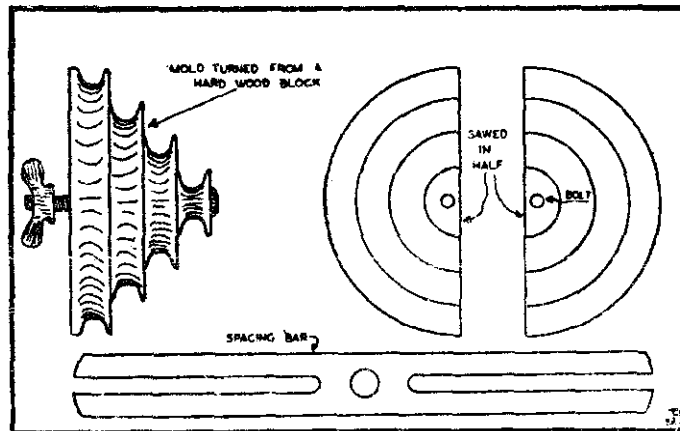

Fig. 4. The details of the molds used with the winding machine of Fig. 3 are shown above

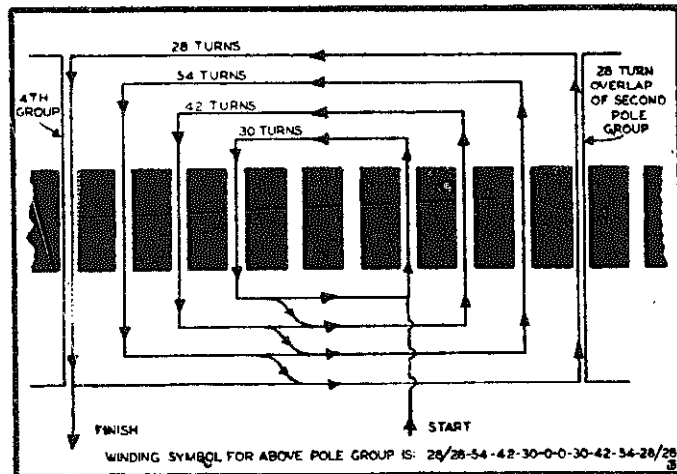

Fig. 5. Typical diagram form of stator coil pole group showing slot and turn data . .

of the winding "gun," described in a previous article, is a great improvement over the straight hand winding, both in time saving and in the neatness of the work. Only long experience and practice enables a winder to turn out a neat, symmetrical job by the plain hand method. Figure 2 shows the general appearance of a coil group wound by either the hand or the "gun" method. Note that in this type of winding, the coil ends rest upon each other for support as the winding progresses, and that there is consequently greater chance for short-circuits between coils. Some rewinders make use of curved blocks between coils during the winding to space the coils properly. The blocks are removed, of course, after the winding is completed.

Most factories, and many rewinders, use a method of winding that has many advantages over straight hand winding. This consists of the use of preformed coils prepared by means of specially designed winding machines. This method may be used to advantage in rewinding motors of the type used in refrigerators. Some points in favor of the prewound coils are: all coil groups are alike as to size and shape; errors in counting turns are practically eliminated; adequate clearance may be provided between coil ends; and a great reduction in winding time is possible. The elec-

trical resistance of coil groups wound in this manner is practically always uniform.

A machine that will wind complete pole groups for single-phase motors up to about 3 horsepower in capacity is easily constructed and will be a most useful piece of equipment for the small motor shop. Almost every shop has a junk box that will afford ample material for the essential parts and hold the construction cost down to a few dollars. The machine shown in this article is typical only and may be simplified or elaborated upon at will. The exact design will vary with the materials available and the ingenuity of the builder. For efficient operation, the features of electric motor drive, control clutch, and turn counter, should be retained. Figure 3 shows two views of a typical machine.

The machine can either be built on the end of an ordinary work bench or it can be constructed as a complete unit. In either case, it is best to have the motor, shafting, and belting below where they will be permanently out of the way. The base of the machine can be made in any number of ways. An old arbor from a belt driven grinder is one suggestion, but any substantial pair of bearings that will hold the shaft in alignment will serve the purpose. The coil winding jig bar is bolted to one end of the shaft; the drive pulley, to the other end. A pin or a sprocket to operate the turn counter should be clamped on the shaft.

The power required to operate the machine is small and may be obtained from a motor of about $\frac{1}{8}$ hp. A speed of about 30 to 60 turns per minute is all that is desired. Provision for reducing the motor speed to suit the work can be provided by the use of line shafting, pulleys, and belting. A clutch operated by a foot pedal is a necessity and should be provided. If nothing better is available, a suitable clutch can be made from wooden disks as shown in the illustration.

The molds upon which the coils are wound present no problem if the shop is equipped with a lathe. Molds to suit coils of any size can be turned out as required and a representative assortment of forms will soon be on hand to fit practically any type coil. These molds should be turned from a block of hard wood, sanded

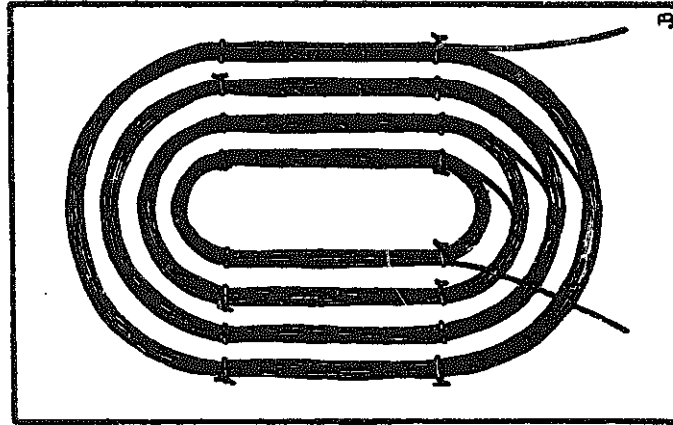

Fig. 6. Representative pole group taken from winding machine. One advantage of this method of winding is the spacing between coils.

smooth, and shellaced. The details of a typical mold and holder bar are shown in Figure 4.

The first step in winding a coil group is to measure accurately the size of each coil forming the group. This can best be done by salvaging one of the old coil groups intact, or by winding carefully a single stiff wire into the slots and forming it to the size and shape desired for each of the coils in the group. With this as a guide, the molds can be spaced properly on the bar to form complete coils of the right size.

In winding a coil group, the beginning end of the wire is tied to the spindle and brought into the groove of the first coil through a small notch. Ample length for connecting should be provided. When ready to start winding, the counter is set at "0," and the foot is pressed on the clutch pedal. Either the largest coil can be wound first, with the others in rotation, or the start can be made with the smallest coil.

Let us suppose that the coil group we wish to wind consists of 30 turns for the inner coil, 42 turns for the second coil, 54 turns for the third coil, and 28 turns for the largest coil. On a winding chart this might be shown as: 28/28-54-42-30-0-0-30-42-54-28/28. The 28/28 symbol denotes that the side of the outer coils of adjoining groups occupy the same slot. The -0-0- indicates that 2 slots in the center of t

are vacant. Figure 5 illustrates how this group would be shown in diagram form.

In winding this coil, we start the machine and allow 28 turns to form in the largest groove of the mold. We then stop the machine, readjust the counter to "0," and proceed to wind 54 turns in the next smaller groove. Again the machine is stopped, the wire is passed over to the next groove and 42 turns are wound. We stop to pass the wire over and finish by winding 30 turns in the smallest groove. The coil group is now complete, but before we remove it from the mold, we should tie it to maintain its shape.

Short lengths of annealed wire make the best ties for the completed coils. One turn around the coils on each side is usually sufficient. Care should be exercised so as not to injure the cotton covering or the enamel. These ties are removed, one by one, as the coil sides are fitted into their respective slots. Figure 6 shows the appearance of a completed coil group as it comes from the machine.

The next step, that of assembling the formed coil groups into the stator, is easy after a little practice. Some patience is required when the slot openings are narrow, but by pressing two or three wires into place at a time the difficulty is overcome. If the slot lining extends well above the stator bore, it will guide the coil sides into the slots. The proper polarity of each coil group must be given consideration as the coils are assembled into the stator. The operations required after the coils are assembled in the stator are the same as in hand-wound jobs.

The use of a coil forming machine such as just described here will go a long way toward helping the small shop to compete on an even basis with the larger shops. In the face of aggressive competition, proper equipment is essential. A machine similar to the one mentioned here will do neat work, and what is probably just as important, will save hours of the motor repair man's time.

Chapter 4

Armature Testing

MUCH has been written about the winding of armatures but little about the methods of checking up on the work as it progresses. The winding of armatures is clean work and exceedingly interesting to those who like it until some form of trouble turns up. Nothing can ruin the day for an armature winder like a "bug" in the winding; one that stubbornly resists all efforts to locate it. Because he has been so close to the work, the winder himself may have difficulty in finding his own mistake; a mistake that may be obvious to a fellow workman. In the larger shops, the foreman, or another winder, may be called upon to do the trouble shooting, but the winder who works alone must depend on testing methods to insure accurate results.

In the usual course of winding, the winder goes about the task more or less automatically, having de-

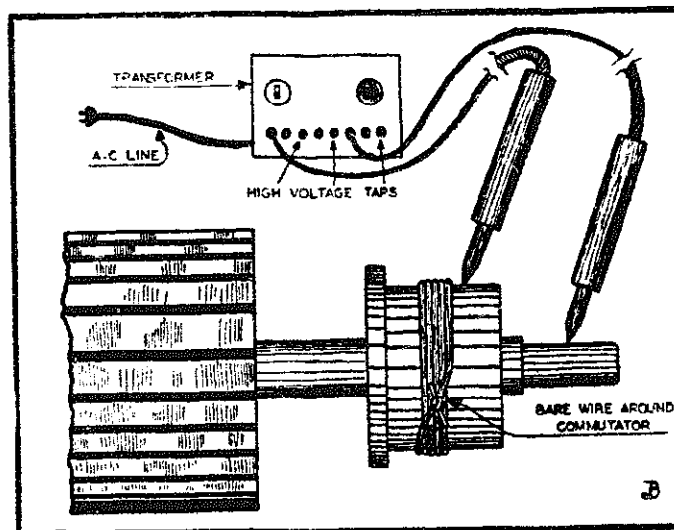

Fig. 1. A quick method of testing commutators for grounds is shown here. The wire connects all segments electrically so that only one test is required

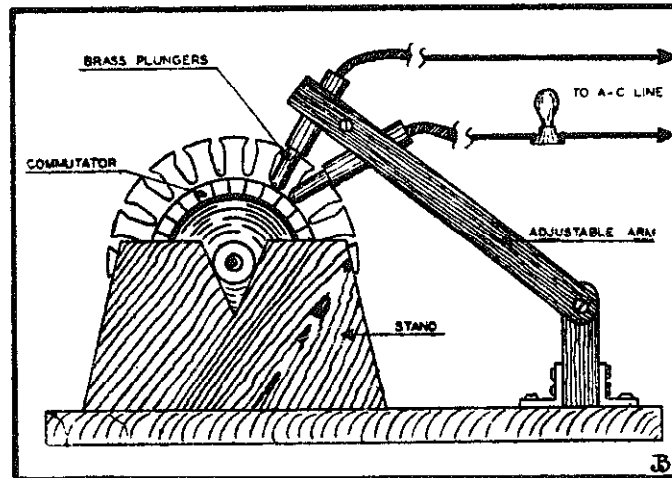

Fig. 2. This handy rack facilitates the testing of commutators for shorts between bars. Springs in the hollow plungers, insure good electrical contact with bars

veloped a certain familiarity with the work. Ever so often, however, an odd job will turn up; one that so taxes the ability of the winder that an error may result from his confusion. The error may be a short or a ground caused by trying to pack a large number of turns into a small slot. It may result from making a wrong connection or any number of other reasons. Most of the writer's troubles in this respect have come about as a direct result of telephone call interruptions or from the idle chatter of well meaning visitors.

Regardless of how careful the winder may be in his work, difficulties will occur which cannot always be prevented. The next best thing, then, is to detect such errors as soon as possible after they occur; not after the winding is all but completed. To do this the winder must use a system, a methodical routine of work and test, work and test. The worst troubles that may occur in armature winding are easily corrected if discovered in time. Each coil that is wound over a defective one makes the trouble shooting that much more complicated and the remedy more difficult.

In armature winding, the most frequent causes of trouble can be traced to the following defects: short circuits, grounds, reversed connections, and open circuits.

Short circuits are most common defects encountered. They may occur between the turns of a coil, between two coil sides occupying the same slot, between coil ends where they lap over each other, between coil leads, and between commutator bars. Open circuits do not occur often. Grounds are also rather uncommon where good slot insulation and fibre end laminations are used, and where the winding is performed in a careful manner.

Test Commutators First

The commutator can account for a lot of the winder's troubles if proper testing is not done in advance of the winding operation. As soon as the armature has been stripped, the commutator should be tested for grounds to the shaft and for shorts between bars. The test for grounds can be made by brightening the commutator and wrapping a bare copper wire around it three or four times so that contact will be made with all bars. Test from commutator to shaft using a voltage much higher than the normal operating voltage of the motor.

Small motor commutators of the 110-220 volt type should be tested at about 1000 volts for at least 60 seconds. A flash test is not always reliable because a little time is often required for the defect to show up. Alternating current is best for testing and can be stepped up to the voltage desired by means of a transformer. The commutators of very small motors, such as are used in sweepers, mixers, etc., are often unable to stand this test because of the thinness of the insulation, but such small commutators should be able to withstand double their normal operating voltages. A rule often followed in testing the commutators of larger motors, $\frac{1}{2}$ hp or more, requires the application of 1000 volts plus twice the normal operating voltage. The commutator of a 1 hp, 220-volt motor would be tested at a voltage of 1440 volts, according to this general rule.

Figure 1 shows the method of testing commutators for grounds. A transformer can be constructed in the shop that will have taps for testing voltages of 100 to 1500, or more, in steps of 100 volts. The money and effort spent in constructing a good variable voltage transformer is well justified, and the outfit can

be used for many other kinds of testing.

The commutator should be tested also for shorted bars. In ordinary work, this can be done satisfactorily with a 110-volt test lamp. The trouble most generally found consists of carbon deposits on the surface of the mica slot insulation. When such a condition exists, the test current arcs across these places and makes their detection a simple matter. This test is made easier by placing the armature in an armature stand so that it can be turned freely. Mark one bar as a starting point and apply the test points to each pair of bars as the armature is turned slowly. If much of this testing is required, the construction of a bar to bar testing device, such as the one shown in Figure 2, will be justified. Such a device not only saves time but eliminates the chance of skipping a bar or two during the test.

Most shorts between commutator bars can be cleared up by cleaning the surface of the slot mica. An undercutting machine is best for this purpose, but the point of a knife, or a specially ground section of hack saw blade may be used. If the burned spot goes deep into the mica, it must be dug out, and the hole that results should be filled with some form of commutator cement. If no commercial form of commutator ce-

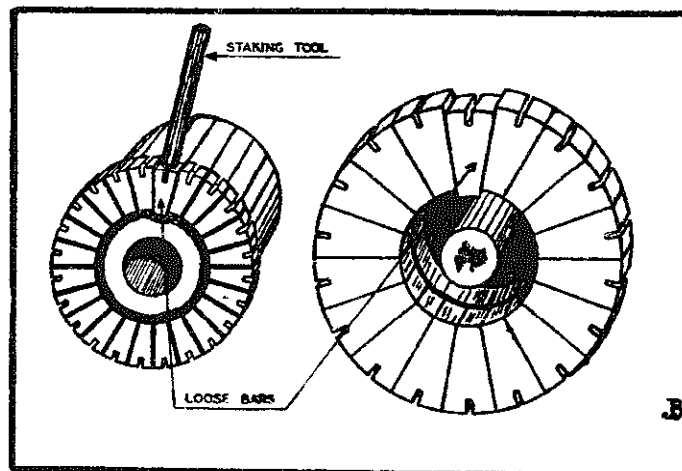

Fig. 3. Loose bars may be found in commutators that have been overheated. Test commutators mechanically before beginning the winding and avoid difficulty later

ment is available, a good substitute can be made by mixing plaster of paris and shellac into thick paste. Pack this into the pole and test again after it hardens.

Several mechanical tests should be applied to commutators before the rewinding of the armature is begun. The commutators on armatures that have been burned in ovens should be given a rigid inspection for loose bars. Loose bars in a commutator may not show up even when the commutator is stripped or dressed in the lathe, but they may become evident when "staking in" the coil leads. Gentle tapping with a light hammer will cause loose bars to shift their position. Figure 3 shows how bars may shift on both the horizontal and vertical type of commutators.

If there is any indication of looseness, the commutator should be repaired or replaced. Nothing can cause more trouble than a poor commutator. Some fractional horsepower, single-phase motors now have commutators that are insulated between the bars with a bakelite compound instead of mica. These bakelite strips frequently burn and chare when overheated and can seldom be used again. A winding is no better than its commutator and the wise winder ascertains that the commutator is in first class condition before starting the winding.

Testing Coils for Grounds

After the winding has been started, frequent tests for grounds should be made on the completed coils. Tests need not be made on each coil as it is finished but should be made on each group of four or five coils as soon as they are in place. In the case of the straight loop winding, where a continuous wire is used from start to finish, the test for a ground is made by touching the test points to the starting end and to ground. When a ground is discovered, and the test has been made on each group of coils as they were wound, the winder may assume that the ground is probably in the last few coils wound. Occasionally, the tamping down of an upper coil will result in a ground in a lower coil. The exact coil in which the fault lies may be located by cutting the loops between coils, separating the winding into sections. The section of the winding containing the ground can then be separated into individual coils and the test points may be used to locate

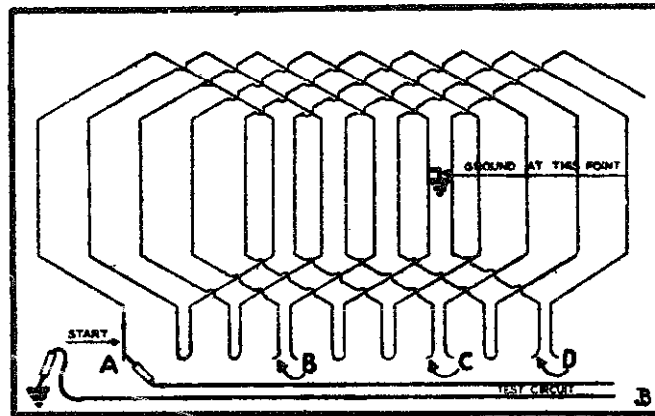

Fig. 4. A ground in a loop winding may be located by separating coils into groups as shown above. By a process of elimination, the faulty coil may be located

the faulty coil. Figure 4 shows a method of locating a ground in a loop winding.

When the armature is wound with two or more wires in hand there will be free ends projecting from the slots, and each coil may be tested at any time. It is a wise plan to wind two or three coils and then test them before proceeding with the work. The upper, or finishing leads, can be bent back over the core to get them out of the way, and the test can be made from ground to each of the projecting starting leads.

Many grounds show up only after the wedging operation. The pressure of inserting the wedge in a tightly packed slot may result in a puncture of the slot lining, especially, if no fibre end laminations or heads have been used. For this reason, the winding should be tested again for grounds after the wedging operation and before any connections are made to the commutator. This may sound like a lot of extra work but it takes only a very few minutes and may save hours of time and the vexation of having to do a large part of the work over.

Nearly every winder has a pet system of his own of connecting the coil leads to the commutator. Some winders use one method on one type of armature, and another method on another type. The leads must be connected to certain commutator bars, of course, but there are ways of handling them. Some winders con-

nect the starting leads of each coil as it is wound to the commutator. The principle advantage of this method is that the winder has no trouble whatever in distinguishing his finishing leads as they are the only ones that remain unconnected when the winding is completed. A disadvantage of this method is the covering up of starting windings. If an error has been made, it will be difficult to correct without unwinding.

Some winders use a natural winding method that leaves the starting leads at the bottom of the coil and the finishing leads on top. There is little opportunity for error in this system but there is a greater chance of trouble developing later, such as shorts and grounds. It is much more difficult to insulate leads properly that are buried deep under the winding. Other winders manage to bring out both the starting and the finishing leads of the coils in the top of the slots, even though the coils to which they belong are wound in the bottom of the slots. This is done by leaving these ends outside of the slot to which they belong until the rest of the winding for that slot is in place. These leads, the starting end of one coil and the finishing end of another, are then laid in the top of the slot.

The winder may have difficulty in recognizing start leads from finishing leads unless some sure method of

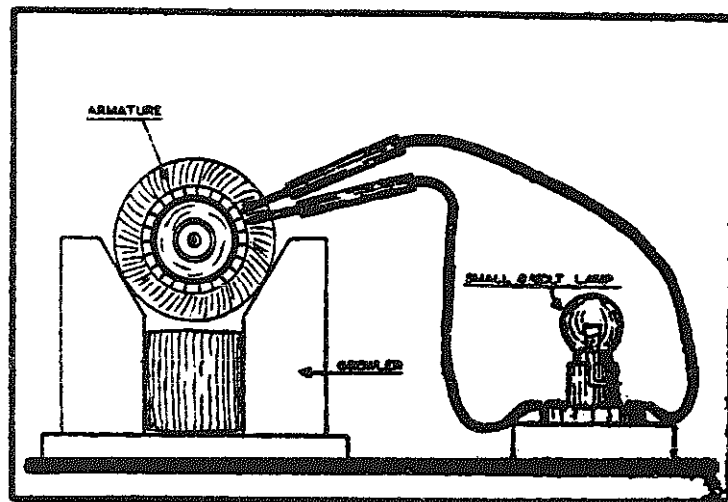

Fig. 5. A test lamp such as the one shown here provides an excellent means of locating shorts, grounds, and open circuits. Induced voltage from the growler lights the lamp . . .

identification is employed. One of the best systems of identification requires that the start and finishing leads be of unequal length. If the starting ends are clipped just long enough to reach the right commutator bars, and if the finishing leads are left at least two inches longer, mistakes are not likely to occur. When the winding consists of more than one wire in hand, which is usually the case with this type of winding, colored tracer wire will simplify connecting and will save the time of testing each circuit.

Make Coil Tests Before Soldering

Tests for shorts, grounds, and reversed connections should be made as soon as the leads are staked in the commutator slot, and before the leads are soldered. Unsoldered leads can be changed easily if a wrong connection is discovered. They can be raised if special tests should be required. All armatures can not be tested in the same way or with the same equipment. They can be given a final test for grounds, however, by applying the proper test voltage to commutator and shaft.

Armatures can be tested for short circuits in a number of ways. Direct current armatures and some a-c armatures can be tested quickly and accurately in an armature growler. Some of the a-c armatures of the repulsion-start, induction-run type have cross connections between opposite commutator bars, and can not be tested properly in a conventional type growler. There is a special form of external growler available, however, that can be used with these armatures.

Short circuited coils in armatures of the type that can be tested in the regular growler may be found by passing a hacksaw blade above the armature, while the armature is revolved slowly in the growler field. A sticking or vibrating blade indicates the presence of a short in the slot beneath. Armatures that pass this test may still have trouble in the form of an open circuit or in reversed connections.

One of the best methods of testing for open circuits in a growler is by means of a small lamp connected to two test prods. A good lamp for this purpose is a Mazda No. 63, such as is commonly used in automobile dash and tail lights. As the armature is slowly revolved in the growler, the two leads to the lamp are

placed on adjacent commutator bars at a position where the lamp will light with the greatest brilliance. After this position is once found, all bars are tested in the same position. The test points may be held still while the armature is turned. Since the potential between adjoining bars is usually low, there is no danger of burning out the lamp. As a matter of fact, the voltage that will be induced in most armature coils will light the lamp rather dimly. Poor contact between the leads and commutator bars will cause the light to burn dimly while an open circuit will give no light at all. Equipment for making such tests is shown in Fig. 5.

D-c motor and generator armatures are often tested inside their field frame if it is available. This test can be made before the commutator is soldered if the commutator leads are bound sufficiently tight to prevent them from being thrown out of place. For testing purposes it is best to energize the armature and field of either a motor or a generator with a voltage that will just cause the armature to turn. A sensitive ammeter in series with the energy supply will indicate reversed coils, shorts, open circuits by fluctuations of the ammeter pointer and by arcing at the brushes.

A compass will provide a reliable test for reverse connected armature coils. Current is applied to well separated points on the commutator as shown in Figure 6. A compass is then passed over the coil ends opposite the commutator end and the readings observed. A reversed coil will cause the compass point in a direction reversed from that observed for the properly connected coils. On small armatures, it may be necessary to test one coil at a time to get an accurate reading. This is accomplished by lifting the coil leads from commutator during the test, making certain each pair of leads are connected properly.

Cross connected a-c armatures, and others of the repulsion-induction type of motor, can be tested satisfactorily without elaborate equipment by installing the armature in the stator with the brushes removed. With the bearings properly adjusted to allow no rubbing, connect the motor to an a-c circuit and turn the armature by hand. A clear winding will allow the rotor to be turned easily while a short circuit at any

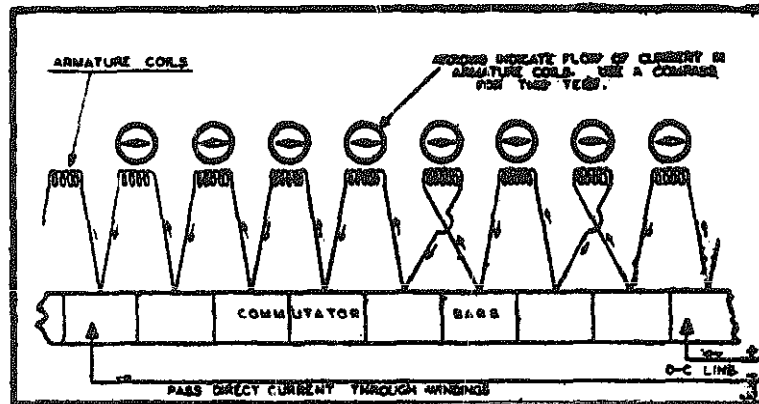

Fig. 6. A small compass may be used to check for reversed coil polarity. In the case of smaller motors, it may be necessary to lift commutator leads during the test . . .

point in the armature winding will cause the rotor to lock in one position. As stated previously, the brushes must not touch the commutator during this test.

Many short circuits, and a few grounds, that are found in rewind armatures, are caused by the soldering operation. For this reason, it is advisable to make the main test after the commutator connections have been completed and before they have been soldered. If trouble becomes apparent after the soldering job has been accomplished the winder will know that the source of the trouble is in the commutator, and not in the winding proper.

Shorts that appear in the commutator after soldering can usually be traced to three things: solder between commutator bars, solder that has flowed below the winding and shorted commutator leads, and the use of acid flux. Small particles of solder often wedge in commutator slots and complete an electrical path between bars. These will sometimes burn out in the growler test, but if not, they can be located by using the method shown in Figure 5. Test from bar to bar and the trouble will be located between bars that do not cause the lamp to light. Surplus solder that has found its way below the winding and caused a short can be located in the same manner. If an acid flux is used in the soldering, the surplus acid will sometimes soak into the insulation and cause shorts or leaks. The pos-

sibility of this kind of trouble should be avoided by using a rosin flux.

If the job is worth doing, it is worth doing right. Frequent tests while the work is in progress will result in better work and will eliminate the need for patch work on mistakes made during the earlier stages of the winding.

Chapter 5

Equipment for Testing Stators and Its Application

THIS article describes the methods used in testing the various types of stators for the many faults or defects that may occur during the re-winding operation. The majority of jobs coming to the small motor shop consist of the small single-phase motors, and many of the tests mentioned here will seldom be used on that class of winding. However, a certain percentage of the business will include other types of motors and it is well to have the proper equipment and knowledge of testing methods available for this out of the ordinary class of work.

The winder with some experience on the fractional horsepower motors such as are used in refrigeration soon arrives at the point where he needs to give but little time or thought to testing his work. A ground test and a check up on the polarity of his coils is usually sufficient. Practice makes for perfection and he seldom has trouble with this familiar type of work.

Different conditions may exist, however, when he obtains an unusual job, a motor of a type which he has perhaps never seen before. Doing a good winding job on simple single-phase motors is one thing; doing a satisfactory job on a large polyphase motor is something else again. The first may demand only a small amount of mental alertness; but the second will require that he keep his wits about him. There may be but a slight chance for error in the first job, but there are plenty of possibilities for mistakes on the latter. And when a mistake is made, it is an advantage to know reliable testing methods.

A rewind stator should be tested twice if possible; first, by routine tests before the dipping and baking and, afterwards, by giving the motor a test run. The latter test will show up almost any defect, but because of the lack of the proper power supply, absence of essential motor parts or other reasons, it is not always

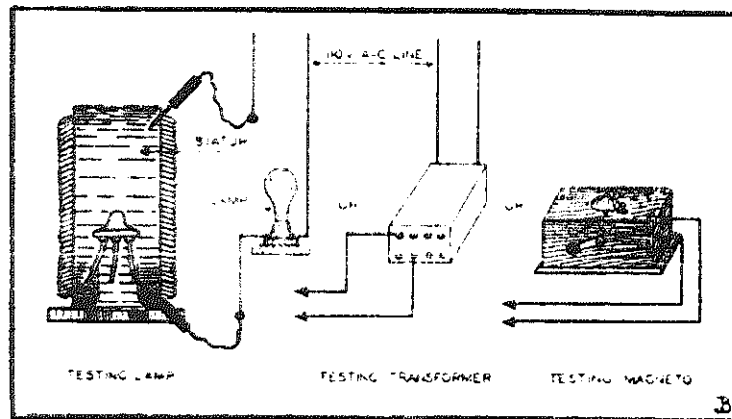

Fig. 1. Rewound stator windings should be given a thorough test for grounds. A lamp test followed by a magneto or high voltage transformer test gives assurance of clear coils

possible to conduct the test run in the winding shop. It is in such cases that the routine method of testing proves most advantageous.

The first of the important routine tests comes just after the winding has been connected, and at this point the necessity of making an accurate diagram of the connections of the original winding is fully realized. Any winder who assumes a stator winding job on a motor of a type with which he is not thoroughly familiar stands to lose a lot of his time and waste a lot of good material unless an accurate and complete diagram is prepared of the original winding. The preparation of such a diagram may be considered as one of the most important parts of the job.

After the stator has been wound and connected the entire job should be rechecked against the diagram. In some of the larger shops this checking is done by the foreman or head winder. In any case, the check up on the connections should be done by some competent person other than the original winder himself if this is possible. Given a correct diagram to start with and a systematic inspection, no errors in connections should go beyond this step.

In the smaller single-phase motors, testing rarely includes more than checking for grounds and polarity. In winding the stators of two- and three-phase mo-

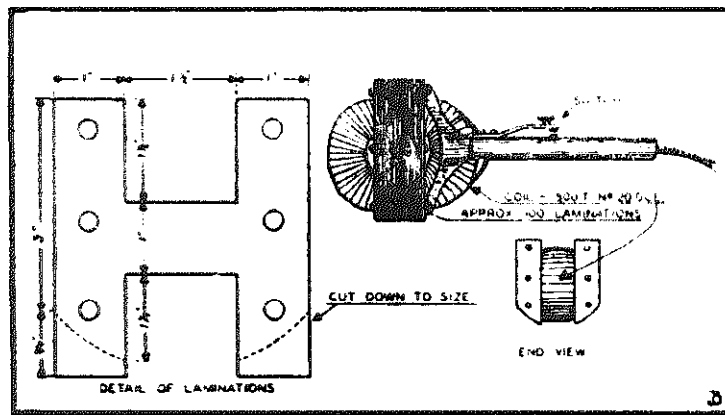

Fig. 2. Short circuits in stator windings may be located easily with an internal growler. This diagram gives construction details for a 110-volt, 60-cycle, a-c growler

tors, however, several other factors must be given consideration. Stators for motors of this type should not only be rigidly tested for grounds and polarity, but they should be carefully tested for short circuits and for balance between phases. Detailed explanations of these tests follow.

Grounds in stator windings may be located successfully by several methods, such as with a test lamp, with a bell ringing magneto made for the purpose or with a step-up testing transformer. Probably the best method is to combine the first with one of the others. Figure 1 indicates this clearly. The simple test lamp connected to the light socket will indicate at once any low resistance ground. If the lamp test indicates that the winding is clear, it should then be subjected to a more rigid test with a higher voltage. The value of this test voltage will depend upon a number of factors, such as the working voltage of the motor, the type of insulation used and the kind of service the motor will be called upon to render. Motors operating in damp or wet places and motors subject to high temperatures and continuous duty will need better insulation than motors used intermittently under more ideal conditions.

No simple rule can be given for determining the test voltage to be applied to stators, but in general it

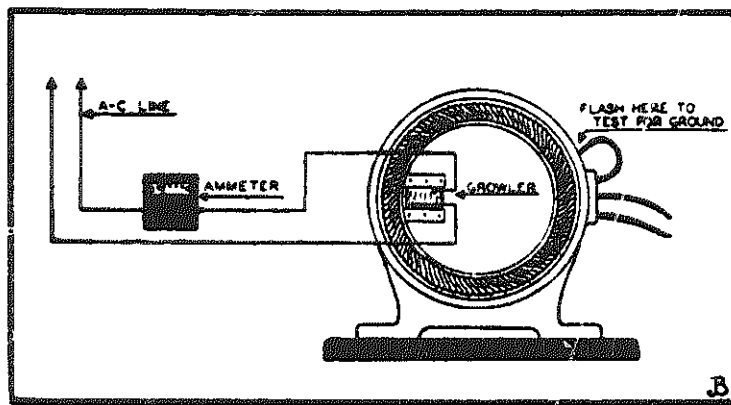

Fig. 3. The growler, in conjunction with an ammeter, can be used to locate either grounds or short circuits in stator windings. Grounds may also be located by the flash test.

from at least two to three times the value of the normal operating voltage. As mentioned before, the higher voltages for making these tests can be obtained from a step-up transformer such as is used for armature testing, or from a hand operated magneto. The transformer method is more reliable since the voltage may be applied in known values, while the magneto voltage varies with the speed at which the crank is turned.

When testing a single phase stator for grounds, each circuit should be tested separately if the stator is one of the type wound for use on 110-220 or other paired voltages. The test is from one lead of a circuit to a bare metal ground on the stator frame. Since all three phases in a three phase stator are internally connected it is only necessary to test from any one of the three terminals to ground. The same rule applies in testing a two-phase stator of the three wire type, but in a four-wire two-phase stator there are two independent circuits and each must be tested individually.

After successfully passing the ground test the stator should be checked for short circuits in the winding. This is best done by means of an internal growler, a piece of testing equipment that serves the same purpose for a stator as the regular growler does for an armature. Instead of moving the winding through the growler field, as is done with an armature on a

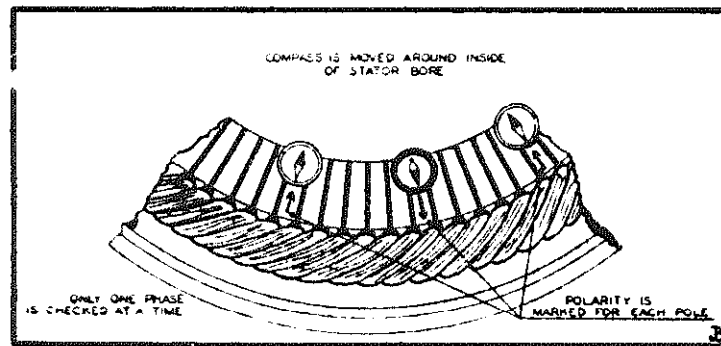

Fig. 4. A pocket compass is useful in checking the polarity of a phase winding. The test must be made with a d-c voltage applied to the winding

regular growler, the winding of the stator remains stationary and the internal growler is moved from place to place.

Many service men have only a hazy idea of the working theory of the growler, and hence a brief description may be of some benefit. Almost everyone who has worked with electricity to any extent understands the operation of a transformer. We know that when alternating (or intermittent) current is passed through a coil of wire wound around an iron core that this core becomes magnetized. We also know that when a second coil is placed in the magnetic field thus created, but electrically insulated from the first coil, a voltage is induced in its winding which is directly proportional to the voltage in the first coil and the ratio between the number of turns in the two coils. The coil to which the voltage is supplied is referred to as the primary coil, and the coil in which the voltage is induced is called the secondary coil.

Growlers operate on the same principle. The growler proper consists of the core and a primary winding, and the stator coils under test comprise the secondary. Thus when the growler is in actual use it is nothing more than a transformer. To explain how a growler indicates a short in the stator windings, we may conveniently refer to the action of a typical transformer under different conditions.

If we take a suitable transformer and connect the

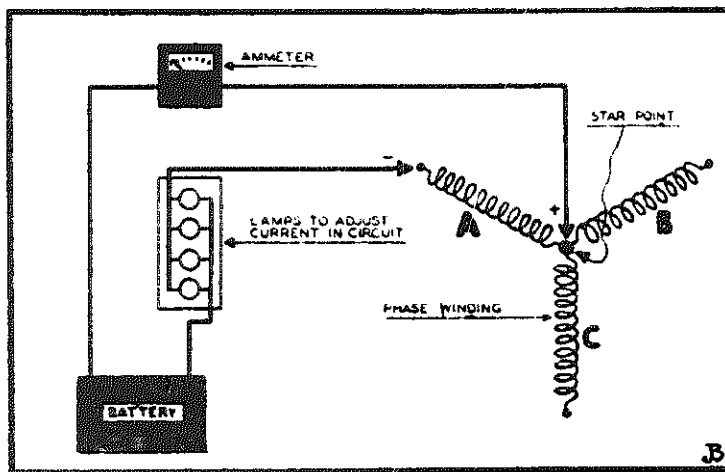

Fig. 5. In testing a three-phase star winding for polarity, one of the d-c test lines must be connected at the junction of all three phases and the other to the phase under test.

primary winding to an a-c supply source, leaving the secondary terminals unconnected, we will find that the flow of current through the primary is almost negligible. In this case the core becomes saturated magnetically which tends to retard the flow of current in the primary winding except such as required to establish the magnetic field. However, if we connect the secondary winding terminals to some form of load we find that there is an immediate increase in the current drawn by the primary. The current in the primary winding will depend upon the current supplied from the secondary. When the section of the stator winding under the growler contains a short circuited coil, the primary current reaches a maximum value. On the other hand, when the internal growler is held over stator coils that are free of shorts, there is no circuit in the secondary, and the current in the growler primary is a minimum. These facts are used to good advantage when testing for shorts.

Figure 2 gives the details for constructing an internal growler suitable for stator testing on a wide variety of motor sizes. The preparation of the laminated core is the only difficult part of the job and this will be simplified if the core from an old transformer of the right kind is available. The core should be H shaped, with the coil wound in the center. The bot-

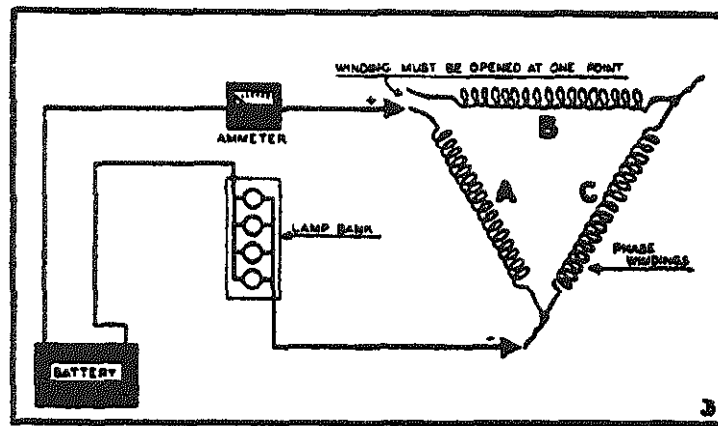

Fig. 6. This diagram shows the proper connections for making a polarity test on a three-phase delta connected stator. The winding must be disconnected at one point as shown.

tom legs of the core should be rounded so as to fit the inside bore of the stators. Laminations of a larger size can be trimmed down to fit with a pair of tin shears. The core should be firmly bolted or riveted together with provision for some form of a handle. A thumb switch on the handle will greatly facilitate the use of an internal growler.

With the aid of this growler, shorts can be detected in several ways. One method is to use a hacksaw blade to "feel out" the winding one coil pitch in advance of the growler's position. If the blade tends to stick or vibrate, the short will be located under the surface at that point. Another method that gives very good results is to cut an a-c ammeter into the primary circuit of the growler. In a clear winding there will be but little current flowing in the primary and the ammeter will give a low reading. However, as soon as the growler is located over a coil containing a short circuit, the current flow in the primary will increase. The current indicated by the ammeter will depend upon the resistance of the short circuit. Figure 3 shows a circuit diagram of a short circuit testing device of this kind.

The internal growler has still another use: it can also be used for locating grounds. The growler is moved about inside the stator and at each position one lead from each of the stator circuits is flashed

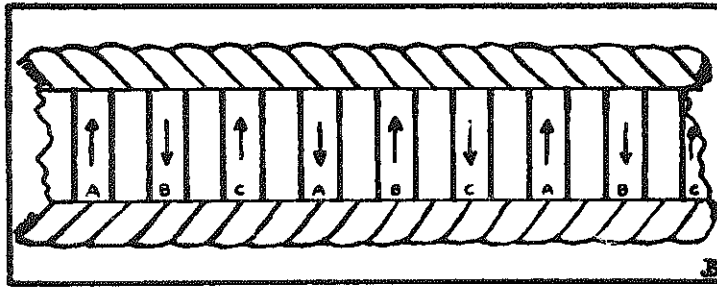

Fig. 7. A three-phase winding is projected on a plane surface here to show the results of a polarity check obtained with a compass. The phases are indicated as "a", "b", and "c."

back and forth against the bare metal of the stator core. If a spark is produced from any of the leads it indicates a ground in that circuit. When an ammeter is connected in the growler primary it will also indicate the presence of a ground under the same circumstances. This method of testing for grounds is shown in Figure 3.

Occasionally a mistake is made in connecting the stator coils in polyphase motors. Such errors can be found easily with simple testing equipment and a little patience. One method makes use of a polarity test which requires a source of low voltage d-c current, an ammeter, several lamps of the proper voltage and a small pocket compass. The testing current in amperes should be about 5% of the full load rating of the motor through one phase of the stator winding. A 6-volt auto battery will supply ample current for all ordinary testing, and one or more 6-volt lamps in series-parallel with the line will limit the flow to the desired value. An ammeter in the circuit serves as a check upon the current passing through the winding.

In testing a polyphase stator winding for polarity, only one phase is tested at a time. The test leads are connected to the terminals of the winding and the compass is passed around the inside of the stator. As the compass passes the center of each "live" pole the needle will be deflected toward the pole center and the compass will indicate whether the pole is a "north" or a "south." Poles giving a "north" indication are marked with crayon in the form of an arrow pointing

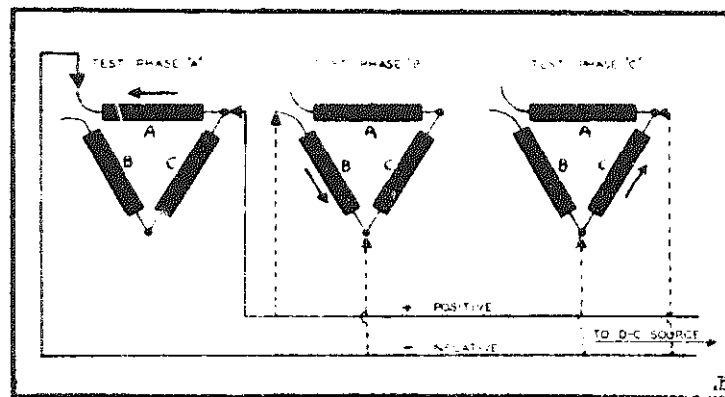

Fig. 8. In testing a delta connected winding, each phase must be checked with the current flowing in the same direction. The proper battery connections are shown above.

toward the operator. Those giving a "south" indication are marked with an arrow pointing away from the operator. As soon as one phase has been tested the test leads are moved to the next phase and the same test and markings are repeated. Figure 4 shows a close-up of the method of testing and marking the stator.

In testing a three-phase star connected winding, one of the d-c test lines must be attached to the star point, or center junction of the three phases. The other test lead is alternately connected to phase leads A, B and C. This is shown by the diagram in Figure 5. The test connections for making a polarity check on a three-phase delta connected stator are shown in Figure 6. If the stator core could be split and rolled out flat at the end of the test the markings would appear as those shown in Figure 7. It will be noted that all poles of a phase alternate north and south, as do adjoining poles regardless of their phase connection.

The compass method of checking the polarity of stator windings is nearly fool proof except for having the proper test line connections to the battery supplying the testing current. If the battery lines are switched it will change the compass readings. Therefore all phases of a stator winding should always be tested with the current flowing in the same direction. An ammeter in the test circuit helps to keep a close

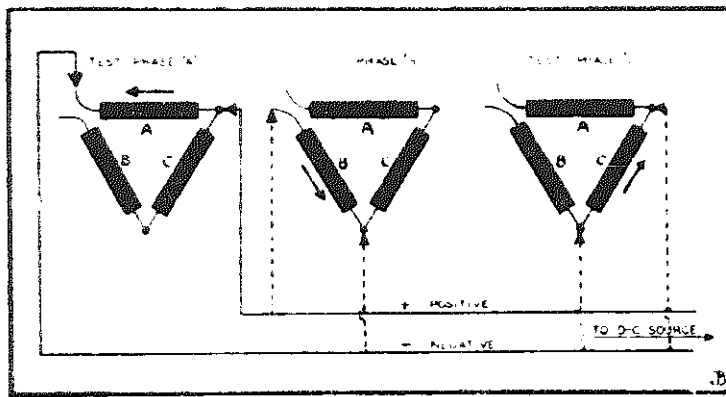

Fig. 8. In testing a delta connected winding, each phase must be checked with the current flowing in the same direction. The proper battery connections are shown above.

check on possible mistakes of this kind, as the meter reading will be reversed if the leads are changed.

In testing a star connected winding for polarity, place the negative battery lead to the star point, and use the positive lead to connect to the three phase leads in turn. There is a slight chance for a mistake if this is done on this type of connection, but with delta connected stators both battery leads must be changed for each phase test and the chance for error is correspondingly greater. Because a delta connected winding forms a closed circuit between any two phases in order to obtain a correct test. Figure 8 shows the method of testing individual phases on a delta winding.

The last of the important tests to be mentioned here is the phase-balance test. The test consists of measuring the flow of current established by a known voltage and frequency through each of the phase windings with an accurate ammeter. The current established in all phases should be equal. The current used for the test should be substantially less than the normal operating current; about 25% of the normal rating is satisfactory but the frequency should be that for which the motor is rated. This adjustment in current flow requires the use of a transformer of the proper rating.

Figure 9 shows the arrangement of the circuit for testing current flow by phases in a star connected

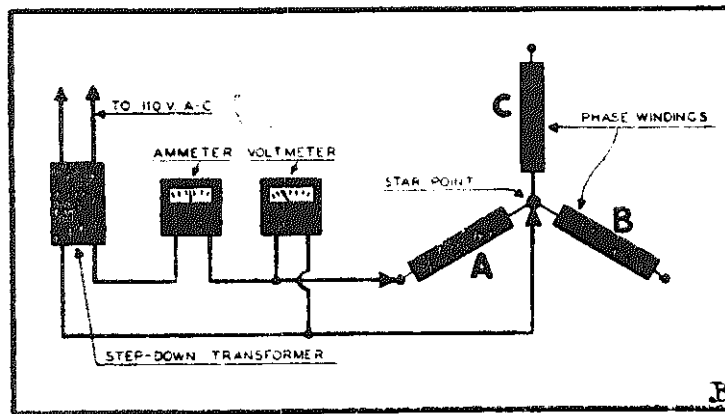

Fig. 9. An important test on every three-phase stator is the phase balance test. In this test, a known voltage is applied to each phase winding and the current measured . . .

winding. The ammeter, and preferably a voltmeter also, is placed in the test circuit to obtain direct readings. As with the polarity test the star point forms one testing point for all three phases while the other test lead is connected to the three phase leads in succession.

No diagram is shown for balance testing a delta connected stator winding but a study of Figure 6 will indicate the proper method. As with the polarity test, the winding must be opened between two phases so that the testing current will flow through only one winding at a time. If the balance test show that the current flow is unequal in the different phases it is an indication that there is an error in the winding or in the connections. Such errors may be of the nature of reverse connected coils or groups, short circuits, unequal number of coils in phases, open circuits, or grounds.

Chapter 6

General Classification of A-C Motors

THE primary classification of alternating current motors consists of two divisions: Single-phase and polyphase. These names are self explanatory to those who have some knowledge of motor windings. A single-phase motor is one in which the winding consists of a single set of coils, so connected that they generate a single wave of alternating magnetomotive force.

A polyphase motor, on the other hand, has two or more phase windings which are so distributed or connected that two or more waves of alternating magnetomotive force, different in phase, are produced at the same time. Thus a two-phase motor has two phase windings so distributed around the field that the result is two separate magnetomotive force waves which are 90 electrical degrees apart, the waves of which are spaced 120 electrical degrees apart.

Manufactured mostly in the fractional horsepower sizes, the single-phase motor has the widest use of any electric motor. This comes about partly because the majority of them are in service in homes, offices and stores where the only source of current supply comes from the lighting circuit. Single-phase motors of various kinds are made in larger sizes to meet special conditions, but their use cannot be said to be general.

Single-phase motors can be classified, according to the principle of operation, into five general types: Repulsion, Induction, Series, Capacitor and Synchronous. There are subdivisions to some of these types, and in some cases, overlapping features. Each type or characteristic will be considered in order. It should be noted here that single-phase motors of the induction types are not inherently self-starting, thus needing some form of auxiliary winding to bring the rotor up to speed. The two most commonly used methods of starting single-phase induction motors are by split-phase, and by repulsion.

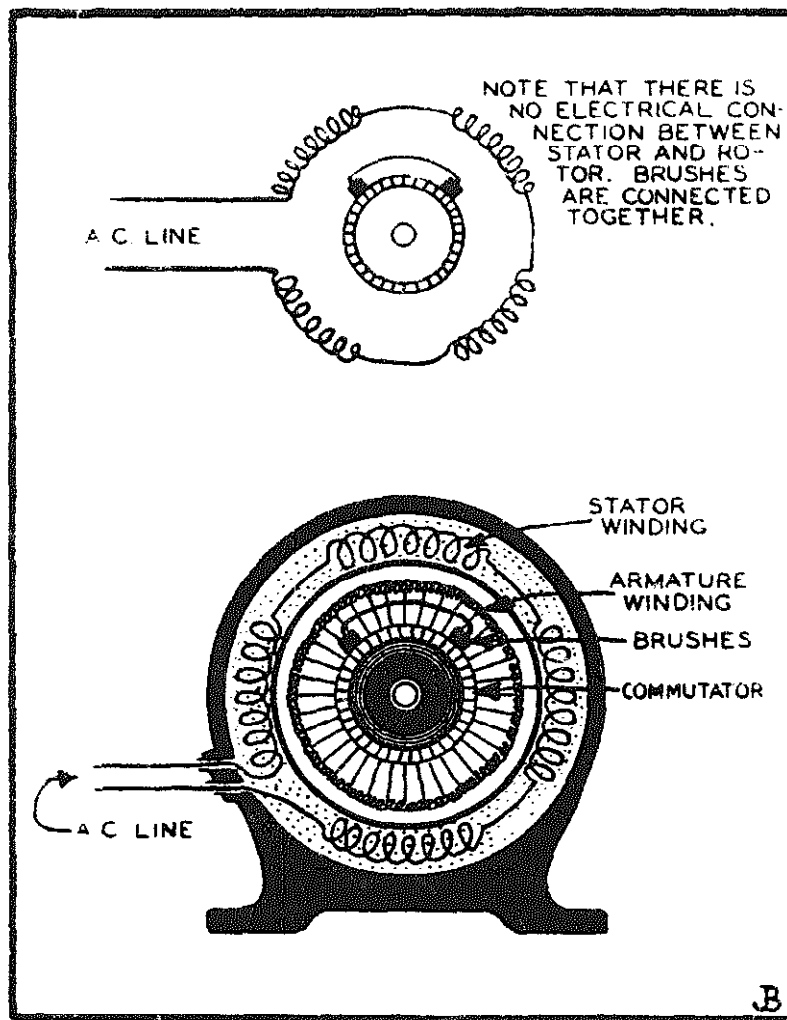

Fig. 1. Diagram of straight repulsion motor circuits

Single-phase straight repulsion motors enjoy a very limited use, and are not to be confused with the more popular repulsion-start, induction-run type, more popularly known as "repulsion-induction." Straight repulsion motors employ a running winding wound on the stator, and a wound rotor of conventional type. There is no electrical connection between the armature winding and the stator winding. Current is induced into the armature winding from the transformer action of the line supplied running winding. The brushes used in a motor of this type are short circuited together, and placed in such a position as to cause the induced current of the armature to create the torque necessary to run the motor.

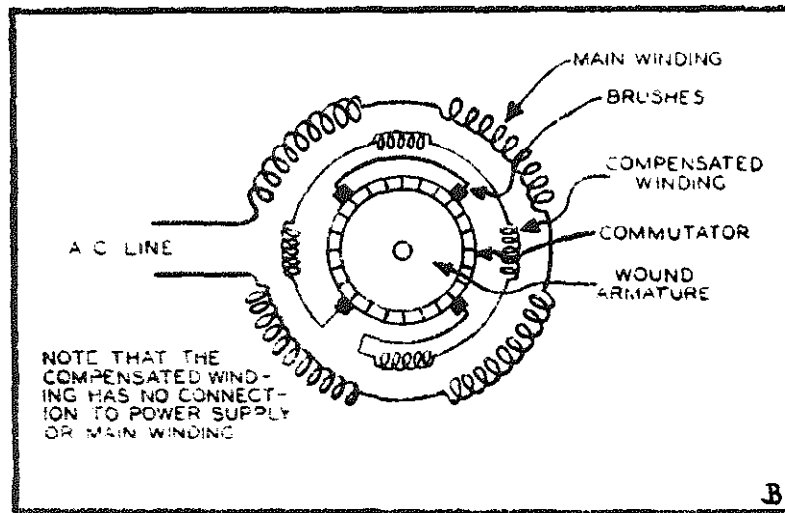

Fig. 2. Schematic diagram of a compensated repulsion motor

Changing the direction of rotation of these motors is accomplished by moving the brushes to a point either side of the neutral position. See Fig. 1.

Single-phase straight repulsion motors have been manufactured which make use of a third winding, and which are known as compensated repulsion motors. In addition to the running winding and the winding on the armature or rotor, there is another winding incorporated in the field ring and which is connected to the commutator of the armature by means of brushes. The compensating winding has no connection to the running winding or to the power supply. The object of the compensating winding is to reduce sparking at the brushes on the one hand and to increase the power factor on the other. A schematic diagram of such a motor is shown in Fig. 2.

The repulsion-start, induction-run motor is one of the three leading types of fractional horse power motors in use, and its name comes as a result of its operating characteristics. Like the straight repulsion motor this type has a running winding and a wound rotor. The winding on the rotor, or armature, however in this case, can be considered as an auxiliary winding as it is used in starting only, and its sole function is to supply the torque essential to bring the motor up to the lower limits of a normal running speed.

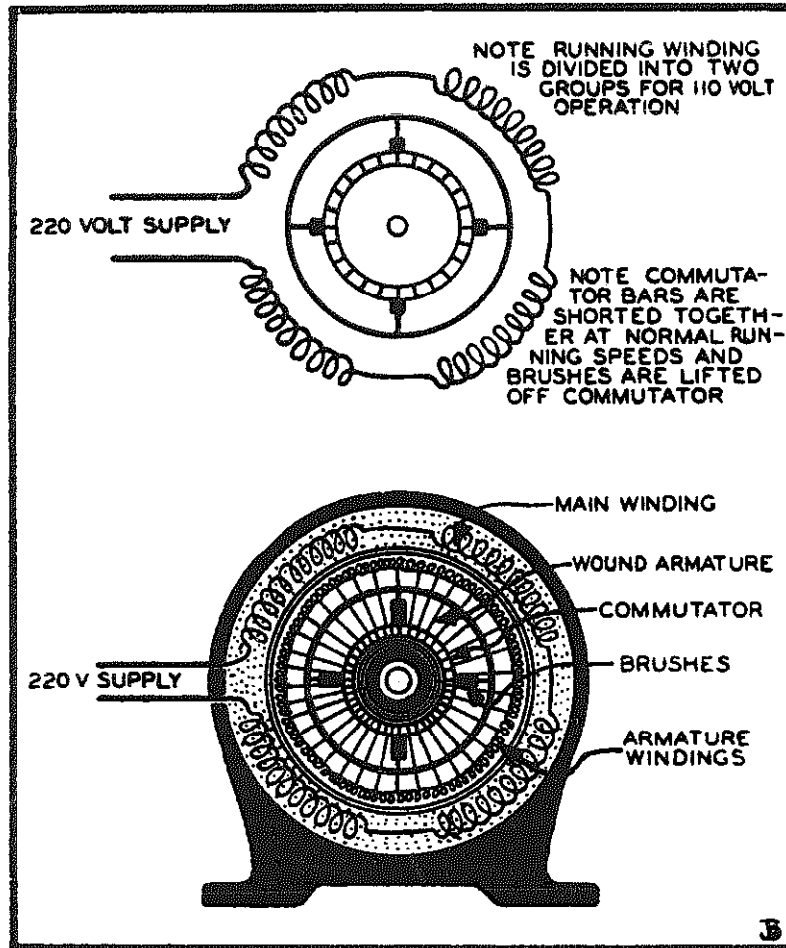

Fig. 3. Circuits of a repulsion-start, induction-run motor

When starting, a motor of this type operates as straight repulsion motor. As soon as sufficient speed is attained to cause the motor to produce the torque needed to run as a straight induction motor, the armature windings are short-circuited together with the result that at normal speeds the rotor functions the same as the squirrel-cage rotor of a plain induction motor. The method of short-circuiting the armature windings in a repulsion-start, induction-run motor is actuated by centrifugal weights, and on many motors of this general type the same device that shorts the commutator segments also lifts the brushes from the commutator. This not only prevents useless wear on the brushes, but tends to reduce minor sparking caused by incomplete shorting

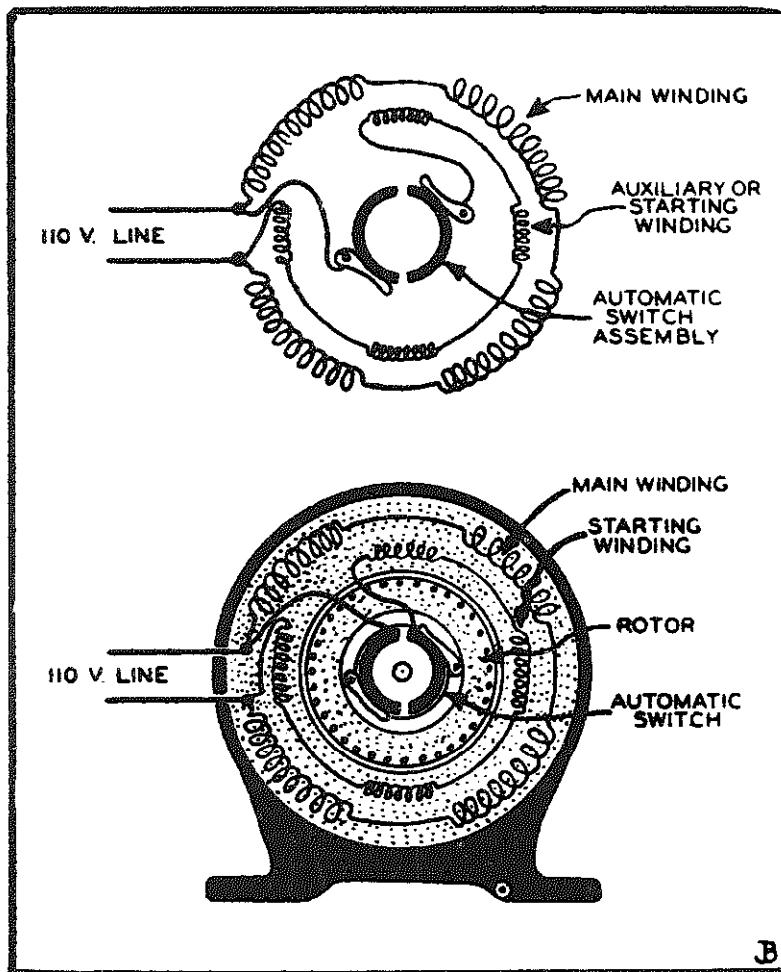

Fig. 4. Circuit of a split-phase alternating current motor

of the armature windings and radio interference. A wiring diagram showing the connections of a repulsion-start, induction-run motor is shown in Fig. 3.

The split-phase motor is another popular type, the use of which is generally confined to the operation of small machinery where the starting torque is not too high. A motor of this type employs two windings, both wound on the stator, a main running winding, and an auxiliary or starting winding. The rotor is of the solid, squirrel-cage type. A simple centrifugal switch disconnects the starting winding from the line as soon as the speed necessary to operate as a plain induction motor is reached.

The main winding of the split-phase motor is arranged in pole groups as is usually found in other

single-phase machines. The starting winding is wound in coils above and *between* the main winding coils, the reason being that these starting coils will set up a rotating field a certain number of slots distant from the effect of the main coils, and cause the rotor to revolve. The starting winding is of no further use as soon as the rotor attains a normal running speed, hence the automatic switch cuts it from the line, conserving current and preventing the high resistance starting winding from over heating and burning out. Fig. 4 shows the circuits of a motor of this type.

Single-phase alternating-current motors of the series types are more often called universal motors, in as much as most of them are built to operate on a-c or d-c current of like voltage. In general these motors are of miniature size and find a rather wide use in fans, carpet sweepers, drink mixers, juice extractors, sewing machine motors and for similar tasks where the duty is intermittent and first cost an important consideration.

Series motors have a field—usually two pole—that is wound like the coils in a straight d-c machine. The armature is wound like a d-c armature and is in series with the field. Motors of this kind are finding less favor than formerly due to the fact that they cause more or less interference with radio reception. The judicious use of by-pass condensers will, however, quiet most of these motors. The simple circuit diagram of the series motor is shown in Fig. 5.

The capacitor, or condenser motor, has moved rapidly to the front, especially in the field of electric refrigeration, because of its greater power factor, efficiency and economy of operation, over other types of single-phase motors. As in the split-phase motor, the capacitor motor has two windings. The main, or running winding, is conventional in design and with the motor in operation, is connected across the line. The starting winding is approximately 90 electrical degrees from the main winding, and is connected at one end to the line, while the other terminal ends on one post of the running condenser. The capacitor motor has been designed in several ways, for experi-

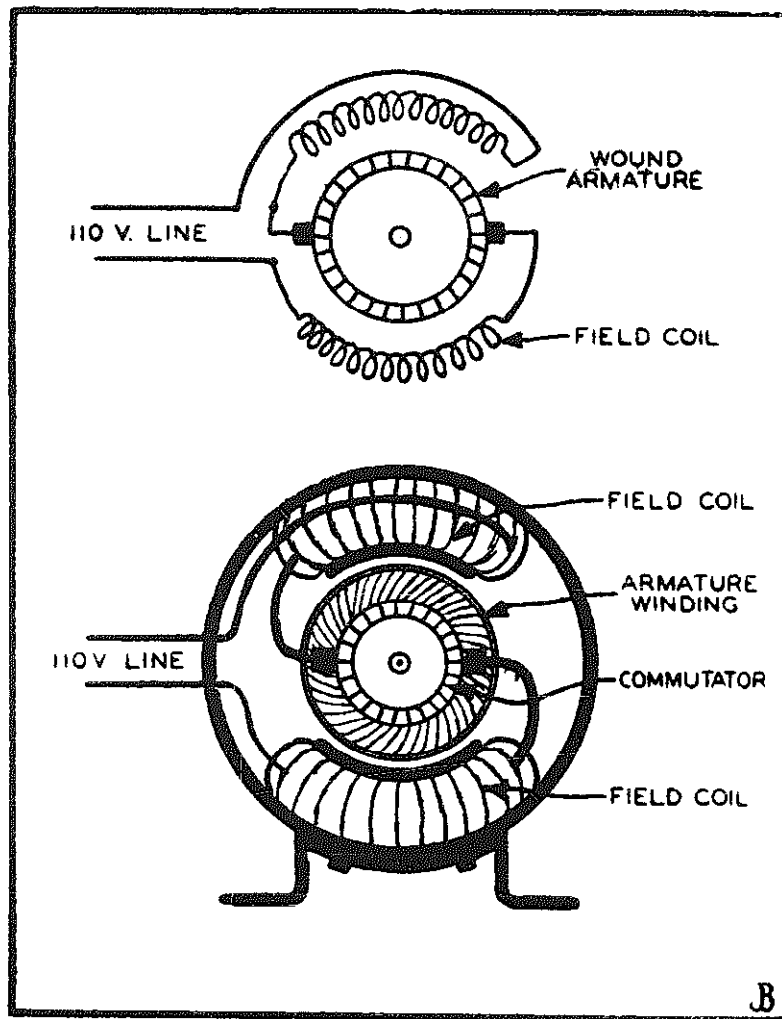

Fig. 5. Wiring diagram of a single-phase motor of the series or universal type

mental purposes and otherwise, but the circuit diagram shown in Fig. 6 may be considered typical of the principle in general use.

In this case we find that the condenser is in reality two condensers, a running condenser and a starting condenser, both of which are incorporated in a metal container outside of the motor. The starting condenser as the name implies, is brought into use while the motor is starting, and is connected on one side to the line, and on the other to the starting winding. A centrifugal switch on the rotor disconnects the starting condenser as soon as the proper speed is obtained. Capacitor motors cause no interference with radio reception.

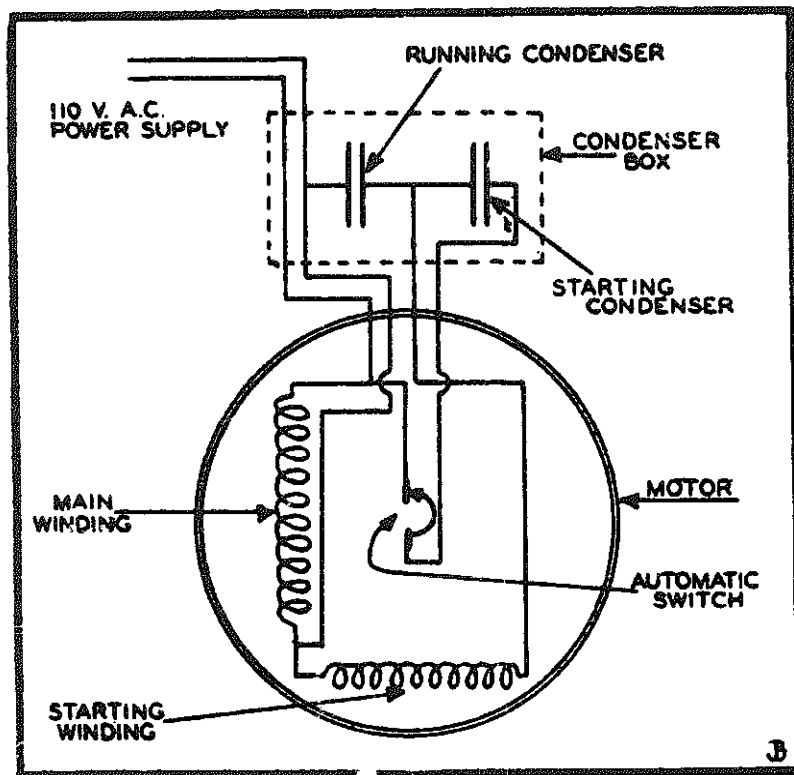

Fig. 6. Theoretical diagram of one form of capacitor motor

The synchronous alternating-current motor has a use in certain industrial fields where constant speed is of prime importance, but it finds no place in domestic or ordinary applications. Aside from the large industrial centers few service men will ever be called upon to repair motors of this type.

Polyphase motors comprise the second group of alternating-current motors. Two and three-phase induction motors have their windings so connected and placed as to make use of polyphase electrical energy. These windings are placed in the stator, while the rotor, which in reality is the "field" of the machine, is not connected to any source of electrical energy. The rotor is excited by the induction set up by the stator windings. Polyphase motors of the induction type have their greatest torque at the instant power is applied, and before the rotor starts to run. Therefore, and unlike the single-phase induction motor, the polyphase induction motors are entirely self-

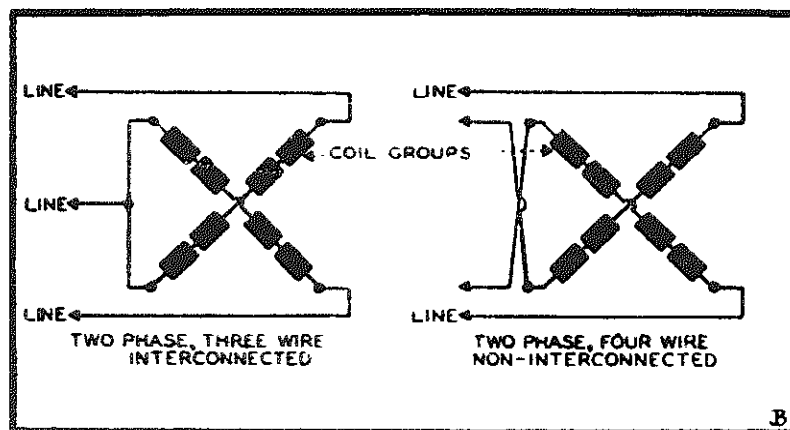

Fig. 7. Diagrammatic circuits of two-phase motors

starting without the aid of auxiliary windings or other devices.

Most two-phase motors can be recognized by observing the number of line terminals, which will be four in number. These are often called two-phase, 4 wire motors, a fact which denotes that the windings are not interconnected. A few interconnected two-phase motors, known as two-phase, 3 wire machines, are in use and have three line terminals the same as three-phase motors. The diagram at Figure 7 shows the circuits of both types.

Three-phase motors have their phase windings arranged in a great variety of circuits depending on the manner of interconnecting the phases, number of poles, number of paths and other considerations. Motors of this type have their windings classified into two groups according to the method of interconnecting the phase windings, as Star connected, or Delta connected. Figure 8 gives a theoretical diagram of each of these types.

From the diagram it will readily be seen that in the star form of winding the ends of each phase winding are connected together at a central point, more often called the "start point." The other, or leading ends, of each phase are connected to the line terminals.

In the delta connected winding we see that each end of a phase-winding is connected to the end of another phase winding, so that the three phase windings form the shape of a triangle.

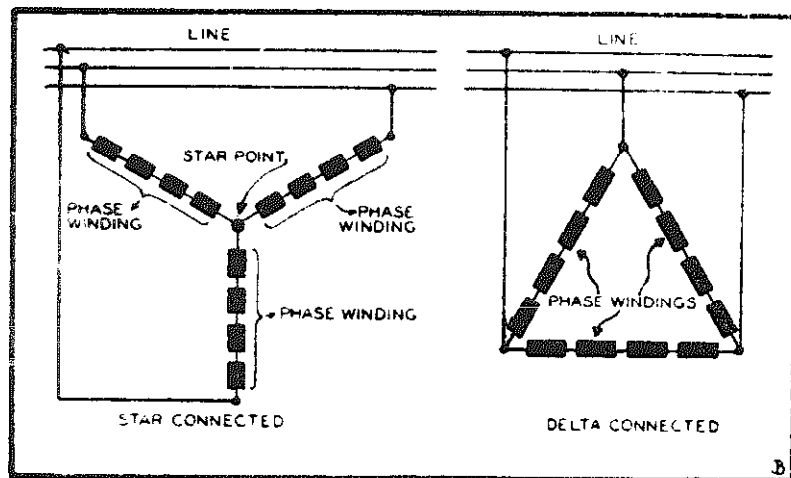

Fig. 8. Three-phase motor circuit types

Other terms used in connection with the windings of three-phase motors might be of interest to those not well posted on the subject. When a three-phase motor is designated as "2 pole", "4 pole", "6 pole", etc., it does not refer to the total number of poles in the motor, but only to the number of poles comprising one of the phase windings. Thus a three-phase, 2 pole motor winding will have 6 poles, two for each of the three phases. In the same way a three-phase, 3 pole winding will have a total of 24 poles for the three phase groups.

The term "1 path", "2 path", "4 path", etc., refers to the number of current paths through each of the phase windings. This will perhaps be better understood by consulting Figure 9. It should be noted that these schematic drawings show only the electrical circuits and connections of the motor windings, and not the relative positions of the coil groups in the stator. In practice a coil belonging to one phase group is followed by a coil of the second phase group, and that in turn by a coil of the third phase group, and this order is repeated around the stator. A diagram of the actual arrangement of the phase groups for a three-phase, 6 pole, 3 path, star winding is shown in Figure 10.

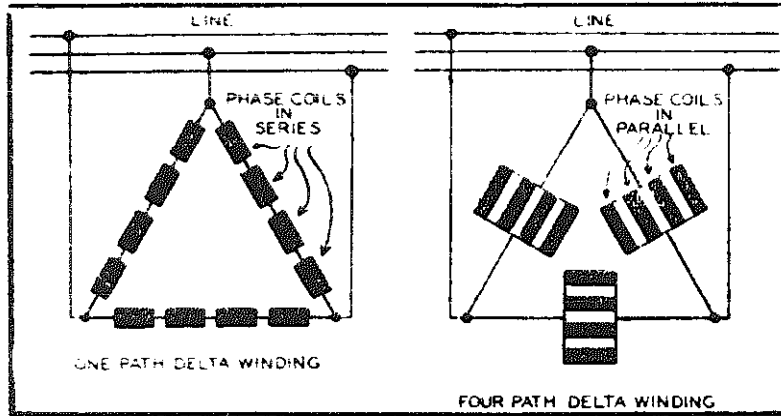

Fig. 9. A single path and a four path delta winding

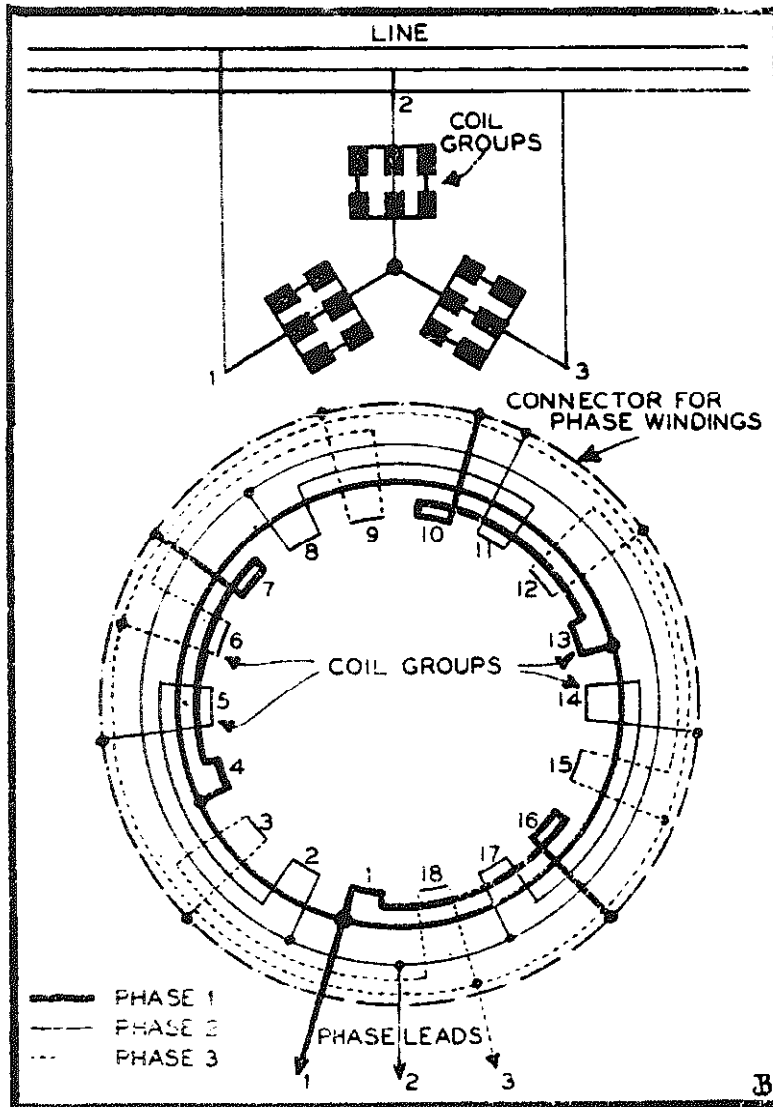

Fig. 10. Circuit diagram of a 3-phase, 6 pole, 3 path, star winding

Chapter 7

Split-Loop Armature Winding

THE several types of split-loop windings have certain advantages over the regular plain loop winding discussed in the previous article. Some of the advantages of the split-loop winding are that it aids in giving better space distribution across the ends of the winding, and that it gives a more even mechanical and electrical balance. The latter is especially true in the case of the parallel wound type of split-loop winding.

Here we find that the coils are wound in pairs, parallel to each other and one on each side of the shaft. Consequently each pair of coils that are parallel to each other are of the same length, and hence will be of the same weight and electrical resistance. In the plain loop winding each one of the coils will be slightly different in these respects while in the split-parallel-loop winding the number of unlike coils is reduced by one half. Another advantage of this type of winding is that it can be wound with more than one wire in hand if required. The only valid objections to this type of winding can be summed up by saying that it is slightly harder to connect up, that it is easier to make mistakes than in the plain loop winding, and that the wires must be cut at the completion of each coil.

The different types of windings discussed here are all chorded. By "chorded" is meant that the coils are wound less than full pitch. If an armature has, for instance, 14 slots, the full pitch for a two pole machine would be in slots 1 and 8, those diametrically opposite each other. When the windings are placed less than full pitch, as in slots 1 and 6, or 1 and 7, the winding spans less than the full distance between pole centers and is called a chorded winding.

Figure 2 shows the method of starting and finishing a parallel split-loop winding. Arbitrarily, an armature having 14 slots has been chosen for purposes of explanation, but any armature with an even num-

ber of slots can be wound in the same general manner. The first coil is started in the slot selected as number 1 and comes back in slot 7, then back through slot 1 and so on around until the correct number of turns have been placed. The wire is now cut at the commutator end, leaving ample length to reach the proper commutator bar with an inch or two left over. A piece of white sleeving should now be slipped over the starting end of the coil while a piece of red sleeving is placed around the finishing end. This method of marking is followed on each coil as it is completed so that all starting ends and all finishing ends will be color coded the same.

When the first coil is completed the armature is turned one half way around so as to be in position to receive the second coil. An inspection of the diagram will show that the second coil goes into slot 8 and 14. A white and a red sleeve are slipped over the starting and the finishing ends of the second coil. The armature is now again turned until slot 3 is in the top position. The third coil is found in slots 3 and 9, and the parallel coil in slots 10 and 2, starting in slot 10 and finishing in slot 2. The fifth coil is started in slot 5 and finishes in slot 11, while its companion coil, No. 6, starts in slot 12 and ends in slot 4.

We have now arrived at a point where all the slots hold one coil side except slots 6 and 13 which are still vacant. These slots are opposite each other and can not hold sides of the same coil, hence it is at this point where we must start to overlap and start the second layer. Coil 7 starts in slot 7 on top of the first coil laid (No. 1) and ends in the otherwise vacant slot No. 13. Moving over to slot 14 we start the 8th coil in top of coil No. 2 and finish it in slot 6 which was heretofore vacant. The rest of the coils forming the top layer are now wound in the following order: Coil 9 starts in slot 9 and finishes in slot 1, coil 10 starts in slot 2 and finishes in slot 8, coil 11 starts in slot 11 and finishes in slot 3, coil 12 starts in slot 4 and finishes in slot 10, coil 13 starts in slot 13 and finishes in slot 5, coil 14 starts in slot 6 and ends in slot 12.

In the type of winding under consideration at this

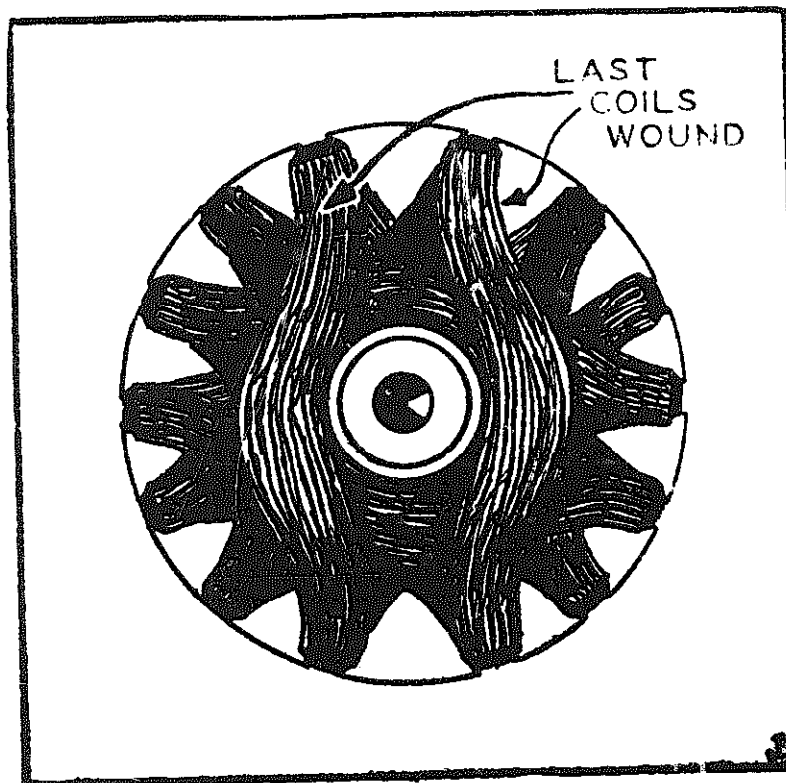

Fig. 1. End view of a parallel-split loop winding

point there is a slight difference in the arrangement of the coils depending upon the fact of whether or not the number of armature slots is divisible by 2 or 4. Rather than take up time and space by going into details of the two variations it has been thought better to condense such information into a table giving the winding data for armatures having from 10 to 24 slots. This winding chart is shown as Figure 3.

Another form of the chorded split-loop winding, employed mainly on small two pole motor armatures, is what might be called a divided split-pitch loop winding. This form of winding differs from the one just considered in that two full coils are wound in but three slots. As will be seen in the typical example of this type of winding shown in Figure 4, two coil sides are wound in slot No. 1 with the remaining sides of each coil going to adjacent slots on the same side of the shaft. In this case we have an armature with 24 slots. The full pitch for this armature would be 12 slots or 1 and 13, a winding which would tend

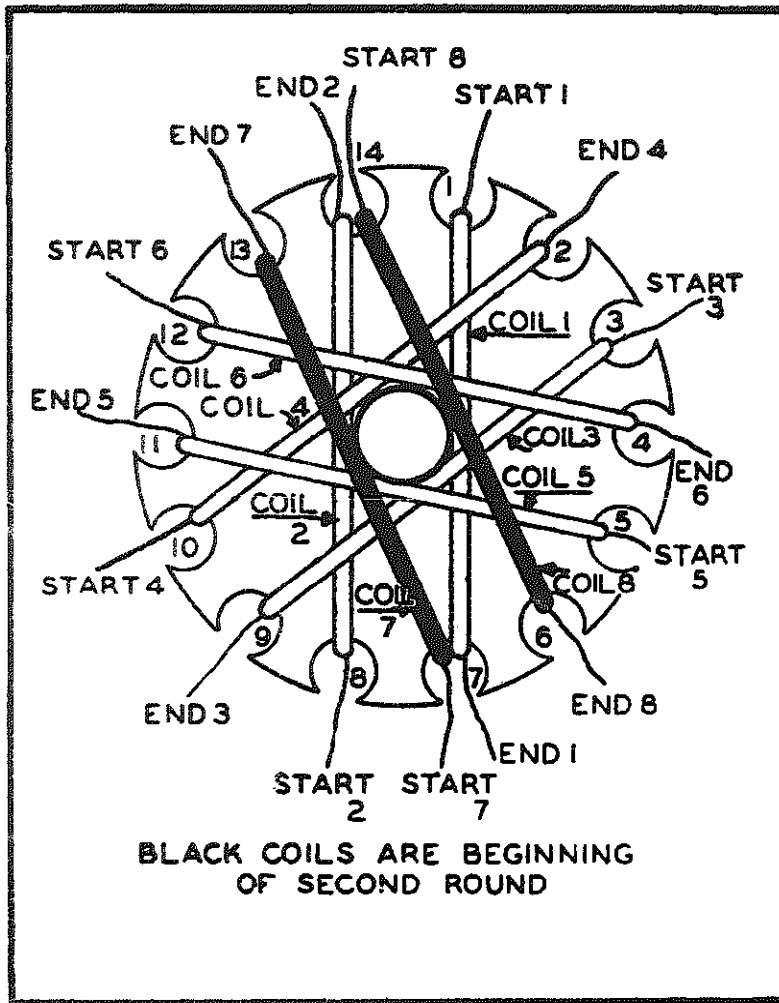

Fig. 2A. Starting a parallel-split loop winding

to "pile up" at the ends because each coil would have to cross the largest number of other coils besides bending around the shaft.

By making the winding short pitch, or chorded, we eliminate a great part of this trouble. If we make the pitch 1 and 11 instead of 1 and 13 we are covering two slots less than full pitch, which helps some but may not solve all of the difficulty of getting the windings in the space allowed. As a further aid to securing a better distribution of the coil ends the divided, or split-pitch winding is often used. This winding is wound with one wire in hand, and can be used on armatures having two or four times as many commutator bars as slots. It can be loop wound with

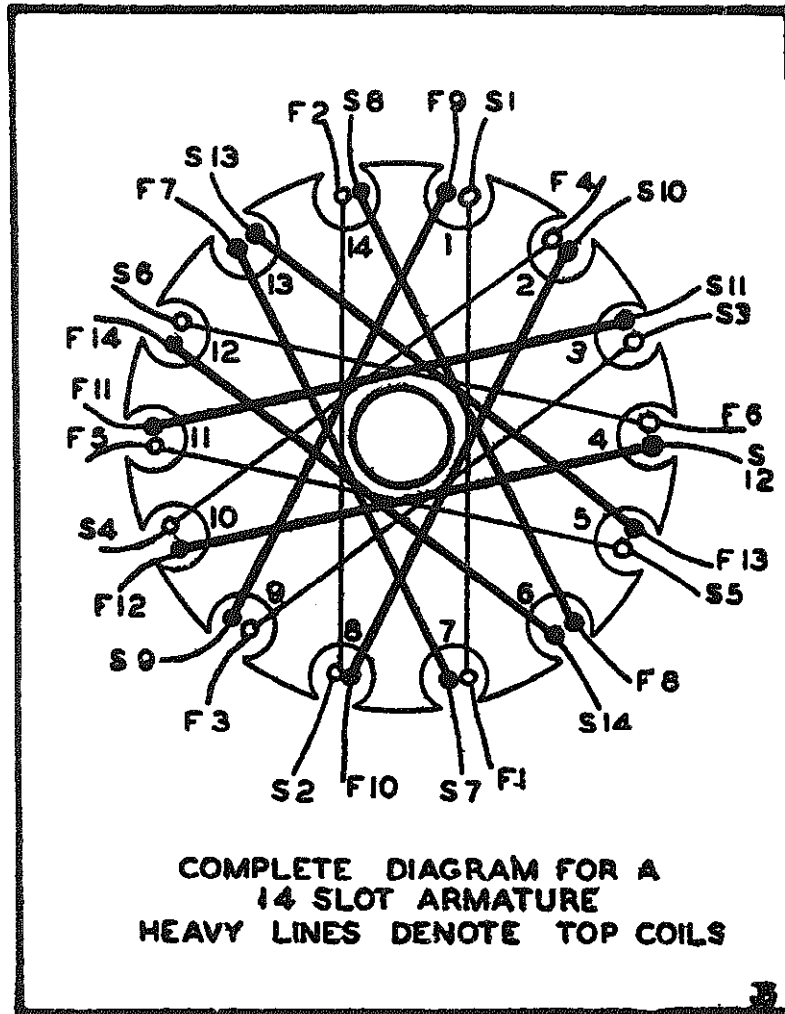

Fig. 2B. Complete diagram of a parallel-split loop winding

a continuous wire, in which case the loops must be color coded alternately.

In winding the armature shown in Fig. 4 the first coil is started in slot 1, carried through slot 11, and back through slot 1 until the full number of turns have been wound. The finish of the first coil is in the same position as the beginning—at the commutator end of slot 1—and a loop long enough to reach the proper commutator bar is made before starting the second coil. Coil two is also started (from the loop) in slot 1, but instead of also going through slot 11 it is wound into slot 10. Thus the pitch of the coils is split between 1 and 10 and 1 and 9. Half of the coils will have a pitch of 10 slots, half will have

a pitch of 9 slots, the average for the whole winding will be $9\frac{1}{2}$ slots, or a pitch of 9.5. Coil three starts in slot 2, carries through slot 12 and finishes with a loop in slot 2. Coil four starts in slot 2, winds in slot 11 and finishes with a loop in slot 2 ready to commence coil five in slot 3. This method is carried on around the armature until each slot contains four coil sides.

Still another type of loop winding is known as the split V loop. The chief advantage of this form of winding will be found where there is little space between the bottoms of the slots and the shaft. Because the coils are split, one coil end from each V shaped pair goes on each side of the shaft as seen in the illustration in Figure 5. While this winding is wound with loops between coils it can not be connected like a regular loop winding. In this case the loops must be cut before connecting to the commutator and it is important that the colored sleeving be around each individual starting and finishing lead and not merely slipped over the loop. Then when the loops are cut the proper designation can still be told. To accomplish this a dozen or more pieces of sleeving, alternately red and white, are slipped over the wire before starting the winding.

A white sleeve can be left on each starting lead and a red one on the finishing end. A loop is then made in the wire, then another white sleeve is put in place, and another coil is wound. Whenever the supply of sleeves on the wire runs out the wire must be cut and a new supply slipped over the wire as in the beginning. With this kind of winding a slot will be completed as soon as the two coils are wound, and it can be wedged at once if desired. This winding can only be used on an even number of slots.

Another form of winding which is adaptable particularly for low voltage armatures where the gauge of the wire is large and the turns few, is what is known as a diametrically split winding. As a winding of this kind must be full pitch to be symmetrical, it can only be used where the slots count up to an even number.

In the diametrically split winding each coil is di-

Coil number	10 SLOTS		12 SLOTS		14 SLOTS		16 SLOTS		18 SLOTS		20 SLOTS		22 SLOTS		24 SLOTS	
	Start in slot No.	Finish in slot No.	Start in slot No.	Finish in slot No.	Start in slot No.	Finish in slot No.	Start in slot No.	Finish in slot No.	Start in slot No.	Finish in slot No.	Start in slot No.	Finish in slot No.	Start in slot No.	Finish in slot No.	Start in slot No.	Finish in slot No.
1	1	6	1	6	1	7	1	8	1	9	1	10	1	11	1	12
2	6	10	7	12	8	14	9	16	10	18	11	20	12	22	13	24
3	5	7	8	8	9	9	5	10	3	11	5	12	3	13	5	14
4	8	2	9	2	10	8	11	2	12	2	13	2	14	2	15	2
5	9	9	10	10	11	11	5	12	5	13	6	14	5	15	3	16
6	10	4	11	4	12	4	13	4	14	4	15	4	16	4	17	4
7	7	1	6	11	7	13	7	14	7	15	7	16	7	17	7	18
8	8	8	12	5	14	6	15	6	16	6	17	6	18	6	19	6
9	9	3	13	1	15	1	16	15	9	17	9	18	9	19	9	20
10	6	8	10	7	8	2	14	7	18	8	19	8	20	8	21	8
11			11	3	11	3	10	1	11	1	10	19	11	21	11	22
12			4	10	4	10	8	9	2	10	20	9	22	21	23	10
13					15	8	12	3	15	3	12	1	13	23	12	23
14					8	12	4	11	4	12	2	11	2	12	24	11
15							14	5	15	5	14	3	15	3	14	1
16							6	13	6	14	4	13	4	14	2	15
17									17	7	16	5	17	5	16	3
18									8	16	6	15	6	16	4	15
19											18	7	19	7	15	5
20											8	17	8	18	6	17
21													21	9	20	7
22													10	20	8	19
23															22	9
24															10	21

Fig. 3. Winding chart for split loop armatures having from 10 to 24 slots. Compiled from tables in Rewinding Small Motors, by Braymer and Roe

vided in half as it is wound, the two halves going on opposite sides of the shaft. When the winding is started several turns are passed to the right or left of the shaft, then a like number are wound on the other side of the shaft, and so on back and forth until the full number of turns have been made. Figure 6 will give a clear idea of the method of placing a winding of this type.

In the foregoing paragraphs an effort has been made to give a general idea of the various types of windings that are often used in small motors and generators operating on direct current. More detailed treatment would take up an undue amount of space. It is seldom that a stripped armature comes to the rewinding shop, but when it does a general knowledge of the different windings may be of value during the process of "engineering" a winding to replace the original.

Usually, and also fortunately for the rewinder, the armature is usually delivered for repairs with the old winding more or less intact, and the necessary

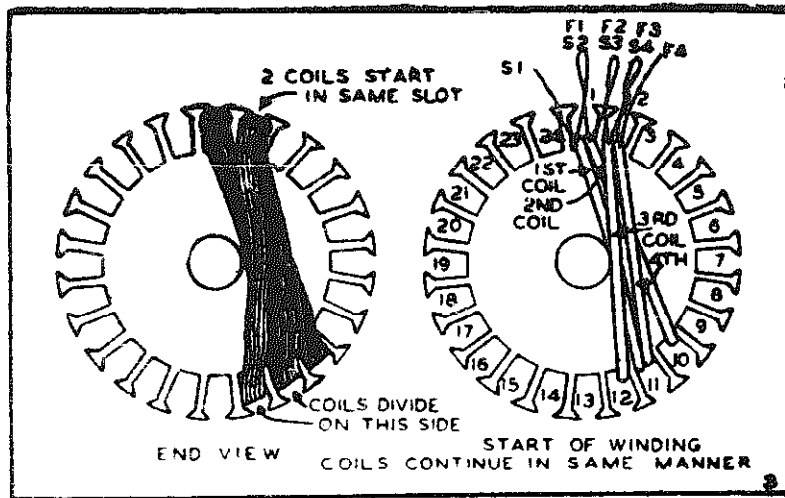

Fig. 4. Divided split-pitch loop winding

data for winding can be secured before stripping. If it is known or can be ascertained that the now defective winding has given long and satisfactory service the rewinder can hardly do better than to copy the old winding in such details as pitch, size of wire, kind of insulation, number of turns, etc. Naturally many rewinders will have pet methods that have proved their worth, new and better materials may be on the market, and it is quite all right to make legitimate substitutions that are known to be good.

When an armature winding is an unknown quantity it should be hand stripped down to a point where the winder will be absolutely sure that he is familiar with the commutator connections and all other information. In such a case, or where this information is already on file from previous jobs of the same kind, the balance of the stripping job can be done in the quickest and best manner.

One method of stripping small armatures that has found favor in many a shop is to cut off all the coil ends at one end of the core. This can be done with a hacksaw or on a lathe. The armature is then placed over a low burning gas fire or in a hot oven and allowed to "bake". The commutator can be removed or not, depending on the proximity to the windings, its construction and the type of heat used to bake the old winding. Commutators should never be placed over a flame.

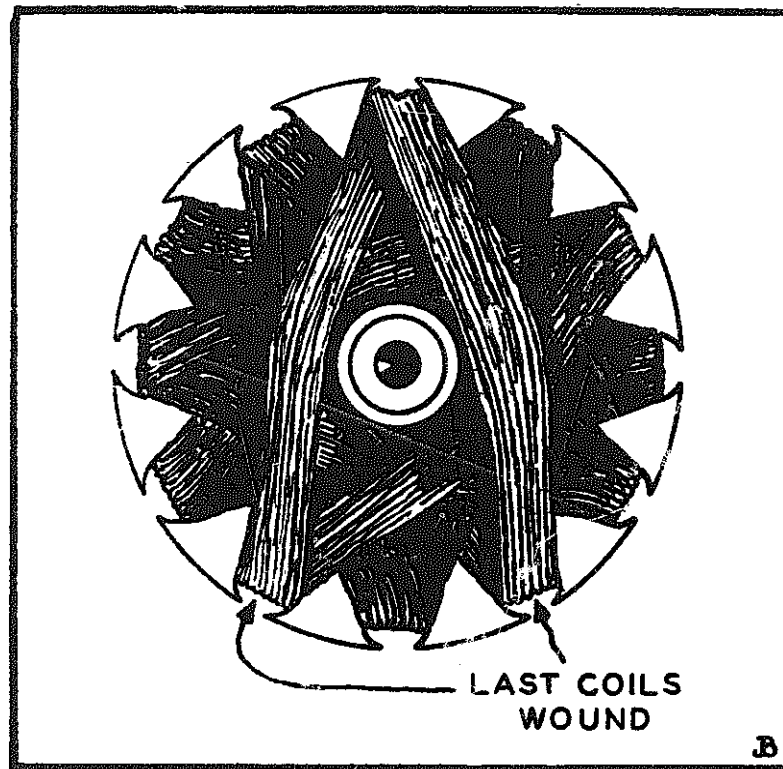

Fig. 5. End view of a split-pitch loop winding

After the winding has been thoroughly baked the shaft can be bumped sharply when in a vertical position and the winding will slip out of the core. If the baking has been thorough the slot insulation will usually come out with the coils, but if not it can easily be cleaned out with an old hacksaw blade.

Usually armatures are wound with the coil ends at the drive end closely hugging the shaft. This allows more room for distributing the coil ends and shortens the distance the wires must travel between slots. Some armatures, however, are wound with a hollow space between the shaft and the windings. The reason for this is either because there is a projection of the bearing boss of the end bell, or else to improve ventilation of the winding.

To form a hollow end in the winding a wooden spool is first slipped over the shaft, and the windings are then wound tight around the spool. Every shop should have a set of these spools available in sizes to

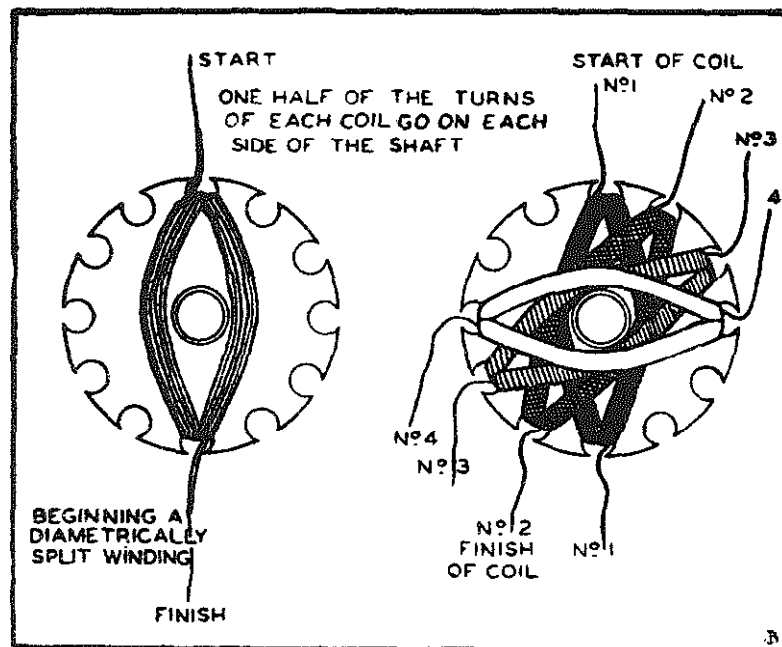

Fig. 6. A diametrically split winding. This is wound full pitch or "on the half"

fit shafts from $\frac{1}{2}$ inch up to at least $1\frac{1}{2}$ inches diameter. An assortment of outside diameters will also be necessary in as much as the spool must be smaller than the radius of the bottom of the armature slots. Usually the spool will be at least a $\frac{1}{4}$ inch below the bottom of the slots. After the winding is completed the spool can easily be slipped off of the shaft by giving a quarter turn.

Some form of counting device is a very handy piece of equipment for the rewinding bench. Armatures and stators used on the higher voltages often have a considerable number of turns per coil and an exact count of the turns wound is very desirable. In the large shops and in the factories the winder will be given a job and allowed to stay with it until through. In the small shop, however, different conditions prevail. The rewinder may have a dozen other duties, such as answering the phone, waiting on customers, doing minor rush repairs, etc., all of which distract attention from the winding job. A turn counter can be rigged up for use when laying hand windings that will allow the winder to stop at any time and yet come back to the job an hour, or a day, or a week

later and know exactly where he left off. The counter can be operated by the hand or foot in some ingenious manner. The writer uses one made from the trip mileage assembly from an old speedometer which is very satisfactory. Counters for all kinds of industrial jobs can be purchased at moderate prices, but if one is purchased get one that can be reset to zero quickly.

Chapter 8

Loop Windings for Small Armatures

IN THE course of a year many types of armatures will come the way of the rewinding shop and it is necessary for the winder to have a comprehensive knowledge of the various forms of windings. One of the most common types is known as the loop winding. On a loop wound armature one complete coil end, or loop, can be seen on the driving end. This is, of course, the last coil wound and is the only one not partially covered by adjacent coil ends. See Fig. 1.

Because consecutive coils finish and start in slots next to each other, and because both of these leads—the finish of one coil and the start of the next—go to the same bar on the commutator, it is not only possible but often practicable to wind the armature with a continuous wire. When this is done a loop is made long enough to reach the proper commutator bar at the finish of one coil, and the wire is doubled back to start the next coil. A study of Figure 2 will show the manner in which this is accomplished.

Loop windings are quite popular on small armatures, such as are used in vacuum cleaner, fan and most universal type fractional horsepower motors. One of the reasons for this is that such armatures are most often wound on armature winding machines, and the loop winding is most adaptable to this form of production. Most rewinders find it not only tedious but unsatisfactory to attempt to rewind very small armatures without the aid of a winding machine. Most of these armatures are wound with plain enameled wire of small diameter and require an even tension to prevent breaking of the insulating film, resulting in shorts.

Few rewinding shops depending on local trade will find it worthwhile to install an armature winding machine for the comparatively few armatures that can not readily be hand wound. There are many concerns making a specialty of machine winding small armatures and usually an exchange plan is offered giving

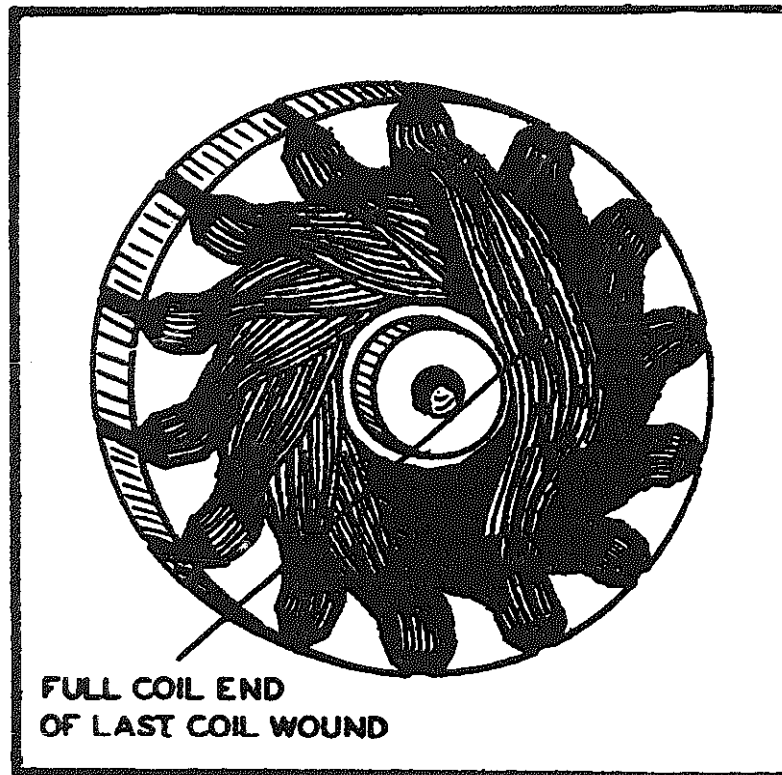

Fig. 1. Appearance of the end of a loop winding. Only one full coil end can be seen.

quick service and low cost. In general, hand winding will be found satisfactory on armatures employing cotton covered wire if the price received for the finished job is in proportion to the labor involved.

In brief, the advantages of the loop winding are that such a winding is quickly wound, and the connections to the commutator are easily made with the smallest chance of error. The chief disadvantages of this form of winding lies in the unequal amount of copper in the various coils, and in unequal mechanical balance. Because the coil ends must be built up, one upon the other, it will be seen that the last coils laid will contain a greater length of wire than will the first coils placed in the slots. Thus there will be a variation of the electrical resistance of the different coils as well as a difference in weight.

Many beginning rewinders experience great difficulty in securing a symmetrical winding because of the tendency of the coil ends to "pile up," with the

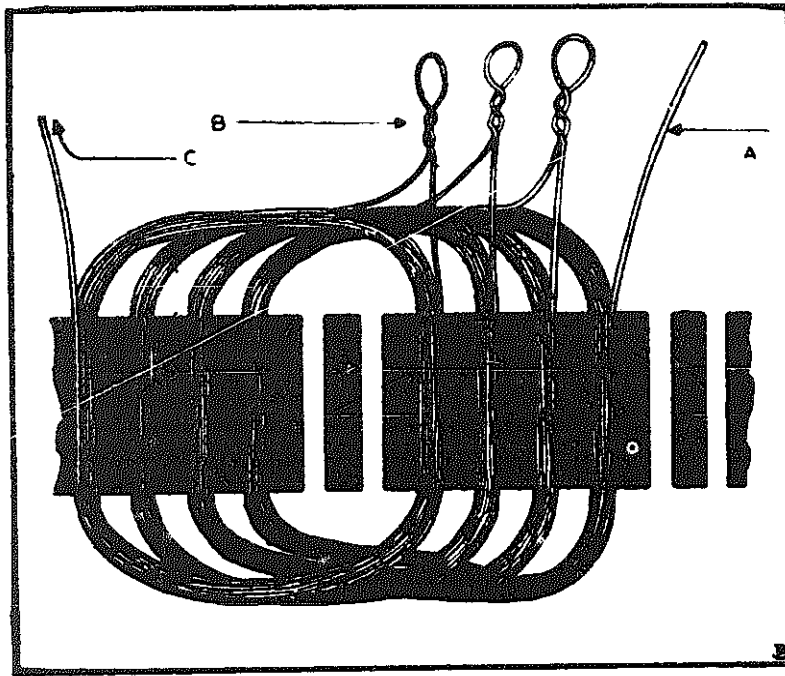

Fig. 2. How a loop winding would appear if wound on a flat surface. **A,** beginning end of wire. **B,** loops left between coils so as to have continuous wire. **C,** wire to reel used in winding. . . .

result that the finished winding occupies too much space, and may even result in preventing its assembly into the machine. There are three tricks well known to experienced rewinders which will overcome this tendency.

The first and probably most important rule to remember is that the *first three coils* laid determine the shape of the finished job, for it is over this position that the last coils overlap. Therefore, particular attention must be given to the first few coils in the way of pressing them neatly and closely against the core and close to the shaft.

In this connection it might be well to state that fibre end laminations should be used whenever possible. These fibre washers can be purchased in sizes and shapes to fit all standard type cores, and a reasonable stock of them should be maintained. Their use eliminates one of the greatest troubles that bothers the winder, that of grounds at the corners where the wires leave the slots. When no factory cut end wash-

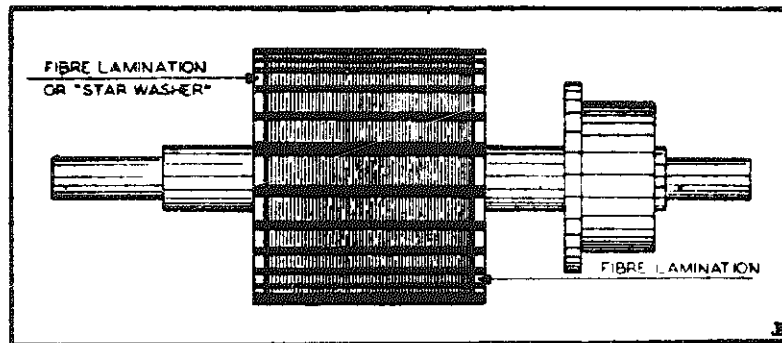

Fig. 3. Showing proper use of fibre end laminations pressed on shaft.

ers are immediately available, some rewinders take the time to hand cut a set from sheet fibre. When no other pattern is at hand one of the iron laminations can be pried from the core and used as a pattern, after which it can be replaced. Figure 3 shows the use of these fibre laminations, while Fig. 4 shows the method of laying coil ends when regular core insulators are not available.

The writer knew of one fairly large rewinding shop which discontinued the use of these insulators some years ago with apparent success. However, most of their work was in the field of low voltage automotive armatures, and they used an unusually heavy type of slot paper with generous margins. Fibre end laminations must be used if the utmost in long life and dependability are expected.

The method of placing a loop winding is as follows: Start the wire in slot No. 1, leaving sufficient length to more than reach the commutator bar to which it will later be connected, and bring around through slot No. 7 as shown in Figure 5. (In this case we are arbitrarily taking an armature having 14 slots with a pitch of 1 and 7, or one slot less than half way). The wire is then taken back through slot No. 1, around to slot No. 7, then back through No. 1 and so forth until the required number of turns have been made.

The wire is then carried out past the commutator, twisted into a loop, and is brought back into slot No. 2. The coil occupying slots No. 2 and No. 8 is now

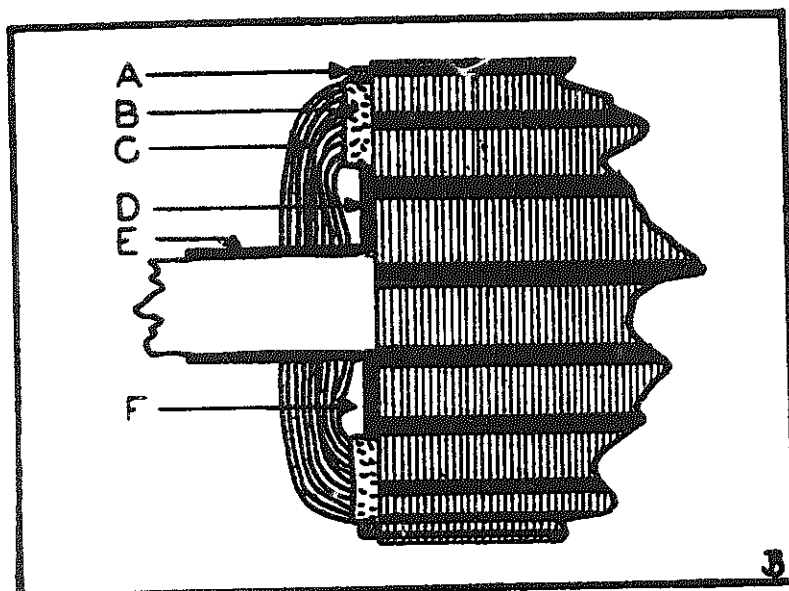

Fig. 4. How to insulate armature coils when no fibre laminations are used. A, wedge. B, slot fibre. C, coil end. D, round fibre washer. E, shaft insulation. F, air space.

wound, leaving another loop at its completion. The coil in slots 3 and 9 is now placed, followed by the other eleven coils. At the conclusion of the winding operation there will be 13 looped ends plus the single starting and finishing ends. These two single ends can be twisted together, after which the loops can be placed in the proper commutator bars in order of rotation. As this particular armature is one wire in hand there will be 14 bars, or one bar per loop.

Another rule that the experienced winder follows to avoid bulkiness in the winding is to "fan out" the coil ends. This means that instead of laying the wires in a more or less round bundle as they are in a slot, the winder spreads the wires out fanwise at the ends where they must pass across other coils. This procedure utilizes the space to the best advantage and tends to keep the layers thin and closer to the core. See the diagram in Figure 6.

Still another method of keeping the coil ends closely packed and symmetrical is to make frequent use of a hammer or small mallet. The blows should not be applied directly to the coil ends but through the med-

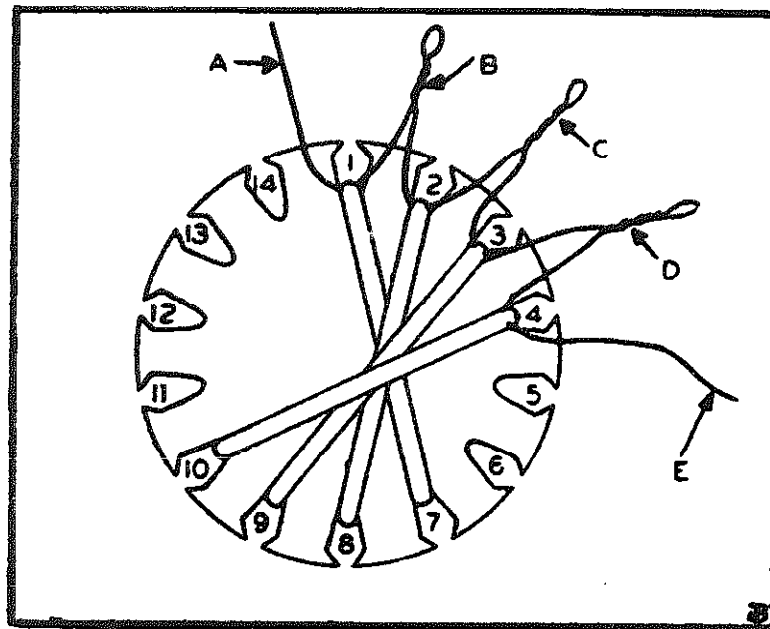

Fig. 5. Starting a loop winding, which can be wound in either direction. A, start of first coil. B, end of first coil and beginning of second coil; C, end of second coil, beginning of third; D, end of third coil, beginning of fourth; E, end of fourth coil ready to loop and proceed with fifth coil.

ium of a small block of soft wood, one with rounder corners. The blows should not be heavy, as considerable caution must be used to avoid cutting through the insulation. A little practice will soon show where and how much pressure can be applied for the best results.

So far we have considered only the loop winding as wound with a single wire. They can, however, be wound with two or three wires in hand, or else the operator if he wishes can wind two, three or more coils in the same slot with a single wire. In this latter case—using but a single wire—the first coil is wound in the slots, then a loop is formed the same as for the single coil winding, another coil is wound in the same slots and on top of the first one, another loop is formed, and additional coils are wound in the same manner.

In a winding of this kind the number of coils per slot is determined by the relation of commutator bars to slots. Thus if there are 14 slots and 42 bars it will

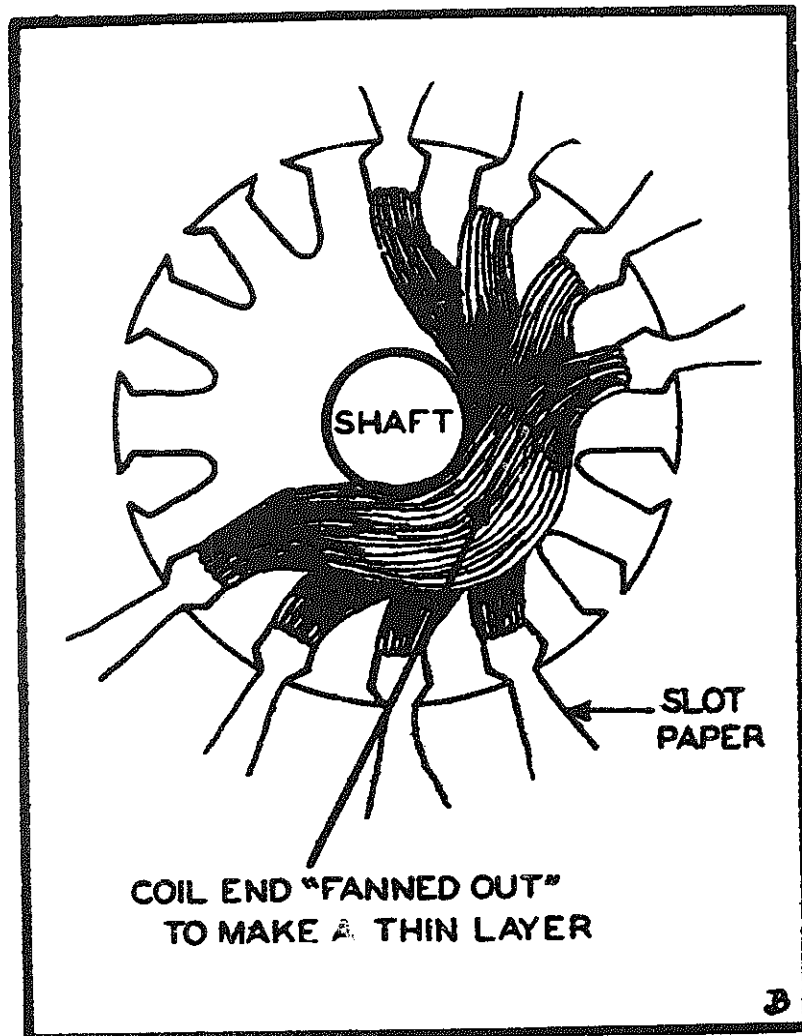

Fig. 6. Spreading out coil ends prevents bulkiness.

be a case of 42 divided by 14, or 3 coils per slot. With the one wire in hand method of forming more than one coil per slot, each loop will be the start of one coil and the finish of another. However, there is danger of getting the loops from the different coils mixed when assembling to the commutator and for this reason winders use several ways of marking the loops of the first, second, third, etc., coils. Either colored woven sleeving can be slipped over the different loops—such as red for the first, black for the second, blue for the third, or else the winder can leave a short loop on the end of the first coil, a longer one on the second, a still longer one on the third, etc.

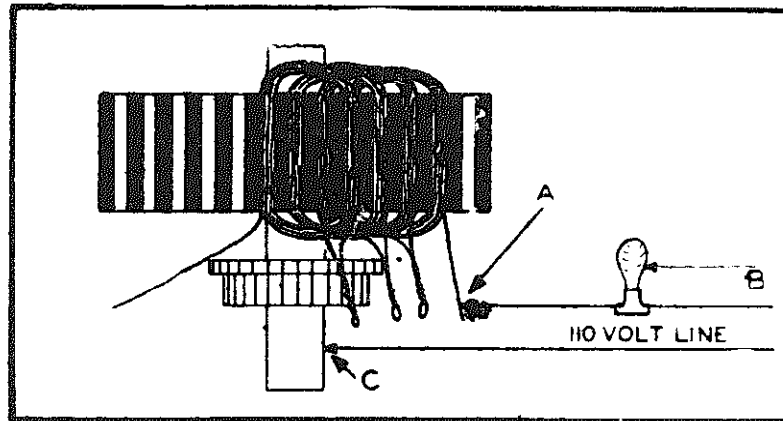

Fig. 7. When a ground occurs in winding, the test lamp lights at once.

When winding an armature with more than one wire in hand the wires are usually cut at the completion of each set of coils and it becomes necessary to brand the ends. This is most often done with colored sleeving but only two colors are needed as all finishing ends can be one color and all starting ends of a different color. As an example plain white sleeving can be used for starting ends, with blue for the finishing leads. This sleeving is not wasted as it can be left on the wires to form an extra layer of insulation going to the commutator where the wires are bunched.

One advantage of the continuous wire system in winding loop wound armatures lies in the fact that grounds can be instantly detected if the beginning of the winding is connected to one side of a test lamp or buzzer, and the shaft is connected to the other side. As soon as a ground appears the lamp will glow, or the buzzer indicate the trouble, and the winder can remedy the fault at once before covering the place with more turns. See Fig. 7 for diagram.

While the armature coils of the higher voltage machines, with certain exceptions, usually contain a large number of turns of relatively small wire, this fact is not true with machines operating on 32 volts and less. Here we most often find very few turns per coil, in the neighborhood of 6 to 10 or so, and the wire possibly between number 12 to 18 gauge. An individual coil on an average armature of this type

will be found to contain anywhere from 6 to possibly 10 feet of wire. Hence many rewinders resort to a scheme of winding that eliminates all bother of counting turns.

The simple method by which this is done is to measure the wire from one of the original coils, and then to cut a bundle of new wires about six inches longer than the sample. This extra length, of course, is to compensate for inequalities in winding and to allow plenty of length for the commutator leads. The winder then draws wires from the bundle and winds turns into the slot until all of the length has been placed. As mentioned before in connection with this type of winding, the last few coils will need slightly more wire than will the first coils, due to the greater distance the last coils have to travel over those beneath.

This method of winding will be found very handy for the man who is constantly called away from the winding bench to answer telephone calls, or to do other work. The freedom from having to count or to remember the number of turns made will allow the winder to get back on the job with the least loss of time and the fewest errors.

When connecting any type of winding to the commutator it is found to be very handy if all of the finishing ends of the coils can be made to come out on the top layer, just under the wedge. This gives a pleasing contour to the finished job and is the way most armatures are wound.

Taking a 14 slot armature as an example, with a pitch of 1 and 7, we find that the first 6 coils wound lie wholly in the bottom of their respective slots. At this point we have six coils with 12 coil sides occupying 12 slots, with two slots still vacant. Our next coil to be wound will start in slot 7 which already holds the finishing side of the first coil wound, and we have to do something about it if we do not wish to cover up the finishing end of the coil starting in slot 1.

What is done is to lift out the finishing end (or ends if more than one in hand) and bend it back away from the rear of the armature. We now wind in the coil that takes position in slots 7 and 13. After

this coil is in place we bring back the finishing end of the first coil that was in slot 7, and which was temporarily removed, and replace it in the top of slot 7 above the last wound coil. Thus we have the finishing lead from the lower coil coming out on top of the top coil. In the armature we are considering this must be done in each slot from No. 7 to No. 14, Slots No. 1 to No. 6 will have the finishing leads coming out on top as a matter of course.

Loop windings can be wound either right or left hand without affecting armature rotation or polarity. By right or left hand is meant the direction in which the coils are placed one upon the other. The winder can wind either way from him or toward him, and the coils can be placed on either side of the armature shaft in making the circuit from slot to slot.

The winding pitch of an armature is found by counting the number of slots spanned by one complete coil, including the slots in which the coil rests. In the fourteen slot armature we have been considering the pitch is 1 and 7, meaning that one side of the coil is in slot No. 1 while the other side is in slot No. 7. For a 2 pole machine of this type the full pitch would be 1 and 8, or in slots exactly opposite each other. As the pitch in this case is one slot less than full pitch it is commonly known by the winding term "chorded." In a machine of four or more poles the "full pitch" would be the number of slots necessary to span the space between exact centers of adjacent poles.

Chapter 9

Rewinding Fan Motors

MANY are the electrical appliances that are brought to the average electric shop for repair. A very fair proportion of such appliances needing service will be fans of one kind or another, and other small single phase motors used in the home, shop or office.

The profit from this kind of work depends almost entirely upon the judgment and experience of the service man. Judgment must be used to decide whether it will be best to take the job in for repairs, or whether the customer should be sold on the purchase of a new and better fan, vacuum cleaner or just extractor. Each case must be considered on its merits, but as a general rule it is poor policy to accept a repair job if the estimated cost of reconditioning a small appliance exceeds 50% of the price of a new article. Unless, of course, the customer insists that the work be done regardless. Such a policy leads to more sales, better profits, and in the long run to more of that red blooded business commodity known as good will.

A certain portion of the market has been flooded with cheap 10c store merchandise: 49c toasters, 79c electric stoves and fans for \$1.19. Obviously it is impractical to repair and impossible to make any profit from this kind of business, and the sooner such items land in the junk box the better for all concerned. Experience will teach a service man that many an expensive appliance should be treated with a hands off policy when it comes to the shop for repairs. This may be because parts are hard or even impossible to obtain, because the amount of labor involved would be out of proportion to the value of the unit, or because new inventions or improvements have made the outfit obsolete.

Many electrical repairmen, while familiar with the operation of small single phase motors above the 1/8 horsepower size, hesitate to dig too deeply into the

miniature single phase motors because they are not familiar with the various starting and speed control circuits used on so many fans and other appliances. Some of these circuits seem quite complicated when seen in the final assembly, and are often very hard to trace out if no diagram is at hand. As most repair men know, it often takes ten times as long to locate the trouble as it does to fix it when once found.

The purpose of this article is to explain, and show by simple diagrams, the circuits commonly used in single-phase fan motors, especially in the older models. Because of space limitations the exact circuits for all makes and models cannot be given, but it is believed enough are described here to give a working knowledge of the principles involved.

The earliest type of alternating current fan motor was copied from the direct-current fans in use at that time. It was discovered that a series type motor would run on a-c as well as d-c, with the exception that the use of a-c current caused excessive sparking at the brushes. This complaint was diminished somewhat by making slight changes in the winding of the armature and field windings. There remained, however, the matter of speed control. On the earlier motors this was accomplished by shifting the brushes from the neutral position, as indicated in Figure 1.

In later types, many of which are in use today, the speed of the fan is controlled by inserting a resistance in series with the motor circuit, thus lowering the voltage applied to the motor windings. This, of course, reduced the speed of the armature in proportion to the value of the resistance. Many of these fans have a single resistance, giving a high and a low speed; others use a tapped resistance giving three or four speeds. A diagram of the circuits of a simple three speed fan of the commutator-series type is shown in Figure 2.

The next step in the advancement of fan motor design was the use of an induction motor of the simplest type. These motors made to operate on 60 cycle current employ four poles to obtain the most satisfactory speed for the most common type of fan blades—in the neighborhood of 1600 r.p.m. Many of

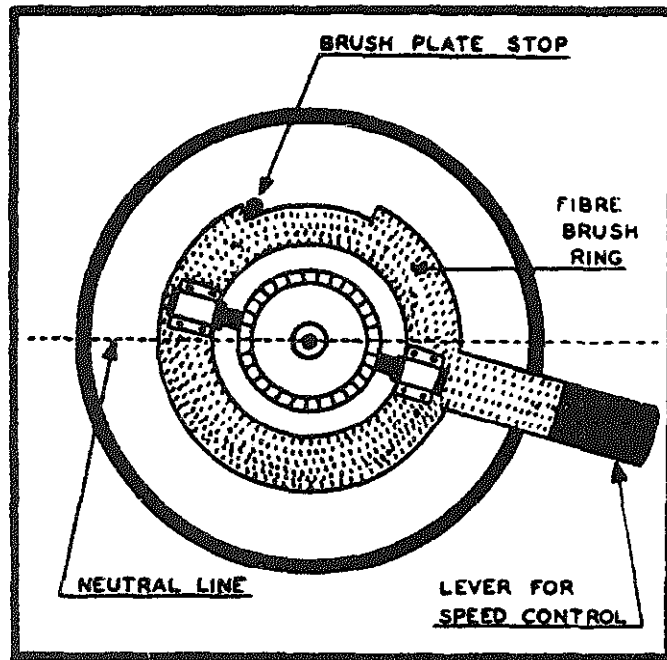

Fig. 1. Old style fan motor of the series type with speed regulation obtained by shifting brushes

the cheaper fans used a cast field ring, but because of the heavy losses common to this type of construction most of the better fans used a laminated field frame.

Since induction motors are not inherently self starting, some means of causing a displacement of the pole flux had to be provided to cause the rotor to start revolving. One means of accomplishing this was by shading the trailing edge of the poles, thus retarding the flow of magnetic flux in that section of the pole surrounded by the copper band, while in the rest of the pole the flux is in phase with the field current. Shaded coil construction reduced manufacturing costs and will be found in many of the cheaper induction motors in this type of service.

Induction type fan motors use a squirrel-cage rotor somewhat similar to the rotors used in larger induction motors. The copper squirrel-cage construction of the typical fan rotor, however, has a higher resistance than that of those used in motors for power drives. This higher resistance of the squirrel-cage rotor is necessary where the field strength is to be

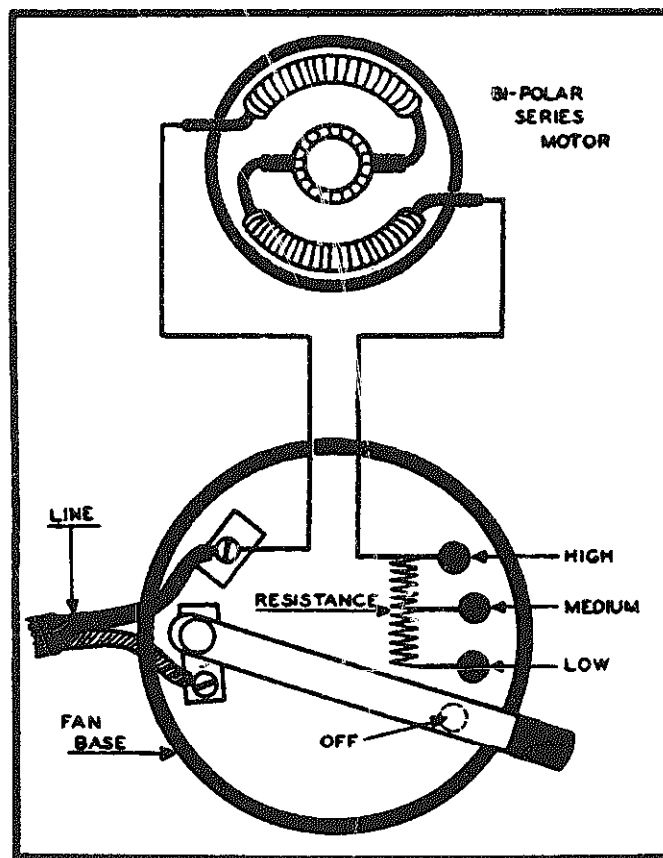

Fig. 2. Circuit of a series-commutator fan motor with speed control by a tapped resistance

reduced in the controlling of fan speed. As the voltage applied to the stator winding is reduced it decreases the density of the magnetic flux and allows greater slippage of the rotor.

The speed of shaded coil motors is usually controlled with the aid of a choke coil or resistance placed in series with the main field. A diagram of a typical single-phase fan motor of the shaded pole type, one employing a resistance unit for speed changes, is shown in Figure 3.

A common type of ceiling fan is similar in principle to the type just described. Some ceiling fans make use of copper band shading on the individual poles while others use a continuous shading coil that is wound through the slots on top and isolated from the main winding. The terminals of this shading coil are soldered together to make a complete circuit

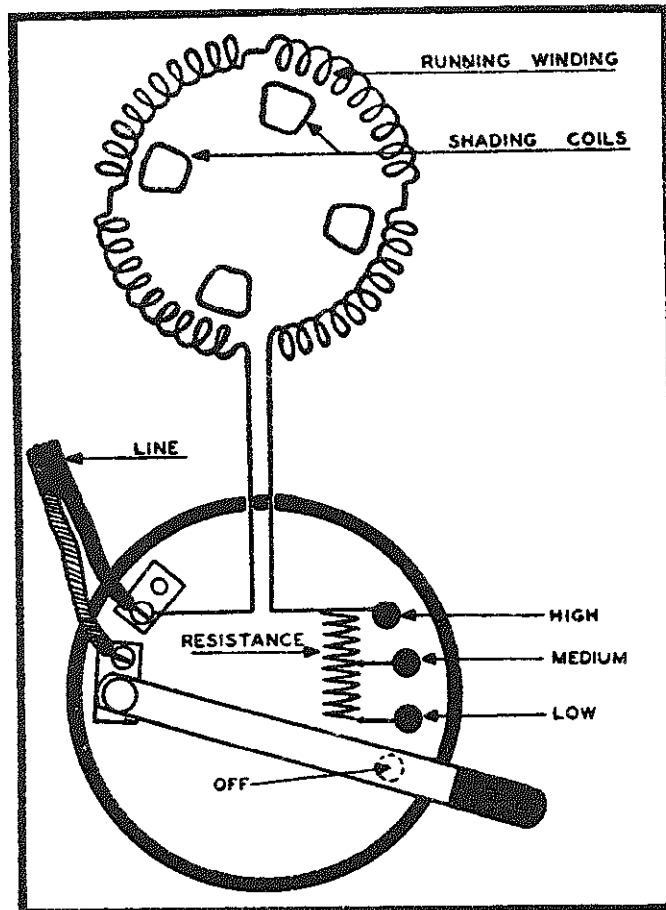

Fig. 3. Single-phase motor of the shaded coil type. A tapped resistance controls speed

having no connection with line voltage at any point. The continuous wire wound shading coil balances the retarded flux in all poles alike, and makes for a smoother and more quiet running motor.

Because of the lower speed at which they operate, all ceiling fan motors have a larger number of poles than does the conventional desk type of fan. When ceiling fans become noisy in operation the trouble can usually be traced to lack of lubrication or wear in the rotor bearing. If excessive the latter condition may allow the rotor to scrape against the poles. Figure 4 shows the circuits of a continuous coil shaded ceiling fan motor, the speeds of which are regulated by a four pole snap switch and a center tapped choke coil.

Split-phase is used in starting fan motors just as it has been used in the larger size of power motors.

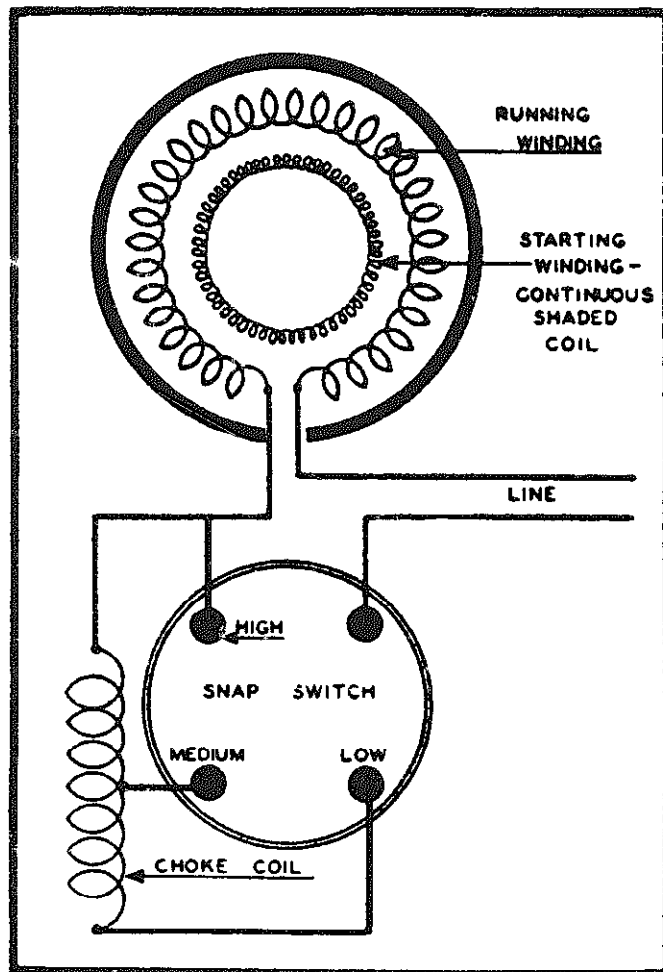

Fig. 4. Circuits of a ceiling fan motor using a wire wound shaded starting coil with choke coil for speed control

Various methods of phase splitting have been brought into use on different makes of fans, and a few of the common circuits will be briefly considered.

Figure 5 shows the simple circuit details of a split-phase fan motor having a main and a starting winding. It will be noted that the starting winding is in the circuit at all times. This simplifies the operation of the fan, as a centrifugal or cutout switch is eliminated from the starting circuit, but means that the starting winding, by being in the circuit at all times, must have a very high resistance. As a fan motor is not required to start under any load other than bearing friction, the starting winding can be of much

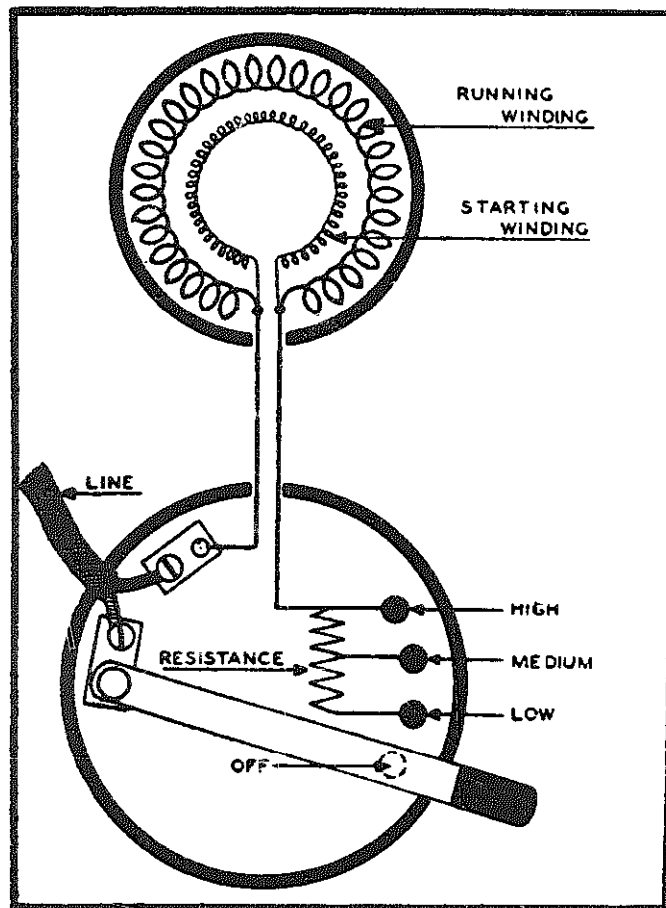

Fig. 5. Split-phase fan motor with high resistance starting winding, which is permanently connected in the circuit

higher resistance than would be possible in a motor having to start under full load. Motors of this type are not economical in current consumption as the starting winding continues to draw current as long as the fan is in operation. Speed control in this type of fan is usually by a resistance coil having one or two taps.

In Figure 6 we have a split-phase fan motor circuit very similar to the one in Figure 5 except that a centrifugal switch has been placed in series with the starting winding. Here the starting winding would be heavier wound as it is in use only during the starting period. Having less resistance it will aid the rotor to attain running speed in a shorter period of time and, while it will consume more current, this

can be disregarded due to the short space of time the starting winding is brought into use. A choke coil in the fan base controls the voltage impressed on the windings and gives a number of speeds corresponding to the number of taps provided.

A very efficient type of desk fan that has been produced in large numbers is shown in Figure 7. This type of fan circuit is familiar to most service men as it is one of the types having a three conductor cable connecting the motor with the base. The motor winding circuit is like that of Figure 6 with the exception that the centrifugal cutout switch is not used, one end of the starting winding being directly connected to one end of the main or running winding. The features of this design are a high starting torque, better than average efficiency at running speeds, and good speed control.

A transformer is to be found in the base of a motor of this type. The transformer primary is tapped at several points and is placed in series with one lead of the main, or running winding. The transformer secondary is connected to the motor side of the primary at one end, and to the free end of the starting winding on the other side. When a circuit of this type is thrown on the line the current for the main winding has to pass through the transformer primary, and the voltage induced in the secondary winding of the transformer is fed to the starting winding circuit. The voltage lag in the secondary of the transformer plus the normal lag in the high resistance starting winding gives a phase-angle almost equal to a two-phase motor. This accounts for the high starting torque in this type of fan, and has a lot to do with quiet operation at all speeds.

Another type of fan motor circuit using a three conductor cable between the base and motor eliminates the use of a starting winding by dividing the main winding into three parts, and placed in relationship to each other so that the flux of the field has a rotating characteristic closely associated to that of a three phase motor. One end of each of the three sections of winding are connected together inside the motor. Line current is fed directly to the

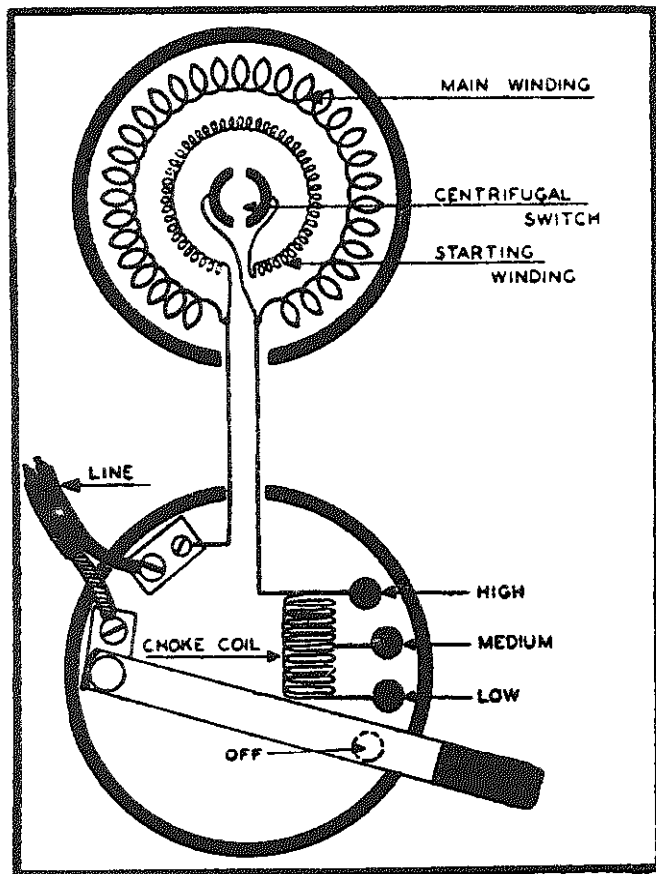

Fig. 6. Circuits of a split-phase fan motor using a cutout switch in series with the starting winding

free end of one winding, and after passing through it, is distributed into the two remaining sections. From the second section of the winding the current must pass through a resistance to reach the other side of the line, and from the third section must pass through a tapped reactance or choke coil. In this way the current in one section of the winding is made to lead that of the next section (because the resistance and choke coils are of different values) and the rotor is caused to revolve in the field.

Speed control in a motor of this type is obtained by adding more or less turns to the working part of the circuit that includes the resistance and choke coil. When the switch is moved to the medium or low positions more turns are added to the choke coil and to the resistance, with the result that the voltage applied to

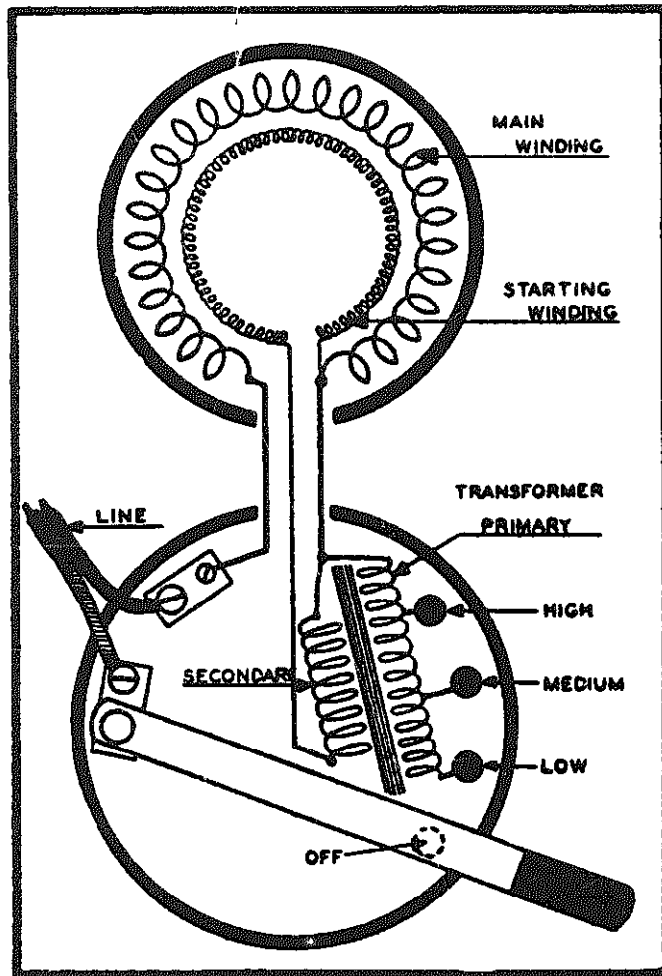

Fig. 7. Split-phase fan motor using a transformer for speed control. Note that the starting winding is connected to the transformer secondary

the motor windings is reduced, and consequently the speed of the rotor. Any reduction of voltage in the two sections of the winding connected to the resistance and choke coils is automatically reflected in the section of the winding connected to the line, as this winding is a common path for the other two sections. A schematic diagram of a fan having a circuit of this type is given in Figure 8.

In the servicing of electric fans the most common complaints are worn out bearings, stripped gears on oscillating types, and burned out resistance or choke coils. As a general rule the motor windings give but little trouble save where the impressed voltage has

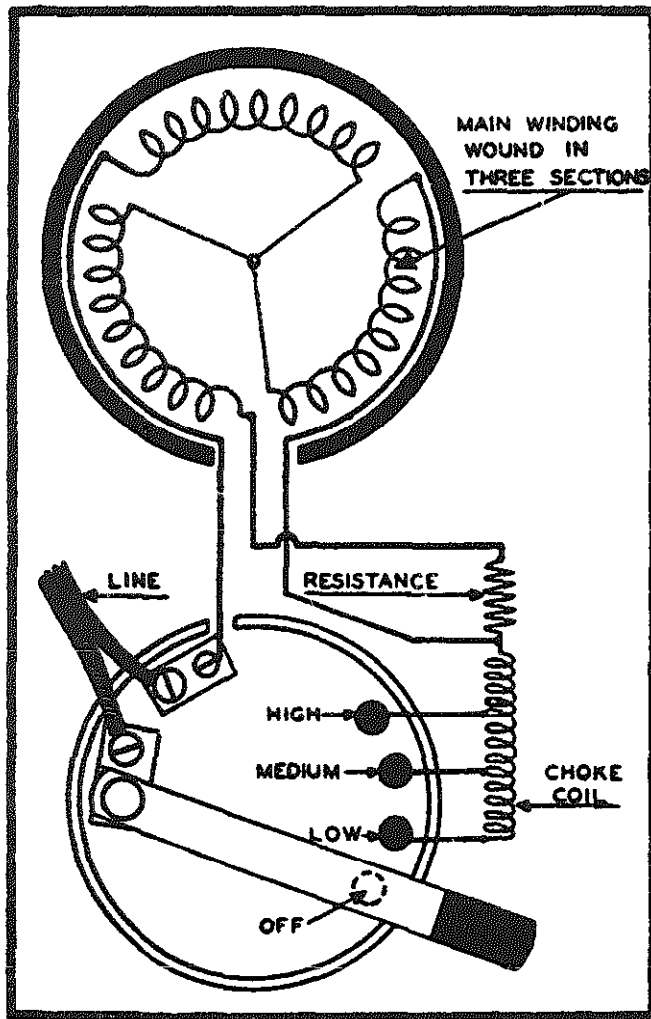

Fig. 8. A split-phase fan motor with winding in three parts. Each section of the winding is spaced one third of a pole apart around the stator instead of as shown in this schematic diagram. A motor of this type has many of the operating characteristics of a three-phase motor

been too high, where the fan has been connected to current of the wrong number of cycles, or where the size or number of the fan blades has been changed. Fan motors are designed to operate at certain speeds under certain load conditions. When larger blades, or more blades of the same size, are attached to the rotor shaft, the rotor speed will be reduced on the one hand, while current draw from the line will be increased on the other. The same conditions apply when fan mo-

tors are used for other purposes where the load or speed is changed within wide limits.

Chapter 10

Rewinding Automotive Armatures

MANY requests have come from motor shops asking for general information on the winding of low voltage armatures such as are used in automobile and marine engine generators and starters. Because it would be impossible to answer all these queries in detail, we are giving here a number of suggestions and instructions for rewinding six and twelve volt armatures.

Before going into the methods used in this branch of rewinding, let us first consider the possibilities for making profits from this sort of work. In the larger cities the automotive field is keenly competitive and in many cases prices have been hammered down to bed rock. For this reason alone the well established motor shop will not find this form of rewinding attractive, and the best interests of all concerned will probably be better served if the motor shop sticks strictly to its own field.

In the larger cities there will usually be found one or more attractive shops that are on a quantity production basis, and who, by the use of cheap, unskilled labor, are able to turn out the work at extremely low prices. Not only do they use cheap labor but in most cases they use undersize wire and many other short cuts to beat down the price. No thought is given to quality or lasting service.

At current prices the most popular types of automobile generator armatures, such as Ford and Chevrolet, can be bought at wholesale as low as a dollar and a quarter. Obviously, at this price, considering even the cheapest labor and materials, there can not be much profit. The question is often asked: How do they do it? A visit to one of these production shops will supply the answer.

The writer recently inspected such a shop. Eleven boys and girls and one experienced armature winder were employed in the work of turning out rewound armatures. One young boy, fresh from the farm, did

nothing all day long but strip old cores. After stripping, the cores were placed in a gas oven to burn out the remaining paper and dope. Another boy replaced defective commutators or cleaned up the old ones for rewinding. One girl cut and inserted the slot insulation. One girl and two boys wound the coils in the slots, leaving the free ends extended. Another boy placed coil leads in the commutator bar grooves, and passed them on to another boy who did the soldering. Still another boy turned the commutators on the lathe and did the final testing. Dipping, baking and undercutting were done by two girls. The foreman was kept busy supervising the work and attending to the few jobs that needed special knowledge.

In this shop not one employee, except the foreman, was capable of winding a complete armature. Each one had been trained to do but one thing, and handled the same operation day after day. The capacity of this shop was about 300 armatures per day with a labor overhead of about \$30, and it is easily seen that the skilled armature winder can not compete in this market.

So far, from the standpoint of the skilled workman, we have painted the picture rather dark. There is, however, another side of the picture if we move to one of the smaller towns some distance from a large center. Here, through automotive jobbers and auto supply stores we still have the same competition in the small car generator armature field, but these stores are not likely to carry armatures to fit old, obsolete or high priced cars, and these are the numbers that net the rewinder real money.

It costs but a few cents more to rewind a \$5.00 armature (dealer's price) than it does to rewind an armature for a Chevrolet six, that wholesales for \$1.50. It is the former jobs, the ones selling for \$3.50 up to \$10.00 and over, that offer encouragement to the motor rewinder. The volume of these higher priced types is not large, but to the already equipped motor shop it offers a chance to fill in odd hours and make wages or better. In many instances automotive rewinding has proved to be a big help to the shop specializing in the rewinding of a-c motors.

Automotive armature winding fits in well with the small town motor shop because the same equipment and stock of materials can be used for both types of work. Low voltage armatures are easier to wind, especially for the beginner, because there are fewer turns, fewer coils, and less attention need be given to insulation. The wire sizes used in automotive generator armatures are the easiest for hand winding, as they are neither too small nor too stiff. Because of the large demand, commutators, fibre end laminations, etc., are quite low in price. A good mica insulated commutator for a Chevrolet armature sells for 35c.

If the rewinding of automotive generator armatures is to be a spare time business for the motor shop, a representative stock of rewound cores must be kept on hand so that exchanges can be made without delay. The exchange method allows prompt service to the buyer (who is invariably in a hurry) and gives the shop the opportunity of doing the winding when other work is not pressing. It is understood that odd types and obsolete armatures can not be stocked, but as these command much higher prices the shop can afford to turn them out as special jobs.

The best way for a shop to build up a stock of automotive armature cores for rewinding is to patronize a local junk yard. Cores in good condition, but with burned out windings, can usually be obtained for about 25c each, as the junk man has no other market for them. In selecting cores, particular attention should be given to the condition of the laminations, trueness, threads, centers and to the bearing surfaces. It will not pay to rewind cores that are not in good condition.

Just as in the winding of any other type armature, the first step is to secure the winding data from the original winding, and to set it down on a form card which can be filed for ready reference. In this manner a more or less complete record of all types of armatures can be built up, after which most of the time that would otherwise be spent in tracing old windings can be saved.

If the shop does a sufficient volume of armature winding it will pay to use a burning oven to aid in

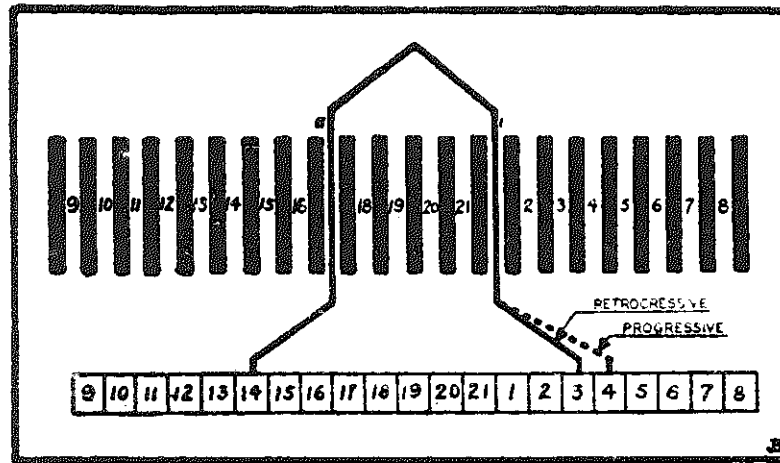

Fig. 1. An example of an accurate diagram of a wave winding. The connections for both a retrogressive and a progressive winding are indicated by the solid and dotted lines

the stripping and cleaning of old cores. After a brief period in an oven of this type all organic matter is completely burned and the wire and insulating material are easily removed. If the commutator is to be used again it should be removed before the burning process. Many of the commutators used in late model armatures use bakelite insulation between the bars, and this is easily ruined. In fact, the great majority of bakelite insulated commutators are badly charred when the armature comes in for rewinding, due to overheating in the generator, and will have to be replaced.

Before removing commutators, the distance they are set back from the bearing shoulder of the shaft should be measured, and the new one pressed on the same distance. Before installing a new commutator, or an old one, the fibre end or star washer should be fitted on the shaft, and the slots in the commutator bars should be scoured bright to make soldering easy.

A special grade of slot insulating paper suitable for almost all automotive armatures can be purchased in 10 pound rolls. This paper is about the right width for most generator armatures, and needs a minimum of trimming. A roll of crepe paper about 1 inch wide is handy for banding exposed parts of the armature shaft, and for insulating the armature neck between winding and commutator leads. Crepe paper can

easily be formed to fit over irregular and tapered parts of the winding.

With the exception of the Ford model T generator, most automotive armatures are wound with two wires in hand. It simplifies matters a great deal and tends to prevent mistakes if one of the wires carries a tracer. In making commutator connections the winder can then place the ends alternately white and tracer, white and tracer completely around the commutator. Number 17 S. C. E. is the size most used in automotive work.

In order to get a symmetrical winding it is best to place all starting leads into the right commutator bars as the coils are wound, leaving the finishing ends free to come out on top of the finished winding. Care must be used to get the right commutator pitch or the armature current will be reversed. Commutator pitch is the number of bars that the winding advances. A change in pitch of one bar will cause the winding to be progressive or retrogressive as the case may be. To explain this matter more fully we will consider a wave winding (used in a four pole generator) having 21 slots and 21 bars.

In Fig. 1 we find the pitch is from bar No. 14 to bar No. 3 in tracing to the right, which gives us an advance of 10 bars, as we do not count the bar in which the coil started. As we wind a second coil, also advancing 10 bars, it brings us around to bar No. 13, which is just behind No. 14, where we started to wind. Then, because the winding has dropped back one bar in tracing to the right, we have a retrogressive winding.

If, however, we made our connections to the commutator as indicated by the dotted line, advancing 11 bars instead of 10 each time, we would discover that instead of coming around to bar No. 13, the winding would cross over the lead to bar No. 14 and enter bar No. 15 making a gain of one bar in tracing through the two coils that make one path around the armature. Because we have gained one bar we call this a progressive winding.

If an armature is wound progressive when it should be retrogressive, or retrogressive when it should be progressive, it will motor in the wrong direction when tested inside the generator, and it will not charge if

driven in the original direction. The armature can be made to charge in the original direction of rotation if the field leads are reversed, but such a change is not always easily made in an automobile generator.

Most of the modern generators, being 2 pole machines, are lap wound, and two forms of winding are in current use, hand wound and form wound. In the former, also called a "balanced" winding, the coils are wound on a form and then assembled in the armature slots. This type of winding has a better mechanical and electrical balance because all coils have the same length and weight of copper, and hence, the same resistance. Two disadvantages of this kind of winding, from the viewpoint of the small winding shop, are that it is much harder to wind in small quantities, and that in working the coils into the slots there is always considerable danger of breaking through the insulation. Since straight hand winding can be substituted satisfactorily for the original form winding, most shops use the latter method in rewinding cores of this type.

The key to a good hand winding lies in the formation of the first three coils. These first three coils determine the shape of the completed winding as all subsequent coils wound must pass over them. The first coils wound should be made to hug the curve of the armature shaft and the core ends. It is necessary to tamp the wires down into the bottom of the slots and keep them under reasonable tension. Coil ends can be tamped into shape by means of a smooth wooden block and a light hammer.

In hand winding, the first few coils wound will occupy the bottom position in the slots on both legs, while the last few coils will occupy only top positions. In the latter case, the finishing ends of the coils will automatically come out on top of the winding, where we want them, but some special provision must be made to bring the finishing ends of the lower coils to the top. One method of doing this is to remove the last half turn of the finishing ends from the slot before a top coil is wound over it. Then at the completion of the top coil, and before the wedge is driven, the finishing ends of the lower coil can be brought upward and placed on top. Since there will be one

set of finishing ends per slot regardless of the position on the armature, there will be no chance of a mistake with this method.

There are a few armatures in the automotive field that do not follow conventional practice. Some of the older Hudson-Essex generator armatures were wound with one dead ended coil to mechanically balance the winding. In other words, when winding the armature with two wires in hand there would be one individual coil left over for which there were no bars on the commutator. The ends of this coil must be cut off and the coil left open circuited. Generator armatures on the older Packards use 20 slots and 41 commutator bars. Since they were wound two in hand there was one odd commutator bar left over. To complete the electrical path of the winding it was necessary to cross connect one pair of bars on opposite sides of the commutator. This and other typical types of automotive windings are shown in some of the accompanying charts.

A very large number of the cheap replacement automobile generator armatures on the market are wound with wire that is one size smaller than originally specified. Rewinders sometimes fall for the temptation of cheaper material and labor costs, but the shop that intends to establish a reputation for a good product should avoid this pitfall. The use of smaller wire gives a higher internal resistance to the winding and will cause the generator to heat up more rapidly. If fewer than the usual number of turns are used, even of the proper size wire or larger—the result will be to lower the efficiency of the machine, and a higher speed will be required to obtain a normal charging rate.

The rewinding shop is occasionally called upon to rebuild or convert an old generator to a different purpose. Wind chargers, arc welders and 110 volt generators for public address systems are some of the common uses of old automobile generators. The change from 6 to 12 volts, or from 12 to 6 volts is one that is often requested. Some experimenting must go along with many of these changes, but there are certain rules than can be followed.

To double the voltage of a generator the rule is to

use a size of wire that is three numbers larger. This wire will be half the cross sectional area, and twice the number of turns will be used. Thus, if a field coil was originally wound with 100 turns of No. 18 wire, it could be rewound, in approximately the same space, with 200 turns of No. 21 wire, and would be suitable for operation at twice the former voltage. It is not always possible to double the turns on an armature for various reasons, but if the original winding is replaced with one of one or two numbers larger, and all available space is filled, the results will usually be satisfactory.

Other operations on the rewinding of automotive type armatures, such as soldering, turning, undercutting, dipping and baking follow standard practice and offer few obstacles. Many motor shops have taken up automotive rewinding as a side line, and have reached the point where this class of work carries much of the overhead through dull seasons. Since it is a branch of the business that demands little additional investment, and since there is a fairly constant demand, it is something to consider.

Chapter 11

Rewinding Small Polyphase Motors

THE single-phase motor because of its wide use in domestic and commercial applications is, and perhaps always will remain, the principal source of revenue of the small motor repair shop. Many winders, who have mastered the technique of the single-phase motor, hesitate to branch out into the two-and-three-phase field for the simple reason that so much of the latter type of work is large and heavy, and also because it requires additional equipment, materials, and specialized knowledge. These are facts that are well worth considering, and in the majority of cases the wisest plan is for the small motor shop to act as a local agent for some concern making a business of repairing the larger polyphase motors.

Numerous requests have come to us, however, for some information regarding the rewinding of the smaller two- and three-phase motors. Most of these requests have come from shops in the smaller cities and towns where an additional job or two often spells the difference between a good and a bad week, at least from the financial point of view. In most localities, the percentage of two- or three-phase motors in the small and fractional horsepower group is small, yet a job is a job and may be the means of rounding out a full week's time.

Many of the winders who have requested additional information on the winding of polyphase motors have a good working knowledge of single-phase windings, but want a few more pointers before venturing on either two- or three-phase work. To these men and others who may be interested, the following notes are presented in the hope that they will clear up the major points in which these windings differ from the usual single-phase type.

It may be stated roughly that almost all of the smaller two- and three-phase motors use one of the following types of winding:

1. Basket winding.

Top of coil No.	1	2	3	4	5	6	7	8	9	10	11	12	13	14	15	16	17	18	19	20	21	22 etc.
Slot No.	1	2	3	4	5	6	7	8	9	10	11	12	13	14	15	16	17	18	19	20	21	22 etc.
Bottom coil No.	1	2	3	4	5	6	7	8	9	10	11	12	13	14	15	16	17	18	19	20	21	22 etc.
Top of coil No.	1	2	3	4	5	6	7	8	9	10	11	12	13	14	15	16	17	18	19	20	21	22 etc.
Slot No.	1	2	3	4	5	6	7	8	9	10	11	12	13	14	15	16	17	18	19	20	21	22 etc.
Bottom coil No.	1	2	3	4	5	6	7	8	9	10	11	12	13	14	15	16	17	18	19	20	21	22 etc.

Charts such as these are useful in determining the proper coil span for a given stator when a basket type winding is to be used. The upper chart indicates that a coil span of 1 and 12 will be practicable for a 48 slot stator to be wound for four poles, three-phase. The lower chart indicates that a coil span of 1 and 9 will not be permissible

2. Two layer diamond coils, one coil side per slot.
3. Two layer flat diamond mush coils.
4. Two layer diamond mush pulled coils.
5. The flat strap copper conductor winding.

The methods of forming or placing each type of winding will be described in the order given above.

There are two prime essentials that go with the basket type of winding. One is that the total number of stator slots must be even, and the other is that the coil span, or number of slots spanned by one coil, must be an odd number. In the latter case the span must be 1 and 6, 1 and 8, 1 and 10, etc., for to get an odd span the last number must be even. For an example, let us consider a 48 slot stator that is to be wound for 4 poles and three-phase operation. We will choose a coil span of 1 and 12 and check it out on a penciled chart to make certain it will work out. A simple chart consists of the numbers from 1 upwards written in a line across a sheet of paper, such as that shown in the accompanying diagram. A study of the chart will show that one slot is skipped in beginning each coil so that there will be a vacant slot available for the finishing side of some other coil. Almost all basket windings have only one coil side per slot. The chart below further proves that the winding will work out correctly in as much as we find that wherever we have either a top or a bottom coil side marked above or below a slot number, there is none charted on the opposite side of the chart number. Thus Slot No. 12 has the top side of Coil No. 1, Slot No. 13 has the bottom side of Coil No. 7, Slot No. 14 has the top of Coil No. 2, etc.

Now to prove our point, let us see if this stator could be wound with a pitch of, say, 1 and 9. (See lower chart in accompanying diagram.) In looking over the chart, we see that this pitch is not correct because slot No. 9 would contain two coil sides, as would slots 11, 13, 15, etc., while the even numbered slots, 10, 12, 14, etc., would contain no coil sides. Therefore, when uncertain of the proper coil pitch to use, it is a good plan to chart it out in advance.

In the basket winding any slot can be called No. 1 for the start, and the throw, or slot for the other coil side, can be counted in a clockwise rotation. In wind-

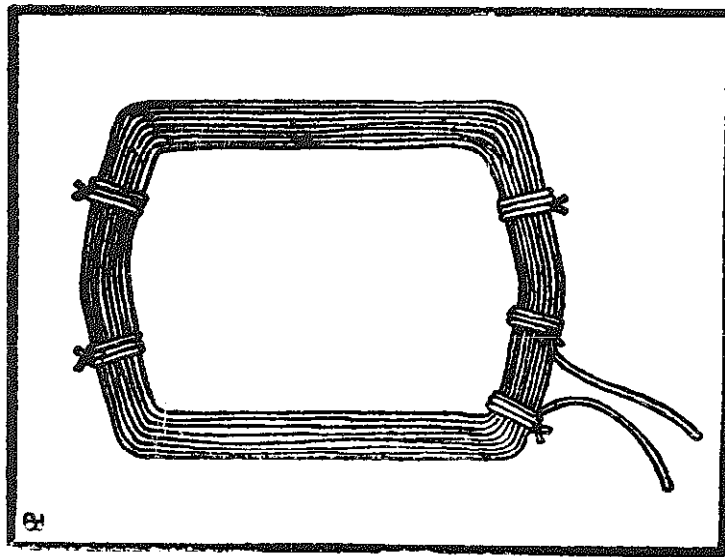

Fig. 1. A typical wound coil for a basket type winding is shown here

ing this 48 slot stator using a 1 and 12 pitch the first five coils, namely Nos. 1, 3, 5, 7, and 9, must be left with the top sides left out of their respective slots. These are called "throw" coils and their loose sides cannot be placed in the slots until other coil sides have been placed in Slots 2, 4, 6, 8, and 10. The first coil that can be inserted at both sides in one operation is the coil going into slots 11 and 22.

Basket coils are first wound around suitably spaced pegs on a board, or on a coil winding machine, and are tied at several points to hold the wires together. After the coil sides are placed in their respective slots, the ends are taped from iron to iron and they are formed to the proper shape by means of a fiber drift and a rubber or rawhide mallet. The slot insulation should extend somewhat from the core and the taping can be made to cover the slot insulation and make a sealed joint. A typical basket coil is shown in Figure 1.

The two-layer winding with only one coil side per slot usually requires diamond-shaped coils of the pulled (mush) type and differs from the basket winding in that as many slots are skipped in laying the coils as there are coils per group (See Figure 2).

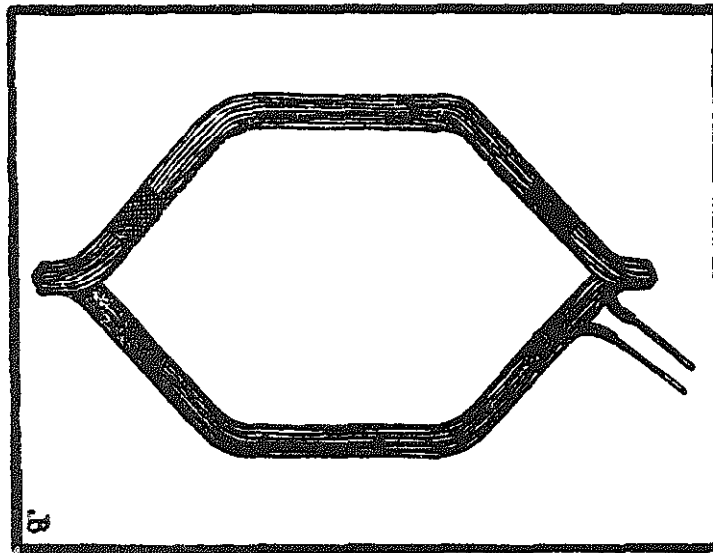

Fig. 2. A typical diamond-shaped coil of pulled or mush type for two-layer windings

The upper sketch of Figure 3 shows the arrangement if there are to be two coils per group. Two coils are inserted, then two slots are skipped before threading in the second pair. The lower sketch shows the arrangement for this type winding when there are three coils per group; insert three coil sides, then skip three slots. The slots that are skipped, of course, will be filled later with the finishing sides of other groups.

The possibility of using any given pitch with this type of winding can be found by making up a chart as explained for the basket winding. Two coil sides can not occupy a single slot and the total number of coils will be just one half of the total number of slots. The slots are preinsulated and the coils are taped after installation just as in the basket winding.

Perhaps the most common type of winding for the smaller polyphase motors is the two-layer winding with flat diamond mush coils. These coils are preformed and partially taped before they are inserted. Figure 4 shows one of these coils ready for insertion in the stator. Note that the tape extends in an inch or so on what will be the bottom side of the coil, while on what is to be the top side the tape lacks

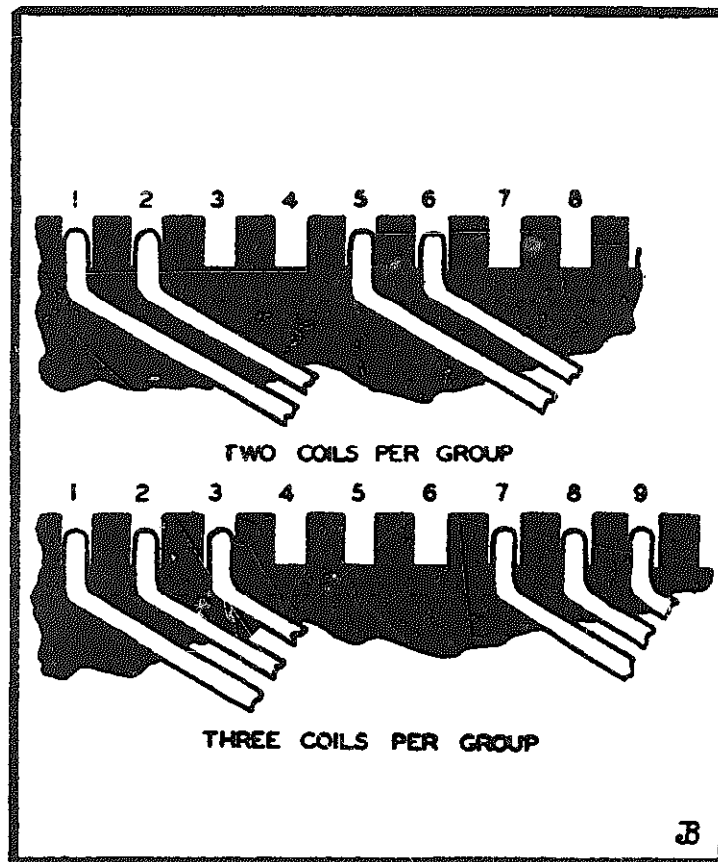

Fig. 3. Method of starting a two-layer winding with one coil side per slot

an inch or so of reaching the band. The leads are brought out and insulated near the diamond nose.

The steps followed in placing this type of winding begin with the slot insulation. A heavy composition cell is formed to fit the slot, with the top edges slightly below the slot opening. Next a treated cloth "slider" is inserted in the slot as shown in Figure 5. The winder now flattens out the center of the untaped portion of the bottom side of the coil with his hands, and slips this flattened section into one end of the slot. By careful manipulation he pushes the coil across the slot until the far end of the coil will drop into the slot. The coil side, now in the slot for its full length, is carefully centered. Make certain that the "slider" is also in the proper position.

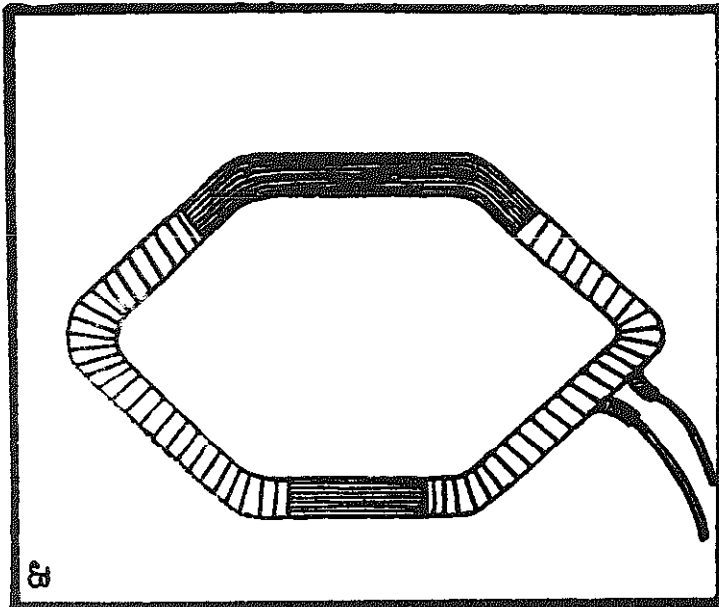

Fig. 4. Flat diamond mush coils, as shown here, are only partially taped to facilitate insertion in slots

The top half of the coil requires a little more time to place. It must be fed into its slot one wire at a time, and for this reason the top side is not taped right up to the bend and beyond as is the bottom side. The extra taping to cover the exposed wires of the coil must be done after the coil is in place. After this insulation is in place, a triangle of treated cloth is slipped between this coil and the coil below for added protection against shorts. The slot, now containing two coil sides, is ready for wedging.

We can now go back to the bottom side of this coil and prepare the slot to receive the top side of a later coil. The cloth "slider" is pulled up along with the bottom coil side until the coil side jams in the neck of the slot, and is then trimmed off as shown in Figure 6. The coil is now pressed down into the bottom of the slot, the sides of the "slider" are bent over and a fibre strip is forced down on top. Another cloth "slider" is used in the same way for the coil side that will later go into the upper section of the slot.

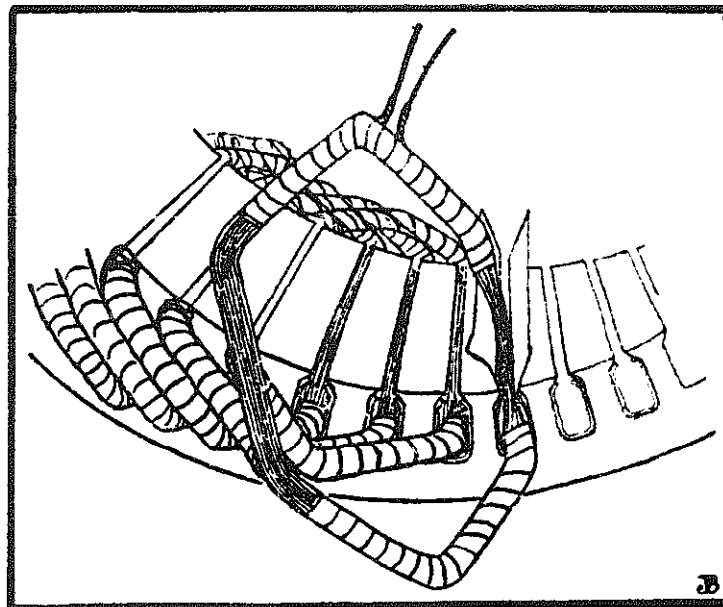

Fig. 5. To install flat diamond mush coils in slots, the bottom coil side is flattened to enter slot while the top coil is threaded in one or two wires at a time

The two-layer diamond mush pulled coils form a type of winding that is similar to a two layer flat diamond winding in most respects. These coils are wound with insulated wire—often double cotton covered—on a shuttle in the form of a loop, or in a regular coil forming machine. In the former case the loops are “pulled” out on a universal type of coil former or “puller,” so as to arrive at the desired shape. Since the coils for this particular type of winding are not taped, they must be tied together at the diamond points to maintain their shape.

Since this type of winding uses untaped coils, extra caution must be used in insulating between coils, and especially so between phase coils. Triangles of a good grade of suitably treated cloth should be inserted between all coil ends, and in the case of the phase coils there should be a double layer. These cloth triangles should be cut to the general shape of the coil ends but should be allowed to extend at least a half an inch on each side and at the diamond point, as shown in Figure 7.

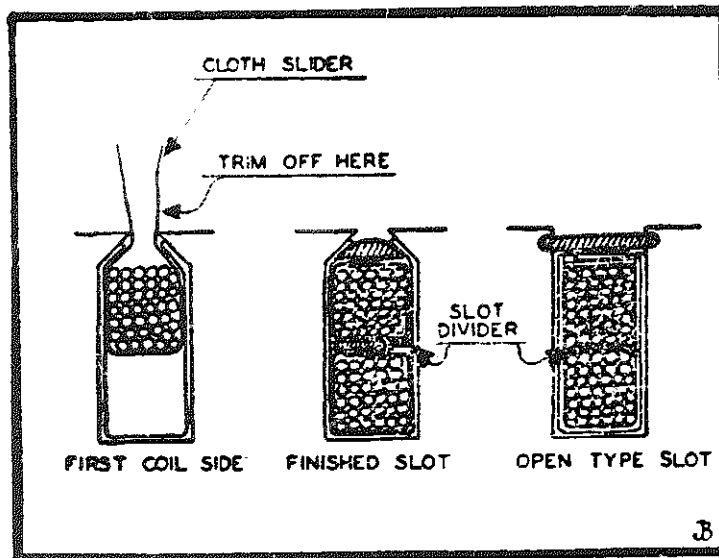

Fig. 6. Winding trouble can usually be traced to improper insulation. The proper method of insulating slots is shown here

Windings with untaped coils are usually used on motors with sealed end bells. Dirt, oil, water, other liquids, fumes, etc., are enemies of insulation, and where these can get to the windings through openings in the motor frame the taped coils will give the best service. However, there are many motors of the dust proof, water proof and explosion resisting types where the untaped type of coils can be expected to give good service. As a general rule, stators with untaped coils are given extra attention in varnishing and baking.

The last type of winding to be considered is one wound with threaded-in strap-copper coils. Few motors of this kind will find their way to the small motor shop. Where the slot opening is full width, these coils can be formed and taped before going into the stator, but with partially closed slots the copper straps must be inserted one at a time. To do this, the inner and outer turns must be inserted through the slot first, and the center turns last. Figure 8 shows the order in which a five-turn coil would be fitted into a slot, the opening of which is just wide enough to pass one turn at a time. The numbers above represent the order in which the turns

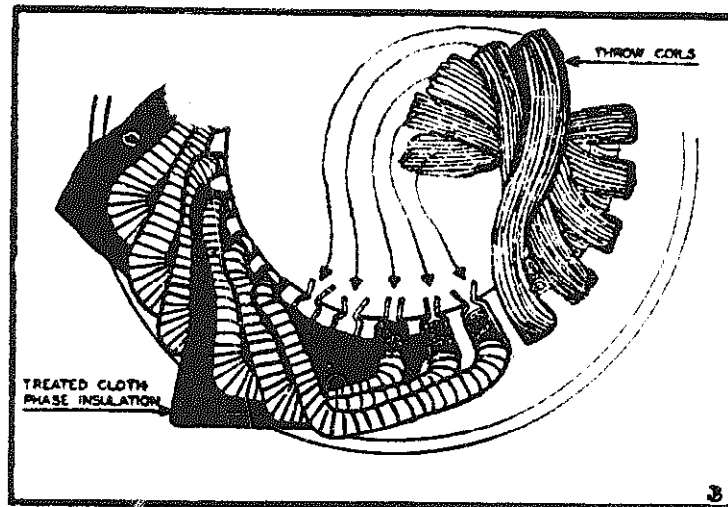

Fig. 7. This sketch shows the use of insulating cloth triangles between phase coils and the closing of winding with "throw" coils . . .

occur in the actual coil, and the lower numbers designate the order in which they pass through the slot opening.

And now for a few last notes on these types of windings. When a winder experiences any trouble in laying any of these windings, it can usually be traced directly to inadequate slot insulation or to improperly formed or "sized" coils. Coils should be accurately wound from a pattern secured from one of the original coils taken from the motor intact. You can seldom stretch a coil and get away with it with any degree of satisfaction. Therefore, it is the practice in many shops to wind the new set of coils *slightly* larger than the originals. If this is done, it often saves a great deal of time. On the other hand, coils that are too large make a sloppy and unsightly job. The best bet for the beginner is to make up three or four coils and then try them in the stator before proceeding to wind the whole group. Experience is the biggest factor in this job—and experience comes only through trial.

Phase insulation, that is, the insulation between coils connected to different phases, is a very important point on all polyphase motors. Many rewinders chalk the slots in which the beginning of each phase

group of coils will start. This gives an accurate reminder of the places where it is necessary to double the insulation. The phase coils form the boundary between phases and as such are always subject to phase potential. On the other hand, coils of the same phase have but a low potential between them.

Polyphase windings must be laid out according to some diagram. They will either be regular or uniform, alternate or irregular, in grouping. In a uniform grouping, all groups fill an equal number of slots, and contain the same number of coils. In the case of an alternate grouping every other group consists of an equal number of slots and coils. Irregular grouping is sometimes necessary because of special conditions, and in such cases there is no apparent system or uniformity in the number of slots per group. They will, however, have to balance out nearly equal in coils per phase over the whole of the winding.

Taping coil ends after the coils are in the slots is an operation that must be done with care. The tape should be applied very tightly and anchored in place with quick drying dope. The best practice calls for allowing the slot insulation to extend beyond the core as much as possible, the tape then being applied over this to form a perfect bond. If the taping is not snug and well anchored it will pull away during the forming, dipping or baking process and leave a spongy mass, or it will fail to protect the coils where protection is most needed.

After all coils have been placed and wedged, the winding must be inspected for mechanical faults and tested for electrical defects. Inspection and measurement will reveal if any coil ends are higher than the stator bore, or if they will rub against the end bells when the motor is assembled. The coils should clear the diameter of the stator bore by at least an eighth of an inch if possible. High coils can be tamped down carefully with a fibre drift and a light hammer. The fibre drifts should have smooth surfaces and rounded edges. Never hit the coils with iron or steel. The same method should be used where one or more coil end extend too far from the core and touch the end housing which may result in trouble later.

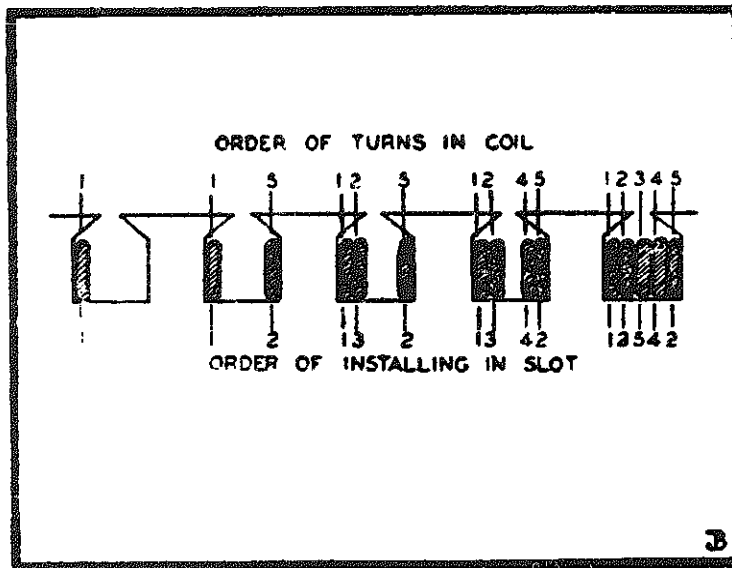

Fig. 8. Special care must be taken in inserting solid strap copper coils in partially closed slots

Chapter 12

Capacitor Motors

THE condenser or capacitor type motor has been used experimentally for many years. Its recent popularity, however, has resulted from the rapidly developing field of electric refrigeration which has brought about the commercial development of these motors and made them standard equipment on many of the small compressing units. Quantity production made the manufacture of efficient low-priced condensers possible and led to the almost universal adoption of this type of motor in household refrigerating units and in other fractional horsepower driven equipment.

Much of the credit for the design and improvement of the capacitor motor must be given to Professor Benjamin F. Bailey of the Department of Engineering Research at the University of Michigan. Experiments with motors of this type between the years

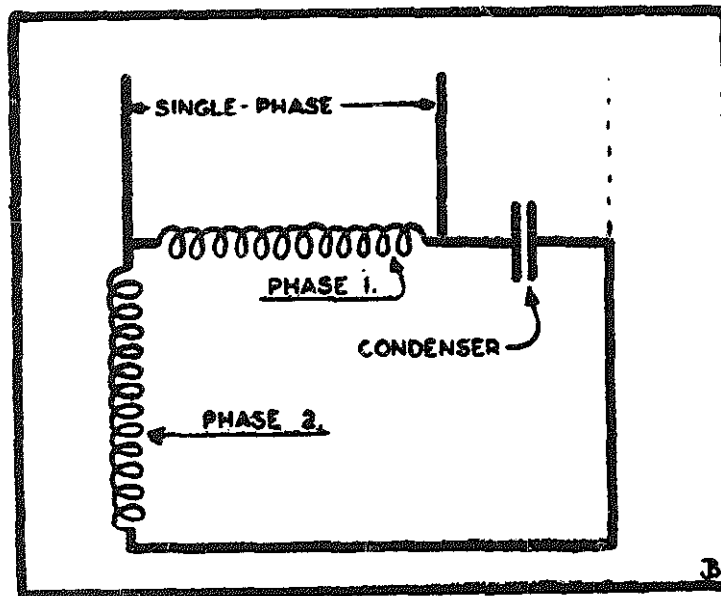

Fig. 1. Two-phase motors can be operated on single phase lines by inserting a condenser across one phase

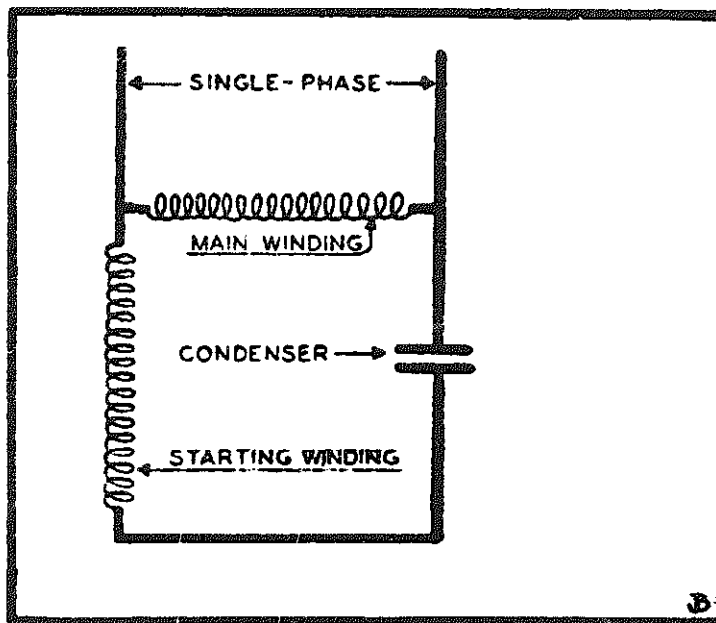

Fig. 2. Diagram of a condenser motor. Note similarity to the two-phase diagram in Fig. 1.

1923 and 1929 were financed by the Detroit Edison Company in the interest of the entire electrical industry.

There are several reasons why the capacitor motor has replaced the types of motors formerly used. First, the condenser motor has a higher efficiency than other single-phase motors; second, it has a higher power factor; third, it has excellent starting characteristics; fourth, it is simple in construction; and last, it is quieter in operation. Every one of these features is valuable in any application, but especially so in the modern domestic type of refrigerating cabinet.

In design the single-phase capacitor motor is very much like the two-phase induction motor except for the fact that the two windings need not be similar. A two-phase motor can be operated from a single-phase circuit if a condenser of proper capacity is inserted in one of the phases. See Figure 1. Some form of automatic switch is incorporated in almost all single-phase condenser motors to reduce the effect of the condenser when the rotor attains full speed. If

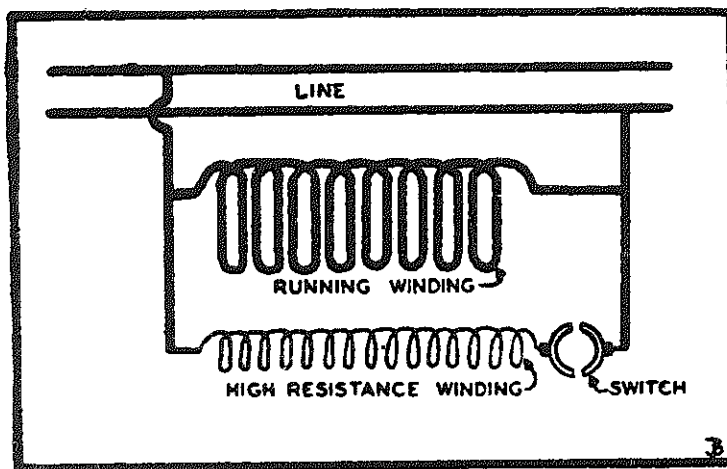

Fig. 3. Diagram of a typical split-phase motor

this were not done it would be impossible to have the motor operate efficiently under both starting and running conditions. If the condenser was of the right value for starting it would be too large for running, while if the capacity of the condenser was suitable for running under load it would be inadequate for starting that same load. The automatic switch is used to control the value of the capacitance under both starting and running conditions.

In discussing the various elements of capacitor motors one winding is referred to as Phase 1, or the main winding, and the other is called Phase 2, or the condenser winding. This latter winding is sometimes termed the starting winding. Perhaps a better way to distinguish between the two windings would be to refer to one as the main phase, and the other as the condenser phase. In other words, the main phase is the one connected across the line and the condenser phase is the winding that connects to the line in series with the condenser. The two windings are identified in Figure 2.

In the ordinary two-phase motor (and similarly in the case of the three-phase) the currents flowing through the two separate windings are out of phase with each other. The magnetic waves of each phase are some distance apart and reach maximum values at different instants giving the effect of a rotating

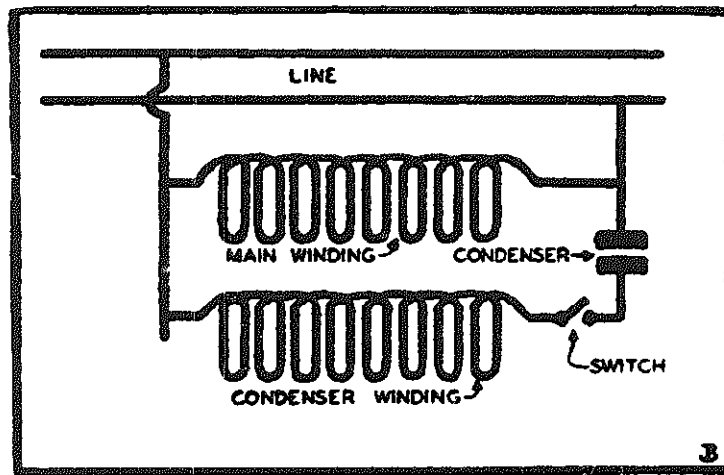

Fig. 4. Diagram of a split-phase condenser motor. Both windings are nearly equal in weight and turns

magnetic field that causes the rotor to revolve in the same direction. That, briefly, is the theory of operation of the two or three-phase (polyphase) induction motor, and accounts for its self-starting characteristics.

On the other hand, single-phase motors are not self-starting unless some special provision is introduced to create a rotating magnetic field similar to that of the polyphase motor just described. A motor can be provided with a single field winding and a squirrel cage rotor that will deliver good power if the rotor is brought nearly to running speed by an external means. Such a motor, however, will not start itself and is useless for most purposes.

Many methods have been devised to make single-phase motors self-starting. Repulsion and repulsion start-induction run are two methods in use but both require a wound rotor brushes and other auxiliaries. A simpler method utilizes the two-phase motor principle by diverting the single-phase current into two paths, one path being through the main or running winding, the other through a starting winding. To accomplish the desired result, that is, to cause the current in one winding to lag behind the current in the other and produce the rotating field necessary to obtain self starting characteristics, the starting wind-

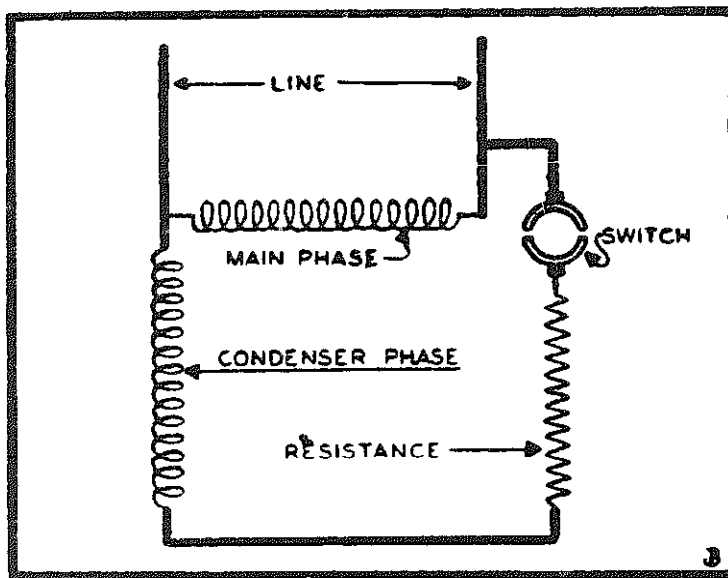

Fig. 5. Diagram of a resistance split-phase motor having windings similar to a condenser motor. An out-of-phase current in the starting winding is produced by the resistance.

ing was designed with a resistance much greater than that of the main or running winding.

Hundreds of thousands of this type of split-phase motor, familiar to nearly everyone in the service field, have been manufactured. To supply the necessary out-of-phase current relation, the starting winding was wound with many turns of fine wire and the coils were placed at an angle—usually between the running coils. Since the starting coils were required only for starting, and since they were prone to overheating if left in the circuit for any appreciable period, a centrifugal switch was provided to disconnect the starting winding as soon as the rotor attained approximate running speed. A diagram of a split-phase motor of this kind is shown in Figure 3. Note the similarity of this diagram to that of a plain condenser split-phase motor as shown in Figure 4.

The essential difference in the split-phase motor shown in Figure 3 and that illustrated in Figure 4 is that in the former the higher resistance of the starting winding causes an out-of-phase relation between the current in that winding and the current in the

main winding, while in the capacitor motor shown in Figure 4 an external condenser connected in series with the starting winding causes a similar out-of-phase relation. In both cases, the difference in phase between the currents in the two windings results in the formation of a rotating magnetic field, the essential characteristic of a self-starting single-phase motor.

Although the starting winding of the ordinary split-phase motor usually consists of many turns of small wire, the starting winding of the capacitor motor may have more or less turns than the main winding. In many instances the size of wire will be the same in both windings. The relative size and number of turns of the starting winding of the capacitor motor will depend upon the type of service for which the motor is designed.

A forerunner of the condenser split-phase motor was the type known as the resistance split-phase motor. Here the two windings were nearly equal in weight and turns, as with the condenser motor, so that the phase difference in the winding currents had to be brought about by some other means. This was accomplished by inserting a resistance in the starting winding circuit. This resistance served about the same function as the condenser does in the capacitor motor, but not as efficiently. A diagram of a resistance split-phase motor is shown in Figure 5.

The characteristics of the condenser are most important factors in the starting and running efficiency of the capacitor motor. To obtain best results, the capacitance value of the condenser should be large when the motor is starting and should then be reduced gradually as the rotor speed increases. The highest efficiency could be obtained by varying the capacitance to suit each change in the load, but this would require a complicated system of taps and switches. On the other hand, the use of a fixed condenser suitable for the running period will only provide about 50% of the running torque for starting purposes. In a great many applications this torque would be sufficient for starting, and some means for increasing and decreasing the capacitance for starting and running must be used.

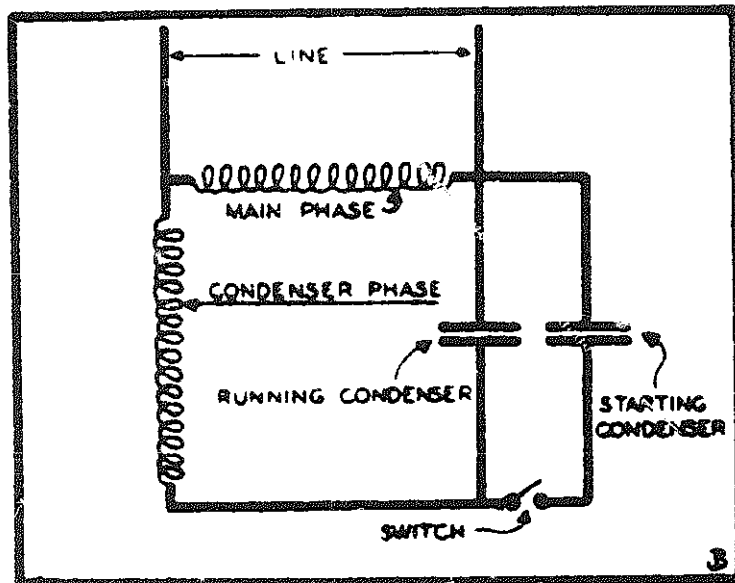

Fig. 6. Condenser motor with windings similar to a resistance split-phase motor. The condenser produces the out-of-phase current relation which gives the advantages of two-phase operation.

If a single condenser is used, connected to the starting winding by means of an automatic switch that opens at running speeds, the result will be a motor of the type commonly known as condenser start-induction run. A motor of this type does not approach the usual two-phase motor efficiency. To obtain a higher efficiency, a double condenser is used in many motors both sections being used for starting and one for running. This system gives the condenser motor characteristics similar to the two-phase motor, and a large number of this type have been built.

Figure 6 shows a diagram of a typical motor of this sort. Two condensers are employed, one of which is always in the circuit of the starting or condenser winding. The second condenser is connected to this same circuit during the starting period by means of the centrifugal switch, and is disconnected when the motor reaches approximate running speed. Thus for all practical purposes the motor is operating as a two phase motor, through the medium of the first condenser, although energized from a single-phase cir-

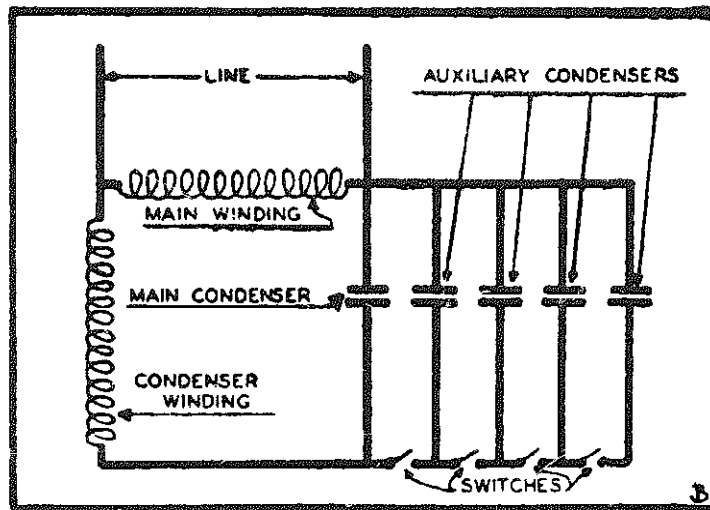

Fig. 7. An ideal but impractical design of a condenser motor. Variable capacitance to suit changing load conditions would increase efficiency but at the expense of simplicity.

cuit. Both the running and the starting condenser can be, and usually are, housed in the same container.

As mentioned previously, the efficiency and power characteristics could be increased to a certain extent if three, four or more condensers were suitably connected in the condenser winding circuit as indicated in Figure 7. The advantage to be gained is rather slight, and would be more than offset by the difficulty of adjusting centrifugal switches to cut in and out in the proper order during speed or load changes. A small measure of efficiency is sacrificed, therefore in the interests of simplification.

An auto transformer, in addition to the condenser—is used in some condenser motors. The value of the capacitance is fixed at all times and the variation to suit starting and running conditions is obtained by varying the voltage applied to the condenser terminals. The circuits of such a motor are shown in Figure 8. During the starting period a higher voltage is applied to the condenser than that required for running. The effect is about the same as though the capacitance was changed, but the efficiency as a whole is lowered because of the losses in the transformer.

Now that we have seen how the size of the conden-

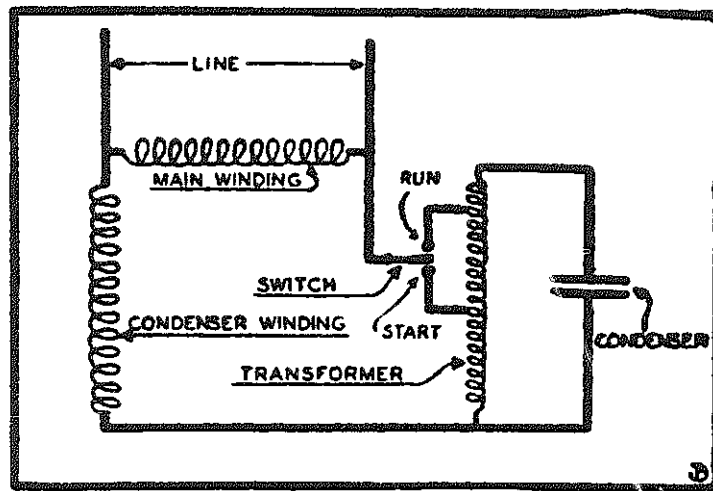

Fig. 8. A condenser motor using a transformer to vary capacitance.

ser affects the starting ability and power factor of the capacitor motor, let us consider the motor windings. The ratio of turns in the two windings as well as the weight of the copper has an important effect on performance. The starting torque of the motor can be influenced considerably by changing the ratio of turns in the two windings.

The size of wire used, as well as the number of turns, in the main winding are more or less definitely established for a motor of any given output. If the number of turns in the main winding are too large the pull-out torque will be too low for many uses. If the number of turns in the main winding are too small the efficiency and the power factor will be seriously decreased. For these reasons the original design should be followed closely when rewinding the main phase winding of a capacitor motor.

The design of the starting or condenser winding may be subjected to more variation than the main winding. The size of wire and the number of turns in this winding can be varied so as to obtain the approximate starting performance desired. If the number of turns in the starting winding is doubled, the wire size reduced to one half the former cross section, and the condenser replaced with one about one-fourth of the former value, the torque will be reduced

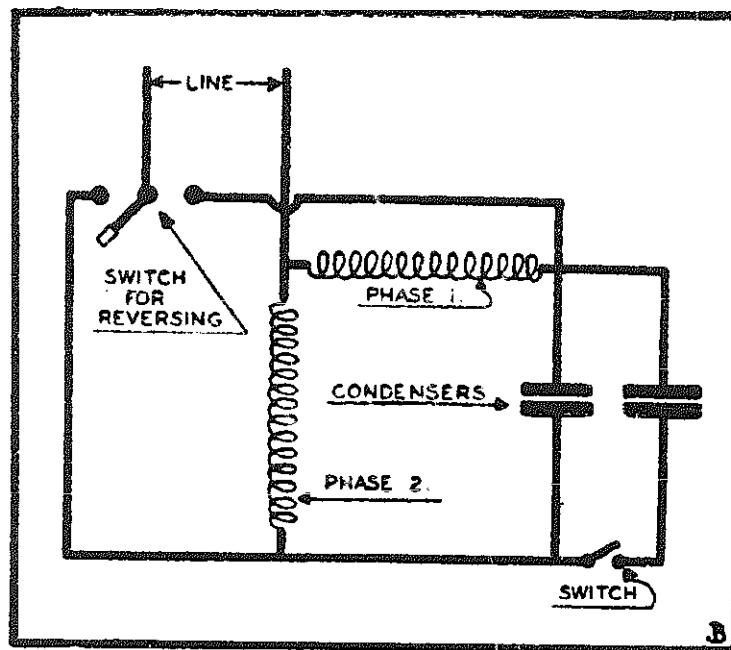

Fig. 9. A method of reversing direction of rotation of a condenser motor

approximately fifty per cent. If a greater torque than that originally available from the motor is required, the starting winding should be rewound with fewer turns of larger wire than that formerly used and a much larger condenser should be used.

Condenser motors are reversible but the change can only be made externally when the manufacturer has provided the proper taps or terminals for this purpose. Other types must be opened and the internal connections adjusted to obtain a change in rotation. Figure 9 shows one method of reversing an ordinary capacitor motor by means of a switch mounted on or near the motor. A single pole, double throw switch connected as shown will allow the motor to be operated in either a forward or reverse direction.

Since the condenser is such an important factor in the operation of the capacitor motor it might be advisable to discuss the types in use and their construction. Both paper and electrolytic condensers are used with capacitor motors, one of each kind being used on some motors. Where this is the case the electrolytic condenser is used in the starting circuit, and the

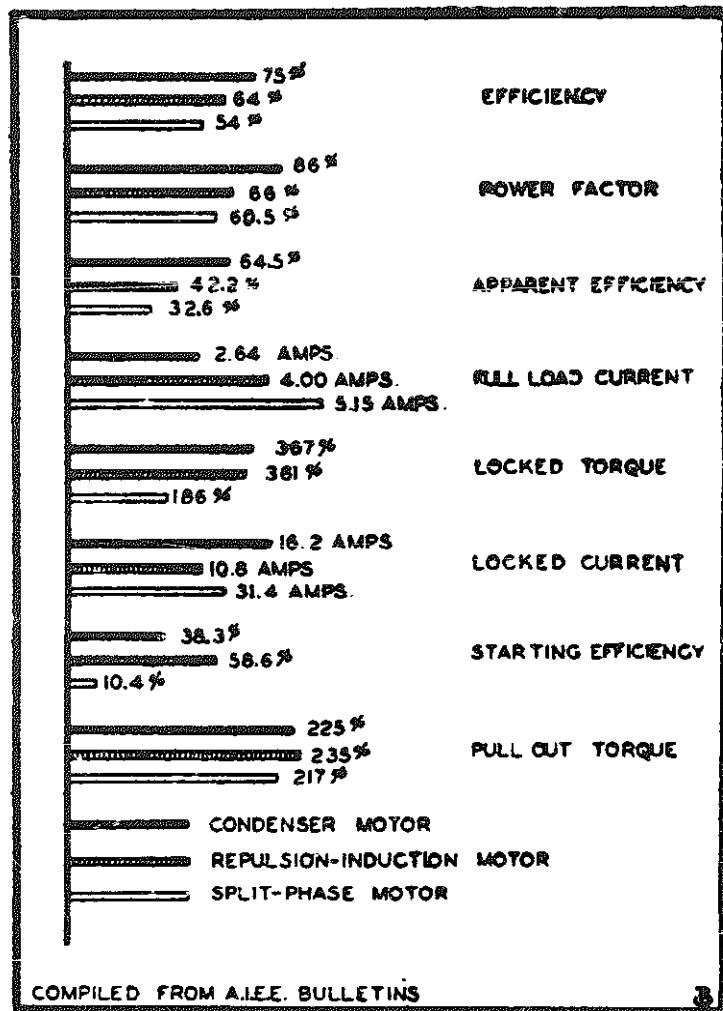

Fig. 10. Comparison chart of condenser, repulsion-induction, and split-phase motors of typical 1/4 hp size

paper one in the running circuit.

Paper condensers able to stand the strain of starting the motor are made but have found little use for this purpose. The paper type, or dry, condenser has the advantage of high efficiency but at the same time has two serious disadvantages from a practical standpoint. One is the initial cost of condensers of the size usually required for starting, and the other is the matter of bulk. The opposite is true of the electrolytic type. It is small in size for its capacity, the manufacturing cost is low, but internal losses are high. Since the use of a condenser in the starting circuit is

but momentary these high losses are not of consequence.

In a test conducted by one of the well known testing laboratories on the relative merits of the condenser, the repulsion-induction, and split-phase type motors, the general results shown in Figure 10 were obtained. Each of the motors used in the test was one of the best and most efficient types available commercially, and all were of the popular one quarter horsepower size.

Chapter 13

Reversing Rotation of A-C and D-C Motors

ASIDE from burned out windings, worn bearings and rough commutators, one of the main causes of having motors brought to the shop is that of having the direction of rotation reserved. Such a task, no matter how simple it may be for the service man, is usually a great mystery to the customer. In most cases the owner of the motor has picked it up to operate some piece of machinery and finds out later that it does not turn in the right direction to suit his need.

A case of this kind happened last winter. The engineer aboard a fair sized yacht was instructed by the owner to install some sort of a ventilating system to rid the living quarters of the boat of the cooking odors and heat from the ship's galley. Instead of ordering an electric motor powered blower made for

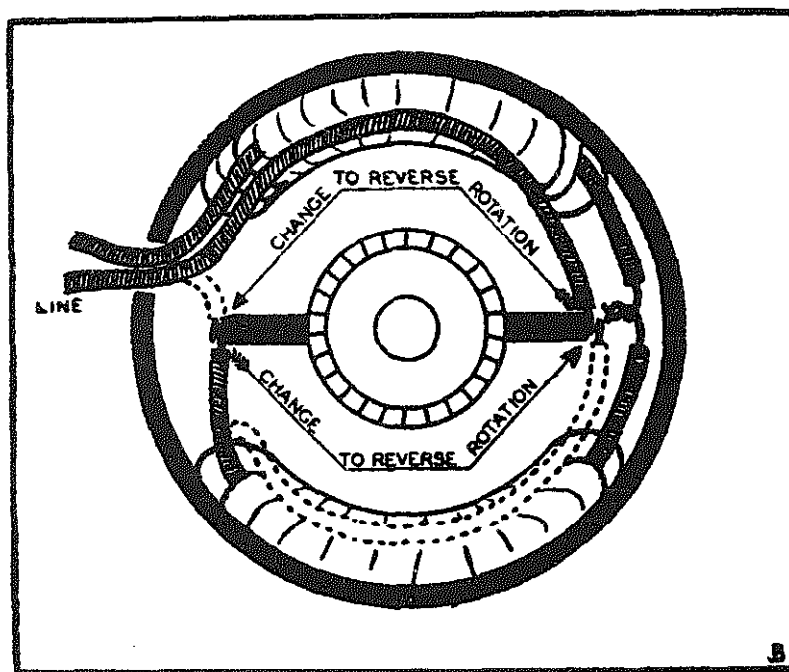

Fig. 1. Changes necessary to reverse rotation of a series motor shown by dotted lines

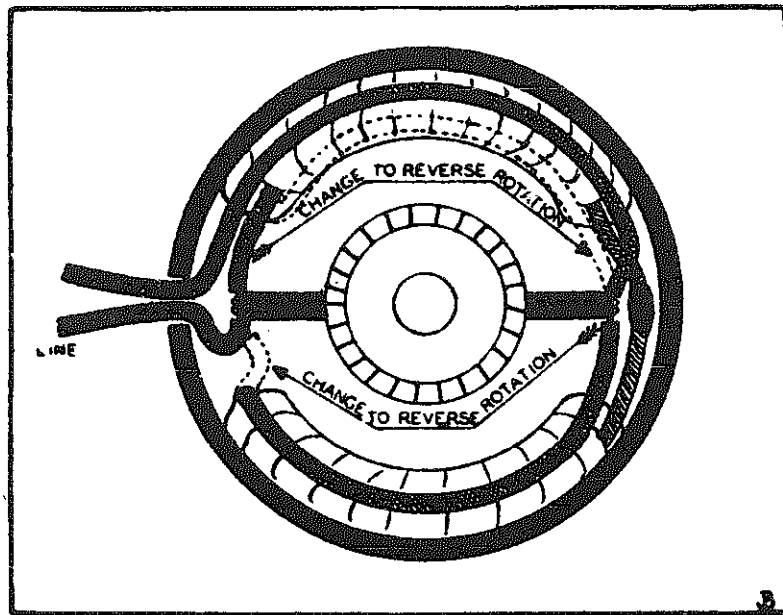

Fig. 2. Changes necessary to reverse rotation of a shunt wound motor are shown by outline marks

the purpose, the engineer, thinking himself to be an expert electrician, shopped around among the electrical stores and purchased a $\frac{1}{4}$ H. P. motor and a set of fan blades. With the aid of a tinner he rigged up an exhaust flue through the deck and installed the improvised blower close by the galley range.

Several days later when the yacht was forty miles down the coast the engineer, prompted no doubt by the irate owner, put through a long listance call to the shop where he had purchased the motor. It seemed that this ventilating system worked in a reverse manner from what had been expected of it, and instead of carrying away the heat and fumes from the galley to the outside air, it was filling the space below the decks with the smell of frying fish and British Thermal Units from the galley range. The main theme of the conversation was that they wanted a service man to reverse the motor, and they wanted him quick.

The outcome of this little incident, as far as the shop was concerned, was that the electrician sent on the job collected a twenty dollar bill for his time and expenses for doing what would have ordinarily been a one dollar job. And to show that he was a good

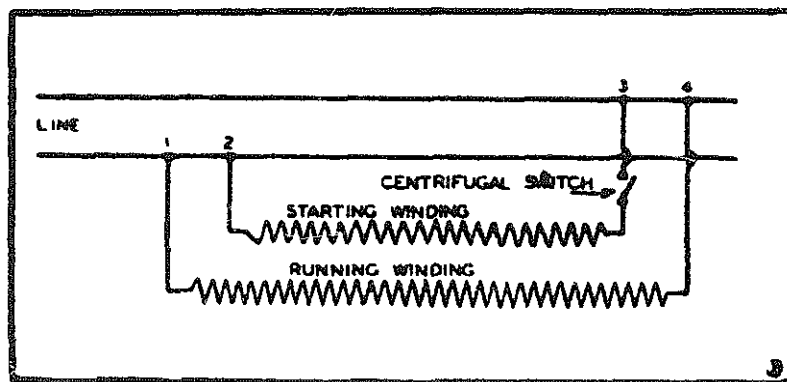

Fig. 3. Connections of a split-phase motor. To change rotation reverse either terminals 1 and 4 or 2 and 3 in relation to power line

merchandise as well as an electrician, he sold the owner two factory built blowers, one for the galley and one for the engine room, to be installed as soon as they arrived.

Most motors are easy to reverse if the principles involved are understood. Different methods must be used to reverse the rotation of the various types of motors, and a small amount of space will be given here covering the types in most popular use.

First to be considered will be direct-current motors of the types in general use, as the same instructions will do for 6, 12, 32 and 110 volt machines.

Direct current motors are reversed by reversing the direction of current flow through either the field or the armature, but not both. The circuit of an ordinary d-c motor of the series type is shown in Figure 1, and that of a shunt connected motor in Figure 2. As it is usually easier to change the field leads at the brush holders, thus reversing the path of the current through the armature, this is the means most often employed. In the diagrams, the original connections to the brushes are shown as solid lines, while the changes made to reverse the rotation of the armature are indicated by broken lines. It is sometimes necessary to lengthen either one or both of the field leads in order to reach the desired brush holders, or to keep the wires from passing too close to the commutator.

On the smaller d-c machines, and those having

either solid end bells or ones with small inspection holes, it will be necessary to remove the commutator end housing to accomplish the job of reversal. In any case this is usually a small matter and the entire job can generally be completed in a half hour at most. Small universal motors—a-c or d-c—are reversed in the same manner as the series direct-current motor.

Alternating current motors are reversed in several different ways, depending upon the type of motor under consideration. In the case of the common split-phase motor we must get at the junctions of the windings in order to change the direction of rotation, and this means partly dismantling the motor.

The split-phase motor has two distinct windings, the heavy low resistance running winding, and a smaller high resistance starting winding. To change the direction of rotation of the rotor the terminals of either one of the windings must be interchanged. That is, the line terminals of the running winding can be switched in relation to the line, or the two ends of the starting winding can be shifted on the line. Do not make the mistake of changing the terminals of both windings or no change of rotation will result; leave one winding as it was found.

Figure 3 shows a schematic diagram of a split-phase motor winding. The points marked 1, 2, 3 and 4 are the connections of the two windings to the line. To change rotation interchange 1 and 4, or interchange 2 and 3, but never all four points.

Repulsion-induction motors are perhaps as a class the easiest on which to change rotation. Having a wound rotor, a commutator and set of brushes and brush holders similar to d-c machines—save that the brushes are shorted together through the metal of the brush rigging—makes a change in direction mechanically simple. Motors of this type are provided with an external means of shifting the brush holder a certain number of degrees either side of the neutral. Narrow slots, known as index marks, are cut into the metal of the end bracket in the proper positions for clock-wise or anti-clockwise rotations. Another mark or pointer on the brush rigging can be made to coincide with one of these marks. Some

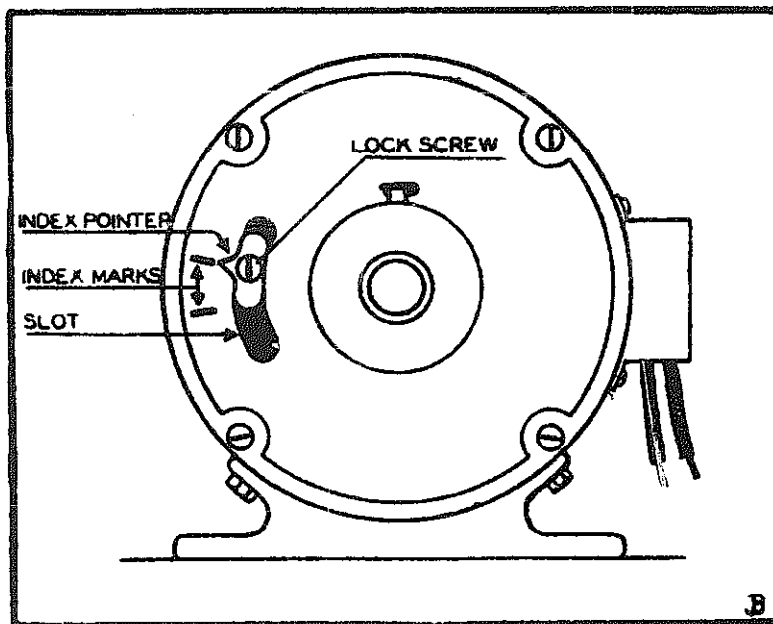

Fig. 4. Reversing rotation of a repulsion start-induction run motor. Shifting index pointer to other index mark changes rotation

form of lock screw or clamp is usually provided to prevent shifting, and this must be released before making a change in the setting.

Figure 4 shows the commutator end of a motor of this type in which the index marks, pointer and lock screw are plainly seen. These factory markings can not always be relied upon if a motor has been rewound or has had a new commutator installed. A slight change in the winding or position of the commutator on the shaft will cause a shift of the true neutral position of the brushes—a point at which the armature will revolve in neither direction—and consequently will likewise shift the brush positions for best operating conditions. By means of instruments on a test bench, or by means of a starting torque test, the position of the brushes for greatest efficiency in starting can readily be located. New marks can then be made on the motor frame.

It is sometimes desirable to have a reversible motor on such a piece of machinery as a lathe, when the expense of purchasing a true reversing motor is un-

warranted. For occasional work of this kind at constant speed, a repulsion-induction motor can be adapted. By bolting stops at each end of the index marks, some form of hand control can be attached to the index pointer, so that a quick shift can be made for rotation in either direction. This type of motor must, however, be allowed to come to a full stop before attempting to run it in the reverse direction, or serious burning or arcing at the commutator will result.

Straight induction motors are easily reversed in most cases by exchanging the end bells so that the rotor can be changed end for end. As a rule motors of this type are built so that either end housing will bolt to either side of the stator housing. By switching the rotor end for end, or by leaving the rotor as it is and turning the stator around, the rotation of the machine will be reversed without any alteration of the windings or connections. Figure 5 shows this clearly.

Shading-coil motors can not be reversed by changing leads or terminals, as this type of motor, used mainly in ceiling fans, has but one winding connected to the line. The shading-coils, which are used to make this form of motor self-starting, are placed to one side of the main poles, and would have to be shifted to the opposite side of the main poles to cause a reversal of the direction of rotation. In most cases this would be a practical impossibility, as it would necessitate a complete rebuilding of the field, and is a method hardly ever used.

The shading or starting coils used in these motors consists of either a circular copper band, or of a short circuited coil of heavy wire. This band or coil inserted in the trailing edge of the pole retards the flow of the magnetic flux in this side of the pole and causes a phase displacement which has a rotating effect on the rotor. These starting coils are insulated from the main winding. Fig. 6.

To change the rotation of a shading-coil motor, reverse the end bells and rotor in relation to the field. If this is impossible because of mechanical restrictions, it may be possible to press out the stator lami-

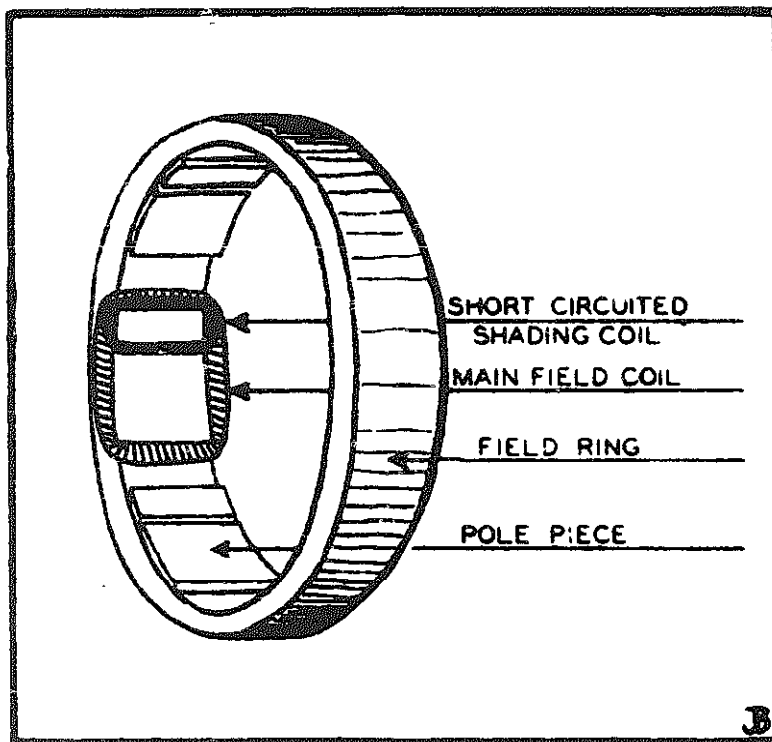

Fig. 6. Construction of a shading-coil motor

nations with the windings intact, and press it back into place in a reversed position. In the latter case the rotor, of course, must be left in the original position in the frame.

After rewinding the stator of an induction motor, or before assembling the complete machine, it is often desirable or essential to know in which direction the motor will operate. This information can be determined in advance with the use of a simple shop made tool which, for want of a better name, can be called a "testing rotor."

Figure 7 shows such a device, and a description of its construction will be given here. The material needed to construct a testing rotor consists of two discs of fibre, bakelite or hard rubber, and a few feet of bare copper wire in several sizes. This material is formed into the shape of a squirrel cage, with two coils projecting from the ends. The cage is mounted on an axle which also forms the handle by which it is held when in use. Figure 7 gives the approximate dimensions of the tool.

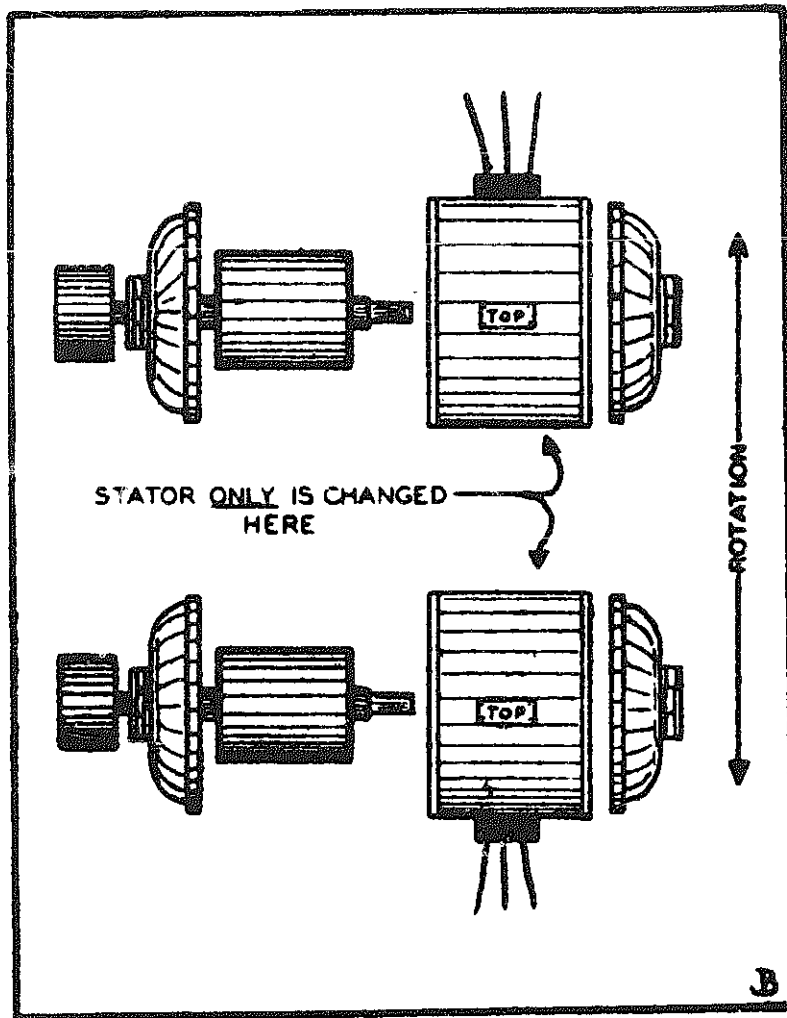

Fig. 5. To reverse rotation of an induction motor change rotor end for end, or change sides of stator, but not both

To discover the direction in which the assembled motor will rotate, connect the stator windings to the line, and with normal current flowing through the coils, hold the testing rotor inside of the stator opening close to the core. Observe the direction in which it tends to turn. This direction will be the same as the rotation of the assembled motor.

Another handy testing device for the motor repair or rewinding shop is an internal growler. Just as an ordinary growler detects faults in most armatures, so will the internal growler locate short circuits inside the field ring or stator. Such a piece of equipment as just mentioned can be made at little or no ex-

pense by any electrician, and will be well worth the time and material expended on it.

Figure 8 shows a detailed drawing of the internal growler and the manner in which it is used. In reality this tool is a core type transformer having but one winding, the primary. The primary coil is excited by 110 volt a-c current as the growler is passed around inside of the stator. The laminated iron core of the internal growler, shaped to fit the inside of a circle, creates an alternating magnetic field, and the stator coils in the path of this alternating field become for the moment the secondary winding of the testing device.

When the internal growler is moved around the inside of the stator—touching the stator iron—and passes over a short circuited turn or coil, the result is the same as when the secondary of a conventional transformer is short circuited. The short circuiting of the secondary causes an increased flow in the primary of the transformer, and this increase of primary current can be detected by having an ammeter in series on the 110 volt line. At the same time that an increase in current flow is registered on the ammeter, it usually happens that considerable heat is generated in the short circuited section of the secondary of the stator. After a moment or two the defective turn or coil of the stator can be located by feeling over the surface just tested with the bare hand.

Another method of finding shorted coils with the internal growler is as follows: Just as a shorted armature in an armature growler will cause attraction for a strip of metal—such as a hacksaw blade—held above the defective coil, so will the shorted stator coil hold an attraction for a strip of steel. In making this test the steel strip must be held to one side of the growler so that it will cover one side of the coil while the growler is covering the other side. Thus the internal growler and the steel strip must be over corresponding sides of the same coil while making the test, and both must be moved around while maintaining their relative positions.

The laminated core of the internal growler can be made from a section of the core from a small direct-

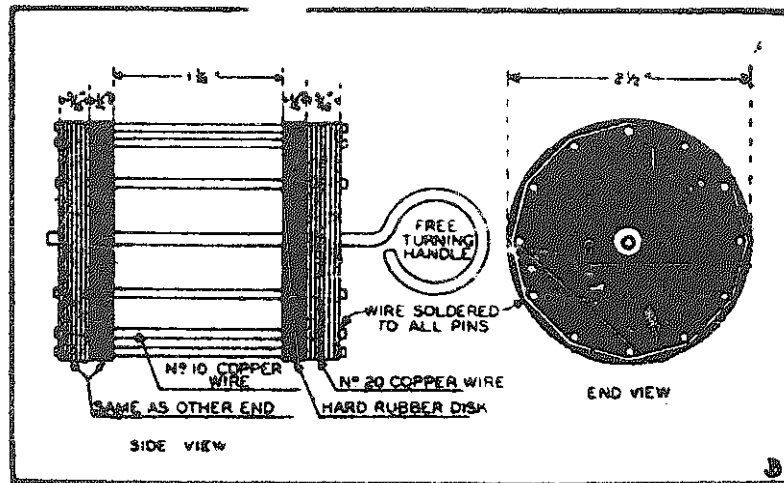

Fig. 7. Details of a test rotor for determining the direction of rotation of a rotor in advance of assembly

current armature by cutting off some of the legs, or it can be shaped from the laminations of some power transformer, such as is used in radio work. Flexible leads should be provided, and it is well to have an easy-to-reach on and off switch fitted to the handle of the tester. Grounded windings can also be tested with this device by proceeding as follows:

To test for grounds in a stator winding, place the internal growler inside the opening and touch each stator lead to the stator frame. If a spark occurs that circuit is grounded. If the stator coils are not as yet connected together, or where there is more than one winding, each coil lead or winding lead must be tested separately.

If a ground is discovered in one or more of the stator windings, the exact slot in which the ground is located can be found in the following manner: Ground one end of the defective coil or winding securely to the stator frame. Next make the growler and hacksaw blade test around the inside of the stator. The slot over which the hacksaw blade vibrates is the one in which the ground is located.

An internal growler is a great time and trouble saver for the motor shop. Like many other "gadgets," it is well worth the labor and thought necessary to construct it.

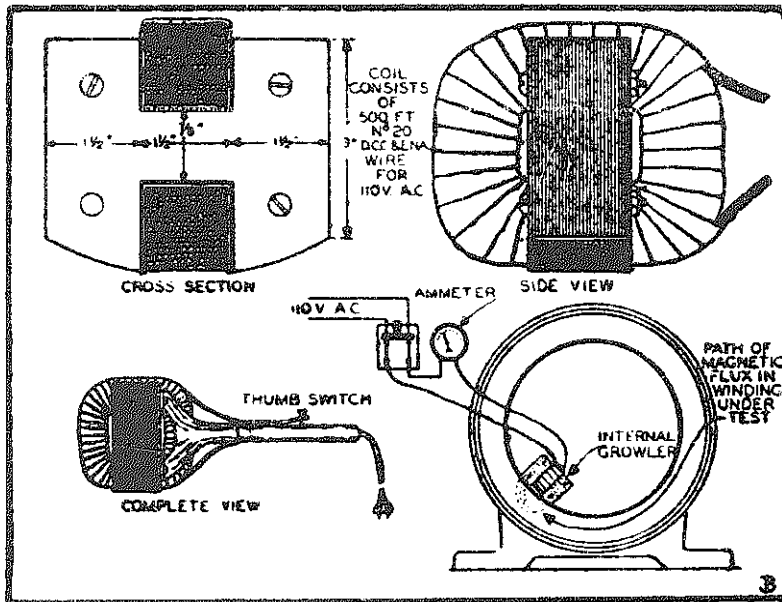

Fig. 8. Details of an internal growler for locating shorts and grounds in stators

Chapter 14

Brush Troubles and Their Remedies

EVERY motor repairman has to contend with brush troubles from time to time, as well as the numerous troubles that can be traced directly to improper brush functioning. Altogether too many people have the idea that a brush is just a brush, and that all that is necessary is to roughly fit any handy piece of carbon and insert it in the brush holder. The result is that a large number of motors, especially of the smaller sizes, are continually coming into the shop with commutators burned, pitted, grooved and even worn completely through.

The material from which brushes are made can roughly be classified as follows: Pure carbon brushes, carbon-graphite brushes, graphite brushes, electro-graphite brushes, and brushes made from metal-graphite composition. The physical properties of these materials or compositions must be taken into account when selecting brushes for a given job.

The resistance of the brush material is a very important factor in many applications. The specific resistance of brush material is its resistance in ohms per cubic inch. In the laboratory this is measured by taking a brush one inch square and taking delicate measurements from opposite sides. If the resistance of the material is too great for the work the brush must do, the brush will heat up in service.

The second important factor in brush design is current carrying capacity. A brush should be able to carry its rated ampere load without causing the operating temperature to rise more than 50° Centigrade under usual conditions. The carrying capacity of a brush is determined by both the specific resistance of the material from which it is made, and by the area in contact with the commutator and holder.

The peripheral speed of the commutator also has a decided bearing on brush selection. The higher the peripheral speed the greater the need for higher carrying capacities, and also, the need for better lubrica-

tion of the brush. Carbon or carbon-graphite brushes are best suited to slow or medium speed equipment where the carrying capacities are not too high. Electro-graphite brushes are adapted to high peripheral speeds and where commutating characteristics must be of the best. Electro-graphitic brushes are non-abrasive and are best fitted for use on undercut commutators, or where commutator slot insulation does not require an abrasive brush.

Graphite brushes are very soft and meet the requirement of very high operating speeds as well as where the current carrying capacities must be unusually high. As a rule, commutators must be undercut for graphite brushes, for the reason that the brush material is too soft to keep the slot insulation worn down even with the commutating surface. Metal-graphite brushes find general use in low voltage direct-current machines, such as starting motors of various types, and are also used on alternating-current slip ring motors and generators.

The abrasiveness of a brush does not necessarily depend on the hardness of its material. A soft grade of carbon brush may be very abrasive, while a hard brush of another type will cause but little commutator wear. A certain amount of abrasiveness in a brush is required to keep both the surface of the brush face and of the commutator clean and polished. The abrasiveness of any brush is also influenced by the peripheral speed of the commutator, and by the pressure applied by the brush spring.

The contact drop, or loss of voltage between the face of the brush and the surface of the commutator, depends on the brush material, speed and pressure. The contact drop of almost any brush can be decreased by increasing the spring pressure, but as this is done brush friction is increased. An increase of brush friction may cause serious heating and undue commutator wear. Where the contact drop of a brush is excessive it would be better to change to a less resistant type of brush, than to exert more pressure.

Brush pressure is usually measured in terms of pounds per square inch of brush contacting surface, and as stated before, should be adjusted to a value

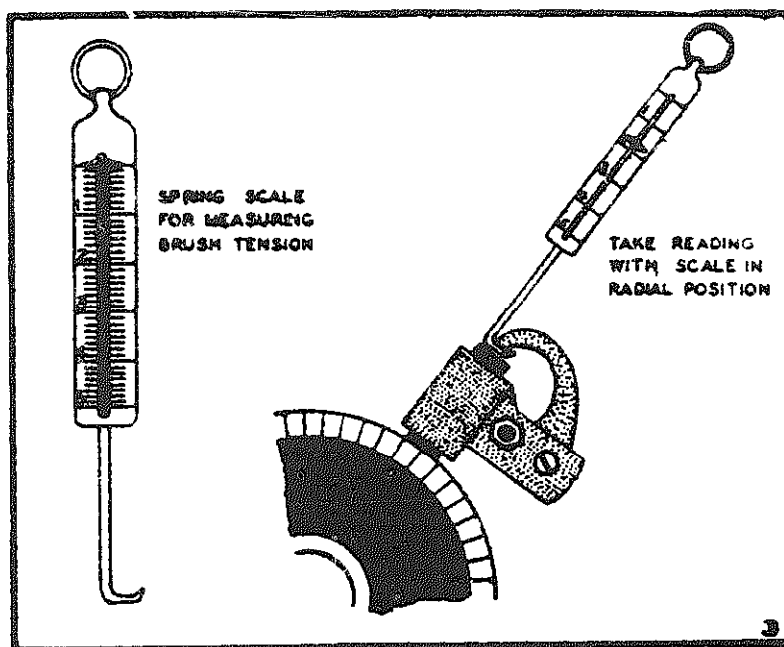

Fig. 1. Measuring brush spring pressure or tension

where a compromise is effected between excessive contact drop and excessive brush friction. A safe rule to follow is to use the lowest brush pressure possible without sparking. This will very seldom be less than $1\frac{3}{4}$ pounds per square inch of brush contact surface except with very soft graphite brushes, where it may be slightly less.

The motor repairman is seldom able to accurately determine the hardness, abrasiveness, resistance or contact drop of brush material, but he is able to measure the brush pressure on the commutator. This is easily done with a brush spring tension scale, as shown in Figure 1. The hook of the scale is slipped under the outer end of the brush spring and the scale is pulled away from the brush at an angle that would cut through the center of the commutator. The brush arm or spring should barely be raised from the brush when the reading is taken direct in ounces and pounds from the body of the scale. The exact area of the brush surface must be calculated in square inches.

Brushes form such an important part in motor repair service work that every motor shop should maintain a reasonable stock of brushes designed for the more popular types of motors. These brushes, espe-

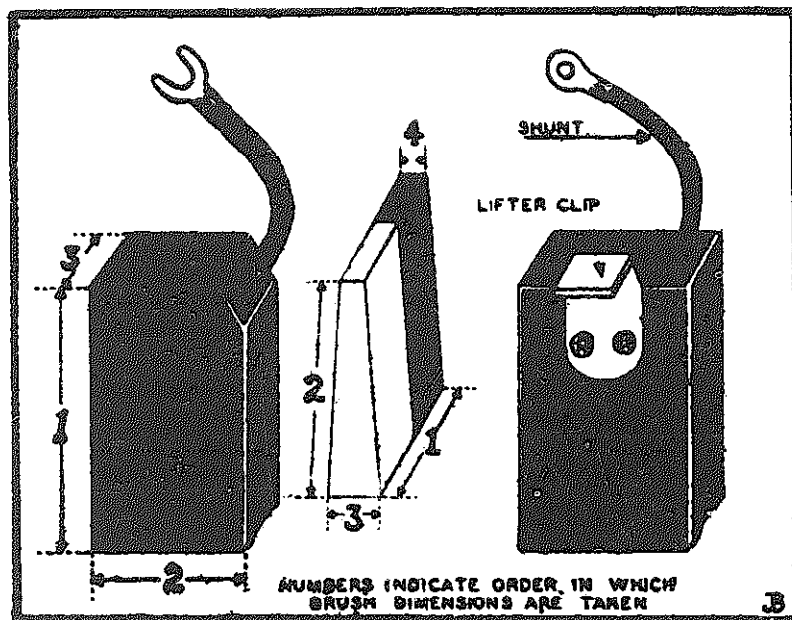

Fig. 2. Illustrating brush parts and standard method of measuring square and wedge shaped brushes

cially for the fractional horsepower motors, are not expensive and a representative stock can be put in for \$10 to \$20. Because of the many physical properties of different brush materials, and because the nature of the service differs in different types of motors, it goes without saying that the dealer's brush stock should come from the motor manufacturer or from one of the several reputable factories specializing in the making of well engineered brushes for replacement purposes.

It is impossible for even the large motor shop to stock brushes for every make and model of motor that may come in for service. The time element is often of great importance and it is not always possible to order a new set of brushes and get them in time to suit the owner of the motor. For this reason every motor-shop should also stock a few sizes of sheet brush carbon.

Carbon sheets of a universal or general purpose grade are available, and usually come in a 4" x 6" or 4" x 8" size, and in an assortment of thicknesses from $\frac{1}{4}$ " to 1" or more. Round or square carbon rods of all diameters in one foot lengths can also be bought, and

solve the problem of making odd brushes for very small motors, such as are used on fans, drink mixers, etc. With this material at hand any sort of brush can be cut and shaped and, while it may not be the exact type of brush needed, at least a set can be made to "pinch hit" until the proper grade can be obtained.

With a little work the motor repairman can make up brushes with shunts—often improperly called "pig-tails"—where they are required. The duty of a shunt, of course, is to carry the current directly from the proper motor lead to the brush, or vice versa as the case may be. In this way the brush holder, the brush spring or the brush spring arm is relieved as an electrical conductor, and a much better circuit is assured. Shunts are attached to brushes in four ways: They are moulded in place when the brush is made; they are fastened in a hole drilled in the brush by means of a screw or pin; they are bolted in place, or they are cemented into a hole drilled in the brush. Fig. 2.

The first way is out of the question for the average repair shop, and the second method is delicate and subject to considerable breakage. It is easy enough to bolt shunts to brushes, but except in the larger sizes there is no room for this type of connection either on the brush or in the confines of the brush holder. Therefore the most practical method for the average shop to follow in fitting shunts to shop made brushes is to cement them in place. Both shunts and shunt cement can be purchased from several of the large brush manufacturing concerns.

In addition to shunts, many of the brushes used on large motors are equipped with hammer or lifting clips. The hammer plate on a brush is a means of preventing fracture of the brush material, or excessive hollowing due to the action of the brush spring arm, grinding on the top of the brush. Lifting clips, as the name implies, are used in applications where the brushes are automatically lifted from the commutator at certain times. Some brushes are fitted with a shunt and a combination hammer and lifting plate. When the need for a set of brushes of this type is imperative, the hammer or lifting clips from the old brushes can be salvaged and riveted to the new brushes. Fig. 2.

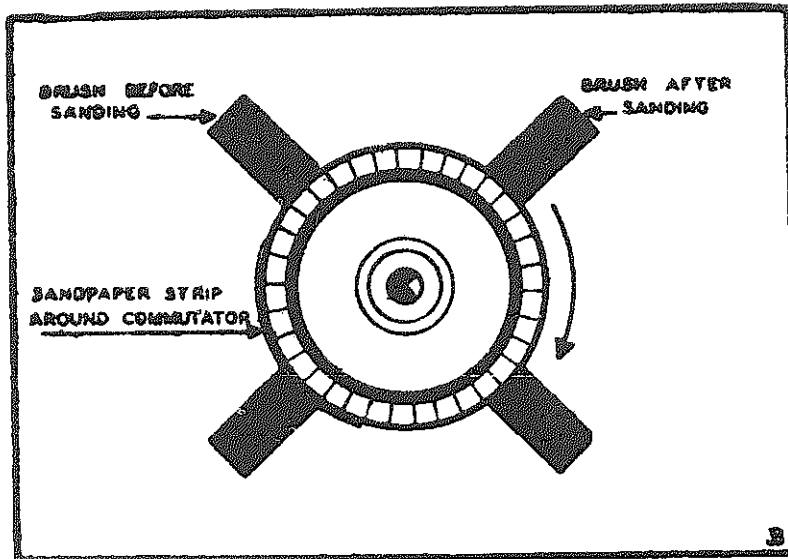

Fig. 3. Method of sanding brushes so that contact surface will conform to curvature of commutator

Selecting the right type of brush is a very important factor in good performance, but no more so than proper installation and adjustment. This applies with equal force to small as well as large motors. To prevent sparking, excessive wear and chattering, every brush should be sanded to fit the curvature of the commutator. This is easily done on many motors by cutting a strip of 00 sandpaper and banding it around the commutator before the brushes are placed. The sandpaper must be wound around the commutator in a direction that will cause it to tighten when the armature is turned in its normal direction of rotation. String, fine wire or rubber bands will hold the sandpaper in place while installing the brushes. The armature should then be revolved until the brushes are well seated. Figure 3 shows a brush before and after sanding.

It is often impractical to sand in brushes on very small motors by this method. However, round or square brushes used in miniature motors should always be fitted to the curve of the commutator, as this cheaply built equipment can stand less arcing as a general rule than can more substantially built motors. Proper fitting of small brushes can be accomplished in this way.

Install new brushes and operate motor for a minute or so. Remove brushes and inspect the contact surface. The glazed part indicates the section of the surface that is rubbing on the commutator. Wrap a piece of fine sandpaper around an object approximately the same diameter as the motor commutator. Rub the end of the brush on this so as to grind away the glazed portion. Reinsert brush in motor and run motor for another minute, then inspect. Keep grinding away glazed portions of the brush until a test shows that at least 75% of the contact surface is bearing on the commutator.

On vertical commutators the brushes may be sanded with a flat strip of fine sandpaper drawn back and forth under the brush. Where the brush holder is attached to the armature shaft and is free to rotate the brushes can all be sanded at once if a circular disk is placed against the commutator face before the brush holder and brushes are installed. After the sanding operation the paper can be torn out. This of course done with the armature out of the machine. Where the sanding of the brushes is done inside the assembled motor or generator, care must be used to blow out all the accumulated carbon dust from the operation.

Motors or generators having adjustable brush holders, and where brush troubles are experienced, should be checked for the angle at which the brushes are set. The proper setting depends to a great extent upon whether the armature rotation is against the heel or the toe of the brush. If the brushes are set for a leading position the angle, as a general rule, should be in the immediate neighborhood of 35° . If the brushes are in a trailing position the angle may vary from 10 to 25° . Trailing, leading and radial positions of a brush are shown in Figure 4.

Brush spacing around the commutator is a source of trouble on certain critical motors and generators. Incorrect spacing is usually caused by careless assembly after a repair job, and shows up worst on interpole machines. An easy way to check for correct brush setting is to wind a strip of paper around the commutator and then mark off the position of each brush. When the paper is removed the distance be-

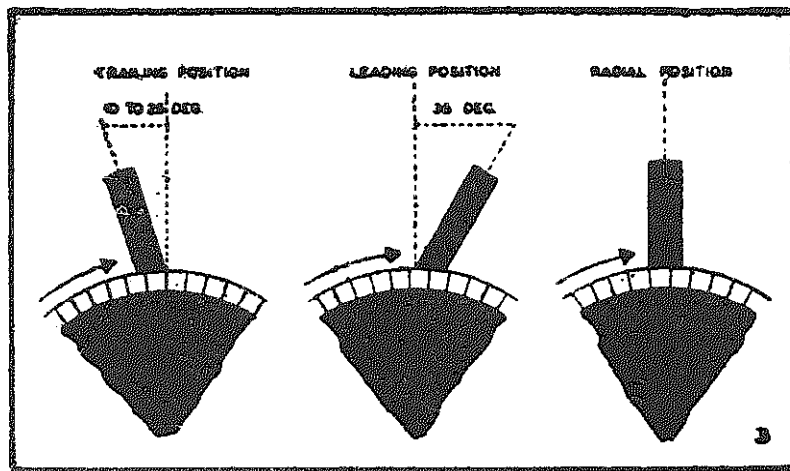

Fig. 4. Brush angle and setting on commutator

tween brushes is easily measured.

Unusual sparking of the brushes is always an indication of trouble and can most often be traced to one or more of the following causes:

High mica between commutator bars; weak spring pressure; incorrect spacing of brushes; oil and dirt on commutator; flat spots or commutator out of round; wrong type of brushes; brushes off the neutral; defective field or armature coils; brushes spanning too many bars; brushes tight or gummed in holders; brushes having too low a contact drop; brushes chattering; overload of machine; worn armature bearings; unequal air gaps at poles; vibration of the motor; loose or out of line brush holder studs; loose connections inside motor or at brushes.

Chapter 15

Insulating Varnishes for Electrical Work

AS rewinders and electrical repair men, we are greatly concerned with the subject of insulation. Without insulation in some form or other we would have very few pieces of electrical equipment that would operate. Glass, porcelain, rubber, bakelite, cotton and other textiles, asbestos, mica and many other substances have played an important part in the development of the electrical industry. In the case of motors and generators, however, the various types of insulating varnishes used play a most important, if not the most important, part in the construction and serviceability of such machines.

Armature varnishes are not only good insulators in themselves but they also serve to protect the insulating properties of many other insulating materials. If the average electric motor were not protected by a penetrating coat of good insulating varnish, the action of vibration, heat, water, oil, dirt and acid fumes—any one or all of them—would soon cause a complete failure of field or rotor circuits. Without a coating of insulating varnish, slot papers would soon become brittle and crack or soggy from moisture, cotton coverings would fray or unravel, and the enamel covering of wires would chip and flake. When properly applied and treated, insulating varnish provides a solid film protective covering.

Because insulating varnishes are used in relatively small quantities as compared with other motor rewinding materials, and because a knowledge of these varnishes involve principals of chemistry rather than mechanics, many armature rewinding shop owners and employees do not have a clear understanding of why some varnishes are best for one purpose and others for another use. While the average rewinder will not be interested in the chemical theory of insulating varnishes, a brief discussion of the different types and their principal uses should be of interest.

Characteristics of Spirit Varnishes

The simplest form of insulating varnish is familiar to nearly everyone under the common name of shellac. Shellac, and other allied gums and resins, dissolved in a suitable solvent usually alcohol—form the group known as spirit varnishes. In these spirit varnishes, the solvent evaporates and leaves behind a film of the gum or resin. The insulating properties of this film depend upon the type of gum or resin used in the solution. Since many of the gums used in spirit varnishes are oil proof, we find them being applied as a final and oil proofing coat to many forms of windings.

The film left by the spirit varnish is usually very hard and brittle and is subject to chipping and peeling. Being compounded of nothing but a gum, the solvent and a little non-drying oil, they have but little of the necessary toughness and elasticity needed for a good insulating job. Because of their inherent tendency to crack, spirit varnishes do not offer good protection against water or atmospheric moisture.

The most successful varnishes for the impregnating of windings are the oil type varnishes. This group, technically known as oleoresinous varnishes, are composed of a gum or resin, vegetable drying oils and a suitable thinner. In the manufacture of varnishes of this type, the gum and oils are given a special heat treatment at high temperatures, after which the thinner is added to the mixture.

Varnishes for Electrical Work

Oil type varnishes dry in an entirely different manner from the spirit varnishes. The thinner used, being volatile, evaporates within a few hours and leaves a coating of the heat treated gum and oils on the surface of the work. In speaking here of the heat treatment of the gum and oils, we are not referring to the baking process done on the finished winding, but to the process employed in the making of the varnish. The purpose of the thinner in this type of varnish is to act as a vehicle for the spreading of the gums and oils into thin films. It has no

other effect upon the final characteristics of the varnish.

The evaporation of the thinner is only the first step in the drying of varnishes of this type. The remaining gums and oils, still in a moist state, then undergo chemical changes which in a certain period of time will cause them to solidify and harden. The application of heat at this point produces a much more rapid action and, in most varnishes, produces a more desirable and durable film. Some varnishes of this type are air drying, but the baking types are usually better and find a much more general use in the manufacture and repair of electrical machinery. The oil type varnishes are much more elastic, durable and water resisting, and are best suited to the insulation of field coils and armatures.

The oil type varnishes are made in four general types known to the trade as clear air drying, black air drying, clear baking and black baking. Clear colored gums and resins are used in the manufacture of the clear type varnishes, while various asphaltic materials form the base of the black varnishes. Suitable oils and solvents are used with both the clear and the black, the different physical properties of the finished product depending upon the kind of gums used.

Varnishes for the Small Shop

While there are numerous varnishes on the market known as general purpose varnishes, it is also true that it is impossible to make a varnish that will give the best of results for all purposes. For the small shop, where the volume of work is limited, it is impossible, of course, to carry a special varnish for each type of work, and a compromise must be reached by using one of the general purpose varnishes. The fact remains, however, that better service can be expected by using the type of varnish best suited to each particular type of job.

The windings of a motor operating under very high temperatures call for a varnish of a type that requires a long baking period. Windings that are subjected to severe vibration will hold up longer with a varnish having a semi-plastic nature and a shorter baking

time. A varnish of this type, however, will not have the maximum in oil proofing qualities. Emergency repair work, on the other hand, will often call for one of the quick air drying varnishes since the quality of the insulation is sometimes of less importance than the time factor.

Baking and air drying varnishes differ in the ratio of oil to gum, and also in the percentage of drier used. As a general rule, the air drying varnishes carry a smaller amount of the drying oils than do the baking types. The main difference between the clear and the black varnishes is in the physical properties only; the electrical properties being about the same in both cases. Usually, the hard drying varnishes are oil proof while the softer, flexible varnishes have poor oil proofing qualities.

Even more important than using the right type of insulating varnish is the importance of applying the varnish in the right way. As already pointed out, insulating varnishes are chemical compounds and like most chemical compounds they are unstable under adverse conditions. Temperature, foreign matter and the addition of wrong solvents or thinners may make a tank of varnish unfit for use. Considerable care should be used in the handling of varnishes in the shop. When a dipping tank is used, it should be provided with a tight cover, with a drain plug in the bottom and with a drain board. See Figure 1.

The insulating varnishes under discussion can be used in a dip, in a spray gun, or they can be applied with a brush. Dipping is the best method for all small work and the one with which small motor winders are most concerned. The big advantage of dipping lies in the fact that the varnish is able to penetrate and saturate all parts of the winding.

Before dipping the coils in the insulating varnish, the work should be preheated in the bake oven for a period of two to four hours at a temperature of approximately 225° F. This accomplishes a double pur-

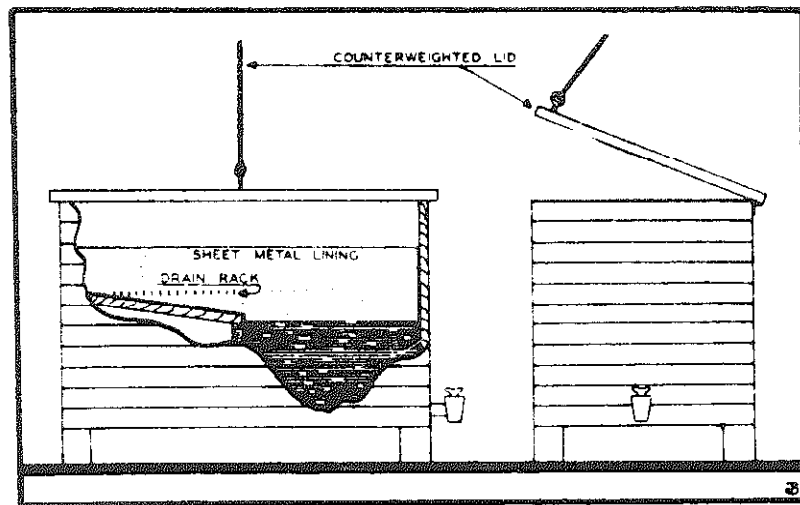

Fig. 1. This dipping tank with draining facilities will serve the small motor shop adequately. The lid should fit tightly and a valve should be provided for drawing off the liquid for cleaning. The size of the tank will be determined, of course, by the size of the work handled.

pose; it dries out atmospheric moisture on the one hand while on the other it brings the core and windings up to a temperature that will readily thin the insulating varnish and allow it to flow freely into the slots and recesses. The dipping tank should contain a sufficient quantity of the varnish to prevent the varnish temperature from rising more than a few degrees when the hot armature or stator is immersed.

Baking and Dipping Operations

The length of time allowed for the dip depends entirely upon the type of work. The best rule to follow is to leave the work in the tank until all bubbling ceases, but a much longer period will do no harm. After the dip comes the draining, and for reasons of economy the draining should be complete. When baking coils or armatures, they should be placed in the oven in an upside down position from that which they were drained. Heat will cause some further flowing of the wet varnish and the reverse position will make for a more even film.

The time allowed for air drying or for baking will depend, of course, upon the individual specifications of the varnish used. All types of work do not re-

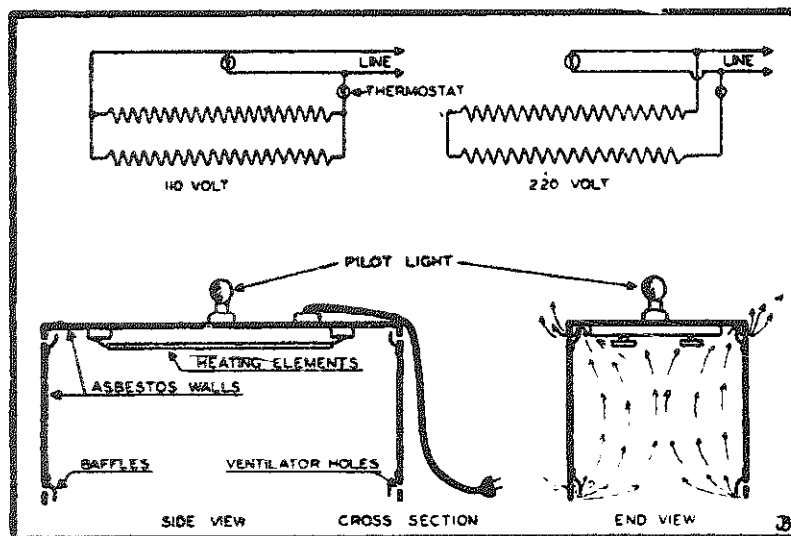

Fig. 2. This portable hood type baking oven is convenient for small work. The sides and top are constructed of stiff asbestos board held in a light angle iron frame. The enclosed type heating units are controlled by a thermostat. The oven is placed over the work to be baked.

quire the same thickness of the varnish film, and this must be considered when preparing the dip. Ordinarily, one coat of varnish is not enough to give results of high quality. Two or more thin coats are much better than one thick coat. This comes about through the fact that a thin varnish coat can be more successfully oxidized or dried than can a thick coat.

The consistency of most insulating varnishes as they come from the can are too thick for general purposes, and the specific gravity and viscosity must be reduced by means of a thinner. The amount that the varnish must be reduced by the addition of a thinner can be found by experimentation or by using a suitable type of hydrometer. Such a hydrometer is one that is calibrated for measuring liquids that are lighter than water. Proper allowances must also be made for the temperature of the varnish when the reading is taken. If the temperature of the varnish is above or below a standard set at, say 70° F., we add or subtract a correction factor of .0004 for each degree above or below our standard. The correction factor is added to the reading when

the liquid temperature is above the standard, and subtracted when the varnish is colder than our standard.

Thinning Commercial Varnishes

The thinner for spirit varnishes is alcohol. A good solvent for many of the commercial baking varnishes is procurable from many of the larger oil companies under the name of "solvent" or "Light Naphtha." The distillation end point should be below 160° ., and the density from 54° to 58 Baume. The cost is about 15c to 20c per gallon. Turpentine and coal tar distillates should not be used because of their softening action on the enameled coating of wire. During the mixing, the thinner and the varnish should be of the same temperature and the thinner should be added slowly and thoroughly stirred. Curdling of the mixture is caused chiefly by blending when either the varnish or the thinner is too cold, by adding the thinner too rapidly, by using the wrong thinner, or when the varnish has become partially oxidized or stale.

Good Bake Ovens Important

An efficient baking oven plays an important part in turning out satisfactory work. The oven should provide a uniform dry heat, good ventilation, heat insulation, and reliable temperature control. An important thing to bear in mind is that a varnish cannot be dried properly if allowed to bake in its own solvent vapors. Ovens must be equipped with a ventilating system that will not only carry away the solvent fumes, but which will allow a constant supply of fresh warm air to aid in oxidizing the varnish.