

[Click Here to download a PDF version of the book's full text and 7 sample drawings in 8 1/2" x 14" format.](#)



Reviews



"Professional Dome Plans is a book for builders not dreamers. If you're planning to construct your own dome, the detailed shop drawings and terse suggestions will be well worth the asking price." \*

"Mother Earth News" January, 1990 [Full Review](#)

\* The comment that it's "well worth the asking price" reflects the original 1990 price of \$34.95. Regrettably, we are unable to continue to develop and deliver the plans for that price. A personal license is now \$54.95 for unlimited personal use and a commercial license is \$184.95 plus a modest royalty.

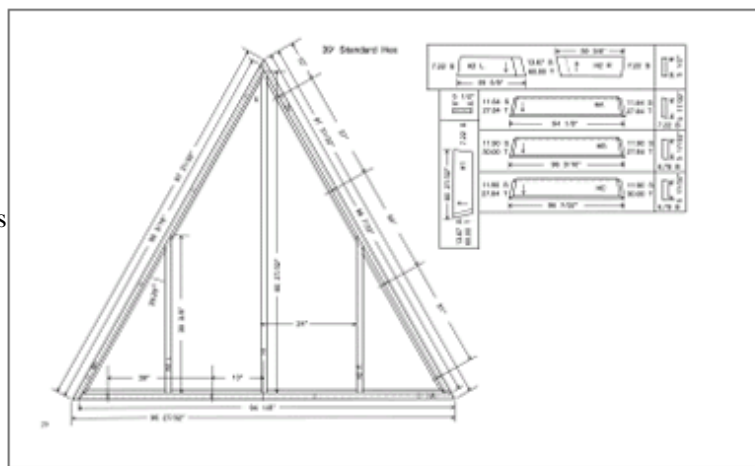

[Click drawing to enlarge.](#)



"Anyone who has ever been intimidated by the desire to build a geodesic dome will be relieved to know that the cavalry has arrived... Professional Dome Plans, has brought the other-worldly science of building geodesic domes down to earth where it belongs — firmly within the abilities of the do-it-yourselfer... The simplicity of the book suggests careful thought from Hill. The drawings are clear and easy to understand.. What it all adds up to in the end is a book that cuts through the complex geodesic math, reducing it to the unimportant obstacle that it is, clearing the way for the important task of building a dome."

"Canadian Workshop" March, 1989 [Full Review](#)

\* "Canadian Workshop" changed its name to "Canadian Home Workshop" in May of 1998. It's still the same great magazine, just with a new name.



"Designed to give a simple understanding of a complex building procedure, Professional Dome Plans is a collection of drawings and diagrams that aims to make dome building self-explanatory... Jeffery O. Hill is a former plant manager at Oregon Dome where he helped produce commercial and residential domes. To Hill's credit, the plan book is thorough."

"Professional Builder" Mid-March, 1989 [Full Review](#)

Sample Drawings

[Click drawings to enlarge.](#)





## PROFESSIONAL DOME PLANS Third Edition 3.01

Copyright © 1987, 1988, 2002 by Jeffrey O. Hill  
All rights reserved.



[Click Here](#) > to download a PDF version of the book's full text and 7 sample drawings in 8 1/2" x 14" format. You must have Adobe Acrobat Reader in order to view this document. If you do not, please [download it now](#).

### FULL TEXT & INDEX

Building a geodesic dome as a do-it-yourself project can be a real challenge. It's difficult to know where to begin even for those with considerable building experience. If you dig deep enough, you can find plenty of information describing the geometry of domes, although most of it is rather technical and theoretical and often lacks the kind of practical hands on advice needed to turn theory into a finished product.

This plan book is designed to fill that void by focusing almost entirely on simple, detailed shop drawings that show how geodesic domes are built with virtually no need for higher math. In fact, the only math you'll see in these plans are the 4 basic functions used in a list of formulas for calculating the length of various parts.

The underlying geometry describes carbon 60, the third stable form of pure carbon after graphite and diamond called buckminsterfullerene or buckyballs. Its shape is a 3 frequency (3v) icosahedron which is an industry-standard for dome homes. If that sounds complicated, and I'm pretty sure it does, I guarantee you it doesn't matter. Understanding the complex geodesic math involved in the design of domes is completely unnecessary when it comes to the actual process of building one. All you'll need are basic woodworking skills and a little patience. With that, you should have little trouble building your own dome.

### TERMS

**HEXagons and PENTagons:** 3v icoa domes are made up of two basic shapes of isosceles triangles arranged in groups. There are five groups of six panels each, called Hex groups, and six groups of five panels each, called Pent groups. These are easy to imagine by using a classic black and white soccer ball. The white patches are Hex groups and the black patches are Pent groups. By putting one Pent group on top and cutting an imaginary plane under the other five Pent groups that surround it, you will see the approximate 3/8 sphere described in these plans.

**A CHORD** is the line that defines the side of a triangular panel. All chords intersect the imaginary sphere at both ends to create nodes and a soccer ball shape with flat triangular facets.

**CHORD FACTORS** are numbers that represent ratios that are multiplied by the dome diameter (DD) to calculate the length of chords. They are always stated as the DD x the number. An example would be: 540" x .2048135683 = 110.5993269" or 110 19/32" which is the A chord for a 45' dome.

Sometimes dome books use chord factors referenced to the true radius or diameter of the sphere the dome is based on. While technically accurate, these numbers are a little difficult to work with because you can't easily measure the true radius or diameter of a 3v dome. This is because the true center of the sphere lies below the floor plane that divides the dome into useful structures. While the chord factors used here are related to the true diameter, they are referenced to the diameter at floor level. This is a number twice the radius from the center of the floor to any corner (p. 9). No two corners are opposite each other in a straight line however so in a 40' dome there is no 40' line but rather a 20' radius that scribes a 40' circle.

Even though the diameter is never really measured, it still serves as a perfect benchmark to ratio many other dimensions from. For example: the radius of a 40' dome is 40' x .5 or 20'. Similarly, the true diameter of a 40' dome is 40' x 1.015063688 or 40' 7 7/32". This will work with all scalable dimensions if you have the right ratios.

Incidentally, nearly all measurements are given in inches rather than feet with the exception being explanations like the one above. Decimal calculations done in feet add the complication of converting the remainder to inches which is just another opportunity for error.

**STRUTS** are the individual boards that make up the sides of the panels. Their lengths are found by multiplying the DD x a chord factor minus a constant that allows for the angled cross-section of the adjacent strut.

The labeling of struts corresponds to the group they're associated with. H stands for Hex and P for Pent followed by A, B or C added in a clockwise direction beginning with the base: HA, HB and HC for Hex panels, and PA, PB and PC for Pents.

BACKERS are the boards that fill in the panels and provide backing for the Sheetrock®. They are labeled with a P or H followed by 1, 2, 3 etc. from largest to smallest.

RISER WALLS are typically short walls that sit directly under the lower Pent groups. In domes smaller than 45' they are necessary to allow adequate height for entry through the natural openings. By raising the dome they also provide more usable floor space on the second floor.

The ratios provided in the Elevation drawing (p.11) give an idea of the effect of different riser wall heights on interior space. Simply multiply the DD x the ratio of a selected node and you will get its height, excluding the riser wall, for any size dome. Now add whatever riser wall height you want and you'll see exactly where that node will be on the second floor. This can be very helpful in deciding where to put skylights in case you might want to see something other than sky.

SHEAR PANELS are rectangular stress skin panels that are bolted and strapped to the ends of the riser walls and to the foundation. They prevent the riser walls from being pushed over by the dome by holding them in a ridged vertical position. Standard Shear Panels sit in line with the exterior walls and should be incorporated into the walls' design. The suggested size represents the minimum. The larger the area of shear the stronger and safer the design.

Extension Shear Panels project from the dome perpendicular to the openings and provide a base to build extensions on. In this arrangement they form a buttress which is very effective in resisting the overturning forces of the dome.

The TENSION RING is the line of struts that surrounds the dome just above the natural openings. This is where the compressional forces of live and dead loads are transformed into tension and constrained by the straps in a circle around the dome. The give and take of compression and tension is of course far more complicated than that, but the conclusion is the same. The tension ring holds the dome together and is one of the most critical links in the system. Great care should be taken to see that it's secure. In fact it's probably wise (although it's not always done) to double the A strut in the Hex panels over the openings. This gives you a double strut around the entire dome. At the cost of 5 boards it seems a small price to pay for the added security. To properly install straps, you need solid material beneath all the nails, so without a second strut you will need to add blocking anyway.

## FORMAT

DOMES DRAWINGS: The two drawings on pages 10 and 11 show a top view and an elevation of an approximate 40' dome on a 3 1/2' riser wall. They are consistent except for a slightly different placement of skylight panels and no shear panels in the top view. Ratios are given for several dimensions which should give you some feel for the proportions of different sized domes.

In the elevation, dotted lines, which normally represent hidden lines, are instead used to show panels visible only from the inside. The little numbers at the vertex of each panel match numbers on the individual panel drawings to indicate their general type and location.

In the lower Pent groups you'll notice that the two Bottom Side Pent panels have the backers laid out parallel to the A strut rather than perpendicular. Often domes are built with all the Pent panels constructed identically as Standard Pent panels. With larger domes or in heavy snow loads, you should consider using this alternate parallel layout. Structurally, the bottom three Pent panels are really more of a wall the dome sits on than part of the dome itself. Running the backers in this more or less vertical arrangement, in the Bottom Side Pents, makes much better use of their load bearing capacity and greatly improves the panels' resistance to buckling under stress.

PANEL DRAWINGS: All panels are drawn skin side up with the skin removed. Possible plywood layouts are shown on the next page. Panels are also all shown framed as 2x6 with backers on 24" centers although 2x4 domes and big domes in heavy snow loads may be safer when built with 16" centers.

As for 2x4 versus 2x6 construction, I would advise not to build any serious dome home with 2x4s. A good case can be made for the relative strength and energy efficiency of 2x4s in domes versus 2x6s in a conventional structure, but it's an apples and oranges argument. The real comparison is dome to dome and in that case 2x6 is better in nearly every way, if perhaps a trifle more expensive in material. Local building officials, who are often unfamiliar with dome construction methods, are also much less likely to have a 2x6 dome violate their comfort zone.

All parts measurements are taken from the outer surface of the framing at the outside upper edge of the panels as defined by the chord lines. This allows for the dome to be made from any dimension lumber from 2x2s to 2x12s, without changing the lengths of the parts.

Triangular skylight drawings are shown with the 2x4 curb removed and drawn truncated in the center. A cross-section of this detail appears at the upper left of each drawing. Rectangular Velux® skylights are flush mounted without curbs.

Bolt hole layouts are intended to be universal and work, in most cases, with any panel of the same basic size and shape. The exceptions are with a few Velux skylights and are noted on the drawings.

**PLYWOOD DRAWINGS:** These drawings show possible ways of cutting plywood skins from 4x8 and occasionally 4x10 plywood. When cutting skins for a dome other than the ones pictured, follow the basic style shown here. Make sure any seams between plywood pieces fall on backing and are glued and stapled. In panelized stress skin domes, the skin carries a good deal of the load, so breaks in the skin are potential breaks in the load transfer.

**RISER WALL DRAWINGS:** Riser walls are drawn with an additional end view to make them clearer. The bottom plates and studs are not shown separately because they have only simple angles evident from the main drawings.

The riser walls pictured for the three domes drawn are sized to position the A Strut in the Hex panels over the openings about 36" off the second floor. This allows for a nice view from a skylight.

Riser walls can be almost any height as long as the shear panels are proportionate. A good rule of thumb is the shear panel should be at least as wide as it is tall.

It's actually best to incorporate the shear panels right into the exterior walls. This way the effective area of shear will increase where any plywood laps beyond the minimum framing of the shear panel itself.

When building on a concrete slab, make sure you carefully locate and incorporate the bottom straps into the foundation when it is poured. No matter how strongly built your riser walls and shear panels are, they're useless unless properly attached to the foundation.

It's also possible to use no riser wall at all. This is a interesting alternative for domes over 45' built on a tight budget. It's often less expensive to build these domes per square foot because there are fewer and larger components for the same usable floor space. 45' is about as small as you can go with this design though, in that you need a minimum height for the exterior doors.

If you choose to use this simplified design you will need a bottom plate under the dome beveled to the same angle as the riser wall top.

**STRUT & BACKER CROSS-SECTIONS:** Struts, because they must be beveled on both edges, always require a wider initial piece of lumber than backers. If for instance, backers are made from full 2x6s, then their accompanying struts will have to be cut down from 2x8s. Similarly if struts start out as 2x6s and are minimally milled, they will end up slightly smaller and the backers will need to be ripped down to match. The drawings on page 8 show both options for 2x4, 2x6 and 2x8 domes.

**PARTS DRAWINGS:** These drawings are the real heart of the plans. They appear with every panel and show a simplified view of its most complicated parts (simple blocks are omitted).

Boards are shown as if lying flat on your radial arm saw table. They are to rough scale with the lengths truncated to save space. Very slight angles have been exaggerated for clarity. Degree marks are omitted as unnecessary.

Angles are given in reference to the saw with S indicating the Swing of the arm and T being the Tilt of the head. B indicates the Bevel of your table saw and appears with the end view.

Dimensions of backers that vary only in length are shown in a list above or below the drawings with only the longest backer shown.

Identifying labels are placed on the same end of the boards as they appear in the scale drawings. The little arrows show the side of the boards the skin is attached to. Make sure you apply these labels and arrows to every board as you go about cutting. If you don't, I guarantee you that you won't be able to tell them apart especially with the Hex struts.

**ANGLES:** Angles are always displayed to the second decimal and are never rounded off. This makes matching the 10 digit equivalents listed with the formulas easy. You may never need to use any of these precision numbers but if you ever want to calculate some new part, they can be a very useful starting point.

**DIMENSIONS:** Dimensions are rounded generally to the nearest 1/32" with very slight adjustments made to allow for matching struts that round in opposite directions.

This level of accuracy may seem extreme, but it's my experience that people are capable of making all the necessary mistakes without help from sloppy dimensions. Just seeing numbers like 110 19/32" tends to make one work more carefully. Then too, domes are far less forgiving than most wooden structures. Even small errors will accumulate making the last panels difficult to install.

The lengths of parts for arbitrary-sized domes can be calculated using 12 simple, although very precise formulas, on page 6. They all use the same approach —  $DD \times a$  ratio minus a constant or two to get the final length.

There are also 4 tables that list strut and backer lengths precalculated for 49 dome sizes from 12' to 60' with backer lengths

figured for both 16" and 24" centers.

## FABRICATION

**GLUING:** Consider gluing if the dome you're building is over 35' or will be subjected to heavy loads. The method of dome building shown in these plans relies heavily on the skin to transfer stress from panel to panel. When bound to the struts with glue, this capacity is greatly increased. Shear panels must be glued in any case, even if you choose not to glue the entire dome.

Glue should be waterproof and "structural", of the resorcinol phenolic resin type. Construction adhesives, while better than nothing, will creep under constant stress over time. Structural glues won't.

**NAILING & STAPLING:** Nail the framing with a pneumatic nail gun. Hot dip galvanized, full round head, 3 1/2" by .120" spiral shank nails should work well. These nails are very long and thin. This allows good penetration when shooting at an angle at the strut ends. The .120" shank also minimizes the chance of splitting the ends of the struts. Another advantage of air nailing is that it's much faster. Also, if you have a slightly warped strut, as sometimes happens, you can set one nail as a pivot point and then with a big Crescent® wrench twist the strut into position just beyond the right spot with one hand, then fasten it quickly with the other and it will relax back to a perfect alignment.

Nail the framing on 2x6 domes with 5 nails in the panel corners where the struts meet and 4 in both ends of the backers if using .120" shank nails.

When backers run perpendicular to the A, strut they should be snugged up and fastened first from the inside on the sharp end with small staples or nails. This insures a tight fit which allows the backers to key in place because of the bevel of the struts.

Flush all framing on the skin side pushing any error to the inside of the panel. This guarantees an intimate glue joint with minimal bridging between parts.

When attaching skins I prefer to use staples. If gluing the skins, space staples 3" on center around the perimeter and on both sides of any seams and 5" on center everywhere else. If not gluing, space them even tighter. If any staples remain above the panel surface, tap them down flush with a hammer to insure a good glue joint. Also make sure the crown of the staple does not run parallel to the grain of the top ply of the plywood. You want the crown to cross the grain and pull the plywood down.

Nail and staple guns can be rented from most general rental companies. A Senco® SN65 or FramePro 650 FRH will work well for framing. A Senco® SNS45 or SNS50 stapler with N-19-BAB staples can be used for skins. If you have difficulty finding 3 1/2" by .120" gun nails locally, you can find them at mazenails.com. in Peru, Illinois, USA.

**JIGS:** When building just one or two domes, making elaborate production jigs is unrealistic and unnecessary. Well cut struts with cleanly fastened corners will have the proper cords and should produce a nearly perfect dome if the struts are straight. Bowed struts, on the other hand, will cause a lot of problems. Even a 1/4" belly in the sides of two adjacent panels will push the panels apart 1/2" at the tips. If you do get one end together, the other end will usually get worse. Errors like this can be overpowered sometimes during assembly, but it's not much fun.

A simple jig made from three dead straight 2x4s nailed to the surface of a work table, snug around a panel, will help keep the struts straight while installing the backers and attaching the skin.

**LUMBER:** For any larger dome lumber should be #1 grade for struts and at least #2 & better for backers. Where skins will be glued and the inside finished, it should also be kiln dried. Air dried lumber will work as long as it's well seasoned with a moisture content as low as KD. Green or wet lumber will not support a good glue joint and tends to warp as it dries.

**PLYWOOD:** Plywood should be at a minimum 1/2" 5 ply CDX or the equivalent, and glued down when running parallel to the backers. Never use 3 ply or 4 ply plywood in this arrangement. It's very weak across the grain and will be spongy under foot, especially on 24" centers.

**BOLT HOLES:** Bolt holes are laid out from the vertex down both equal sides for the B and C Struts. For the A struts they're laid out from the center to both ends. This is because in the case of A Struts, HAs match PAs but must also match themselves. An HA to HA paring will double any error made in laying out the bolt holes from one end. Layout done from the center will minimize this problem.

Center is most accurately found by measuring it twice from both ends of the strut. If both lines are not in exactly the same spot, a line splitting the difference will be the center.

Bolt holes can be jiggged by drilling holes for guides in the center of a 2x4 and clamping it flush to the top of the framing. Just make sure you mark the vertex end in the case of B and C Struts and always flush that end. With A Struts, lay the jig holes out from center and match that mark to a center line made on the struts themselves.

Bolt holes should be drilled 1 3/4" down the outside face of the struts at 90° to their surface. This transfers stress in as direct a path as possible from skin to skin. Holes should be 5/8" when predrilled to allow for adjustments.

Bolt placement and spacing are somewhat arbitrary. The layouts illustrated follow a deliberately conservative pattern of a bolt approximately every 24" beginning and ending about 10" or less from the tips. The purpose here is not only to transfer loads, but is also to prevent Sheetrock® cracking. With domes, the joints in the Sheetrock® unavoidably fall right on the joints between the panels creating a weak spot. In a 45' dome this amounts to more than 700' of joint. That's a lot of potential for damage, so a few extra bolts are worth the price.

**HARDWARE:** Bolts can be 1/2" x 4" grade 2. Washers can be 1/2" heavy flat washers but 3/8" malleable iron washers work a lot better. Their hole is just a little over 3/8" so 1/2" bolts (which are actually under 1/2") will fit through them most of the time without reaming. The difference is in the amount of torque they will take. Flat washers will bend in a cup shape under stress and noticeably crush the wood underneath them. Malleable iron washers, which have at least three times the bearing surface, will feel tight long before you notice any crushed wood. This allows you to torque the bolts closer to specs. and get the struts tighter together.

**STRAPS:** The size and strength of straps used depends on the size of dome you build and the loads you expect. Single 3' long Simpson MTS37 straps, or the equivalent in strength, have been used on 45' domes in snow loads below 30 lbs. In heavier snow loads, a second ring of straps should be installed at the next ring of struts up from the tension ring.

### ASSEMBLY

Raising a dome is fairly straightforward. Domes are sometimes raised by prefabricating the lower five Pent groups on the ground and then tilting them up as one piece. While this works well enough for smaller 2x4 domes, it would be difficult and certainly dangerous with a 60' 2x6 dome. With larger domes you may want to begin with just the bottom three Pent panels and go one at a time from then on. In any case, make sure to brace everything well as you go. A dome is not self supporting until the first forty panels are up and form a complete tension ring.

Bolts should be tightened as you go along except for the two Hex to Hex seams in the Hex group that meets the last Pent Panel. Leaving these bolts a little loose allows you to flex the dome open slightly with two long poles and slip the final Pent panel in more easily. After the dome is up it's a good idea to go around and retorqued the bolts one last time before you cover them up. Sometimes a few just get missed otherwise.

Take time to finish one step before racing on to the next. Riser walls and shear panels, if used, should be completely strapped to the foundation prior to raising the dome. This guarantees that no movement takes place before the straps are called on to take up load.

Strapping should be installed on the dome itself as soon as the tension ring is finished. This is because tension straps allow a very slight movement of the panels as they load up. As you add additional panels, the straps will come under tension and seat, allowing no further movement. If you wait until after the dome is up to install the straps, it will actually be the bolts at the tension ring that are taking the stress and not the straps. Now add a roof, Sheetrock® and about two feet of snow, and you may get a minor movement of the panels as the straps take up the additional load. The result at worst will likely be nothing more than hairline cracks over the openings but they're worth avoiding if you can.

### SMALL SCALE DOMES

These plans focus mainly on building large scale domes which is reflected in the use of full-dimension lumber in all of the drawings and tables. Small scale domes for use as a back yard storage building or potting shed don't really need this heavy lumber and can be sensibly built making panels from thinner lumber such as 1x4s. You can easily calculate the parts for these domes using the formulas on page 6. They need only minor modifications that account for the smaller cross-section of the lumber.

To figure struts, use the same ratios but reduce the following constant by the percentage your lumber is thinner than standard 1 1/2" lumber. For instance: 3/4" lumber is 1/2 as thick as standard lumber so you would divide the constant by 2. 1/2" lumber is 1/3 as thick so you would divide the constant by 3, and so on.

To figure backers you again use the same ratios and reduce the first constant by the percentage your lumber is thinner. The second constant, however, should remain the same. Its only purpose is to calculate the change in the length of a backer relative to its position on layout. No cross-sectional dimensions are involved in this process so it is unaffected by lumber thickness.

### FORMULAS

Calculating the length of struts is straightforward. The dome diameter (DD) is first multiplied by a ratio to figure the entire length of a panel's side or chord. A constant, which allows for the angled cross-section of the adjacent strut, is then subtracted to produce the finished strut length.

Calculating backers is a little more complicated. In the case of backers running parallel to any strut, the DD is first multiplied by a ratio to establish the chord. A constant is then subtracted that allows for the angled cross-section of both intersecting struts as if

they crossed at both ends. A second constant is then subtracted for every inch the backer is away from the base line on layout. That is if the backer you want is 13 1/2" from the edge, you would multiply the second constant by 13.5 and subtract.

If the backers are perpendicular to the A Strut, the DD is first multiplied by a ratio that establishes a line that bisects the panel through the vertex. A constant is then subtracted that allows for the cross-section of the A Strut plus the intersection of the B and C Struts. This produces a number equal to the length of the first center backer. Subsequent backers are figured by subtracting a second constant for every inch they are from the center line on layout. Remember that since the reference line is to the center of the panel, and not the edge of a backer, a 3/4" allowance must be made on the first layout. That is, on 16' centers laid out on center, the second backer would be 15 1/4" from center not 16". Laid out off center, the first backer would be 7 1/4" from the reference line, not 8".

Building a dome is really not that different from any other building project. In the beginning there are always two big questions:

1. What do the parts look like?
2. How do they go together?

If you know the answers to these two questions, your odds of success are pretty good. To that end, I hope you find these plans helpful.

j.o. hill

***Most formulas and data have been zeroed in the sample version.***

**HEX STRUTS**

HA = DD x .2048135683 - 1.732050808"

HB = DD x .0000000000 - 0.0000000000"

HC = DD x .0000000000 - 0.0000000000"

**HEX BACKERS**

Perpendicular to the A Strut = DD x .0000000000 - 0.0000000000" - (0.0000000000" per inch of layout)

Parallel to the A Strut = DD x .0000000000 - 0.0000000000" - (0.0000000000" per inch of layout)

Parallel to the B or C Struts = DD x .0000000000 - 0.0000000000" - (0.0000000000" per inch of layout)

**PENT STRUTS**

PA = DD x .0000000000 - 0.0000000000"

PB = DD x .0000000000 - 0.0000000000"

PC = DD x .0000000000 - 0.0000000000"

**PENT BACKERS**

Perpendicular to the A Strut = DD x .0000000000 - 0.0000000000" - (0.0000000000" per inch of layout)

Parallel to the A Strut = DD x .0000000000 - 0.0000000000" - (0.0000000000" per inch of layout)

Parallel to the B or C Struts = DD x .0000000000 - 0.0000000000" - (0.0000000000" per inch of layout)

**REFERENCE ANGLES**

0.00000000°	00.000000°	00.00000000°
0.00000000°	00.00000000°	29.29158251°
0.00000000°	00.00000000°	00.00° ...
0.00000000°	00.00000000°	00.00000000°
6.789275306°	00.00000000°	31.41683498°
0.00000000°	00.00000000°	00.00000000°
7.22886028°	00.00000000°	00.00000000°
0.00000000°	00.00° ...	00.00000000°
0.00000000°	00.00000000°	00.00000000°
0.00000000°	00.00000000°	00.00000000°
0.00000000°	00.00000000°	00.00° ...
0.00000000°	00.00° ...	00.00° ...



0.000000000°      00.00000000°      00.00° ...  
0.00000000°      00.00000000°

## CONTENTS

1. --- 7. Text
8. Strut and backer cross sections
9. Foundation Layout
10. Top View
11. Elevation
12. 39° Standard Pent
13. plywood layout for above
14. 39° Bottom Side Pent
15. plywood layout for above
16. 39° Pent for Sierra Plastics P35 Skylight
17. plywood layout for above
18. 39° Pent for Velux Model 104 Skylights
19. plywood layout for above
20. 39° Standard Hex
21. plywood layout for above
22. 39° Hex for Sierra Plastics H35 Skylight
23. plywood layout for above
24. 39° Hex for Velux Model 304 Skylights
25. plywood layout for above
26. 39° Hex for Velux Model 104 Skylights
27. plywood layout for above
28. 18/18 & 27/27 Riser Walls for 39° Dome
29. 18/27 & 27/18 Riser Walls for 39° Dome
30. Standard & Extension Shear Panels for 39° Dome
31. & 32. Table of Pent backers perpendicular to the A Strut.
33. Table of Pent backers parallel to the A Strut
34. 45° Standard Pent
35. plywood layout for above
36. 45° Bottom Side Pent
37. plywood layout for above
38. 45° Pent for Sierra Plastics P45 Skylight
39. plywood layout for above
40. 45° Pent for Velux Model 306 Skylights
41. plywood layout for above
42. 45° Standard Hex
43. plywood layout for above
44. 45° Hex for Sierra Plastics H45 Skylight
45. plywood layout for above
46. 45° Hex for Velux Model 108 Skylights
47. plywood layout for above
48. 45° Hex for Velux Model 308 Skylights
49. plywood layout for above
50. 18/18 & 27/27 Riser Walls for 45° Dome
51. 18/27 & 27/18 Riser Walls for 45° Dome
52. Standard & Extension Shear Panels for 45° Dome
53. & 54. Table of Hex backers perpendicular to the A Strut.
55. Table of strut lengths for both Hex and Pent panels.
56. 50° Standard Pent
57. plywood layout for above
58. 50° Bottom Side Pent
59. plywood layout for above
60. 50° Pent for Sierra Plastics P60 Skylight
61. plywood layout for above
62. 50° Pent for Velux Model 306 Skylights
63. plywood layout for above
64. 50° Pent for Velux Model 108 Skylights

65. plywood layout for above
66. 50' Standard Hex
67. plywood layout for above
68. 50' Hex for Sierra Plastics H60 Skylight
69. plywood layout for above
70. 50' Hex for Velux Model 108 Skylights
71. plywood layout for above
72. 50' Hex for Velux Model 308 Skylights
73. plywood layout for above
74. 18/18 & 27/27 Riser Walls for 50' Dome
75. 18/27 & 27/18 Riser Walls for 50' Dome
76. Standard & Extension Shear Panels for 50' Dome

Sheetrock® is a registered trademark of United States Gypsum Company. Velux® is a registered trademark of Velux-America Inc. Senco® is a registered trademark of Senco Products Inc. Crescent® is a registered trademark of Cooper Industries Inc.



## License Agreements and Disclaimer

**Please read the license agreements carefully. There are two versions.**

1. A **Personal License** which allows you to build an unlimited number of domes for your personal use for \$54.95 U.S. or
2. A **Commercial License** which allows the same unlimited personal use but also allows you to build domes commercially for \$184.95 U.S. plus a very modest royalty.

**To move on to the Order Page you must first acknowledge with a check mark in the box at the bottom of this page that you have read and understand the terms and conditions of the license agreements. When you arrive at the Order Page you may choose the version you prefer while placing your book order.**

---

### License Agreement (Personal)

#### **Introduction.**

This is a License Agreement (the "Agreement"), effective as of this date (the "Effective Date"), between Precision Structures LLC (the "Licensor") of 2565 Potter Street, Eugene, Oregon 97405, and you (the "Licensee"). Licensor and Licensee shall be collectively referred to as "the parties."

Licensor is the owner of certain proprietary rights to the written work Professional Dome Plans, Third Edition ("the Work.") Licensee desires to license certain rights in the Work therefore the parties agree as follows:

#### **The Work.**

The Work refers to all proprietary rights, including but not limited to copyrights.

#### **Grant of Rights - Personal License.**

Licensor grants to Licensee a nonexclusive, nontransferable, non-commercial license to use the Work in building an unlimited number of domes for Licensee's personal use.

#### **Personal and Non-commercial Use Limitation.**

The Work is for Licensee's personal and non-commercial use. Licensee may not modify, copy, distribute, transmit, display, reproduce, publish, license, create derivative works from, transfer or sell the Work or any portion of it.

#### **Reservation of Rights.**

Licensor expressly reserves all rights other than those being conveyed or granted in this Agreement.

#### **Term.**

This Agreement shall commence upon the Effective Date and shall expire simultaneously with the expiration of the copyright of the Work unless sooner terminated pursuant to a provision of this Agreement.

#### **License Fee.**

As a nonrefundable, nonrecoupable fee for executing this license, Licensee agrees to pay to Licensor upon execution of this Agreement the sum of \$54.95 U.S.

#### **Limitation of Licensor Liability.**

Licensor's maximum liability to Licensee under this agreement, regardless on what basis liability is asserted, shall in no event exceed the total amount paid to Licensor under this Agreement. Licensor shall not be liable to Licensee for any incidental, consequential, punitive or special damages.

#### **Compliance with Intellectual Property Laws.**

The license granted in this Agreement is conditioned on Licensee's compliance with the provisions of all applicable laws and regulations, including but not limited to intellectual property laws of the United States and any foreign country. All copies of the Work as well as all promotional material shall bear appropriate proprietary notices.

#### **Licensor's Right to Terminate.**

**Licensor shall have the right to terminate this Agreement for the following reasons:**

**(a) Licensee assigns or sublicenses the Work in violation of the Agreement;**

**or**

**(b) Licensee breaches any other term of the Agreement.**

**Effect of Termination.**

After termination of this license, all rights granted to the Licensee under this Agreement shall terminate and revert to Licensor, and Licensee will refrain from further use of the Work.

**Attorneys' Fees and Expenses.**

The prevailing party shall have the right to collect from the other party its reasonable costs and necessary disbursements and attorneys' fees incurred in enforcing this Agreement.

**Dispute Resolution - Alternative Dispute Resolution.**

If a dispute arises and cannot be resolved by the parties, either party may make a written demand for formal resolution of the dispute. The written request will specify the scope of the dispute. Within 30 days after such written notice, the parties agree to meet, for one day, with an impartial mediator and consider dispute resolution alternatives other than litigation. If an alternative method of dispute resolution is not agreed upon within 30 days of the one-day mediation, either side may start litigation proceedings.

**Governing Law.**

This Agreement shall be governed in accordance with the laws of the State of Oregon and of the United States of America.

**Jurisdiction.**

The parties consent to the exclusive jurisdiction and venue of the federal and state courts located in Lane County, Oregon, United States of America in any action arising out of or relating to this Agreement. The parties waive any other venue to which either party might be entitled by domicile or otherwise.

**Waiver.**

The failure to exercise any right provided in this Agreement shall not be a waiver of prior or subsequent rights.

**Invalidity.**

If any provision of this Agreement is invalid under applicable statute or rule of law, it is to be considered omitted and the remaining provisions of this Agreement shall in no way be affected.

**Entire Understanding.**

This Agreement expresses the complete understanding of the parties and supersedes all prior representations, agreements and understandings, whether written or oral. This Agreement may not be altered except by a written document signed by both parties.

**Notices.**

Any notice or communication required or permitted to be given under this Agreement shall be sufficiently given when received by certified mail, or sent by facsimile transmission or overnight courier.

**No Joint Venture.**

Nothing contained in this Agreement shall be construed to place the parties in the relationship of agent, employee, franchisee, officer, partners or joint ventures. Neither party may create nor assume any obligation on behalf of the other.

**Assignability.**

Licensee may not assign or transfer its rights or obligations pursuant to this Agreement. Any assignment or transfer in violation of this section shall be void.

**Execution.**

Each party executing this agreement personally or on behalf of a corporation warrants that the party is authorized to enter this Agreement and that this Agreement is binding on the party.

---

**License Agreement (Commercial)**

**Introduction.**

This is a License Agreement (the "Agreement"), effective as of this date (the "Effective Date"), between Precision Structures LLC (the "Licensor") of 2565 Potter Street, Eugene, Oregon 97405, and you (the "Licensee"). Licensor and Licensee shall be collectively referred to as "the parties."

Licensors are the owners of certain proprietary rights to the written work Professional Dome Plans, Third Edition ("the Work.") Licensee desires to license certain rights in the Work therefore the parties agree as follows:

**The Work.**

The Work refers to all proprietary rights, including but not limited to copyrights.

**Grant of Rights - Commercial License.**

Licensors grants to commercial Licensee a nonexclusive, nontransferable, non-commercial license to use the Work in building an unlimited number of domes for Licensee's personal use. In addition, Licensors grants to Licensee a nonexclusive, nontransferable, commercial license to use the Work in building an unlimited number of domes for Licensee's customers provided Licensee pays the Royalties as set out below.

**Use Limitation.**

Licensee may not modify, copy, distribute, transmit, display, reproduce, publish, license, create derivative works from, transfer or sell the Work or any portion of it. However, Licensee may make a working copy of pages to be used as cutting lists provided that said copies are used for no other purpose and are destroyed after use.

**Reservation of Rights.**

Licensors expressly reserves all rights other than those being conveyed or granted in this Agreement.

**Term.**

This Agreement shall commence upon the Effective Date and shall expire simultaneously with the expiration of the copyright of the Work unless sooner terminated pursuant to a provision of this Agreement.

**License Fee.**

As a nonrefundable, nonrecoupable fee for executing this license, Licensee agrees to pay to Licensors upon execution of this Agreement the sum of either:

- (a) \$184.95 U.S. if purchased as an original Commercial License, or
- (b) \$130.00 U.S. if purchased as an upgrade from an existing Personal License, and thereafter to pay promptly other sums payable under the terms of this Agreement.

**Royalties.**

All royalties ("Royalties") provided for under this Agreement shall accrue when the respective domes are contracted, built, sold, billed or paid for, whichever occurs first.

**Licensed Work Royalty.**

Commercial Licensee agrees to pay a Royalty of ten cents U.S. (\$.10) per square foot on the area of a circle in square feet scribed by the radius of the dome at ground level on each dome built for a customer. The formula used will be: Pi times the radius squared where Pi equals 3.14.

$(\text{diameter} \div 2)^2 (3.14) (\$0.10) = \text{Royalty Payment}$

**For example:**

1. The royalty due on a 40-foot dome with a radius of 20 feet would be  $(20')^2 = 400' \times 3.14 = 1256 \text{ sq. ft.}$  and  $1256 \text{ sq. ft.} \times \$0.10 \text{ per sq. ft.} = \$125.60.$
2. The royalty due on a 12-foot dome with a radius of 6 feet would be  $(6')^2 = 36' \times 3.14 = 113 \text{ sq. ft.}$  and  $113 \text{ sq. ft.} \times \$0.10 \text{ per sq. ft.} = \$11.30.$

**Payments to Licensors.**

Within thirty days after the Royalty accrues, Licensee shall pay to Licensors at the address set out above or at the web site domeplans.com the Royalty described in the preceding paragraph. All payments shall be paid in United States currency drawn on a United States bank. The acceptance by Licensors of any of royalties paid shall not preclude Licensors questioning the correctness at any time of any payments.

**Audit.**

Licensee shall keep accurate books of account and records covering all transactions relating to the license granted in this Agreement, and Licensors or its duly authorized representatives shall have the right upon five days prior written notice, and during normal business hours, to inspect and audit Licensee's records relating to the Work licensed under this Agreement. If the results indicate an underpayment, Licensee shall promptly reimburse Licensors for all costs of the audit along with the amount due with interest on such sums. Interest shall accrue from the date the payment was originally due, and the interest rate shall be 1.5% per month, or

the maximum rate permitted by law, whichever is less. All books of account and records shall be made available and kept available for at least two years after Royalties accrue under this Agreement.

**Late Payment.**

Time is of the essence with respect to all payments to be made by Licensee under this Agreement. If Licensee is late in any payment provided for in this Agreement, Licensee shall pay interest on the payment from the date due until paid at a rate of 1.5% per month, or the maximum rate permitted by law, whichever is less.

**Limitation of Licensor Liability.**

Licensor's maximum liability to Licensee under this agreement, regardless on what basis liability is asserted, shall in no event exceed the total amount paid to Licensor under this Agreement. Licensor shall not be liable to Licensee for any incidental, consequential, punitive or special damages.

**Compliance with Intellectual Property Laws.**

The license granted in this Agreement is conditioned on Licensee's compliance with the provisions of all applicable laws and regulations, including but not limited to intellectual property laws of the United States and any foreign country. All copies of the Work as well as all promotional material shall bear appropriate proprietary notices.

**Licensor's Right to Terminate.**

Licensor shall have the right to terminate this Agreement for the following reasons:

- (a) Licensee fails to pay Royalties when due and such failure is not cured within thirty days after written notice from the Licensor;
- (b) Licensee assigns or sublicenses the Work in violation of the Agreement; or
- (c) Licensee breaches any other term of the Agreement.

**Effect of Termination.**

After termination of this license, all rights granted to the Licensee under this Agreement shall terminate and revert to Licensor, and Licensee will refrain from further use of the Work.

**Attorneys' Fees and Expenses.**

The prevailing party shall have the right to collect from the other party its reasonable costs and necessary disbursements and attorneys' fees incurred in enforcing this Agreement.

**Dispute Resolution - Alternative Dispute Resolution.**

If a dispute arises and cannot be resolved by the parties, either party may make a written demand for formal resolution of the dispute. The written request will specify the scope of the dispute. Within 30 days after such written notice, the parties agree to meet, for one day, with an impartial mediator and consider dispute resolution alternatives other than litigation. If an alternative method of dispute resolution is not agreed upon within 30 days of the one-day mediation, either side may start litigation proceedings.

**Governing Law.**

This Agreement shall be governed in accordance with the laws of the State of Oregon and of the United States of America.

**Jurisdiction.**

The parties consent to the exclusive jurisdiction and venue of the federal and state courts located in Lane County, Oregon, United States of America in any action arising out of or relating to this Agreement. The parties waive any other venue to which either party might be entitled by domicile or otherwise.

**Waiver.**

The failure to exercise any right provided in this Agreement shall not be a waiver of prior or subsequent rights.

**Invalidity.**

If any provision of this Agreement is invalid under applicable statute or rule of law, it is to be considered omitted and the remaining provisions of this Agreement shall in no way be affected.

**Entire Understanding.**

This Agreement expresses the complete understanding of the parties and supersedes all prior representations, agreements and understandings, whether written or oral. This Agreement may not be altered except by a written document signed by both parties.

**Notices.**

Any notice or communication required or permitted to be given under this Agreement shall be sufficiently given when received by certified mail, or sent by facsimile transmission or overnight courier.

**No Joint Venture.**

Nothing contained in this Agreement shall be construed to place the parties in the relationship of agent, employee, franchisee, officer, partners or joint ventures. Neither party may create nor assume any obligation on behalf of the other.

**Assignability.**

Licensee may not assign or transfer its rights or obligations pursuant to this Agreement without the prior written consent of Licensor. Any assignment or transfer in violation of this section shall be void.

**Execution.**

Each party executing this agreement personally or on behalf of a corporation warrants that the party is authorized to enter this Agreement personally or on behalf of such corporation and that this Agreement is binding on the party.

**Notice.**

**LICENSOR MAKES NO REPRESENTATIONS ABOUT THE SUITABILITY OF THE INFORMATION CONTAINED IN THE DOCUMENTS AND GRAPHICS PUBLISHED AS PART OF THE BOOK PROFESSIONAL DOME PLANS, THIRD EDITION ("THE WORK") FOR ANY PURPOSE. THE WORK IS PROVIDED "AS IS" WITHOUT WARRANTY OF ANY KIND. LICENSOR HEREBY DISCLAIMS ALL WARRANTIES AND CONDITIONS WITH REGARD TO THE WORK, INCLUDING ALL WARRANTIES AND CONDITIONS OF MERCHANTABILITY, WHETHER EXPRESS, IMPLIED OR STATUTORY, FITNESS FOR A PARTICULAR PURPOSE, TITLE AND NONINFRINGEMENT. LICENSOR SHALL IN NO EVENT BE LIABLE FOR ANY SPECIAL, INDIRECT OR CONSEQUENTIAL DAMAGES OR ANY DAMAGES WHATSOEVER RESULTING FROM LOSS OF USE, WHETHER IN AN ACTION OF CONTRACT, NEGLIGENCE OR OTHER TORTIOUS ACTION, ARISING OUT OF OR IN CONNECTION WITH THE USE OF INFORMATION AVAILABLE IN THE WORK.**

**I have read and I understand the terms and conditions of the license agreements.**

# PROFESSIONAL DOME PLANS

Third Edition 3.01

Copyright © 1987, 1988, 2002 by Jeffrey O. Hill  
All rights reserved.

LICENSOR MAKES NO REPRESENTATIONS ABOUT THE SUITABILITY OF THE INFORMATION CONTAINED IN THE DOCUMENTS AND GRAPHICS PUBLISHED AS PART OF *PROFESSIONAL DOME PLANS, THIRD EDITION* ("THE WORK") FOR ANY PURPOSE. THE WORK IS PROVIDED "AS IS" WITHOUT WARRANTY OF ANY KIND. LICENSOR HEREBY DISCLAIMS ALL WARRANTIES AND CONDITIONS WITH REGARD TO THE WORK, INCLUDING ALL WARRANTIES AND CONDITIONS OF MERCHANTABILITY, WHETHER EXPRESS, IMPLIED OR STATUTORY, FITNESS FOR A PARTICULAR PURPOSE, TITLE AND NONINFRINGEMENT. LICENSOR SHALL IN NO EVENT BE LIABLE FOR ANY SPECIAL, INDIRECT OR CONSEQUENTIAL DAMAGES OR ANY DAMAGES WHATSOEVER, WHETHER IN AN ACTION OF CONTRACT, NEGLIGENCE OR OTHER TORTIOUS ACTION, ARISING OUT OF OR IN CONNECTION WITH THE USE OF INFORMATION IN THE WORK.

Building a dome as a do-it-yourself project can be a real challenge. It's difficult to know where to begin even for those with considerable building experience. If you dig deep enough, you can find plenty of information describing the geometry of domes, although most of it is rather technical and theoretical and often lacks the kind of practical hands on advice needed to turn theory into a finished product.

This plan book is designed to fill that void by focusing almost entirely on simple, detailed shop drawings that show how domes are built with virtually no need for higher math. In fact, the only math you'll see in these plans are the 4 basic functions used in a list of formulas for calculating the length of various parts.

The underlying geometry describes carbon 60, the third stable form of pure carbon after graphite and diamond called buckminsterfullerene or buckyballs. Its shape is a 3 frequency (3v) icosahedron which is an industry-standard for dome homes. If that sounds complicated, and I'm pretty sure it does, I guarantee you it doesn't matter. Understanding the complex geodesic math involved in the design of domes is completely unnecessary when it comes to the actual process of building one. All you'll need are basic woodworking skills and a little patience. With that, you should have little trouble building your own dome.

## TERMS

HEXagons and PENTagons: 3v icosadomes are made up of two basic shapes of isosceles triangles arranged in groups. There are five groups of six panels each, called Hex groups, and six groups of five panels each, called Pent groups. These are easy to imagine by using a classic black and white soccer ball. The white patches are Hex groups and the black patches are Pent groups. By putting one Pent group on top and cutting an imaginary plane under the other five Pent groups that surround it, you will see the approximate 3/8 sphere described in these plans.

A CHORD is the line that defines the side of a triangular panel. All chords intersect the imaginary sphere at both ends to create nodes and a soccer ball shape with flat triangular facets.

COHRD FACTORS are numbers that represent ratios that are multiplied by the dome diameter (DD) to calculate the length of chords. They are always stated as the DD x the number. An example would be: 540"

x .2048135683 = 110.5993269" or 110 19/32" which is the A chord for a 45' dome.

Sometimes dome books use chord factors referenced to the true radius or diameter of the sphere the dome is based on. While technically accurate, these numbers are a little difficult to work with because you can't easily measure the true radius or diameter of a 3v dome. This is because the true center of the sphere lies below the floor plane that divides the dome into useful structures. While the chord factors used here are related to the true diameter, they are referenced to the diameter at floor level. This is a number twice the radius from the center of the floor to any corner (p. 9). No two corners are opposite each other in a straight line however so in a 40' dome there is no 40' line but rather a 20' radius that scribes a 40' circle.

Even though the diameter is never really measured, it still serves as a perfect benchmark to ratio many other dimensions from. For example: the radius of a 40' dome is 40' x .5 or 20'. Similarly, the true diameter of a 40' dome is 40' x 1.015063688 or 40' 7 7/32". This will work with all scalable dimensions if you have the right ratios.

Incidentally, nearly all measurements are given in inches rather than feet with the exception being explanations like the one above. Decimal calculations done in feet add the complication of converting the remainder to inches which is just another opportunity for error.

STRUTS are the individual boards that make up the sides of the panels. Their lengths are found by multiplying the DD x a chord factor minus a constant that allows for the angled cross-section of the adjacent strut.

The labeling of struts corresponds to the group they're associated with. H stands for Hex and P for



Pent followed by A, B or C added in a clockwise direction beginning with the base: HA, HB and HC for Hex panels, and PA, PB and PC for Pents.

BACKERS are the boards that fill in the panels and provide backing for the Sheetrock®. They are labeled with a P or H followed by 1, 2, 3 etc. from largest to smallest.

RISER WALLS are typically short walls that sit directly under the lower Pent groups. In domes smaller than 45' they are necessary to allow adequate height for entry through the natural openings. By raising the dome they also provide more usable floor space on the second floor.

The ratios provided in the Elevation drawing (p.11) give an idea of the effect of different riser wall heights on interior space. Simply multiply the DD x the ratio of a selected node and you will get its height, excluding the riser wall, for any size dome. Now add whatever riser wall height you want and you'll see exactly where that node will be on the second floor. This can be very helpful in deciding where to put skylights in case you might want to see something other than sky.

SHEAR PANELS are rectangular stress skin panels that are bolted and strapped to the ends of the riser walls and to the foundation. They prevent the riser walls from being pushed over by the dome by holding them in a ridged vertical position. Standard Shear Panels sit in line with the exterior walls and should be incorporated into the walls' design. The suggested size represents the minimum. The larger the area of shear the stronger and safer the design.

Extension Shear Panels project from the dome perpendicular to the openings and provide a base to build extensions on. In this arrangement they form a buttress which is very effective in resisting the overturning forces of the dome.

The TENSION RING is the line of struts that surrounds the dome just above the natural openings. This is where the compressional forces of live and dead loads are transformed into tension and constrained by the straps in a circle around the dome. The give and take of compression and tension is of course far more complicated than that, but the conclusion is the same. The tension ring holds the dome together and is one of the most critical links in the system. Great care should be taken to see that it's secure. In fact it's probably wise (although it's not always done) to double the A strut in the Hex panels over the openings. This gives you a double strut around the entire dome. At the cost of 5 boards it seems a small price to pay for the added security. To properly install straps, you need solid material beneath all the nails, so without a second strut you will need to add blocking anyway .

## FORMAT

DOME DRAWINGS: The two drawings on pages 10 and 11 show a top view and an elevation of an approximate 40' dome on a 3 1/2' riser wall. They are consistent except for a slightly different placement of skylight panels and no shear panels in the top view. Ratios are given for several dimensions which should give you some feel for the proportions of different sized domes.

In the elevation, dotted lines, which normally represent hidden lines, are instead used to show panels

visible only from the inside. The little numbers at the vertex of each panel match numbers on the individual panel drawings to indicate their general type and location.

In the lower Pent groups you'll notice that the two Bottom Side Pent panels have the backers laid out parallel to the A strut rather than perpendicular. Often domes are built with all the Pent panels constructed identically as Standard Pent panels. With larger domes or in heavy snow loads, you should consider using this alternate parallel layout. Structurally, the bottom three Pent panels are really more of a wall the dome sits on than part of the dome itself. Running the backers in this more or less vertical arrangement, in the Bottom Side Pents, makes much better use of their load bearing capacity and greatly improves the panels' resistance to buckling under stress.

PANEL DRAWINGS: All panels are drawn skin side up with the skin removed. Possible plywood layouts are shown on the next page. Panels are also all shown framed as 2x6 with backers on 24" centers although 2x4 domes and big domes in heavy snow loads may be safer when built with 16" centers.

As for 2x4 versus 2x6 construction, I would advise not to build any serious dome home with 2x4s. A good case can be made for the relative strength and energy efficiency of 2x4s in domes versus 2x6s in a conventional structure, but it's an apples and oranges argument. The real comparison is dome to dome and in that case 2x6 is better in nearly every way, if perhaps a trifle more expensive in material. Local building officials, who are often unfamiliar with dome construction methods, are also much less likely to have a 2x6 dome violate their comfort zone.

All parts measurements are taken from the outer surface of the framing at the outside upper edge of the

panels as defined by the chord lines. This allows for the dome to be made from any dimension lumber from 2x2s to 2x12s, without changing the lengths of the parts.

Triangular skylight drawings are shown with the 2x4 curb removed and drawn truncated in the center. A cross-section of this detail appears at the upper left of each drawing. Rectangular Velux® skylights are flush mounted without curbs.

Bolt hole layouts are intended to be universal and work, in most cases, with any panel of the same basic size and shape. The exceptions are with a few Velux skylights and are noted on the drawings.

PLYWOOD DRAWINGS: These drawings show possible ways of cutting plywood skins from 4x8 and occasionally 4x10 plywood. When cutting skins for a dome other than the ones pictured, follow the basic style shown here. Make sure any seams between plywood pieces fall on backing and are glued and stapled. In panelized stress skin domes, the skin carries a good deal of the load, so breaks in the skin are potential breaks in the load transfer.

RISER WALL DRAWINGS: Riser walls are drawn with an additional end view to make them clearer. The bottom plates and studs are not shown separately because they have only simple angles evident from the main drawings.

The riser walls pictured for the three domes drawn are sized to position the A Strut in the Hex panels over the openings about 36" off the second floor. This allows for a nice view from a skylight.

Riser walls can be almost any height as long as the shear panels are proportionate. A good rule of thumb is the shear panel should be at least as wide as it is tall.

It's actually best to incorporate the shear panels right into the exterior walls. This way the effective area of shear will increase where any plywood laps beyond the minimum framing of the shear panel itself.

When building on a concrete slab, make sure you carefully locate and incorporate the bottom straps into the foundation when it is poured. No matter how strongly built your riser walls and shear panels are, they're useless unless properly attached to the foundation.

It's also possible to use no riser wall at all. This is a interesting alternative for domes over 45' built on a tight budget. It's often less expensive to build these domes per square foot because there are fewer and larger components for the same usable floor space. 45' is about as small as you can go with this design though, in that you need a minimum height for the exterior doors.

If you choose to use this simplified design you will need a bottom plate under the dome beveled to the same angle as the riser wall top.

STRUT & BACKER CROSS-SECTIONS: Struts, because they must be beveled on both edges, always require a wider initial piece of lumber than backers. If for instance, backers are made from full 2x6s, then their accompanying struts will have to be cut down from 2x8s. Similarly if struts start out as 2x6s and are minimally milled, they will end up slightly smaller and the backers will need to be ripped down to match. The drawings on page 8 show both options for 2x4, 2x6 and 2x8 domes.

PARTS DRAWINGS: These drawings are the real heart of the plans. They appear with every panel and show a simplified view of its most complicated parts (simple blocks are omitted).

Boards are shown as if lying flat on your radial arm saw table. They are to rough scale with the lengths truncated to save space. Very slight angles have been exaggerated for clarity. Degree marks are omitted as unnecessary.

Angles are given in reference to the saw with S indicating the Swing of the arm and T being the Tilt of the head. B indicates the Bevel of your table saw and appears with the end view.

Dimensions of backers that vary only in length are shown in a list above or below the drawings with only the longest backer shown.

Identifying labels are placed on the same end of the boards as they appear in the scale drawings. The little arrows show the side of the boards the skin is attached to. Make sure you apply these labels and arrows to every board as you go about cutting. If you don't, I guarantee you that you won't be able to tell them apart especially with the Hex struts.

ANGLES: Angles are always displayed to the second decimal and are never rounded off. This makes matching the 10 digit equivalents listed with the formulas easy. You may never need to use any of these precision numbers but if you ever want to calculate some new part, they can be a very useful starting point.

DIMENSIONS: Dimensions are rounded generally to the nearest 1/32" with very slight adjustments made to allow for matching struts that round in opposite directions.

This level of accuracy may seem extreme, but it's my experience that people are capable of making all the necessary mistakes without help from sloppy dimensions. Just seeing numbers like 110 19/32" tends to make one work more carefully. Then too, domes are far less forgiving than most wooden structures. Even

small errors will accumulate making the last panels difficult to install.

The lengths of parts for arbitrary-sized domes can be calculated using 12 simple, although very precise formulas, on page 6. They all use the same approach —  $DD \times a$  ratio minus a constant or two to get the final length.

There are also 4 tables that list strut and backer lengths precalculated for 49 dome sizes from 12' to 60' with backer lengths figured for both 16" and 24" centers.

## FABRICATION

**GLUING:** Consider gluing if the dome you're building is over 35' or will be subjected to heavy loads. The method of dome building shown in these plans relies heavily on the skin to transfer stress from panel to panel. When bound to the struts with glue, this capacity is greatly increased. Shear panels must be glued in any case, even if you choose not to glue the entire dome.

Glue should be waterproof and "structural", of the resorcinol phenolic resin type. Construction adhesives, while better than nothing, will creep under constant stress over time. Structural glues won't.

**NAILING & STAPLING:** Nail the framing with a pneumatic nail gun. Hot dip galvanized, full round head, 3 1/2" by .120" spiral shank nails should work well. These nails are very long and thin. This allows good penetration when shooting at an angle at the strut ends. The .120" shank also minimizes the chance of splitting the ends of the struts. Another advantage of air nailing is that it's much faster. Also, if you have a slightly warped strut, as sometimes happens, you can set one nail as a pivot point and then with a big

Crescent® wrench twist the strut into position just beyond the right spot with one hand, then fasten it quickly with the other and it will relax back to a perfect alignment.

Nail the framing on 2x6 domes with 5 nails in the panel corners where the struts meet and 4 in both ends of the backers if using .120" shank nails.

When backers run perpendicular to the A, strut they should be snugged up and fastened first from the inside on the sharp end with small staples or nails. This insures a tight fit which allows the backers to key in place because of the bevel of the struts.

Flush all framing on the skin side pushing any error to the inside of the panel. This guarantees an intimate glue joint with minimal bridging between parts.

When attaching skins I prefer to use staples. If gluing the skins, space staples 3" on center around the perimeter and on both sides of any seams and 5" on center everywhere else. If not gluing, space them even tighter. If any staples remain above the panel surface, tap them down flush with a hammer to insure a good glue joint. Also make sure the crown of the staple does not run parallel to the grain of the top ply of the plywood. You want the crown to cross the grain and pull the plywood down.

Nail and staple guns can be rented from most general rental companies. A Senco® SN65 or FramePro 650 FRH will work well for framing. A Senco® SNS45 or SNS50 stapler with N-19-BAB staples can be used for skins. If you have difficulty finding 3 1/2" by .120" gun nails locally, you can find them at mazenails.com. in Peru, Illinois, USA.

**JIGS:** When building just one or two domes, making elaborate production jigs is unrealistic and unnecessary. Well cut struts with cleanly fastened corners will have the proper chords and should

produce a nearly perfect dome if the struts are straight. Bowed struts, on the other hand, will cause a lot of problems. Even a 1/4" belly in the sides of two adjacent panels will push the panels apart 1/2" at the tips. If you do get one end together, the other end will usually get worse. Errors like this can be overpowered sometimes during assembly, but it's not much fun.

A simple jig made from three dead straight 2x4s nailed to the surface of a work table, snug around a panel, will help keep the struts straight while installing the backers and attaching the skin.

**LUMBER:** For any larger dome lumber should be #1 grade for struts and at least #2 & better for backers. Where skins will be glued and the inside finished, it should also be kiln dried. Air dried lumber will work as long as it's well seasoned with a moisture content as low as KD. Green or wet lumber will not support a good glue joint and tends to warp as it dries.

**PLYWOOD:** Plywood should be at a minimum 1/2" 5 ply CDX or the equivalent, and glued down when running parallel to the backers. Never use 3 ply or 4 ply plywood in this arrangement. It's very weak across the grain and will be spongy under foot, especially on 24" centers.

**BOLT HOLES:** Bolt holes are laid out from the vertex down both equal sides for the B and C Struts. For the A struts they're laid out from the center to both ends. This is because in the case of A Struts, HAs match PAs but must also match themselves. An HA to HA paring will double any error made in laying out the bolt holes from one end. Layout done from the center will minimize this problem.

Center is most accurately found by measuring it twice from both ends of the strut. If both lines are not

in exactly the same spot, a line splitting the difference will be the center.

Bolt holes can be jugged by drilling holes for guides in the center of a 2x4 and clamping it flush to the top of the framing. Just make sure you mark the vertex end in the case of B and C Struts and always flush that end. With A Struts, lay the jig holes out from center and match that mark to a center line made on the struts themselves.

Bolt holes should be drilled 1 3/4" down the outside face of the struts at 90° to their surface. This transfers stress in as direct a path as possible from skin to skin. Holes should be 5/8" when predrilled to allow for adjustments.

Bolt placement and spacing are somewhat arbitrary. The layouts illustrated follow a deliberately conservative pattern of a bolt approximately every 24" beginning and ending about 10" or less from the tips. The purpose here is not only to transfer loads, but is also to prevent Sheetrock® cracking. With domes, the joints in the Sheetrock® unavoidably fall right on the joints between the panels creating a weak spot. In a 45' dome this amounts to more than 700' of joint. That's a lot of potential for damage, so a few extra bolts are worth the price.

**HARDWARE:** Bolts can be 1/2" x 4" grade 2. Washers can be 1/2" heavy flat washers but 3/8" malleable iron washers work a lot better. Their hole is just a little over 3/8" so 1/2" bolts (which are actually under 1/2") will fit through them most of the time without reaming. The difference is in the amount of torque they will take. Flat washers will bend in a cup shape under stress and noticeably crush the wood underneath them. Malleable iron washers, which have at least three times the bearing surface, will feel tight long before you notice any crushed wood. This allows

you to torque the bolts closer to specs. and get the struts tighter together.

**STRAPS:** The size and strength of straps used depends on the size of dome you build and the loads you expect. Single 3' long Simpson MTS37 straps, or the equivalent in strength, have been used on 45' domes in snow loads below 30 lbs. In heavier snow loads, a second ring of straps should be installed at the next ring of struts up from the tension ring.

## ASSEMBLY

Raising a dome is fairly straightforward. Domes are sometimes raised by prefabricating the lower five Pent groups on the ground and then tilting them up as one piece. While this works well enough for smaller 2x4 domes, it would be difficult and certainly dangerous with a 60' 2x6 dome. With larger domes you may want to begin with just the bottom three Pent panels and go one at a time from then on. In any case, make sure to brace everything well as you go. A dome is not self supporting until the first forty panels are up and form a complete tension ring.

Bolts should be tightened as you go along except for the two Hex to Hex seams in the Hex group that meets the last Pent Panel. Leaving these bolts a little loose allows you to flex the dome open slightly with two long poles and slip the final Pent panel in more easily. After the dome is up it's a good idea to go around and retorque the bolts one last time before you cover them up. Sometimes a few just get missed otherwise.

Take time to finish one step before racing on to the next. Riser walls and shear panels, if used, should be completely strapped to the foundation prior to raising

the dome. This guarantees that no movement takes place before the straps are called on to take up load.

Strapping should be installed on the dome itself as soon as the tension ring is finished. This is because tension straps allow a very slight movement of the panels as they load up. As you add additional panels, the straps will come under tension and seat, allowing no further movement. If you wait until after the dome is up to install the straps, it will actually be the bolts at the tension ring that are taking the stress and not the straps. Now add a roof, Sheetrock® and about two feet of snow, and you may get a minor movement of the panels as the straps take up the additional load. The result at worst will likely be nothing more than hairline cracks over the openings but they're worth avoiding if you can.

## SMALL SCALE DOMES

These plans focus mainly on building large scale domes which is reflected in the use of full-dimension lumber in all of the drawings and tables. Small scale domes for use as a back yard storage building or potting shed don't really need this heavy lumber and can be sensibly built making panels from thinner lumber such as 1x4s. You can easily calculate the parts for these domes using the formulas on page 6. They need only minor modifications that account for the smaller cross-section of the lumber.

To figure struts, use the same ratios but reduce the following constant by the percentage your lumber is thinner than standard 1 1/2" lumber. For instance: 3/4" lumber is 1/2 as thick as standard lumber so you would divide the constant by 2. 1/2" lumber is 1/3 as thick so you would divide the constant by 3, and so on.

To figure backers, you again use the same ratios and reduce the first constant by the percentage your

lumber is thinner. The second constant, however, should remain the same. Its only purpose is to calculate the change in the length of a backer relative to its position on layout. No cross-sectional dimensions are involved in this process so it is unaffected by lumber thickness.

## FORMULAS

Calculating the length of struts is straightforward. The dome diameter (DD) is first multiplied by a ratio to figure the entire length of a panel's side or chord. A constant, which allows for the angled cross-section of the adjacent strut, is then subtracted to produce the finished strut length.

Calculating backers is a little more complicated. In the case of backers running parallel to any strut, the DD is first multiplied by a ratio to establish the chord. A constant is then subtracted that allows for the angled cross-section of both intersecting struts as if they crossed at both ends. A second constant is then subtracted for every inch the backer is away from the base line on layout. That is if the backer you want is 13 1/2" from the edge, you would multiply the second constant by 13.5 and subtract.

If the backers are perpendicular to the A Strut, the DD is first multiplied by a ratio that establishes a line that bisects the panel through the vertex. A constant is then subtracted that allows for the cross-section of the A Strut plus the intersection of the B and C Struts. This produces a number equal to the length of the first center backer. Subsequent backers are figured by subtracting a second constant for every inch they are from the center line on layout. Remember that since the reference line is to the center of the panel, and not the edge of a backer, a 3/4" allowance must be made on the first layout. That is, on 16' centers laid out on

center, the second backer would be 15 1/4" from center not 16". Laid out off center, the first backer would be 7 1/4" from the reference line, not 8".

Building a dome is really not that different from any other building project. In the beginning there are always two big questions:

1. What do the parts look like?
2. How do they go together?

If you know the answers to these two questions your odds of success are pretty good. To that end, I hope you find these plans helpful.

j.o. hill

*Most formulas and data have been zeroed in the sample version.*

## HEX STRUTS

$$\begin{aligned} HA &= DD \times .2048135683 - 1.732050808'' \\ HB &= DD \times .0000000000 - 0.000000000'' \\ HC &= DD \times .0000000000 - 0.000000000'' \end{aligned}$$

## HEX BACKERS

$$\text{Perpendicular to the A Strut} = DD \times .0000000000 - 0.000000000'' - (0.000000000'' \text{ per inch of layout})$$

$$\text{Parallel to the A Strut} = DD \times .0000000000 - 0.000000000'' - (0.000000000'' \text{ per inch of layout})$$

$$\text{Parallel to the B or C Struts} = DD \times .0000000000 - 0.000000000'' - (0.000000000'' \text{ per inch of layout})$$

## PENT STRUTS

$$\begin{aligned} PA &= DD \times .0000000000 - 0.000000000'' \\ PB &= DD \times .0000000000 - 0.000000000'' \\ PC &= DD \times .0000000000 - 0.000000000'' \end{aligned}$$

## PENT BACKERS

$$\text{Perpendicular to the A Strut} = DD \times .0000000000 - 0.000000000'' - (0.000000000'' \text{ per inch of layout})$$

$$\text{Parallel to the A Strut} = DD \times .0000000000 - 0.000000000'' - (0.000000000'' \text{ per inch of layout})$$

$$\text{Parallel to the B or C Struts} = DD \times .0000000000 - 0.000000000'' - (0.000000000'' \text{ per inch of layout})$$

## REFERENCE ANGLES

0.000000000°	00.0000000°	00.0000000°
0.000000000°	00.0000000°	29.29158251°
0.000000000°	00.0000000°	00.00°...
0.000000000°	00.0000000°	00.0000000°
6.789275306°	00.0000000°	31.41683498°
0.000000000°	00.0000000°	00.0000000°
7.22886028°	00.0000000°	00.0000000°
0.000000000°	00.00°...	00.0000000°
0.000000000°	00.0000000°	00.0000000°
0.000000000°	00.0000000°	00.0000000°
0.000000000°	00.00°...	00.00°...
0.000000000°	00.0000000°	00.00°...
0.000000000°	00.0000000°	

## CONTENTS

1. — 7. Text
8. Strut and backer cross sections
9. Foundation Layout
10. Top View
11. Elevation
12. 39' Standard Pent
13. plywood layout for above
14. 39' Bottom Side Pent
15. plywood layout for above
16. 39' Pent for Sierra Plastics P35 Skylight
17. plywood layout for above
18. 39' Pent for Velux Model 104 Skylights
19. plywood layout for above
20. 39' Standard Hex
21. plywood layout for above
22. 39' Hex for Sierra Plastics H35 Skylight
23. plywood layout for above
24. 39' Hex for Velux Model 304 Skylights
25. plywood layout for above
26. 39' Hex for Velux Model 104 Skylights
27. plywood layout for above
28. 18/18 & 27/27 Riser Walls for 39' Dome
29. 18/27 & 27/18 Riser Walls for 39' Dome
30. Standard & Extension Shear Panels for 39' Dome
31. & 32. Table of Pent backers perpendicular to the A Strut.
33. Table of Pent backers parallel to the A Strut
34. 45' Standard Pent
35. plywood layout for above
36. 45' Bottom Side Pent
37. plywood layout for above
38. 45' Pent for Sierra Plastics P45 Skylight
39. plywood layout for above
40. 45' Pent for Velux Model 306 Skylights
41. plywood layout for above
42. 45' Standard Hex
43. plywood layout for above
44. 45' Hex for Sierra Plastics H45 Skylight
45. plywood layout for above
46. 45' Hex for Velux Model 108 Skylights
47. plywood layout for above
48. 45' Hex for Velux Model 308 Skylights
49. plywood layout for above
50. 18/18 & 27/27 Riser Walls for 45' Dome
51. 18/27 & 27/18 Riser Walls for 45' Dome
52. Standard & Extension Shear Panels for 45' Dome
53. & 54. Table of Hex backers perpendicular to the A Strut.
55. Table of strut lengths for both Hex and Pent panels.
56. 50' Standard Pent
57. plywood layout for above
58. 50' Bottom Side Pent
59. plywood layout for above
60. 50' Pent for Sierra Plastics P60 Skylight
61. plywood layout for above
62. 50' Pent for Velux Model 306 Skylights
63. plywood layout for above
64. 50' Pent for Velux Model 108 Skylights
65. plywood layout for above
66. 50' Standard Hex
67. plywood layout for above
68. 50' Hex for Sierra Plastics H60 Skylight
69. plywood layout for above
70. 50' Hex for Velux Model 108 Skylights
71. plywood layout for above
72. 50' Hex for Velux Model 308 Skylights
73. plywood layout for above
74. 18/18 & 27/27 Riser Walls for 50' Dome
75. 18/27 & 27/18 Riser Walls for 50' Dome
76. Standard & Extension Shear Panels for 50' Dome

Sheetrock® is a registered trademark of United States Gypsum Company. Velux® is a registered trademark of Velux-America Inc. Senco® is a registered trademark of Senco Products Inc. Crescent® is a registered trademark of Cooper Industries Inc.

To inquire about how to buy Sierra Skylights, contact:

Sierra Plastics Inc.  
7601 4th St.  
White City, OR 97503

541-826-5699 Fax  
1-800-888-0532  
www.sierraplastics.com

To inquire about specialty nails contact:

Maze Nails  
P.O. Box 449  
Peru, IL 61354

1-800-435-5949  
www.mazenails.com



Top View

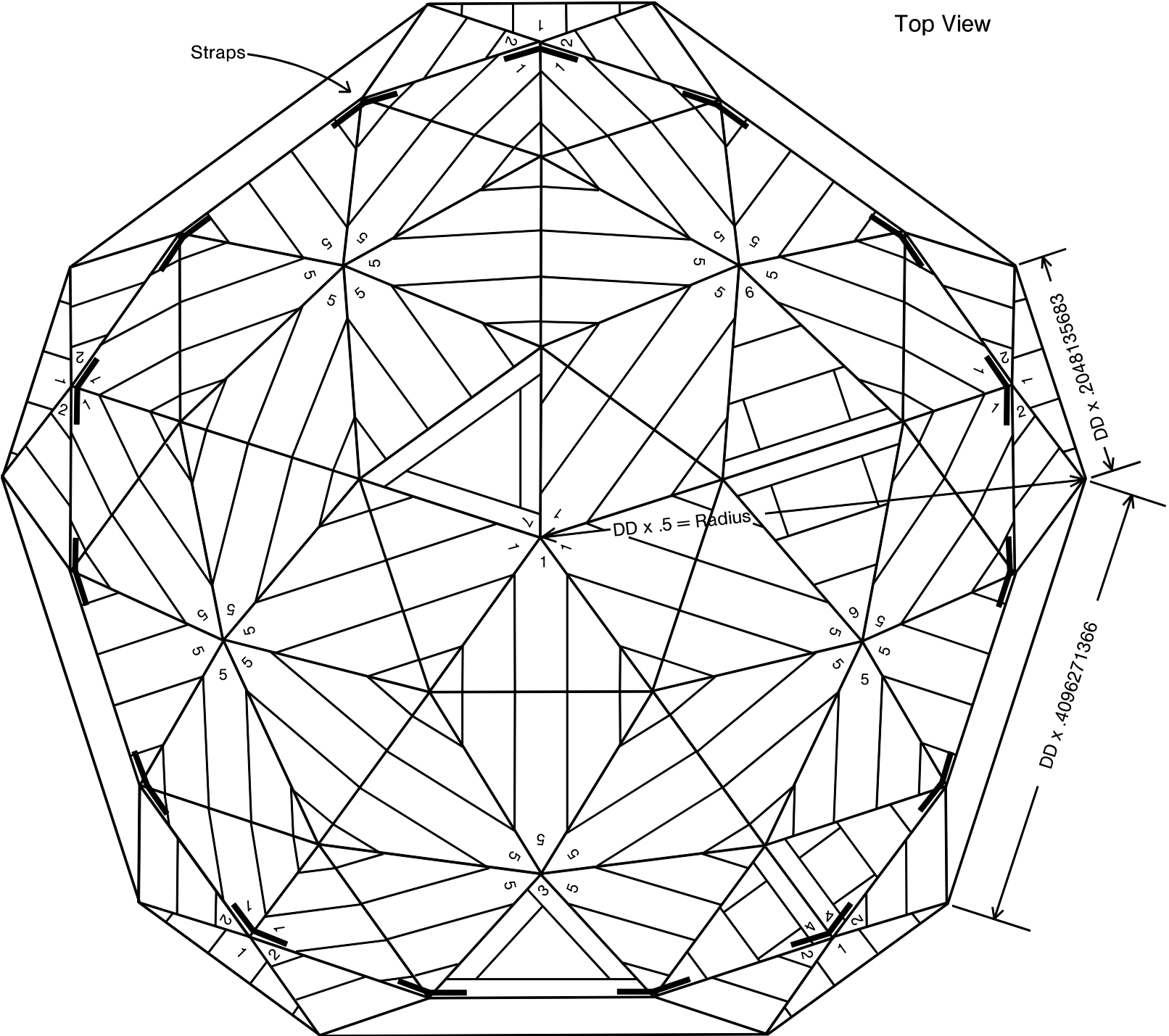

- 1 = Standard Pent
- 2 = Bottom Side Pent
- 3 = Hex Sierra Skylight
- 4 = Pent Velux Skylight
- 5 = Standard Hex
- 6 = Hex Velux Skylight
- 7 = Pent Sierra Skylight



# Elevation

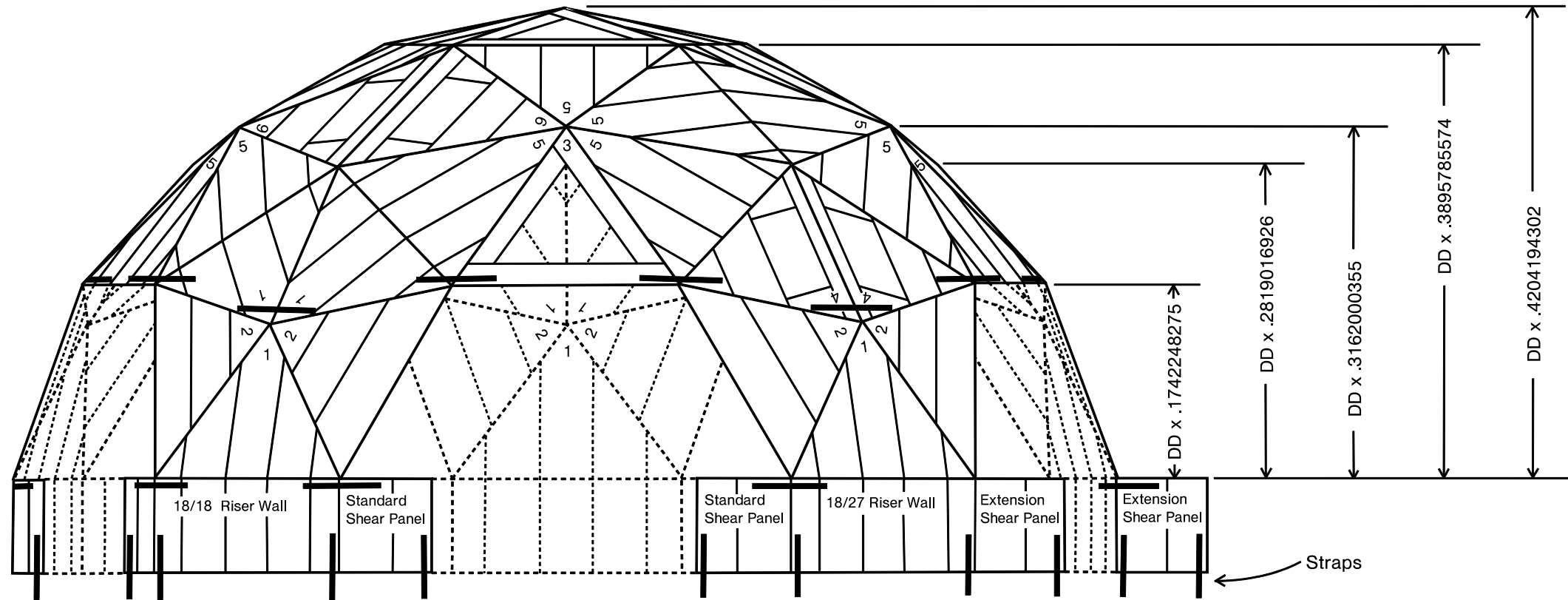

39' Standard Hex

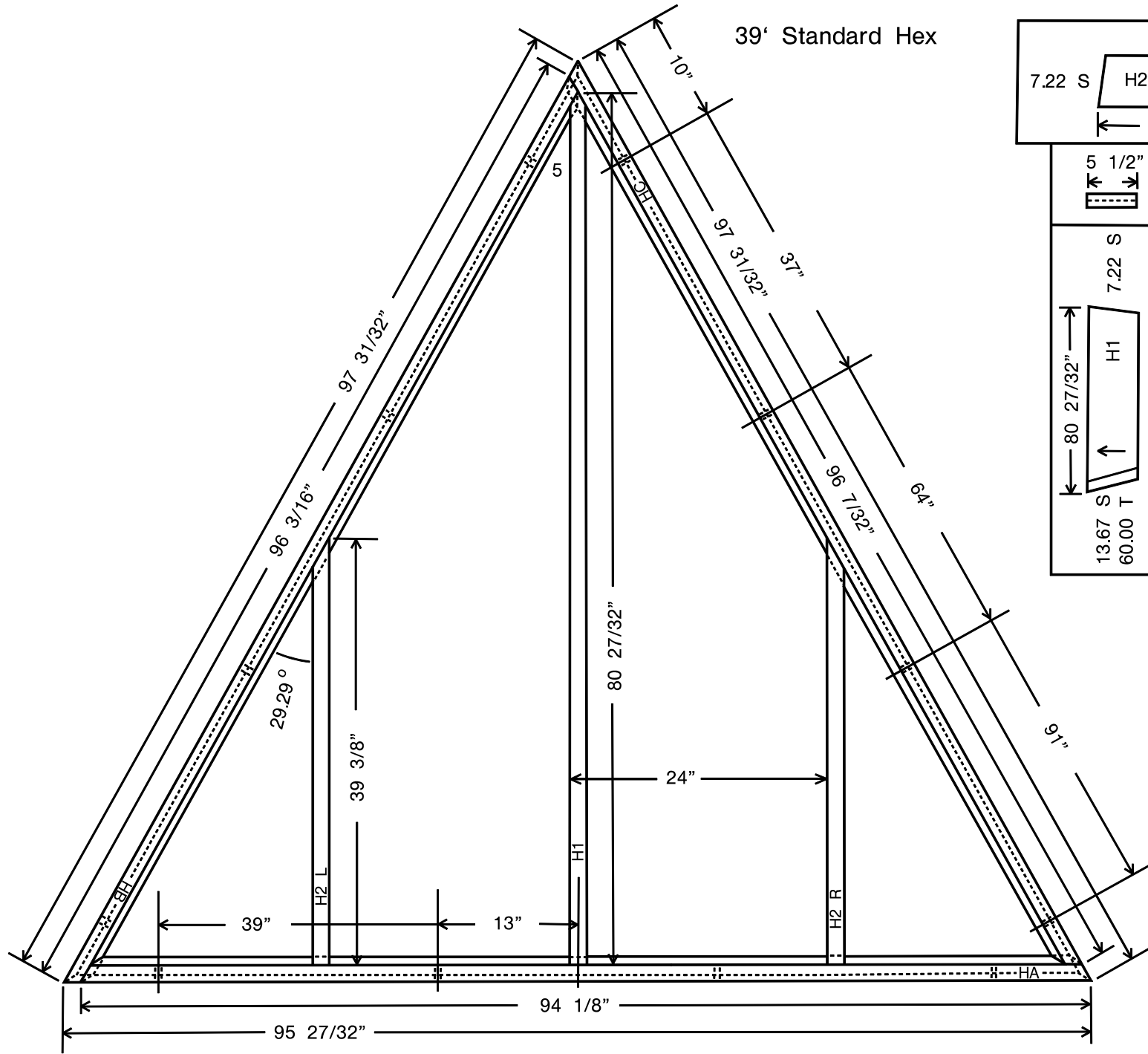

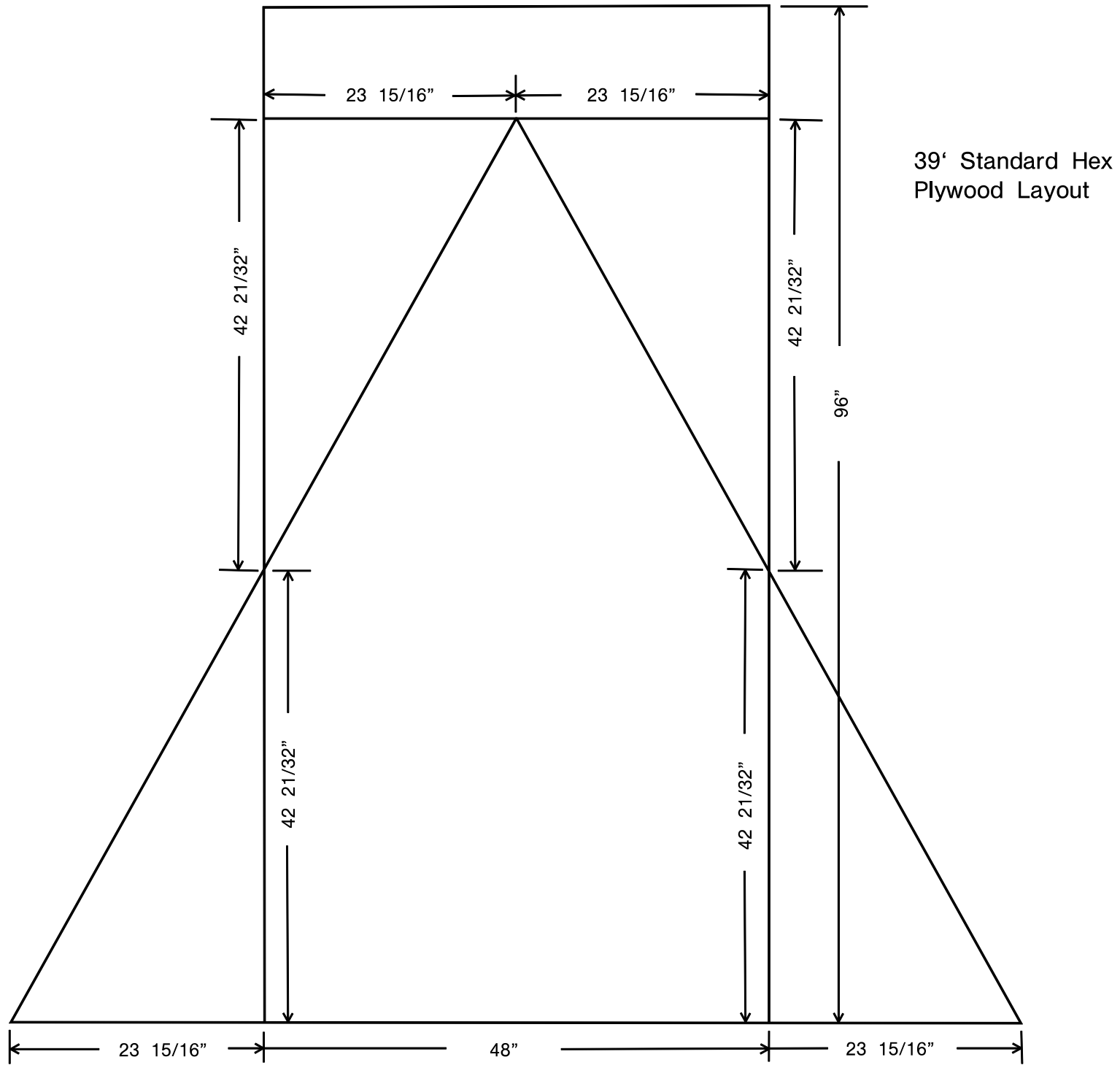

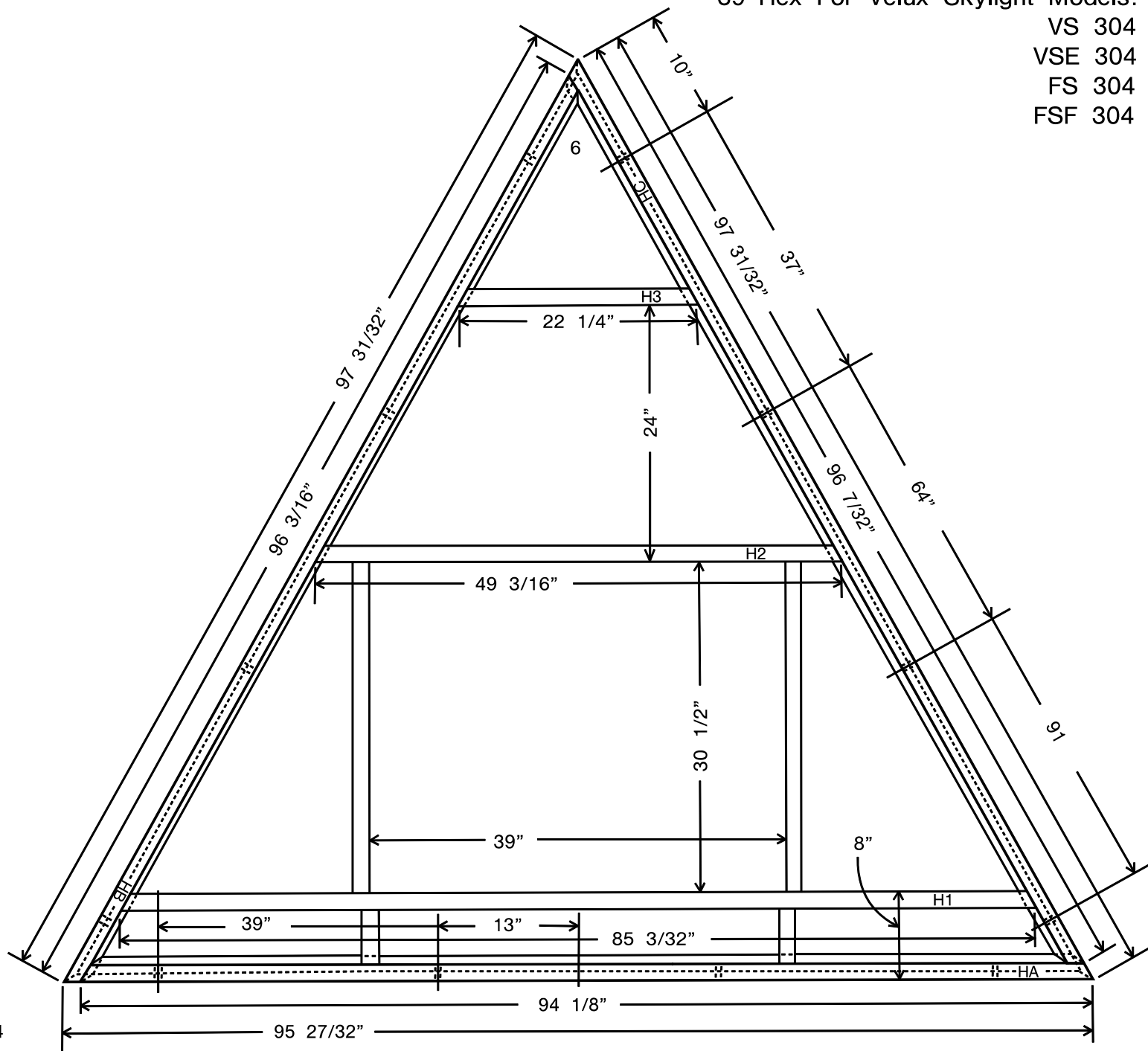

39' Hex For Velux Skylight Models:

- VS 304
- VSE 304
- FS 304
- FSF 304

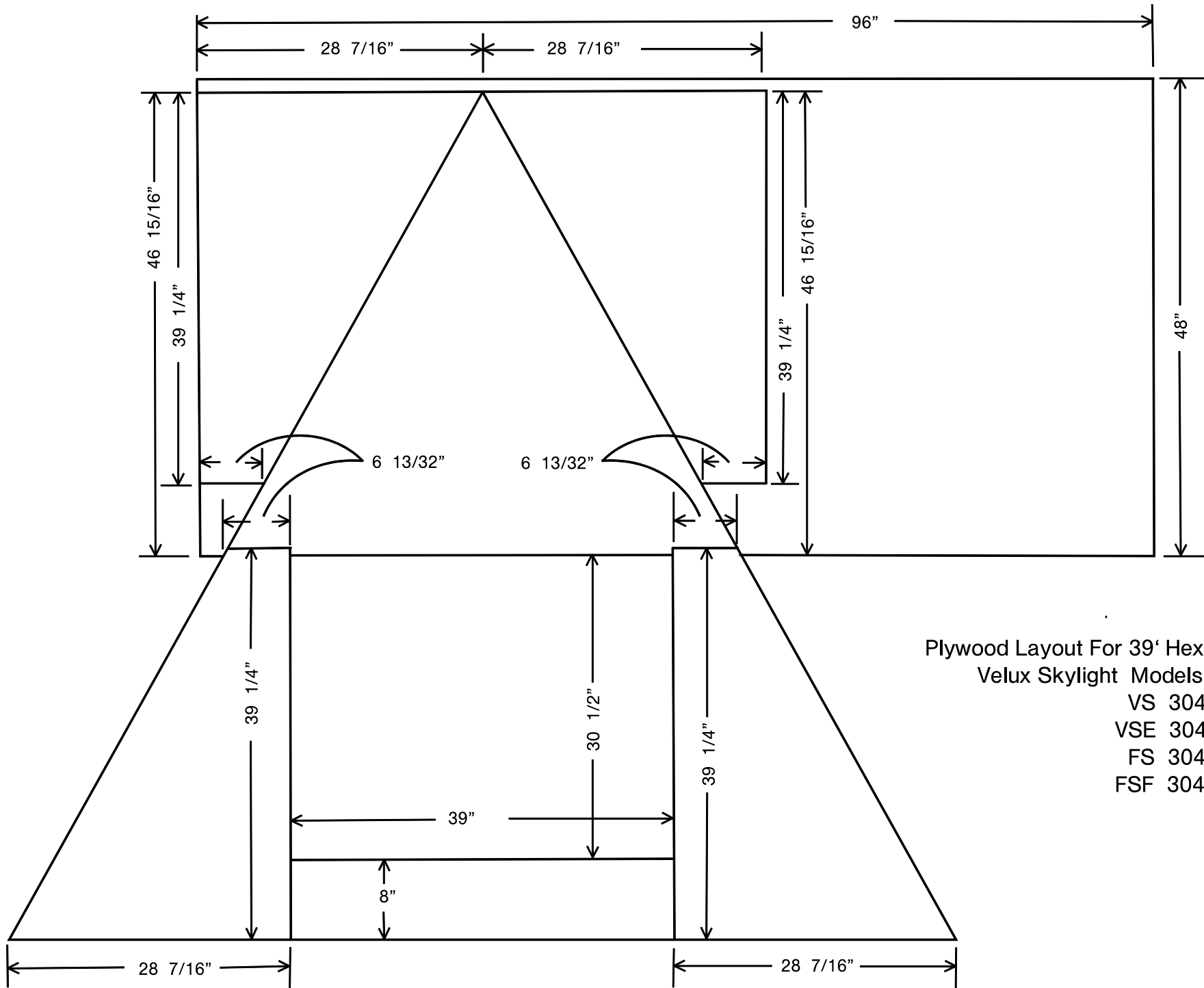

11.64 S 27.84 T		11.64 S 27.84 T	
11.90 S 30.00 T		11.90 S 27.84 T	
11.90 S 27.84 T		11.90 S 30.00 T	
7.77 S 29.06 T		7.77 S 29.06 T	
(1) 85 3/32" (2) 49 3/16" (3) 22 1/4"			



Plywood Layout For 39' Hex  
 Velux Skylight Models:  
 VS 304  
 VSE 304  
 FS 304  
 FSF 304

## License Agreements

Please read the license agreements carefully.  
There are two versions.

- (1) A **Personal License** which allows you to build an unlimited number of domes for personal use for \$54.95 U.S.  
and  
(2) A **Commercial License** which allows the same personal use but also allows you to build domes commercially for \$184.95 U.S. plus a very modest royalty.

### License Agreement (Personal)

#### Introduction.

This is a License Agreement (the "Agreement"), effective as of this date (the "Effective Date"), between Precision Structures LLC (the "Licensor") of 2565 Potter Street, Eugene, Oregon 97405, and you (the "Licensee"). Licensor and Licensee shall be collectively referred to as "the parties."

Licensor is the owner of certain proprietary rights to the written work *Professional Dome Plans, Third Edition* ("the Work.") Licensee desires to license certain rights in the Work therefore the parties agree as follows:

#### The Work.

The Work refers to all proprietary rights, including but not limited to copyrights.

#### Grant of Rights - Personal License:

Licensor grants to Licensee a nonexclusive, nontransferable, non-commercial license to use the Work in building an unlimited number of domes for Licensee's personal use.

#### Personal and Non-commercial Use Limitation.

The Work is for Licensee's personal and non-commercial use. Licensee may not modify, copy, distribute, transmit, display, reproduce, publish, license, create derivative works from, transfer or sell the Work or any portion of it.

#### Reservation of Rights.

Licensor expressly reserves all rights other than those being conveyed or granted in this Agreement.

#### Term.

This Agreement shall commence upon the Effective Date and shall expire simultaneously with the expiration of the copyright of the Work unless sooner terminated pursuant to a provision of this Agreement.

#### License Fee.

As a nonrefundable, nonrecoupable fee for executing this license, Licensee agrees to pay to Licensor upon execution of this Agreement the sum of \$54.95 U.S.

#### Limitation of Licensor Liability.

Licensor's maximum liability to Licensee under this agreement, regardless on what basis liability is asserted, shall in no event exceed the total amount paid to Licensor under this Agreement. Licensor shall not be liable to Licensee for any incidental, consequential, punitive or special damages.

#### Compliance with Intellectual Property Laws.

The license granted in this Agreement is conditioned on Licensee's compliance with the provisions of all applicable laws and regulations, including but not limited to intellectual property laws of the United States and any foreign country. All copies of the Work as well as all promotional material shall bear appropriate proprietary notices.

#### Licensor's Right to Terminate.

Licensor shall have the right to terminate this Agreement for the following reasons:

- (a) Licensee assigns or sublicenses the Work in violation of the Agreement;
- or
- (b) Licensee breaches any other term of the Agreement.

#### Effect of Termination.

After termination of this license, all rights granted to the Licensee under this Agreement shall terminate and

revert to Licensor, and Licensee will refrain from further use of the Work.

#### Attorneys' Fees and Expenses.

The prevailing party shall have the right to collect from the other party its reasonable costs and necessary disbursements and attorneys' fees incurred in enforcing this Agreement.

#### Dispute Resolution - Alternative Dispute Resolution.

If a dispute arises and cannot be resolved by the parties, either party may make a written demand for formal resolution of the dispute. The written request will specify the scope of the dispute. Within 30 days after such written notice, the parties agree to meet, for one day, with an impartial mediator and consider dispute resolution alternatives other than litigation. If an alternative method of dispute resolution is not agreed upon within 30 days of the one-day mediation, either side may start litigation proceedings.

#### Governing Law.

This Agreement shall be governed in accordance with the laws of the State of Oregon and of the United States of America.

#### Jurisdiction.

The parties consent to the exclusive jurisdiction and venue of the federal and state courts located in Lane County, Oregon, United States of America in any action arising out of or relating to this Agreement. The parties waive any other venue to which either party might be entitled by domicile or otherwise.

#### Waiver.

The failure to exercise any right provided in this Agreement shall not be a waiver of prior or subsequent rights.

#### Invalidity.

If any provision of this Agreement is invalid under applicable statute or rule of law, it is to be considered omitted and the remaining provisions of this Agreement shall in no way be affected.

**Entire Understanding.**

This Agreement expresses the complete understanding of the parties and supersedes all prior representations, agreements and understandings, whether written or oral. This Agreement may not be altered except by a written document signed by both parties.

**Notices.** Any notice or communication required or permitted to be given under this Agreement shall be sufficiently given when received by certified mail, or sent by facsimile transmission or overnight courier.

**No Joint Venture.**

Nothing contained in this Agreement shall be construed to place the parties in the relationship of agent, employee, franchisee, officer, partners or joint ventures. Neither party may create nor assume any obligation on behalf of the other.

**Assignability.**

Licensee may not assign or transfer its rights or obligations pursuant to this Agreement. Any assignment or transfer in violation of this section shall be void.

**Execution.**

Each party executing this agreement personally or on behalf of a corporation warrants that the party is authorized to enter this Agreement and that this Agreement is binding on the party.

**License Agreement (Commercial)****Introduction.**

This is a License Agreement (the "Agreement"), effective as of this date (the "Effective Date"), between Precision Structures LLC (the "Licensor") of 2565 Potter Street, Eugene, Oregon 97405, and you (the "Licensee"). Licensor and Licensee shall be collectively referred to as "the parties."

Licensor is the owner of certain proprietary rights to the written work *Professional Dome Plans, Third Edition* ("the Work.") Licensee desires to license certain rights in the Work therefore the parties agree as follows:

**The Work.**

The Work refers to all proprietary rights, including but not limited to copyrights.

**Grant of Rights - Commercial License:**

Licensor grants to commercial Licensee a nonexclusive, nontransferable, non-commercial license to use the Work in building an unlimited number of domes for Licensee's personal use. In addition, Licensor grants to Licensee a nonexclusive, nontransferable, commercial license to use the Work in building an unlimited number of domes for Licensee's customers provided Licensee pays the Royalties as set out below.

**Use Limitation.**

Licensee may not modify, copy, distribute, transmit, display, reproduce, publish, license, create derivative works from, transfer or sell the Work or any portion of it. However, Licensee may make a working copy of pages to be used in a shop setting as cutting lists provided that said copies are used for no other purpose and are destroyed after use.

**Reservation of Rights.**

Licensor expressly reserves all rights other than those being conveyed or granted in this Agreement.

**Term.**

This Agreement shall commence upon the Effective Date and shall expire simultaneously with the expiration of the copyright of the Work unless sooner terminated pursuant to a provision of this Agreement.

**License Fee.**

As a nonrefundable, nonrecoupable fee for executing this license, Licensee agrees to pay to Licensor upon execution of this Agreement the sum of either:

- (a) \$184.95 U.S. if purchased as an original Commercial License,
  - or
  - (b) \$130.00 U.S. if purchased as an upgrade from an existing Personal License,
- and thereafter to pay promptly other sums payable under the terms of this Agreement.

**Royalties.**

All royalties ("Royalties") provided for under this Agreement shall accrue when the respective domes are contracted, built, sold, billed or paid for, whichever occurs first.

**Licensed Work Royalty.**

Commercial Licensee agrees to pay a Royalty of ten cents U.S. (\$.10) per square foot on the area of a circle in square feet scribed by the radius of the dome at ground level on each dome built for a customer. The formula used will be:  $\text{Pi } (\pi) \text{ times the radius squared where } \pi \text{ equals } 3.14.$

For example:

(1) The royalty due on a 40-foot dome with a radius of 20 feet would be  $20'^2 = 400' \times 3.14 = 1256 \text{ sq. ft. and } 1256 \text{ sq. ft.} \times \$ .10 \text{ per sq. ft.} = \$125.60.$

(2) The royalty due on a 12-foot dome with a radius of 6 feet would be  $6'^2 = 36' \times 3.14 = 113 \text{ sq. ft. and } 113 \text{ sq. ft.} \times \$ .10 \text{ per sq. ft.} = \$11.30.$

**Payments to Licensor.**

Within thirty days after the Royalty accrues, Licensee shall pay to Licensor at the address set out above or at the web site [domeplans.com](http://domeplans.com) the Royalty described in the preceding paragraph. All payments shall be paid in United States currency drawn on a United States bank. The acceptance by Licensor of any of royalties paid shall not preclude Licensor questioning the correctness at any time of any payments.

**Audit.**

Licensee shall keep accurate books of account and records covering all transactions relating to the license granted in this Agreement, and Licensor or its duly authorized representatives shall have the right upon five days prior written notice, and during normal business hours, to inspect and audit Licensee's records relating to the Work licensed under this Agreement. If the results indicate an underpayment, Licensee shall promptly reimburse Licensor for all costs of the audit along with the

amount due with interest on such sums. Interest shall accrue from the date the payment was originally due, and the interest rate shall be 1.5% per month, or the maximum rate permitted by law, whichever is less. All books of account and records shall be made available and kept available for at least two years after Royalties accrue under this Agreement.

**Late Payment.**

Time is of the essence with respect to all payments to be made by Licensee under this Agreement. If Licensee is late in any payment provided for in this Agreement, Licensee shall pay interest on the payment from the date due until paid at a rate of 1.5% per month, or the maximum rate permitted by law, whichever is less.

**Limitation of Licensor Liability.**

Licensor's maximum liability to Licensee under this agreement, regardless on what basis liability is asserted, shall in no event exceed the total amount paid to Licensor under this Agreement. Licensor shall not be liable to Licensee for any incidental, consequential, punitive or special damages.

**Compliance with Intellectual Property Laws.**

The license granted in this Agreement is conditioned on Licensee's compliance with the provisions of all applicable laws and regulations, including but not limited to intellectual property laws of the United States and any foreign country. All copies of the Work as well as all promotional material shall bear appropriate proprietary notices.

**Licensor's Right to Terminate.**

Licensor shall have the right to terminate this Agreement for the following reasons:

(a) Licensee fails to pay Royalties when due and such failure is not cured within thirty days after written notice from the Licensor;

(b) Licensee assigns or sublicenses the Work in violation of the Agreement; or

(c) Licensee breaches any other term of the Agreement.

**Effect of Termination.**

After termination of this license, all rights granted to the Licensee under this Agreement shall terminate and revert to Licensor, and Licensee will refrain from further use of the Work.

**Attorneys' Fees and Expenses.**

The prevailing party shall have the right to collect from the other party its reasonable costs and necessary disbursements and attorneys' fees incurred in enforcing this Agreement.

**Dispute Resolution - Alternative Dispute Resolution.**

If a dispute arises and cannot be resolved by the parties, either party may make a written demand for formal resolution of the dispute. The written request will specify the scope of the dispute. Within 30 days after such written notice, the parties agree to meet, for one day, with an impartial mediator and consider dispute resolution alternatives other than litigation. If an alternative method of dispute resolution is not agreed upon within 30 days of the one-day mediation, either side may start litigation proceedings.

**Governing Law.**

This Agreement shall be governed in accordance with the laws of the State of Oregon and of the United States of America.

**Jurisdiction.**

The parties consent to the exclusive jurisdiction and venue of the federal and state courts located in Lane County, Oregon, United States of America in any action arising out of or relating to this Agreement. The parties waive any other venue to which either party might be entitled by domicile or otherwise.

**Waiver.**

The failure to exercise any right provided in this Agreement shall not be a waiver of prior or subsequent rights.

**Invalidity.**

If any provision of this Agreement is invalid under applicable statute or rule of law, it is to be considered omitted and the remaining provisions of this Agreement shall in no way be affected.

**Entire Understanding.**

This Agreement expresses the complete understanding of the parties and supersedes all prior representations, agreements and understandings, whether written or oral. This Agreement may not be altered except by a written document signed by both parties.

**Notices.**

Any notice or communication required or permitted to be given under this Agreement shall be sufficiently given when received by certified mail, or sent by facsimile transmission or overnight courier.

**No Joint Venture.**

Nothing contained in this Agreement shall be construed to place the parties in the relationship of agent, employee, franchisee, officer, partners or joint ventures. Neither party may create nor assume any obligation on behalf of the other.

**Assignability.**

Licensee may not assign or transfer its rights or obligations pursuant to this Agreement without the prior written consent of Licensor. Any assignment or transfer in violation of this section shall be void.

**Execution.**

Each party executing this agreement personally or on behalf of a corporation warrants that the party is authorized to enter this Agreement personally or on behalf of such corporation and that this Agreement is binding on the party.





"Professional Dome Plans is a book for builders, not dreamers. If you're planning to construct your own dome, the detailed shop drawings and terse suggestions will be well worth the asking price.\* As Hill dryly remarks, when describing his penchant for rounding dimensions to the nearest thirty-second of an inch, 'This level of accuracy may seem extreme, but it's my experience that people are capable of making all the necessary mistakes without help from sloppy dimensions'."

"Mother Earth News" January, 1990

\* The comment that it's "well worth the asking price" reflects the original 1990 price of \$34.95. Regrettably, we are unable to continue to develop and deliver the plans for that price. A personal license is now \$54.95 for unlimited personal use and a commercial license is \$184.95 plus a modest royalty.



"Anyone who has ever been intimidated by the desire to build a geodesic dome will be relieved to know that the cavalry has arrived. A recent publication from Jeffrey Hill of Precision Structures, Oregon, titled *Professional Dome Plans*, has brought the other-worldly science of building geodesic domes down to earth where it belongs — firmly within the abilities of the do-it-yourselfer.

Beginning with a few explanatory pages of terms and materials, Hill heads straight to the heart of the matter, offering precise scale drawings of 39', 45' and 50' domes and their riser walls. These three sizes account for approximately 80% of all residential dome construction. And to satisfy the builder who has a desire for a dome size other than the three drawn within the book, or who wishes to use nonstandard size lumber (the dome plans in the book all use 1 1/2" thick lumber), Hill has been considerate enough to supply tables that list precalculated parts for 49 sizes of dome, from 12' to 60' in diameter, and 12 simple formulas for calculating most parts for any size dome.

The simplicity of the book suggests careful thought from Hill. The drawings are clear and easy to understand, showing the assembled panels and their plywood skins, and separate cutting lists for the individual parts, as well. These drawings illustrate all the boards and their angles as they would appear lying flat on a radial arm saw table, lending a perspective that makes cutting the compound angles nearly foolproof.

What it all adds up to in the end, is a book that cuts through the complex geodesic math, reducing it to the unimportant obstacle that it is, clearing the way for the important task of building a dome."

"Canadian Workshop" March, 1989

\* "Canadian Workshop" changed its name to "Canadian Home Workshop" in May of 1998. It's still the same great magazine, just with a new name.



"Designed to give a simple understanding of a complex building procedure, Professional Dome Plans is a collection of drawings and diagrams that aims to make dome building self-explanatory. The book is written for those who understand woodworking, but a solid grasp of geometry will also be helpful.

Jeffrey O. Hill is a former plant manager at Oregon Dome where he helped produce commercial and residential domes. To Hill's credit, the plan book is thorough. After introducing the methodology of building a dome, three featured dome plans are shown. A foundation view, a top view and an elevation are diagrammed, each with a key to understanding the building formulas. These plans are for domes measuring 39 feet, 45 feet and 50 feet in diameter.

The book is divided into several topics: terms, which define the major components and parts; format, or how the plans are set up and in what order; and assembly, which describes raising a dome. Though the book could have been written a little more clearly, Hill calls it a 'basic book that really takes all the mysteries out of dome building.'

Following the dome plans, standard pentagon and hexagon construction shapes — the two components essential to domes — are diagrammed individually. Drawings also show how to include a skylight into the pent or hex form.

Riser wall plans (riser walls sit under a dome if more height is needed) are next, followed by a chart for constructing 49 different dome sizes. A solid understanding of geometry will help if you are building a dome a different size than shown in the book,

Professional Dome Plans -- Building geodesic domes made easy.

though Hill says the book 'makes it easy for anyone to build domes without an advanced math degree.'

To make the plans easier to read, they are diagrammed lying flat on a radial-arm-saw table. According to Hill, this makes cutting the compound angles of the plans virtually foolproof."

"Professional Builder" Mid-March, 1989

Copyright 2002, Jeffrey O. Hill

[Home](#) [Full Text](#) [Links](#) [Order Plans](#) [License](#) [Contact Us](#)



---

## Dome Related Links

[Professional Dome Plans](#) — a book of detailed shop drawings and simple formulas for building 3v icosahedron, wood framed, panelized geodesic domes. This is also, of course, a link to the [Home Page](#) of this very web site.

[The Buckminster Fuller Institute](#) — a well maintained hub for those interested in the ideas of Buckminster Fuller and geodesic domes.

[Applied Synergetics](#) — Geodesic dome design freeware called DOME that calculates spherical vertex coordinates, symmetry triangle topological abundance, and chord factors. It supports class I (alternate) and class II (triacon) breakdowns for Icosahedron, Octahedron and Tetrahedron polyhedron types.

[Desert Domes](#) — this very useful site provides a calculator for figuring strut lengths for any size 2, 3, 4, 5, or 6 frequency icosahedron dome — especially helpful if you're interested in conduit domes.

[Geodesic Domes](#) — Lots of information including an extensive list of geodesic dome manufacturers, vendors and consultants.

[The R. Buckminster Fuller FAQ](#) — This is the Frequently Asked Questions and Answers Resource on R. Buckminster Fuller. It is based primarily on the history of the discussions, interests, and needs of the readers of the BITNET mailing list Geodesic and its USENET gateway bit.listserv.geodesic.

[Dome Home Companion](#) — Lots of links and an interesting and lively discussion group.

[Mathworld](#) — A deep link in a heavy duty math site with areas covering Astronomy, Chemistry, Mathematics and Physics — tough going but interesting browsing.

[Spencer Hunter's Homepage](#) — A gopher site with an eclectic mix of interesting and useful sites.

## Homesteading and Green Living

[ecobusinesslinks.com](#) — A huge directory with thousands of reviewed green websites for a more sustainable living. Very well organized and easy to navigate.

[littlecountryvillage.com](#) — Homesteading, frugal living, cottage gardening, easy meal recipes and much more.

[Family Homesteading Advocate](#) — Simple living resources for the natural family. Homeschool, herbal health, natural foods, organic gardening, homebirth and a lot more.

[Energy Efficiency and Renewable Energy Network](#) — A U.S. Government site with extensive resources.

[Backwoods Home Magazine](#) — Practical ideas for self-reliant living. They offer informative articles on a wide range of subjects including building, alternative energy, farming, gardening, food and cooking, country living and more.

## Home Designers

[globalhouseplans.com](#) — Choose from thousands of innovative house plans. From cottages to executive homes, they offer plans designed by the Nation's leading Designers and Architects, compiled into a user friendly, on-line collection.

[Weinmaster Home Design](#) — Easy to use, house plans web site offering a wide range of home designs. Whether you are looking for starter or executive homes, you can find some very nice plans here.

[Rick Garner Designer](#) — Unique Designs for Unique People. Trusted & Proven Professional Home Designs.

[southerndesigner.com](#) — "Quality, not quantity" — The Southern Designer is a collection of house plans, garage plans and multifamily designs by leading professional U.S. and Canadian designers. Quality plans in an easy to navigate and informative

format.

### General Building Information

[doityourself.com](http://doityourself.com) — A huge site with articles on hundreds of subjects for the do-it-yourselfer. Very well organized and easy to navigate considering the wealth of information.

[infoforbuilding.com](http://infoforbuilding.com) — A site tailored to the do-it-yourself owner builder. Includes an interesting tutorial that takes you through the process of building a home from beginning to end.

[sierraplastics.com](http://sierraplastics.com) — Providers of triangular skylights that precisely mirror the geometry of 3v icosahedron geodesic dome panels.

[mazenails.com](http://mazenails.com) — A good source for 3 1/2" by .120", spiral shank, galvanized gun nails.

Copyright 2002, Jeffrey O. Hill

[Home](#) [Full Text](#) [Links](#) [Order Plans](#) [License](#) [Contact Us](#)

[Skip navigation](#)



Products	Solutions	Support	Purchase	Company
----------	-----------	---------	----------	---------

- 
- [Search](#)
- [Contact Us](#)
- 

## Products

- [All](#)
- [Acrobat family](#)
- [Document Services](#)
- [Digital imaging](#)
- [Video and audio](#)
- [Web publishing](#)
- [Print publishing](#)

## Solutions

- [Enterprise](#)
- [Government](#)
- [Adobe Studio](#)
- [Digital imaging](#)
- [Education](#)
- [Partners](#)

## Support

- [Support main](#)
- [Downloads](#)
- [Training](#)
- [Forums](#)
- [Announcements](#)

## Purchase

- [Adobe Store](#)
- [Your account](#)
- [Volume licensing](#)
- [Other ways to buy](#)
- [Customer service](#)

# Company

- [About Adobe](#)
- [Press](#)
- [Jobs](#)
- [Investors](#)
- [Adobe Ventures](#)
- [Community](#)
- [Contact Adobe](#)

## Adobe Reader

Download Adobe Reader

Thank you for your interest in [Adobe® Reader®](#) — free software for viewing and printing [Adobe Portable Document Format](#) (PDF) files. Created from applications like [Adobe Acrobat® 6.0](#), Adobe Photoshop® Album [photo software](#), and more, Adobe PDF files can be viewed on most major operating systems. Adobe Reader 6.0 is the newest version of the familiar Adobe Acrobat Reader software. It also replaces [Adobe Acrobat eBook Reader](#), software for viewing high-fidelity eBooks on your notebook or desktop computer.

**IMPORTANT:** Review the [system requirements](#) before downloading and installing Adobe Reader 6.0.

To distribute Adobe Reader software or place an "Includes Adobe Reader" logo on your printed material, [see details](#).

### Step 1 of 2

**Choose your language and platform. Your selection will determine the version of software that you will download.**

Language

Platform

### Step 2 of 2

**The platform and language combination specified will determine the version of Adobe Reader that you will receive.**

**Full version:** You will receive the full-featured version of Adobe Reader software. Recommended for broadband users.

**Basic version:** You will receive a compact version of Adobe Reader software without all available options. This version will transfer more quickly over dial-up connections.

By downloading software from the Adobe Web site, you agree to the terms of our license agreements. Please read the following license agreements before downloading:

[Adobe Reader license agreement.](#)

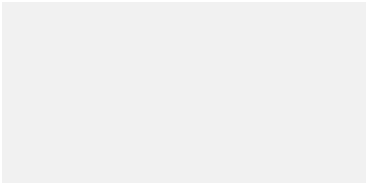

An accessible, [text-only Adobe Reader download page](#) is available if you are using a screen reader. [An Adobe Reader archive page](#) enables you to find and download an earlier version of Adobe Reader.

Copyright © 2004 Adobe Systems Incorporated. All rights reserved.

- [Terms of Use](#)
- [Privacy Policy](#)
- [Accessibility](#)
- [Avoid software piracy](#)
- [Permissions and trademarks](#)
- [Product License Agreements](#)



# THE BUCKMINSTERFULLERINSTITUTE

WORKING TO ADVANCE HUMANITY'S OPTION FOR SUCCESS



- HOME
- ABOUT BFI
- STORE
- SUPPORT BFI
- BOOKS & RESOURCES
- LINKS

- HUMANITY'S OPTION
- WHO IS R.B. FULLER?
- DOMES
- SYNERGETICS
- DESIGN SCIENCE

### BECOME A MEMBER



**Support BFI and become a member!**

There has never been a better time to become a member of the institute. In celebration of the stamp release we are offering a series of special collectible membership premiums. [Click here](#) to find out more!

**STORE**

### WELCOME TO THE NEW BFI WEBSITE

We are in the midst of a major overhaul of BFI's online presence! As you click through the site you may notice some pages from our old site mixed in with new material and a new look. All of our extensive resources on Buckminster Fuller and his work are still online, and will be soon joined by our new community and publishing platform, and a new online store!

### NEWS & EVENTS

[Empty content area for news and events]



**New store items!** [Click here](#) for information on how to order by mail or phone.



[Our Spaceship Earth Satellite Map](#), \$15.

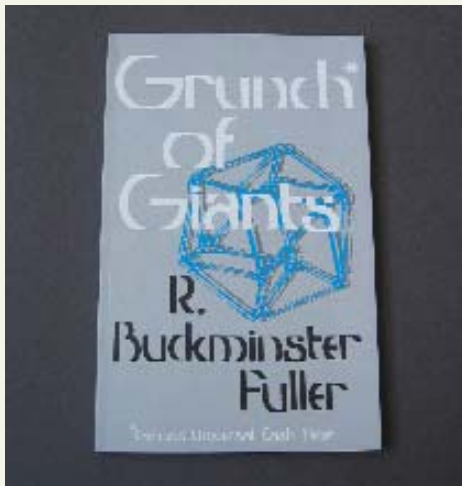

[Grunch\\* of Giants](#) (\*Gross Universal Cash Heist), \$15.

## Celebrate the Bucky Stamp!

On July 12, 2004, Fuller's 109th birthday, the U.S. Postal Service is releasing a commemorative Buckminster Fuller Stamp! 2004 was chosen as the year to release the stamp as it marks the 50th anniversary of Fuller's patent for the Geodesic Dome.

The image by Boris Artzybasheff originally appeared on the [cover of TIME Magazine](#) on January 10th, 1964 (and you can read an excerpt from the original article, "[The Dymaxion American](#)").

Special thanks go out to BFI Board Member Thomas Zung, who spearheaded this effort! For more on this historic event, read Zung's article, "[Story of the Stamp](#)," from our newsletter Trintab.

---

**New! Further Reading:** BFI Board member Greg Watson's stamp release op-ed piece, [Heed The Peaceful Revolutionary's Call](#).



The **First Day Issue Ceremony** at Stanford University on Monday July 12 was a great success! Thanks to all who joined us!

Bucky fans celebrated the release of the postage stamp all across the country...

In **Palo Alto, CA** at Stanford University, home of the Fuller Archives:



Former astronaut Dr. Buzz Aldrin, left, and Allegra Fuller Snyder have a chat after the unveiling of a new postage stamp at Stanford, July 12th.



[Set of 3 posters with quotes by Buckminster Fuller](#), \$15.

#### MAILING LIST

**Subscribe to our monthly e-bulletin**

[Read the e-bulletin archives](#)

#### FEATURED PROGRAM

In **Carbondale, IL** at Fuller's former [Dome Home](#);  
In **Rockland Maine** at [The Farnsworth Art Museum](#);  
In **San Diego, CA** in [Horton Square](#);  
In **St. Louis, MO** at the [Missouri Botanical Gardens](#);  
and in **New York City** at the Center for Architecture:



Longtime Fuller colleague Herman Wolf joined us in NYC from Bridgeport, CT.



From left, the NYC ceremony speakers: Raschelle Miley, USPS; Jonathan Marvel, Rogers&Marvel Architects, Fuller's great-nephew; Joshua Arnow, BFI Board president; Elizabeth Thompson, BFI Acting Executive Director.

#### Press coverage of the stamp release

Check out stories on the stamp from [Wired News](#), [Metafilter](#), [Gothamist](#), and [many others!](#)

#### President's Message

Read [BFI Board President Joshua Arnow's thoughts](#) on the stamp, our move and BFI's exciting future.

---

## The Buckminster Fuller Institute Opens in Brooklyn!

*reprinted from BFI newsletter Trimtab, Vol.17 no.2*



[Interactive geo-stories](#) about the state of the Earth, our communities, and possible futures.

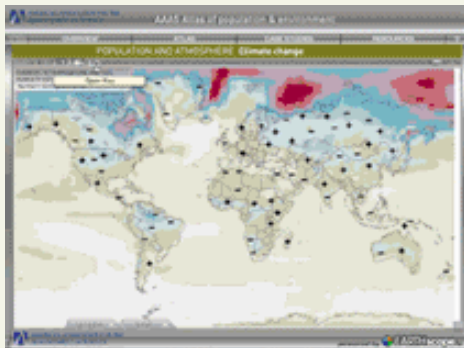

## TRIMTAB

### Read recent issues of our newsletter

[The Spring 2004 issue](#) is now online, in PDF format. You will need the [Adobe Reader](#) installed to read it.

Read [the archives of Trimtab](#).

[Become a member](#) and receive *Trimtab* by mail or e-mail!

We Are Here!



**Our new address is:**  
Buckminster Fuller Institute  
181 N. 11th Street  
Suite 402  
Brooklyn, NY 11211  
718-290-9280  
Fax: 718-290-9281  
Toll-Free: 800-967-6277

BFI's core operations moved to beautiful new premises this April, capping off an intensive 24-month long strategic planning process initiated at the January 2002 Board meeting. Approved at the Board meeting in January of 2004, our move to New York enables BFI to evolve into a more mission-critical "Interactive Network of Innovational Comprehensive Designers." BFI simply had to capture the value of situating itself in a strategic location and hiring executive level staff. Sebastopol served us incredibly well as a temporary and convenient re-tooling site while we began the very hard work of reorienting our focus once the Fuller Archive moved to Stanford.

BFI's rooftop dome-raising Open House in May, 2004. Across the street is a Williamsburg landmark, the Russian Orthodox Church's "Green Onion dome!"



[Read more](#) about our new office in the rest of this article from our newsletter Trimtab.

---

## Planetnetwork Journal Launches

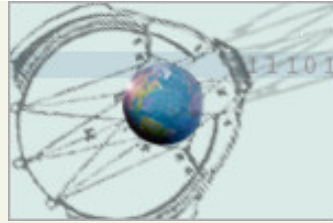

<http://journal.planetwork.net/>

A Fuller-aligned quarterly online publication for in-depth articles by those engaged in applying new technology to benefit the public interest. The inaugural issue features articles by BFI colleagues: Bonnie DeVarco, "Earth as A Lens: Global Collaboration, GeoCommunication, and The Birth of EcoSentience." and Hardin Tibbs, "Interactivity and The Open Society."

---

## BFI Board member Carl Frankel's new book: *Out of the Labyrinth*

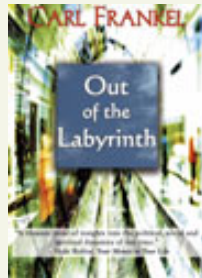

<http://www.outofthelabyrinth.com/>

*Out of the Labyrinth* combines a visionary framework, a personal narrative, and cultural criticism into a story about where we have gone wrong as a culture and what we must do -- and become -- to set things right.

"Blends story and philosophy into a dazzling concoction that offers powerful guidance to us all." -- Thom Hartmann, author, *The Last Hours of Ancient Sunlight*

---

## Nano Exhibit at LACMA



The [Nano exhibit](#) at the [Los Angeles County Museum of Art's](#) Boone Children's Gallery is loaded with Bucky inspiration. It runs until September 6, 2004.

The Nano exhibit was featured last week on [The News Hour with Jim Lehrer!](#)

---

## Smithsonian Course Postponed

Buckminster Fuller's [Comprehensive Anticipatory Design Science](#) course at the Smithsonian in Washington, D.C. has been postponed until September; stay tuned for updates!

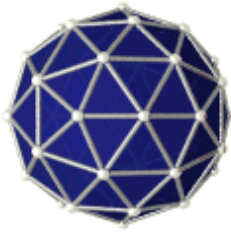

# Applied Synergetics

## [Geodesic Domes](#)

[Download WinDome 4.80](#)

[WinDome Readme](#)

[Download DOME for Linux](#)

[DOME for Linux Readme](#)

[Download Console DOME](#)

[Console DOME Readme](#)

[Povray Dome Gallery](#)

[VRML Dome Gallery](#)

[Geodesic Dome Resources](#)

[Design Science University](#)

[Add to Guestbook](#)

[View Guestbook](#)

[Discussion Forum](#)

[News](#)

[FAQ](#)

[Design Science Workshop](#)

## Geodesic Dome Design Software

DOME is an open source utility for generating the coordinates of a geodesic dome or sphere. Versions are available for 32-bit Windows platforms, Linux/Unix and MacOS. Full source code is available per the GNU General Public License.

DOME 4.80 Features:

- Command-line Input.
- Generates data files in the following output formats:
  - *Drawing Exchange Format (DXF)* for import into CAD packages
  - *Persistence of Vision Raytracer (POV)* format for creating photo-realistic images.
  - *Virtual Reality Mark-up Language (WRL)* files for interactive Web viewing. Now Conforms to VRML97 Specifications.
  - *ASCII Report (DAT)* format including chord, axial and face angle data.
  - *ASCII Import Format (PRN)* for use with spreadsheets, etc.
- Supports Tetrahedron, Octahedron & Icosahedron Polyhedron types
- Generates Symmetry Triangles and Full Spheres for Class I & II Structures
- "Buckyball" Structuring (now includes all three polyhedron types).
- Elliptical Geodesics
- Geodesic Parabolic Dome Design.
- Defines and a makefile for Non-Borland C compilation (i.e. Unix, Linux, etc.).
- Functions for calculating Point, Edge & Face Coordinates
- A DXFtoPOV console utility.
- WinDome provides a GUI front-end to the application.

If you like DOME & WinDome and wish to help in it's development, please consider a donation via PayPal. For more info on donations please click [here](#).

DOME will output a "camera-ready" POV-Ray script file. [POV-Ray](#) is also freeware, so if you have the requisite hardware, then pictures such as the ones on the gallery page are just a heartbeat away on your own computer.

Download WinDome for Windows: [windome48.zip](#) 268K zip

Download Console Version: [dome48.zip](#) 175K zip

Download Unix/Linux Version: [dome\\_4\\_80.tgz](#) 55K tarball

Download MacOS Version: [dome46.sit.bin](#) 165K bin

NOTE: The Mac compilation of DOME was generously provided by Marc St-Jean. Marc has tested the compile under 68k emulation mode on a PowerPC. I do not have access to a Mac, so I am unable to personally verify the operation of the Mac version. For this same reason, I am unable to provide support for the Mac version or compile a package for Version 4.80. I hope to support MacOS users in the future by providing a Java port.

DOME & WinDome is freeware according to the terms of the standard [GNU license](#)

[agreement.](#)

---

*Planned Development...*

Planned features include:

- INI Files for customized input of parameters and POV-ray data
- Non-Spherical structure design
- Buckyball Faces
- Buckyball Topology Calculations
- Space frame support
- Dihedral angle calculations
- "Flat" Network layouts of geodesic designs.
- Java Cross Platform Port

It is never to late to contribute your ideas. Drop me an e-mail with your suggestions and I will do my best to incorporate them in the next release. You can also leave comments in my [guestbook.](#)

---

Contact [Rick Bono](#) at: [rjbono@applied-synergetics.com](mailto:rjbono@applied-synergetics.com)



Copyright (c) 2002 - Applied Synergetics. All Rights Reserved



# Desert Domes

Making the world a "Fuller" place

HOME

DOME CALCULATOR

DOME FORMULAS

BAMBOO DOMES

CONDUIT DOME TIPS

FAQ

DOMES FOR SALE

PHOTO GALLERIES

LINKS

ABOUT ME

BIBLIOGRAPHY

HOME



Welcome to Desert Domes!

I'm Gerlach, Nevada living in a trailer park while we build the dome structure that will be the base of the man this year for Burning Man. If you send an e-mail, and I don't reply, it's because I'm in the desert... If you are going to Burning Man this year, drop by for a visit at 5:30 and Esplanade (look for the red dome)

If you have been here before, I hope you like the new look. I have added a bibliography and a page about me, along with a few other odds and ends. In the future, look for an elliptical dome calculator, and more in depth information on geodesic geometry.

After many years of hard work and no sleep, I finally graduated from college with a bachelor's degree in mechanical engineering. I'm in the real

world now, and I'm not sure I like it. I'm back in the Bay Area, and I'm looking for a job, so if you know any companies looking for someone like me, please e-mail me.

I first became interested in geodesic domes while participating in my first Burning Man, and this site is a result of that interest. Nearly everything I know about domes can be found in a few books which I have listed in the bibliography section of this site. The rest comes from experience.

After 4 years, I am finally returning home. If you are planning on going to Burning Man, and you want to stop by to say hi, just come by our camp, [The Catadomes and Kiddie Korral](#) at 5:30 and Esplanade. If you built a dome using this site, I'd like to come over to visit you! Please e-mail your addresses, and I'll make yours a stop on the dome tour!!!



Reset on February 23, 2004

© 2002 Desert Domes | | Oakland, California



# GEODESIC DOMES

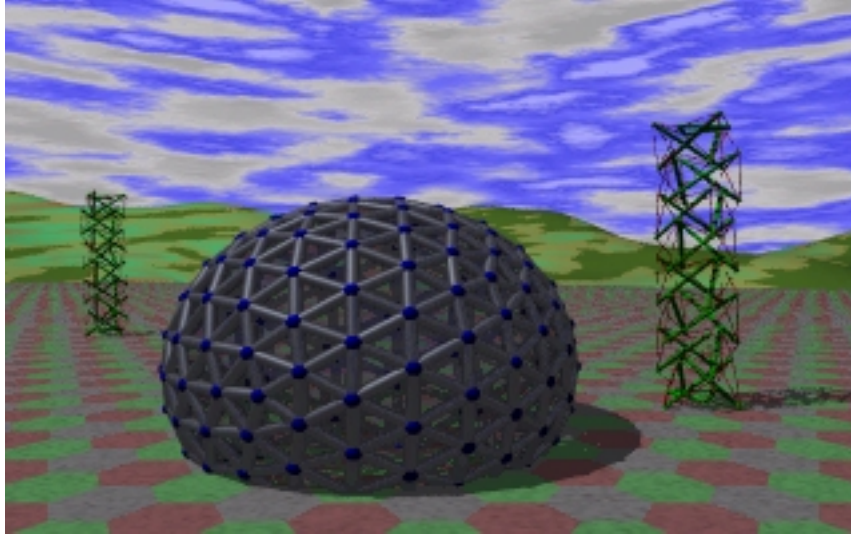

[History](#) | [Geometry](#) | [Providers](#) | [Prototypes](#) | [Resources](#)

*Synergetics on the Web*  
maintained by [Kirby Urner](#)

# The R. Buckminster Fuller FAQ

Christopher J. Fearnley, [cjf@CJFearnley.com](mailto:cjf@CJFearnley.com)

v.1.4.0, 6 November 2002

---

*This is the **Frequently Asked Questions and Answers (FAQ) Resource on R. Buckminster Fuller**. It is based primarily on the history of the discussions, interests, and needs of the readers of the BITNET mailing list Geodesic and its USENET gateway `bit.listserv.geodesic` (I will use the word "GEODESIC" or sometimes simply "the list" to refer to these two gatewayed discussion areas). Some of the information could be in error (especially addresses and phone numbers). Please send all errors and suggestions to the FAQ maintainer, Chris Fearnley ([cjf@CJFearnley.com](mailto:cjf@CJFearnley.com)).*

---

## 1. [Introduction](#)

## 2. [Synergetics](#)

- 2.1 [What is a tetrahedron \(tetra\), octahedron \(octa\), and an icosahedron \(icosa\)?](#)
- 2.2 [What is "synergy?"](#)
- 2.3 [What is Fuller's definition of "Universe?"](#)
- 2.4 [What is the "Isotropic Vector Matrix" \(IVM\)?](#)
- 2.5 [What is an octet truss?](#)
- 2.6 [What is the "vector equilibrium" \(VE\)?](#)
- 2.7 [What is the "jitterbug"?](#)
- 2.8 [What is a sphere?](#)
- 2.9 [What is Fuller's concept of "space?"](#)
- 2.10 [What is a "system?"](#)
- 2.11 [What is the "minimal system?"](#)
- 2.12 [What are the A and B quanta modules?](#)
- 2.13 [What is the "omnidirectional halo?"](#)
- 2.14 [What does Fuller mean by 4D?](#)
- 2.15 [Does synergetics provide an extension or modification of the "scientific method?"](#)

- 2.16 [Are there connections between synergetics and fullerenes \(besides the name, of course\)?](#)
- 2.17 [Why use synergetics' conversion factors and other irrationals?](#)
- 2.18 [What is ``precession?''](#)
- 2.19 [What is the equation for finding the volume of a pyramid? \[ Steve Mather \]](#)
- 2.20 [How to communicate synergetically?](#)
- 2.21 [Modeling suggestions?](#)
- 2.22 [What applications of synergetics are being discovered?](#)
- 2.23 [Is it possible to develop an operational pi?](#)
- 2.24 [What are Koski's and Kajikawa's modules?](#)
- 2.25 [What is Richard Hawkins' curVE model?](#)
- 2.26 [Fuller's \*Synergetics\* and Sex Identity.](#)
- 2.27 [Tips for reading \*Synergetics\*.](#)

### **3. Fuller's Ideas About Human Society: Critical Path**

- 3.1 [What is the Design Science Revolution?](#)
- 3.2 [What is the ``cosmic accounting system?'' --- Fuller's Economics.](#)
- 3.3 [What is the World Game?](#)
- 3.4 [What were Fuller's views on religion and God?](#)
- 3.5 [What is the Global Energy Grid idea?](#)
- 3.6 [What is a ``trimtab?''](#)
- 3.7 [Was Bucky a socialist?](#)
- 3.8 [What were Fuller's views on Education?](#)
- 3.9 [What is the difference between ``Class I'' and ``Class II'' evolution?](#)
- 3.10 [How to house humanity? And other reflections on Making the World work.](#)
- 3.11 [Was Bucky an ``optimist'' or a ``pessimist''?](#)
- 3.12 [What about Fuller's plan for a nationless world?](#)

### **4. Geodesic Domes**

- 4.1 [What is a geodesic dome?](#)
- 4.2 [Dome Math: What you've all been waiting for!!!](#)

- [4.3 How to build a geodesic dome?](#)
- [4.4 Did Fuller invent the Dome?](#)
- [4.5 Dome References](#)

## **5. Other Inventions**

- [5.1 What is a tensegrity model?](#)
- [5.2 What are ``cloud nines?''](#)
- [5.3 What is ``dymaxion?''](#)
- [5.4 What was the ``Dymaxion Car?''](#)
- [5.5 What is a ``fog gun?''](#)
- [5.6 What was Fuller's ``floating city?''](#)
- [5.7 What was the Old Man's River City Project \(circular cities\)?](#)
- [5.8 What was the Dymaxion Deployment Unit?](#)
- [5.9 What is the Dymaxion Map?](#)
- [5.10 What was the Dymaxion House?](#)

## **6. Miscellany**

- [6.1 What are ``fullerenes" and ``buckyballs?''](#)
- [6.2 What is Biosphere II?](#)
- [6.3 What were Fuller's early years like?](#)
- [6.4 Was Fuller formally educated?](#)
- [6.5 Bibliography: Culled from many postings](#)
- [6.6 Organizations and Corporations mentioned on GEODESIC \(incomplete and dated\)](#)
- [6.7 Computer tools \(may or may not be useful to dome design or synergetics' modeling\).](#)
- [6.8 Fuller's ``failures."](#)
- [6.9 Where would you encourage your best friend to start in the Fuller literature? \(For maximum ease of mastery\) \[Jeff Perth\]](#)
- [6.10 Quotes and Coinages.](#)
- [6.11 Bucky: humanitarian or cold-hearted technocrat --- The value of a man?](#)
- [6.12 What was the nature of Fuller's involvement with Werner Erhardt, EST and the World Hunger Project? \[Lance Fletcher\]](#)
- [6.13 What were relations like between Fuller and his Students?](#)

- 6.14 [What is GENESIS II?](#)
- 6.15 [Could Fuller's proposed Very Large Structures work?](#)
- 6.16 [Why did Fuller apply for patents?](#)
- 6.17 [Is there a Bucky CD-ROM available?](#)
- 6.18 [Why is overspecialization dangerous?](#)
- 6.19 [Letters from Bucky to Mark A. Burginger.](#)

## **7. Net Resources**

- 7.1 [The current version of the FAQ is on the Web](#)
- 7.2 [On-line Discussion Forums](#)
- 7.3 [Web Resources](#)

---

[Next](#) [Previous](#) [Contents](#)

Some  
[DomeHome  
Pictures](#)

submitted by  
subscribers...

Browse  
some [links](#)  
to dome-related  
sites and other  
resources...

Browse the  
[Archives...](#)  
past  
DomeHome  
postings.

Welcome to the

# DomeHome Companion

## Web Site

A Web presence

for subscribers of

the DomeHome Email List



Web hosting is  
courtesy of our  
friends at  
[Addy &  
Associates](#)

*Many thanks!*

## What is the DomeHome Email List?

DomeHome is an e-mail list for geodesic dome home enthusiasts everywhere, dedicated to the discussion of geodesic domes as homes/living areas, and is maintained as a public service by Hoflin Publishing (publishers of *DOME* magazine).

DomeHome is a **moderated** list, meaning that all messages posted by subscribers are reviewed and forwarded by a moderator — not for purposes of censorship, but to make sure that subscribers do not become targets of unwanted e-mail advertising.

This DomeHome Companion Web site is a place where List members can post pictures of the things we talk about in e-mail — and a central location for dome-related resources.

To sign up, send an e-mail message to the address:

[requests@h19.hoflin.com](mailto:requests@h19.hoflin.com)

In the **BODY** of your message (the subject line is ignored), include:

**SUBSCRIBE DomeHome-H**

If you already receive "enough" e-mail, but would like to sample the conversations on our List, you can subscribe in **digest** form, in which you would receive only one e-mail message per day, a compilation of that day's messages.

To subscribe in digest form, in the **BODY** of your message, type:

**SUBSCRIBE DIGEST DomeHome-H**

To unsubscribe from the List, follow the same process, but include this text in your message:

**UNSUBSCRIBE DomeHome-H**

Or, if you like, you can join the DomeHome List by filling in the form at [Hoflin's Web site](#). Choose **DomeHome-H** from the long list of Lists.

**Stormy's Top Ten Reasons To Build Or Live In A Dome**

10. An insatiable desire to taunt hurricanes
  9. Ultimate Christmas decoration: a big Santa hat
  8. Lost your 90-degree builders square
  7. Want to live on Icosadodecahedron Road
  6. Need a place for the composting toilet
  5. You like it when it rains indoors
  4. Want to see mother-in-law's face when told,  
"we're building a house from a kit"
  3. Wanted square house, but ran out of money for the corners
  2. Never figured out square-peg-in-round-hole game as child
- And the Number One Reason To Build Or Live In A Dome:**
- - 
  - 
  1. Need a house to match his-and-hers Volkswagen Beetles!

## Thanks to Stormy Henderson

Everything  
the power of the world  
does is done in a circle. The  
sky is round, and . . . the earth is  
round like a ball, and so are all the stars.  
The wind, in its greatest power, whirls. Birds  
make their nests in circles, for theirs is the same  
religion as ours. The sun comes forth and goes  
down again in a circle. The moon does the same,  
and both are round. Even the seasons form a  
great circle in their changing and always come  
back again to where they were. The life of a  
man is a circle from childhood to child-  
hood, and so it is in everything  
where power moves.  
— *Black Elk*

Check out the **DomeHome [Survey Results](#)**  
...our subscribers describe their Dream Houses.



**Buckminster Fuller** and  
Japanese-American sculptor **Isamu  
Noguchi** were contemporaries and friends.  
Here's a short description of some pictures  
you can see here, captured and digitized  
from a PBS special (clicking on any of these  
links will open the picture in a separate  
window... no need to use the Back button):



A [picture](#) of Noguchi and Fuller talking...

A [bust of Fuller](#) by Noguchi...

A picture of Fuller standing next to his [Dymaxion Car](#)...

Fuller's head and shoulders standing in front of one of his larger [domes](#)...

Fuller with a model of his [Dymaxion House](#)...



This Web site is maintained voluntarily by DomeHome List Moderator  
[J. Michael Rowland](#),  
and is not related to Hoflin Publishing.

mathworld

## INDEX

[Algebra](#)  
[Applied Mathematics](#)  
[Calculus and Analysis](#)  
[Discrete Mathematics](#)  
[Foundations of Mathematics](#)  
[Geometry](#)  
[History and Terminology](#)  
[Number Theory](#)  
[Probability and Statistics](#)  
[Recreational Mathematics](#)  
[Topology](#)

---

[Alphabetical Index](#)

## ABOUT THIS SITE

[About \*MathWorld\*](#)  
[About the Author](#)  
[Terms of Use](#)

## DESTINATIONS

[What's New](#)  
[MathWorld Headline News](#)  
[Random Entry](#)  
[Animations](#)  
[Live 3D Graphics](#)

## CONTACT

[Email Comments](#)  
[Contribute!](#)  
[Sign the Guestbook](#)

## MATHWORLD - IN PRINT

[Order book from Amazon](#)

---

# Access Denied to Browser Agent Mozilla/3.0 (compatible; WebCapture 1.0; Auto; Windows)

---

Thank you for your interest in *Eric Weisstein's World of Mathematics*. You have been denied access because your browser agent either failed to identify itself or was found in a proscribed list of "bulk downloaders" that do not respect `robots.txt` files. Note that some "content filtering" programs (e.g., *AtGuard*) can prevent your browser from identifying itself and can be responsible for the problem.

The material on this web site is copyrighted, and may not be bulk downloaded. For more information, please see the relevant FAQs,

<http://mathworld.wolfram.com/about/terms.html>

<http://mathworld.wolfram.com/about/faq.html#agent>

<http://mathworld.wolfram.com/about/faq.html#copyright>

<http://mathworld.wolfram.com/about/faq.html#mirrors>

Sincerely,  
[MathWorld webmaster](#)

## Gopher-like Menu

- (DIR) [About this gopher and myself.](#)
- (FILE) [NIST time.](#)
- (HTML) [UTC standard](#)
- (DIR) [Reference gophers, etc.](#)
- (DIR) [Educational gophers, etc.](#)
- (DIR) [Community gophers, etc.](#)
- (DIR) [Newsworthy gophers, etc.](#)
- (DIR) [Socially responsible gophers, etc.](#)
- (DIR) [You link to mine and I'll link to yours.](#)
- (DIR) [Some ftp/software sites.](#)
- (DIR) [Sample navigational tools.](#)
- (DIR) [In memory of Dr. Johnson +](#)
- (HTML) [Send a comment, if you must!](#)

# EcoBusinessLinks

## Environmental Directory

The First Green Directory **100% Wind Energy powered** through wind credits. We walk our talk! Serving You and Mother Earth Since 1998!



<a href="#">Home</a>
<a href="#">Search</a>
<a href="#">Add Your Website</a>
<a href="#">Advertising</a>
<a href="#">Contact</a>
<b>General Retailers</b>
<a href="#">Department Stores &amp; Malls</a>
<a href="#">Free Recycled Goods</a>
<a href="#">Second Hand</a>
<a href="#">Bookstores</a>
<b>Specialized Online Retailers</b>
<b>Body Care</b>
<a href="#">Bodycare</a>
<a href="#">Feminine Hygiene</a>
<a href="#">Natural Soap</a>
<b>Baby Care &amp; Toys</b>
<a href="#">Attachment Parenting</a>
<a href="#">Baby Products</a>
<a href="#">Cloth Diapers</a>
<a href="#">Diaper Services USA &amp; Canada</a>
<a href="#">Nappy Services Europe</a>
<a href="#">Toys</a>
<b>Food</b>
<a href="#">Online Food Stores</a>
<a href="#">Organic Herb Stores</a>
<a href="#">Cooking Hardware</a>
<a href="#">Solar Cookers</a>
<a href="#">Pet Food Stores</a>
<a href="#">Seed Stores</a>
<b>Apparel &amp; Access.</b>
<a href="#">Bags &amp; Accessories</a>
<a href="#">Clothing</a>
<a href="#">Organic Cotton Clothing</a>

Looking for cheap solar panels, a solar house, organic cotton, a vegetarian date,  
organic food, an organic farm or a sustainable community?  
This and much more in thousands of reviewed green websites from EcoBusinessLinks.

## Welcome at EcoBusinessLinks!

### New Categories

- [Yurts](#)
- [Environmental Testing](#)
- [Carbon Emissions Offsetting](#)
- [Free & Recycled !](#)
- [Natural Candles](#)
- [Sustainable Farming Associations](#)
- [Garden Offices](#)
- [Printing & Packaging B2B](#)
- [Small Wind Turbine Gallery](#)
- [Edible Wild Plants - Foraging](#)

### Image Galleries

- [Small Wind Turbines](#)
- [Green Furniture Gallery1](#)
- [Strawbale Houses](#)
- [Dome Houses](#)
- [Cob Houses](#)
- [Earth Sheltered Houses](#)
- [Masonry Stoves](#)

### Event Calendars

- [Renewable Energy](#)
- [Sustain. Building 1](#) [Calendar 2](#)
- [Food Safety](#)
- [EcoTourism](#)
- [Electric Vehicles](#)
- [Sustainable Agriculture \*\*NEW\*\*](#)
- [Simple Living Events](#)

### Environmental Jobs!

### Eco Villages!

USA, Europe, Russia,...

## Featured Site

### Green Planet Homes



This Canadian company builds ecologically sustainable homes and specializes in straw bale houses but will also renovate sustainably.

### Towards ZERO emissions! Fuel Efficient Vehicles

Now starting at 215 mpg and 1 gr. CO emissions!

**Featured Model**  
**Honda Civic Hybrid**  
**48 mpg**



New global **fuel cell** vehicle study is now available (free)

### Daily EcoNews

- [Planet Ark](#)
- [Enviro. News Network](#)
- [Solar News](#)
- [Overview](#)
- [Press@Yahoo](#)
- [Solar Access REN](#)
- [WindPowerOnline.com](#)
- [H2FC Fuel Cell News](#)
- [Fuel Cell Today](#)
- [Europe Enviro. News](#)
- [Forests News](#)
- [Organic Industry News](#)

### Other EcoNews

- [AmazonWatch](#)
- [GE Food Alert](#)
- [Electric Vehicles](#)
- [Clean Vehicles](#)
- [News-UK](#)
- Monthly EcoNews**
- [Enviro. Building News](#)
- [PositiveNews](#) (email only)

### Even More EcoNews

### Ecological Footprint & Pollution Calculators

**Green Single?**  
**Click here!**

- [Organic Wool Clothes](#)
- [Fabrics](#)
- [Hemp Products](#)
- [Shoes](#)
- Home**
- [Air Purifiers](#)
- [Arts & Crafts](#)
- [Bedding](#)
- [Candles New](#)
- [Clean Energy](#)
- [Cleaning Products](#)
- [Composting Toilets](#)
- [Cooking Hardware](#)
- [Furniture](#)
- [Lighting](#)
- Office**
- [Office Products](#)
- [Recycled Paper](#)
- Transport**
- [Electric Vehicles](#)
- [Car Rentals](#)
- Do-It-Yourself**
- [Natural Soap Making](#)
- Food**
- Food Sources**
- [Going Local](#)
- [Food Co-ops](#)
- [Online Organic Food](#)
- [Organic Baby Food](#)
- [Organic Herbs](#)
- [Restaurants](#)
- Food Resources**
- [Organic Food Info](#)
- [Vegetarian Food Info](#)
- [Vegan Food Info](#)
- [Macrobiotic Food Info](#)
- [Veg. Recipes](#)
- [Organic/Natural/Vegan Food Manufacturers](#)
- [Edible Wild Plants](#)
- Lifestyle**
- [Ecological Footprint & Pollution Calculators](#)
- [Carbon Offsetting NEW](#)
- [Veg & Eco Dating](#)
- [Green Weddings](#)
- [Simple Living](#)
- [Communities and EcoVillages](#)
- [Environmental Jobs](#)
- [Local Currencies](#)

## Campaigns



- [M&M/Mars Fair Trade Chocolate Campaign](#)
- [Clean Clothes Campaign](#)
- [National Campaign for Sustainable Agriculture](#)
- [The Global Campaign for Agrarian Reform](#)
- [Sierra Club Campaign Center](#)
- [Greenpeace Action Center](#)
- [EcoBusinessLinks Campaign Center](#)

## Some Great (Positive) Articles & Stories

- [How enlightened businesspeople are changing the world at the local level](#)
- [Buddhist monks helping 1000's setting up organic farming in Thailand](#)

**Europe installed more MW wind energy in 2002 than the total installed capacity of the USA!**

When will the USA wake up?

Read new Stanford Univ. study: [25% of USA can produce as cheaply as gas or coal!](#)

Further information: [American Wind Energy Association](#) [European Wind Energy Association](#)

## Awards



## Some of the Kind Folks Who Link To EcoBusinessLinks

Last update: 08/31/04

Total number of sustainable links: 2809

**Proudly serving Mother Earth since 1998!**

## DISCLAIMER

**Please note that these pages are meant strictly for informational purposes to those seeking retailers/wholesalers/manufacturers/providers of or information about ecological products and/or services. Inclusion or exclusion from these pages does not imply a recommendation or lack thereof by EcoBusinessLinks and/or its collaborator(s) for any particular company or organization.**

This site is best viewed with Internet Explorer 4.x or greater

Problems with website, please contact the [webmaster](#)

<b>Organic Farming &amp; Gardening</b>
<a href="#">Organic Seeds</a>
<a href="#">Natural Pest Control</a>
<a href="#">CSA Farming Info</a>
<a href="#">Organic Farming Info</a>
<a href="#">Farming Associations</a>
<a href="#">Organic Farms</a>
<a href="#">Organic Farms for Sale</a>
<a href="#">Personal Gardening Pages</a>
<b>Other Resources</b>
<a href="#">News</a>
<a href="#">Magazines</a>
<a href="#">Education</a>
<a href="#">Green Directories</a>
<b>Services</b>
<a href="#">Green Electricity Utility</a>
<a href="#">Enviro Organizations</a>
<a href="#">Insurance</a>
<a href="#">Investing</a>
<a href="#">Sustainable Development</a>
<b>Services B to B</b>
<a href="#">Sustainable Webhosts</a>
<a href="#">Printing &amp; Packaging</a>
<b>House &amp; Interior</b>
<b>General</b>
<a href="#">House Plans</a>
<a href="#">Sustainable Architects</a>
<a href="#">Interior Design &amp; Renovation</a>
<a href="#">Green Real Estate</a>
<a href="#">Organic Real Estate</a>
<b>House Styles</b>
<a href="#">EcoHouses General</a>
<a href="#">EcoHouse Showcases</a>
<a href="#">Dome Homes</a>
<a href="#">Concrete Domes</a>
<a href="#">Straw Bale Houses</a>
<a href="#">Cob Houses</a>
<a href="#">Garden Offices</a>
<b>House Features</b>
<a href="#">Roof Gardens</a>
<a href="#">Building Supplies</a>
<a href="#">Natural Paint Mfg</a>
<a href="#">House Cooling</a>
<a href="#">Masonry Heating</a>
<a href="#">Insulation</a>
<b>Energy</b>

<b>General</b>
<a href="#">General Info</a>
<a href="#">Retailers</a>
<a href="#">Green Utilities</a>
<b>Solar Energy</b>
<a href="#">Solar Price Survey</a>
<a href="#">Used &amp; Surplus Panels and Cells</a>
<a href="#">Solar Water Heaters</a>
<a href="#">Solar Cookers</a>
<a href="#">Solar Energy Info</a>
<a href="#">Solar Manufacturers</a>
<a href="#">Solar Trackers Manuf</a>
<b>Wind Energy</b>
<a href="#">Wind Energy Info</a>
<a href="#">Small Wind Turbine Gallery</a>
<a href="#">Small Wind Turbine Manufacturers</a>
<a href="#">Large Wind Turbine Manufacturers</a>
<a href="#">Wind Farm Development</a>
<a href="#">Wind Energy Associations</a>
<b>Energy - Others</b>
<a href="#">Biodiesel</a>
<a href="#">Fuel Cells</a>
<b>Travel</b>
<b>Transport</b>
<a href="#">Train Travel</a>
<b>Guides &amp; Tours</b>
<a href="#">EcoTravel Guides</a>
<a href="#">Eco Adventure</a>
<a href="#">Walking Holidays</a>
<a href="#">Eco Bike Tours</a>
<a href="#">Educational Holidays</a>
<a href="#">Volunteering</a>
<b>Lodging</b>
<a href="#">Eco Hotels</a>
<a href="#">Jungle Lodges</a>
<a href="#">Organic Farm Holidays</a>
<a href="#">Rural Tourism</a>
<a href="#">Cottages &amp; Camps</a>
<a href="#">Vegetarian &amp; Organic Food Guest Houses</a>

# LIVING THE COTTAGE LIFE FRUGALLY



Frugal Living, Homesteading, and Cottage Style, With The Old-fashioned Charm of Yesteryear!

[Read The New July Issue of Heart & Home Newsletter](#)

## Find The Grants You Need

Looking for a grant to help with your needs? This website lists all the governments grants that are available to you.

The Catalog of Federal Domestic Assistance (CFDA)

The website is: <http://www.cfda.gov/>

You can simply enter a keyword & search the entire database to find the programs that you might qualify for. Then they give you the phone number & contact information for the person you should get in touch with for that particular program. The great thing is, because you will need to submit a proposal for the grant & let the agency know why they should pick you for it, the site offers many guides and sample proposals to help you get started! There is also a top 10 list to help you see what grants other people are looking for to help you get an idea of where to begin your search.

A few things that I found:

- \* Rural Businesses grants
- \* Promotion of the arts grants
- \* Higher Education Challenge Grants
- \* Teacher Next Door Initiative (for teachers who need a new home)
- \* Rural Housing Preservation Grants If your life is taking a new path, take a few moments to see if you can get some help along the way!

~ He who kneels before God can stand before anyone.

### Tips:

To keep outdoor light bulbs from rusting and becoming hard to remove, coat the threads with petroleum jelly before you put them in!

Also - put a layer around the inside rim of a paint can before closing the lid. It will come right off when you open the next time and it will still be fresh.

<a href="#">Newsletter</a>	<a href="#">Go Carts</a>	<a href="#">Frugal Tips</a>	<a href="#">Garden Ponds</a>	<a href="#">Queen Village</a>
<a href="#">Past Issues</a>	<a href="#">Link Directory</a>	<a href="#">Income Ideas</a>	<a href="#">Cottage Gardens</a>	<a href="#">About Us</a>
<a href="#">How-to Articles</a>	<a href="#">Homesteads 4 Sale</a>	<a href="#">Radio Show</a>	<a href="#">Home</a>	<a href="#">Email</a>



© Copyright of Pearl Sanborn. No reproduction of any kind without written permission.  
[Everything you can see & do at this site!](#)

The Google logo is displayed in its characteristic multi-colored font (blue, red, yellow, blue, green, red) with a trademark symbol (TM) to the upper right.



What are you looking for? Search this site here.

The Links below will take you to more articles, information and resources for your natural, self-sufficient lifestyle.

[Natural Skin Care Products](#) Soaps, lotions, baby care, emu oil...

[Herbal Health and Healing Information](#)

[Home Herbal Medicine Cabinet](#) See what herbs our family uses

[Community Herbal Medicine Cabinet](#) See what remedies others use & add yours!

[Birth, Babies and Breastfeeding](#)

[Homeschooling](#)

[Natural Foods](#)  
In The Kitchen  
Home Preparedness

[Organic Gardening](#)

[Raising Small Livestock](#)

[Home Business](#)

[Kiahs Krafts 4 Kids](#)  
The Kids Pages

[The Forums](#)

[Resourceful Links Index](#)

[Natural Family Home Newsletter Archive](#)

[About us](#)  
[Contact us](#)  
[Link To Us](#)

Find Resourceful Links Quick!

naturalfamilyhome.com

# Family Homesteading Advocate

Simple Living for the Urban and Rural Homesteader



The Forums are now up and running!  
[Go to the Forums](#) to find/offer help with your homesteading needs.

**Our purpose** is to provide information, resources and support to help improve your natural, self-sufficient lifestyle, whether you homestead in the city or the country!

~~~~\*~~~~

May all who desire to live simply, more self-reliant and closer to nature enjoy the fellowship with other "homesteaders" that you will find here.

Lots more great articles and information is provided on the page links in the left hand column!  
Check it out!

### What is "Homesteading" really?

(hom'sted-A home or dwelling, esp. a house with the ground and buildings immediately connected with it)  
Homesteading! The word for us has come to mean something far different from the concept we first embraced. Mention the word and what probably comes to mind is a fair chunk of land, a cozy home, animals grazing in the field, huge gardens, pantries stocked with home preserved food, etc. Nowadays that's not a total possibility for some folks. Homesteading to me brings a vision of a home, any home, anywhere with people living and working together for a simple, healthy, holistic, satisfied lifestyle.

Read on and stay tuned. You'll meet all kinds of folks "just doin' it." Urban and rural, living in apartments or wind swept mountain tops and everywhere in-between.  
Keep the faith, Tony & Kelly Frohnauer

Mission Statement: This website was birthed from our continuing commitment and conviction to simple, self-sufficient living and a holistic lifestyle. Our hope and desire is that through our experiences, both the failures and the successes, we can be an encouragement to others who have the same convictions and to ultimately plead the cause for all of us who are "just doin' it".

Inside the Family Homesteading Advocate...  
You will find informative articles, how-to tips, helpful products and interesting links relating to many areas of simple, natural living and self-sufficiency. Some of our pages will have regular feature authors such as our goat raising

## Natural Family Botanicals



### Natural Skin Care for the Natural Family

A full line of natural soaps, lotions, baby care, emu oil & more!

[~Shop Here~](#)

### Tell A Friend About This Website!

Your Name:

Your E-mail:

Your Friend's E-mail:

Your Comments:

Receive copy:

Family Homesteading Advocate  
[Guest Book](#)  
Please say "Hi" and tell us where you are from.  
[Sign Here](#)  
[Read Here](#)

If you would like to use our articles for your publication please [contact us.](#)

Our goal is to make navigation simple and enjoyable. If you find



articles by Bea Frankland, our long time friend and local goat farmer! You can find her articles on the [Raising Small Livestock](#) page.

We encourage submissions of articles, tips, personal stories, recipes, and anything relating to simple family living. Our desire is for the Family Homesteading Advocate to be a publication "by the people for the people". Articles will be updated and changed regularly so please [Bookmark this site](#) and check back often!

links that aren't working or anything else that is confusing or annoying please don't hesitate to let us know!!! **ENJOY!!!**

Need Homeschooling Materials? [Click here](#) to see the Used Curriculum Listings!  
  
[Join our Homeschooling Community at the forums!](#)

**HOMESTEADING FORUMS**  
~}~~Join our Community at the FORUMS~~{~  
The place to interact with other folks who are "just doin' it"!  
Topics started....  
Homesteading Communities  
Natural Birthing  
Homeschooling  
Homesteading Tips  
Recycling  
.....more!  
[CLICK HERE](#)  
If you have a Topic that you would like to see started just let us know and we will set it up!

**Send us your stories**  
If you have an idea, tip, story, favorite link, resource or anything that you would like to share with our readers, please [contact us](#) and we will consider it for publication.

[Visit www.Lehmans.com!](#)

- \*books
- \*cheese/butter
- \*housewares
- \*canning
- \*lighting
- \*stoves
- \*solar power
- \*water pumps
- \*and much more!



Visit **Lehman's** for all your homesteading needs. **Gas powered refridgerators, pre-electric lights**, homestead tools and a whole lot more. They also have a good list of helpful **how-to books**.



[HOME](#) | [ABOUT US](#) | [BIRTH, BABIES & BREASTFEEDING](#) | [FORUMS](#) | [HOMESCHOOLING](#) | [HERBAL HEALTH & HEALING](#) | [HOME MEDICINE CABINET](#) | [COMMUNITY MEDICINE CABINET](#) | [ORGANIC GARDENING](#) | [NATURAL FOODS](#) | [RAISING SMALL LIVESTOCK](#) | [HOME BUSINESS](#) | [KIAHS KRAFTS4KIDS](#) | [LINKS & RESOURCES](#) | [NATURAL SKIN CARE PRODUCTS](#) | [CONTACT US](#)

©2001-2004, naturalfamilyhome.com





# U.S. Department of Energy Energy Efficiency and Renewable Energy

[Search Help](#) ▶ [Search](#)

[Site Map](#)

[EERE Information Center](#)

## Energy Information Portal **DOE Offices & Programs**

A gateway to hundreds of Web sites and thousands of online documents on energy efficiency and renewable energy

### Energy Efficiency

- ▶ [Buildings](#)
- ▶ [Industry](#)
- ▶ [Power](#)
- ▶ [Transportation](#)

### Renewable Energy

- ▶ [Bioenergy](#)
- ▶ [Geothermal](#)
- ▶ [Hydrogen](#)
- ▶ [Hydropower](#)
- ▶ [Ocean](#)
- ▶ [Solar](#)
- ▶ [Wind](#)

### Information For

- ▶ [Consumers](#)
- ▶ [Kids](#)
- ▶ [States](#)

### Topics

- ▶ [Education](#)
- ▶ [Financing](#)

▶ [About the DOE Office of Energy Efficiency and Renewable Energy](#)

▶ [Biomass Program](#)

▶ [Building Technologies Program](#)

▶ [Distributed Energy Program](#)

▶ [Federal Energy Management Program](#)

▶ [FreedomCAR & Vehicle Technologies Program](#)

▶ [Geothermal Technologies Program](#)

▶ [Hydrogen, Fuel Cells & Infrastructure Technologies Program](#)

▶ [Industrial Technologies Program](#)

▶ [Solar Energy Technologies Program](#)

▶ [Weatherization & Intergovernmental Program](#)

▶ [Wind & Hydropower Technologies Program](#)

- ▶ [Business Administration](#)
- ▶ [Golden Field Office](#)
- ▶ [Regional Offices](#)
- ▶ [DOE Laboratories](#)
- ▶ [Solicitations](#)

### NEWS

[DOE Awards \\$16 Million for 162 Efficiency, Renewable Energy Projects](#)

August 09, 2004

[DOE Begins Process to Set New Efficiency Standards for Energy Equipment](#)

July 30, 2004

[DOE Awards \\$94.8 Million to Weatherize Homes in 20 States](#)

July 29, 2004

[More News](#)

[Subscribe to Our Newsletter](#)

### FEATURES

**New EERE Corporate Brochure** (PDF 73 KB)  
Download Acrobat Reader ▶



[Webmaster](#)

| [Security](#)

& [Privacy](#) |

[Disclaimer](#)

U.S.  
Department  
of Energy

Content

Last

Updated:

08/25/2004

# Backwoods Home Magazine

practical ideas for self-reliant living



Want a more self-sufficient lifestyle for you and your family? Backwoods Home Magazine can help you achieve it. Every issue is packed with solid, practical, hands-on information on a wide range of self-reliance topics.



Remembering  
Sept. 11, 2001

Enter A Keyword

Search  
BHM

Subscribe

## Features

[Home Page](#)  
[Current Issue](#)  
[Article Index](#)  
[Previous Issues](#)  
[Newsletter](#)  
[Letters](#)  
[Humor](#)  
[Free Stuff](#)  
[Feedback](#)  
[Recipes](#)  
[Tell-A-Friend](#)  
[Home Energy In](#)

## Quick Links

[Massad Ayoub](#)  
[Ask Jackie Clay](#)  
[Dave Duffy](#)  
[John Silveira](#)  
[Claire Wolfe](#)

## Forum / Chat

[Forum/Chat Info](#)  
[Enter Forum](#)  
[Member Chat](#)  
[Lost Password](#)

## General Store

[Ordering Info](#)  
[Subscriptions](#)  
[Anthologies](#)  
[Books](#)  
[Back Issues](#)  
[Help Yourself](#)  
[All Specials](#)  
[Classified Ad](#)  
[Trading Post Ad](#)

## Advertising

[Swap Meet](#)  
[Print Classifieds](#)  
[Trading Post](#)  
[Web Site Ads](#)  
[Magazine Ads](#)

Win a BHM CD Anthology? Just for Telling  
A Friend about the Backwoods Home  
Magazine website? Can this be true?

YES!

Read online from the current issue:

### [Solar power 101: Inverters](#)

By Jeffrey Yago, P.E., CEM

This third installment of our continuing course on solar electric power system basics will address power inverters. Since all solar photovoltaic modules generate DC electricity, unless all of the lights and appliances being powered are DC, an alternative energy power system will need to include an inverter. This device is used to convert the DC electricity from the solar modules and batteries into AC electricity.

### [Common sense about burglary prevention](#)

By Massad Ayoub

Your smart, professional burglars case their jobs carefully and hit empty homes. The ones who hit when you are there have to be considered dangerous. Either they know you and your loved ones are at home and are prepared to deal with you forcibly, or they are so incredibly stupid or spaced out that they are dangerous to themselves and others.

You cannot, of course, use deadly force merely because the intruder is in your house. But, if he attacks you after forcing his way into your home, he is bought and paid for. The best thing, of course, is to keep him from getting in at all.

[Read more articles from the Current Issue or read features in Adobe PDF format](#)



Get 3 FREE gifts,  
including a 384 page anthology,  
with any regular subscription  
[Click Here](#)

#### More Features

[Links](#)  
[Country Moments](#)  
[Radio Show](#)  
[Meet The Staff](#)  
[Contact Us/](#)  
[Address Change](#)  
[Write For BHM](#)  
[Privacy Policy](#)

#### News/Politics

[Dave Duffy](#)  
[John Silveira](#)  
[Columnists](#)

#### Link to BHM

Available Now In  
The General Store



\$17.95

more info

Create 50 herb related projects including creams, vinegars, oils, & teas.

#### Win a FREE CD!

Our Latest [Tell-A-Friend](#) Winner:

#### Andrea Elvin of Pickerington, Ohio

We've had 93 winners so far. You could be the next to win a CD anthology. [Here's How!](#)

#### Feedback

BHM welcomes your letters. We are especially interested in your non-political letters that talk about how you live your self-reliant life.



Updated August 29

[Click Here To Read Or Write Letters](#)

### Get Powered Up!

Certified energy manager Jeff Yago answers your questions on our new

### Home Energy Information

page. You'll also find quick links to online articles and more.

[Click here](#)

Stop back often.  
You'll find something new on our home page every few days.

### Hardyville, USA

#### [The Hardy Awards](#)

by Claire Wolfe

It's been another stellar year in the history of the Hardyville Freedom Film Festival (a Hardy County institution since 2004). The competition was fierce. Famous stars and directors vied for the coveted Hardy Awards. Which was pretty amazing, what with several of those celebrities busy being dead.

The gossip, backbiting, politicking, and campaigning were fierce. At least they were fierce around the judges' table at the Hog Trough Grill and Feed. At one point Nat and Dora's disagreements came to a head - rather literally -- when she flung a bloody-rare steak, complete with sizzling platter, at his skull. (The steak toss might have been considered assault with a deadly weapon, but Nat salted and devoured the evidence.)

[Previous Column](#) - [SKScapades](#)

### Duffy's View

#### [Voting for Bush to fight terrorism](#)

by Dave Duffy

Only a month ago I decided I would sit out my first presidential election ever because I didn't like either Senator Kerry or President Bush. But after some soul searching, and after assessing the important issues over which a President has a lot of control, I've decided to vote after all, and I'll be voting for President Bush. The main issue that has prompted my change of heart is the War on Terrorism. Yesterday's terrorist murder of Russian school children reinforced my belief that it is a full scale international war that must be won, and I think Bush is a far more resolute war time leader than Kerry would be.

## BHM Encore

*Every once in a while, one of the articles we publish touches so many nerves we receive an avalanch of letters about it, both pro and con. Don Chance's article on horsemeat was the most recent article to raise the hackles of many, many readers. You'll find many of their letters on our web site [Feedback](#) page as well as in the [letters section](#) of the current issue.*

*For those of you who missed it, we offer it here again. And if you have any comments on it, one way or the other, send them along to Editor and Publisher Dave Duffy at [editor@backwoodshome.com](mailto:editor@backwoodshome.com)*

### [Hungry enough to eat a horse???](#)

by Don Chance

Okay, it's not everyday dining fare, I agree. But, tell someone you're having horse steaks for supper, grilled to perfection and garnished with plenty of fresh herbs and vegetables, and you're likely to get the same reaction as if you had casually mentioned you're serving up your own leg.

But is setting the table with horse meat really that offensive an idea?

## BHM Web Site Exclusive

### [Stairs: the next level](#)

by Skip Thomsen

A staircase can be so visually inviting that it beckons one to try it out—to see where it leads. A properly done staircase is comfortable to walk and visually interesting. A staircase can be designed to have a landing that affords a unique view of a room below or out of a special window. But too often, staircases are basically boring, many are uncomfortable or tiring to walk, some are even downright dangerous. Many perfectly legal and structurally correct staircases are intimidating by being too steep, dark, or narrow. Maybe even all of the above.

So what are the ingredients of the perfect staircase design? The basic components are safety, comfort, eye-appeal, and visual and functional integration into the design of the room or building. Often, these elements are simple to put into practice. Sometimes they take some careful thought and even a bit of creativity.

## MEET THE DUFFYS

September 24-26: Fredricksburg, Texas  
**Renewable Energy Roundup and Green Living Fair**

512-326-3391

[www.theroundup.org](http://www.theroundup.org)

**Stop by the BHM booth to say hello and chat or just to take advantage of some spectacular deals we'll be offering.**

## Road Trip

### [The Wisconsin energy show and other places](#)

by Dave Duffy

My family and I just returned to Oregon from Wisconsin after exhibiting the magazine at the 2004 Midwest Renewable Energy Association (MREA) annual energy show. The show was a resounding success for Backwoods Home Magazine...



## The Affordable Whole Sheebang!

Includes 2 new Books  
& our 4-year Anthology CD

You'll get  
11 Print Anthologies  
12 CD Anthologies  
PLUS  
A FREE 2-Year subscription to  
Backwoods Home Magazine

Only 3 payments of \$69

Save \$196.35!

[Click here for details](#)

## Lifetime Subscription Special

Save \$355.85

Order a Lifetime subscription to  
BHM and we'll send you The Whole  
Sheebang, advertised to the left,  
absolutely FREE!

Plus you'll get all our future  
anthologies sent to you FREE

Only \$500

[Click here for details](#)

### BHM Web Site Exclusive

[Brood X](#) by Rev. J.D. Hooker

Though I was still in my early thirties at the time, I clearly remember fishing during the last big 17-year hatch. At that time I'd simply gather up a large quantity of already dead locusts from where they'd fallen around the tree trunks and, after threading a locust on to a relatively large #1-size hook attached to a tapered leader, I'd flip-cast the bug into a shaded area right up near the bank. If I didn't get a strike within the first few seconds, I'd give my rod a little twitch causing the bug to move only a couple of inches. This nearly always triggered an actual attack by a frenziedly feeding fish.

### BHM Web Site Exclusive

[Getting Logs](#) by Dorothy Ainsworth

Attention: Would-be loggers. There have been changes in policy at the United States Forest Service and the Bureau of Land Management. I have just found out that the procedure to obtain logs through the USFS or BLM has changed drastically because of the NEPA (National Environmental Protection Agency). You can no longer go into a ranger station like I did and simply get a permit to cut your own logs in a given area. Now you have to go through a "process".

### BHM Web Site Exclusive

## Ayoob on Firearms

[Firearms handling refresher Part III: Rifles](#) by Massad Ayoob

Always remember that training is a good investment in anything serious. Your local fish and wildlife department, or your local gun shop, can probably steer you to certified instructors. So can the National Rifle Association, at their toll-free number 1-877-NRA-2000. Jeff Cooper's Gunsite has an excellent course they call "General Rifle," and Clint Smith's Thunder Ranch still offers the course that made "Urban Rifle" a byword in training. Another good source is the Firearms Academy of Seattle where the pictures that accompany this article were taken. I particularly recommend the rifle classes FAS offers taught by Georges Rahbani. The graduates rave about the program.

Previously: [Part I: Handguns](#), [Part II: Shotguns](#)

**Recipe of the Week**  
from [Backwoods Home Cooking](#)



[Boston brown bread](#)



**From Our Seventh Year Anthology**

**Here are some cucumber pickles to make at home** By Olivia Miller

Preserving produce by "pickling" is one of the oldest and most delightful ways to save your summer harvest for your winter table. The word "pickle" applies to any food preserved in brine and/ or vinegar, with or without bacterial fermentation, and with or without the addition of spices and sugar.

[Read this article](#)

**From Our Eleventh Year Anthology CD**

**Build this sturdy large-capacity food dehydrator** By Charles Sanders

Drying of food as a means of preservation has been around for a long time. Populations in suitably dry climates all around the globe have dried meat, fish, fruit, and vegetables in times of plenty as a way to provide for the leaner months of the year. My grandmother used to tell us of when she was a child, helping to spread apple slices on the top of a tin-shed roof for drying. An aunt once described stringing fresh young bean pods on a long heavy thread and hanging them to dry, coming up with what they called leather-britches beans. Obviously, these were simple and imperfect food drying systems, but they do show ways in which food can be dried at home.

[Read this article](#)

**Super Special Anthology Sales**

Get a FREE 1 year subscription to  
Backwoods Home Magazine

when you buy our Eight Anthology  
Special or our CD Anthology Special

[Click Here for more info](#)

**FREE Toolbar for Internet Explorer**



Great features. Customizable. Get yours now!

[Click for details.](#)

## Featured Writer

### [Determined woman builds distinctive vertical log studio](#)

By Dorothy Ainsworth

For a novice, there's no thrill like the tactile kinetic experience of driving a 16-penny nail home in three blows, then burying its head with two extra whacks for no reason. There was evidence of beginner's overkill everywhere. Electrical cord repairs looked like snakes that had swallowed gophers. A job wasn't finished until all the nails were gone. There were no gimmicks or shortcuts in the learning process. I sweated and strained and scarred. But the satisfaction of sawing a clean square cut with a hand saw rivaled sewing a fine seam or baking a perfect loaf of bread, and eventually the results became just as predictable.



#### More by Dorothy Ainsworth:

[Never underestimate a woman](#)

[Dorothy Ainsworth update: Out of the ashes](#)

[Dorothy Ainsworth makes her valiant comeback](#)

[Build a log crib](#)

[This coop is for the birds](#)

[Start a post-construction cleaning business](#)

[Make a quilt out of Levis](#)

[A river rock shower](#)

**[Dorothy Ainsworth responds to critics](#)**

[The "Curious Guy" and the "Offended Woman"](#)



**Newly Revised!  
Now 296 pages!!**

BHM's  
**Emergency Preparedness  
and Survival Guide**

Choose the 296 page book,  
the expanded CD-ROM, or both!

[Click Here for more information.](#)



## Back Issue Special

12 15 selected issues for only \$29.95.  
**Save \$45.05!**

[Click here for details](#)

## In The BHM Book Store

[Fences for Pasture & Garden](#)

[Brewing the World's Great Beers](#)

[Making Rag Rugs](#)

[How To Live Without Electricity And Like It](#)

[GunProof Your Children](#)

[Storey's Guide to Raising Chickens](#)

[Herbal Tea Gardens](#)

[365 ways to RELAX mind, body & soul](#)

[The Self Reliant Homestead](#)

## From Past Issues

[Used bookstores can be successful in the hinterlands](#)

By Jennifer Stein Barker

[A Native American feast](#)

By Jackie Clay

[Tools and hardware for the backwoods home](#)

By James Ballou

[Finding the best dog for the country life](#)

By Anita Evangelista

[Five building tricks for super strong framing](#)

By Don Fallick

[Southern cooking that doesn't just whistle Dixie](#)

By Richard Blunt

[Everybody talks about lightning — and yes, there are things you can do about it](#)

By Albert H. Carlson

[America's earliest First Ladies were fascinating](#)

By John Silveira

[Sex and Sins in the Cemetery](#)



Click For  
Details

**12 Selected Issues  
Only \$29.00**

Click For  
Details



*Backwoods Home Magazine* strives for accuracy in its articles and honesty in its advertisements, but the publisher and editors assume no responsibility for injuries or loss incurred by anyone utilizing the information in the articles, responding to the ads or following any of the links posted on this website.

[Please click here to read our privacy policy.](#)

Top of Page

www.backwoodshome.com designed and maintained by [Oliver Del Signore](#)  
© Copyright 1998 - 2004 Backwoods Home Magazine



Premium **House Plans** from the Nation's leading **Architects and Designers**

[Home](#) | [My Plans](#) | [Order Info](#) | [Contact Us](#) | [Advanced Search](#)

[Sitemap Us](#) | [About Us](#) | [FAQ](#) | [Links](#)

Log In To [My House Plans](#)

September 5th, 2004

### Featured House Plan



[View House Plan](#)

### Plans In Our Database

- [Country/Farm House Plans](#)
- [European Home Plans](#)
- [Victorian House Plans](#)
- [Colonial Floor Plans](#)
- [Cape Cod House Plans](#)
- [Traditional Home Plans](#)
- [Contemporary Home Plans](#)
- [Mediterranean Home Plans](#)
- [Recreational Floor Plans](#)
- [Ranch Home Plans](#)
- [Hillside House Plans](#)
- [1 1/2 Story Floor Plans](#)
- [Split Entry House Plans](#)
- [In-Law Suites](#)
- [Split Level Home Plans](#)
- [Log House Plans](#)
- [Grade Level Entry Plans](#)
- [Wheelchair Accessible Plans](#)

### GLOBAL SEARCH

|                                        |                                                               |
|----------------------------------------|---------------------------------------------------------------|
| Search for Plan #:                     |                                                               |
| Square Footage Range: (sq. ft)<br>to   | Number of Bedrooms:<br>1 2 3 4 5+                             |
| House Width Range: (ft)<br>to          | Number of Stories:<br>1 2 3+ Walk-out                         |
| House Depth Range: (ft)<br>to          | Attached Garage:<br>No Preference Yes No                      |
| House Plan Types:                      | Bonus Room<br>Master Bedroom on Main Floor                    |
| Number of results per page:<br>6 12 24 | <a href="#">ADVANCED SEARCH</a><br><a href="#">click here</a> |
| <input type="button" value="CLEAR"/>   |                                                               |

### Garage Plans



[View Garage Plans](#)

- [New House Plans](#) ▶
- [Price Guarantees](#) ▶
- [Find a Builder](#) ▶
- [Bookmark This Page Now](#) ▶
- [Home Builders](#) ▶

We invite you to browse through our online catalog to view the vast selection of house plans and garage plans available, including some of the most unique house plans in the country. This distinctive collection of outstanding home plans is offered by Globalhouseplans.com on behalf of North America's leading Architects and Designers.

Our commitment to service, combined with our exceptional house plans, garage plans and affordable prices is the reason we are one of North America's leading House Plan Companies. Finding the right house plan to build your ultimate dream home could be a difficult task without the right resource. It's a very big decision, and you want the knowledge and assurance that selection and excellence of choice are provided. If you are looking for home plans, floor plans, house floor plans, garage plans, house designs and home design, you have come to the right place.

If you have any questions on any of our house plans and garage plans, please do not hesitate to call us at **1-800-645-1477**

[Canadian Search](#) | [Home](#) | [My Plans](#) | [Order Info](#) | [Contact Us](#) | [Search](#) | [Sitemap](#) | [About Us](#) | [FAQ](#) | [Links](#)

[House Floor Plans](#)  
[Home Plans](#)

[Disclaimer](#)

[Link To Us](#)

[HomeSalez.com](#)



[globalhouseplans](#)

[More House plans](#)

# HOME PLAN Superstore

HOME MY PLANS ORDER INFO CONTACT ADVANCED SEARCH ABOUT FAQ LINKS SITEMAP

Log In To [My Home Plans](#)

September 5th, 2004

## Featured Home Plan



[View Home Plan](#)

### Plans in our Collection

- [Country/Farm House Plans](#)
- [European Home Plans](#)
- [Victorian Floor Plans](#)
- [Colonial House Plans](#)
- [Cape Cod Home Plans](#)
- [Traditional Floor Plans](#)
- [Contemporary Home Plans](#)
- [Mediterranean Home Plans](#)
- [Recreational House Plans](#)
- [Ranch Home Plans](#)
- [Hillside House Plans](#)
- [1 1/2 Story Home Plans](#)
- [Split Entry Floor Plans](#)
- [In-Law Suites](#)
- [Split Level House Plans](#)
- [Log House Plans](#)
- [Grade Level Entry Plans](#)
- [Wheelchair Accessible Home Plans](#)

## HOME PLAN SEARCH

**Search for Plan #:**

|                                        |                                                               |
|----------------------------------------|---------------------------------------------------------------|
| Square Footage Range: (sq. ft)<br>to   | Number of Bedrooms:<br>1 2 3 4 5+                             |
| House Width Range: (ft)<br>to          | Number of Stories:<br>1 2 3+ Walk-out                         |
| House Depth Range: (ft)<br>to          | Attached Garage:<br>No Preference Yes No                      |
| House Plans Types:                     | Bonus Room<br>Master Bedroom on Main Floor                    |
| Number of results per page:<br>6 12 24 | <a href="#">ADVANCED SEARCH</a><br><a href="#">click here</a> |

**CLEAR**

## Garage Floor Plans



[View Garage Floor Plans](#)

- [CANADIAN HOUSE PLANS](#) GO
- [PRICE GUARANTEE](#) GO
- [BOOKMARK THIS PAGE NOW](#) GO
- [FIND A BUILDER](#) GO
- [HOME BUILDERS](#) GO

When looking for house plans, turn to one of North America's leaders in the field, Weinmaster and Associates. With a solid commitment to excellence and affordability, we have created unique residential designs, which translate into beautiful homes. We invite you to browse through our online selection of builder ready house blueprints to view the wide range of home designs available, such as Victorian, country, rancher, cottage, cabin and recreational styles, as well as duplexes and garages.

Whether you are looking for a starter house plan or an executive home plan, you can find the perfect one here. Accuracy is crucial when it comes to house design. With combined experience in the home building field, Weinmaster and Associates has a detailed knowledge of all the house building trades to create award-winning house floor plans. Our home building blueprints offer everything you will need to transform your dreams into reality. Our focus is on superior structure, efficiency and beauty.

[Canadian Search](#) | [Home](#) | [My Plans](#) | [Order Info](#) | [Contact Us](#) | [Search](#) | [Sitemap](#) | [About Us](#) | [FAQ](#) | [Links](#)

[Link To Us](#)



Copyright © 2004 Weinmaster and Associates.

All house plans and illustrations contained in this publication are the exclusive property of Weinmaster and Associates and reproduction in whole or in part is strictly prohibited by law.

All construction house plans ordered through Weinmaster and Associates are provided as-is. Weinmaster and Associates disclaims all other warranties, express or implied, including merchantability or fitness of purpose. Construction blueprints may not be returned for credit and/or refund under any circumstances. Weinmaster and Associates is not liable for incidental, special, consequential, or indirect damages of any kind, including, but not limited to, loss of anticipated profits, business opportunity, or other economic loss arising out of the use of services or any construction plans received from Weinmaster and Associates even if Weinmaster and Associates has been advised of the possibility of such damage. It is the customer's responsibility to ensure the accuracy, compliance with applicable statute or regulation, and fitness of purpose of any plans or construction information received from Weinmaster and Associates prior to use thereof. In the event any liability is imposed on Weinmaster and Associates, Weinmaster and Associate's liability to you or any third party shall not exceed the price paid for Weinmaster and Associate's product.



House Plans-Small House Plans-Home Design-Floor Plans-Custom Home Plans-House Floor Plans-House Design-New House Construction-Country House  
Plans  
[Detailed Site Map](#)

Order Toll Free 877-977-9485

Stock House Plans~Updated 08-25-04



**Rick Garner Designer**

Stock House Plans and Custom Home Design

[Plan Search](#)

[New Stock House Plans](#)

[Collections](#)

[Link Partners](#)



**Quick Search**

[Main House Plan Search](#)

[Small House Plans](#)

[House Plans 1500-2000](#)

[House Plans 2000-2499](#)

[House Plans 2500-3000](#)

[House Plans Over 3000](#)

[Garage Plans](#)

[Vacation Plans](#)

[Multi-Family Plans](#)

[Cabin Plans](#)

[New Home](#)

[Construction Information](#)



**Collections**

[Small Country Home Plans](#)

[Medium Country Home  
Plans](#)

[Large Country Home Plans](#)

[Small Traditional Home  
Plans](#)

[Medium Traditional Home  
Plans](#)

[Large Traditional Home  
Plans](#)



Click here for details on our



**[LOWEST PRICE ONLINE GUARANTEE](#)**

Scroll down for available **new** plan options!

**~Featured Floor Plan~**



**More Stock House Plans Here!**

**The Southern  
DESIGNER**

Featuring Leading Designer's Best  
Selling & New **House plans, Garage  
plans, Vacation plans, Cabin plans  
and Multifamily Plans!**

View plans in reverse with the touch of  
a button! Compare plans, view similar  
plans, view rear elevations, view  
photos, alternate elevations and more!  
Join our Client's Corner and create  
your Personalized, Printable Plan  
Book!

[The French Collection  
New House Plans!](#)



**Information**

- [About Our House Plans](#)
- [About Our Company](#)
- [Design & Order FAQ's](#)
- [What is Included](#)
- [Home Design Price Schedule](#)
- [Home Plan Modifications](#)
- [Custom Home Plans](#)
- [Home Plan Definitions](#)
- [Copyright Information](#)
- [House Plan Elevations](#)
- [Order House Floor Plans](#)
- [Contact Us](#)
- [House & Home Links](#)

**Order House Plans!**

For Information on our home designs and to Order by Phone:  
**1-877-977-9485**



**Mississippi Residents**

Visit this link for local subdivision information, builders, plans and more!

**Plan RG-1005-10**

This NEW home plan features 2 bedrooms, 1 bath, spacious living area, large bedrooms, covered front porch and more!  
**Total Living: 1042 sq. ft.**

[See More Featured Homes!](#)



*Order Your FREE Rick Garner Designer 2004 Catalog featuring new stock house plans in full color. Click here to order now!*



**Promotional Presentation Plans**

Rick Garner Designer realizes the importance of marketing and advertising newly build homes. We now offer to all builder clients Personalized Promotional Presentation Plan Sheets as a marketing tool for you to offer prospective home buyers.

Our presentation sheets can be used on the construction site for distribution to potential home buyers as well as for ads in local publications, for realtors to distribute, mail outs and much more.

For more information [click here](#).



**New Study Plans**

Our study plans are reduced versions of our complete construction plans (9x15) available for your review. A study set enables you to see the layout in more detail and to see the home from all four sides. **This plan set will be stamped "Not for Construction"** as it does not include a license to build the home. These are available for all of our designs and can be purchased by contacting our office at **877-977-9485** to place your order or you can [order online](#). **The cost of our study plans will be credited to your blueprint package order when you purchase the construction sets.**

**Plan ordering Information**

**All sales final. No Refunds~No Exchanges.** All orders ship within 24 hours of receipt. It is important that you check your lot dimensions before ordering. Be sure to order all the plan sets you will need to build your new home by using our [Blueprint Calculator](#).

**NEW Free Catalog**

Our new catalog has arrived. See many new plans in our full color publication featuring best selling and new house plans from our design gallery. To receive your FREE copy of this publication [click here](#).



PROFESSIONAL MEMBER  
**American Institute  
of Building Design**



Rick Garner is Professional Member of the AIBD, NAHB & NCBDC.  
Mr. Garner is President of the Mississippi Chapter of the American Institute of Building Design.



Order a guide to building your new home.



### Affiliate and Partner Programs

Rick Garner Designer is always happy to link to other professional and quality home related websites. If you would like to exchange links [email](#) us for consideration.

We also offer an exceptional commission program for those of you interested in offering our house plans on your website. [email](#) us for additional information.



[Vote for this site!](#)

[Custom Home Audio](#)



### We want to hear from you!

If you have ordered one of our homes before or would like to comment on our site please take a minute and [email us](#). We would like your comments for our new "Testimonials" page which we are developing for this website.

Be sure to visit our [Link Partner Page](#) for great online home resources!

## Shop Smart - Buy Wholesale

Save 30-50% buying Factory Direct! Never pay retail again!



**Kustomized Audio**



**SOUTHWEST SUPPLY** (888) 365-9709  
questions@southwestfastener.com



House and Home plan firms reviewed



Copyright 2001©, 2002©, 2003©, 2004©



**Rick Garner Designer**

370 Towne Center Blvd., Ridgeland, MS 39157

All Rights Reserved. No Section of this website may be duplicated in any way without permission from Rick Garner.

All stock house plans on this home design website are copyright protected.

**This home plan site designed and maintained by [Resinet Marketing](#)**

*"Internet Marketing Exclusively for Residential Designers"*

Warning: odbc\_prepare(): supplied argument is not a valid ODBC-Link resource in c:\inetpub\virtual\southerndesigner\lib\dbi\_odbc.php on line 62



[Shopping Cart](#)



[Shipping Status](#)

- HOME PAGE
- DESIGNER COLLECTIONS
- NEWEST PLANS
- MOST POPULAR
- GARAGE PLANS
- DESIGNER LOGIN
- EMAIL US

[About Us](#)

[How to Order](#)

[What's Included](#)

[Pricing](#)

**Clients Corner**

- [Sign Into Your Account](#)
- [Become a Member](#)
- [My Planbook](#)
- [Free Plan Catalog](#)

**Information**

- [What to Expect](#)
- [FAQ's](#)
- [Plan Modifications](#)
- [Plan Order Terms](#)
- [Planning Definitions](#)
- [Copyright Info](#)
- [Client Privacy Policy](#)

**Quick Search**

- Easy House Plan Search By Square Footage**
- [House Plans 1000-1500](#)
  - [House Plans 1501-2000](#)
  - [House Plans 2001-2500](#)
  - [House Plans 2501-3000](#)
  - [House Plans 3001-3500](#)
  - [House Plans 3501-4000](#)
  - [House Plans 4001-4500](#)
  - [House Plans 4501 and up](#)

- Easy Plan Search for House Plans By Style**
- [Country House Plans](#)
  - [Traditional House Plans](#)
  - [French House Plans](#)
  - [Acadian House Plans](#)
  - [A-Frame House Plans](#)
  - [Bungalow House Plans](#)
  - [Cape Cod House Plans](#)
  - [Colonial House Plans](#)
  - [Contemporary House Plans](#)
  - [Cottage House Plans](#)
  - [Craftsman House Plans](#)
  - [Early American House Plans](#)
  - [European House Plans](#)
  - [Florida House Plans](#)
  - [Georgian House Plans](#)
  - [Mediterranean Home Designs](#)
  - [Prairie Home Designs](#)
  - [Ranch Home Designs](#)
  - [Spanish Home Plans](#)
  - [Victorian Home Designs](#)

Sorry, your browser doesn't support Java. If it did, you would be seeing a cool applet right now... ; Msg in no java browsers

Warning: odbc\_prepare(): supplied argument is not a valid ODBC-Link resource in c:\inetpub\virtual\southerndesigner\lib\dbi\_odbc.php on line 62

**Welcome to The Southern Designer!**  
 Stock Plans Updated 08-25-04  
[Detailed Site Map](#)

Offering leading residential designs for new construction  
**-We are Designer owned and operated-**  
 You will receive the best client services and accurate information on all of our home designs.  
**-Use the search box to the right to find your new plans!-**  
**Or look to the left & scroll for easy searching options!**  
 Select house plans, garage plans, cabin plans, vacation plans & multifamily plans from leading professional designers  
**Be sure to bookmark this page!**

**Sign up for the SouthernDesigner.Com Mailing List!**  
 Receive updates on new plans & specials!

**Email Address:**



**Cabin Plans**

We are pleased to offer our newest Cabin Plan section featuring cabin plans from Great House Design. Click above to view this wonderful collection of plans!



**Garage Plans**

Looking for a garage plan? Browse our collection of great garage plans!



**Multifamily Plans**

A fine collection of duplex, apartment, townhouse & rancher plans.



**Newly Added House Plans**

New plans are featured daily on our website. Click the link above to see what's new!



**Vacation Homes**

Looking for the perfect plan for your new vacation home? Click the link above to find your new getaway!

**The Southern Designer Promise**

We offer each customer quality home designs, garage plans, vacation plans, cabin plans & multifamily plans (apartments, townhouses, duplex plans, ranchers) in an easy to view format from established, professional US and Canadian Designers & Architects. Our US Designers & Architects are professional members of the AIBD or AIA with many years of experience. We are designer owned and operated which means you are working with knowledgeable people who can easily assist you in all of your home planning questions and selections. We are also a family owned establishment which only furthers our desire to see that your home planning experience with us is professional, prompt and of exceptional service. Please let us know what you think of our website and if you have any suggestions or questions feel free to [email](#) us anytime and we will be happy to assist.

**Plan Search**

|                              |              |           |             |
|------------------------------|--------------|-----------|-------------|
| <b>Search By Plan Number</b> |              |           |             |
| <b>Square Footage Range</b>  | <b>From:</b> |           |             |
|                              | <b>To:</b>   |           |             |
| <b>Maximum Width</b>         |              |           |             |
| <b>Maximum Depth</b>         |              |           |             |
| <b>Bedrooms</b>              |              |           |             |
| <b>Bathrooms</b>             |              |           |             |
| <b>Levels</b>                |              |           |             |
| <b>Main Ceiling Height</b>   |              |           |             |
| <b>Bonus Room</b>            | <b>Yes</b>   | <b>No</b> | <b>Both</b> |
| <b>Master Bedroom</b>        |              |           |             |
| <b>Style</b>                 |              |           |             |
| <b>Reset</b>                 |              |           |             |

**Building Cost Estimates!**  
Calculate the estimated cost to  
build a plan before you buy it!

|                                                                                                                                                                                         |                                                                                                                                                              |
|-----------------------------------------------------------------------------------------------------------------------------------------------------------------------------------------|--------------------------------------------------------------------------------------------------------------------------------------------------------------|
|  <b>Our Backyard</b>  |  <b>Construction Information</b>                                            |
| Visit The Southern Designer's Backyard for links to great backyard websites! Greenhouses, play houses, gazebos, swings, sheds and more!                                                 | The Southern Designer has made arrangements to offer you professional information on new home construction, builder locators, mortgage information and more. |



100% construction loan financing to build your own home! NO down payment, NO payments while you build. Unique owner-builder program allows you to control your own home-building project. Imagine saving \$25K to \$70K on your next home-building project, you could with BuildMax. [Click Here](#)



[Vote for this site!](#)

#### Customized Audio



[Custom Home Audio](#)

#### Mississippi Residents

[Click here for new construction information](#)



[This Site Best Viewed In Internet Explorer](#)

Disclaimer: All house plans ordered through [Southerndesigner.com](#) are offered as-is and the [Southerndesigner.com](#) disclaims all other warranties, expressed or implied. Stock house plans may not be returned or exchanged under any circumstances. All sales are final. [Southerndesigner.com](#) is not liable for incidental, special, consequential, or indirect damages of any kind, including, but not limited to, loss of anticipated profits, business opportunity, or other loss arising out of the use of services or any stock plan received from [Southerndesigner.com](#). It is the responsibility of each customer to ensure the accuracy, compliance with applicable statute or regulation, and fitness of purpose of any plans or information received from [Southerndesigner.com](#) prior to the usage thereof.

House Plans ~ Garage Plans ~ Home Plans ~ Duplex Plans ~  
House Floor Plans ~ Multifamily ~ Townhouses ~ Ranchers ~  
Condos ~ Apartment Building Plans ~ Developers ~  
Builders~Architects~ Residential Designers~Builder  
Plans~Blueprints~ Housing Developers~ Residential  
Developments~ Vacation plans~ Cabin plans

All content is copyright © 2004 by The Southern Designer.  
Website design & marketing by [Resinet Marketing](#)  
All Sales Final



Click Any Link Above For Home Improvement and Home Repair Info



Community Forums

Showcases and Links

Go Shopping

Need A Contractor

Loan Center

Interactive Project + Design

Keyword Search::

Home Improvement How To's - Our "Home Improvement How-To Info and Home Repair Tips" help answer basic questions... in Do It Yourself projects. Click here on any Topic on the bottom of this page for step by step instructions and information.

Community Forums

Our Community Forums are hosted by home improvement and repair experts. They are dedicated to provide you the info you need to do any Home Repair or Home Improvement project right. Ask Questions and Get Answers! Now featuring over 100 topics of interest to DoItYourselfers!

The Do-It-Yourself Video Special

Use the best home repair tool available - knowledge to complete projects RIGHT THE FIRST TIME. Many of our home improvement articles are generated from this Classic TV Series. Save \$8.00 OFF on our most popular videos. Choose from Exterior Home Improvement Projects, Interior Home Improvement Projects, Real Estate and Home Repair Videos.

How Should You Pay for a Home Remodeling Project? With Interest Rates Still at Historic Lows, why not lock in a Low Cost Home Improvement Loan Today! Within minutes you will have lenders compete for your business.

DoItYourself.com is proud to be featured in Time Magazine's 50 Best Websites! Click here for more!

project + design TOOLS

Our founder and president recently appeared on Ask Andrea, a nationally syndicated home improvement radio show. To listen to the interview click here.



Extend Growing Seasons UV Covered Grow Racks 4 Adjustable Shelves \$89.95 Value SALE \$69.95 Freight-Free in the USA ColorSmart by Behr Coordinate and preview before you paint.

Need a Contractor? If you don't have the time to Do It Yourself, or need a bit more experience before you tackle a home improvement project, why not have it done by a prescreened, qualified contractor in your area?

Want a FREE issue of Family Handyman magazine? Click Here! For a FREE issue of American Woodworker Magazine Click Here!

Invisible Killers in the Home: Virtually everyone has one type or another of mold somewhere in their home. Although not all molds produce toxic biproducts, exposure to non-toxic mold types can pose a health risk to people with allergies or asthma. The threat doesn't stop there, other biological contaminants that can make it into your home include bacteria, mildew, viruses, pet dander, dust, mites, cockroaches, and pollen. Learn how to safeguard your home from these dangerous contaminants. Read all about in our do-it-yourself feature of the month. CLICK HERE to buy our HOME-TESTING KITS

Also This Month... How home improvement projects can pay big dividends. Find out what areas of the home give the biggest return when it comes time to sell. Click here for more...

Choose a Balmer Molding, Medallion, or Fireplace Mantel

Thinking of Buying or Selling a Home? Get Matched With Top Performing Real Estate Agents in Your Area. Free Service - No Obligation

## [Click Any Link For Home Improvement - Home Repair Info](#)

### [Interior Home Improvements](#)

[Attics](#), [Basements](#), [Bathroom Remodeling](#), [Building and Remodeling Contractors](#), [Cabinetry and Built-Ins](#), [Ceilings](#), [Ceramic Tile](#), [Doors](#), [Fireplaces and Hearths](#), [Insulation](#), [Kitchen Remodeling](#), [Lumber](#), [Paneling](#), [Skylights](#), [Walls](#), [Weatherizing](#), [Windows](#) and [Woodworking](#)

### [Exterior Home Improvements](#)

[Brick](#), [Slate and Stone](#), [Cement Concrete Stucco Clay](#), [Chimneys](#), [Decks](#), [Garages](#), [Gutters](#), [Roofing](#), [Sunrooms](#) and [Waterproofing](#)

### [Decorating and Painting](#)

[Accessories](#), [Blinds](#), [Shades and Shutters](#), [Carpeting](#), [Decorating for Children](#), [Decorating with Color](#), [Draperies and Top Treatments](#), [Faux and Texture Finishing](#), [Furniture](#), [Glass and Mirrors](#), [Holiday Decorating](#), [Interior Decorating](#), [Laminate Floors](#), [Paint Applicators and Tools](#), [Paint Preparation](#), [Painting Exteriors](#), [Painting Interiors](#), [Patching and Plastering](#), [Upholstery](#), [Vinyl Floor Coverings](#), [Wallpaper and Wallcoverings](#), [Wood Finishing](#) and [Wood Floors](#)

### [Electrical and Electronics](#)

[Accent Lighting](#), [Basic Electric](#), [Computers](#), [Home Automation](#), [Home Entertainment](#), [Home Security Alarms](#), [Lighting Exteriors](#), [Lighting Interiors](#) and [Voice and Data Communications](#)

### [Plumbing, Air and Heat](#)

[Air Conditioning](#), [Dehumidifiers and Humidifiers](#), [Drainage and Sewage](#), [Duct Work](#), [Faucets and Sinks](#), [Garbage Disposals](#), [General Plumbing](#), [Heat Pumps](#), [Heating - Electric Plus](#), [Heating - Gas and Oil](#), [Toilets](#), [Ventilation](#), [Water Filters and Conservation](#), [Water Heaters](#) and [Wells and Septic Systems](#)

### [Cars, Trucks and Boats](#)

[Auto Buying and Selling](#), [Auto Finance and Insurance](#), [Auto Maintenance and Care](#), [Auto Repair](#), [Marine](#), [Boating and Sailing](#), [Motorcycles](#), [ATV's](#), and [Go Carts](#), and [Trucks](#), [RV's](#) and [Motor Homes](#)

### [Gardens and Outdoors](#)

[Fences](#), [Fertilizer](#), [Compost and Soil](#), [Flowers](#), [Fruits](#), [Garden Maintenance](#), [Garden Projects](#), [Greenhouses](#), [Hot Tubs and Spas](#), [Lawns and Ground Cover](#), [Outdoor Living](#), [Outdoor Pest Control](#), [Outdoor Power Equipment](#), [Ponds and Water Gardens](#), [Pools](#), [Shrubs and Trees](#), [Vegetables and Herbs](#), and [Wildlife Issues](#)

### [Hardware and Tools](#)

[Fasteners](#), [Garden Tools](#), [Hand Tools](#), [Locks](#), [Power Tools](#), and [Welding and Iron Work](#)

### [Household and Cleaning](#)

[Appliances - Electric](#), [Appliances - Gas](#), [Appliances - Small](#), [Cleaning and Stain Removal](#), [Closets and Organizers](#), [Home Canning and Preserving](#), [Home Safety and Testing](#), [Indoor Pest Control](#), [Mold and Mildew Removal](#), and [Pet Care](#)

### [Lifestyle and Recreation](#)

[Bicycles](#), [Crafts and Hobbies](#), [Dieting and Weight Loss](#), [Education](#), [Employment](#), [Exercise and Fitness](#), [Food and Recipes](#), [Health](#), [Lifestyle and Living](#), [Parenting](#), [Seniors and Disabilities](#), [Sports](#), and [Travel](#)

### [Real Estate and Finance](#)

[Appraisals and Inspections](#), [Architecture Residential](#), [Banking and Credit](#), [Buying New Homes](#), [Buying Resale Homes](#), [Closing on a House](#), [Dealing with Real Estate Agents](#), [Emergency Preparedness](#), [Enjoying Your Home](#), [Finance](#), [Foreclosures](#), [Home Business and Home Office](#), [Home Equity](#), [Making Home Offers](#), [Mobile Homes](#), [Mortgages](#), [Non-Residential Architecture](#), [Refinance](#), and [Selling a House](#)

[Hardware Store](#) - [Advertising](#) - [Community Forums](#) - [Need A Contractor](#) - [Glossary](#) - [Links](#) - [Media](#)  
- [Mortgage Savings](#) - [Search Content](#) - [Site Map](#)



RELIABILITY PROGRAM

BBB

CONFIDENTIAL

DoItYourself.com® was founded in 1995 and is the leading independent home improvement website. All contents are copyrighted and DoItYourself.com is a registered trademark of DoItYourself.com Incorporated. You are welcome to view this site for your own, non-commercial purposes, AS IS, subject to our disclaimer and conditions of use. We have a strict [Privacy Policy](#) and do not share your information with outsiders. Please [subscribe to our Free Newsletter](#). You may [send this page to a friend](#).

Problems regarding the website operations should be directed to [webmaster@doityourself.com](mailto:webmaster@doityourself.com). Questions of a Do It Yourself nature, not directly related to purchasing products from DoItYourself.com should be submitted to our "[DoItYourself.com Community Forums](#)". [Would you like information about Loans, Refinance or Mortgages? Need a Pre-Qualified Local Contractor?](#)



Copyright © 1995-2004 DoItYourself.com Inc. All rights reserved. You may freely link to this site.

**Visit FreeAdvice.com For Free Legal Information - Visit AttorneyPages.com to Find an Attorney**





**CONSTRUCTION FORMS**

**HOUSE PLANS**

**CONSTRUCTION SCHEDULES**

**PHOTOS**

**ASK THE GENERAL**

### Home Building Information for the Owner-Builder

Whether you're a contractor, seasoned owner-builder or a novice, we believe that InfoforBuilding.com can provide the "tools" that you will need to succeed in any construction project.

Our goal is to help you build your home and save thousands of dollars in the process. Contracting a home involves education, preparation, organization, and most importantly determination. We have the tools to help make your project a success.

Download a FREE contractor questionnaire form in PDF format. [Download Now!](#)

**Construction Schedules**  
Download a pre-construction schedule and more!

**Construction Questions?**  
[Ask the General](#)

The general contractor that is...go ahead it's FREE!

**Photos**  
[Owner builder photos](#) from excavation to final inspection.

**Documents & Forms**  
[Construction forms & documents](#)

**Calculator/Estimator**  
[Owner Builder Calculator](#)-Calculate your saving as the project contractor.

**Owner-Builder Article:**  
["Is a hydronic baseboard heating practical today?"](#)

NEW! Customizable Schedules

NEW! Owner-Builder Calculator

### The Five Phases of Home Construction from infoforbuilding .com:

PRECONSTRUCTION

» START HERE

PHASE

**1**

PHASE

**2**

PHASE

**3**

PHASE

**4**

PHASE

**5**

### Construction Forms and Documents

Manage you project like a professional construction manager. Our **Professional Series Construction Documents™** (PSCD) are used by builders and home owners throughout the industry. They have been developed by legal and construction management professionals and are updated regularly to meet today's changing construction environment.

Our documents can be purchased separately or in packages. We have combined our documents into packages to provide the best value and to meet the varying needs of owner-builders, homeowners and contractors. We also have **free** forms and construction calculators to help with different aspects of your project.

### Instant download!

Forms and packages that are purchased by credit card are automatically emailed to you for instant download.



Accepted through **Paypal™**, the most reliable online payment service available.



"A proud member of the Better Business Bureau"

In order to facilitate quick downloads the forms have been zipped and require WinZip™ utility to open. WinZip™ can be downloaded for free at [www.winzip.com](http://www.winzip.com)

### Document Formats

Our forms are saved in .pdf, MS Excel, Quattro Pro, and .doc format. The legal agreements and lien waivers are in .doc format so that they can be customized. The calculators are Excel or Quattro pro format. PDF files require Adobe Acrobat Reader™ [click here for free download.](#)

How to hire a Contractor  
This practical [article](#) tells how to find a contractor for your project.

Construction Dictionary  
visit our online [construction dictionary](#).



This package contains the basics to manage your project. The Basic package is best suited to owner-builders with some construction management experience who understand subcontractor sequencing, construction costs and construction methods. Click on each document for a sample view and complete description. The following are included:

- [Description of materials](#)
- [Subcontractor agreement](#)
- [Release of lien forms](#)

Basic Owner-builder package-\$**24.95** save \$8 over individually purchased items.

**Individual Form**

[Construction Schedule](#)

[New Home Inspection List](#)

[Release of Lien Forms](#)

[Description of Materials](#)

[Owner-Builder Calculator](#)

[Subcontractor Agreement](#)

[Owner/Contractor Agreement](#)

[Contract Change Order](#)

[Certificate of Substantial Completion](#)

[Daily Construction Site Report](#)



The Standard Owner-builder package contains all the items in the Basic owner-builder package plus:

- [Construction schedule](#)

Standard Owner-builder package-\$**34.95** save \$19 over individually purchased items.

**FREE DOWNLOADS!**

Contractor Questionnaire  
Are you trying to find the right contractor but don't know what questions to ask? Here are the questions...and the right answers.  
[Contractor Questionnaire in PDF](#)

Concrete Estimator  
Download our free flatwork estimator. It is an in-depth calculator great for estimating driveways, sidewalks, patios, and basement slabs. It's available in Quattro Pro and Excel. Enjoy!  
[Concrete estimator-Excel](#)  
[Concrete estimator-Quattro Pro](#)

Pre-Construction Schedule  
Here is a pre-construction schedule



The Deluxe Owner-builder package contains all the items in the Standard owner-builder package plus:

- [Owner-builder calculator](#)
- [Contract Change Order](#)
- [Daily Construction Site Report NEW!](#)

Deluxe Owner-builder package-\$**49.95** save \$36 over individually purchased items.

in bar chart form (Gantt). It shows all of the items that must be complete before you can start the onsite building process.

[Download in PDF](#)

Footing and Foundation Estimator  
Download our free footing estimator. It is an in-depth calculator great for estimating footings or foundation walls. It is available in MS Excel. Have Fun!

Foundation estimator-Excel  
[Footing Estimator-Excel](#)



The Basic Builder package is designed for owners who plan to hire a contractor to build their home. It contains the following items:

- [Owner/contractor agreement](#)
- [Description of materials](#)
- [New home Inspection list](#)

Basic Builder package-\$**29.95** save \$20 over individually purchased items.

Home Building Links  
Resources for the Owner Builder

[Linkspage](#) - links to great information on other construction sites.

[Home plans](#)

[Learn about Scheduling](#)

Alternative Building Links  
Links and information to interesting and alternative building methods:

[Straw bale](#)

[Earthship](#)

[Adobe](#)

[Insulated concrete](#)

[Domes](#)

[Log homes](#)

[Steel buildings](#)

Design Help  
Information about the important elements of your home

[Kitchens & baths](#)

[Decks & patios](#)

[Greenhouses & outbuildings](#)



The Standard Builder package contains the items in the Basic builder package plus:  
- [Construction schedule](#)

Standard Builder package-\$**39.95** save \$26 over individually purchased items.



The Deluxe Builder package contains the items in the Standard builder package plus:  
- [Contract Change Order](#) **NEW!**  
- [Certificate of Substantial Completion](#) **NEW!**

Deluxe Builder package-\$**49.95** save \$36 over individually purchased items.

For technical problems or questions regarding this site please contact the [webmaster](#)

[100% Risk Free](#) | [Ordering](#) | [Security & Privacy](#) | [Contact Us](#) | [Shipping](#) | [FAQ](#)  
[Construction Forms](#) | [House Plans](#) | [Construction Schedules](#) | [Photos](#) | [Ask the General](#)

Copyright © 1999-2004 infoforBuilding.com. All rights reserved.



You searched the web for **Plastic Skylights**

Top ten bidded listings are below

### [AIA Industires Skylights](#)

AIA manufactures plastic dome skylights in any size, and will sell direct.

[www.aiaindustries.com...](http://www.aiaindustries.com...)

### [Replacement Skylight & Dome Manufacturer](#)

Acrylic & polycarbonate domed skylights for residential & commercial. Round, square, circular, rectangular & custom shaped plastic skylights. Available in clear, tinted or translucent white.

[www.globalplastics.ca...](http://www.globalplastics.ca...)

### [Plastic Dome Tubular Skylight by Velux](#)

Sun Tunnel Flexible Tubular skylight systems are industry leaders in natural indoor lighting. Installs in as little as two hours. In stock, ready to ship.

[www.bigfrogmountain.com...](http://www.bigfrogmountain.com...)

### [Duo-Gard - Plastic Skylights](#)

Design/Build skylights integrate natural light, advanced translucent technology, aesthetics, economy for high performance in new and existing facilities. Windows, walls, canopies, walkways.

[www.duo-gard.com...](http://www.duo-gard.com...)

### [Get a Quote On Any Construction Material](#)

Over 3,000 pages of current labor and material costs for construction. Search by keyword through the largest construction cost estimating database on the Web, including plastic skylight.

[www.get-a-quote.net...](http://www.get-a-quote.net...)

### [Find Plastic Skylights with Free WebSearch Tools](#)

Click here to download WebSearch Tools and search 15 engines for Plastic Skylights at once now with FREE Pop-up Blocker, Yellow/White Pages, Free Games, Maps, Skins, Cursors and more!

[download.websearch.com...](http://download.websearch.com...)

### [Find Plastic Skylights on Crawler.com with Free WebSearch Tools](#)

Click here to download WebSearch Tools and search 15 engines for Plastic Skylights at once now with FREE Pop-up Blocker, Yellow/White Pages, Free Games, Maps, Skins, Cursors and more!

[download.websearch.com...](http://download.websearch.com...)

### [Find Plastic Skylights on 2020Search.com](#)

If youre having trouble finding Plastic Skylights here, 2020Search provides relevant results from the top search engines on the internet. Your result is a click away at 2020Search.com.

[ws1.2020search.com...](http://ws1.2020search.com...)

### [Find Plastic Skylights at UpSpiral.com](#)

Having trouble finding information on Plastic Skylights?UpSpiral will provide you with the results you are looking for by drawing on the best search engines the Internet has to offer.

[www.upspiral.com...](http://www.upspiral.com...)

### [Find the Best Sites For Plastic Skylights With Starware](#)

Starware search is an excellent resource for quality sites on Plastic Skylights and much more! Starware also provides related listings for Plastic Skylights.

<http://search.starware.com/search.php?product=gsea...>

### [Payday Loans](#)

[Get your money now, deposited directly into your checking account. Your job is your credit.](#)

[Click here](#)

[Previous 10](#) -- [Next 10](#)

[Click to learn more about Plastic Skylights](#)

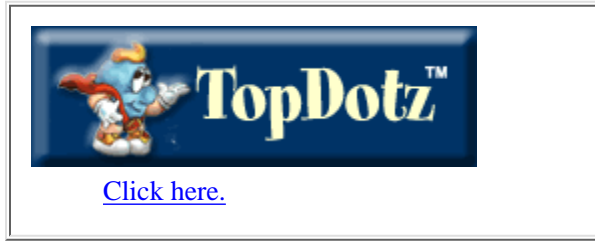

---

[CONTACT US](#)



MAZE NAILS • INDEPENDENT NAIL • TREMONT NAIL



The World's Largest Variety of Specialty Nails!

[MAZE NEWS](#)

[FREE CATALOG](#)

[MAZE DEALER LOCATOR](#)

[CONTACT US](#)

[LINKS](#)

[GUESTBOOK](#)

Hot-Dipped Galvanized  
Specification Sheets

[click here](#)



Click Here to See  
our **NEW Video**  
presentation!

What To Do For ACQ

[click here](#)



The "MAZE GROUP" is comprised of three well-known U.S. nail mills - with more than 400 years of combined experience in nail manufacturing. The "Maze Group" of nail mills makes all sorts of popular **SPECIALTY NAILS!** Come by all of our sites to get more specific information on our wide line of MADE-IN-USA nails, fasteners and screws.



- **MAZE NAILS:** Peru, Illinois - 800-435-5949 ~ Established in 1848. eMail: [mazenails@MazeNails.com](mailto:mazenails@MazeNails.com)
- **INDEPENDENT NAILS:** Taunton, Massachusetts - 800-443-1966 ~ Established in 1915. eMail: [independent@MazeNails.com](mailto:independent@MazeNails.com)
- **TREMONT NAIL:** Wareham, Massachusetts - 800-842-0560 ~ Established in 1819.

**NEW!** [Tremont Nail Online Store](#)

eMail: [tremont@MazeNails.com](mailto:tremont@MazeNails.com)



... **LIFETIME WARRANTY** ...

Would you like us to eMail you when we update [www.MazeNails.com](http://www.MazeNails.com)?

Fill in your eMail address, click on "Watch this site for me "  
and we will send you an eMail when our site is updated.

We will not send you any promotional eMail or broker it. Since this is  
automated,

please **ONLY** enter your eMail address, nothing else (eg:  
[username@domain.com](mailto:username@domain.com)):

Your eMail address:



**MAZE NAILS**

Copyright © 1995-2004. All Rights Reserved.

**W.H. MAZE COMPANY**  
P.O. Box 449  
Peru, Illinois 61354  
Phone: 800-435-5949  
Fax: 815-223-7585  
eMail: [info@MazeNails.com](mailto:info@MazeNails.com)

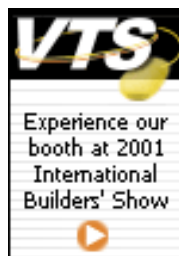

Hosted by :  
**BuildingOnline**  
Where the Building Industry  
is Found on the Internet!



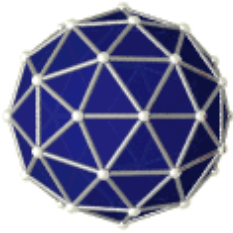

# *Applied Synergetics*

[Home](#)

[About](#)

[News](#)

[Products](#)

[Services](#)

[Projects](#)

[Research](#)

[Web Hosting](#)

[Open Source](#)

[FAQ](#)

## Welcome to Applied Synergetics

Applied Synergetics is dedicated to the development of technological solutions to problems encountered in a wide array of fields and industries.

This website is currently under construction so please check back often as information on our products and services will be added continuously.

Copyright (c) 2002 - Applied Synergetics. All Rights Reserved

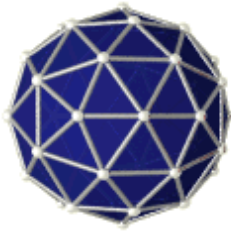

# Applied Synergetics

[Geodesic Domes](#)[Download WinDome 4.80](#)[WinDome Readme](#)[Download DOME for Linux](#)[DOME for Linux Readme](#)[Download Console DOME](#)[Console DOME Readme](#)[Povray Dome Gallery](#)[VRML Dome Gallery](#)[Geodesic Dome Resources](#)[Design Science University](#)[Add to Guestbook](#)[View Guestbook](#)[Discussion Forum](#)[News](#)[FAQ](#)[Design Science Workshop](#)

## Geodesic Dome Design

### WinDome

Version 4.80  
October 8, 2002

---

### What is DOME?

DOME is a program which calculates the properties of a geodesic dome symmetry triangle. DOME calculates spherical vertex coordinates, symmetry triangle topological abundance, and chord factors. DOME supports class I (alternate) and class II (triacon) breakdowns for Icosahedron, Octahedron and Tetrahedron polyhedron types. DOME also supports "Buckyball" formations as well as elliptical geodesics and geodesic parabolic dishes.

---

### Why DOME?

WinDome is a Windows version of the original command-line DOME program. DOME began as a set of geodesic math test algorithms for use in investigating properties of generalized geodesic structures. This continues to be the main purpose of my development of the DOME code. DOME should serve as a basic tool for those interested in geodesic dome design and modeling. All source code is also included in this package and is freely modifiable under the conditions of the [GNU General Public License](#).

---

### System Requirements

WinDome has been compiled using Microsoft Visual C++ 5.0 as a 32-bit MFC application. WinDome will should run fine in Windows 95, 98, ME, NT, 2000 or XP. Dome frequency is limited by the amount of memory available. WinDome 4.80 is in Beta.

---

### Changes From Previous Release Version 4.60

- Added parabolic dish functions
  - Rewrote several functions into modules.
  - Added Windows GUI front-end.
  - Upgraded VRML output to the VRML97 specification
-

## Installation

WinDome has been compiled statically so that it is a self-contained program. Simply create a folder called WinDome and copy the WinDome.exe file into it. You can then create a shortcut to access the program at your convenience.

---

## Usage

Select the Dome properties, specify a file name and press "Execute".

---

## File Formats

DOME currently supports five file formats:

- DXF - DXF face data which can be input into most computer aided design packages. Each polyhedron face is saved on a separate level if spherical data generation is requested. DXF data for Buckyballs are saved as LINE data. The default DXF data for all other structures is 3D POLYFACE data. This can be changed to LINE data with the -w option. Note that not all applications support DXF line data. In these cases, use polyface instead.
  - DAT - An ASCII report format. Shows only symmetry triangle parameters. This format displays chord factors, face angles and axial angles. Not available for Buckyballs.
  - PRN - An ASCII comma delimited format. Contains vertex coordinate and chord coordinate data. Suitable for parsing into custom routines and spreadsheets. Only data for the symmetry triangle is saved. Not available for Buckyballs.
  - POV - POV-ray script file. Generates spheres for vertexia, cylinders for chords and triangles for faces. Faces are not saved when using the Buckyball option. The POV script consists of two files. The .POV file contains the scene description while the dome.inc file contains the dome geometry. Note that DOME references "up" as the z-axis while POV references the y-axis. The Sky statement in the camera definition compensates for this.
  - WRL - VRML file for use with a VRML enabled browser such as the Cortona plugin from ParallelGraphics. Only wire-frame output is available with Buckyball option. WinDome supports the VRML97 Specification.
- 

## Elliptical Structures

DOME allows the creation of elliptical geodesic structures. The -en switch enables this feature. The "n" parameter is the elliptical eccentricity. This value is simply the ratio of the ellipse major axis to ellipse minor axis. A circle has an eccentricity of 1.0. Dome allows eccentricity values greater than 0.0 but less than 2.0. An eccentricity less than 1.0 results in an ellipse having a semimajor axis = 1.0 and aligned along the x-axis. Likewise, an eccentricity greater than 1.0 results in an ellipse having a semiminor axis = 1.0 and major axis aligned along the z-axis.

---

## Parabolic Structures

WinDome now includes functions which allow the design of geodesic parabolic dishes. Select the parabolic radio button and then specify the focus and radius of the dish.

The parabolic functions work with:

- Class I or Class II geodesic
- All supported polyhedron types.

The following restrictions apply to the use of parabolics:

- A DXF filename must be included with the parabolic switches.
- The -w wireframe option should not be used.
- The ratio of focal length to dish diameter (f/d) must be greater than or equal 0.25.
- No other output file type aside from the 3DFACE DXF file is supported at this time.
- Frequency is based on a spherical formation. Large values of f/d will reduce the number of faces used in the structure. Compensate by further increasing the frequency.

WinDome produces a DXF file containing the dish face data and an ASCII text file named parabolic.txt containing the raw data for each face. The following data is output:

- Index data for each triangle vertex (A, B, C see map.gif)
- Chord lengths for each triangle side (a, b, c)
- Face angles (A, B, C).

This data is given for each polyhedron face. In the case of the class I icosahedron 20 faces will be output. The class II structure will use up to 60 triangles. Many of these faces may not contain data as this is dependent on the truncation used.

The enclosed file map.gif contains a graphical representation one polyhedron face as well as the nomenclature used for each triangle.

The units used for the focus location will determine the units of chord length. If -d6 is used where 6 is the focal length in feet, then the chord lengths will be output in feet as well.

The parabolic.txt file is designed to be read by a spreadsheet application such as Microsoft Excel. When importing this file into a spreadsheet, set the field delimiter to 'tab', the text delimiter to '"' and make sure that the first three columns are read as text fields.

---

## Other Goodies

See the [Applied Synergetics Homepage](#) for image samples and links to other Synergetics Web sites. The latest WinDome & DOME info can be found [here](#).

---

## Other Platforms

Check the DOME web page for versions which support other platforms.

---

## UNIX Portability

Several defines have now been added to the DOME & DXFtoPOV source code to allow porting to UNIX machines. A Unix/LINUX makefile developed by Chris

Fearnley has now been included to improve g++ compilation.

---

## Source Code Comments

Releases of DOME prior to 4.0 had all the source code in one file. DOME 4.60 has the source code split across several files:

Releases of DOME prior to 4.0 had all the source code in one file. DOME & WinDome 4.80 has the source code split across several files:

- dome.txt - this file
- dome.cpp - Source code for main program loop.
- geodesic.h - Header file containing variables, structures and class member function prototypes.
- geodesic.cpp - Source code for geodesic class member functions. Most of the work is done by these routines.
- dxfsave.cpp - Geodesic class DXF save routines.
- povsave.cpp - Geodesic class POV save routines.
- wrlsave.cpp - Geodesic class WRL (VRML) save routines.
- cartesian.cpp - cartesian & spherical coordinate conversion & data structures
- cartesian.h - header for cartesian.cpp
- chords.cpp - class containing chord data structures
- chords.h - header for chord.cpp
- command.cpp - class implementing input parameter data structures
- command.h - header for command.cpp
- faces.cpp - class containing triangle face data structures
- faces.h - header for faces.cpp
- labels.cpp - class containing vertex label data structures
- labels.h - header for labels.cpp
- points.cpp - class containing vertex position data structures
- points.h - header for points.cpp
- ThetaTruncation.cpp - class for collecting truncation data
- ThetaTruncation.h - header for ThetaTruncation.cpp

WinDome also includes the Visual C++ 5.0 project files for the GUI.

---

## DOMÉ Updates

The next major release of DOME will include:

- Provide Buckyball topological abundance in reports
- Buckyball face data
- Dihedral Face Angles

- INI file input for customizing POV-ray and other settings.
- Enhanced non-spherical support
- Space frame support
- Graphical Display

Feel free to contact me at [rjbono@applied-synergetics.com](mailto:rjbono@applied-synergetics.com) for suggestions, bug reports or questions.

---

## Copyright Information

DOMe 4.80 Beta 1, Copyright (C) 1995 - 2002 Richard J. Bono This program is free software; you can redistribute it and/or modify it under the terms of the GNU General Public License as published by the Free Software Foundation; either version 2 of the License, or any later version. This program is distributed in the hope that it will be useful, but WITHOUT ANY WARRANTY; without even the implied warranty of MERCHANTABILITY or FITNESS FOR A PARTICULAR PURPOSE. See the GNU General Public License for more details. You should have received a copy of the GNU General Public License along with this program; if not, write to the Free Software Foundation, Inc., 675 Mass Ave, Cambridge, MA 02139, USA. Please direct inquiries, comments and modifications to:

[Richard J. Bono](mailto:rjbono@applied-synergetics.com)  
44 Augusta Rd.  
Brownsville, TX 78521

email: [rjbono@applied-synergetics.com](mailto:rjbono@applied-synergetics.com)

---

## Acknowledgements & References

The main reference used in the creation of this code was: "Geodesic Math & How to Use It" by Hugh Kenner, 1976, University of California Press. ISBN 0-520-02924-0; Library of Congress Catalog Card Number: 74-27292. Many thanks to Hugh for putting this data in an accessible format. Also, many thanks to:

- Dr. J. F. (Jym) Nystrom for turning me on to Bucky back in the summer of 1984.
  - My wife and daughters for their de-finite patience.
  - Chris Fearnley for pushing me to release this code, providing uploading tips, general comments, GNU POV scripts and UNIX/LINUX make files.
  - Kirby Urner for introducing me to POV-ray and for providing DOMe with a home in cyberspace.
  - R. Buckminster Fuller for changing the way I view Universe.
- 

[Back to DOMe page](#)

Contact [Rick Bono](mailto:rjbono@applied-synergetics.com) at: [rjbono@applied-synergetics.com](mailto:rjbono@applied-synergetics.com)



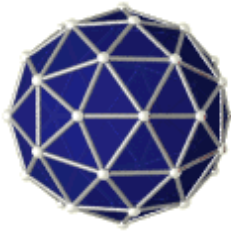

# Applied Synergetics

[Geodesic Domes](#)[Download WinDome 4.80](#)[WinDome Readme](#)[Download DOME for Linux](#)[DOME for Linux Readme](#)[Download Console DOME](#)[Console DOME Readme](#)[Povray Dome Gallery](#)[VRML Dome Gallery](#)[Geodesic Dome Resources](#)[Design Science University](#)[Add to Guestbook](#)[View Guestbook](#)[Discussion Forum](#)[News](#)[FAQ](#)[Design Science Workshop](#)

## Geodesic Dome Design

### Dome

Version 4.80  
October 8, 2002

---

### What is DOME?

DOME is a program which calculates the properties of a geodesic dome symmetry triangle. DOME calculates spherical vertex coordinates, symmetry triangle topological abundance, and chord factors. DOME supports class I (alternate) and class II (triacon) breakdowns for Icosahedron, Octahedron and Tetrahedron polyhedron types. DOME also supports "Buckyball" formations as well as elliptical geodesics & geodesic parabolic dishes.

---

### Why DOME?

DOME began as a set of geodesic math test algorithms for use in investigating properties of generalized geodesic structures. This continues to be the main purpose of my development of the DOME code. DOME should serve as a basic tool for those interested in geodesic dome design and modeling. All source code is also included in this package and is freely modifiable under the conditions of the [GNU General Public License](#).

---

### System Requirements

Dome frequency is limited by the amount of memory available.

---

### Changes From Previous Release Version 4.60

- Rewrote several functions into modules.
- Added Windows GUI front-end.
- Upgraded VRML output to the VRML97 specification

---

### Usage

DOME is run as a console application. The program will terminate with an error message if there is not enough memory to allocate array space for the coordinate matrix. If this occurs, re-run DOME and request a smaller subdivision frequency.

Only even frequencies are allowed when using class II.

**Usage: dome [-fnnn] [-cn] [-px] [-s or -sb] [-en] [-v] [-w] [-h] [filename.xxx]**

**Where: -fnnn is geodesic frequency (default nnn=2) -cn is class type (n=1 or 2; default n=1) -px sets the polyhedron type where x is: i for icosahedron (default) o for octahedron t for tetrahedron -s generate full sphere data (default: symmetry triangle) -sb generate a buckyball. Must use class I with frequency equal to a multiple of three. -en enable elliptical formation (default: n=1 circle) n=elliptical eccentricity (n > 0.0 and n &lt; 2.0) -v verbose data display at run-time -dn enables paraboloid and specifies focus location -rn sets Outer radius of paraboloid. -w enable wire-frame VRML or DXF output (default: face data) -h displays a help screen filename.xxx is a standard DOS filename where xxx is: DXF, DAT, WRL, POV or PRN**

---

#### Examples of Usage

- A 5 frequency, class I, icosahedron sphere in DXF format (note class I & icosahedron are the defaults): dome -f5 myfile.dxf
- A 3 frequency buckyball in POV format: dome -f3 -sb myfile.pov
- A 10 frequency, class II, octahedron symmetry triangle in DXF format:

dome -f10 -c2 -po myfile.dxf

---

## File Formats

DOMe currently supports five file formats:

- DXF - DXF face data which can be input into most computer aided design packages. Each polyhedron face is saved on a separate level if spherical data generation is requested. DXF data for Buckyballs are saved as LINE data. The default DXF data for all other structures is 3D POLYFACE data. This can be changed to LINE data with the -w option. Note that not all applications support DXF line data. In these cases, use polyface instead.
  - DAT - An ASCII report format. Shows only symmetry triangle parameters. This format displays chord factors, face angles and axial angles. Not available for Buckyballs.
  - PRN - An ASCII comma delimited format. Contains vertex coordinate and chord coordinate data. Suitable for parsing into custom routines and spreadsheets. Only data for the symmetry triangle is saved. Not available for Buckyballs.
  - POV - POV-ray script file. Generates spheres for vertexia, cylinders for chords and triangles for faces. Faces are not saved when using the Buckyball option. The POV script consists of two files. The .POV file contains the scene description while the dome.inc file contains the dome geometry. Note that DOMe references "up" as the z-axis while POV references the y-axis. The Sky statement in the camera definition compensates for this.
  - WRL - VRML file for use with a VRML enabled browser such as the Cortona plugin from ParallelGraphics. Only wire-frame output is available with Buckyball option. WinDome supports the VRML97 Specification.
-



## Elliptical Structures

DOME allows the creation of elliptical geodesic structures. The -en switch enables this feature. The "n" parameter is the elliptical eccentricity. This value is simply the ratio of the ellipse major axis to ellipse minor axis. A circle has an eccentricity of 1.0.

Dome allows eccentricity values greater than 0.0 but less than 2.0. An eccentricity less than 1.0 results in an ellipse having a semimajor axis = 1.0 and aligned along the x-axis. Likewise, an eccentricity greater than results in an ellipse having a semiminor axis = 1.0 and major axis aligned along the z-axis.

---

## Parabolic Structures

Dome now includes functions which allow the design of geodesic parabolic dishes. Two command line switches have been added to enable parabolics:

- dn where n = the distance from the dish center to the focus.
- rn Where n = the radius of the dish. This defaults to 2 x focus.

The parabolic functions work with:

- Class I or Class II geodesic
- All supported polyhedron types.

The following restrictions apply to the use of parabolics:

- A DXF filename must be included with the parabolic switches.
- The -w wireframe option should not be used.
- The ratio of focal length to dish diameter (f/d) must be greater than or equal 0.25.
- No other output file type aside from the 3DFACE DXF file is supported at this time.
- Frequency is based on a spherical formation. Large values of f/d will reduce the number of faces used in the structure. Compensate by further increasing the frequency.

Dome produces a DXF file containing the dish face data and an ASCII text file named parabolic.txt containing the raw data for each face. The following data is output:

- Index data for each triangle vertex (A, B, C see map.gif)
- Chord lengths for each triangle side (a, b, c)
- Face angles (A, B, C).

This data is given for each polyhedron face. In the case of the class I icosahedron 20 faces will be output. The class II structure will use up to 60 triangles. Many of these faces may not contain data as this is dependent on the truncation used.

The enclosed file map.gif contains a graphical representation one polyhedron face as well as the nomenclature used for each triangle.

The units used for the focus location will determine the units of chord length. If -d6 is used where 6 is the focal length in feet, then the chord lengths will be output in feet as well.

The parabolic.txt file is designed to be read by a spreadsheet application such as Microsoft Excel. When importing this file into a spreadsheet, set the field delimiter to

'tab', the text delimiter to '"' and make sure that the first three columns are read as text fields.

---

## Other Goodies

See the [Applied Synergetics Homepage](#) for image samples and links to other Synergetics Web sites. The latest DOME info can be found [here](#).

DXFtoPOV is a short utility which converts DXF line entities to POV-ray script. This is useful when using a CAD program to modify a DXF file. The modified DXF file can then be rendered using POV-ray. See the source code for more implementation comments.

---

## Unix/Linux Install

Open the tarball and type make to build the dome executable. Change directory to dxftopov and type make to build the dxftopov utility.

---

## Other Platforms

Check the DOME web page for versions which support other platforms.

---

## Source Code Comments

Releases of DOME prior to 4.0 had all the source code in one file. DOME 4.60 has the source code split across several files:

- dome.txt - this file
- dome.cpp - Source code for main program loop.
- geodesic.h - Header file containing variables, structures and class member function prototypes.
- geodesic.cpp - Source code for geodesic class member functions. Most of the work is done by these routines.
- dxfsave.cpp - Geodesic class DXF save routines.
- povsave.cpp - Geodesic class POV save routines.
- wrlsave.cpp - Geodesic class WRL (VRML) save routines.
- cartesian.cpp - cartesian & spherical coordinate conversion & data structures
- cartesian.h - header for cartesian.cpp
- chords.cpp - class containing chord data structures
- chords.h - header for chord.cpp
- command.cpp - class implementing input parameter data structures
- command.h - header for command.cpp
- faces.cpp - class containing triangle face data structures
- faces.h - header for faces.cpp
- labels.cpp - class containing vertex label data structures

- labels.h - header for labels.cpp
  - points.cpp - class containing vertex position data structures
  - points.h - header for points.cpp
  - ThetaTruncation.cpp - class for collecting truncation data
  - ThetaTruncation.h - header for ThetaTruncation.cpp
- 

## DOME Updates

The next major release of DOME will include:

- Provide Buckyball topological abundance in reports
- Buckyball face data
- Dihedral Face Angles
- INI file input for customizing POV-ray and other settings.
- Enhanced non-spherical support
- Space frame support
- Graphical Display

Feel free to contact me at [rjbono@applied-synergetics.com](mailto:rjbono@applied-synergetics.com) for suggestions, bug reports or questions.

---

## Copyright Information

DOME 4.80 Beta 1, Copyright (C) 1995 - 2002 Richard J. Bono This program is free software; you can redistribute it and/or modify it under the terms of the GNU General Public License as published by the Free Software Foundation; either version 2 of the License, or any later version. This program is distributed in the hope that it will be useful, but WITHOUT ANY WARRANTY; without even the implied warranty of MERCHANTABILITY or FITNESS FOR A PARTICULAR PURPOSE. See the GNU General Public License for more details. You should have received a copy of the GNU General Public License along with this program; if not, write to the Free Software Foundation, Inc., 675 Mass Ave, Cambridge, MA 02139, USA. Please direct inquiries, comments and modifications to:

[Richard J. Bono](mailto:rjbono@applied-synergetics.com)  
44 Augusta Rd.  
Brownsville, TX 78521

email: [rjbono@applied-synergetics.com](mailto:rjbono@applied-synergetics.com)

---

## Acknowledgements & References

The main reference used in the creation of this code was: "Geodesic Math & How to Use It" by Hugh Kenner, 1976, University of California Press. ISBN 0-520-02924-0; Library of Congress Catalog Card Number: 74-27292. Many thanks to Hugh for putting this data in an accessible format. Also, many thanks to:

- Dr. J. F. (Jym) Nystrom for turning me on to Bucky back in the summer of 1984.
- My wife and daughters for their de-finite patience.

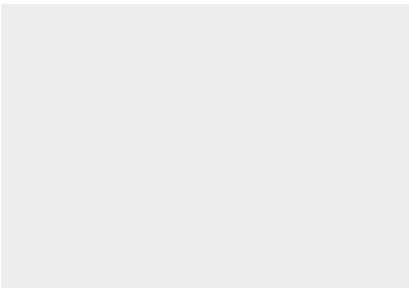

- Chris Fearnley for pushing me to release this code, providing uploading tips, general comments, GNU POV scripts and UNIX/LINUX make files.
- Kirby Urner for introducing me to POV-ray and for providing DOME with a home in cyberspace.
- R. Buckminster Fuller for changing the way I view Universe.

---

[Back to DOME page](#)

---

Contact [Rick Bono](#) at: [rjbono@applied-synergetics.com](mailto:rjbono@applied-synergetics.com)



Copyright (c) 2002 - Applied Synergetics. All Rights Reserved

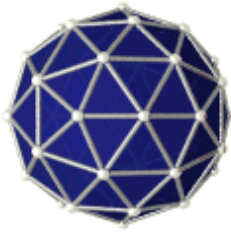

# Applied Synergetics

[Geodesic Domes](#)[Download WinDome 4.80](#)[WinDome Readme](#)[Download DOME for Linux](#)[DOME for Linux Readme](#)[Download Console DOME](#)[Console DOME Readme](#)[Povray Dome Gallery](#)[VRML Dome Gallery](#)[Geodesic Dome Resources](#)[Design Science University](#)[Add to Guestbook](#)[View Guestbook](#)[Discussion Forum](#)[News](#)[FAQ](#)[Design Science Workshop](#)

## Geodesic Dome Design

### Dome

Version 4.80  
October 8, 2002

---

### What is DOME?

DOME is a program which calculates the properties of a geodesic dome symmetry triangle. DOME calculates spherical vertex coordinates, symmetry triangle topological abundance, and chord factors. DOME supports class I (alternate) and class II (triacon) breakdowns for Icosahedron, Octahedron and Tetrahedron polyhedron types. DOME also supports "Buckyball" formations as well as elliptical geodesics & geodesic parabolic dishes.

---

### Why DOME?

DOME began as a set of geodesic math test algorithms for use in investigating properties of generalized geodesic structures. This continues to be the main purpose of my development of the DOME code. DOME should serve as a basic tool for those interested in geodesic dome design and modeling. All source code is also included in this package and is freely modifiable under the conditions of the [GNU General Public License](#).

---

### System Requirements

Dome frequency is limited by the amount of memory available.

---

### Changes From Previous Release Version 4.60

- Rewrote several functions into modules.
- Added Windows GUI front-end.
- Upgraded VRML output to the VRML97 specification

---

### Usage

DOME is run as a console application. The program will terminate with an error message if there is not enough memory to allocate array space for the coordinate matrix. If this occurs, re-run DOME and request a smaller subdivision frequency.

Only even frequencies are allowed when using class II.

**Usage: dome [-fnnn] [-cn] [-px] [-s or -sb] [-en] [-v] [-w] [-h] [filename.xxx]**

**Where: -fnnn is geodesic frequency (default nnn=2) -cn is class type (n=1 or 2; default n=1) -px sets the polyhedron type where x is: i for icosahedron (default) o for octahedron t for tetrahedron -s generate full sphere data (default: symmetry triangle) -sb generate a buckyball. Must use class I with frequency equal to a multiple of three. -en enable elliptical formation (default: n=1 circle) n=elliptical eccentricity (n > 0.0 and n &lt; 2.0) -v verbose data display at run-time -dn enables paraboloid and specifies focus location -rn sets Outer radius of paraboloid. -w enable wire-frame VRML or DXF output (default: face data) -h displays a help screen filename.xxx is a standard DOS filename where xxx is: DXF, DAT, WRL, POV or PRN**

---

#### Examples of Usage

- A 5 frequency, class I, icosahedron sphere in DXF format (note class I & icosahedron are the defaults): dome -f5 myfile.dxf
- A 3 frequency buckyball in POV format: dome -f3 -sb myfile.pov
- A 10 frequency, class II, octahedron symmetry triangle in DXF format:

dome -f10 -c2 -po myfile.dxf

---

## File Formats

DOMe currently supports five file formats:

- DXF - DXF face data which can be input into most computer aided design packages. Each polyhedron face is saved on a separate level if spherical data generation is requested. DXF data for Buckyballs are saved as LINE data. The default DXF data for all other structures is 3D POLYFACE data. This can be changed to LINE data with the -w option. Note that not all applications support DXF line data. In these cases, use polyface instead.
  - DAT - An ASCII report format. Shows only symmetry triangle parameters. This format displays chord factors, face angles and axial angles. Not available for Buckyballs.
  - PRN - An ASCII comma delimited format. Contains vertex coordinate and chord coordinate data. Suitable for parsing into custom routines and spreadsheets. Only data for the symmetry triangle is saved. Not available for Buckyballs.
  - POV - POV-ray script file. Generates spheres for vertexia, cylinders for chords and triangles for faces. Faces are not saved when using the Buckyball option. The POV script consists of two files. The .POV file contains the scene description while the dome.inc file contains the dome geometry. Note that DOMe references "up" as the z-axis while POV references the y-axis. The Sky statement in the camera definition compensates for this.
  - WRL - VRML file for use with a VRML enabled browser such as the Cortona plugin from ParallelGraphics. Only wire-frame output is available with Buckyball option. WinDome supports the VRML97 Specification.
-

## Elliptical Structures

DOME allows the creation of elliptical geodesic structures. The -en switch enables this feature. The "n" parameter is the elliptical eccentricity. This value is simply the ratio of the ellipse major axis to ellipse minor axis. A circle has an eccentricity of 1.0.

Dome allows eccentricity values greater than 0.0 but less than 2.0. An eccentricity less than 1.0 results in an ellipse having a semimajor axis = 1.0 and aligned along the x-axis. Likewise, an eccentricity greater than results in an ellipse having a semiminor axis = 1.0 and major axis aligned along the z-axis.

---

## Parabolic Structures

Dome now includes functions which allow the design of geodesic parabolic dishes. Two command line switches have been added to enable parabolics:

- dn where n = the distance from the dish center to the focus.
- rn Where n = the radius of the dish. This defaults to 2 x focus.

The parabolic functions work with:

- Class I or Class II geodesic
- All supported polyhedron types.

The following restrictions apply to the use of parabolics:

- A DXF filename must be included with the parabolic switches.
- The -w wireframe option should not be used.
- The ratio of focal length to dish diameter (f/d) must be greater than or equal 0.25.
- No other output file type aside from the 3DFACE DXF file is supported at this time.
- Frequency is based on a spherical formation. Large values of f/d will reduce the number of faces used in the structure. Compensate by further increasing the frequency.

Dome produces a DXF file containing the dish face data and an ASCII text file named parabolic.txt containing the raw data for each face. The following data is output:

- Index data for each triangle vertex (A, B, C see map.gif)
- Chord lengths for each triangle side (a, b, c)
- Face angles (A, B, C).

This data is given for each polyhedron face. In the case of the class I icosahedron 20 faces will be output. The class II structure will use up to 60 triangles. Many of these faces may not contain data as this is dependent on the truncation used.

The enclosed file map.gif contains a graphical representation one polyhedron face as well as the nomenclature used for each triangle.

The units used for the focus location will determine the units of chord length. If -d6 is used where 6 is the focal length in feet, then the chord lengths will be output in feet as well.

The parabolic.txt file is designed to be read by a spreadsheet application such as Microsoft Excel. When importing this file into a spreadsheet, set the field delimiter to

'tab', the text delimiter to '"' and make sure that the first three columns are read as text fields.

---

## Other Goodies

See the [Applied Synergetics Homepage](#) for image samples and links to other Synergetics Web sites. The latest DOME info can be found [here](#).

DXFtoPOV is a short utility which converts DXF line entities to POV-ray script. This is useful when using a CAD program to modify a DXF file. The modified DXF file can then be rendered using POV-ray. See the source code for more implementation comments.

---

## Windows Console Install

Unzip the program and then change to the Dome48 folder in a DOS command window. Change directory to dxftopov and type make to build the dxftopov utility.

---

## Other Platforms

Check the DOME web page for versions which support other platforms including 32-bit Windows & Linux.

---

## Source Code Comments

Releases of DOME prior to 4.0 had all the source code in one file. DOME 4.60 has the source code split across several files:

- dome.txt - this file
- dome.cpp - Source code for main program loop.
- geodesic.h - Header file containing variables, structures and class member function prototypes.
- geodesic.cpp - Source code for geodesic class member functions. Most of the work is done by these routines.
- dxfsave.cpp - Geodesic class DXF save routines.
- povsave.cpp - Geodesic class POV save routines.
- wrsave.cpp - Geodesic class WRL (VRML) save routines.
- cartesian.cpp - cartesian & spherical coordinate conversion & data structures
- cartesian.h - header for cartesian.cpp
- chords.cpp - class containing chord data structures
- chords.h - header for chord.cpp
- command.cpp - class implementing input parameter data structures
- command.h - header for command.cpp
- faces.cpp - class containing triangle face data structures
- faces.h - header for faces.cpp



- labels.cpp - class containing vertex label data structures
  - labels.h - header for labels.cpp
  - points.cpp - class containing vertex position data structures
  - points.h - header for points.cpp
  - ThetaTruncation.cpp - class for collecting truncation data
  - ThetaTruncation.h - header for ThetaTruncation.cpp
- 

## DOME Updates

The next major release of DOME will include:

- Provide Buckyball topological abundance in reports
- Buckyball face data
- Dihedral Face Angles
- INI file input for customizing POV-ray and other settings.
- Enhanced non-spherical support
- Space frame support
- Graphical Display

Feel free to contact me at [rjbono@applied-synergetics.com](mailto:rjbono@applied-synergetics.com) for suggestions, bug reports or questions.

---

## Copyright Information

DOME 4.80 Beta 1, Copyright (C) 1995 - 2002 Richard J. Bono This program is free software; you can redistribute it and/or modify it under the terms of the GNU General Public License as published by the Free Software Foundation; either version 2 of the License, or any later version. This program is distributed in the hope that it will be useful, but WITHOUT ANY WARRANTY; without even the implied warranty of MERCHANTABILITY or FITNESS FOR A PARTICULAR PURPOSE. See the GNU General Public License for more details. You should have received a copy of the GNU General Public License along with this program; if not, write to the Free Software Foundation, Inc., 675 Mass Ave, Cambridge, MA 02139, USA. Please direct inquiries, comments and modifications to:

[Richard J. Bono](mailto:rjbono@applied-synergetics.com)  
44 Augusta Rd.  
Brownsville, TX 78521

email: [rjbono@applied-synergetics.com](mailto:rjbono@applied-synergetics.com)

---

## Acknowledgements & References

The main reference used in the creation of this code was: "Geodesic Math & How to Use It" by Hugh Kenner, 1976, University of California Press. ISBN 0-520-02924-0; Library of Congress Catalog Card Number: 74-27292. Many thanks to Hugh for putting this data in an accessible format. Also, many thanks to:

- Dr. J. F. (Jym) Nystrom for turning me on to Bucky back in the summer of 1984.

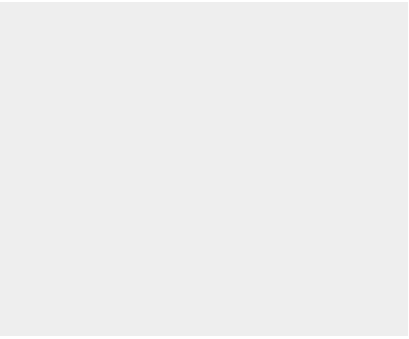

- My wife and daughters for their de-finite patience.
- Chris Fearnley for pushing me to release this code, providing uploading tips, general comments, GNU POV scripts and UNIX/LINUX make files.
- Kirby Urner for introducing me to POV-ray and for providing DOME with a home in cyberspace.
- R. Buckminster Fuller for changing the way I view Universe.

---

[Back to DOME page](#)

---

Contact [Rick Bono](#) at: [rjbono@applied-synergetics.com](mailto:rjbono@applied-synergetics.com)



Copyright (c) 2002 - Applied Synergetics. All Rights Reserved

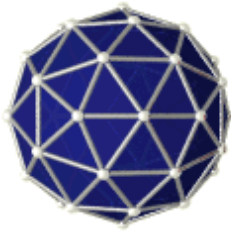

# Applied Synergetics

[Geodesic Domes](#)

[Download WinDome 4.80](#)

[WinDome Readme](#)

[Download DOME for Linux](#)

[DOME for Linux Readme](#)

[Download Console DOME](#)

[Console DOME Readme](#)

[Povray Dome Gallery](#)

[VRML Dome Gallery](#)

[Geodesic Dome Resources](#)

[Design Science University](#)

[Add to Guestbook](#)

[View Guestbook](#)

[Discussion Forum](#)

[News](#)

[FAQ](#)

[Design Science Workshop](#)

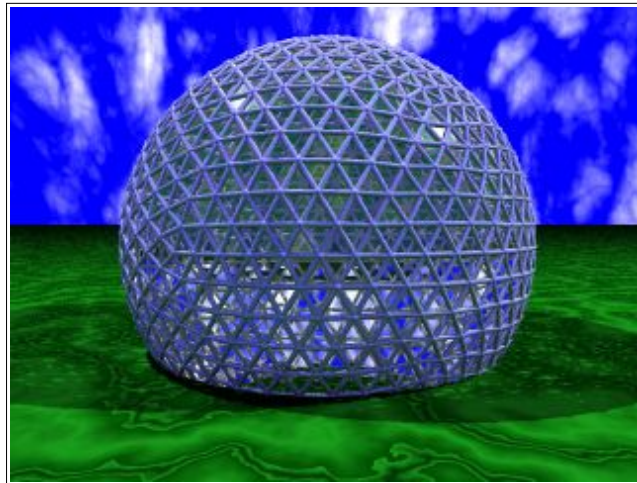

## DOME Ray-trace Gallery

### Geodesic Dome Images

Ray-traced images of various geodesic domes and their worlds. These images were made using [POV-Ray](#) ray-tracing program and my freeware [DOME](#) software.

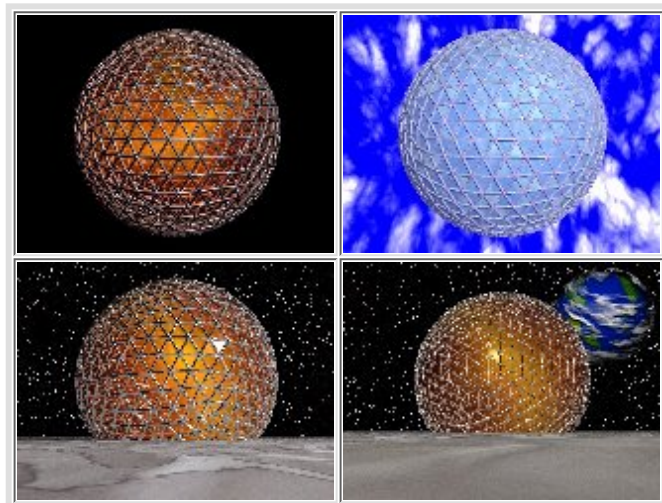

Click on the image to load

Contact [Rick Bono](#) at: [rjbono@applied-synergetics.com](mailto:rjbono@applied-synergetics.com)



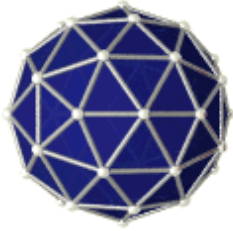

# Applied Synergetics

[Geodesic Domes](#)

[Download WinDome 4.80](#)

[WinDome Readme](#)

[Download DOME for Linux](#)

[DOME for Linux Readme](#)

[Download Console DOME](#)

[Console DOME Readme](#)

[Povray Dome Gallery](#)

[VRML Dome Gallery](#)

[Geodesic Dome Resources](#)

[Design Science University](#)

[Add to Guestbook](#)

[View Guestbook](#)

[Discussion Forum](#)

[News](#)

[FAQ](#)

[Design Science Workshop](#)

## Virtual Synergetics Gallery

### Geodesic Dome Models

---

VRML models of various geodesic dome constructs. All of these models were generated with [DOME](#), My freeware geodesic dome design program.

---



Contact [Rick Bono](#) at: [rjbono@applied-synergetics.com](mailto:rjbono@applied-synergetics.com)



Copyright (c) 2002 - Applied Synergetics. All Rights Reserved

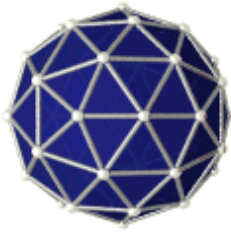

# Applied Synergetics

## Geodesic Dome Resources

[Geodesic Domes](#)

[Download WinDome 4.80](#)

[WinDome Readme](#)

[Download DOME for Linux](#)

[DOME for Linux Readme](#)

[Download Console DOME](#)

[Console DOME Readme](#)

[Povray Dome Gallery](#)

[VRML Dome Gallery](#)

[Geodesic Dome Resources](#)

[Design Science University](#)

[Add to Guestbook](#)

[View Guestbook](#)

[Discussion Forum](#)

[News](#)

[FAQ](#)

[Design Science Workshop](#)

---

Geodesic Dome info from Chris Fearnley's [R. Buckminster Fuller FAQ](#)

---

- [Parabolic Geodesic Solar reflectors.](#)
- [Oregon Domes, Inc.](#) - Dome Kits, Aluminum Frames.
- [American Ingenuity](#) - Modular Dome Homes Kits.
- [DomeHome Companion](#)
- [Envisioneering](#) - Components, domes, Trusses
- [Growing Spaces, Inc.](#) - Greenhouses
- [KingDomes](#) - Domes, Kits
- [Walt's Dome Page](#) - Good Dome Modeling and Building info.
- [Dome Glossary](#)
- [Kirby Urner's](#) Geodesic Dome Page
- Robert Conroy's [Structural Elements](#)
- [Geodesic Club House](#)
- [Geodesic Domes & Homes](#) Dome Homes.
- [Pacific Domes](#) Portable Geodesic Domes.
- Eric Weisstein's World of Mathematics entry [Geodesic Domes](#).
- [Rodrigo A. Siqueira's](#) Geodesic Dome Page.
- [Design and Implementation for a Geodesic Dome.](#)
- Build your own backyard [Geodesic Dome Observatory](#).
- [Desert Domes.](#)
- Burning Man Waterproof [Dome Plans](#).
- David Anderson's ["Monkey House"](#) (Don't let the name fool you!).
- Trevor Blake's [Geodesic Model Building Techniques](#).
- [Geodesic Greenhouse Building Instructions](#).
- [Professional Dome Plans](#)

Note: These links are for information only. I do not claim to endorse any of the products they may offer.

---

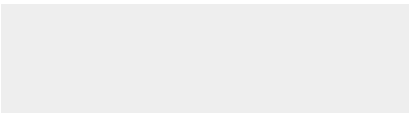

Take a look at [Chris Fearnley's page](#) for more POV-Ray examples and downloadable scripts. [Kirby Urner's Geodesic Dome](#) page has a wealth of Geodesic Dome resources. Also try the [Design Science University](#).

---

Contact [Rick Bono](#) at: [rjbono@applied-synergetics.com](mailto:rjbono@applied-synergetics.com)



Copyright (c) 2002 - Applied Synergetics. All Rights Reserved

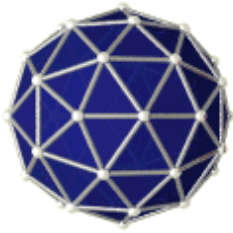

# Applied Synergetics

[Synergetics](#)

[General Systems Theory](#)

[Theory of Games](#)

[Chemistry](#)

[Physics](#)

[Topology](#)

[Projective Geometry](#)

[Cybernetics](#)

[Communications](#)

[Meteorology](#)

[Geology](#)

[Biology](#)

[Sciences of Energy](#)

[Political Geography](#)

[Ergonomics](#)

[Production Engineering](#)

[DSU Bookstore](#)

[Add to Guestbook](#)

[View Guestbook](#)

FAQ

[Design Science Workshop](#)

## Design Science University

### About The Design Science University...

In his book, "Utopia or Oblivion: The Prospects for Humanity", R. Buckminster Fuller describes his recommendations for a curriculum of Design Science. This page is devoted to bringing this comprehensivist curriculum to the Web.

### Design Science University - Course Catalog

The course catalog for Design Science University are listed on the right. The subject areas are divided into "schools" and provide links to information on the World Wide Web as well as sources for additional reading materials. The information provided ranges from references to tutorials for the subjects at hand. A recommended set of optional reading materials for each subject is also available.

Also see [MIT's Open Courseware](#) initiative. Within a few years their entire curriculum will be available on-line making the DSU a dream realized.

Search Now:

Search New and Used  
[amazon.com.](#)

Contact [Rick Bono](#) at: [rjbono@applied-synergetics.com](mailto:rjbono@applied-synergetics.com)



Copyright (c) 2002 - Applied Synergetics. All Rights Reserved

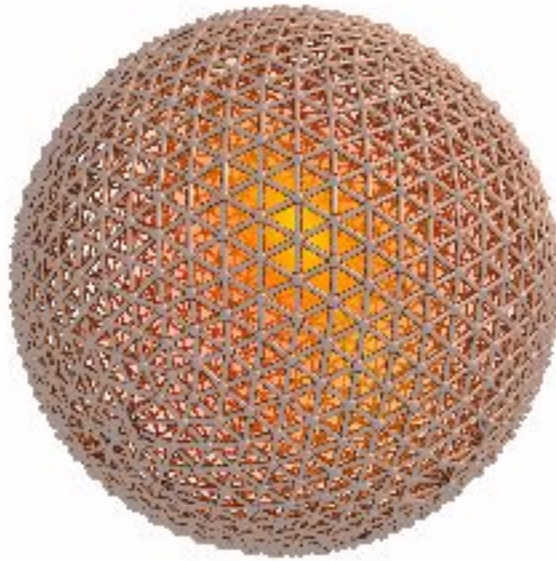

# Applied Synergetics Guestbook

---

**Warning:** mysql\_pconnect(): Access denied for user: 'dome\_guest@localhost' (Using password: YES) in **/home/rjbono/public\_html/ashp/guestbook/require/config.php** on line **29**  
Unable to connect to SQL server



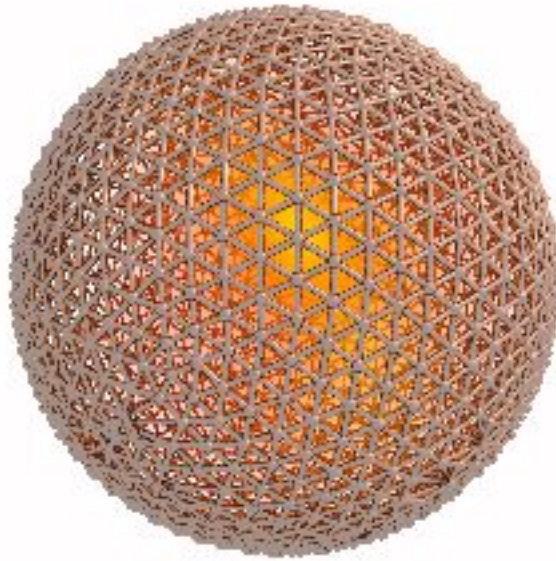

# Applied Synergetics Guestbook Entries

Click [here](#) for guest books entries from 1997 thru Mid September 2002

Click [here](#) to add a new entry

**Warning:** mysql\_pconnect(): Access denied for user: 'dome\_guest@localhost' (Using password: YES) in **/home/rjbono/public\_html/ashp/guestbook/require/config.php** on line **29**  
Unable to connect to SQL server

phpBB : **Critical Error**

Could not connect to the database

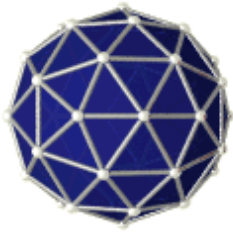

# Applied Synergetics

## Design Science Workshop

---

[Geodesic Domes](#)

[The Journal of Applied Synergetics](#)

[Synergetics](#)

[Tensegrity](#)

[Buckminsterfullerenes](#)

[Computational Cosmography](#)

[The Properties of Space](#)

[Modeling Techniques](#)

[Synergetics VRML \(3D\)](#)

[Design Science University](#)

[Links & Resources](#)

[Tetrahedral Kites](#)

[Add to Guestbook](#)

[View Guestbook](#)

[News](#)

FAQ

[Design Science Workshop](#)

Can't access the database. Try again later or [mail the webmaster](#).

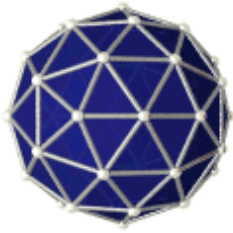

# Applied Synergetics

## Frequently Asked Questions

[Home](#)

[About](#)

[News](#)

[Products](#)

[Services](#)

[Projects](#)

[Research](#)

[Web Hosting](#)

[Open Source](#)

[FAQ](#)

**Warning:** mysql\_pconnect(): Access denied for user: 'faq@localhost' (Using password: YES) in  
**/home/rjbono/public\_html/as/faq/sites/dome/dome\_faq\_config.php** on line **29**  
Unable to connect to SQL server

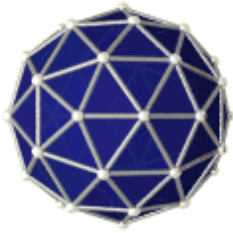

# Applied Synergetics

## Design Science Workshop

[Geodesic Domes](#)

[The Journal of Applied Synergetics](#)

[Synergetics](#)

[Tensegrity](#)

[Buckminsterfullerenes](#)

[Computational Cosmography](#)

[The Properties of Space](#)

[Modeling Techniques](#)

[Synergetics VRML \(3D\)](#)

[Design Science University](#)

[Links & Resources](#)

[Tetrahedral Kites](#)

[Add to Guestbook](#)

[View Guestbook](#)

[Discussion Forum](#)

[News](#)

[FAQ](#)

The goal of the Applied Synergetics Design Science Workshop is to provide design-scientists with a means to present their research activities in an open, global forum. These activities include (but are not limited to) educational tools, modeling software, visualization of synergetics concepts and artifact creation.

---

Can't access the database. Try again later or [mail the webmaster](#).

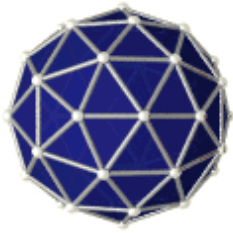

# Applied Synergetics

[Geodesic Domes](#)

[Download WinDome 4.80](#)

[WinDome Readme](#)

[Download DOME for Linux](#)

[DOME for Linux Readme](#)

[Download Console DOME](#)

[Console DOME Readme](#)

[Povray Dome Gallery](#)

[VRML Dome Gallery](#)

[Geodesic Dome Resources](#)

[Design Science University](#)

[Add to Guestbook](#)

[View Guestbook](#)

[Discussion Forum](#)

[News](#)

[FAQ](#)

[Design Science Workshop](#)

## For those wondering about the donations link...

DOME has always been and will always remain free software. I'm proud to say that DOME has been under the GNU General Public License since Version 2.18 back in 1995. Some would say back before "Open-Source" was cool. Since that time, DOME and the Applied Synergetics Home page have been hosted at my cost. I've been happy to do so and I plan to continue to do so as long as I am able.

The addition of the donations option is meant to allow the DOME user community a chance to help me continue to offer DOME, WinDome and the Applied Synergetics Home Page and encourage development of new versions of DOME.

**Donations are strictly optional, but are highly appreciated!**

Back to [Geodesic Dome](#) Page

Contact [Rick Bono](#) at: [rjbono@applied-synergetics.com](mailto:rjbono@applied-synergetics.com)



Copyright (c) 2002 - Applied Synergetics. All Rights Reserved



[Download](#) [Documentation](#) [Resources](#) [Community](#) [Support](#) [Search](#)

Welcome to povray.org

The [Persistence of Vision Raytracer](#) is a high-quality, totally free tool for creating [stunning three-dimensional graphics](#). It is [available in official versions](#) for [Windows](#), [Mac OS/Mac OS X](#) and [i86 Linux](#). The source code is available for those wanting to do their own ports.

POVCOMP 2004

The POV-Team is pleased to announce [POVCOMP 2004](#), a new POV raytracing competition that will run from now until mid-October. The first prize is a [raytracer's dream machine](#) worth more than US\$10,000. It comes equipped with dual 64-bit processors, eight gigabytes of RAM, one *terabyte* of disk space, two flat-panel monitors and an NVIDIA Quadro FX 3000 video card.

For more information, visit the competition site - [www.povcomp.com](http://www.povcomp.com).

What's New

### POVRAY.ORG's 10th anniversary

It was ten years ago today - on 18 August 1994 - that the POVRAY.ORG domain was registered. We've been on the internet continuously since then. Back in those days it was fairly unusual for a free software project to have its own domain and/or server and the logistics of setting one up were entirely different than they are now.

The POV-Team would like to extend its thanks to all those who have helped to make this happen, including Walnut Creek CDROM for providing our original hosting, the FreeBSD folks for early support and the immensely stable OS we run on, [Digimark](#) for providing DNS for all this time, and [Netplex Internet](#) for providing fast and reliable hosting for many years and generally being darn cool folks.

[August 18, 2004]

### POV-Ray response to claims benchmarked is rigged

We have posted a [response](#) to unsubstantiated claims made by a hardware review site that our [benchmark](#) may be 'tweaked' to suit a particular CPU manufacturer. While it seems unbelievable to us that someone could make such a claim when our source code is openly available, nevertheless it has happened. Our response includes some useful points to consider for

Hall of Fame

### "Villarcu Circles"



[See more Hall of Fame images...](#)

Webmaster's Pick @ zazzle

*Purchases made via these links support our server*



**MORAY**  
A wireframe modeller for  
POV-Ray version 3.x

anyone who wants to write hardware performance reviews.

[August 16, 2004]

### **POVWIN v3.6 RC2 (64-bit edition) available**

POV-Ray for Windows/64 version 3.6.0 RC2 is now available from our [beta page](#). This fully native 64-bit edition of POVWIN requires an AMD64 (or compatible) processor running Windows XP/64 (or any other 64-bit Microsoft operating system targeted at the AMD64). It will not install or function on any 32-bit operating system, even if it is hosted on a 64-bit processor.

[July 12, 2004]

### **Older news**

- [POV-Ray With Subdivision available](#)
- [POV-Ray v3.6.0 source code released](#)
- [Discontinuity Animation System Ready for Development](#)
- [povanim : a tool to export from Blender to POV-Ray](#)
- [Tools and Includes - New Releases and Updates](#)
- [POV-Ray 3.6.0 released](#)
- [Tools and Includes - New Releases and Updates](#)
- [Results of Fractal Raytracing Contest](#)
- [New Planet and Terrain generator written in Java](#)
- [POV-Ray v3.6 beta 2 available](#)
- [POV-Ray Short Code Contest 3 winners](#)
- ['Discontinuity' animation tool released.](#)
- [Rune's "story of the POV-Ray logo"](#)
- [QT-based POV editor for X-Windows](#)
- [POV-Tree 1.4 available](#)
- [Unattended POV install/de-install utility](#)
- [POV-Ray v3.6 beta 1 available](#)
- [SMPOV 4.00 released with scripting interface](#)
- [TesselSphere-1.1.0-rc9 released](#)
- ['Lawnmaker' tool](#)
- [Friedrich Lohmueller's Insert Menu add-on updated](#)





Go to the [previous](#), [next](#) section.

# GNU GENERAL PUBLIC LICENSE

Version 2, June 1991

Copyright (C) 1989, 1991 Free Software Foundation, Inc.  
675 Mass Ave, Cambridge, MA 02139, USA

Everyone is permitted to copy and distribute verbatim copies of this license document, but changing it is not allowed.

## Preamble

The licenses for most software are designed to take away your freedom to share and change it. By contrast, the GNU General Public License is intended to guarantee your freedom to share and change free software--to make sure the software is free for all its users. This General Public License applies to most of the Free Software Foundation's software and to any other program whose authors commit to using it. (Some other Free Software Foundation software is covered by the GNU Library General Public License instead.) You can apply it to your programs, too.

When we speak of free software, we are referring to freedom, not price. Our General Public Licenses are designed to make sure that you have the freedom to distribute copies of free software (and charge for this service if you wish), that you receive source code or can get it if you want it, that you can change the software or use pieces of it in new free programs; and that you know you can do these things.

To protect your rights, we need to make restrictions that forbid anyone to deny you these rights or to ask you to surrender the rights. These restrictions translate to certain responsibilities for you if you distribute copies of the software, or if you modify it.

For example, if you distribute copies of such a program, whether gratis or for a fee, you must give the recipients all the rights that you have. You must make sure that they, too, receive or can get the source code. And you must show them these terms so they know their rights.

We protect your rights with two steps: (1) copyright the software, and (2) offer you this license which gives you legal permission to copy, distribute and/or modify the software.

Also, for each author's protection and ours, we want to make certain that everyone understands that there is no warranty for this free software. If the software is modified by someone else and passed on, we want its recipients to know that what they have is not the original, so that any problems introduced by others will not reflect on the original authors' reputations.

Finally, any free program is threatened constantly by software patents. We wish to avoid the danger that redistributors of a free program will individually obtain patent licenses, in effect

making the program proprietary. To prevent this, we have made it clear that any patent must be licensed for everyone's free use or not licensed at all.

The precise terms and conditions for copying, distribution and modification follow.

## **TERMS AND CONDITIONS FOR COPYING, DISTRIBUTION AND MODIFICATION**

1. This License applies to any program or other work which contains a notice placed by the copyright holder saying it may be distributed under the terms of this General Public License. The "Program", below, refers to any such program or work, and a "work based on the Program" means either the Program or any derivative work under copyright law: that is to say, a work containing the Program or a portion of it, either verbatim or with modifications and/or translated into another language. (Hereinafter, translation is included without limitation in the term "modification".) Each licensee is addressed as "you".

Activities other than copying, distribution and modification are not covered by this License; they are outside its scope. The act of running the Program is not restricted, and the output from the Program is covered only if its contents constitute a work based on the Program (independent of having been made by running the Program). Whether that is true depends on what the Program does.

2. You may copy and distribute verbatim copies of the Program's source code as you receive it, in any medium, provided that you conspicuously and appropriately publish on each copy an appropriate copyright notice and disclaimer of warranty; keep intact all the notices that refer to this License and to the absence of any warranty; and give any other recipients of the Program a copy of this License along with the Program.

You may charge a fee for the physical act of transferring a copy, and you may at your option offer warranty protection in exchange for a fee.

3. You may modify your copy or copies of the Program or any portion of it, thus forming a work based on the Program, and copy and distribute such modifications or work under the terms of Section 1 above, provided that you also meet all of these conditions:
  1. You must cause the modified files to carry prominent notices stating that you changed the files and the date of any change.
  2. You must cause any work that you distribute or publish, that in whole or in part contains or is derived from the Program or any part thereof, to be licensed as a whole at no charge to all third parties under the terms of this License.
  3. If the modified program normally reads commands interactively when run, you must cause it, when started running for such interactive use in the most ordinary way, to print or display an announcement including an appropriate copyright notice and a notice that there is no warranty (or else, saying that you provide a warranty) and that users may redistribute the program under these conditions, and telling the user how to view a copy of this License. (Exception: if the Program itself is interactive but does not normally print such an announcement, your work based on the Program is not

required to print an announcement.)

These requirements apply to the modified work as a whole. If identifiable sections of that work are not derived from the Program, and can be reasonably considered independent and separate works in themselves, then this License, and its terms, do not apply to those sections when you distribute them as separate works. But when you distribute the same sections as part of a whole which is a work based on the Program, the distribution of the whole must be on the terms of this License, whose permissions for other licensees extend to the entire whole, and thus to each and every part regardless of who wrote it.

Thus, it is not the intent of this section to claim rights or contest your rights to work written entirely by you; rather, the intent is to exercise the right to control the distribution of derivative or collective works based on the Program.

In addition, mere aggregation of another work not based on the Program with the Program (or with a work based on the Program) on a volume of a storage or distribution medium does not bring the other work under the scope of this License.

4. You may copy and distribute the Program (or a work based on it, under Section 2) in object code or executable form under the terms of Sections 1 and 2 above provided that you also do one of the following:
  1. Accompany it with the complete corresponding machine-readable source code, which must be distributed under the terms of Sections 1 and 2 above on a medium customarily used for software interchange; or,
  2. Accompany it with a written offer, valid for at least three years, to give any third party, for a charge no more than your cost of physically performing source distribution, a complete machine-readable copy of the corresponding source code, to be distributed under the terms of Sections 1 and 2 above on a medium customarily used for software interchange; or,
  3. Accompany it with the information you received as to the offer to distribute corresponding source code. (This alternative is allowed only for noncommercial distribution and only if you received the program in object code or executable form with such an offer, in accord with Subsection b above.)

The source code for a work means the preferred form of the work for making modifications to it. For an executable work, complete source code means all the source code for all modules it contains, plus any associated interface definition files, plus the scripts used to control compilation and installation of the executable. However, as a special exception, the source code distributed need not include anything that is normally distributed (in either source or binary form) with the major components (compiler, kernel, and so on) of the operating system on which the executable runs, unless that component itself accompanies the executable.

If distribution of executable or object code is made by offering access to copy from a designated place, then offering equivalent access to copy the source code from the same place counts as distribution of the source code, even though third parties are not compelled to copy the source along with the object code.

5. You may not copy, modify, sublicense, or distribute the Program except as expressly provided under this License. Any attempt otherwise to copy, modify, sublicense or distribute the Program is void, and will automatically terminate your rights under this License. However, parties who have received copies, or rights, from you under this License will not have their licenses terminated so long as such parties remain in full compliance.
6. You are not required to accept this License, since you have not signed it. However, nothing else grants you permission to modify or distribute the Program or its derivative works. These actions are prohibited by law if you do not accept this License. Therefore, by modifying or distributing the Program (or any work based on the Program), you indicate your acceptance of this License to do so, and all its terms and conditions for copying, distributing or modifying the Program or works based on it.
7. Each time you redistribute the Program (or any work based on the Program), the recipient automatically receives a license from the original licensor to copy, distribute or modify the Program subject to these terms and conditions. You may not impose any further restrictions on the recipients' exercise of the rights granted herein. You are not responsible for enforcing compliance by third parties to this License.
8. If, as a consequence of a court judgment or allegation of patent infringement or for any other reason (not limited to patent issues), conditions are imposed on you (whether by court order, agreement or otherwise) that contradict the conditions of this License, they do not excuse you from the conditions of this License. If you cannot distribute so as to satisfy simultaneously your obligations under this License and any other pertinent obligations, then as a consequence you may not distribute the Program at all. For example, if a patent license would not permit royalty-free redistribution of the Program by all those who receive copies directly or indirectly through you, then the only way you could satisfy both it and this License would be to refrain entirely from distribution of the Program.

If any portion of this section is held invalid or unenforceable under any particular circumstance, the balance of the section is intended to apply and the section as a whole is intended to apply in other circumstances.

It is not the purpose of this section to induce you to infringe any patents or other property right claims or to contest validity of any such claims; this section has the sole purpose of protecting the integrity of the free software distribution system, which is implemented by public license practices. Many people have made generous contributions to the wide range of software distributed through that system in reliance on consistent application of that system; it is up to the author/donor to decide if he or she is willing to distribute software through any other system and a licensee cannot impose that choice.

This section is intended to make thoroughly clear what is believed to be a consequence of the rest of this License.

9. If the distribution and/or use of the Program is restricted in certain countries either by patents or by copyrighted interfaces, the original copyright holder who places the Program under this License may add an explicit geographical distribution limitation excluding those countries, so that distribution is permitted only in or among countries not thus excluded. In such case, this License incorporates the limitation as if written in the body of this License.

10. The Free Software Foundation may publish revised and/or new versions of the General Public License from time to time. Such new versions will be similar in spirit to the present version, but may differ in detail to address new problems or concerns.

Each version is given a distinguishing version number. If the Program specifies a version number of this License which applies to it and "any later version", you have the option of following the terms and conditions either of that version or of any later version published by the Free Software Foundation. If the Program does not specify a version number of this License, you may choose any version ever published by the Free Software Foundation.

11. If you wish to incorporate parts of the Program into other free programs whose distribution conditions are different, write to the author to ask for permission. For software which is copyrighted by the Free Software Foundation, write to the Free Software Foundation; we sometimes make exceptions for this. Our decision will be guided by the two goals of preserving the free status of all derivatives of our free software and of promoting the sharing and reuse of software generally.

## **NO WARRANTY**

12. BECAUSE THE PROGRAM IS LICENSED FREE OF CHARGE, THERE IS NO WARRANTY FOR THE PROGRAM, TO THE EXTENT PERMITTED BY APPLICABLE LAW. EXCEPT WHEN OTHERWISE STATED IN WRITING THE COPYRIGHT HOLDERS AND/OR OTHER PARTIES PROVIDE THE PROGRAM "AS IS" WITHOUT WARRANTY OF ANY KIND, EITHER EXPRESSED OR IMPLIED, INCLUDING, BUT NOT LIMITED TO, THE IMPLIED WARRANTIES OF MERCHANTABILITY AND FITNESS FOR A PARTICULAR PURPOSE. THE ENTIRE RISK AS TO THE QUALITY AND PERFORMANCE OF THE PROGRAM IS WITH YOU. SHOULD THE PROGRAM PROVE DEFECTIVE, YOU ASSUME THE COST OF ALL NECESSARY SERVICING, REPAIR OR CORRECTION.
13. IN NO EVENT UNLESS REQUIRED BY APPLICABLE LAW OR AGREED TO IN WRITING WILL ANY COPYRIGHT HOLDER, OR ANY OTHER PARTY WHO MAY MODIFY AND/OR REDISTRIBUTE THE PROGRAM AS PERMITTED ABOVE, BE LIABLE TO YOU FOR DAMAGES, INCLUDING ANY GENERAL, SPECIAL, INCIDENTAL OR CONSEQUENTIAL DAMAGES ARISING OUT OF THE USE OR INABILITY TO USE THE PROGRAM (INCLUDING BUT NOT LIMITED TO LOSS OF DATA OR DATA BEING RENDERED INACCURATE OR LOSSES SUSTAINED BY YOU OR THIRD PARTIES OR A FAILURE OF THE PROGRAM TO OPERATE WITH ANY OTHER PROGRAMS), EVEN IF SUCH HOLDER OR OTHER PARTY HAS BEEN ADVISED OF THE POSSIBILITY OF SUCH DAMAGES.

## **END OF TERMS AND CONDITIONS**

# How to Apply These Terms to Your New Programs

If you develop a new program, and you want it to be of the greatest possible use to the public, the best way to achieve this is to make it free software which everyone can redistribute and change under these terms.

To do so, attach the following notices to the program. It is safest to attach them to the start of each source file to most effectively convey the exclusion of warranty; and each file should have at least the "copyright" line and a pointer to where the full notice is found.

```
one line to give the program's name and an idea of what it does.  
Copyright (C) 19yy name of author
```

```
This program is free software; you can redistribute it and/or  
modify it under the terms of the GNU General Public License  
as published by the Free Software Foundation; either version 2  
of the License, or (at your option) any later version.
```

```
This program is distributed in the hope that it will be useful,  
but WITHOUT ANY WARRANTY; without even the implied warranty of  
MERCHANTABILITY or FITNESS FOR A PARTICULAR PURPOSE. See the  
GNU General Public License for more details.
```

```
You should have received a copy of the GNU General Public License  
along with this program; if not, write to the Free Software  
Foundation, Inc., 675 Mass Ave, Cambridge, MA 02139, USA.
```

Also add information on how to contact you by electronic and paper mail.

If the program is interactive, make it output a short notice like this when it starts in an interactive mode:

```
Gnomovision version 69, Copyright (C) 19yy name of author  
Gnomovision comes with ABSOLUTELY NO WARRANTY; for details  
type `show w'. This is free software, and you are welcome  
to redistribute it under certain conditions; type `show c'  
for details.
```

The hypothetical commands `show w' and `show c' should show the appropriate parts of the General Public License. Of course, the commands you use may be called something other than `show w' and `show c'; they could even be mouse-clicks or menu items--whatever suits your program.

You should also get your employer (if you work as a programmer) or your school, if any, to sign a

"copyright disclaimer" for the program, if necessary. Here is a sample; alter the names:

```
Yoyodyne, Inc., hereby disclaims all copyright
interest in the program `Gnomovision'
(which makes passes at compilers) written
by James Hacker.
```

```
signature of Ty Coon, 1 April 1989
Ty Coon, President of Vice
```

This General Public License does not permit incorporating your program into proprietary programs. If your program is a subroutine library, you may consider it more useful to permit linking proprietary applications with the library. If this is what you want to do, use the GNU Library General Public License instead of this License.

Go to the [previous](#), [next](#) section.



# Desert Domes

Making the world a "Fuller" place

- HOME
- DOME CALCULATOR
- DOME FORMULAS
- BAMBOO DOMES
- CONDUIT DOME TIPS
- FAQ
- DOMES FOR SALE
- PHOTO GALLERIES
- LINKS
- ABOUT ME
- BIBLIOGRAPHY

## DOME CALCULATOR

2V

3V

4V

5V

1V

6V

Check out the new [FAQ page!](#)

Go to the [Reverse Dome Calculator](#) if you know one of the strut lengths, and you want to calculate the radius and the lengths of the other struts.

Need some Cool Neon wire to decorate your dome? Don't know what that is? Click [here!](#)





# Desert Domes

Making the world a "Fuller" place

- HOME
- DOME CALCULATOR
- DOME FORMULAS
- BAMBOO DOMES
- CONDUIT DOME TIPS
- FAQ
- DOMES FOR SALE
- PHOTO GALLERIES
- LINKS
- ABOUT ME
- BIBLIOGRAPHY

## DOME FORMULAS

I've gotten several requests for the formulas behind the dome calculator, so here they are!

First of all, you need this simple formula:

$$\text{dome radius} = \text{strut length} / \text{strut factor}$$

which is the same as:

$$\text{strut length} = \text{dome radius} * \text{strut factor}$$

Now all you need are the strut factors!

| Strut            | Strut factor | Dome | Sphere |
|------------------|--------------|------|--------|
| A                | 1.05146      | 25   | 30     |
| 5-way connectors |              | 6    | 12     |
| 4-way connectors |              | 5    | 0      |

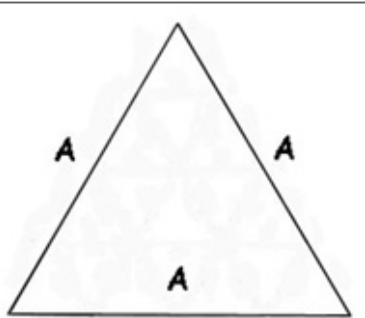

| Strut            | Strut factor | Dome | Sphere |
|------------------|--------------|------|--------|
| A                | .61803       | 35   | 60     |
| B                | .54653       | 30   | 60     |
| 4-way connectors |              | 10   | 0      |
| 5-way connectors |              | 6    | 12     |
| 6-way connectors |              | 10   | 20     |

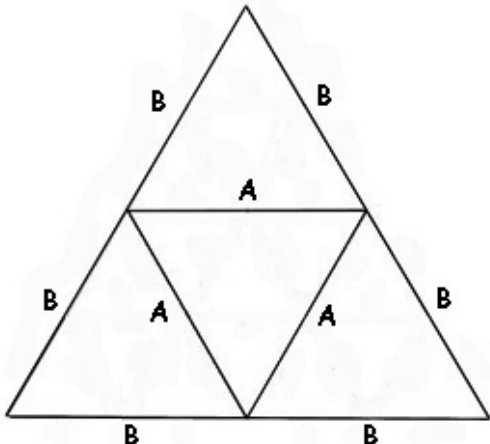

| Strut | Strut factor | 3/8 | 5/8 | Sphere |
|-------|--------------|-----|-----|--------|
| A     | .34862       | 30  | 30  | 60     |

|                  |        |    |    |     |
|------------------|--------|----|----|-----|
| B                | .40355 | 40 | 55 | 90  |
| C                | .41241 | 50 | 80 | 120 |
| 4-way connectors |        | 15 | 15 | 0   |
| 5-way connectors |        | 6  | 6  | 12  |
| 6-way connectors |        | 25 | 40 | 80  |

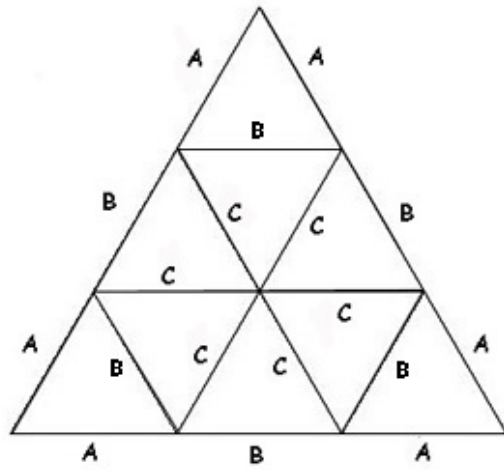

| Strut            | Strut factor | Dome | Sphere |
|------------------|--------------|------|--------|
| A                | .25318       | 30   | 60     |
| B                | .29524       | 30   | 60     |
| C                | .29453       | 60   | 120    |
| D                | .31287       | 70   | 120    |
| E                | .32492       | 30   | 60     |
| F                | .29859       | 30   | 60     |
| 4-way connectors |              | 20   | 0      |
| 5-way connectors |              | 6    | 12     |
| 6-way connectors |              | 65   | 150    |

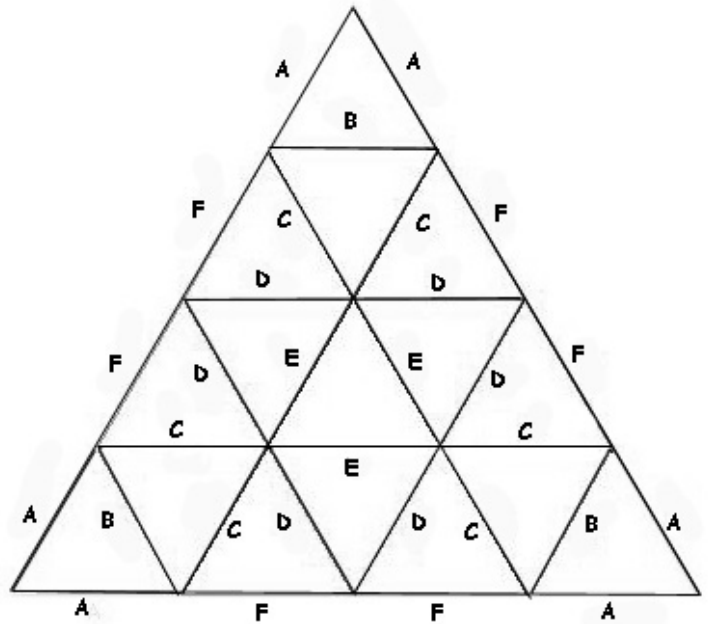

| Strut            | Strut Factor | Dome | Sphere |
|------------------|--------------|------|--------|
| A                | .19814743    | 30   | 60     |
| B                | .23179025    | 30   | 60     |
| C                | .22568578    | 60   | 120    |
| D                | .24724291    | 60   | 120    |
| E                | .25516701    | 70   | 120    |
| F                | .24508578    | 90   | 120    |
| G                | .26159810    | 40   | 60     |
| H                | .23159760    | 30   | 60     |
| I                | .24534642    | 20   | 30     |
| 4-way connectors |              | ??   | 0      |
| 5-way connectors |              | 6    | 12     |
| 6-way connectors |              | ??   | ??     |

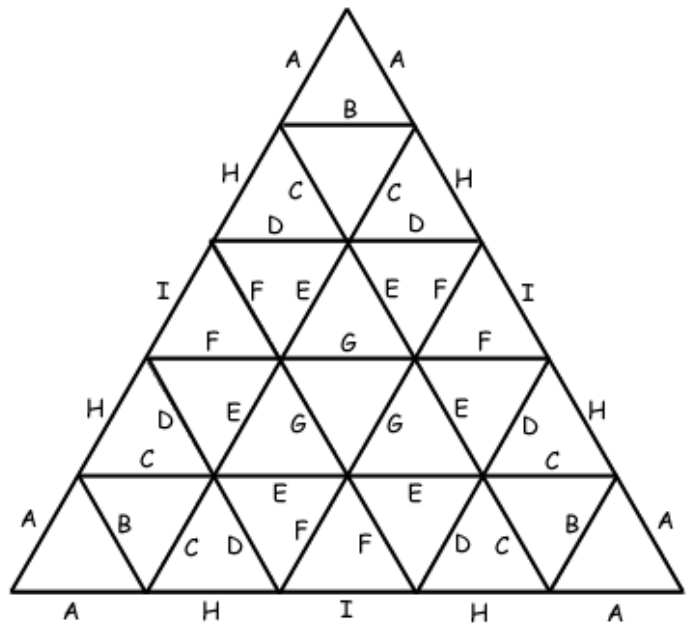

| Strut            | Strut Factor | Dome | Sphere |
|------------------|--------------|------|--------|
| A                | .1625672     | 30   | 60     |
| B                | .1904769     | 30   | 60     |
| C                | .1819083     | 60   | 120    |
| D                | .2028197     | 90   | 180    |
| E                | .1873834     | 30   | 60     |
| F                | .1980126     | 60   | 120    |
| G                | .2059077     | 120  | 240    |
| H                | .2153537     | 60   | 120    |
| I                | .2166282     | 60   | 120    |
| 4-way connectors | ??           | 0    |        |
| 5-way connectors | 6            | 12   |        |
| 6-way connectors | ??           | ??   |        |

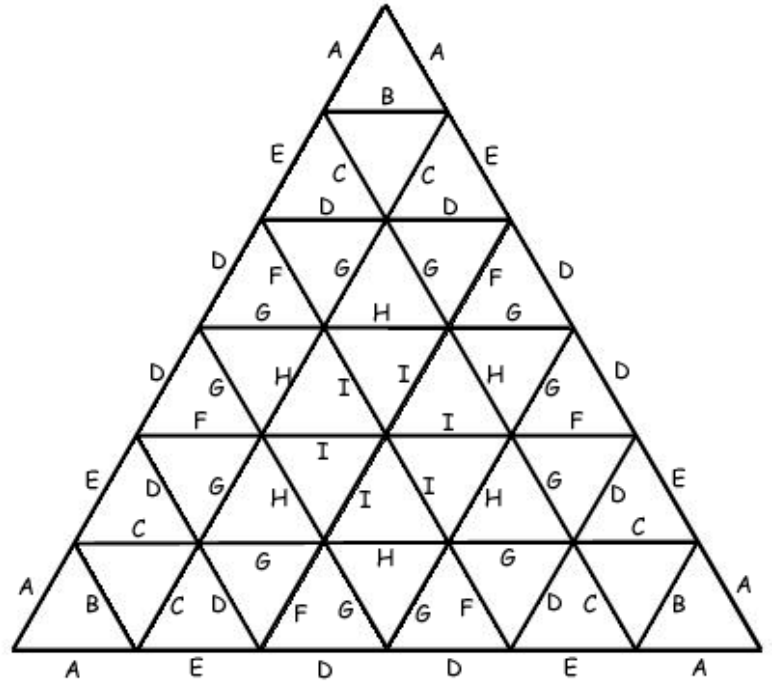

© 2002 Desert Domes || Oakland, California



# Desert Domes

## Making the world a "Fuller" place

- HOME
- DOME CALCULATOR
- DOME FORMULAS
- BAMBOO DOMES
- CONDUIT DOME TIPS
- FAQ
- DOMES FOR SALE
- PHOTO GALLERIES
- LINKS
- ABOUT ME
- BIBLIOGRAPHY

### BAMBOO DOMES

This is page 95 of "Domebook Two", a book that was published in the 70's and is very hard to find. It was written by Pacific Domes (not the same as [Pacific Domes](#)), and I was able to find it at the local library.



Bamboo grows fast, is free material for a dome framework. It might be possible to suspend a tent skin or mosquito netting inside, or pull a stretch cloth over the outside and shoot foam. Tools: a pocket knife and string. The following instructions were prepared by R. Buckminster Fuller. I haven't tried this yet.



### Dome Assembly

The geodesic dome, as shown in the assembly diagrams, contains two different joints: a B joint which occurs at the vertices of all pentagons formed, and an R joint which occurs at all other points.

The spans from joint to joint are BB, BR, or RR. The arc factors of these lengths are:

**BB=.26030616, BR=.31030984, RR=.32636688.**

For these factors, the radius of the dome is 1.00. To construct a 22' dome (11' radius) the lengths of the arcs would be as follows: BB=2.86', BR=3.41', RR=3.59'.



### Cutting and Measuring the Members

There are only two different lengths of members used in the erection.

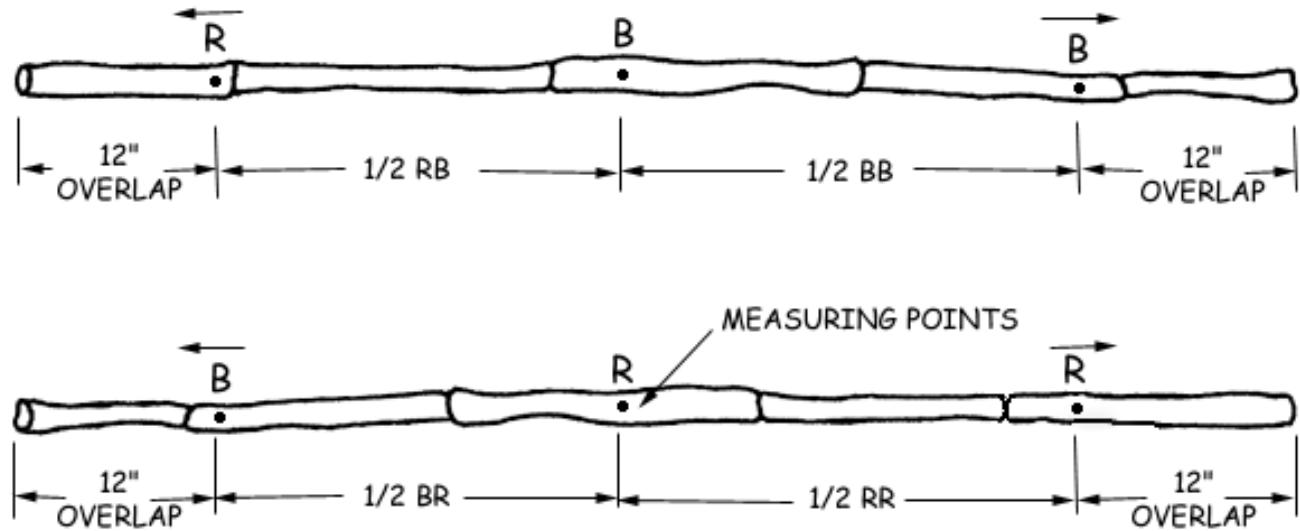

For a 5/8 dome, 80 B members are required.

A line of color can be drawn around the bamboo members at each measuring point. Use blue for the B points and use red for the R points.



### Cross Assembly

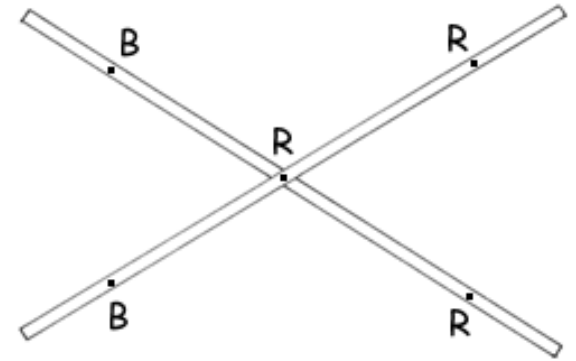
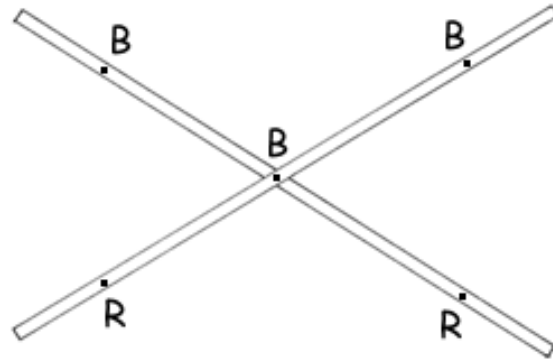

The B cross consists of two B members whose lengths are:  
 $\frac{1}{2} BB$  plus  $\frac{1}{2} BR$  plus 12" extra at each end.

The R cross consists of two R members whose lengths are:  
 $\frac{1}{2} BR$  plus  $\frac{1}{2} RR$  plus 12" extra at each end.

With 12" extra on the end of each stick, there'll be a 24" overlap when the crosses are assembled.



### Cross Tying

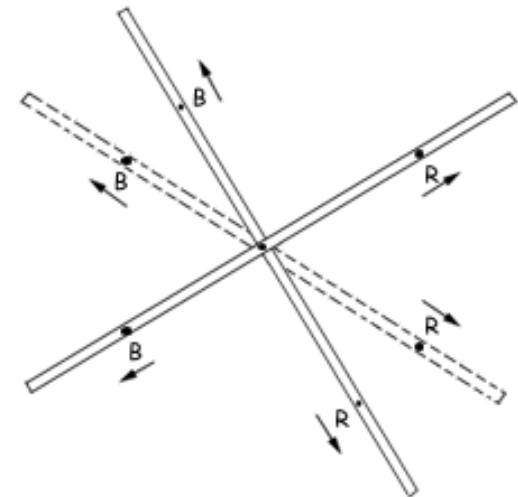
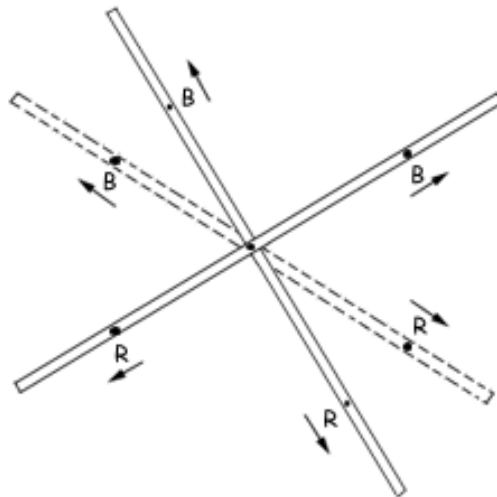

Place members at right angles to each other and tie firmly, but not too tight. During assembly of the dome, the crosses will twist into proper position as shown.

In all cases, when looking at a cross with the acute angles at the sides and the obtuse angles at the top and bottom, the member going from the upper right hand corner to the lower left hand corner always passes over the other member.



### Stage 1 Assembly

The first stage in the assembly of the dome is the construction of the pentagons at the top of the dome. This process employs 5 B crosses.

**Step A:** Tie together two B crosses as shown in the diagram. Note that the end measuring points have the same designation as the cross to which they are connected.

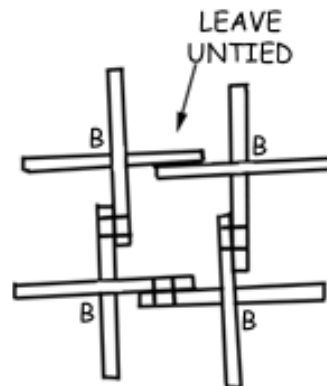
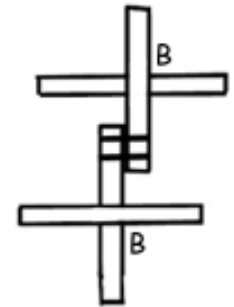

**Step B:** Add two more B crosses in the same manner as shown in step A.

**Step C:** Add fifth B cross between the untied legs. In order to insert this cross, all crosses will be twisted so that a regular pentagon is formed.

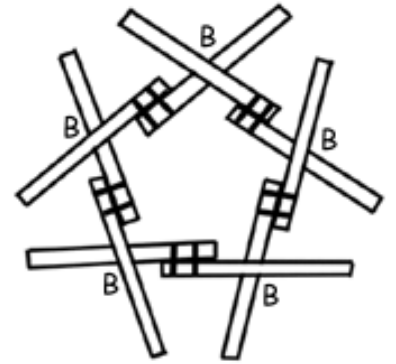

## Stage 2 Assembly

The second stage consists of closing the five triangles around the pentagon. Use five R crosses.



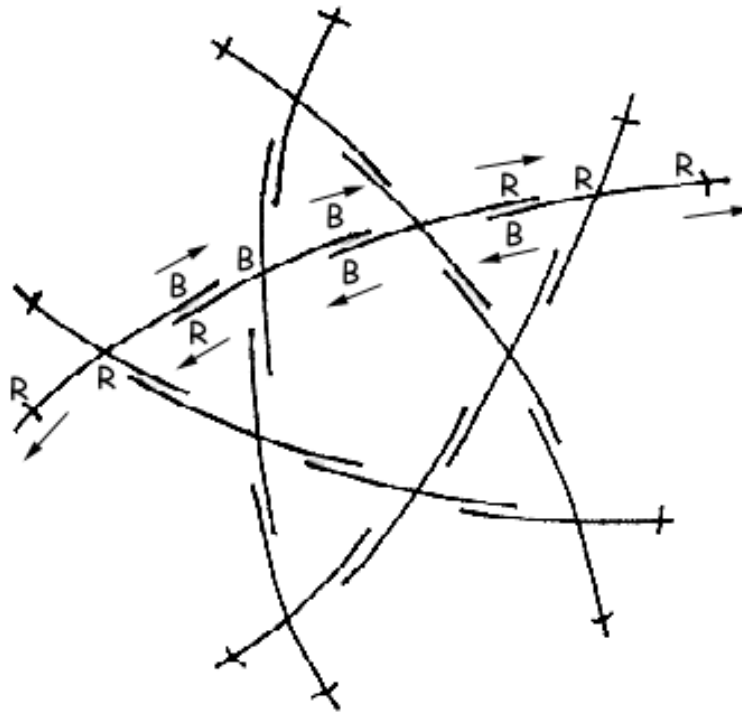

Again, the end measuring points always have the same designation as the cross to which they are connected.  
At this point, the structure will tend to bow. Turn the figure so that it is concave downward.



**Prop It**



Lift the assembled figure off the ground to facilitate the addition of new crosses. Use five bi-ped props. Each prop consists of two bamboo sticks about 7 feet long, tied together near the top with a cord about a foot long. These props will then support the dome at equidistant points from it's apex; first at the five vertices at the top of the pentagon, later at five corresponding points on the top five hexagons.



### Stage 3

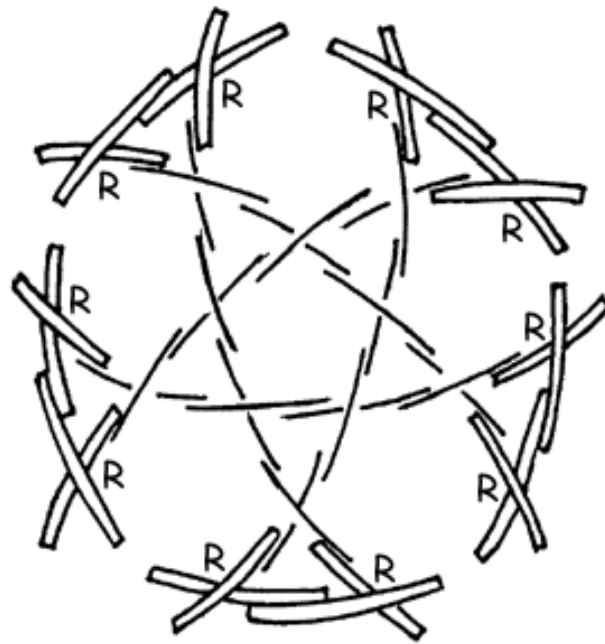

For the third stage, use ten R crosses as shown.



### Stage 4

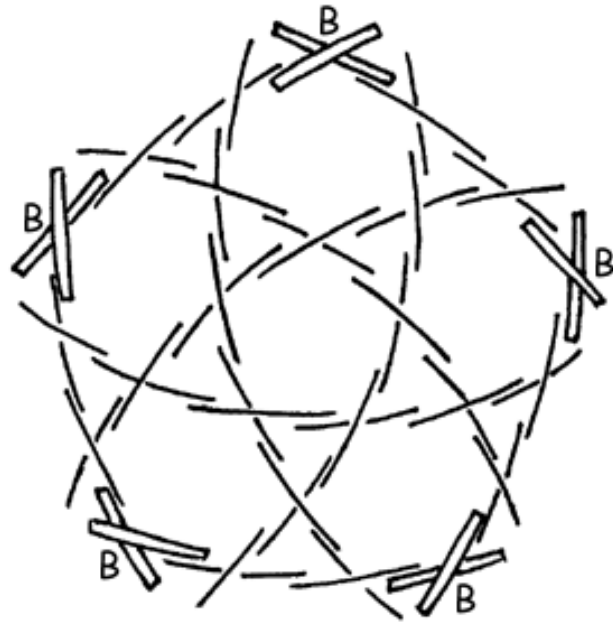

The fourth stage uses 5 B crosses which close the five hexagons.



### Stage 5

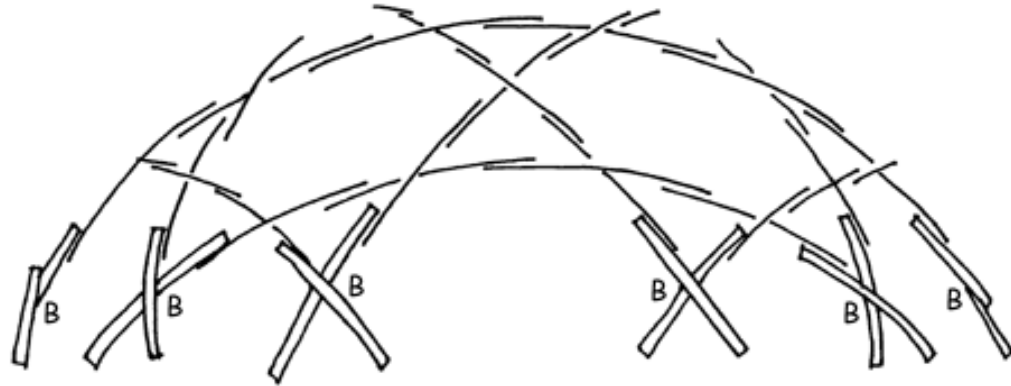

The fifth stage uses ten B crosses to close ten triangles. Six of the crosses can be seen in the diagram above.



### Stage 6

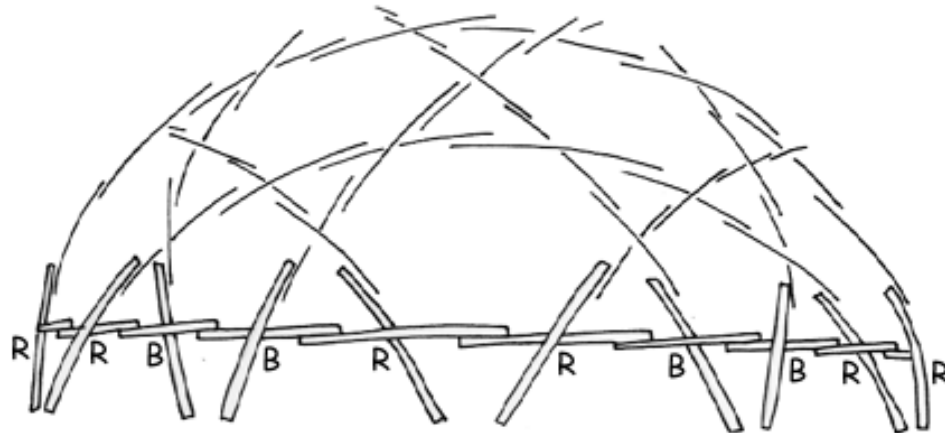

The sixth stage uses ten B crosses and ten R crosses to complete the first horizontal band. We now have a 3/8 dome.



## Stage 7,8

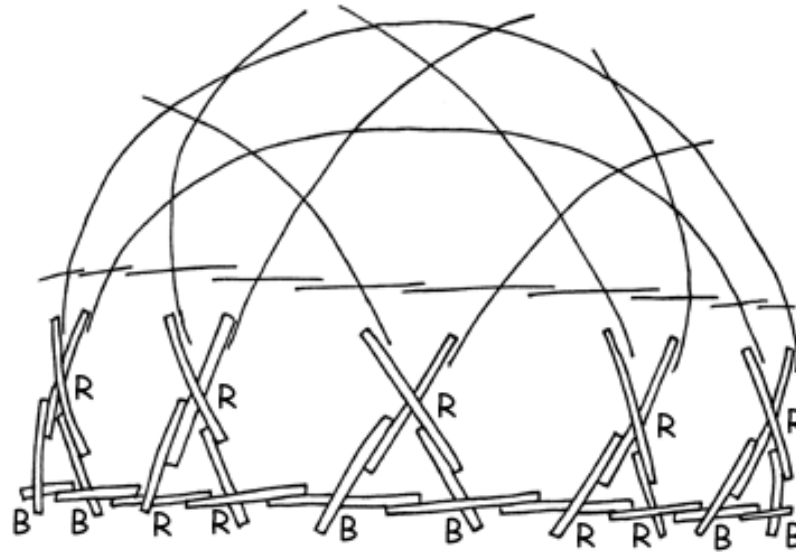

To complete the 5/8 dome requires two stages. The seventh stage uses ten R crosses and the eighth stage uses ten R crosses and ten B crosses. On the last twenty crosses, all members pointing towards the ground should be cut off 12" from the cross' central point.



© 2002 Desert Domes || Oakland, California



# Desert Domes

## Making the world a "Fuller" place

HOME

DOME CALCULATOR

DOME FORMULAS

BAMBOO DOMES

CONDUIT DOME TIPS

FAQ

DOMES FOR SALE

PHOTO GALLERIES

LINKS

ABOUT ME

BIBLIOGRAPHY

### CONDUIT DOME TIPS

Conduit, or EMT seems to be the material of choice for domes at Burning Man. Conduit is easy to work with, relatively inexpensive, and plated so painting isn't necessary. This page will provide tips for making conduit framed domes.

#### STEP 1: Deciding on a frequency

The first thing you need to do is figure out what type of dome you want to build. If this is your first dome, the 2 or 3 frequency domes are recommended. These domes require a fewer number of struts, and therefore less confusion.

#### STEP 2: What Size?

Once you have decided what kind of dome you are going to build, you need to decide on a size. Sometimes it is better to work out how long your longest or shortest strut will be and work from there. You can use the [Reverse Dome Calculator](#) when this is the case.

#### STEP 3: Calculating Strut Lengths

This is where the [Dome Calculator](#) comes in. Go to the calculator and plug in the radius that you decided on for your dome. If it's been a long time since your last math class, radius is the the distance from the center to the edge of a circle or sphere. In this case, the radius is the ceiling height for the even frequency domes. For the odd frequency domes, the ceiling will be higher than the radius that you put in (unless you are building the 3/8 3v dome, in that case the ceiling will be lower).

1v dome builders: Cut all your pipe the same length and skip to Step 5.

#### Step 4: Eliminating Waste

This part is tedious, but worth the effort because it will save you money and you won't have to feel bad about throwing away tons of wasted pipe. You will have to repeat steps 2, 3, and 4 to do this right. It may take a while, but I would think you were a bad person if you didn't at least try. Conduit is usually sold in 10' lengths, so your job is to figure out how to cut those pieces eliminating as much waste as possible. Make sure to add 1/2" for each strut to allow for drilling. For all you 2v dome builders, it's easy because there are only two lengths involved. The magic numbers for a 2v dome cut from 10' conduit pieces are A = 5.3', and B = 4.7'. These numbers allow for holed drilled 3/4" away from the ends. 2v people may

now skip to step 5. The rest of you: Still with me? Play with the numbers until you can get the maximum number of struts using the minimum number of conduit pieces. You may try 2 A's and 1 C, or 1 A, 1 C, and 1 F. Don't forget that different numbers of struts are required. Don't get stuck with more or less than what you need. I never said this was the easy part...

### Step 5: Cutting the struts

Cut the tubes according to the strut factors plus 1½". This allows for drilling the holes ¾" from the ends. Cut the struts using either a hacksaw or a pipe cutter. If you use a hacksaw, 16 or 18 tooth blades work best. When making many cuts, it's always best to use a jig so all the struts are exactly the same length.

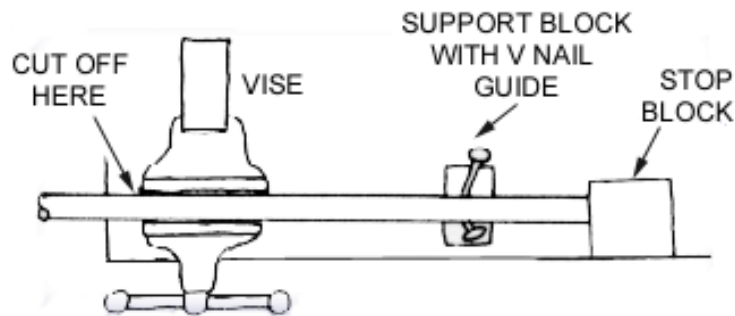

### STEP 6: Flattening the ends

OK, there are a few ways to do this part. You can either pound the ends flat with a hammer, which could be really time consuming, or nearly impossible if you are as small as I am. You can also use a vise, but make sure it's a fairly large one so it doesn't break after a few squishes. The way I like to do it is to use a press. The press in the picture is a 1 ton arbor press bought at Harbor Freight Tools. It was really cheap, but only lasted about 20 squishes. The 3 ton press worked a lot better, but it started to bend after about 150 squishes. If you can afford it, a hydraulic press seems like the way to go. If you flatten the ends with a curved die like the one shown below, the ends will be stronger and therefore less likely to bend under load. (click image to enlarge) Please notice the weld along the side of the conduit. If you flatten the end with the weld on the side, the conduit will be likely to split there. It can also split if the weld is in the center of the flat part. I personally haven't had this happen, but I spend good money on dome parts, and would rather not learn the hard way. Keep in mind that the flattened ends need to be in the same plane. If you take a few minutes to construct a simple jig for this, I promise you won't regret it.

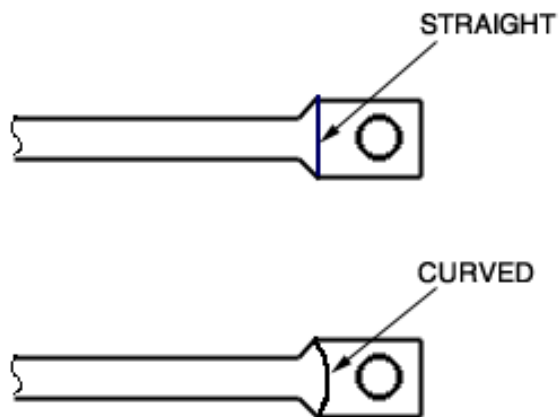

### Step 7: Drilling Holes

To drill the first hole in each strut, cut a V groove in a 2 X 4 six inches longer than the longest strut. Clamp it to a drill press with C clamps. Use a stop block so that all of the holes are the correct distance from the end of the pipe ( $\frac{3}{4}$ " from center of hole to edge of pipe). Use a  $\frac{3}{8}$ " drill bit (you may need to buy several). Titanium costs more, but lasts the longest. This gives about  $\frac{1}{2}$ " from the edge of the hole to the edge of the pipe. To drill the second hole, you will need to measure the exact hole-to-hole (aka strut) length, along the 2 X 4 and drill a  $\frac{3}{8}$ " hole there. Screw in a  $\frac{7}{16}$  carriage bolt that has its head cut off with a hacksaw. It will be tight since the hole is smaller than the bolt, but trust me on this one. You can use a vise-grip or a pipe wrench to screw it in. File the cut-off stump to a slight taper so the holes in the pipe will easily slip over it. Clamp the 2 X 4 back to the drill press so that when the first hole is placed over the cut-off bolt, the other end can be placed under the drill in the correct position. Pull the drill down so it just touches the pipe, and double check your measurements. If they are correct, continue drilling with confidence. If not, you know what to do. Continue this process with all lengths moving the pin as necessary. It would also be a good idea to mark the table and the jig when you get it set so you can tell if it is moving.



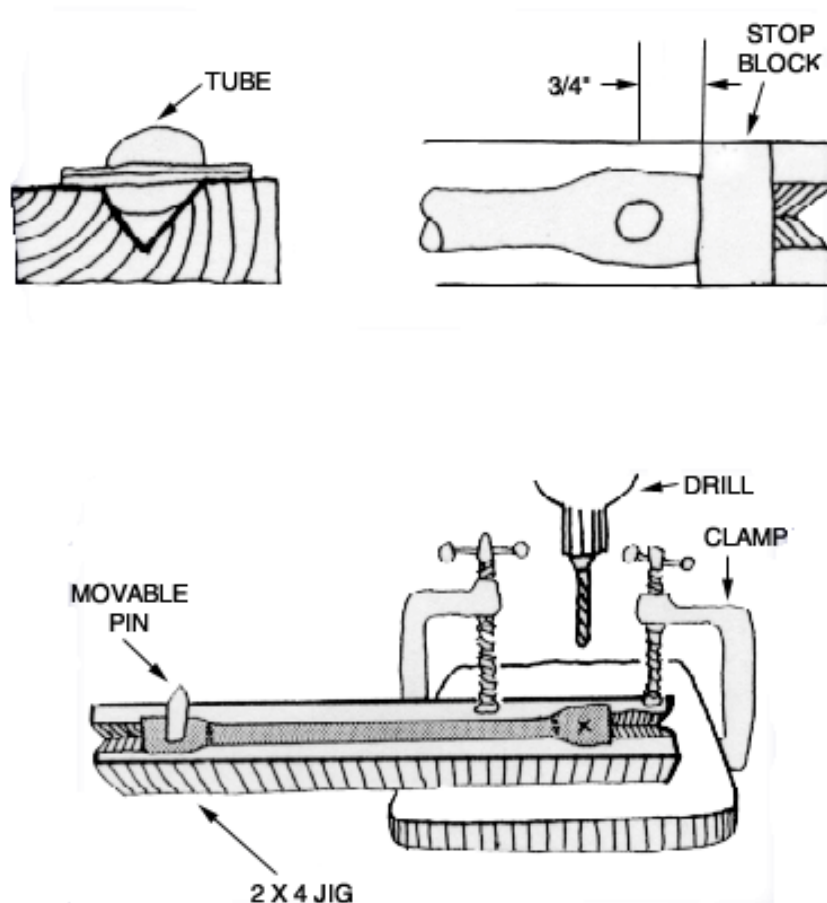

### Step 8: Bending the Struts

Now the struts need to be bent to the correct angles. You can do this by clamping the end into a vise and bending the tube to a stop block. If any of the flattened ends are split, bend the pipe toward the split side so the split will be on the inside of the dome. The accuracy of the bend is not as important as drilling the holes, so don't hurt yourself on this one. I repeat, the accuracy is not that crucial, don't spend all day deciding if you need to bend an extra degree or not! When the dome goes up for the first time, the struts will bend to the exact angles on their own.

The bending angles are as follows:

1v dome: bend 32° on each end

2v dome: bend A's 18°, and B's 16° on each end

3v dome: bend A's 10°, B's and C's 12° on each end

4v dome: bend all struts 7°-9° on each end

5v dome: bend all struts 6°-7° on each end

6v dome: bend all struts 5°-6° on each end

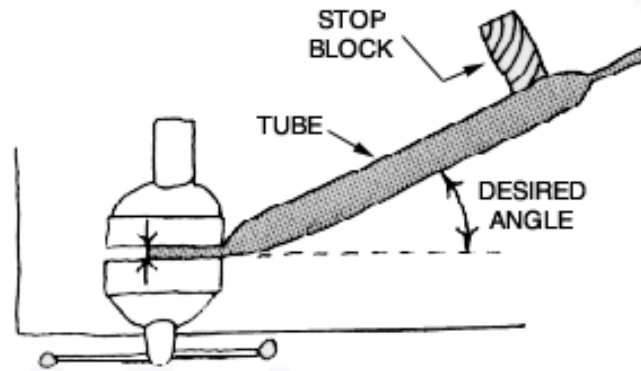

### Step 9: Painting

The ends of the struts all need to be painted, because otherwise they will rust. Since you are painting anyway, why not color-code! I'm a big fan of color-coding, and when you try to assemble the dome you'll find out why. To make it even easier on yourself while you're in the desert, make a model using the same colors as in your dome. When you get to Burning Man, you can set the model down, lay out all of the struts, and sit back and relax while other people put it together for you. Well, not really, but it will make it a lot easier to put the dome together if you have a model as a reference.

### Step 10: Break Time!

Take a break, cause that was hard work. If your camp is anything like ours, you can't take a break because you just finished the prep work for the dome 3 hours before it's time to leave for the desert...

### Step 11: Assembly

Ahhh, the moment you've all been waiting for. Bet you're a little nervous if it's your first time. Don't be. If you followed these instructions carefully, your dome should go up smoothly.

Domes can either be built from the top down or bottom up, depending on the size of the dome, and your tallest ladder. Building from the top down eliminates the need for a ladder, but you better have a lot of people helping. As the dome goes up, you will need one person at every vertex holding it up. If any of your poles get bent during this process, you better hope you listened to me before and made extras. Bottom to top assembly is much safer on the dome, but it means you have to bring ladders and/or scaffolding tall enough to reach the top of the dome. I noticed several domes last year without tops. Build the dome in layers whether you are going from top to bottom or vice versa. Don't get ahead of yourself. If you build in layers, the dome will pretty much support itself as it goes up. It might be a good idea to designate one person as the parts person. All this person has to do is lay out the next layer of struts on the ground for the assembly crew. This prevents over anxious builders from getting ahead of the rest of the crew. Don't tighten the bolts until all of the struts are in place. The struts will shift into their proper alignments as the dome

is built, and they can't do that if the bolts are tight. Remember the dome doesn't get it's strength until the last strut is in place and all the bolts are tightened.

Here are the assembly diagrams for domes 2-6.

[2v dome](#)

[3v dome](#)

[4v dome](#)

[5v dome](#)

[6v dome](#)

If you are building your dome from the bottom up, here is some useful information:

You will need to lay out the appropriate number of struts in a circle to get started. The numbers are given below.

1v dome - 5 struts

2v dome - 10 struts

3v 3/8 dome - 15 struts

3v 5/8 dome - 15 struts

4v dome - 20 struts

5v 3/8 dome - 25 struts

5v 5/8 dome - 25 struts

6v dome - 30 struts

### **Step 12: Staking Down**

Please don't forget this part. If you cover your dome before you stake it down, you will not be a happy camper when it catches wind and smashes into the cars parked a couple of feet away. Rebar bent into candy cane shapes work really well for stakes. Make sure they are at least 2 feet long. Pound them in about every other vertex along the bottom.

### **Step 13: Covering your dome**

The whole purpose of this IS for shade right? If not, you can stop here.

Parachutes make really nice dome coverings because all have to do is pull the parachute over the dome and tie it down. The only problem with parachutes is that they were made to catch wind... Need I say more?

You've gotten this far, you can make a covering. Be creative on this one.

You can use bed sheets, canvas, or anything else you can think of.

Reinforce all points that will be connected to the dome or they will tear with the slightest gust of wind.

Woo Hoo! Now that your dome is finished, you can sit back and relax, or wander around knowing that you have a really cool shelter to return to.

Be sure to come and see us at Camp Sunscreen for a relaxing sunscreen massage. If you know where you and your dome will be, please e-mail me with your address so I can come check out your masterpiece and also take pictures for the photo gallery.

See ya on the playa!

Tara

Here are some other dome building tips pages.

[My friend and fellow Camp Sunscreen camper's dome tips page](#) - there are lots of pictures and very good tips

[Michael Gourlay's Dome Page](#) - Michael is another fellow Burning Man

attendee



© 2002 Desert Domes | | Oakland, California





# Desert Domes

## Making the world a "Fuller" place

HOME

DOME CALCULATOR

DOME FORMULAS

BAMBOO DOMES

CONDUIT DOME TIPS

FAQ

DOMES FOR SALE

PHOTO GALLERIES

LINKS

ABOUT ME

BIBLIOGRAPHY

### FAQ

#### **Are the results of the dome calculator given in feet, inches, or meters?**

The results of the dome calculator are the same unit of measure you used for the radius. If you enter the radius in feet, the strut lengths will be in feet. The dome calculator simply multiplies your number by constants, so the unit doesn't matter.

#### **What does 3/8 and 5/8 mean?**

The odd frequency domes are not exactly half of a sphere. They can either be a little more or less than half. 3/8 and 5/8 are not exact numbers, they are mainly for reference.

#### **How do you put these things together? And what is the meaning of that triangle next to the strut lengths?**

All of the domes on this site are based on the icosahedron. The 1v dome is actually an icosahedron with the bottom 5 struts removed. The triangles on the Dome Calculator pages represent one icosahedron face. I created assembly diagrams for all of the domes except the 1v, and the links to them are as follows:

[2v dome](#)

[3v dome](#)

[4v dome](#)

[5v dome](#)

[6v dome](#)

If you are building your dome from the bottom up, here is some useful information:

You will need to lay out the appropriate number of struts in a circle to get started. The numbers are given below.

1v dome - 5 struts

2v dome - 10 struts

3v 3/8 dome - 15 struts

3v 5/8 dome - 15 struts

4v dome - 20 struts

5v 3/8 dome - 25 struts

5v 5/8 dome - 25 struts

6v dome - 30 struts

#### **Are the lengths given from vertex to vertex?**

Yes, the lengths given are from vertex to vertex. If you are building a dome out of metal pipe by flattening the ends and

drilling holes, you will need to add about 3/4" to each end for a total of 1.5" for each strut. If you are building a dome using connectors, you will need to subtract twice the length of the connector (one for each end) from each strut.

**The dome calculator is great, but I want to build a dome using feet as my unit of measure. How do you go from decimals to feet or inches?**

Here's a walkthrough:

If you want to build a dome with a 12 ft. radius, you would put 12 in the calculator. For the 3V dome (just an example), you get:

$$A = 4.183$$

$$B = 4.842$$

$$C = 4.945$$

For the A strut, the 4 just means 4 ft. The .183 is a little harder to figure out. You want to convert the .183 from feet to inches, so multiply .183 by 12 (12 inches in a foot).

$$.183 \times 12 = 2.196 \text{ inches}$$

Now you have 4ft and 2.196 inches, almost there. Now you want to convert the 2.196 inches into 8ths of an inch (I don't think you have to go all the way to 16ths of an inch, unless you enjoy being tortured). You can do this by multiplying .196 by 8.

$$.196 \times 8 = 1.568 \text{ (round this up to 2)}$$

This gives you 2/8" or 1/4", so the new measurement is 4' 2 1/4"  
You should be able to do the other ones now.

Decimal Equivalents:

$$.12500 = 1/8$$

$$.25000 = 1/4$$

$$.37500 = 3/8$$

$$.50000 = 1/2$$

$$.62500 = 5/8$$

$$.75000 = 3/4$$

$$.87500 = 7/8$$

It would be nice if we could buy pvc in meters because it would be a lot easier to use the decimal measurements.

Example: 12 meter radius dome (3V)

$$A = 4.183$$

$$B = 4.842$$

$$C = 4.945$$

A = 4 meters and 18.3 centimeters (or 183 millimeters)

B = 4 meters and 84.2 centimeters

C = 4 meters and 94.5 centimeters

**What are 4, 5, and 6-way connectors? Do I need those?**

You don't need connectors if you are building a dome out of

metal conduit with the ends flattened and drilled (or something similar). The 4, 5, and 6 way connectors are just the points where that number of struts come together. The 4 way connectors are all on the bottom, and the 5-ways are where the A's come together. The rest of the connections are all 6-way. There's a really fine example of what connectors are on this [page](#). It takes a little while to load, but worth it. You have to scroll all the way down to see the connectors.

### **How do you build a dome out of a bunch of flat pieces?**

Well, the pieces are not exactly flat. The struts will need to be bent a little on each end to allow the dome shape to form. The bending angles are as follows:

1v dome: bend 32° on each end

2v dome: bend A's 18°, and B's 16° on each end

3v dome: bend A's 10°, B's and C's 12° on each end

4v dome: bend all struts 7°-9° on each end

5v dome: bend all struts 6°-7° on each end

6v dome: bend all struts 5°-6° on each end

### **I want to build a model first, but I don't know what to use for materials. Can you help?**

I recommend using 1/8" wooden dowels and 1/8" (inner diameter) clear vinyl tubing. You should be able to find these at any hardware store. Just make sure to buy the 1/8" inner diameter tubing. You will also need very small nuts and bolts to hold the tubing together. Just ask the salesperson at the hardware store, and they should be able to help you. Cut the tubing into one and a half inch (1.5") pieces, and punch small holes in the center with a leather punch. You will also need some 1" pieces of tubing for the 4 and 5 way connectors, but punch the holes on one end of these pieces instead of in the center. For the 6 way connectors, you will need 3 pieces of tubing with holes punched in the centers. Put the bolt through all three pieces, screw the nut on, and tighten it. It should look the picture in the diagram linked below. For the 4 way connectors, you will need one 1.5" piece, and two 1" pieces (remember, punch the holes on one end for these, and not in the center). Put the bolt and nut in, and tighten. For the 5 way connectors, use five 1" pieces and bolt them together. This is an example of the [6-way connector](#) for this model.

### **I'm going to [Burning Man](#) this year, and I was wondering what kind of dome you recommend.**

I know I used to say that PVC was the way to go, but now the answer is definitely metal conduit. Got to the new [Conduit Dome Tips](#) page for more info! PVC is light and a little cheaper, but it doesn't hold up as well. If you paint the ends of the struts on your conduit dome so they don't rust, the dome could last forever. (well, not really but you see what I'm getting at) For smaller domes 1/2" conduit is OK, but don't make the struts any longer

than 4'. For larger domes, don't show up at Burning Man with anything less than 3/4" conduit. You don't want to be that camp with the once beautiful dome that just got pulverized by the high desert winds. I know, it happened to me before (long story). Spend the extra money, you won't regret it when the dust storm comes and your structure is the only one left standing. Always bring extra pieces pre-cut and drilled just in case... There always seems to be one pole short, bent, or just plain messed up.

**But I really really want to build a PVC dome, how do I do it?**

If you have your heart set on PVC, here's a short explanation of the connectors. They are just short (4-5") pieces of conduit slipped into each end of the pvc. Make sure it's a tight fit, you can try them out at the hardware store before you buy them. A couple of sheet rock screws secures the pieces in the PVC. The ends of the conduit are flattened and bent slightly, then a hole is drilled in each one. Don't forget the sheet rock screws to hold the conduit inside the PVC. They are very important, and speaking from experience, don't leave ANY out (long story, same one from above). Two screws in each end. Yes, longer bolts will be necessary for the 5 and 6 way connections. I think I bought 2" long bolts, and they were almost long enough. I think 3" would be plenty long enough.

**How do you secure your dome to the desert floor?**

For tie downs, we used rebar (at least 2 ft.) bent to resemble a candy cane. Every other point on the bottom of the dome got a stake over the conduit that lays on the ground. Pound them all the way in, you don't want any of your fellow playa people getting hurt.





# Desert Domes

## Making the world a "Fuller" place

HOME

DOME CALCULATOR

DOME FORMULAS

BAMBOO DOMES

CONDUIT DOME TIPS

FAQ

DOMES FOR SALE

PHOTO GALLERIES

LINKS

ABOUT ME

BIBLIOGRAPHY

### DOMES FOR SALE

I've decided to start selling dome frames online for people who are either not mechanically inclined or simply not willing to do it themselves. I do not plan to ship these unless you really, really want me to. The price of shipping would be too high in my opinion for this to be worthwhile. If you live in the San Francisco Bay Area, you can simply drop by and pick up your dome when it is ready. I have compiled a list of common sized domes and their prices. If there is a dome that you would like that is not listed below, just e-mail me and I can give you a price quote.

Since the prices are entirely dependent on the price of steel, they are subject to change. A 50% deposit for all domes is required. Payments can be made by cash, check, or credit card.

**Unfortunately, we are no longer accepting orders for domes for Burning Man.** All orders taken at this time will not be processed until after September 7. I have been hired by the Burning Man organization to build the dome under the man, so all of my time from the first week of August until Burning Man will be devoted to that.

|                            |                         |
|----------------------------|-------------------------|
| 17' Diameter 2v Dome       | \$550 (\$275 deposit)   |
| 24' Diameter 3v Dome (5/8) | \$1350 (\$675 deposit)  |
| 32' Diameter 4v Dome       | \$2000 (\$1000 deposit) |

Prices are for 3/4" conduit frame domes. Domes come with all nuts, bolts and washers needed for assembly.



# Desert Domes

Making the world a "Fuller" place

- HOME
- DOMe CALCULATOR
- DOMe FORMULAS
- BAMBOO DOMES
- CONDUIT DOMe TIPS
- FAQ
- DOMES FOR SALE
- PHOTO GALLERIES
- LINKS
- ABOUT ME
- BIBLIOGRAPHY

## PHOTO GALLERIES



Burning Man Domes



Burning Man '97



Burning Man '98

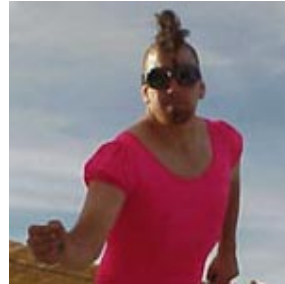

Burning Man '99



Mardi Gras 2000



Mardi Gras 2001



Mardi Gras 2002

© 2002 Desert Domes || Oakland, California



# Desert Domes

## Making the world a "Fuller" place

HOME

DOME CALCULATOR

DOME FORMULAS

BAMBOO DOMES

CONDUIT DOME TIPS

FAQ

DOMES FOR SALE

PHOTO GALLERIES

LINKS

ABOUT ME

BIBLIOGRAPHY

## LINKS

### Sites Dedicated to Buckminster Fuller

[The Buckminster Fuller Institute](#)

[Online Edition of A Fuller Explanation](#)

[The Bucky Fuller Travelling Miracle Medicine Show](#)

### Geodesic Dome Sites

[Design and Implementation for a Geodesic Dome](#)

[Mathworld's Geodesic Page](#)

[Earl's Geodesic Domes](#) - Has some really useful information on modifying dome geometry to allow for doors

[Cardboard Domes](#) - This site shows you everything you need to know about making cardboard domes for Burning Man

[Hoberman Associates](#)

[Applied Synergetics Home Page](#)

[Beezer's PlayDome Page](#) - Tire Domes

[Hexayurts](#)

[How to make a 2V newspaper dome](#)

[Welcome To Zometool](#)

[Detail Plans for a Geodesic Dome Observatory](#)

[Geodesic Structures by Steve Miller](#) - This site also includes plydomes

[Geodesics Unlimited](#)

[Geodesic Domes at Kibbutz Lotan](#)

[Links to geodesic and alternative building](#)

[Professional Dome Plans](#)

### Math Sites

[The Math Studio](#)

[Natural Math Multiplication](#)

[Polyhedreality](#)

## Burning Man

[The Burning Man Project - Official Site](#)

[Camp Roller Disco](#)

[Space Lounge](#) - Has conduit dome plans online

## Earth Friendly Web Sites

[Earthship](#)

[Studio of Indigenous Designs](#)

[Energy Efficient Building Association](#)

[Green Design Network](#)

[Woodwise](#) - Help protect the world's forests

[Sierra Solar Systems](#)

## Friends' Web Pages

[Da Funhouse](#)

[Bradley Green](#)

## Catalogs

[Cool Neon](#) - The ONLY place to order flexible neon wire!

[American Science and Surplus](#) - Really cool catalog!

[Edmund Scientific](#)



# Desert Domes

## Making the world a "Fuller" place

[HOME](#)

[DOME CALCULATOR](#)

[DOME FORMULAS](#)

[BAMBOO DOMES](#)

[CONDUIT DOME TIPS](#)

[FAQ](#)

[DOMES FOR SALE](#)

[PHOTO GALLERIES](#)

[LINKS](#)

[ABOUT ME](#)

[BIBLIOGRAPHY](#)

### ABOUT ME

I recently graduated in mechanical engineering at the University of Louisiana at Lafayette, and I'm looking forward to actually finding a job. If you know anyone who is looking for someone like me, please e-mail me and I can send them my resume'. I just moved to Oakland, California, so I would like to find a job here in the Bay Area. I am from Louisiana, and am proud to call myself a cajun. I thought I might take this opportunity to clear up a few misconceptions about cajun people. We do not bite the heads off of alligators like in The Waterboy. We do eat alligator on occasion, but the truth is, it's not all that great. New Orleans isn't the only city in Louisiana, and we do not all live there. We don't all have a "cajun" accent. Some of us do, some of us don't. Cajun food is not meant to make you lunge for the nearest glass of water as soon as you take a bite. Making food spicy doesn't make it cajun. If you want to try authentic cajun food, you will have to go to Louisiana to get it.

OK. Now that I've gotten that off my chest, I guess I need to explain how this whole geodesic dome thing started. I went to Burning Man for the first time in 1996 and was not fully prepared for the SUN. I had been living in San Francisco for two years and had not seen the sun very much during that time. If you live there or have ever visited, you know what I'm talking about. Anyway, we spent all of our days following the shade and waiting for the sun to go down. I explored around a bit and noticed that the people who had domes were able to find shade all the time. What a concept! I decided that I was going to build a dome for our camp the next year. Of course I went straight to my computer when I got home and searched the internet for information on how to make a geodesic dome. There were pages about domes, but none of them gave me the information that I needed. The next day I went to the San Francisco Public Library, and found what I was looking for. While I was in the process of learning how to build my first dome, I started working on a website that would teach other people how to build their own domes. It started out with just a few pages, and gradually escalated to what you see today. This is a completely free website, and will be as long as I can afford it. Thank you for all of the wonderful e-mails that you sent over the years, (I do read all of them) and good luck with your domes!

Tara Landry



© 2002 Desert Domes | | Oakland, California





# Desert Domes

Making the world a "Fuller" place

HOME

DOME CALCULATOR

DOME FORMULAS

BAMBOO DOMES

CONDUIT DOME TIPS

FAQ

DOMES FOR SALE

PHOTO GALLERIES

LINKS

ABOUT ME

BIBLIOGRAPHY

## BIBLIOGRAPHY

[Geodesic Math and How to Use It](#) by Hugh Kenner - This book is set to be re-released in October of this year, and you can pre-order now! It's in paperback form and priced moderately at \$13.27

Dome Builder's Handbook No. 2 by Wiliam Yarnell  
Running Press; (October 1978)  
ASIN: 0894710427

Domebook One  
Pacific Domes - edited by Lloyd Khan  
Bolinás, CA, 1970

Domebook 2  
Pacific Domes - edited by Lloyd Khan  
Bolinás, CA, 1971



# Desert Domes

Making the world a "Fuller" place

HOME  
DOME CALCULATOR  
DOME FORMULAS  
BAMBOO DOMES  
CONDUIT DOME TIPS  
FAQ  
DOMES FOR SALE  
PHOTO GALLERIES  
LINKS  
ABOUT ME  
BIBLIOGRAPHY

## Catadomes and Kiddie Korral

### 5:30 and Esplanade



Kiddie Korral will be a pitstop for families on the go at Burning Man. Ideal for any folks with a rugrat in the 1-3 yr range who want to take a break and hang out day or night while cruising the Esplanade. All others can check out our collection of dome building styles, including an elliptical dome. Click [here](#) to see our camp garbage plan.

Don't forget to bring your skates for the Roller Disco!

Need some CoolNeon wire? Don't know what that is? Click [here!](#)

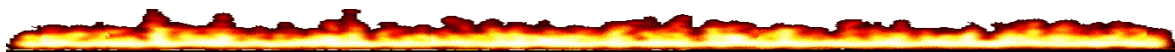





# Desert Domes

## Making the world a "Fuller" place

HOME

DOME CALCULATOR

DOME FORMULAS

BAMBOO DOMES

CONDUIT DOME TIPS

FAQ

DOMES FOR SALE

PHOTO GALLERIES

LINKS

ABOUT ME

BIBLIOGRAPHY

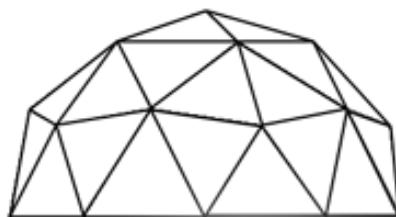

Dome Radius:

Don't include units here. For example, if you want to build a dome that's 10' 6" high, enter 10.5

| Strut            | Length | Dome | Sphere |
|------------------|--------|------|--------|
| A                |        | 35   | 60     |
| B                |        | 30   | 60     |
| 4-way connectors |        | 10   | 0      |
| 5-way connectors |        | 6    | 12     |
| 6-way connectors |        | 10   | 20     |

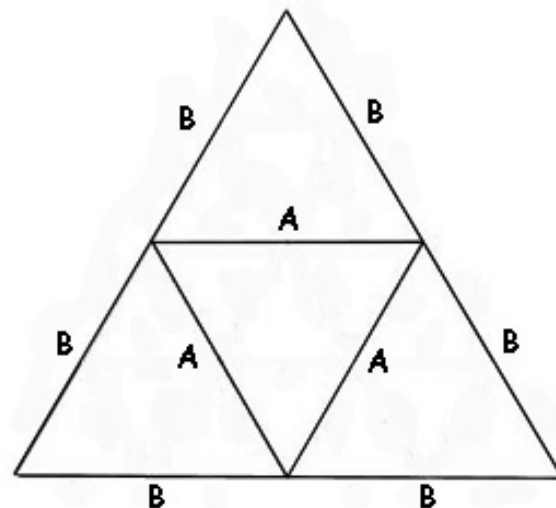

[How to make a 2V newspaper dome Assembly Diagram](#)



# Desert Domes

Making the world a "Fuller" place

- HOME
- DOME CALCULATOR
- DOME FORMULAS
- BAMBOO DOMES
- CONDUIT DOME TIPS
- FAQ
- DOMES FOR SALE
- PHOTO GALLERIES
- LINKS
- ABOUT ME
- BIBLIOGRAPHY

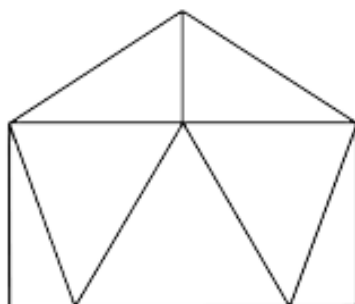

Dome Radius:

**Don't include units here. For example, if you want to build a dome that's 10' 6" high, enter 10.5**

| Strut            | Length | Dome | Sphere |
|------------------|--------|------|--------|
| A                |        | 25   | 30     |
| 5-way connectors |        | 6    | 12     |
| 4-way connectors |        | 5    | 0      |



# Desert Domes

Making the world a "Fuller" place

- HOME
- DOME CALCULATOR
- DOME FORMULAS
- BAMBOO DOMES
- CONDUIT DOME TIPS
- FAQ
- DOMES FOR SALE
- PHOTO GALLERIES
- LINKS
- ABOUT ME
- BIBLIOGRAPHY

## DOME CALCULATOR

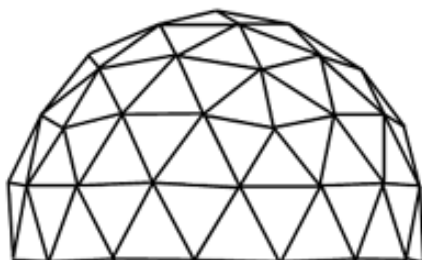

Dome Radius:

**Don't include units here. For example, if you want to build a dome that's 10' 6" high, enter 10.5**

| Strut            | Length | 3/8 | 5/8 | Sphere |
|------------------|--------|-----|-----|--------|
| A                |        | 30  | 30  | 60     |
| B                |        | 40  | 55  | 90     |
| C                |        | 50  | 80  | 120    |
| 4-way connectors |        | 15  | 15  | 0      |
| 5-way connectors |        | 6   | 6   | 12     |
| 6-way connectors |        | 25  | 40  | 80     |

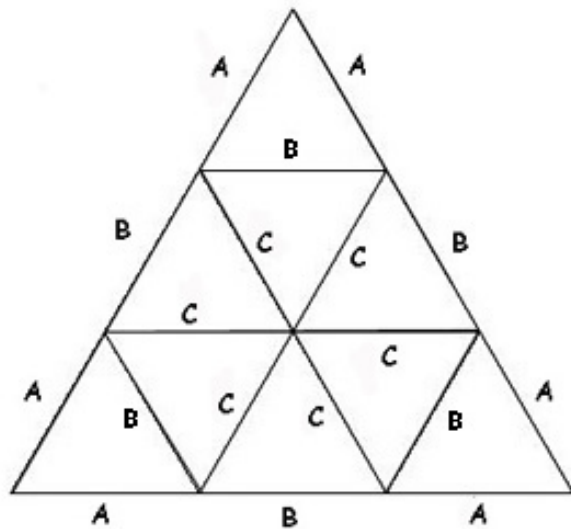

[Assembly Diagram](#)



# Desert Domes

Making the world a "Fuller" place

- HOME
- DOME CALCULATOR
- DOME FORMULAS
- BAMBOO DOMES
- CONDUIT DOME TIPS
- FAQ
- DOMES FOR SALE
- PHOTO GALLERIES
- LINKS
- ABOUT ME
- BIBLIOGRAPHY

## DOME CALCULATOR



Dome Radius:

Don't include units here. For example, if you want to build a dome that's 10' 6" high, enter 10.5

Check out the new [FAQ page!](#)

| Strut            | Length | Dome | Sphere |
|------------------|--------|------|--------|
| A                |        | 30   | 60     |
| B                |        | 30   | 60     |
| C                |        | 60   | 120    |
| D                |        | 70   | 120    |
| E                |        | 30   | 60     |
| F                |        | 30   | 60     |
| 4-way connectors |        | 20   | 0      |
| 5-way connectors |        | 6    | 12     |
| 6-way connectors |        | 65   | 150    |

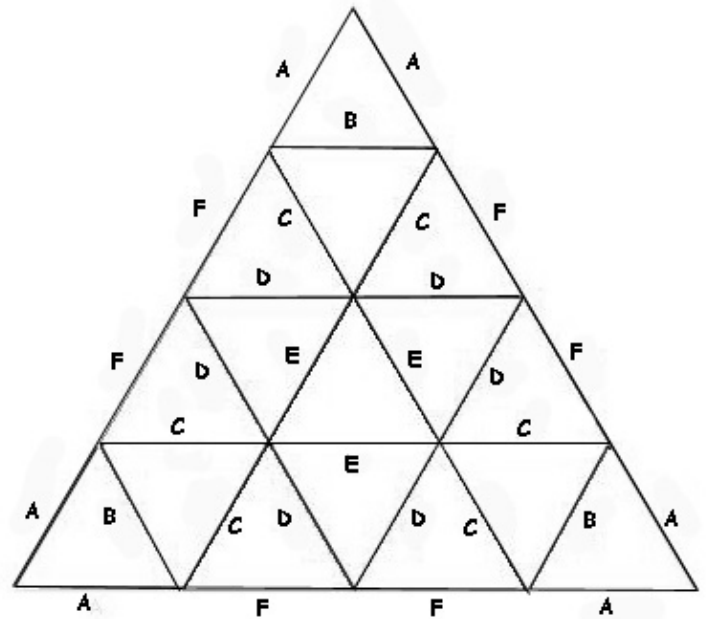

[Assembly diagram](#)



# Desert Domes

## Making the world a "Fuller" place

[HOME](#)  
[DOME CALCULATOR](#)  
[DOME FORMULAS](#)  
[BAMBOO DOMES](#)  
[CONDUIT DOME TIPS](#)  
[FAQ](#)  
[DOMES FOR SALE](#)  
[PHOTO GALLERIES](#)  
[LINKS](#)  
[ABOUT ME](#)  
[BIBLIOGRAPHY](#)

### DOME CALCULATOR

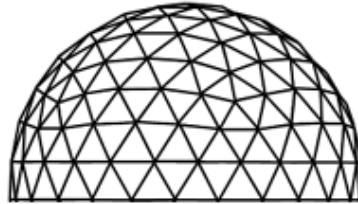

Dome Radius:

Don't include units here. For example, if you want to build a dome that's 10' 6" high, enter 10.5

Check out the new [FAQ page!](#)

| Strut            | Length | 3/8 | 5/8 | Sphere |
|------------------|--------|-----|-----|--------|
| A                |        | 30  | 30  | 60     |
| B                |        | 30  | 30  | 60     |
| C                |        | 60  | 60  | 120    |
| D                |        | 60  | 70  | 120    |
| E                |        | 50  | 70  | 120    |
| F                |        | 50  | 80  | 120    |
| G                |        | 30  | 35  | 60     |
| H                |        | 30  | 30  | 60     |
| I                |        | 10  | 20  | 30     |
| 4-way connectors |        | 25  | 25  | 0      |
| 5-way connectors |        | 6   | 6   | 12     |
| 6-way connectors |        | 95  | 120 | ??     |

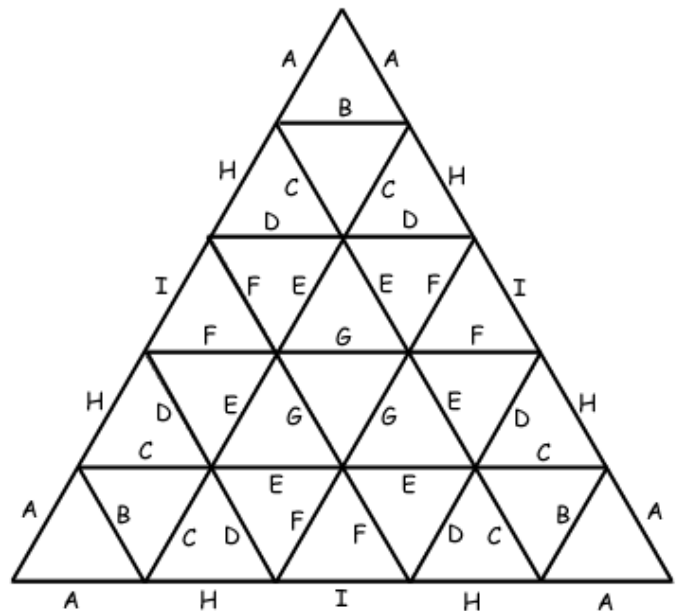

[Assembly diagram](#)



# Desert Domes

Making the world a "Fuller" place

- HOME
- DOME CALCULATOR
- DOME FORMULAS
- BAMBOO DOMES
- CONDUIT DOME TIPS
- FAQ
- DOMES FOR SALE
- PHOTO GALLERIES
- LINKS
- ABOUT ME
- BIBLIOGRAPHY

## DOME CALCULATOR

Dome Radius:

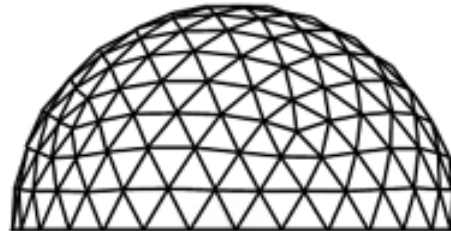

Don't include units here. For example, if you want to build a dome that's 10' 6" high, enter 10.5

| Strut | Length | Dome | Sphere |
|-------|--------|------|--------|
| A     |        | 30   | 60     |
| B     |        | 30   | 60     |
| C     |        | 60   | 120    |

|                  |  |     |     |
|------------------|--|-----|-----|
| D                |  | 90  | 180 |
| E                |  | 30  | 60  |
| F                |  | 60  | 120 |
| G                |  | 130 | 240 |
| H                |  | 65  | 120 |
| I                |  | 60  | 120 |
| 4-way connectors |  | 30  | 0   |
| 5-way connectors |  | 6   | 12  |
| 6-way connectors |  | 160 | ??  |

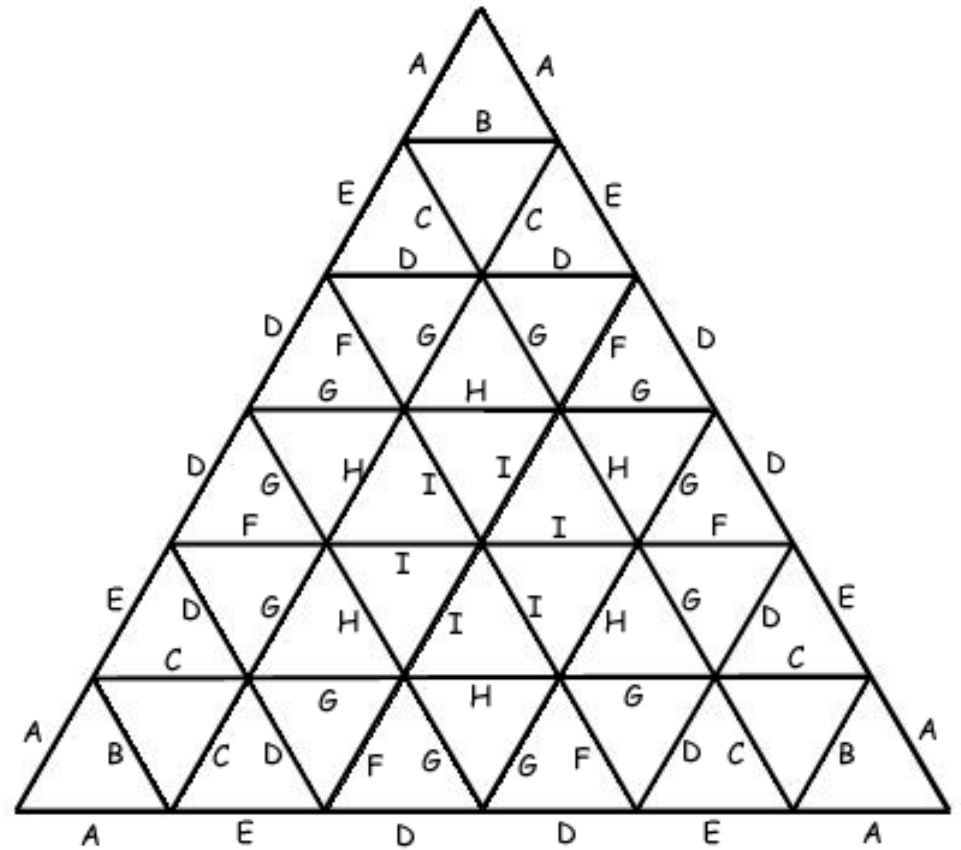

© 2002 Desert Domes | | Oakland, California



# Desert Domes

Making the world a "Fuller" place

- HOME
- DOME CALCULATOR**
- DOME FORMULAS
- BAMBOO DOMES
- CONDUIT DOME TIPS
- FAQ
- DOMES FOR SALE
- PHOTO GALLERIES
- LINKS
- ABOUT ME
- BIBLIOGRAPHY

## DOME CALCULATOR

2V

3V

4V

5V

1V

6V

Need some Cool Neon wire to decorate your dome? Don't know what that is?  
Click [here!](#)

© 2002 Desert Domes | | Oakland, California



# COOL NEON

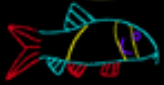

RIDING THE PHAT LINE BETWEEN BUSINESS AND PLEASURE

HOME  
SHOP  
WHAT'S NEW  
WARRANTY  
PRICE GUARANTEE  
SOLDERING  
SPECIALS  
SHIPPING  
PHOTO GALLERY  
ABOUT US  
ELVES  
ROLLER DISCO  
FUNHOUSE  
DIRECTIONS  
LINKS



**Come visit us at 5:30 and Esplanade  
at the Catadomes and Kiddie Korral**

**Benjamin has left for The Playa.**

**We will be closed for Labor Day weekend from September 3rd  
through September 6th.**

**We discourage you from soldering on the playa. It's a bad idea for  
many reasons. So do try to finish your projects before leaving.**

**Check out the San Francisco [Chronicle's big Burning Man](#) article  
(8-30-04). All the photos are of our campmates, and there is a sweet  
plug for Cool Neon.**

**If you drop by our home; Catadomes and Kiddie Korral at 5:30 &  
Esplanade, please remember that we'll be off tech support duty, but  
eager to see your amazing creations (look for the red dome).**

### **The Funhouse Elves**

Greetings, and welcome to the online home of Funhouse  
Productions

Purveyors of Cool Neon electroluminescent fiber

Low Price Guarantee

Funhouse Productions will NOT be undersold!

We will SELL you the product for 10% LESS than the competitor's  
price!

If you see Coolneon wire or accessories advertised on another  
Web Site at a price that is lower than Funhouse Productions price  
then you can take advantage of our Low Price Guarantee in one  
of three ways:

1. If you are ordering from our website, just copy and paste the URL (address) of the website that has the lower price, into the "Special Instructions" field of the order form on our website. We'll check it out immediately and we will ship your item at the lower price.

2. Email us at:

3. Call us at 510-547-5878

We will need the following information:

a. The website address

b. Their part number and price

We'll check out the web site. Once we confirm their price we will SELL you the product for 10% LESS than the competitor's price. If their shipping charge is less, we will match their shipping charge!

Note: no matter what you pay for our products they will always come with the highest level of friendly customer support, technical assistance, and our [guarantee](#).

Be sure to keep an eye on our fabulous, Cool Neon [Specials](#) page for new, and exciting bargains.... The products on this page are usually in short supply, so be sure to order quickly if something catches your eye. This page is now being updated on a near daily basis, so check back often for the really good deals!!!

Cool Neon is a new material you may have heard of. If you haven't seen it, we know you'll be delighted the first time you make it glow. It looks like neon, but it doesn't heat up with use (hence the "cool" in the name -- and you thought we were just being groovy!).

**Cool Neon** is a bright, glowing wire of phosphor (same as what's in your TV) in a clear, flexible tube that's just a tenth of an inch wide. Totally safe and non-toxic, it's durable and lightweight; you can bend it, shape it, even braid pieces of it together -- no problem! It's perfect for safety lighting, wrapping around yourself or your bicycle, home décor, night lights, and countless other uses. Wherever it's dark, Cool Neon stuns! For more information, go to our Products page. If you've experienced Cool Neon, we don't have to tell you it's truly magical. It really will take you to the farthest reaches of your imagination. We'd love to help you get there! checkout [What's New](#)

Funhouse Productions  
1419 Mandela Parkway  
Oakland, CA 94607  
phone 510.547.5878 \* fax 510.663.6462  
email:

Authorized distributor and direct importer of LYTEC  
electroluminescent wire  
Elam USA Inc  
P.O.BOX 1029

WAINSCOTT, NY 11975

WE  
PROUDLY  
ACCEPT:



Authorized Distributor  
Protected by U.S patent No. 5,485,355  
and China patent no. ZL-97121158.2

© 2002 Cool Neon | | Oakland, California

## Dome Sizes

16ft Dome  
16ft Riser  
20ft Dome  
24ft Dome  
30ft Dome  
36ft Dome  
44ft Dome  
60ft Dome

## Why Domes

Shelters  
Event Dome  
Playground  
Greenhouse  
projection  
Mandala

## Features

Frame  
Covers  
Door  
Windows  
Wood Stove  
Screens  
Connecting  
Interiors  
Floors

## Extras

Winter Liners  
Insulation  
Skylight  
Air Chairs  
Eco Toilet  
Floating Bed

## Technical Information

Fabric Options  
Floor Plans  
Frame Diagrams  
Engineering Specs  
Anchoring  
Fabric Treatment

## Order Info

Prices  
Shipping

## Contact Us

## Links

## Photos



# PACIFIC DOMES

## SHELTERS FOR FREEDOM WORLDWIDE

247 Granite Street Ashland, OR 97520

**1-888-488-8127**

**Pacific Domes** -Ideal family dwelling guest house workshop or yoga studio. Architecturally engineered steel frame handles heavy snow & hurricane winds. Durable covers are weathertight / windows, screens & wood stove set-up. Winterizing kits available.



Pacific Domes is a family owned and operated business located in the Siskiyou Mountains of southern Oregon. Since 1980 we have been working on perfecting the function and beauty of our portable Geodesic Domes. We combine the [sacred geometry](#) of R. Buckminster Fuller with our progressively designed covers to bring you this futuristic Zen structure.

Our Domes illuminate with natural light creating an atmosphere of being close to nature in a comfortable environment. From Michigan winters to Arizona summers, people live comfortably in our Domes.

Any questions? Give us a buzz at [info@pacificdomes.com](mailto:info@pacificdomes.com)

**Please note that we can answer your questions most effectively by telephone.**

**Please call us toll free: **1-888-488-8127** or:  
**1-541-488-7737****

Mandalas



Mandalas



**DomeWorks**

DomeWorks, our partner company, provides installation, rental, and design to create World Class Environments for Weddings, Movie Sets and Trade Shows.

**Click Here To Visit the Website**

Copyright ©2004 Pacific Domes

---

[Email: info@pacificdomes.com](mailto:info@pacificdomes.com)

247 Granite Street  
Ashland, OR 97520  
©2001 Pacific Domes

1-888-488-8127  
1-541-488-7737

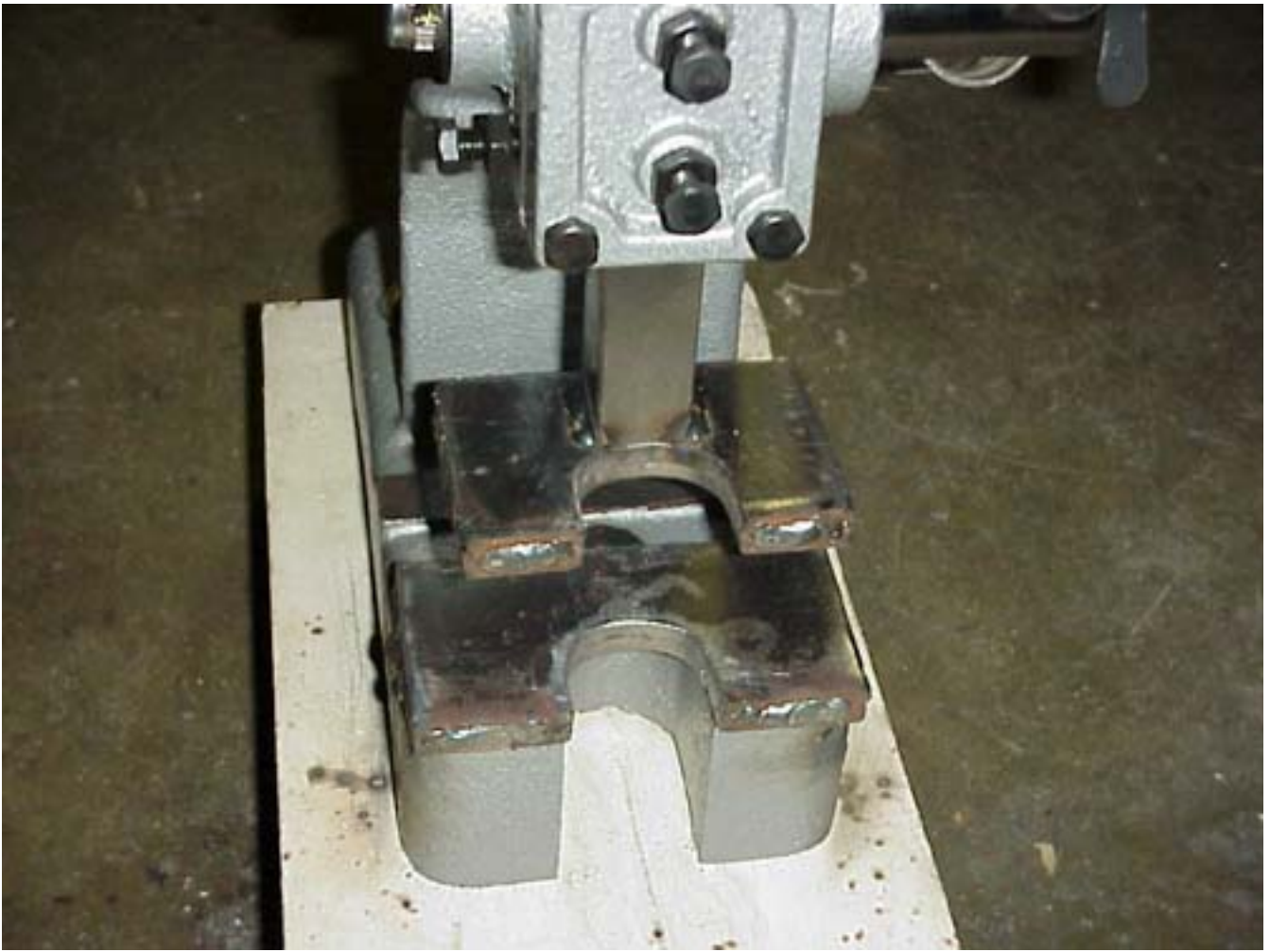

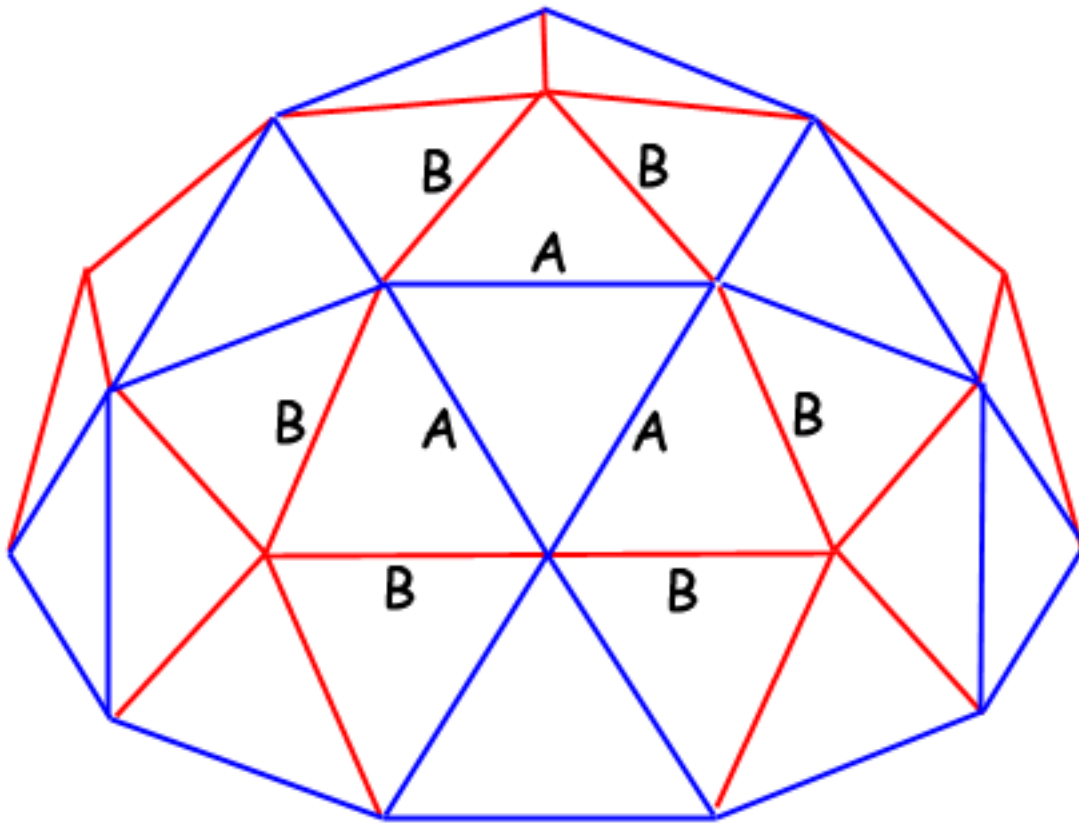

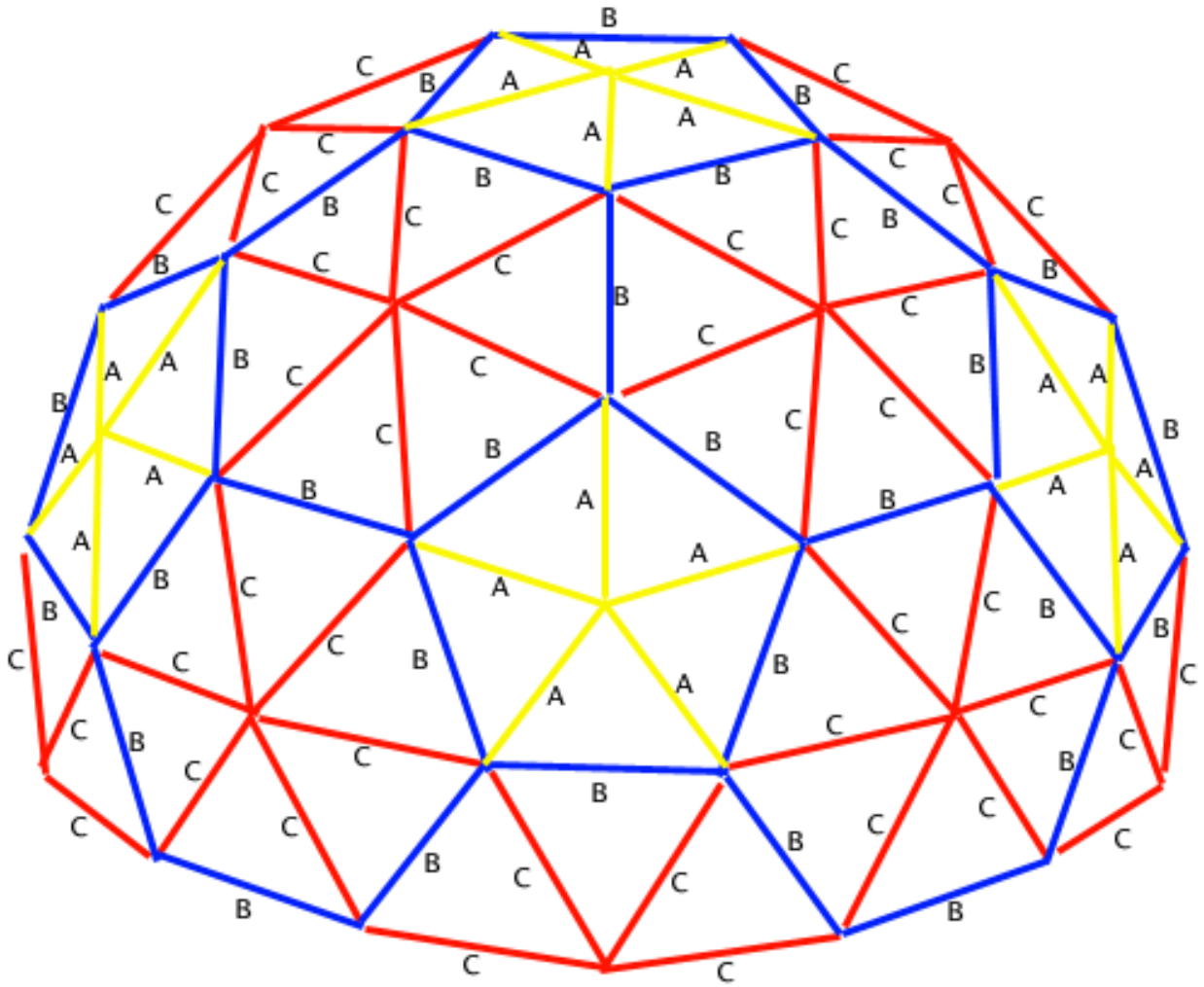



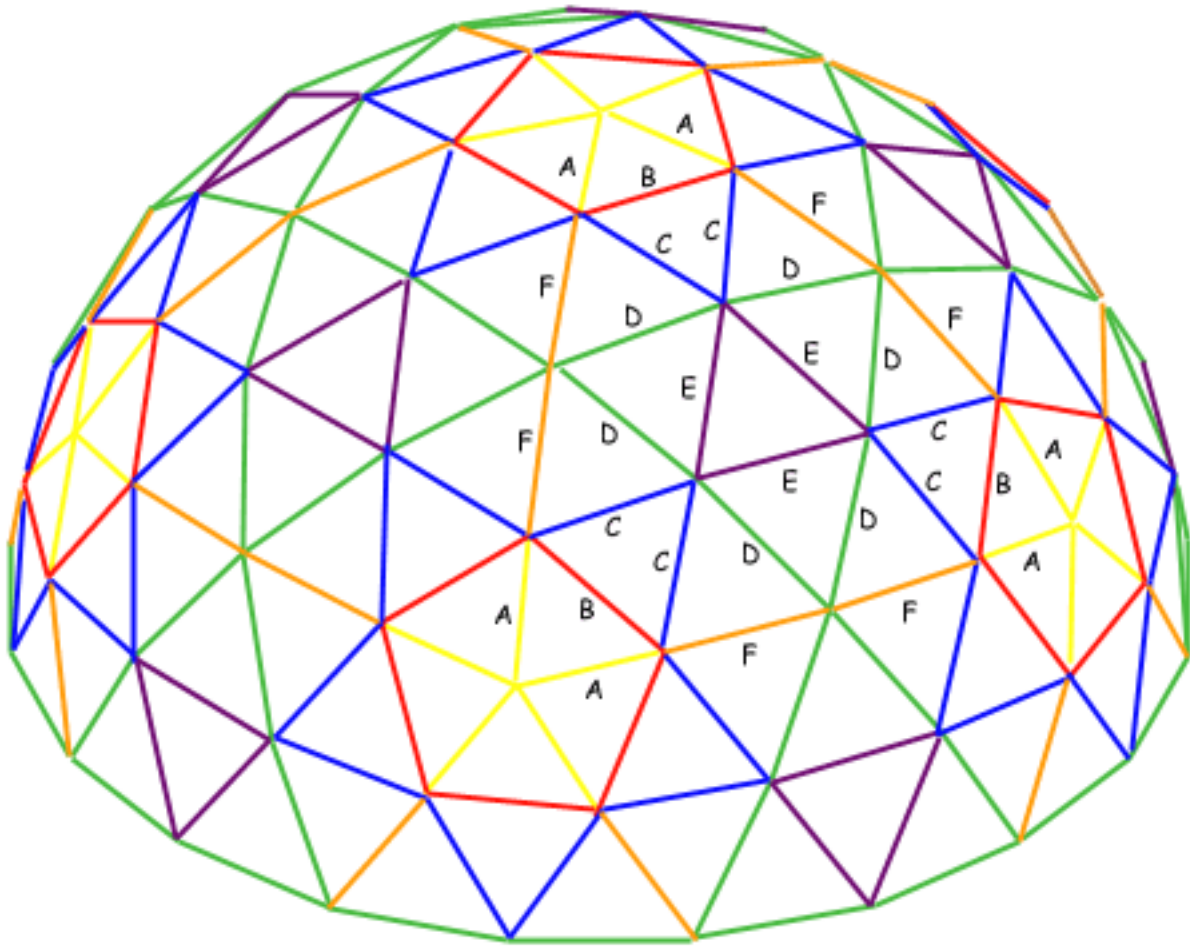

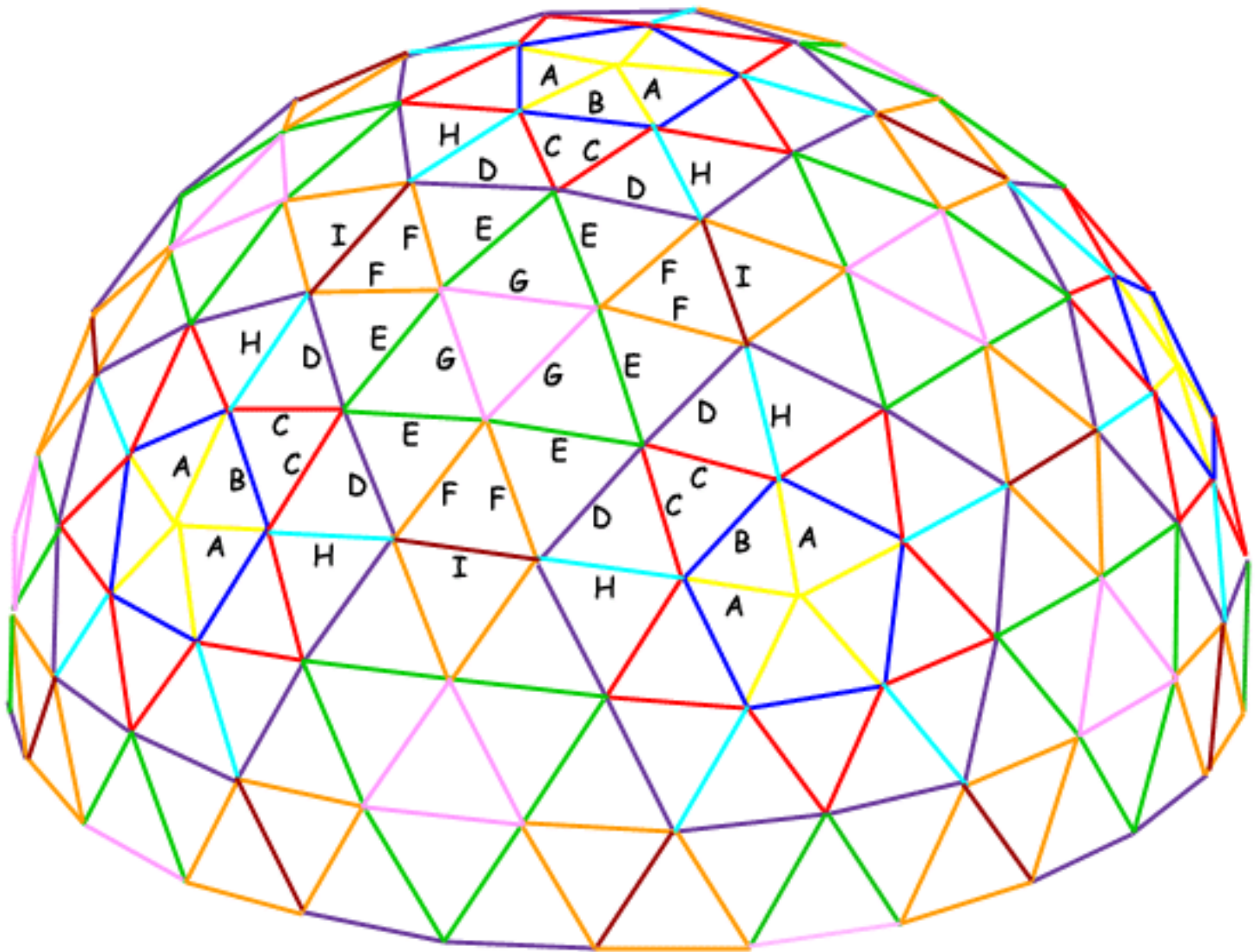

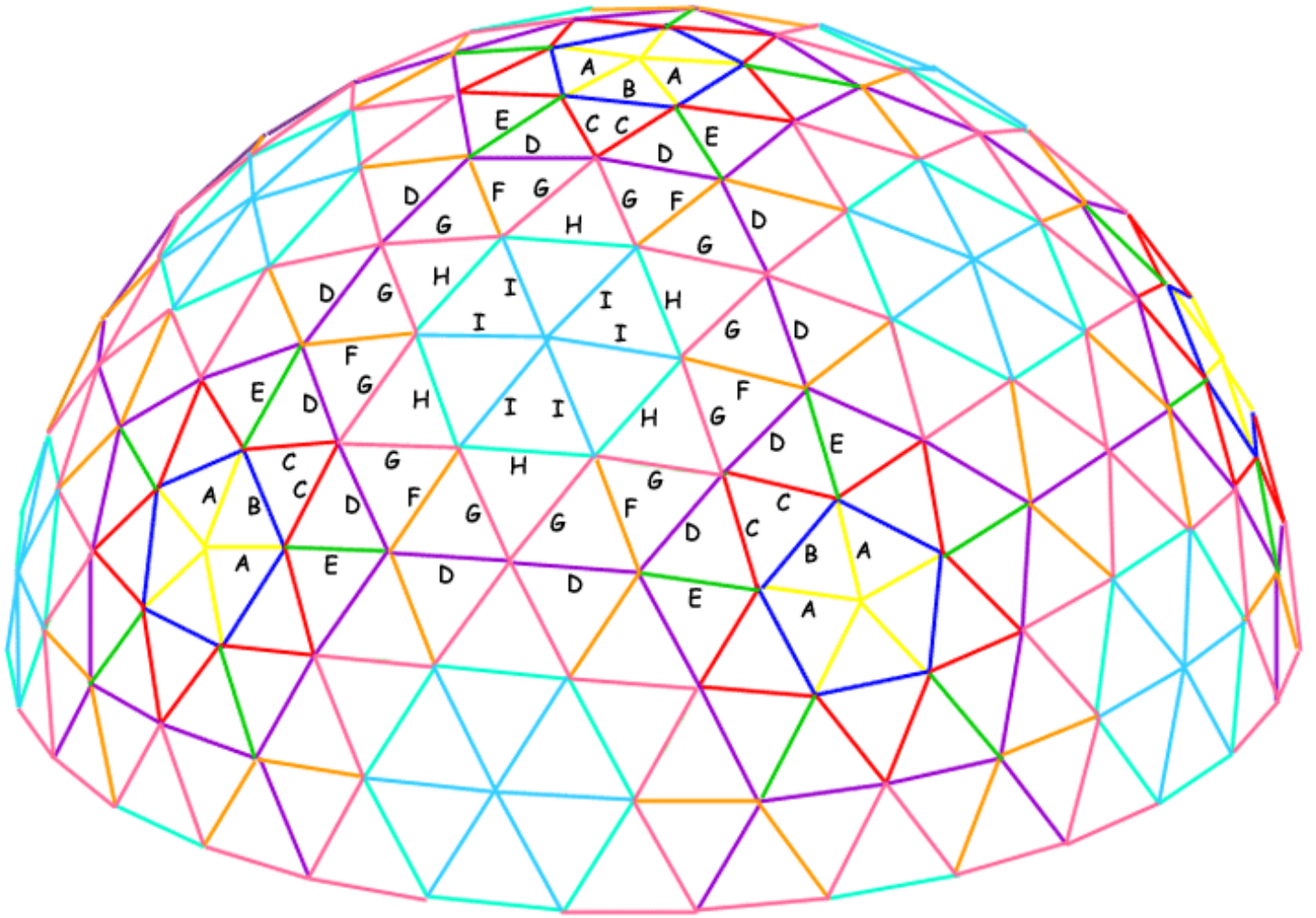

# The Home Dome

[Home](#)[Burning Man](#)[Timefold](#)[Band](#)[Skating](#)[Writing](#)[Polymer Clay](#)[3na the Jellyfish](#)[▶ The Home Dome](#)[Cutting Struts](#)[Drilling Struts](#)[Assembly](#)[The Desert Nose](#)[Roller Disco 2002](#)[101](#)[The Fishmobile](#)[Camp Nose Fish 2004](#)

I built a 20' diameter geodesic dome using 3/4" electrical conduit (metal pipe). It will be my home at Burning Man.

Follow the [Photo Tour](#) to see how the parts were made and for more photos of the finished dome.

Here's some [diagrams](#) that show how to cover a dome with tarps. I use costco tarps which are 12' x 16' at the price of 2 for \$14. It leaves a hole at the top, which is ideal for ventillation. Attach another tarp over the hole with three permanant ropes, plus one you use to attach it at night and to pull the top tarp on or off. A 10' sqare top tarp is idea size for an optimal 2v dome. or a 3v dome with a 16 foot diameter, etc.

I built the dome based on figures produced by [The Dome Calculator](#) at <http://www.desertdomes.com>. Mine is a "3 frequency" dome, built to about 3/8ths of a sphere.



I covered it with a 35' diameter olive drab Army surplus parachute which I purchased through Ebay. I set up my tent inside the dome, and it nestles nicely against the curved inside of the dome. I plan to cut remnant carpet into triangles and place them on the floor.

### **Don't use a parachute for your dome!**

The only thing that didn't work in my 2000 Burning Man experience was trying to use a parachute for a covering. As it turned out, a parachute has none of the right characteristics and many of the worst possible characteristics imaginable. Here's just a sampling of why I think a parachute is the exact opposite of what you need for a dome covering:

- It catches the wind and applies extra forces to your dome. Parachutes are designed to catch the most wind possible by weight. What you want is for wind to slip over your dome. A parachute presses against the struts and forms lots of tiny parachutes trying their best to slow your dome down with respect to the wind... ;-)
- It catches the rain in pockets which form when the material between the struts sags under the weight. The water pours through these sagging reservoirs, drilling holes in the playa beneath, even right through a carpet. Parachutes are not waterproof.
- It whips mercilessly in the wind causing enough noise that you have to raise your voice substantially to be heard. Parachutes are loud, but offer no acoustic insulation! Gee, could it get any worse? Yes! Read on...
- It gets tangled when you try to put it on your dome. Believe it or not, shingling panels of silver tarps is probably the best idea. Shingling means coving from the bottom toward the top, and having higher tarps overlap lower tarps. Water rolls off, and no one tarp is too big to handle, even in the wind. Parachutes are unweildy.
- If all that isn't enough, a parachute is translucent and traps air. In other words, your dome becomes an oven during the day because the covering traps the sun's energy in the air inside your dome. Parachutes form ovens, not shade structures.

I also have a hammock and two awesome Lafuma reclining chairs, a table and whatever else I have room to bring. I want to create a chill space which is visually private, shaded, but still with enough space to not feel cramped. And during the night, it will be nice to lower the canopy for privacy and warmth.

The desertdomes.com web site has an incredible FAQ about how to build domes out of metal conduit. The FAQ surely saved me a lot of time, frustration and wasted material.

It took me two days to produce about 130 pieces. The first day I cut the

pieces to length and flattened the ends of about 1/3 of the pieces using a manual press. The second day I flattened the rest of the pieces and drilled holes in each end at just the right positions. Then I spray painted the ends of each piece and let them all dry.

It took me three hours on the third day to assemble the dome from pieces using 3/8" carriage bolts, fender washers, lock washers and nuts. I needed a stepladder which was about 3' tall to finish the top but I'll figure out something else to stand on for Burning Man.

Once assembled it is remarkably strong! You can climb on it, but I ask that people avoid putting their weight on the middle of any of the pieces -- you can climb from vertex to vertex. The triangles at the bottom are different sizes, but the largest is just big enough for me to wheel my bike into. :-)

The total cost of the materials for the dome was about \$200, and you can get a Parachute for about \$40-\$50. Steven's Creek Surplus in San Jose had them for \$40 at the time I wrote this page (7/5/2000). The rebar for the stakes cost another \$2.25 each and I needed 8. So the total cost was less than \$275.

---

Problems? Contact the webmaster: [hoco@timefold.com](mailto:hoco@timefold.com)

All information copyright 2000-2004 Howard Cohen. All rights reserved worldwide.

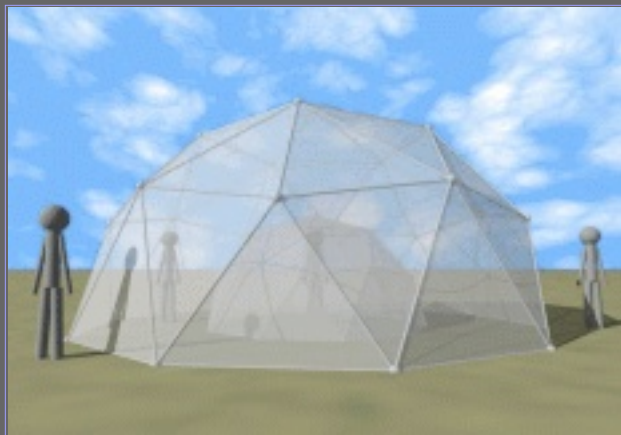

# Design and Implementation for a Geodesic Dome

Portable robust shade structure for [Geodesika](#) and other hard core temporary outdoor scenarios.

[home](#) [antarctica](#) [audio](#) [DOME](#) [music](#) [movies](#) [research](#) [resume](#) [scrytch](#) [software](#)

|                                    |                                      |                                   |                                  |                                |                           |                              |                           |
|------------------------------------|--------------------------------------|-----------------------------------|----------------------------------|--------------------------------|---------------------------|------------------------------|---------------------------|
| <a href="#">small dome details</a> | <a href="#">hi-freq dome designs</a> | <a href="#">covering patterns</a> | <a href="#">spherical models</a> | <a href="#">misting system</a> | <a href="#">VRML camp</a> | <a href="#">bibliography</a> | <a href="#">Hexayurts</a> |
|------------------------------------|--------------------------------------|-----------------------------------|----------------------------------|--------------------------------|---------------------------|------------------------------|---------------------------|

## Purpose

The stick figure people depicted in the cartoon images are about 6 feet (2 meters) tall.

Geodesika is a festival in the mountains at the beginning of summer. Burning Man is a festival in the desert at the end of summer. It gets hot and sunny during the day, so shade structures are crucial. The larger and more portable, the better. They should also be cheap, easy to assemble, and stable enough to withstand strong winds. A geodesic dome fits that description.

Portable geodesic domes and other large tent structures are commercially

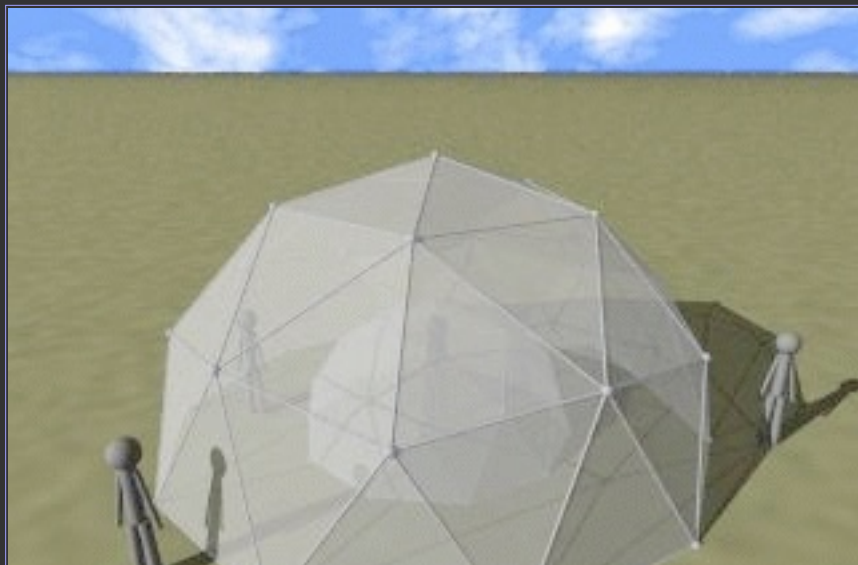

available. (Some information is provided below for some manufacturers.) However, they tend to be either expensive or flimsy, and definitely less fun and versatile than a home-made structure.

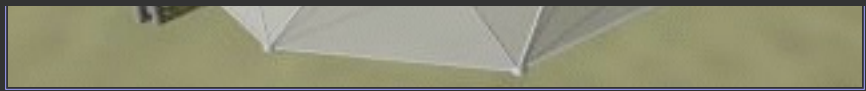

Some materials for the geodesic dome covers are translucent and white, and could have light projections coming from either outside or inside.

## Design

One of the benefits of a geodesic dome is that they are made of triangles. Triangular structures can not deform without deforming the edges, unlike parallelepipeds or other structures based on polygons with more than 3 edges. For example, a triangle can not be squashed, but a rectangle can be squashed into a parallelogram just by changes in angles at the vertices. The idea behind geodesics is to exploit geometry to obtain greater structural integrity. However, geodesic structures have a drawback: In practice, it is difficult to align the vertices, and if there is misalignment, the structural integrity is compromised. The smaller the number of edges, the less problems with alignment, but the longer the edges. Longer edges require stronger materials to maintain their integrity. The design presented here is an attempt to compromise on these issues.

## Geometry

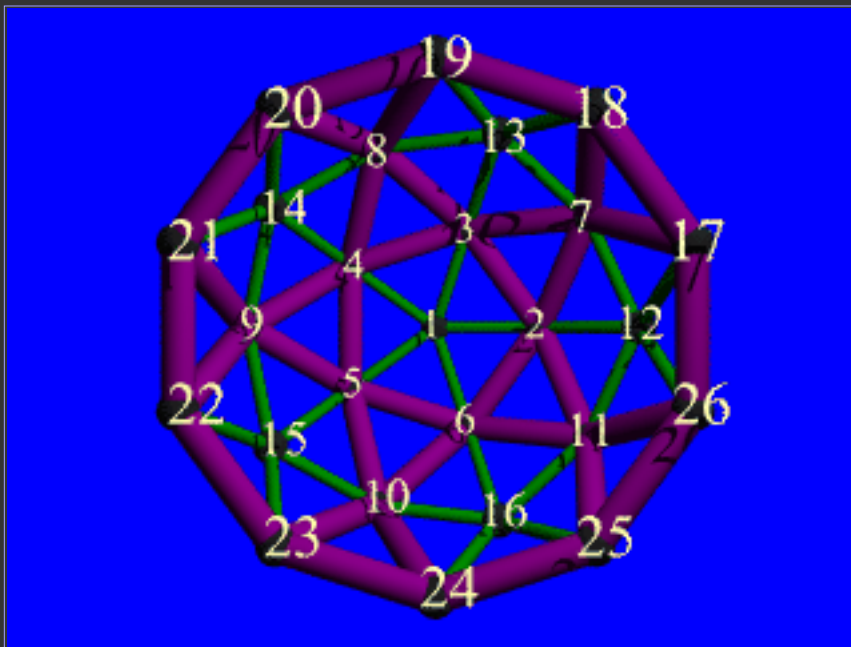

This is the bottom view of a frequency-2, class-I (aka "alternate division") geodesic dome. Each pole is called an **edge** and each place where the poles meet is called a **vertex**. The thicker **magenta** edges are all of the same length, which is 0.61803399 times the desired radius. The thinner **green** edges are all of the same length, which is 0.54653306 times the desired radius.

(Note that the ratio of the edge lengths is 1.13082636 and that the sum is 1.16456705. This will be useful to remember later.)

For example, for a geodesic dome with a diameter of 30 feet (i.e. a radius of 15 feet), the edges represented by thick **magenta** poles would be  $(15 * 0.61803399) = 9.27$  feet long, and the edges represented by the thin **green** poles would be  $(15 * 0.54653306) = 8.20$  feet long.

In this design, there are 35 long edges, and 30 short edges. There are 26 vertices. 6 vertices (1, 12-16) have 5 edges. 10 vertices (2-11) have 6 edges. 10 vertices (17-26) have 4 edges.



I have presented [high-4 designs](#) for a larger geodesic dome that allow the edges to be shorter, although the number of edges is about quadruple of this design.

## Entrance

For small geodesic domes (shorter than about 15 feet tall), the triangles at the bottom are too short to walk through so having a larger entrance is desirable. To make an entrance, remove the radial edges of one of the lower triangulated pentagons (such as all edges touching the vertex 12, i.e. edges V12-V2, V12-V7, V12-V17, V12-V26, and V12-V11). After removing the edges, the geodesic dome will partially collapse at that region, so it will need to be reinforced.

To reinforce the entrance, add edges from the middle of the top two edges of the pentagon to the bottom two vertices of the same pentagon (e.g. from vertex 26 to mid-way along the edge between vertices 2 and 11, and from vertex 17 to mid-way between vertices 2 and 7).

The cartesian coordinate of a new vertex midway between vertices 2 and 7 is (0.606961, 0.25, 0.688191). The vector from vertex 17 and that new 2-7 vertex is (0.344096, 0.059017, 0.688191). The length of that vector is 0.771681 dome radii.

redundant check: The cartesian coordinate of a new vertex midway between vertices 6 and 10 is (0.050203, -0.654509, 0.688191). The vector from vertex 24 and that new 6-10 vertex is (0.050203, 0.345491, 0.688191). The length of that vector is 0.771681 dome radii. This matches the length computed above.

---

## Implementation

The issues involved in implementing a geodesic dome include deciding what materials to use, and how the pieces will be connected together. The solution should be as simple as possible, and use as little material as possible.

### Materials

Materials should be cheap, readily available, easy to work with, and able to withstand the environment where the dome will be.

### Frame

The poles could be made from thin steel conduit, also known as electrical metal tubing or EMT. Conduit varieties include variations in wall thickness, diameter, and material. The cheapest feasible possibility is to use non-rigid zinc-coated or galvanized steel conduit. (Steel rusts rapidly.

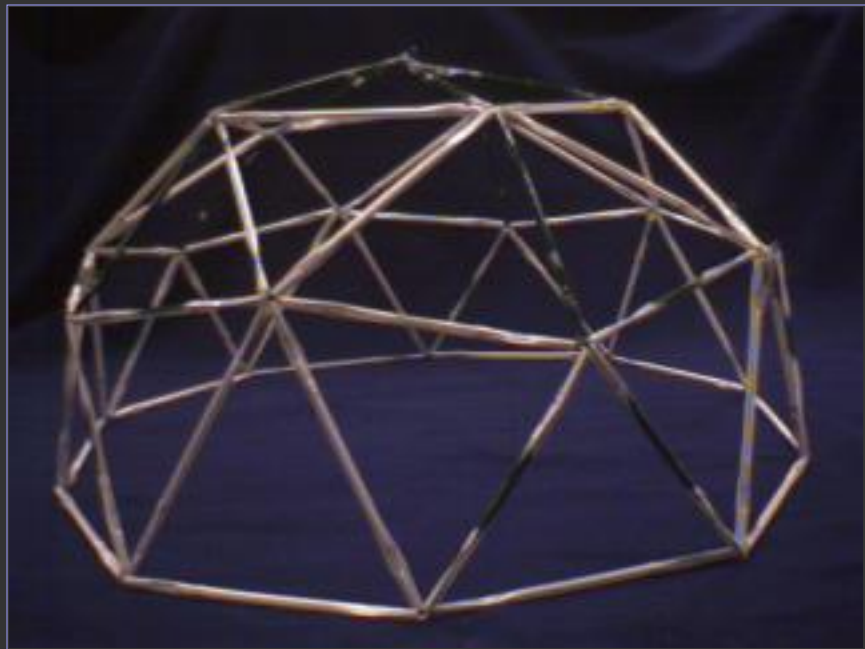

The coating is intended to reduce corrosion, but if the dome will be oft exposed to wetness, apply primer or paint.) The diameter of conduit to use depends on the lengths of each edge: The edges should not bend under the weight of the load they will bear. Longer edges will require larger diameter poles.

If the edge lengths exceed 10 feet each, then a problem occurs: conduit poles are 10 feet long. In order to construct edges which are longer than 10 feet, multiple conduit poles will have to be joined for each edge. One method is to use two different diameters of pole, and insert the smaller into the larger, creating a "telescoping" pole, similar to the legs of a tripod or the barrels of a collapsible hand telescope. Telescoping is a big hassle and reduces the integrity of the structure, but it is easier than using a higher frequency geometry. Still, I have found that using telescoping poles leads to an unsatisfactory structure.

Some people use PVC or ABS (kinds of plastic) pipes for their domes. PVC is light and cheap, but very flexible, even for very large diameters. The hubs are sometimes made of conduit, and the PVC is attached to the hubs using pins or small bolts. In other cases, the hubs are simply made using lashings or tape. Several people have had success with PVC, but I find it too flimsy for my purposes. It is not possible to hang heavy things from PVC domes, not even from the vertices. PVC domes can collapse if they bear much load. Some designs avoid this problem cleverly, but I will not be discussing PVC frames.

Another edge material that has been used is fiberglass. Fiberglass poles, about 4 feet long, are mass produced for use as broom handles, and if you are lucky enough to live near a manufacturer of these poles, you might be able to obtain 65 of them to make a dome. These poles are strong, light, and rigid. To connect them at the hubs, conduit can be used.

## Covering

A parachute could be used to cover the dome. Round parachutes can be obtained from military supply stores, in either white or green. I have seen nylon parachutes, and I have heard of cotton ones. White parachutes are suitable for either back or front projection of images or laser light, but let most light pass through so they make for awful shade coverings. Parachutes require very little effort to cover the dome, since they are circular and drape easily over the frame. Often, parachutes have ties or grommets around their perimeter for attaching to the frame. Round parachutes also have hemmed holes in their top which will let hot air escape. Parachutes catch wind efficiently, and that can be undesirable if the dome is not firmly attached to the ground, weighted down, or designed such that no air flow can get underneath the dome. Be careful using parachutes in windy scenarios.

Mesh or other very breathable fabrics can be used as a covering. They lack the wind-catching problems that parachutes have. Mesh fabrics can be expensive. Shop around to find inexpensive fabric. Also, it is unlikely to find a single, large, circular sheet of mesh fabric, so if this material is used, a way to drape it over the dome such that material is not wasted will have to be found, such as cutting the material into triangular panels and sewing them together.

Parachutes and mesh coverings have a serious drawback -- they are not opaque and do not sufficiently block sunlight. This makes them look interesting at night when they are lit from inside but during the daytime, the problem is horrible. Dark chutes improve the shade some, but a better

solution would be to use an opaque cover, such as a silver tarpaulin, to cover the dome.

Drawbacks of tarpaulins include the fact that the fabric is slightly inflexible and that it makes an annoying sound when blown in wind. To mitigate those problems, [custom-fit covering patterns](#) can be cut from the tarps.

Tarps are not entirely opaque but that can be improved by gluing aluminum foil to the tarp. Use spray adhesive. After the adhesive dries, the foil can peel off, but not easily. In fact, the foil coated tarps can be folded, wrinkled, wadded up and abused without the foil tearing significantly. Plus the shiny look of the foil is neat.

## Cost

Shop around for the place that sells conduit for the lowest price -- a lot is required. In Boulder, the prices varied by a factor of two!!! Conduit prices from near McGuckin's Hardware charges literally more than twice as much for conduit than most other stores in the area. Sullivan's Hardware charged 25 percent more than what could be found at Home Depot or Eagle. 1998. All prices listed are for

non-rigid, galvanized steel conduit. Larger diameter poles will be less flexible than smaller diameter poles.

Poles with thicker walls also give

| Diameter   | Price<br>(per 10-foot length) |
|------------|-------------------------------|
| 1/2 inch   | US\$1.50                      |
| 3/4 inch   | US\$2.00                      |
| 1 inch     | US\$3.67                      |
| 1 1/4 inch | US\$4.80                      |

more strength to the structure, and there is a "rigid" variety of conduit, but it is much more expensive and difficult to deal with. Note that there is a difference between "thick walled" conduit and large diameter conduit. "Thick walls" refers to the actual thickness of the metal, where the diameter of the pole refers to the circular cross section size. These two properties are somewhat independent.

Bolts (3/8 inch diameter shaft, 9/16 inch hex head, steel) cost about US\$0.25 each. Cost depends on length. Bolts 2 to 3 inches long are needed, depending on the number of edges that meet at a vertex. The cost of corresponding nuts is about US\$0.05 each. Washers probably cost about US\$0.02 each. For 26 vertices, the total cost of the bolt/washer/nut combos is about US\$9 including sales tax.

## Hubs

The vertices, or hubs, could be implemented by pressing the pole ends flat and parallel, drilling a hole near the end, bending the ends, and sliding a bolt through all of the pole ends at each vertex.

## Sizes

The way parachutes sizes are advertised is by the diameter of the circle they make when laid flat. This is *not* the same as the diameter of the hemisphere they cover.

If laid flat, the parachute should be circular, like a disc. When the parachute is draped over a spherical dome, the *diameter* of the parachute should be equal to *half* of the circumference of a sphere with the same diameter as the dome. Some simple geometry and math yields this

relationship between the diameter of the parachute and the diameter of the dome:

$$\text{diameter\_dome} = \text{diameter\_parachute} * 2 / \pi$$

i.e.,

$$\text{diameter\_parachute} = \text{diameter\_dome} * \pi / 2$$

E.g., a parachute to cover a 15-foot diameter dome would have a semi-circle arc that rises over the top of the dome has an arc length of  $\pi * (15 \text{ feet}) / 2 = 23.562$  feet.

After the size of the dome is determined, the sizes of the poles is determined by using the factors given above: Multiply the *radius* (i.e., half the diameter) of the dome by 0.61803399 for the long poles, and by 0.54653306 for the short poles.

## Accuracy

There are two principle aspects of constructing the dome pieces that require accuracy and precision: Making sure that the pole ends are flat and parallel, and placing the vertex holes in the right place.

A significant impediment to assembling the dome is if the flattened ends of the edges are not parallel. If the edge ends are not parallel, then when the pole ends are joined, the effective thickness of the vertices will be much larger than necessary, requiring either a longer bolt, or complicated maneuvers with C-clamps to hold the edges together while the bolts are inserted. Much effort will be saved by making sure that the flattened edges are parallel.

What determines the edge length, more so than the cut length of the poles, is the distance between vertex holes in the poles. If the edges are the wrong length with an error of about 1/16 inch each, then after 10 consecutive segments, the cumulative error can be 5/8 of an inch. This is a quite large error, which would make it difficult to connect the edges together. However, machining these edges to an accuracy of better than 1/16 inch is difficult.

In practice, the dome is somewhat flexible, so that if the vertex holes are not drilled precisely, it will be possible to bend the dome to line up the vertex holes, although bending the dome into shape is less elegant than simply drilling the holes in the right place.

## Flattening

In order to flatten the pole ends, several methods can be employed.

### Flattening with a hydrolic press

This is the most elegant method, if you have the means. If you do not have access to a metal shop, then you can probably hire one to press and drill all of your poles for under \$100.

### Flattening with a sledge or spud bar

Another method of flattening is to use a large, heavy hammer to flatten the poles. Such hammers are cheap, portable, fast, and require less effort than using a vise.

A "spud" bar is the back end of a device used to split concrete. The splitting side has a blade, and the back has a flat base, and the flat base can flatten poles with relatively little effort. This device looks like a pipe with a blade at the end. The pipe has a length of about 4 to 5 feet. The device weighs about 20 pounds, and costs around \$20. One benefit of this device is that you can rig a pipe sleeve mounted vertically to guide this hammer so that you only need to place the pole end under the sleeve-guided hammer, then repeatedly lift and drop the hammer a few times to flatten the pole. Using a spud bar is much better than using a sledge hammer.

The major problems with using a hammer include these:

- Hammering is very loud.
- Hammering can damage the surface used as a base.
- The poles can be easily split along their seams.
- It is difficult to keep both sides of the pole uniform.
- It is difficult to make the flat pole-ends parallel.

Each of these problems have various solutions. Keep in mind that 130 pole ends will have to be flattened, so elegant, simple solutions are desirable.

- Use ear protection to reduce the pain from the noise of hammering.
- Find a well made base for hammering. If you use a sidewalk or cement base, and the sidewalk starts to crumble at the beginning, remember that there are 130 ends (or more) to flatten, requiring thousands of hammer blows, so find another surface as the base. One good option for a base is an anvil. Note that some vises have anvils on their behinds.
- To reduce the likelihood of splitting the poles at their seams, work gently, flattening gradually. Heavy blows that drastically and rapidly deform the pole are more likely to split them.
- To keep the flat parts uniform, partially flatten one side, then turn the pole over and flatten the other side. The pole might curve, in which case turn the pole over again, and carefully whack out the curve. The hammer is heavy so let gravity do the work. Also let the recoil of the hammer bring it back up. Work gently and slowly. Using a hammer is fairly fast work in any case so there is no need to rush it.
- Keeping the flat parts parallel is crucial. If using a hammer, flatten one end first, then find a very heavy object (50 pounds or more) that has a flat bottom, and use that to hold the flattened end straight and parallel to the ground before flattening the other end.

## Flattening with a vise

One method is to use a vise to flatten the poles. Using a vise will give precision in flattening the pole. A vise is also useful for many other tasks, such as holding poles while sawing or drilling them. The major problems with using a vise to flatten are that a large 5-inch vise costs about \$60 (which is more expensive than a hammer), and that the force (or torque) required to flatten metal poles is significant, so the process takes a long time and a lot of effort.

A heavy duty vise with large jaws (5 inches or more) is desirable. It should be mounted onto a stable, immobile, strong platform. If the vise is simply mounted to a table, even a heavy table, pushing on the vise rod will move the table around. (Bending steel, after all, requires a lot of force.)

The vise could be attached to a 2x12 length of board, then there would be a large, sturdy platform which could then be clamped to a much larger, immobile table. This allows the vise to be semi-portable while still having a sturdy mount.

Also recommended is extending the vise rod by about 12 inches, perhaps by slipping a length of conduit over the existing vise rod. The extra length will increase the torque applied to the vise, which reduces the amount of force required. The amount of force required is inversely proportional to the length of the vise rod (or rather, to the distance between the pivot point and the point where the force is applied); If the length of the rod is doubled, the amount of force needed is halved. Be careful, though; if the vise rod is too long then a modest force can produce enough torque to destroy the threads on the vise screw. More than doubling the vise rod length is not recommended.

Work incrementally. Make a first pass, partially flattening the length, starting at the end and squeezing about 1/2 of the pole at a time, working toward along the length, then make a second pass to fully flatten. After one end is flattened, place the other end into the vise, close the jaws just enough to grab the pole, then use a level to align the flat end so that the two ends will be parallel when they are both flat.

### **Flattening with both hammer and vise**

A combination approach of using a hammer and a vise is a good compromise. Using the hammer for only one end of the pole, while using the vise to flatten the other end gives some of the ease and speed of the hammer, while giving precision of the vise for keeping the ends parallel. Yet another possibility is to use the hammer to flatten one end, then to use the vise to partially flatten the other end (just enough to make sure the rest of the flattening will indeed be parallel to the fully flattened end), then finish flattening with the hammer. Still yet another compromise, one that I prefer most, is to use a hammer to flatten the pole ends, then use a vise to refine the work, to make sure the pole ends have no "bubbles".

### **Flattening hints**

Making the ends as flat as possible will save time and effort during assembly. If the pole ends are not as flat as they can be, even if there are "bubbles" in the ends that are a millimeter wide, then assembling the dome will be slower and will require more physical labor.

## **Drilling vertex holes**

Placement of the vertex holes requires the most precision of all of the steps in making the dome. To make sure the holes are precisely in the right place, consider subtle length-modifying effects (listed below), measure carefully, drill carefully and systematically, and allow for some play.

## Length modifier: Bending effects

When the ends of the poles are bent in order to mate up with each other at the vertices, the poles are effectively slightly shortened. This shortening must be accounted for. This would be added to the distance *between* vertex holes. The angle of the bend will be about 16 to 18 degrees, depending on which pole you are bending.

Diagram showing the bending effect length modifier. (The angle depicted in the diagram is exaggerated for clarity of illustration.)

(Derivation of angle: The sum of exterior angles of a polygon is always 360 degrees. The polygon forming the great circles of this dome is 10-sided. For a 10-sided regular polygon, each exterior angle will be 36 degrees. Each edge will have to bend by half that angle to meet the adjacent edge.

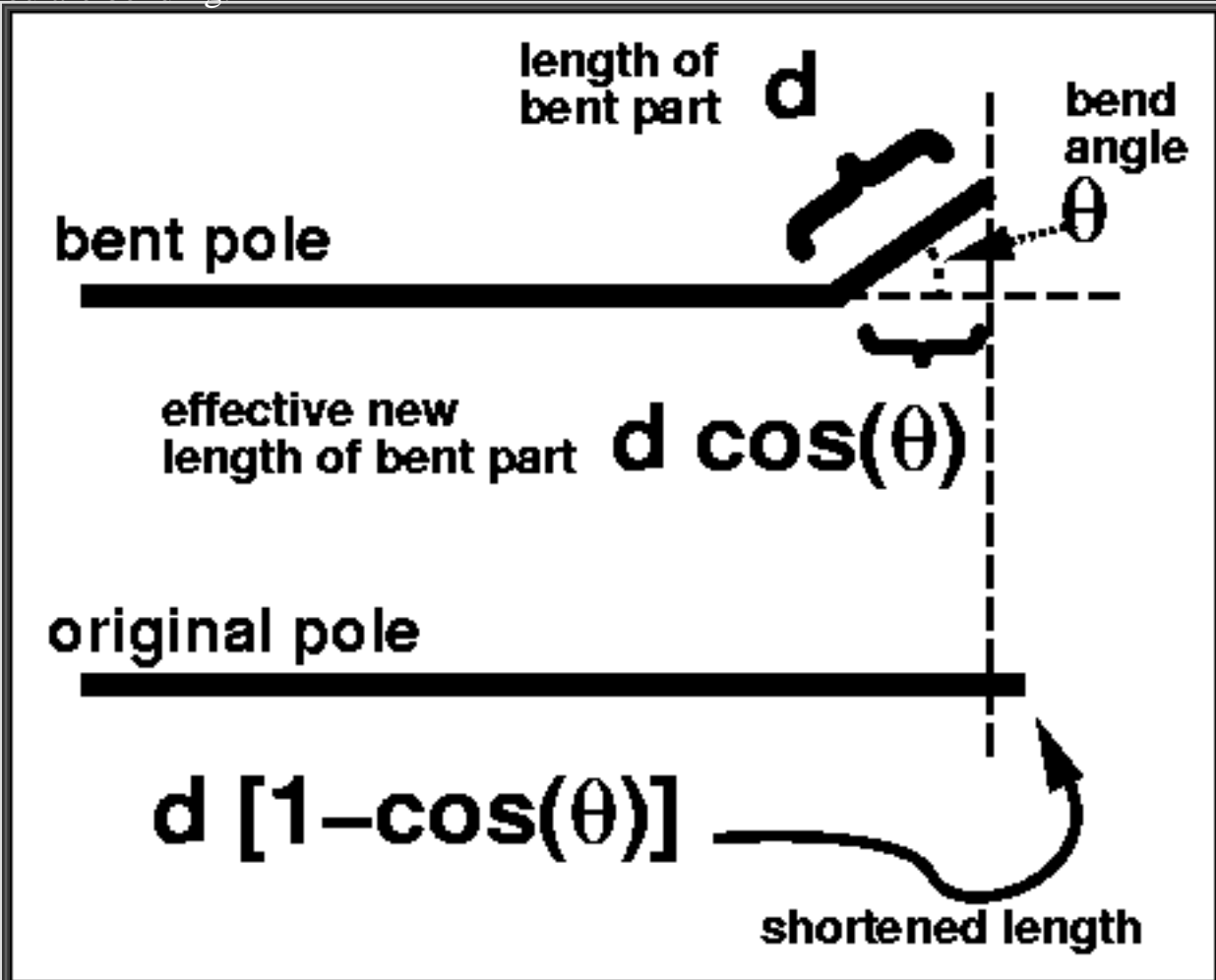

This works for the geodesic polygons, but not for other angles, but the other angles are approximately the same. For a more exact computation of angle, have a look at the list of vertex coordinates by clicking on the bottom view schematic image.)

If the bend is made  $d$  inches before the target vertex point then the edge would be shortened by a length of

$$2 * d * (1 - \cos(18 \text{ degrees}))$$

$$= d * 0.097886967 ,$$

where the factor of 2 comes from the fact that there will be bends at both ends of the conduit.

For  $d=1$  inches, the length change due to bending is  $3/32$  inch.

For  $d=2$  inches, the length change due to bending is  $3/16$  inch.

For  $d=3$  inches, the length change due to bending is  $9/32$  inch.

## Length modifier: Drill hole padding

The edge lengths are the distances between vertices. The actual lengths of the conduit for each edge will have to include extra length to allow for room for the bolts to go through. The diameter of the bolts will be around 1/4 inch or 1/2 inch. Leave extra space for making oversized holes and to have a margin for structural integrity. About 1 or 1.5 inches should be sufficient. This length is *outside* of the distance between the vertex holes.

## Drilling tips

Use a heavy-duty, industrial bit which is designed to drill through metal, preferably zirconium-nitride coated, and apply lubrication (such as Tap Oil) to the drilling area to keep the drill bit sharp.

## Bending

The pole end will be bent at a place a distance "d" (the same distance "d" used in the calculation of the bending effects, above) inside, from the center of the vertex holes. This is the place where the bend will be.

Using the vise, bend the end of each pole. For the frequency-2, class-I dome, the bend angle should be 18 degrees. Use a speed square to measure the angle, locking the rotating arm at the 18 degree location for easy measurement. Do this at both ends of each pole. Make sure the bends are in the same direction for each pole. I.e. the poles should end up mildly C-shaped, not mildly Z-shaped.

---

## Example

Details for how to build a 15-foot diameter, 7.5-foot tall steel conduit geodesic dome are given in "[small dome details](#)".

---

## Acknowledgements

- Thanks to the "[dome](#)" program (version 4.6) by [Richard J. Bono](#) which produced the geometry for this model.
- Thanks to [POVray](#) for raytracing this model.
- Thanks to [Vinay Gupta](#) for telling me the flat-end-with-bolts vertex hub idea, and encouraging my interest in this stuff.
- Thanks to FleshLab for helping me maintain the large dome.
- A great big Fuck You to my former neighbor and the Boulder department of building inspection for harassing me, without justification, for building the domes in my own back



yard. These domes have no foundation, and are therefore not permanent structures, and do not fall under the jurisdiction of the department of building inspection. To all of you who discouraged me, underestimated me, or detracted from my attempts to be creative, you deserve to miss out on a great experience. May your children surpass you.

## Further browsing

- [Synergetics On the Web](#) has an *awesome* Java applet that helps in [designing geodesic dome geometries](#). That page also explains geometry aspects of domes in a clear way.
- The [Buckminster Fuller Institute](#) has other useful information about The Man.
- The [Applied Synergetics home page](#) has information about geodesic domes and Buckminster Fuller's work, including the full text of Fuller's opus of work, "Synergetics".
- [Burning Man](#) is the event which inspired me to build this dome.
- [Geodesika](#) happens in Colorado each summer, and is like Burning Man but better, in that the terrain is more beautiful and the people have fewer image issues.
- The children's book **Geodesic Domes** by Borin van Loon has the simplest explanation of geodesic dome geometry and terminology I have ever seen, plus it has several paper cut-out models of many varieties of geodesic structures including the "Bucky Ball" (which is not a true geodesic, but which is famous since the early 1990's because of the carbon molecule, buckminsterfullerine).
- [Books](#) about geodesic domes tend to be out of print. Check used book stores. If you find any such books, I recommend that you buy them. If you have such books and do not want them, please let me know and I will probably offer to buy them from you.

## Dome designers, manufacturers and vendors

- [KYNER SHELTERS - Netscape Enhanced Page](#)
- [Geodesic Dome Cover Plans for Do-It-Yourself Woodworkers, used as solar greenhouses, pool covers, pet shelters, hay shelters.](#)
- [Walt's Dome Page](#)
- [Structural Elements](#)
- [conduit domes](#)
- [32' Structural Plans](#)
- [Patrick Salisbury's Home Page](#)
- [Geometry 1998](#)
- [Alternate Conduit Flattening Method](#)
- [Mark's \(geodesic\) Dome picture page](#)
- [Mark's \(geodesic\) Dome page](#)
- [American Ingenuity Domes](#)
- <http://www.agate.net/~insearch/Dom96Hom.html>
- <http://www.arachneweb.com/NewHouseShelter/>
- [Geodesic Dome](#)

- [Kettner & Associates Present: IDESA Geodesic Dome Aviaries](#)
- [JPEG image 638x574 pixels](#)
- [Geodesic Dome Home](#)
- [Applied Synergetics Home Page](#)
- [Buckminster Fuller Institute \(BFI\)](#)
- [Geodesic Domes - "Structures and Homes"](#)
- [Desert Domes](#)
- [Builders/Manufacturers of Geodesic Dome Homes and Structures](#)
- [Timberline Geodesic Domes](#)
- [For Geodesic Domes & Dome Homes In Tyler Texas se Geodesic Dome Homes In Whitehouse Texas](#)
- [Oregon Dome, Inc.](#)
- [affordable geodesic dome homes](#)
- [Geodesic Dome Frame Kits](#)
- [Welcome to Worldflower Garden Domes greenhouses for your garden and landscape](#)
- [JPEG image 280x289 pixels](#)
- [JPEG image 319x271 pixels](#)
- [JPEG image 280x292 pixels](#)
- [Welcome to Worldflower Garden Domes greenhouses for your garden and landscape](#)
- [geodome](#)
- [Dome](#)
- [The Explorer Building Group](#)
- [GeoDomes WoodWorks, Inc.](#)
- [Circular Domes](#)
- [Re: geodesic dome greenhouses](#)
- [Geodesic Dome Picture Scrapbook - A step-by-step chronology.](#)
- [C & R Enterprises - Creative Design Engineering for Products](#)
- [www.hoberman.com](#)
- [More Information](#)
- [DOME List, Magazine & Directory](#)
- [The Inflatable Frameless Dome by Liquid Sod,Construction,Sports,Golf.](#)
- [GH ORGANIZATION](#)
- [marketZONE-Dome Mfgs](#)
- [CONSTRUCTIONS LAB & KINGDOMES C/O EINAR THORSTEINN](#)
- [The Monolithic Dome](#)
- [Natural Spaces Domes: Home!](#)
- [Lydick's Dome Page](#)
- [The Growing Dome](#)
- [Patent Server: 5566516 Detailed View](#)
- [Biospaces Home Page](#)
- [The Catadomes!](#)
- [Formactive](#)
- [GEODESIC DOMES](#)
- [Dome Manufactures](#)

- [Synergetics Home Page.](#)
- [DOME GEOM](#)
- [Geodesic Dome Homes](#)
- [Geodesic Domes, Geodesic Domes, Geodesic Domes](#)
- [Altantic Geodesic Dome and Sphere Company](#)
- [Links to geodesic and alternative building](#)

---

The Universal Resource Locator for this web page is  
<http://www.colorado-research.com/~gourlay/dome/>

---

[Dr. Michael J. Gourlay](#) / gourlay at colorado-research dot com

[Up](#)

---

## my 7m dome



(Well, 6.7m diameter actually (22 feet))

The geometry of the dome is based on an icosahedron, by adding new vertices at the midpoints of each edge, and then pushing these out to the circumscribing sphere. More edges are then added to create a mesh of triangles, with 4 for each original face of the icosahedron. The full polyhedron would have 42 vertices, 80 faces and 120 edges.

There are 2 different edge lengths, 2.06m and 1.82m (about 6'9" and 6'), which in the full "sphere" would be present in equal numbers (60 of each). This structure is only a 1/2 sphere, and lacks the (long) edges around the equator, and hence has 25 long poles, 30 short poles.

The entire sphere would have 12 5-way joints and 30 6-way joints. Breaking at the equator means that this dome has 6 5-way joints (one at the central apex), 10 6-way joints and 10 2-way anchor points. For the structure to be stable these anchor points need staking down.

In the completed dome, so long as forces are only applied to the joints, the structure exhibits great rigidity and strength, since the poles or joints do not experience torque (bending) forces. (This is not, however, the case during construction!)

The total length of aluminium tubing used is 103m or 343'. The total area of the triangles is 64.8 sq metres (~700 sq feet). The total mass is 43kg (96lb), of which the tubes comprise 85%. The central apex joint is capable of taking the weight of a person (80kg) swinging on the end of a rope, and is 11' above the ground. The usable floor area for a 6' individual is approximately 20 sq m, 220 sq ft. Total floor area is 32.6 sq m (~350 sq ft, or half the area of the dome, which would be an exact relationship for a true sphere)

The structure was raised for the first time on the afternoon of Sat 28 Sept 1996, and this took about 4 hours. It was taken down the following day in about 1 hour. Part of the time to put it up was due to the need to drill larger holes to give the bolts (sorry, panel-head machine screws) more clearance. 220 nuts/bolts is quite enough to make you sick of them! 2 nuts and no bolts were lost during this process.

My next project is to create a covering for the current framework-only design. The joints each have auxiliary holes to allow the bolting on of fixing points, exterior or interior.

---

The dome and its creator:



Cross Eyed stareogram: ([larger version](#))



During construction:



The various components:



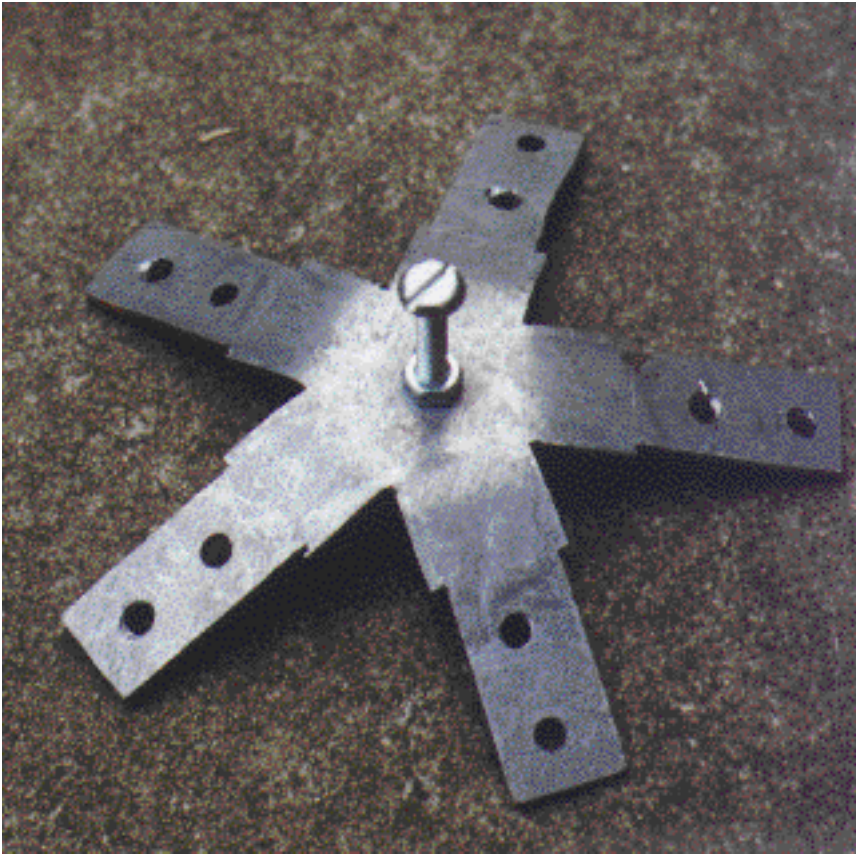
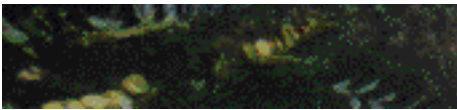



---

all but the tubes:

[all the joints  
on the ground]

---

A completed joint in close-up:



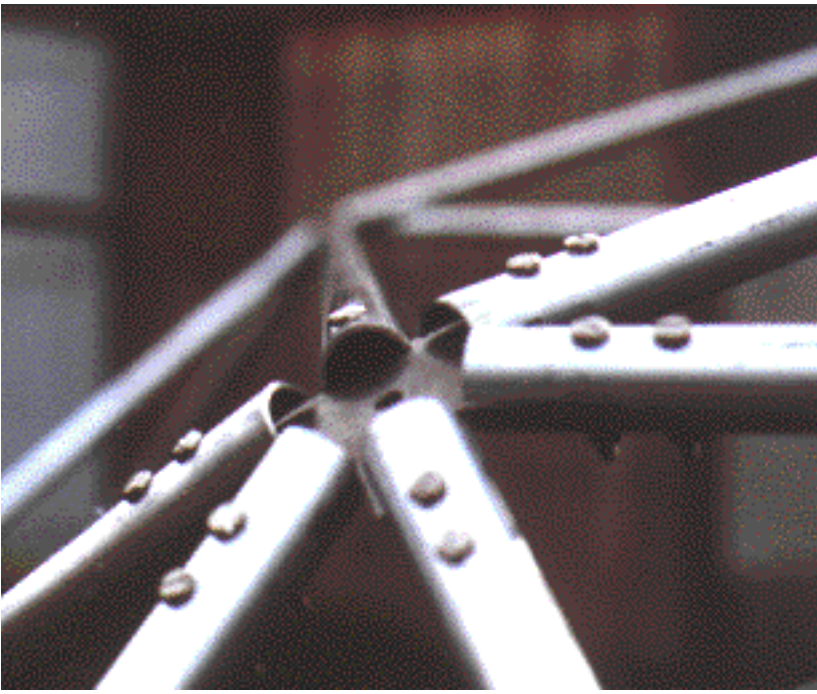

---

Some nutter immediately after materialization in the dome:



---

After the aliens land:

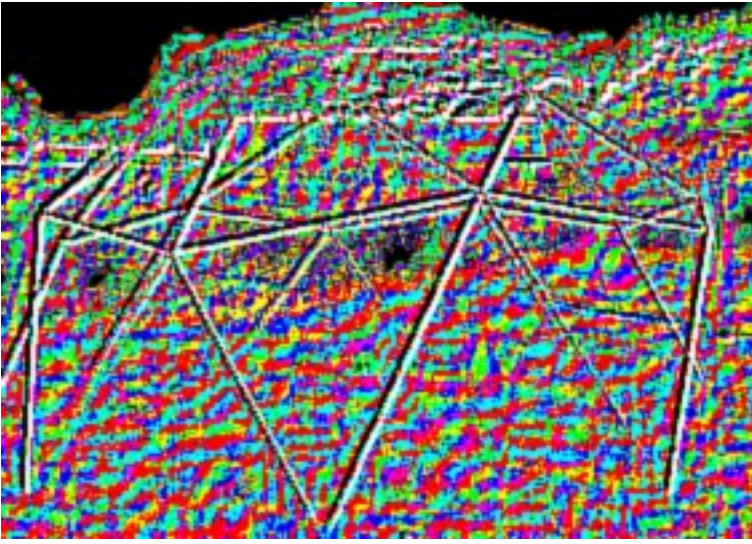

Last updated by [markt@chaos.org.uk](mailto:markt@chaos.org.uk) Fri 4 October 1996

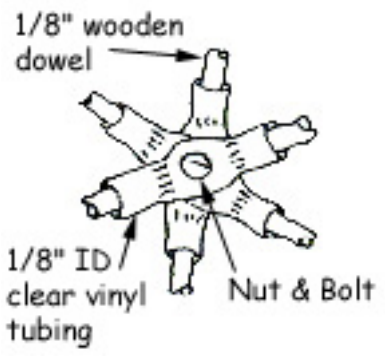

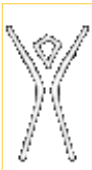

- [What is Burning Man?](#)
- [Art of Burning Man](#)
- [Press Here](#)
- [News](#)
- [Participate](#)
- [Black Rock City Year Round](#)
- [E-Playa](#)
- [Calendars](#)
- [Image Gallery](#)
- [First Timer's Guide](#)
- [Preparation](#)
- [On The Playa](#)
- [Theme Camps & Art Installations](#)

[ADVANCED SEARCH >](#)

[SITE MAP >](#)



XXXXXXXXXXXXXXXXXXXX

# BURNING MAN 2004

## AUG 30 - SEPT 6, 2004

Updated August 19, 2004

### [Black Rock City Weather](#)

Get the weather report direct from First Camp here at Black Rock City.

### [Getting to Black Rock City](#)

Know where you're going? Here are the [driving directions](#) to Black Rock City, no matter where you're coming from. Need a ride? Offering one? Use the [Ride Share Board](#) to set up a carpool to the playa.

### [2004 Theme: Vault of Heaven](#)

Burning Man's art theme for 2004 is Vault of Heaven. Read about the theme, and how you can [participate in The Observatory!](#)



### [Prepare Yourself for Burning Man 2004!](#)

Get all the information you need to understand, enjoy and survive Burning Man 2004. Read the [2004 Event Survival Guide](#), the [First Timer's Guide](#), and our [Frequently Asked Questions](#).



Updated August 19, 2004

[2004 BRC Webcast](#)

[now available](#)

[2005 Burning Man Calendar](#)

[Mutant Vehicles Update](#)

[2004 Burning Man Journal](#)

[Afterburn Report 2003](#)

[Frog Pond Restoration](#)



Updated August 9, 2004

[Regionals Network](#)

[Year Round Calendar](#)

[E-Playa BBS](#)

[Playa Artifacts](#)

[Tales from the Playa](#)

[Knob](#)



Updated August 3, 2004

### [2004 Burning Man Tickets](#)

Tickets are now only available at the front gate ... come and join us in Black Rock City!

### [Camping Near Black Rock City](#)

If you need to camp out after the event, here's a listing of [local campgrounds](#).

### [Black Rock City Map](#)

The 2004 Black Rock City Plan, showing this year's street names, is now available for your viewing and download.

### [Playa Calendar](#)

Plan your week at Burning Man by perusing our playa calendar, and add your own event!

### [Department of Mutant Vehicles \(DMV\)](#)

The mandatory Mutant Vehicle registration process is now closed. Please be aware that non pre-registered vehicles will not be licensed to drive on the playa. Read the [latest news](#) about the review process.

### [Theme Camps and Art Installations](#)

The registration process for Theme Camps and Art Installations is now closed. View the listings of 2004 [theme camp placements](#), [theme art](#) and [playa art](#).

### [Register Your Video Camera!](#)

If you bring a video camera or video-capable digital camera to the playa, it must be registered to help protect everybody's privacy. Download and print out the online [registration form](#).

**HOTLINE: 415 TO-FLAME**

[Health and Safety](#)

[here](#)



[The Jack Rabbit Speaks](#)

[Heloise on the Playa](#)



Updated August 2, 2004



Updated August 19, 2004

[2005](#)

[Burning Man Calendar](#)

**PARTICIPATE HERE**

[DVD or](#)

[video](#)

[Contact the Webmaster](#)

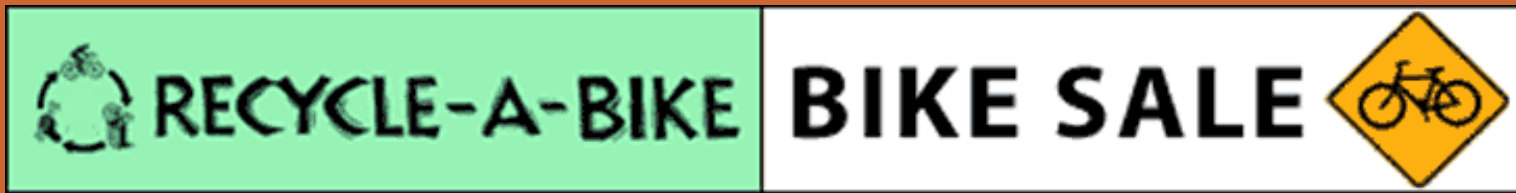

Amy C. Edmondson

A Fuller  
Explanation

The Synergetic Geometry  
of  
R. Buckminster Fuller



# The Bucky Fuller Travelling Miracle Medicine Show

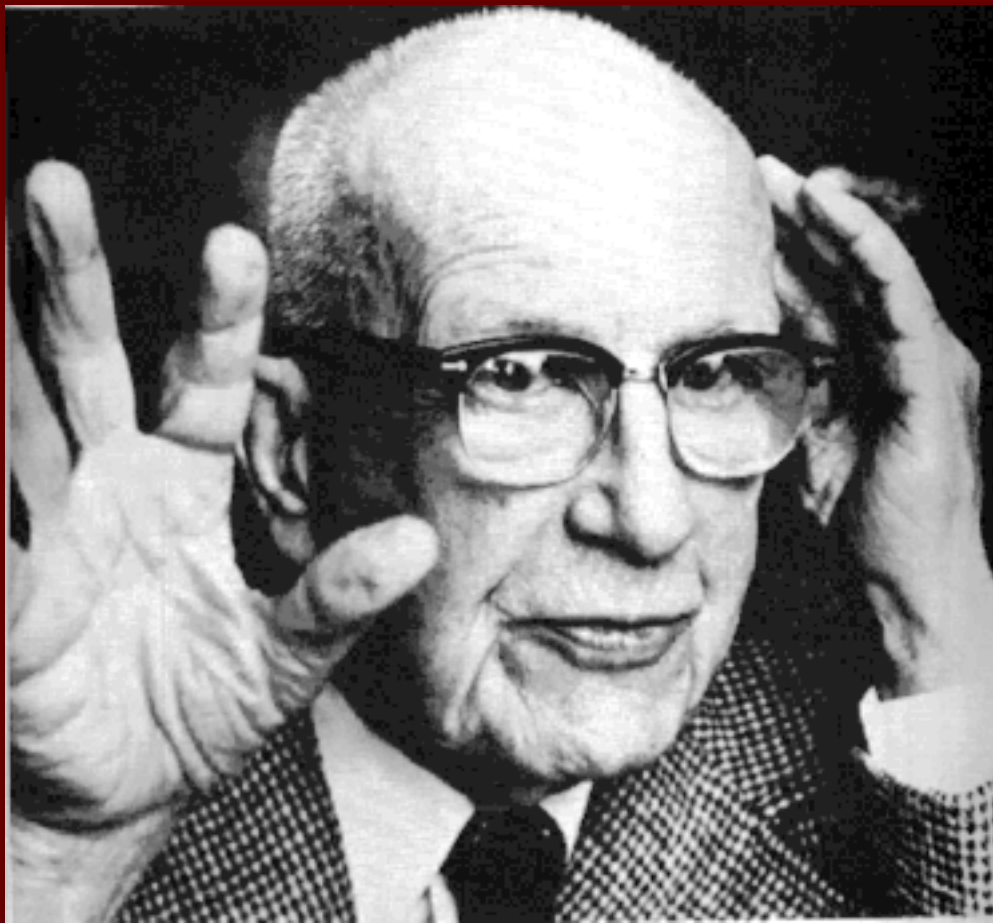

R. Buckminster Fuller

``Guinea Pig B'' (the introduction to *Inventions*)  
[In pages](#) (169 pages) or [all on one page](#) (about 90K)

[Bucky pictures](#)

My wife's favorite [part](#) of *How Little I Know*

---

Please report any and every typographical error in the preceding files to [me](#).

---

Copyright © 1995 Christopher Rywalt.

[crywalt@westnet.com](mailto:crywalt@westnet.com)

[Back to Chris Rywalt's home page.](#)

# Earl's Geodesic Domes



I was inspired to build a geodesic dome for a temporary living structure. Just to get a feel for the whole idea, i started by making a [newspaper dome](#). With that a success, i went on to the real thing, an [8-foot radius EMT dome](#). Flush with too much confidence, i volunteered to lead the creation of a [16-foot radius EMT dome](#) for Camp Recharge, of which i am a [spectator participant](#). I am also learning something about [screw-in ground anchors](#) along the way. Lastly, i have a geeky explanation of one way to [modify the geometry](#) for a larger entrance triangle.

If you are considering building domes like these (do it! do it!), please go to the [links page](#) which points you to the sites you really should read first. Then come back here and read my site afterwards. The information here is only intended to supplement what's already out there, is not available without a prescription, is only at participating locations, and is void in Minnesota and West Virginia.

I welcome feedback via email, even [audio feedback](#). Send it to [superdotfly@hotmail.com](mailto:superdotfly@hotmail.com). Thanks!

[Newspaper dome](#)

[8.5 foot radius frequency two dome](#)

[16 foot radius frequency four dome](#)

[About screw anchors](#)

[Modifying dome geometry for a larger entrance](#)

[Very useful links](#)





[Home](#) [Dome Composition](#) [Cardboard Triangles](#) [Wood Triangles](#) [Rebar & Gaskets](#)

[Painting, Vents, Tape & Velcro](#) [Flooring](#) [Assembly](#) [Site Map](#) [Contact](#) [Links](#)

# How to Build a Geodesic Dome out of Cardboard

This site was designed in response to people asking us how we made our domes and who were interested in making their own.

The design was borrowed from a 1973 edition of Popular Mechanics and was improved upon to meet the rigors of the Black Rock Desert.

These domes have served as an effective shelter against wind, extreme heat and, once painted, rainfall. The largest of the three domes in the picture opposite measures approximately 12' 7" in



diameter and is about 6' 3" high at its center. We recommend building the largest one. All the measurements throughout this web site relate to the largest size. They are fairly inexpensive to build as recycled cardboard is the main component and, if water-based paint is used, can be burned. The domes are strong enough to attach decorative pieces and lighting components to the inside. Assembly time, on site, is 3 to 4 hours for 3 people constructing one dome with the appropriate tools.

Feel free to contact us with any questions or comments about dome

construction  
or the outline  
of this web  
site. If you do  
end up  
building one  
or more of  
these domes  
for the Playa,  
please let us  
know where  
we can find  
you.





Toys

Structures

Company

Press

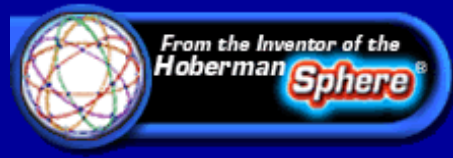

Questions? Comments? Write us at [designs@hoberman.com](mailto:designs@hoberman.com).  
©2003 Hoberman Designs, All rights reserved.

# The PlayDome Page



Please [download Java\(tm\)](#).

The PlayDome described here is based on a design by [Curt Flowers](#). Curt has "granted permission to use this idea and/or to reproduce and redistribute these plans for any private, non-commercial use." (See page one of the [plans](#) for the full conditions on their use.)

The PlayDome pictured above was installed at the Arcadia Montessori Learning Center in Tacoma, Washington on June 8, 1996. The 21 automobile tires have been bolted together to form a little more than half of a truncated icosahedron, which is reminiscent of Buckminster Fuller's geodesic domes, and is the same as the carbon-60 (C<sub>60</sub>) molecule known as fullerene.

- Curt Flower's [original plans](#) for the PlayDome. You have to take a look at these if you are serious about constructing your own.
- My [notes](#) on modifications and additions to Curt's plans.
- [Photos and commentary](#) on the installation process.
- Some remarks on the [geometry](#) of a PlayDome.

- More mathematics - how to arrange the [colors](#) of the tires.
- A Playdome [photo gallery](#).

[Rob Beezer](#), BEEZER(at)UPS(dot)EDU.

Created: June 9, 1996, Updated: June 20, 1998.

# The Hexayurt

Friday, August 13  
2004

Welcome,  
Burners! Looks  
like we're getting  
traffic from  
people looking  
for Burning Man  
shelter and, well,  
it's a lot easier  
and more  
comfortable than  
a standard conduit  
geodesesic :-)

If you build a  
hexayurt for use  
at Burning Man,  
or some similar  
structure, **please,**  
**please** send me  
pictures and  
performance  
reports  
afterwards. Please  
pay particular  
attention to the  
construction  
coreography -  
how it went up,  
and how it came  
down.

And email me if  
you've got  
questions - the  
contact link above  
works. Enjoy the  
burn, I may yet  
see you there!

June 20, 2004  
Cameron tells me

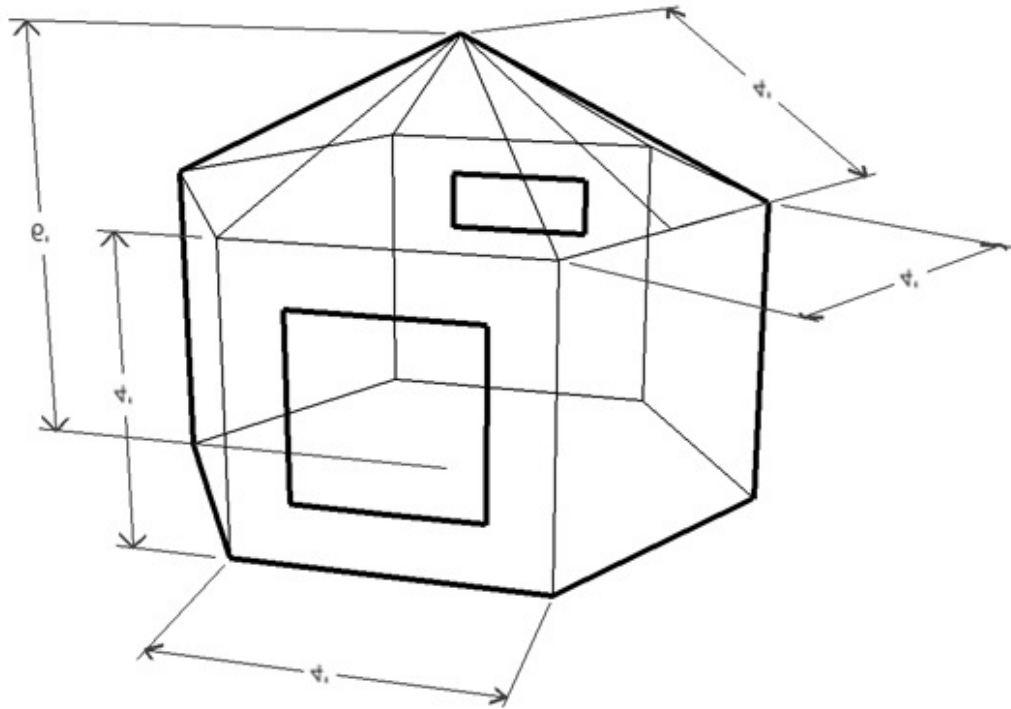





that he's posted a link here to [Architecture For Humanity's](#) newsletter. If you're visiting because of that link, greetings!

The "Hexayurt" is a very small shelter which is makes very efficient use of both materials and labor. The design completely uses 4' by 8' sheet goods producing no waste, and construction requires only six straight cuts across the diagonals of 4'x8' sheets (to make the roof triangles).

A hexayurt can be built using many different kinds of materials. Plywood, polystyrene, cardboard, plastic and even metal might be appropriate for different environments.

The desert hexayurt in these pictures is a half-scale model built from hexacomb cardboard, using



a reflective vapor barrier for insulation and waterproofing. Because it kept out so much light and heat, it was possible to sleep in the building until around noon in the Nevada desert, and a 10 watt solar panel connected to an improvised swamp cooler actually helped cool the building significantly, although not as much as evaporative cooling with a spray gun.

Here are the [diagrams of the full sized hexayurt](#) and the [gallery of images of the desert hexayurt](#). The diagrams have some reversed text on them due to an OS bug, but I should have fixed ones up later today.

Finally, here's a [blog thread to discuss the hexayurt](#) - just leave your feedback as comments, by clicking that link,

or .

Thank you for  
your interest!

Sep 15 2003  
[Large Hexayurt  
Diagrams](#) - this is  
the full scale  
hexayurt - 12  
sheets of 4x8  
sheet per unit, 8'  
roof, 166 square  
feet of floor  
space, more  
details later.

Sep 15 2003  
[Hexayurt  
Diagrams](#) now  
online. I need to  
prepare some  
more images to  
help with the  
whole silver foil  
skin, but these  
give all of the  
necessary info on  
the basic  
structure.

A bug in the beta  
of Panther which  
I am running has  
caused some of  
the text to come  
out in  
mirror-writing.  
I'll repost these  
images once that  
bug is fixed. It's  
an operating  
system problem,  
not a SketchUp  
problem -  
Mail.app does it  
too!

---

Sep 9 2003  
I'll be posting

cutting and construction diagrams shortly, but in the mean time here is the [Gallery of Hexayurt Images](#) which give a fairly good idea of how the structure works. These are only the take-down images, as my camera with all of the pictures of the hexayurt being assembled was destroyed.

---

The Hexayurt is a prototype for a family of refugee shelters. At the moment, most refugees wind up in poly tarp structures held up by PVC pipe. These structures rot rapidly, offer little protection from the elements, and in the long run feel like tents.

Tents are fun for a while, but few people would choose to live in one for years at a time.

The Hexayurt is a first draft of a different kind of super-low-cost housing. This prototype is made

from cardboard, but the design holds good for any 4' x 8' sheet goods, allowing different materials like plywood or styrofoam to be used in different climates.

The exterior is made from a reflective insulating material, which lends both insulation and waterproofing. Separating the structural and waterproofing elements means a much wider range of structural materials can be used.

Finally, the Hexayurt is made to be portable on a car, truck, donkey, or at worst, on the back of humans. A single adult can carry the hut in this picture without undue difficulty, and two adults could carry a hut for many miles in a single day if the need arose.

---

This prototype was made with materials given to

me by three companies. [Pactiv Corporation](#) donated their [Hexacomb board](#) material, which forms the sides and roof of the hexayurt, [Innovative Energy](#) donated [Heatshield](#), the reflective insulation which surrounds the structure, and [3M](#) donated the fibre tape which holds the structure together.

[SketchUp](#) very generously provided me with a copy of their [amazing 3D sketching program](#). I had used the time-limited demo to make the diagrams which helped me explain the project to the people who gave me the materials, and all of the construction diagrams you can see on the site were made with this amazing tool.

I'd like to thank all four companies. I was completely amazed and

gratified by their  
generosity and  
genuine interest  
in this project,  
and I hope that  
their time and  
money will turn  
out to be a  
worthwhile  
investment.

# Geodesic Clubhouse



Geodesic domes are made of interlocking geometric shapes--often triangles. Because loads are spread over many triangles, these domes are especially strong. Often made of aluminum bars and plexiglass, they're also light compared to ordinary domes.

Geodesic domes were popularized by an American inventor named Buckminster Fuller (1895-1983). Look for the distinctive Bucky-ball shape in museums, greenhouses, alternative housing, and science centres. Vancouver's Science World is a 47-metre tall geodesic dome made of 766 triangles.

For a printable version of this project, [click here](#).

## Dome Talk

This project is quickly proving to be our most popular! We often get comments about how much fun families have had building and playing in their own geodesic dome. We think this is wonderful and encourage anyone doing this project to take photos and write us about your dome experience. You can send them to us via email at [web@yesmag.ca](mailto:web@yesmag.ca).

Here are the stories we have received so far...

[Moville Cub Scouts Pack 259](#)

[Fam van Dinther](#)

[Académie de la Capitale](#)

[Daisy Girl Scout Troop #316](#)

[Karen Pierce](#)

[Michael Kiesel](#)

[G. Ray Bodley High School](#)

[Fairland Elementary School Grade 5 Class](#)

[8th Brockville Scout Troop](#)

[St. Edwards School Grade 7 Class](#)

[John Bastianelli's Cardboard Dome](#)

[Kris Fontes' Grade 7 Art Class](#)

[Riverview Elementary School](#)

[AJCC Day Camp](#)

[The Montgomery Family](#)

[Cub Pack 411, Ethridge, Tennessee](#)

[The Terry Family](#)

[College Park Elementary Grade 2 Class \(Fall 2000\)](#)

[College Park Elementary Grade 2 Class \(Fall 1998\)](#)

[Onoway High School Grade 7 Class](#)

[Mr. Lisowyk's Grade 6 Class](#)

[Young Scientist's Club in Winnipeg](#)

[Leigh, Sue, Nick, Andrew, Greg, and Matthew from Halifax](#)



## Materials

- " newspaper
- " doweling or broom handle
- " tape
- " marker pen
- " stapler (and staples)
- " measuring tape

Like a real engineer, you will probably need to rely on teamwork to get this project finished. Why? Because the dome tends to flop over unless it's supported, and stapling is a bit tricky unless you get help holding all the newspaper tubes together.

Using a piece of doweling makes stronger tubes that are harder to staple. Using a broom handle makes slightly weaker tubes that are easier to staple.

## Instructions

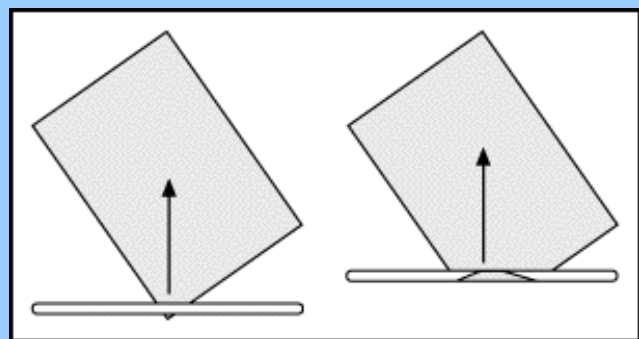

1. Open up a sheet of newspaper. Roll the newspaper around the doweling diagonally from one corner to the other.
2. Cut a piece of tape and stick it to something (preferably not your head) for a minute. Hold the newspaper tube in one hand and gently pull out the dowel with your other hand. If you rolled the newspaper really tightly, you may need to wiggle and twist the dowel a bit. Use the piece of tape to keep the newspaper tube together.
3. Cut the tube to length. [Note: The ends of the tube are not very stiff. To make a stronger tube, make the tube the correct length by cutting some off both ends.] You need a total of 35 newspaper tubes measuring 71 cm and 30 tubes measuring 66 cm. So get busy rolling, measuring, and cutting. Keep the two lengths separated.
4. Use the marker pen to put a mark on the longer newspaper tubes. Now you'll be able to tell the two lengths apart easily. From now on, we will call the marked tubes As, the unmarked tubes Bs.

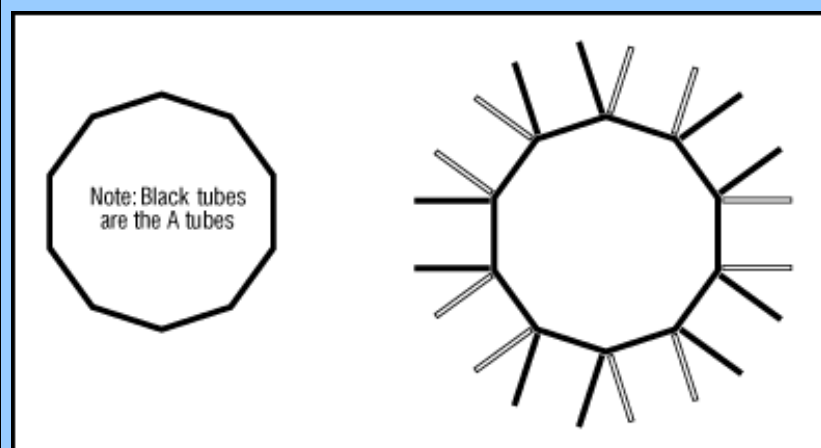

5. Arrange 10 As in a circle.
6. Overlap the ends of two tubes by 2 cm and staple together. Repeat this to form the base of the dome.
7. Lay alternating pairs of As and Bs radiating out from the central circle.

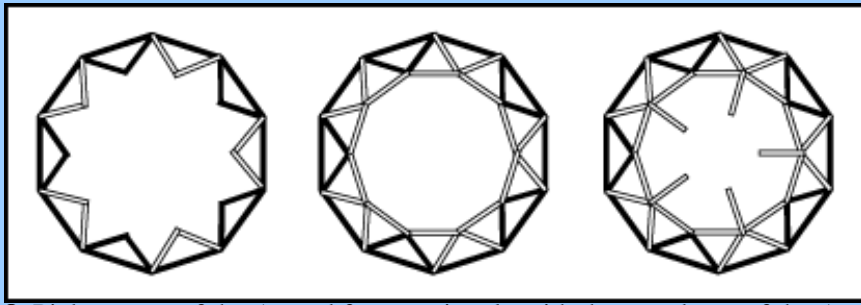

8. Pick up two of the As and form a triangle with them and one of the As from the circle. Staple the joints firmly.
9. Do the same thing with the rest of the tube pairs. You should end up with a circle of triangles poking into the air. Tall triangles should alternate with short triangles.
10. Connect the triangles by stapling a row of Bs across the top.
11. Every point where four Bs come together, staple on another B pointing straight up.

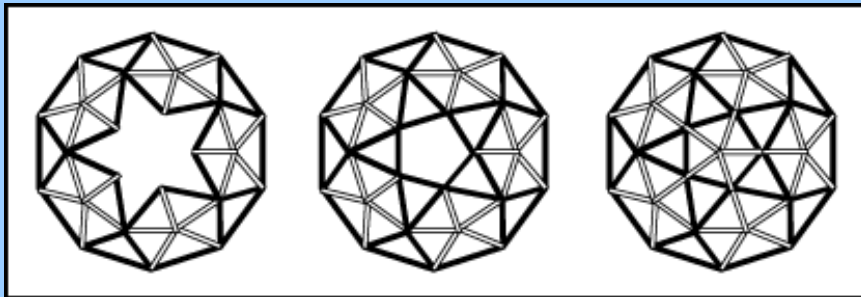

12. Brace the Bs by using two As, one attached to each adjacent joint.
13. Connect the tubes by stapling a row of As across the top.
14. Finish the dome by adding the last five Bs. These tubes come from the five joints and meet in the middle.

**ZOME** Shop Now Educators Fans News About Retailers Support



FAQ site search

**Pure Discovery, Pure Fun!**



[See Zome on Video!](#)

request a **catalog**

receive our **newsletter**

are you an **educator?**

Win a FREE Explorer Kit!  
That's right. We are giving away a free Zome Explorer Kit, a \$69.95 value! Click on Enter to register to win. Congrats to past winners, Lindy L. of Nevada and Beverly S. of Minnesota!



**enter to win!**

Parents' Choice Gold Award  
Dr. Toy's 100 Best Children's Products

Paul's Big Bag  
**of Parts**  
1/2 Pound of Zome Parts!  
**9.95!**

Zome educational construction toys - experiment like never before! Architects, artists, engineers, NASA scientists and educators recognize the power of Zome, using it as a teaching, as well as a research and modeling tool. But kids are the real Zome wizards, creating fantastic everyday, fun objects such as airplanes, bridges, animals and academic objects like polygons, crystals, and school science projects as vast and brilliant as the mind itself. In the classroom and homeschool, Zome teaches algebra, scale, number sense, symmetry, proportion, geometry, DNA structure, trigonometry, and lots more. For ages 6 to 106.

[ [Shop Now](#) | [Educators](#) | [Fans](#) | [News](#) | [About](#) | [Retailers](#) | [Support](#) | [Multimedia](#) ]

**GET ZOME NOW!**



We have just received more Toy Awards.

Please view [Hot off the Press: Zome](#), the PR section of our web site



[Teacher's Bundle](#)

Kids love learning math through play. A full range of lesson plans help you to design high impact lessons for the elementary~high school level.  
968 Pieces  
\$149.95 [GO ->](#)



[ScienceZone Series Bundle](#)

3 cool kits in one: Crazy bubbles, DNA, and Bucky Ball.  
\$37.85 [GO ->](#)

Zome is based on the 31-zone structural system, discovered by Steve Baer,  
Zomeworks Corporation, Albuquerque, NM, USA  
Copyright © 2001, 2002 Zometool, Inc. Made in the USA.  
No images or text may be used without written consent,  
exemptions available for not-for-profit organizations,  
please see our [copyright page](#) for details.



[Adventurer](#)

[Kit](#)

Build domes,  
crystals,  
flowers,  
bridges, DNA  
- anything you  
can imagine!  
242 Pieces  
\$34.95 [GO ->](#)

**GET ZOME NOW!**

# Detail Plans for a Geodesic Dome Observatory

All rights reserved, Joe Garlitz 1997, jgarlitz@orednet.org

---

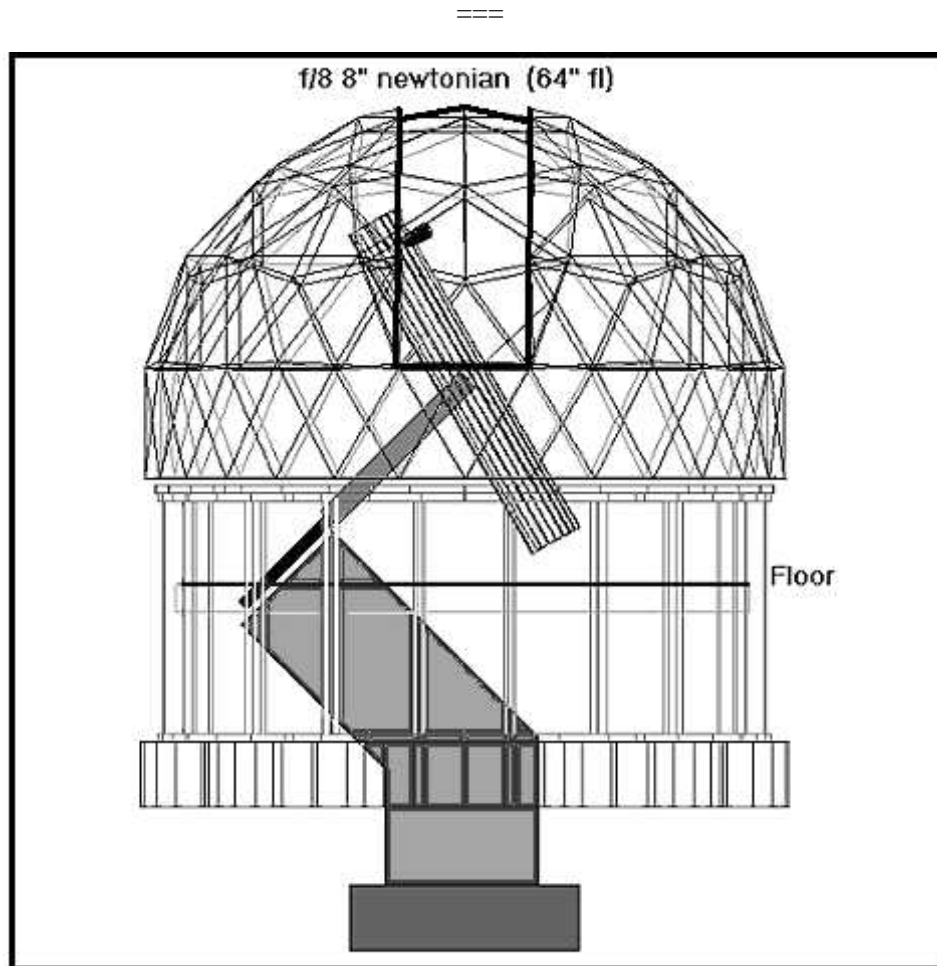

## INTRODUCTION

The "geodesic dome" design has been patented by the late Buckminster Fuller. No use of this design for monetary gain is of course allowed. I make no claims on the geodesic design. However, the geometry of this dome and all cutting patterns presented here were calculated by myself from basic geometric principles using DesignCad-3D (TM) and TurboCad-2D (TM).

## DESIGN

The dome is straight forward to construct but it takes a lot of attention to detail. The design is based on a geodesic composed of pentagons and hexagons. At the top of the dome is a pentagon. 5 hexagons surround this pentagon. 5 pentagons are then arranged around the perimeter in the niches formed by the hexagons. A second row of 5 hexagons is placed between the pentagons. Finally 5

half-hexagons are placed beneath each of the pentagons. Studying the figures should make this clear.

===

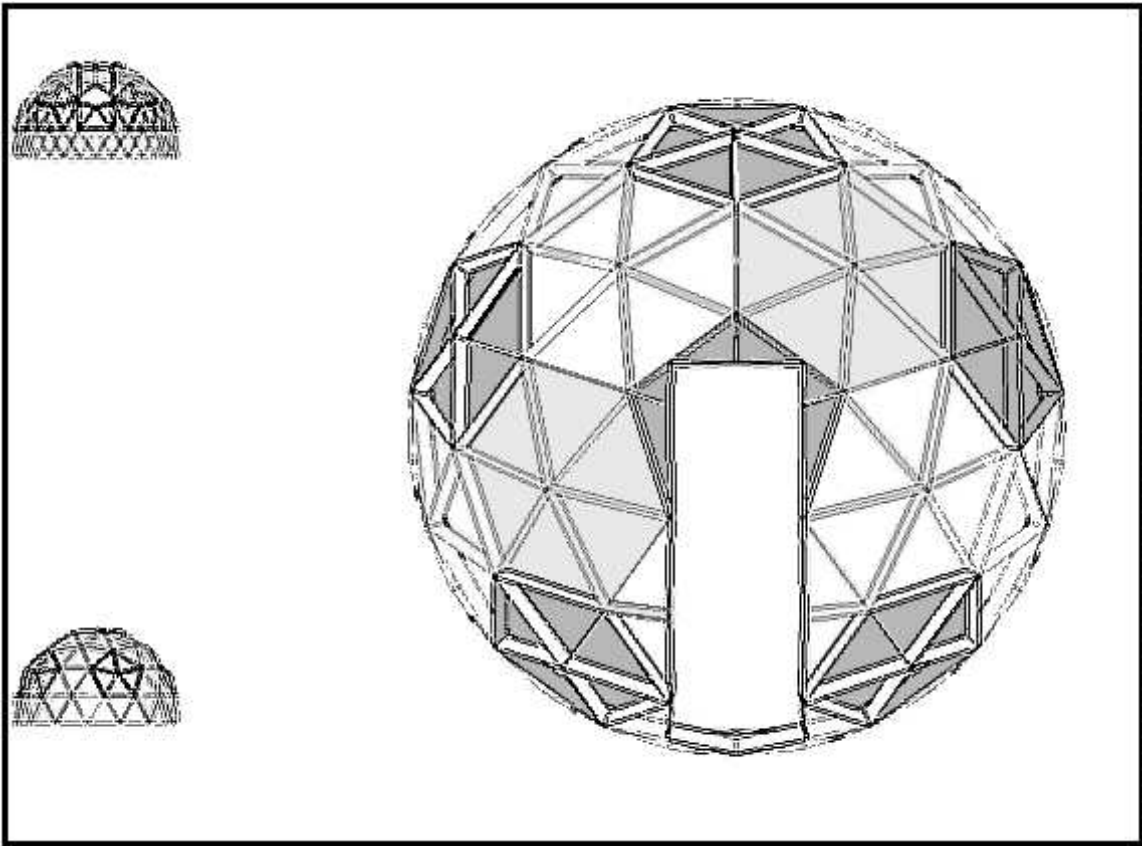
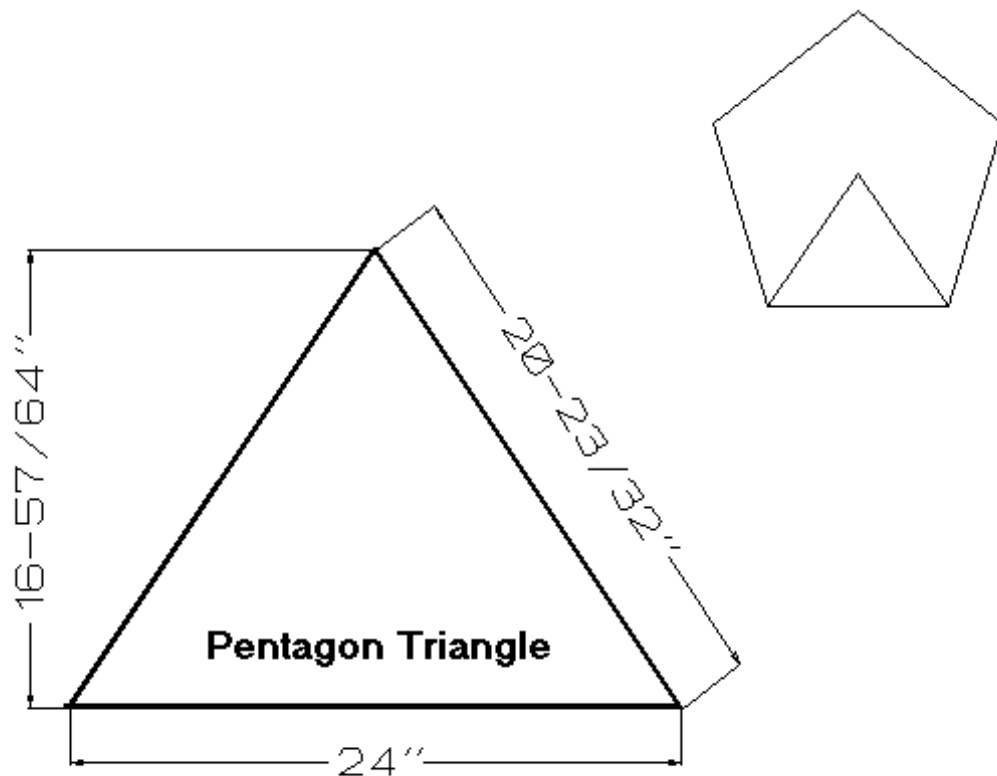

FIGURE 2 "domfrm\_g.jpg"

===

---

The entire dome is made of just two shapes; the triangle that forms the pentagons;



==

FIGURE 3 "pent\_tri.gif" ==

and the triangle that forms the hexagons. ==

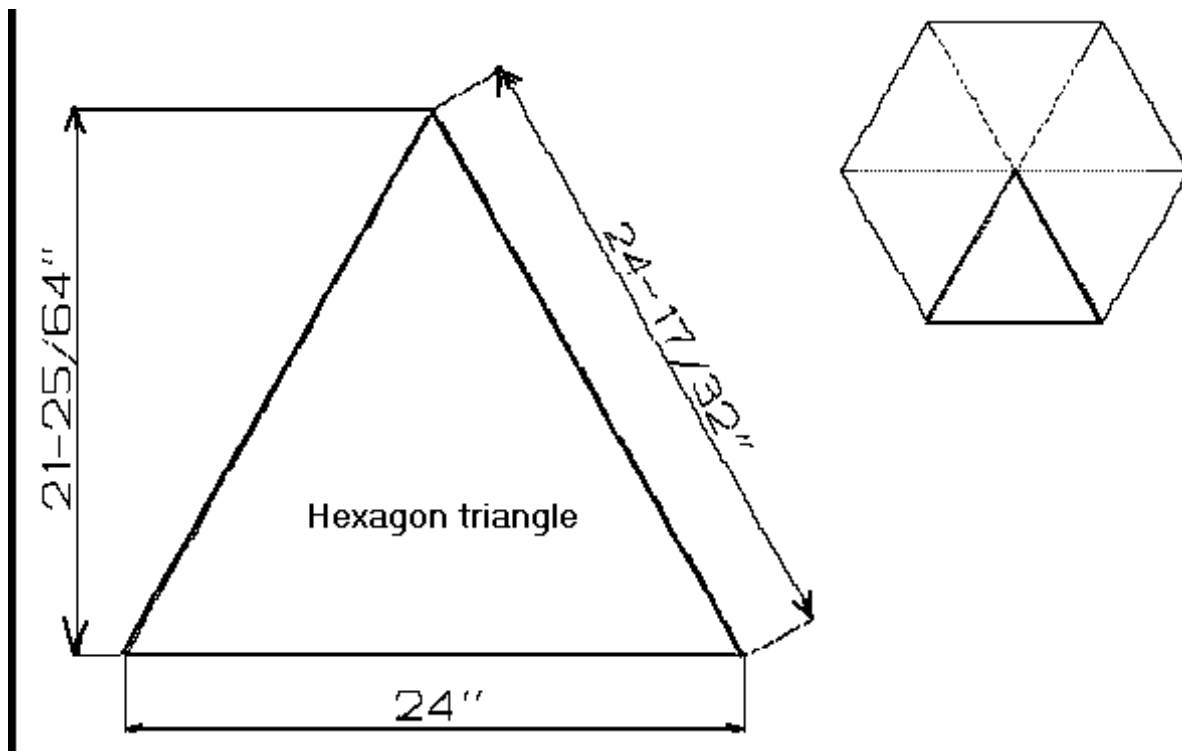

FIGURE 3 "hex\_tri.gif" ==

Note that the sides of the pentagons and hexagons are equal. In the dome shown here, the polygon side dimension is 2 feet. This provides a dome diameter of 9 feet 4 inches. This fits well with the size of my 64 inch focal length newtonian and worked out well with the size of the construction materials, i.e.. 4'x 8' sheets.

This design can be scaled to any size dome. All angles are as shown here. All linear dimensions are scaled by what ever factor you choose.

## CONSTRUCTION

### Cutting

The triangles are cut from 3" thick bead-board. The foam board cuts easily with a hot wire. You can rig-up a "saw" using the wire from an old electric heater element or using iron wire like bailing wire or re-bar tie wire. The wire is heated using an electric current. A rheostat connected to the wire, powered by a car battery is probably the safest approach. An adjustable transformer can also be used with relative safety for voltages below 20 volts.

#### **\*\*CAUTION\*\***

House current can be used

#### **BUT NOT DIRECTLY!**

#### **\*\*CAUTION\*\***

**IF YOU DO NOT UNDERSTAND COMPLETELY HOW TO DO THIS SAFELY, DON'T!**

#### **\*\*CAUTION\*\***

Set up a cutting table large enough hold a 4x8 sheet and to make a full 4' cut. See figure 8 for a diagram of a cutting table. This setup allows a long straight and perpendicular cut.

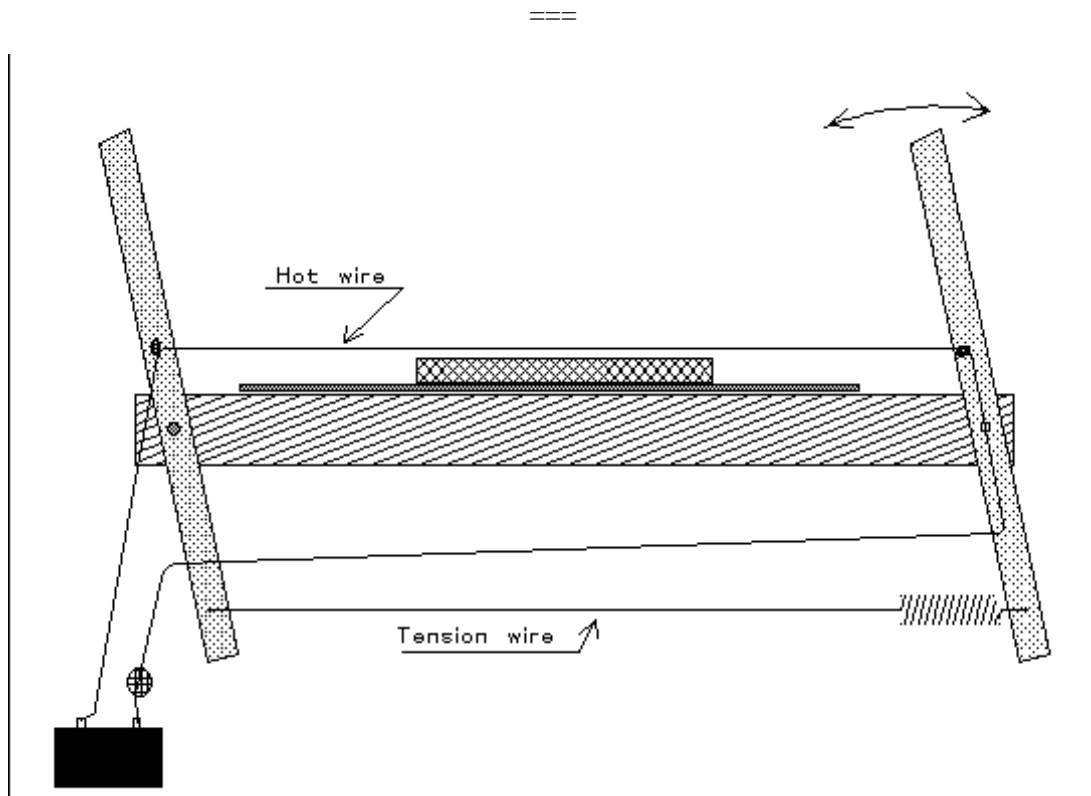
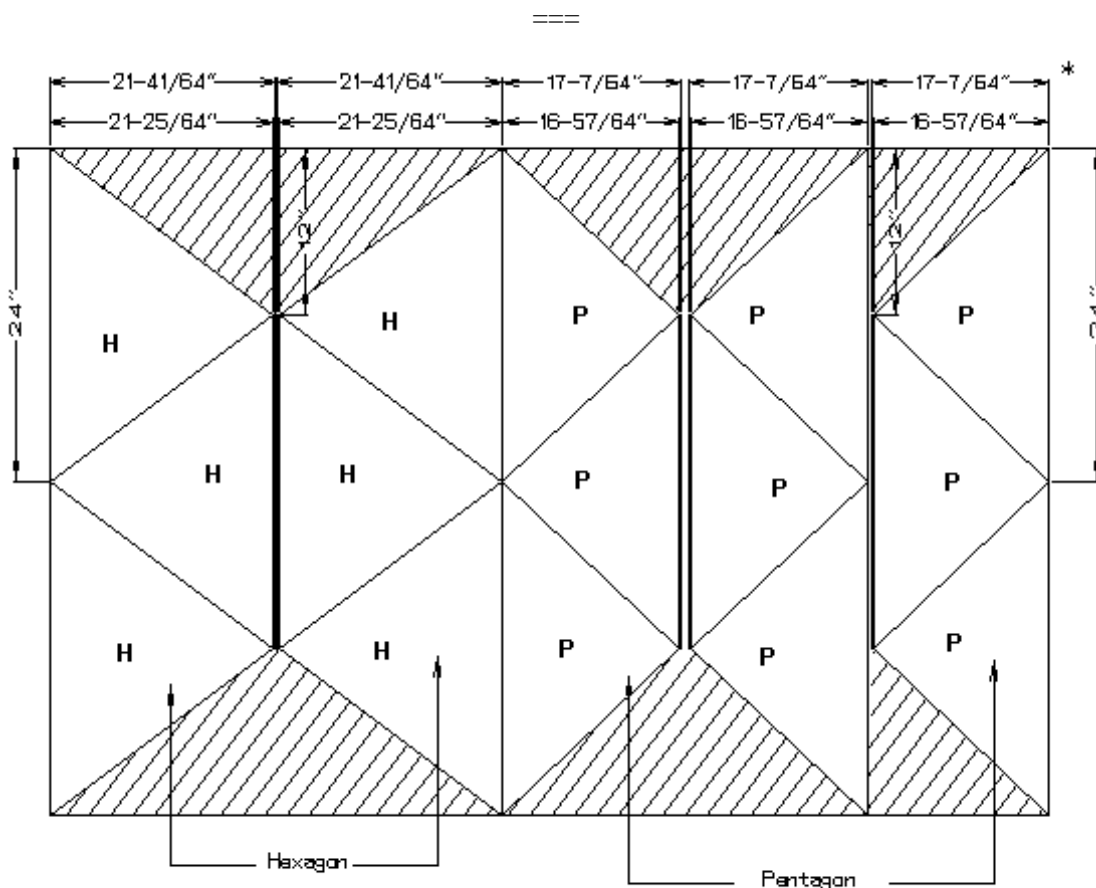

FIGURE 8 "cut\_tabl.gif" ===



The dome requires 30 pentagon triangles and 75 hexagon triangles. These are cut from seven 4'x 8' sheets of foam. Figures 9, 10 and 11 show the layout for cutting the sheets. This layout provides 29 pentagon triangles and 72 hexagon triangles. The remaining 3 hexagon triangles and the pentagon triangle can be made by cementing scraps together. The scrap triangles should be placed in the area that will be cut out for the slit.



**Cut 2 sheets**

Mixed cut pattern - 6 Hex triangles & 9 pent triangles

\* allowance for cut kerf

FIGURE 9 "p\_h-cut.gif" ===

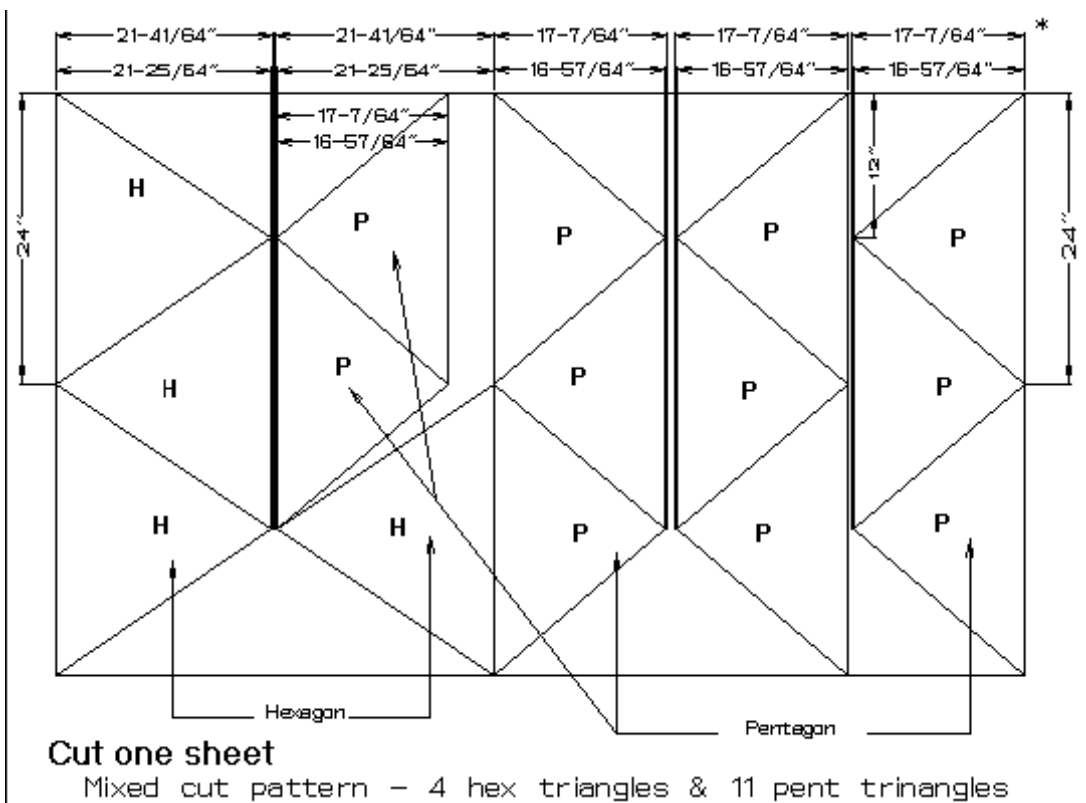

FIGURE 10 "p\_h-cut2.gif" ===

===

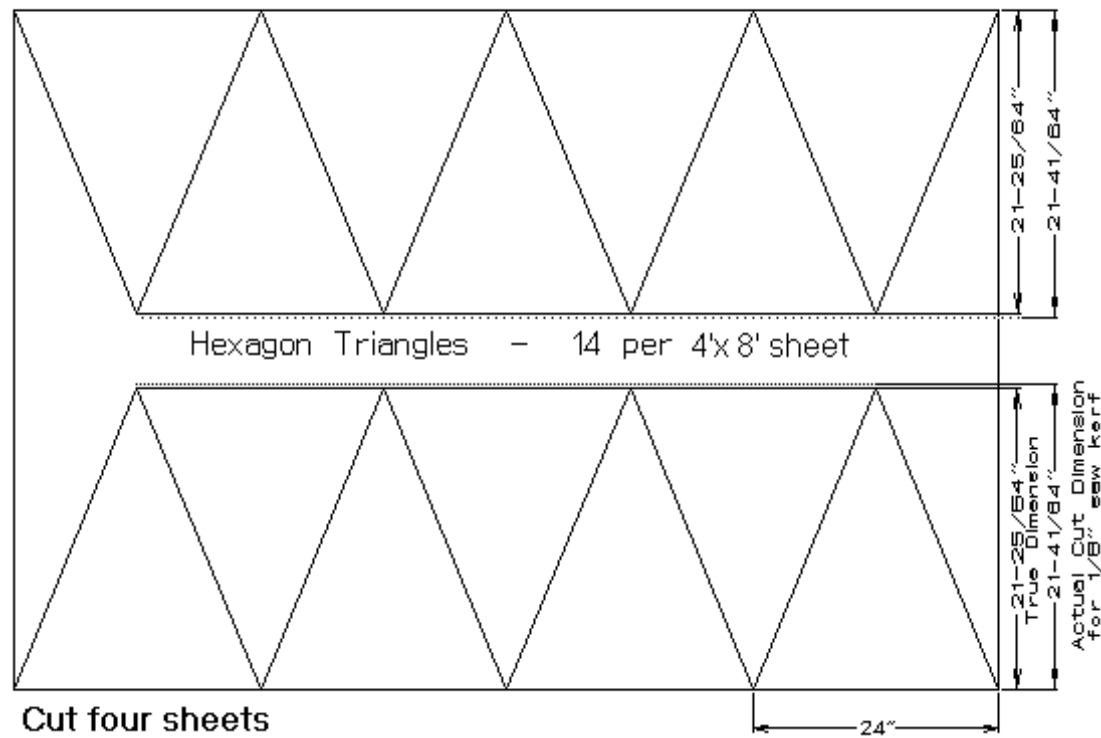

FIGURE 11 "hex\_cut.gif" ===

In laying out the triangle cutting pattern, allowance must be made for the width of the cutting wire. Two dimensions are shown for the

height of the triangles in the cutting patterns. The smaller dimension is the actual triangle dimension. The larger dimension is to allow for the cutting width. Figure 12 shows a close up of how to offset the triangles to allow for the cutting kerf.

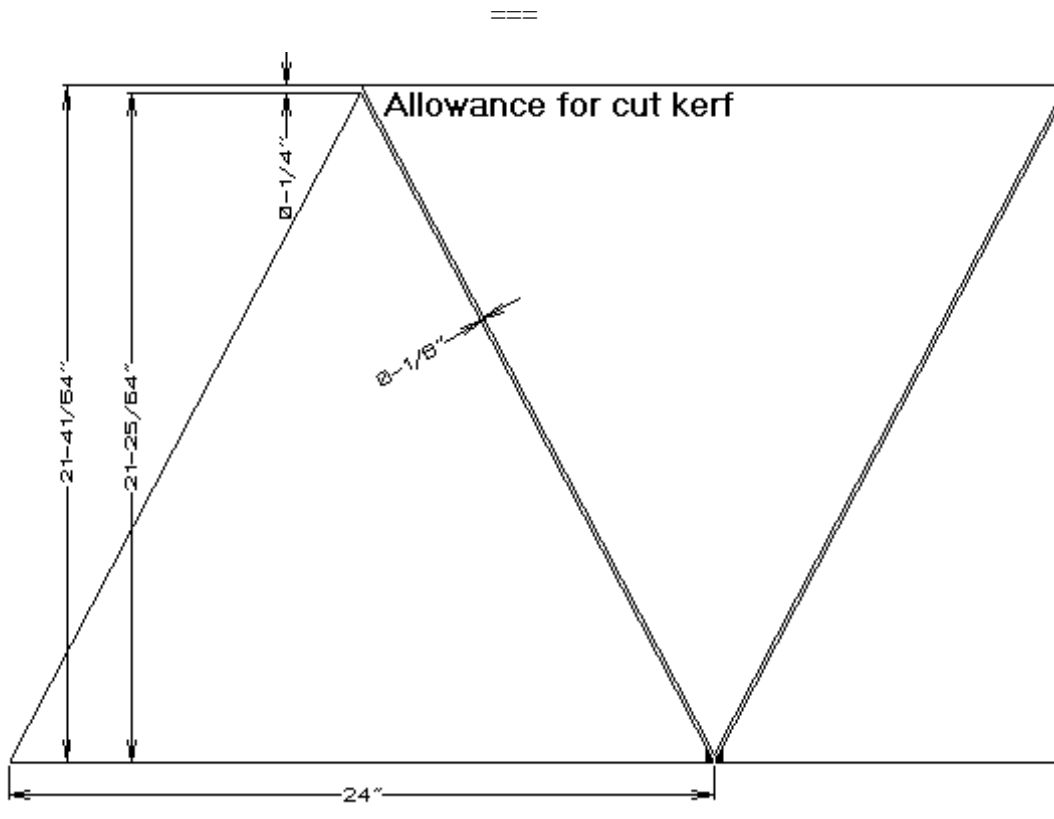

FIGURE 12 "kerf.gif" ===

Since there is no room to separate the triangle bases, the triangle corners will be snubbed off. This is not a problem, since most of this defect will be removed when tapering the triangle sides.

## Triangle shaping

The triangles are three dimensional, thus the edges must be tapered to fit into the dome. The triangles are equilateral. The equal sides form the "spokes" of the polygons; the base of the triangles form the polygon sides. Templates for tapering the triangles are shown in the following figures. It is important not to confuse the sides and bases.

===

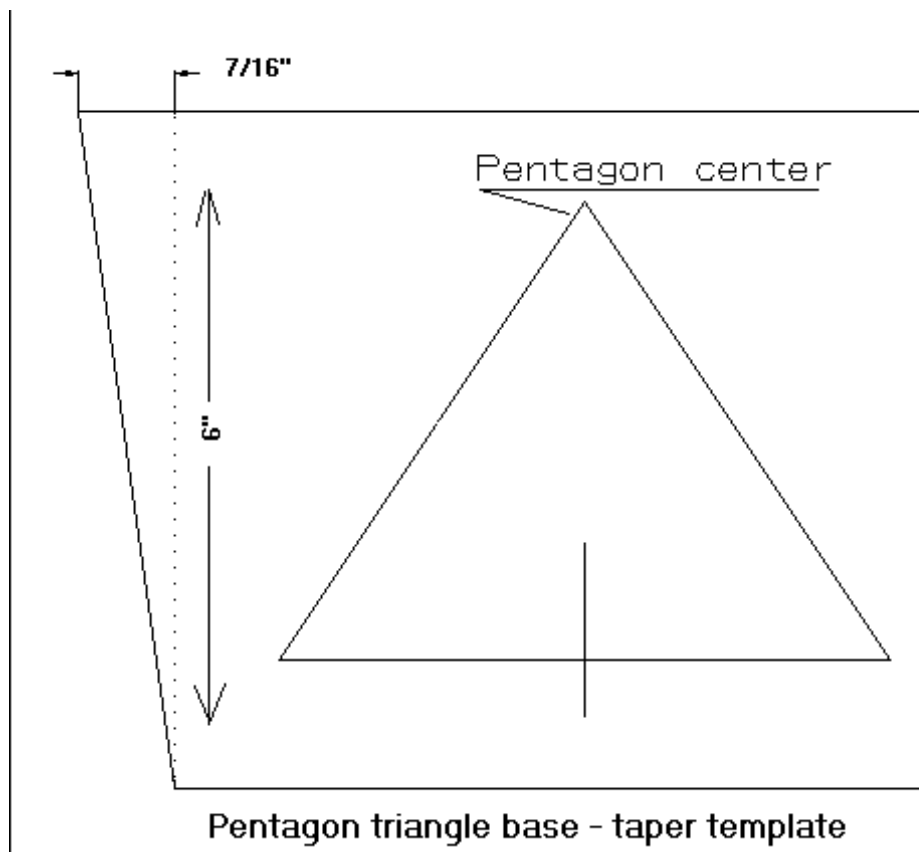

FIGURE 4 "p\_b-tmpl.gif" ===

Pentagon-triangle base taper template.

===

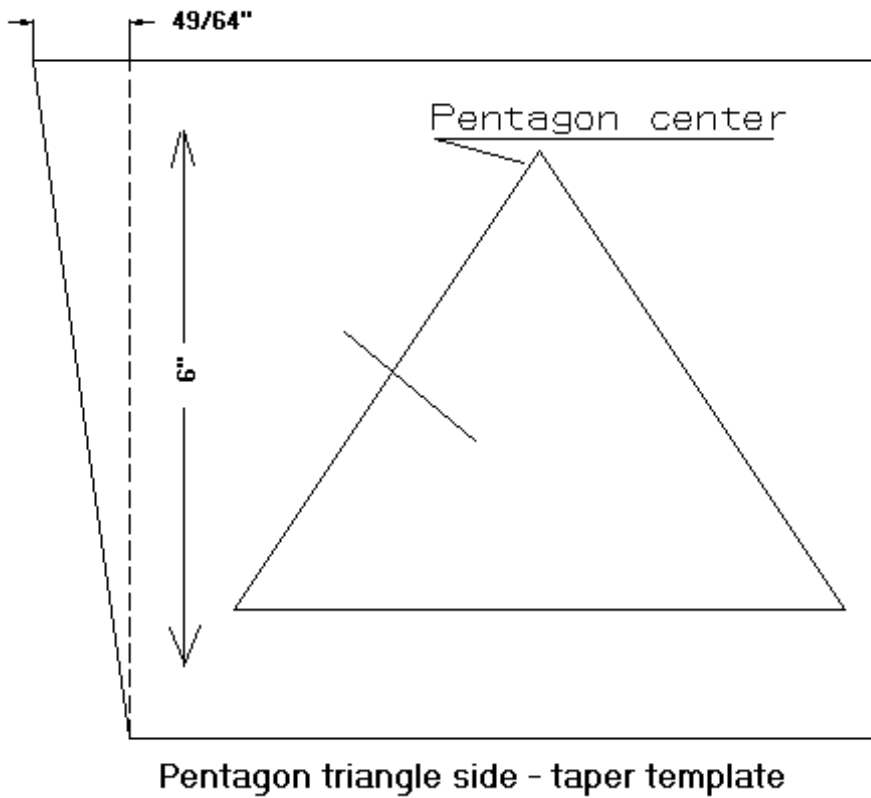

FIGURE 5 "p\_s-tmpl.gif" ===

Pentagon-triangle side taper template; taper both sides.

===

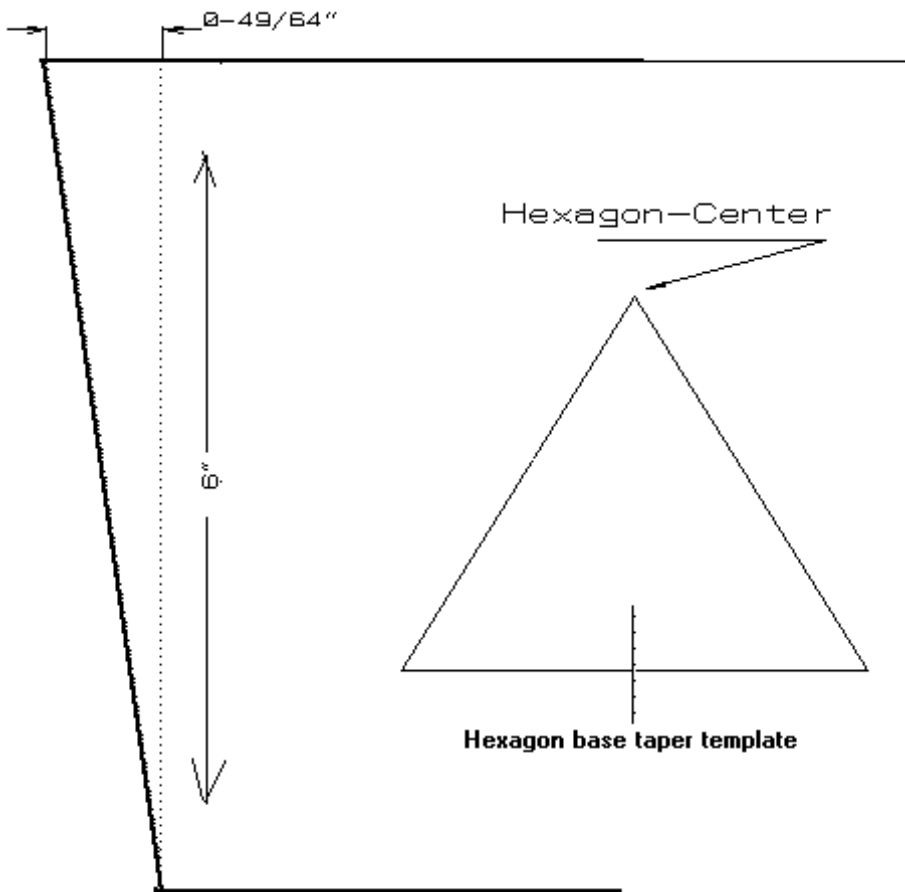

FIGURE 6 "h\_b-tmpl.gif" ===

Hexagon-triangle base taper template.

===

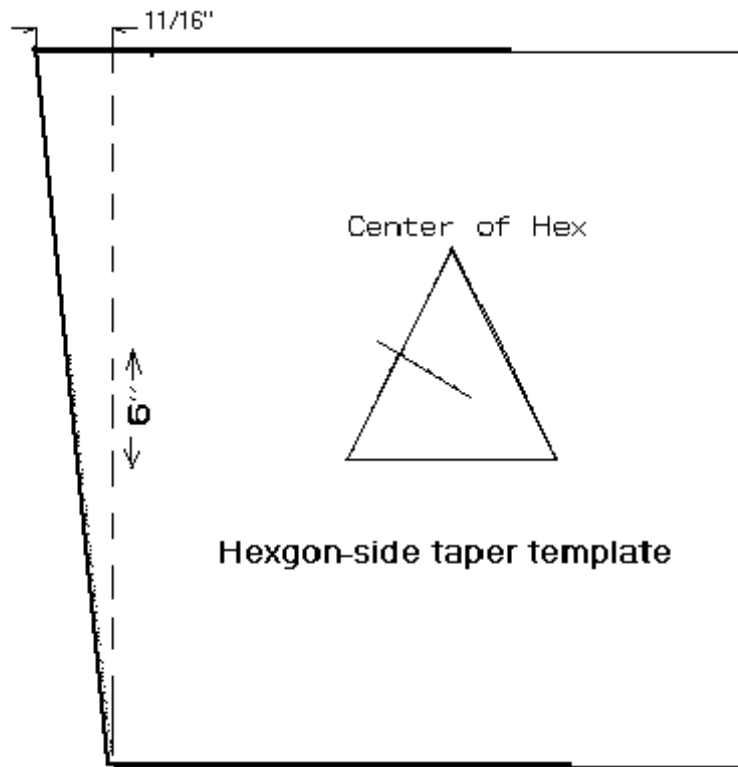

FIGURE 7 "h\_s-tmpl.gif" ===

Hexagon-triangle side taper template; taper both sides.

Setup the cutting table for cutting the tapers. Figure 9 shows a setup to cut the taper on the triangle sides.

===

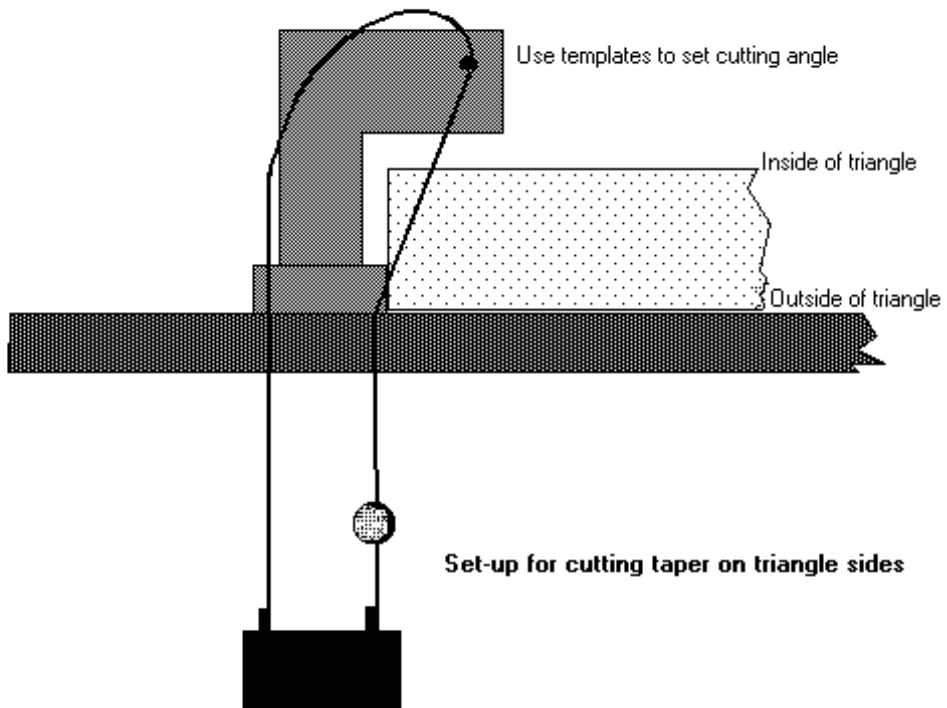

FIGURE 13 "cut\_tapr.gif" ===

Note, that there is a narrow edge left uncut by this setup. This is necessary to allow a uniform cut along the entire side of the triangle. The guide edge must be long enough to guide the triangle through the entire cut.

Cutting the taper is the most likely area to mess up.

- 1) Separate the hexagon triangles from the pentagon triangles.
- 2) Boldly mark one face of each triangle as the inside.
- 3) Mark the base of each triangle.
- 4) Set the cutter using the CORRECT template and cut the base tapers first.  
Note; Cut the triangles with the INSIDE face UP.
- 5) Reset the cutter using the correct template and cut the side tapers;  
again with the INSIDE face UP.

The taper of the hexagon bases and the pentagon sides are the same. So cut the pentagon bases first, then the hexagon bases. Then cut the pentagon sides, with this same angle. Finally cut the hexagon sides.

Use a course grit sandpaper on the cut-faces to remove any flashing left by the taper cutting.

## Assembly

**CAUTION**, test all chemicals that you plan to use, on a scrap of foam. Many paints, adhesives, solvents, etc. will vaporize the foam board. Water based adhesives and paints are generally ok. However, you will not live long enough for water based adhesive to cure, if you try cementing one piece of foam to another. Carpenters glue is highly recommended for gluing fabric and wood to the foam.

With the triangles finished, it is time to assemble the pentagons and hexagons.

I used 3M "77" spray contact cement to glue the triangles together. This cement bonds stronger than the foam board, so you must be careful to have the pieces properly placed before contact.

You can make a trial fit by taping the triangles together with duct tape. It is easy enough to cement the triangles together. However the last triangle of each polygon is more difficult. It is nearly impossible to get this last one in place without prematurely touching the contact cement. You can keep the cemented surfaces separated by putting a piece of paper between the cemented surfaces after the contact cement has dried. When the triangle is then put in position, the paper is slipped out.

**REMEMBER** to make 5 half hexagons. It might be best to make these first as a good place to get some practice. Mark the half-hexagons and set them aside.

Making all the hexagons by joining 2 half-hexagons together is a good way to avoid the problem of having to inserting the last triangle. (This doesn't work for the pentagons, however.)

With 6 pentagons, 10 hexagons and 5 half-hexagons completed, the dome can be assembled.

An extra set of hands is VERY helpful here.

Mark the hexagons and pentagons made from the scrap triangles, use these where the dome slit will be cut out.

Since the top of the dome will be cut out, start with a pentagon having scrap triangles. Cement 5 hexagons around this pentagon. (Note, one of these hexagons will be cut for the slit so it too should be one with scrap triangles).

Next, cement 5 pentagons in the notches formed by the hexagons, and then 5 hexagons in the notches formed by the pentagons. Finally place the remaining hexagons around the dome, and cement the 5 half-hexagons in place to complete the dome. Study figure 2 to see how the hexagons and pentagons go together.

At some time it might be easier to do this by turning the whole thing upside-down.

This is probably a good place to mention that **THE COMPLETED DOME WILL NOT GO THROUGH A SINGLE CAR GARAGE DOOR.**

Be sure you work where you can get the dome outside. I assembled my dome in two pieces; the upper half to the row of 5 pentagons; and the lower half of the remaining 5 hexagons and half-hexagons. It is best to assemble the whole dome in one piece, (but only if you can get it out of the garage).

With the dome completed you will notice that it does not sit flat on the floor. You must trim the bottom to make it flat. This can be done with the hot wire, if you are up to making this set up, or you can use a fine toothed saw and trim the bottom.

## Reinforcing the Dome

The dome sits on a ring made of particle board. This ring will be the surface for the rollers to run on, allowing the dome to turn. The ring is cut from a 4'x 8' sheet of 3/8" or 1/2" particle board. Figure 14 shows the cutting pattern for the base ring.

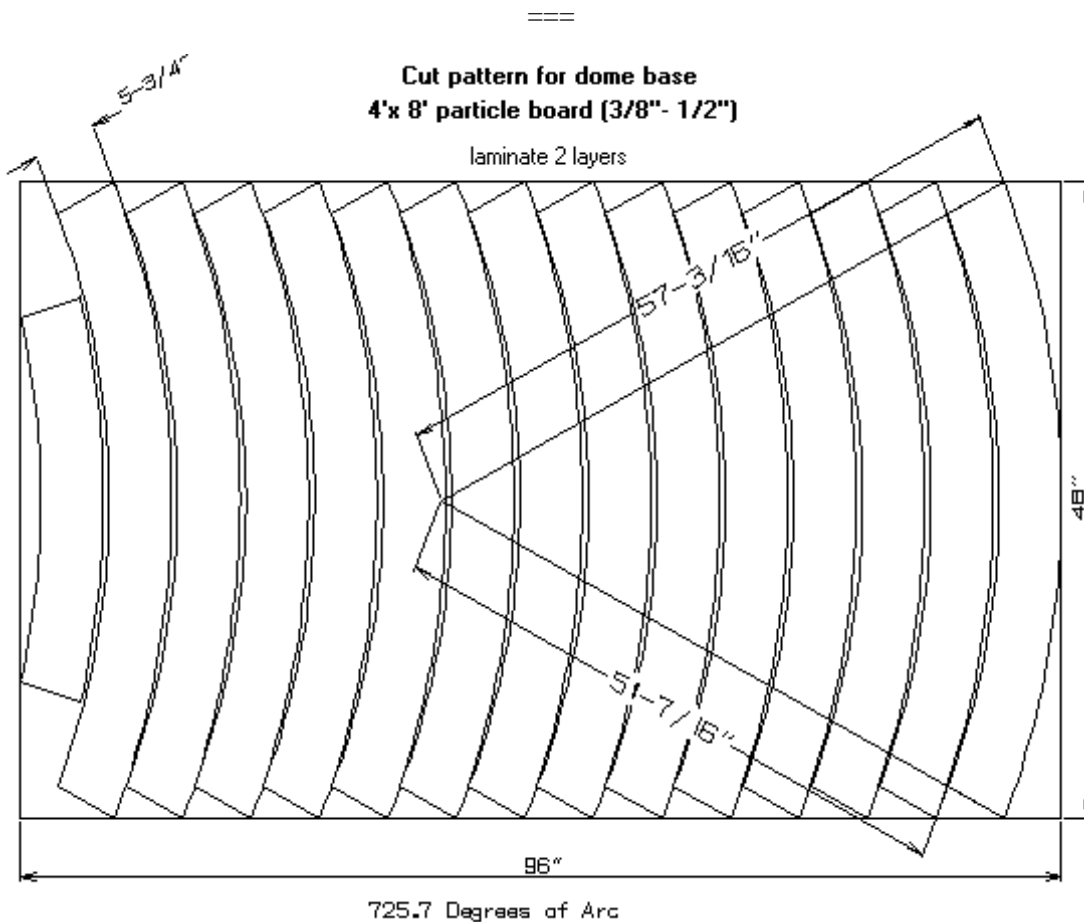

FIGURE 14 "base\_cut.gif" ===

Cut the ring segments as shown. Then draw a circle just over 57-1/4" in radius on a flat surface. Lay out the segments on the work surface just inside the drawn circle. It will take 7 and about 1/4 segments to complete a layer. With the segments together, uniformly inside the circle mark the 8th piece and cut it to fit. Lay the second layer over the first, lapping the joints in the first layer. Again mark the last segment and cut it to fit. Set the top layer off and spread carpenter's glue on the lower ring, replace the upper ring and weight it down while the glue sets. Check the ring to make sure it is round and within the circle. When the glue is set, the ring can be trimmed and trued to a circle by using a router. The router is fastened to swing from the center of the base ring by a strap or wire. Routers with this setup allows the inside of the base ring to be a true circle. This is important so the horizontal guide rollers that run on the guide band will not bind. More on this later

When the base ring is ready, place the dome on the ring. Center the dome on the ring and glue the dome to the base ring using carpenter's glue. (Note: if you haven't trimmed the bottom of dome, do it now so the dome will sit flat on the ring.)

To facilitate centering the dome, you might cut an access hole in the area where you will cut out the dome slit. The hole should be only large enough to allow you to get inside the dome.

The base ring must be reinforced to the dome. This is done by gluing plywood plates with gussets to the bottom row of triangles and fastening the gussets to the base ring. Refer to figure 15 for details.

===



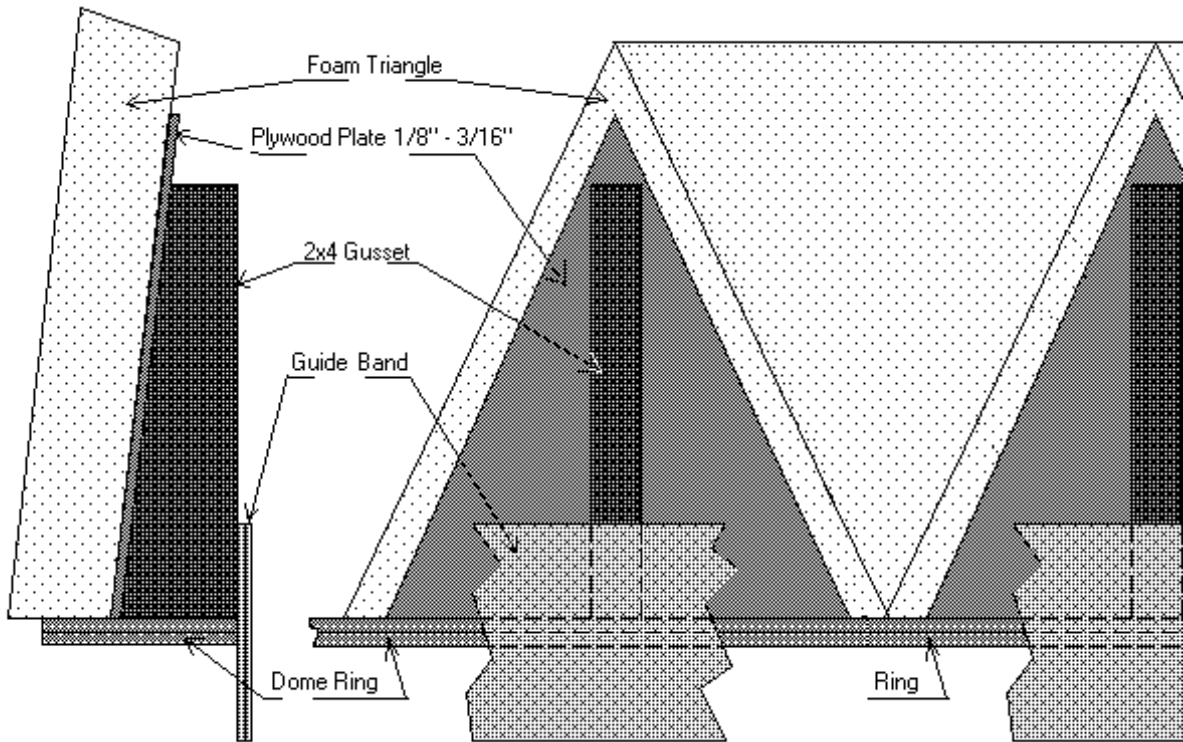

Figure 15, Reinforcement for dome & ring

===

The gussets that fasten to the plywood triangles and the dome ring are cut from 2"x 4"s. The width and angle of the gussets must be measured and cut to fit. There are several different angles that must be cut. It is best to glue and nail the plates to the gussets. The plates can then be glued to the dome and the gussets screwed to the base ring.

There is a band of masonite fastened inside the base ring, also shown in figure 15. This band will provide a centering guide for the dome as it rotates. Several horizontal rollers placed around the dome will run on the outside of this guide band to keep the dome centered. It also provides additional support to the base ring and gussets. The guide band is made of 6" wide by 8' long strips cut from a 4'x 8' sheet of 1/8" or 3/16" masonite. Two layers are laminated to form the band. It will take just over 3 and a 1/3 strips for each

layer of the band. Place 3 strips inside the base ring, then measure and cut the final piece. Cutting it just a fraction too long, will allow the band to "snap to" and hold itself in place. Cut the second layer of the band in the same way. Glue the two layers together overlapping the joint of the first layer. Clothes pins can be used to clamp the two band layers together. Proper clamps, though, will be needed at the butt joints to keep the joints tight and smooth.

## The Dome Slit

The dome slit is easily cut into dome working from the inside. Use a fine toothed hand saw. I cut the slit 24" wide using the side of the top pentagon as a reference, and cutting down through the top and bottom of the adjoining hexagon sides. This is adequate for telescopes 8" or less. A 30" slit is recommended for larger scopes. The slit is cut past the very top of the dome so the telescope can have a clear view of the zenith. (Note, the frame as designed, is wide enough to accommodate the smaller radius at the wider slit edges.)

It is important that the sides of the slit are cut parallel to each other and are parallel to the plane passing through the center of the slit. Resist the temptation to cut perpendicular to the surface of the dome where you are cutting. To keep the cut straight, fasten a template of stiff paper or card board, the width and length of the slit, over the area to be cut. Cut along the edge of the template and perpendicular to its surface.

A rigid frame is constructed to reinforce the slit. The sides of the frame are made by laminating arcs cut from masonite. The arc of the frame is just a little over 90°. Figure 16 shows the cut pattern for the slit frame sides:

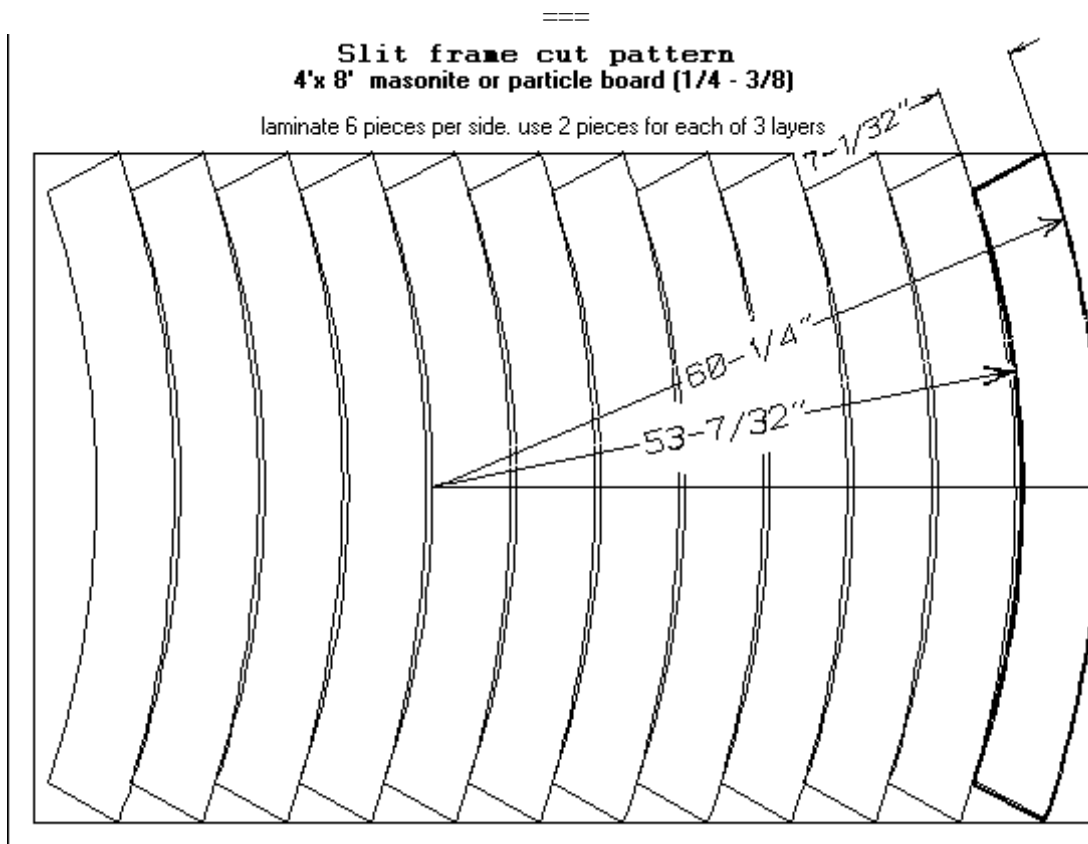
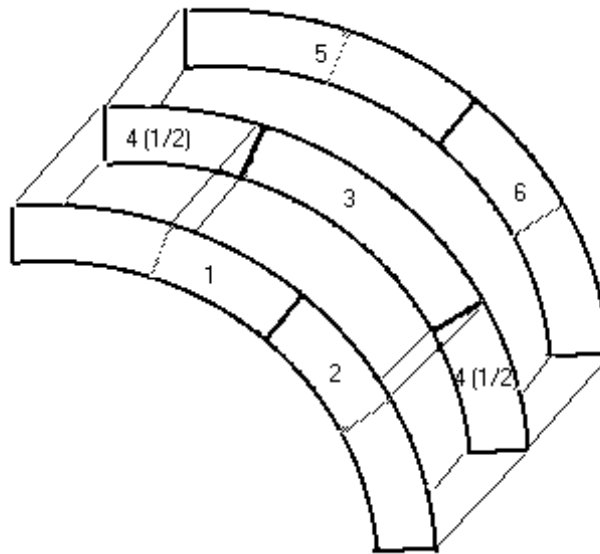
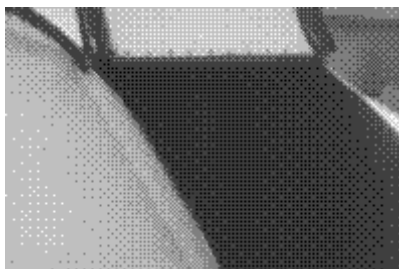
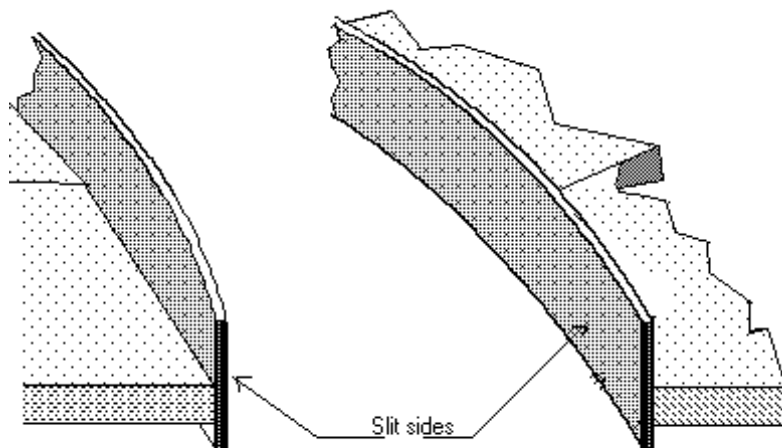

Figure 16, Cut pattern for slit frame sides



Lay out two arcs end to end, place a third arc on top of these, centered on the joint. Cut a fourth arc in half, and place the halves at each end of the third arc. Finally, place two more arcs on the stack to complete the side. The pieces are glued together. When the glue is set, make ends for the top and bottom of the slit frame, forming a "box" of the sides, top and bottom. You will want to smooth and finish sand the sides before you assemble the frame "box". This allows the two sides to be shaped together.



The frame is placed into the slit cut-out in the dome. It is glued in place using carpenters wood glue. Adjust the frame, in and out so you have the inside edge of the cut just covered. This leaves a substantial lip on the outside to protect from rain and snow.

It is a good idea to place a reinforcing triangle plate and gusset under the bottom end of the slit box. The 2x4 gusset should extend between the base ring and the bottom of the slit frame. If you will use the slit as an entrance, the bottom of the frame should be wide enough to extend into the dome and rest fully on the 2x4 gusset under it. (Note, the slit bottom should not be a step, but in any case reinforce it because it will get stepped on.)

## The Dome Support Structure

The dome structure is basically completed at this point. The outside surface needs to be finished to protect it from the elements. Before finishing the dome surface, the support structure should be constructed and prepared to accept the dome. The dome as constructed to this point will weigh less than 100 lbs. However, with the stucco finish, it will weigh 300 to 400 lbs. Obviously, it will be much easier to put the dome on its support before the outside surface is coated.

The under-structure must be designed to accommodate the specific type and size of scope the dome is housing. My newtonian is mounted on a fork close to the floor. The side wall is thus only 18" high to the bottom of the dome, with the bottom of the slit 30" above the floor. As a result, I use the slit for access.

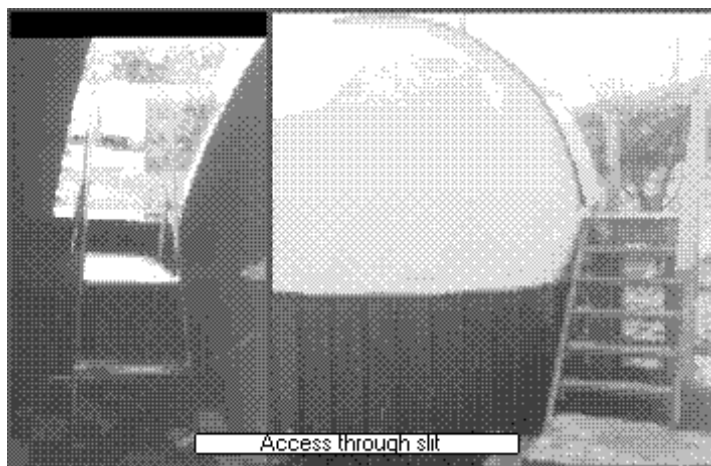

Figure 17, Access steps

A cassegrain will, of course, require a much higher side wall. The access will most likely be through a door in the under-structure. The dome can be supported on a circular structure like I built, or a structure of what ever shape and size suits the needs of the instruments and the observer. This is left as an exercise for the builder ;-)

The dome is supported on rollers mounted on the under-structure. I used synthetic "rubber" cart wheels available at departments stores and building supply stores. Wide, small diameter rollers are preferable, but any sturdy wheel with a decent bearing surface will do. Place at least 5 rollers around the perimeter of the under-structure to support the dome.

Guide rollers are place between the support rollers. These too are cart wheels. Thin, large diameter wheels are best for this purpose.



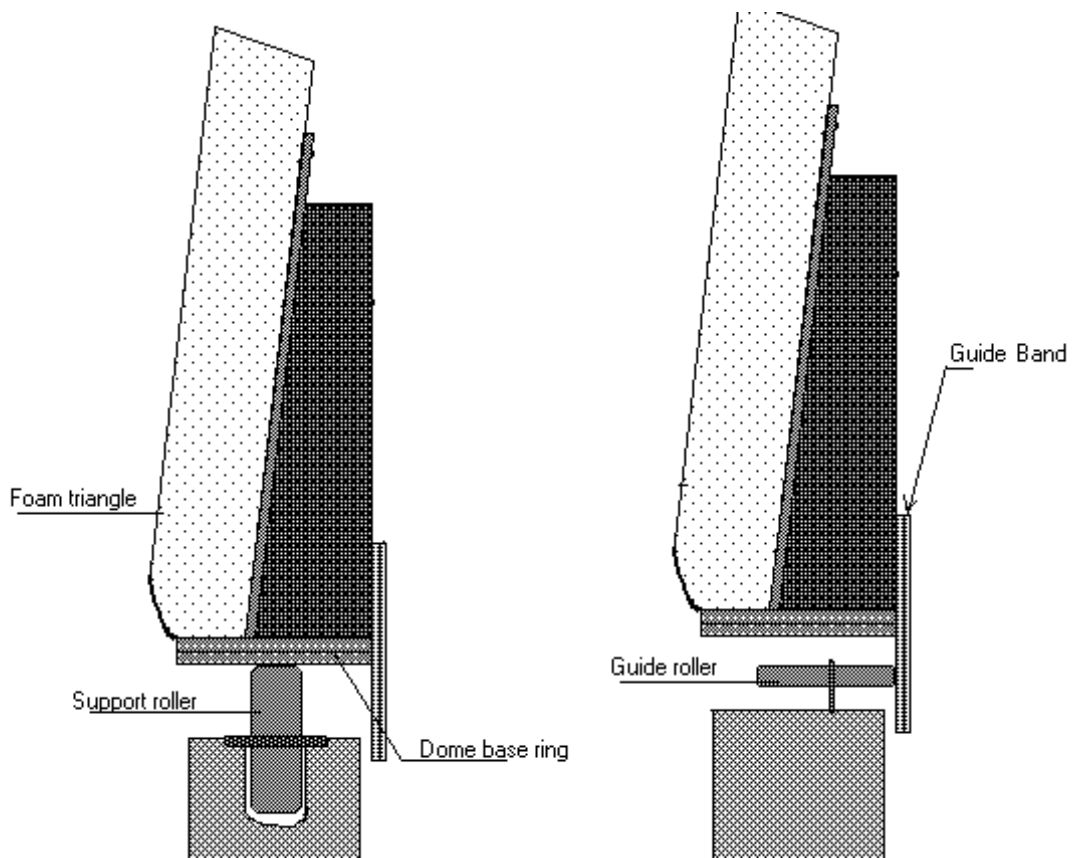

Figure 18, Support & Guide Rollers

## Dome Surface Finish

To make the Styrofoam surface durable, it must be coated with a weather resistant surface. Also, to keep the elements out of the structure, a slit door and a perimeter seal must be fashioned. The door can be constructed after the surface is finished, so we will deal with that later. The perimeter seal must be integrated into the finished surface. Figure 19 shows the detail for the seal.

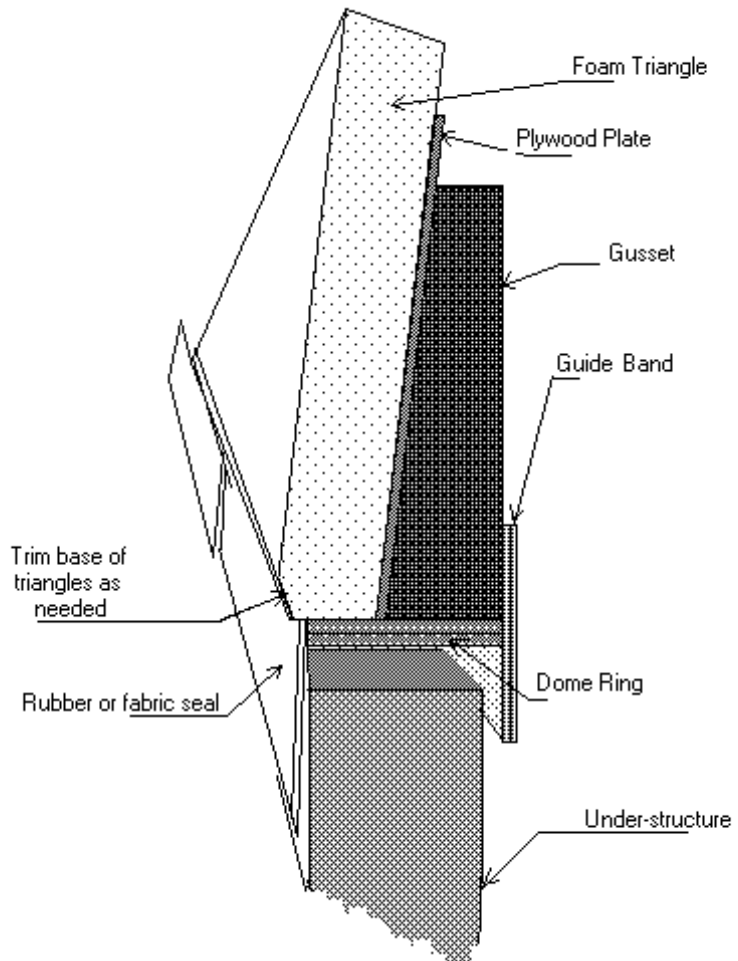

Figure 19, Perimeter Seal Detail

The seal material can be made from fabric such as canvas, and painted with the dome. However a better material, that will also be used to seal the door panels, is rubber sheeting used to cover RV roofs. You can probably buy a small piece from a trailer repair shop.

The seal is made of a number of strips, each about 12" long and 4" wide. After the dome has been set in place on its rollers, the strips are fastened to the outside edge of the dome ring, overlapping the strips 2"- 3" . Fabric can be glued with carpenter's wood glue. Rubber can be cemented with the contact cement used to build the dome. Tacking the strips down to the ring with brads helps hold the strips in place and gives them added strength. The bottom edge of the dome triangles can be trimmed smooth to the seal with very course sand paper. This gives a finished look to the base and makes it easier to bring the stucco finish to the seal.

With the seal strips in place the dome surface is ready to finish. The surface of the foam is coated with a thin layer of concrete (stucco). Window screen is imbedded for reinforcement. I used fiberglass screen, however, if one is going to use a CCD camera in an area with a significant amount of RFI, aluminum screen would provide a shield. NOTE: [If your observatory is at an exposed site, and you use aluminum screen, it would probably be wise to provide several grounding conductors from the dome reinforcing screening to a ground rod, allowing grounding of a possible lightning strike.]

The concrete is best if mixed from scratch. A very "rich" mix is made using the following:

by volume;

- 2 parts screened sand;
- 1 part portland cement;
- 1/4 part mason's lime.

The sand must be screened. Use window screen to sift out any large granules. It's best to start with "masons" sand. This is sand that has been screened at the sand and gravel plant, but it will still contain a lot of "boulders". You can use river sand, but it must be washed and drained first. To wash the sand place it in a bucket with a garden hose turned on full. Stir the sand with the water running to lift and wash sediment and organics out over the top of the bucket. The sand must be drained or it will be too wet to give a proper mix.

Mix together the sand and the lime. Add just enough water to make a damp mix. After the sand and lime are well mixed, add the cement (no water), and mix thoroughly. The mix will soften as you mix it, so resist the temptation to add water. To test the mix before adding water, vigorously mix a small area. If it softens, continue to mix the batch until it all softens. Add water only after mixing very well and add in small amounts. The mortar is to be like soft butter or cake frosting, not thin or runny.

The lime makes the mix "buttery". It has a better effect if mixed with the sand before adding the cement. There is a wide range you can use to make the mortar and still get a good product. The cement can be as rich as 1:1 with the sand, and as lean as 1:3 and still give a good sound concrete. If the mortar is not "squishy" soft, add a little more lime. The best mortar is the mortar that works best, so experiment.

Pre-mixed concrete can be used; use "mortar mix". This mix needs to be screened too. You will probably find that it needs a bit of masons lime added, to make the mortar soft enough to apply easily.

**CAUTION:** Both the lime and the cement are harsh basic (Caustic) materials. I have found that rubber kitchen gloves work well to protect my hands. The heavy rubber construction gloves are too stiff to allow close work. Kitchen gloves don't last as long but are much easier to work with and quite inexpensive.

There is one other ingredient that you might want to use in your mortar, a substance that looks and smells like carpenters wood glue, (Elmer's glue). It is called concrete bonder. you can use it in your mortar and on the dome. If your mortar is not sticking tightly to the dome when it is set, try using this material. Add some to the mix as the directions on the container indicate. Also mix some of the bonder with water and paint it on the dome. Paint it ahead of your working area, so it will be damp but **NOT** wet.

Before beginning to lay up the mortar, place several braces in the dome slit to keep it from sagging under to weight of the mortar. When the mortar is set it will be very strong and support the dome, but as you lay it on the foam, the dome slit will sag if not braced; (voice of experience).

Cut several pieces of window screen basically large enough to cover a triangle. Try "dry fitting" them to the dome. The screen should lap the seams between the triangles. See how the screen will adjust to the surface. Aluminum screen will stretch more easily than the fiberglass screen, since the strands are not bonded to each other. When you have a good feel for placing the screen without wrinkles or bubbles you are ready to start laying on the mortar.

Starting at the bottom, work around the dome doing the bottom layer of triangles. Remember to keep the seams of the screen on the face of the triangles so the triangle seams are overlapped by the screen. Fit the screen around the bottom edge and onto the perimeter seal. You can cut slits into the screen to get a good fit. Run the mortar onto the seal where it fastens to the base ring. Use plenty of mortar, shaping it around the bottom of the triangles and onto the seal.

When laying on the first layer, fill in the voids at the triangle seams and any hole dents etc. Work the mortar on to the dome slit frame. Run the screen up to the slit frame and bend it up along the frame a 1/2 inch or so. Cover the screen at the seam well with mortar, working it into the joint and onto the frame.

Work completely around the dome, one layer at a time, letting the mortar cure between layers. This will allow the weight of the mortar to be uniformly loaded on to the dome, and also allow the first layers to strengthen the dome as you put more and more weight on it.

Once the mortar is laid on, the next trick to getting a sound surface is to cure the concrete slowly. This is done by keeping the new mortar *wet*. As soon as the mortar skins over you can wet it down with a fine mist. Avoid streams that might run down the surface, as they can cut into the fresh mortar. After 5-6 hours the mortar will be fairly firm and can be watered more heavily. **Do not** let the mortar dry out for at least 3-4 days. The longer it is wet, the stronger it will be. You can use plastic sheeting to wrap the dome to hold the moisture. Filmy painters drop cloth is cheap and works well.

Practice working with the mortar. If things aren't working out, you can strip off the mortar by pulling on the screen. Loose a little sand and cement to save your sanity and/or pride. A small pointing trowel works well around the base and along the slit. A wide plaster-board taping trowel works well on the open areas. You can try using a cement finish trowel, but I have never gotten the hang of using one. A wooden float will probably pull the mortar too much, but you might try one. Always keep the trowel at a slight angle to your work. If you lay it flat, it will stick and pull the mortar off the dome. If you can find a contractor doing stucco work, go and watch him/her work. It will never be as easy as they make it look, but can learn enough by watching to make the job a lot easier.

As soon as the last of the dome is covered and the mortar is set, you can paint it. Use white rubberized mobil home roof paint. I tried a fancy two layers system the first time; black under coat and a white top coat. The two layers didn't bond to each other and the top coat

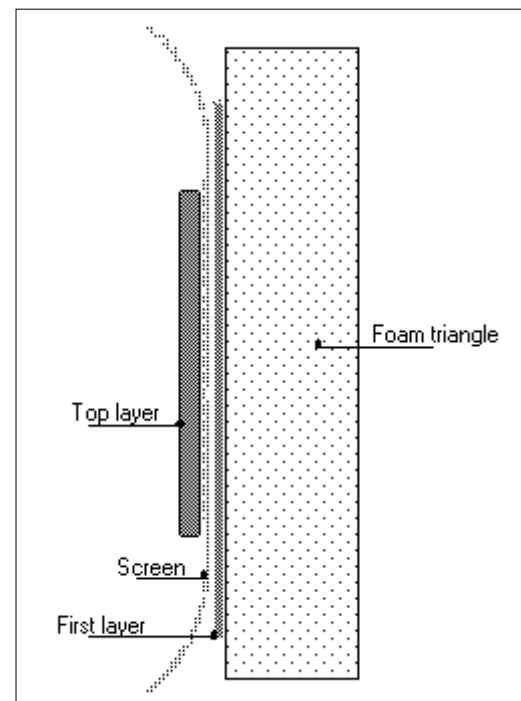

filled with "water blisters" as soon as the rains started. I would recommend any decent white rubber roof paint. You can get it in 5 gal pails at your favorite mart-mart store. Make the first coat heavy. I noticed that regardless of the kind of brush I used there was a myriad of small bubbles that dried in the paint leaving pin holes. So expect to paint two or three coats. The second and third coats do not have to be heavy. Paint the entire dome, the slit frame inside and out, and the perimeter seal. You need to paint the slit frame with several heavy coats to prevent moisture from getting into the wood.

You can finish the inside with plaster-board taping plaster if you are up for it. I just painted the inside with a flat black interior latex. (Gets real dark inside with it black when compared to the white before being painted.)

## Slit Door

The slit door is made of masonite. The curvature of the dome gives enough strength to the masonite that a thickness of 1/4" is adequate. To set a curve in the door, bent the masonite, sprinkled it lightly with water, then let it dry. The door on my dome is 8' 3-1/2" long. The door was made from an 8' strip, 25" wide. I "stretched" the piece by widening the gap at the hinges and using a wide end piece.

The door folds in three pieces as shown in the photo. The Pieces are hinged with "piano" hinges. Use wide hinges if you need to stretch your door length a bit. Paint the door with a good enamel to guarantee a weather tight coating on the masonite. The hinges are sealed with rubber roofing used on travel trailers. It is a white rubber sheet and makes a great seal, see figures below.

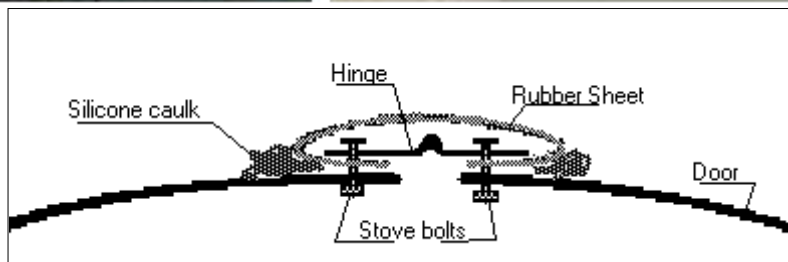
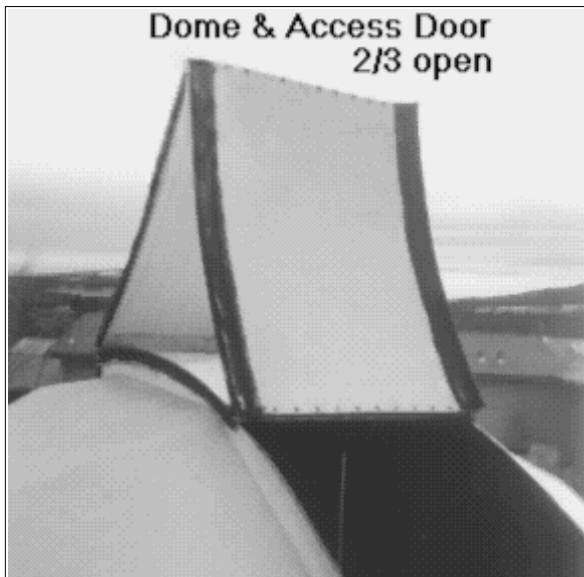

Its a bit tricky getting the stove bolts in place. Place the bolts in the hinge, then fold it to keep the bolts from falling out. The rubber strip can then be placed over the bolts. The rubber will hold the bolts while you feed them into the door. Cut the rubber 4 to 5 inches longer than the width of the door. The over hang will keep rain from blowing into the hinge. Measure the width and cut the rubber so it will fit snug but not tight when the hinge is open. Use plenty of silicone caulk between the door and the rubber.

The door is fitted with a garage door seal to provide a seal with the slit frame. I used a "slick" finished seal, and had a real problem getting silicone to adhere. It acted like it was bleeding oil into the silicone. If you can find a flat finish foam-type material, it might work better. See the figure showing the seal and finish trim. I slit a rubber hose and used it to cover the door edges. This too bled into the silicone and made it difficult to get a good bond. I don't know what to recommend here. You might have to try a couple of different materials.

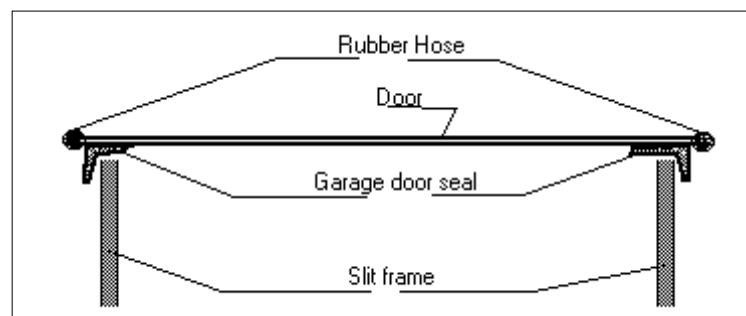



A couple more details need to be described. The two figures below show how the door opens. Notice that in the 2/3rds open position, the first door section slides along the face of the third section. A couple of "glides" are fastened to the end of the first section to allow it to slide without damaging the face of the third section. When full open, the door is supported by a stop to hold the door. There is a hook at the top of the door to catch the end of the first section. Without the hook and the door-stop, the door wants to cascade down the back of the dome. The stop also holds the door up where it can easily be pulled closed. I made the stop from a scrap of foam board. It is attached with silicone and has a rubber "shoe" on its face. The hook is cut from an aluminum extrusion. Storm doors, shower doors etc. make a good source for finding an appropriate extrusion shape. (You can tell I spend a lot of time scrounging materials in the "dump", eh, recycling center.)

To facilitate closing the door a rope is attached to the third section. Pulling the rope swings the folded door closed where it caught and lower. It is then unfolded. The door is held closed by "chest" latches. The latches are attached on the inside of the door at each end of the hinges and at the extension of the bottom of the door. The latches are attached to catches on the inside of the dome slit.

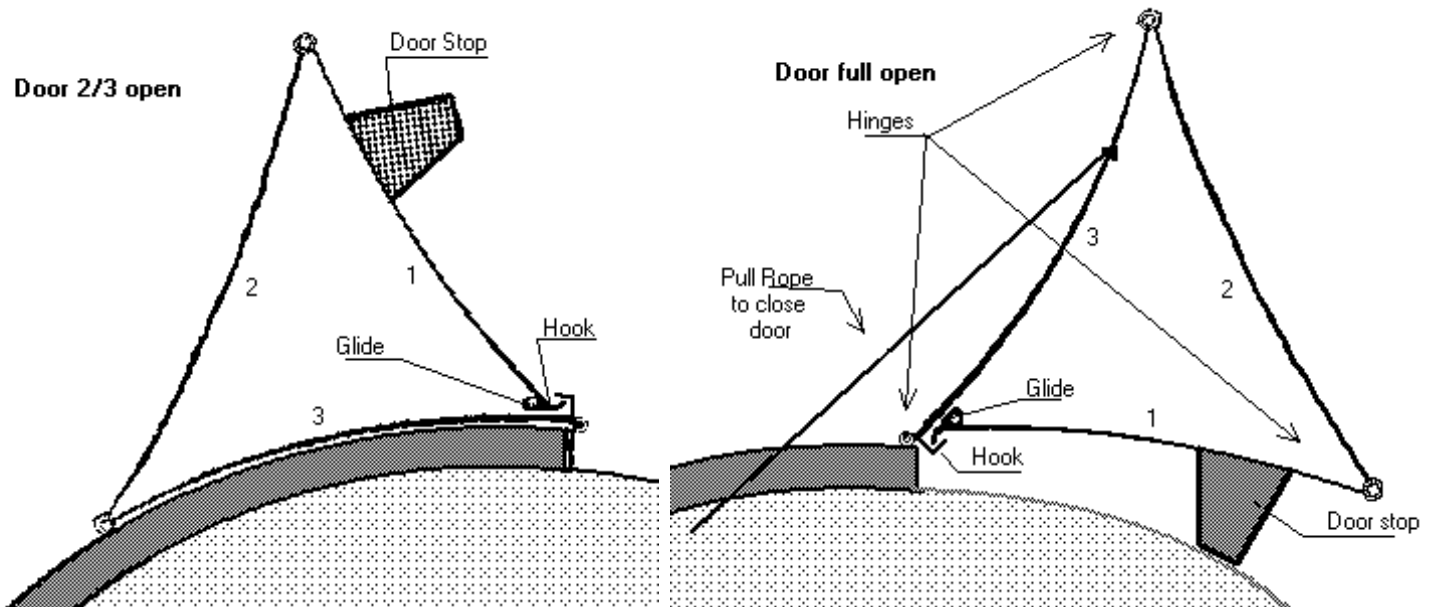

Since the door must be a bit longer than 8' (the length of the masonite board), to "stretch" the door, I used a couple of pieces of aluminum extrusion to sandwich the door at each end as shown in the figure.

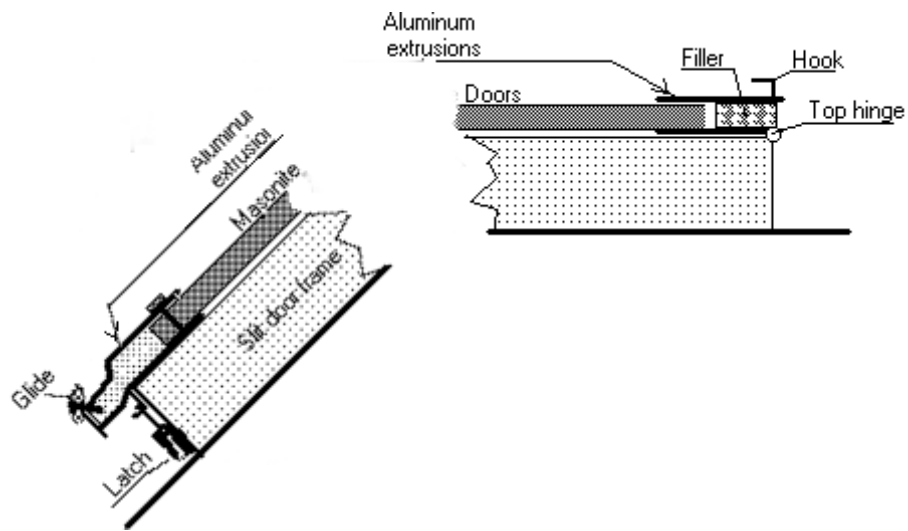

---

Well that just about sums up the project.

Feel free to e-mail any questions or comments you might have, including proof reading comments.

This material is presented with the same spirit expressed by Mel Bartels, in presenting his Alt-Az dobsonian drive; i.e.. having been helped along the way by others, this is offered freely to those who wish to use it for non-commercial purposes. Maybe it can assist them in their pursuit of the beauty of the skies. Clear skies and dark backgrounds, Joe Garlitz

# Formactive

## Geodesic Structures by Steve Miller

---



In 1972 I first became interested in geodesic domes. There was little information available at the time, beyond an article in *Popular Science* for pool covers. A group of domebuilders in California published *Domebook 2* in 1972, which I bought right away (*Domebook 1* came out earlier, but must have been rare. I have never seen a copy.). I studied it tirelessly, trying to get my mind around figures based not on squares nor even with a gravity orientation.

[24' Plydome](#)

[Small Domes](#)

[Aluminum Foil Dome](#)

[18' Research Dome](#)

[Geodesic Tent](#)

[42' Plydome](#)

[Chrysalis](#)

That book was jammed with useful data; however, I was alarmed by the domes they were promoting. Although the geometry was a challenge for me, I had worked as a roofer during summers in high school and college, with shingles and flashing and roofing cement, and knew a lot more about roofing than anyone in *Domebook 2* seemed to know. They were building hemispherical walls, with open seams facing the sky, and trying to seal them with new plastic products. They were working with inadequate budgets, and third rate materials, and making skylights out of vinyl. (It is important to understand that though domes can be made with a small amount of material compared to other methods, the materials must be of high quality). The only geodesic domes that had a chance were the offbeat metal and concrete domes that the writer/builders themselves condemned for their lack of aesthetic appeal. Aesthetics played a primary role

## Sphere Cottage

in these domes. The builders were obviously artists; the book was a tour de force of creative domebuilding, covering a surprising amount of ground. Many domebuilders of today were inspired by this book.

The design they were promoting, with dimension lumber frames and sheathed with cut out, nailed on plywood triangles, is still the most popular residential geodesic dome type, made with the figures printed in that old *Popular Science* article for the pool covers. The domes built today for homes are mostly refined versions of the leaky hemispherical walls of the early days, utterly dependent on composite shingles to shed water.

In the back of *Domebook 2* was a list of [Fuller's geodesic patents](#). A few years later I sent for several of them, and was thrilled by the brilliance of the methods described. The ideas laid down in the patents were being ignored. The "Self-Strutted Geodesic Plydome" grabbed me. I had worked with plywood in the building trades, and had felt the strength potential in thin, bent plywood, although I had not thought of how to exploit it very well. The pictures of plydomes in *The Dymaxion World of Buckminster Fuller* showed domes made of full sheets of quarter inch plywood bolted together in an overlapping "shingle" pattern that got me going on a research project that started in 1981, and continued until recently, when I and my family moved into one. The overlapping plywood sheets make domes that shed water as soon as the dome is assembled. The basic building is inherently watershedding, and no shingles are needed. The tensional continuity is nearly perfect, unlike the primitive nailing on of plywood triangles. The shell is so strong that often no frame is needed; I have found a hex-pent frame to be advisable on my larger diameter plydomes, fastened on the inside after assembly. A hex-pent frame has 1/3 as many struts as a triangulated frame, and is used to increase rigidity. It is also handy for stapling on bubblepack insulation.

I found out that working from a patent can be a risky business—the plydome patent was a minefield for me. The domes I built were quite daring. I wanted to know just how strong a dome had to be to be useful, and wanted to accentuate the tensile qualities, which are beautifully described in *Synergetics 1*, in the context of balloons ([Section 760.00](#)). When my largest dome was in a state of partial collapse from a sudden heavy snow load, and I was jacking the undamaged section out, I thought of a simple mathematical formula to link geodesics to pneumatics. Fuller mentioned the usefulness of 'failure point research' in getting past the excessive overbuilding and compressive, crystalline

## Interesting Links

### [Zometools](#)

Geodesic modeling

### [Synergetics](#)

Vol. I & II (Hypertext)

---



Send E-mail to Steve



[View the Guestbook](#)

[Sign the Guestbook](#)

Broken link? Problems  
navigating this site?  
Contact the [Webmaster](#)

structuring that plagues geodesic construction. I ran with that idea, and deliberately made domes that could possibly collapse. Then I carefully added supplemental structuring to bring them to usefulness, when possible. Some of them never got that far.

Almost all of my load testing has been with snowfalls. The 42' dome weighed about 2 tons and after a 30" snowfall was carrying 10 tons of snow. That was before I installed a thin 2v frame within the 6v dome in the hopes it could bear a 5' load someday.

Insulating in our plydome home followed a similar failure point pattern, where I am using an experimental approach based on tight sealing and air chambers within the ideal aerodynamic shape, with thoughtful use of vents. While experimenting with domes the most frequent question posed to me was, "how will you insulate them?" I studied the patents for the Dymaxion Deployment Unit, the Dymaxion Dwelling Machine, and the Fly's Eye (Critical Path) to understand the Bucky Fuller approach. The method I came up with is most like the postwar Dwelling Machine design (1940's) which used tightly sealed chambers with a rubber curtain hanging inside the airspace. Metal connectors are minimal, and fastened in wood frames. The rubber curtains are updated to 5/16 aluminized bubblepack ([Reflectix](#)). Although the bottom part of the house is unfinished- the insulation shows, and so it lacks the important inside air chamber in the lower 3/8 of the sphere- but our house is using an exceptionally small amount of fuel in the winter in Vermont, just a few gallons a day. This is with an R value of less than 10. In the summer we have no trees to shade the house, and a full exposure all year. The metal ventilator works as a parasol to keep sun off the top of the dome, and a rope operated trap door in the top of the ceiling enables air movement in and out of the top of the dome. This has been perfectly satisfactory for 3 years.

So far our plydome is working well. I am not offering it as a kit or plans, since I am not an engineer and doubt any engineer would endorse my designs- meaning building codes will find them unacceptable. Also, the process is familiar to me after years of practice, but would be a difficult process for the beginner to attempt.

Steve Miller

---

Created: February 2, 2001

Last Revised: May 21, 2002

© Steve Miller, 2002

# GEODESICS UNLIMITED

[Contact Geodesics Unlimited](#)

[About Geodesics Unlimited](#)

[Domes Designed and Built](#)

[Dome Design Service](#)

[Domes For Sale and Rent](#)

[What Are Geodesic Domes](#)



*For Geodesic Domes  
of all shapes, sizes,  
uses and materials.*

*We'll design and  
manufacture  
whatever you require  
or find someone  
who can.*



## Kibbutz Lotan Center for Ecotourism and Creative Ecology

You are here > [Home](#) > Geodesic Domes at Lotan

### NAVIGATE THE SITE

[Home](#)

[Eco Center](#)

[Eco Workshops](#)

[Natural Health](#)

[Attractions](#)

[Holistic Breaks](#)

[Guesthouse](#)

### INTERACT

[What's New](#)

[Eco Updates](#)

[Search the Site](#)

[Link to Us](#)

[Where is Lotan?](#)

[Contact Us](#)

[Join our Mail List](#)

[Today's Weather](#)

[Useful Eco Links](#)

# Geodesic Domes at Kibbutz Lotan

## Round About Re-inventions

Q. How many inventors does it take to build a geodesic dome?

A. 3. One to do the math, one to put the pieces together, and one to realize that it's all been done before...

In various places around Lotan guests encounter one of the strongest, simplest, easy-to-build structures you can find in nature... Yet, it took the mathematical wizardry and creative determination of 2 designers -- Walter Bauersfeld in Germany in 1922 and inventor-guru R. Buckminster "Bucky" Fuller in the United States in the 1950's -- to bring domes back into the world of modern construction.

Lotan domes are an experiment in sustainable architecture. Pieces of irrigation-pipe connect 250 date-palm branches (a local, renewable resource) in a pattern of 136 triangles; and a covering of interwoven creepers and vines protects visitors from the hot, desert sun.

When Bucky Fuller discovered that he could create a sphere by arranging triangles of various sizes in a special pattern, he believed he had found the answer to the problem of global housing. Dressed in suit and tie, Bucky attracted a following of hippy youth, science fanatics, math geniuses, and political planners with the promise of his GEODESIC DOMES.

Like all spheres, the geodesic sphere is efficient: it encloses more space per unit of surface area than any other 3 dimensional shape. Having less surface area means that spheres -- or parts of spheres, domes -- require fewer building materials and that they are less likely to be damaged by high winds, rain, or sand storms. Less surface area also means that there is less wall space through which heat can escape, so domes tend to stay warmer and waste less energy than rectangular buildings.

What sets geodesic spheres apart from other spheres is their super-strength. Because they are made up of triangles, geodesic spheres are among the strongest, most stable built structures that exist. And, unlike conventional buildings that grow shakier as they grow taller, domes get stronger and more stable as they get bigger!



## Useful Alternative Building links

- [To go back to the Alternative Building index page](#) ↗
- [To go to the Straw Bale Construction page](#) ↗
- [To view the 'Tires n' Trash' page](#) ↗
- [Read Lotan's latest eco update \(July 2002\)](#) ↗

---

## Contact info

**Daphna Abell**  
**Program Coordinator**

[lotan-programs@lotan.ardom.co.il](mailto:lotan-programs@lotan.ardom.co.il)

**Tel: +972 8 6356935**

**Fax: +972 8 6356937**

**Toll Free: 1800 2000 75**

[ [EcoKef](#) ]

[ [Eco Workshops](#) ]

[ [Natural Health](#) ]

[ [Attractions](#) ]

[ [Lodging & Leisure](#) ]

Copyright © 2002 [Kibbutz Lotan Center for Ecotourism and Creative Ecology]. All rights reserved.



## Links to geodesic and alternative building

[BFI Home Page](#)

[Earth Viewer](#)

[Amnesty International - About Amnesty](#)

[Greenpeace International Home Page](#)

[We the Peoples: 50 Communities Awards](#)

[Yahoo! - Society and Culture:Environment and Nature:Sustainable Development](#)

[EnviroLink Home Page](#)

[Earthship](#)

[Global Network of Environment & Technology \(GNET\) Home Page](#)

**[Ecological Architecture and Natural Building](#)**

**[Alternative Construction Material Businesses in the World](#)**

**[Environmental Organization WebDirectory - Sustainable Development](#)**

**[Whole Systems](#)**

**[Builders/Manufacturers of Geodesic Dome homes and structures](#)**

**[The Solar Energy Network - Doormat](#)**

**[Solstice: Sustainable Energy and Development Online!](#)**

**[Internet Straw Bale Resources](#)**

**[Welcome to Jade Mountain](#)**

## [Applied Synergetics Home Page](#)

### [EcoArch](#)



[Back to the english index of this site.](#)



[Back to the home page of this site.](#)



[geodome@sympatico.ca](mailto:geodome@sympatico.ca)

All drawings, photographs, texts and technologies shown on this site are the exclusive property of Guy Massicotte.

Tous les dessins, photographies, textes, et technologies présentés sur ce site sont la propriété exclusive de Guy Massicotte.

© Guy Massicotte, jan. 1997



# Multiplication: An Adventure in Number Sense

**New!** Natural Math® workshops in the Research Triangle Area, NC

[March 7th "Multiplication adventure" report](#) See pictures of fun activities, follow links to computer games and more!

---

## Contents:

### [Why Would I Want to Play with This Stuff?](#)



[Introduction: Too Many Facts? The Facts You Do NOT Need to Memorize](#)



[Multiplication Applet \(Java\)](#)



[Coloring the Monster Table](#)



[Times Eleven and Arithmetic Progression](#)



[Twin Facts and Commutative Law](#)



[Times One for Free](#)



[Times Ten for Free](#)



[Times Nine Patterns](#)



[Times Nine "Tricks"](#)



[Times Five Pattern](#)



[Times Two](#)



[Off Diagonal](#)



[Summary of Patterns: No Need to Memorize...](#)



[More Patterns to Discover!](#)

## Printables and Reference:



[Printable Grid](#)



[Facts You Do NOT Need to Memorize: The Hyperlinked Table](#)



[Printable Base 10 Multiplication Table \(for coloring\)](#)



[Printable Base 10 Multiplication Table \(wallet size\)](#)



[Base 16 Multiplication Table](#)



---

The picture we use as a bullet is an ancient Egyptian symbol for number 1,000,000 (one million)

---

## Why Would I Want to Read This Stuff?

The main reason why people read these materials is for fun. However, there are many "applied" uses for these pages:

- learn why you need to memorize only 13 multiplication facts (or less) in order to know the whole table
- learn a lot of useful tricks and patterns that will help in **fast mental arithmetic** and will develop your **number sense**
- follow suggested investigations to discover a lot of **algebraic patterns** (it is worth at least as much as taking the standard pre-algebra and algebra 1 courses)
- find getaways to advanced topics such as **matrices** or **arithmetic progression**

Each page in the unit consists of dialogs between a Student and a Mentor, as well as illustrations, summaries and suggestions for further explorations and activities. Users can skip dialogs if they wish, going directly for the summaries and activities.

---

## Dialog Example

**Student:** There are too many multiplication facts to memorize.

**Mentor:** If you want to know the multiplication table from 1 to 10, you may want to memorize 13 facts, at most. There are very easy tricks that will let you get the rest of the facts as fast as if you remembered them.

**Student:** I think it is better when you are able to figure something out, rather than remembering it. It takes too much time to memorize things, and then I forget them so easily!

**Mentor:** Also, you learn a lot of useful stuff while you figure facts out.

---

## Summary Example



*To multiply a number by nine, multiply it by ten and subtract the number.*

$$8*9 = 80 - 8 = 72$$

---

## Suggestion Example



*Find a multiplication fact you like. Try to find as many ways to express this fact as you can. Use graph paper, marbles, numbers, or anything else. How many ways have you found? Share them with somebody.*

---

The more types of manipulatives students use, the more knowledge and enjoyment they can get from the unit. At the very least, students should have some kind of "counters" of several colors (e.g., marbles, poker chips, several kinds of beans), graph paper, and several pencils, markers or

crayons. [A page of graph paper can be printed out from here.](#)

Pattern considered on these pages are only example. If people have a chance, they discover and develop their own unique patterns and personal relationships with numbers, facts and concepts. The more individual patterns each person can find, the better the person will feel about numbers and math ideas. Therefore, it may be more important for students to find their own patterns than to learn someone else's tricks and ideas.

Enjoy!



---

© Copyright 1998 by Maria Droujkova and Dmitri Droujkov. All rights reserved. No part of these materials should ever be used in any situation that involves compulsory teaching. See also [copyright notes](#) and [student rights](#).



# George W. Hart

e-mail: [george@georgehart.com](mailto:george@georgehart.com)

<http://www.georgehart.com/>

85 Oak Street  
Northport, NY  
11768 USA

(631) 754-2722

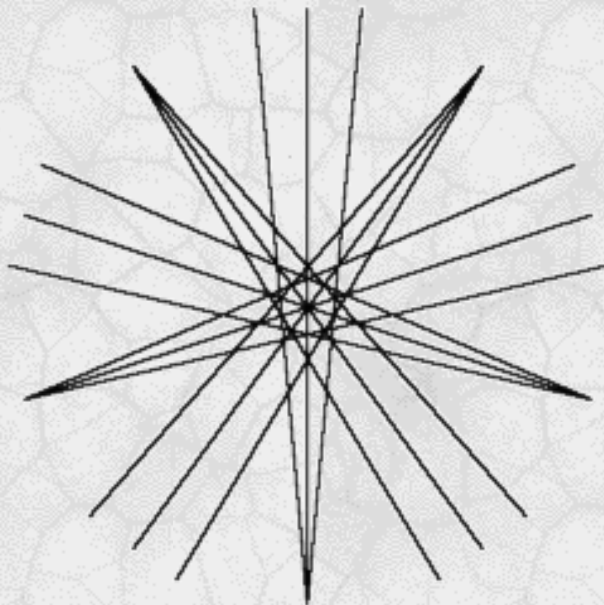

This is a top-level table of contents into my several hundred web pages:

- [Geometric sculpture](#) (I am a sculptor. Take a look and enjoy my work.)
  - [Color postcards available](#)
  - [Limited edition acrylic sculptures](#)
  - [My latest "sculpture barn raising"](#) (while I was artist-in-residence at MIT)
  - [A 60-piece reconstructable sculpture](#)
- [My Rapid Prototyping Page](#) (collects RP models from several projects of mine.)
- [Trip to Taiwan](#) (July 2004)
- [The Zome Geometry book](#) (Also an author, my latest book is now available.)
  - [Advanced Zome construction projects](#)
  - [Additional photos supplementing the book](#)
  - [Corrections to the first printing](#)
  - [Zome Workshop information](#)
- [Encyclopedia of Polyhedra](#) (An enormous continually expanding online reference, including...)
  - [Polyhedra and Art through History](#) (This is the topic of the book I am currently writing.)
  - [Classroom Project Ideas](#) (Teachers ask me for these.)
  - [Annotated Bibliography](#) (Lists just about everything ever written about polyhedra.)
- [Pavilion of Polyhedreality --- fun images and links to related web sites](#)
- About me:
  - [Brief biography](#)
  - [My printed publications](#)
  - [Citations, press clippings about me, etc.](#)
  - [My SUNY Stony Brook web pages](#) (I am currently a computer science professor there)

- Food-related topics:
  - [My trilobite recipe \(really!\)](#) (A popular baking activity.)
  - [The Incompatible Food Triad](#) (An open problem in theoretical epicureanism.)
- [Multidimensional Analysis](#) (My first book is about linear algebra and dimensional analysis.)

Check out this nice article about me by Ivars Peterson:  
["Polyhedron Man," Science News, 22 Dec. 2001, p. 396.](#)



Above is a typical view of my office, although what hangs there is always changing.

Here are some places where my sculpture is currently on public display, in case you want to go see something in person

- [Northport Public Library](#), Northport, NY
- [Long Island Museum of Science and Technology](#)
- [University of California at Berkeley](#), CS Dept., Soda Hall, Berkeley CA
- [Goudreau Museum](#), New Hyde Park, NY
- [Princeton University](#), Mathematics Dept., Fine Hall, Princeton, NJ

Note: my gallery in New York, (The Vorpal Gallery) just closed. I have not yet looked for another gallery. So if you are interested in seeing my work, contact me directly.

---



From October 1-29, 2003, I had a small exhibit on view at the [Northport Library](#), directly underneath my [Bookball](#).

---

Here is a list of some recent and upcoming events where you can meet me and/or see my sculpture. Check out the photos of events which have posted pictures:

#### 2003:

- [Southwest Research Institute](#), San Antonio, TX, July 15
- [Bridges/ISAMA 2003](#), Granada, Spain, July 23-25 ([report/photos](#))
- [MathFest 2003](#), Boulder, Colorado, August 1
- [MathCamp 2003](#), University of Puget Sound, Tacoma, WA
- [Artist in residence](#), MIT, Cambridge, MA, Oct 29 - Nov. 4. ([photos](#))

#### 2004

- [Joint Mathematics Conference](#), art exhibit, Phoenix, AZ, January 7-10
- [University of Houston](#), Houston, TX, February 25
- [G4G6](#), Atlanta, GA, March 2004
- [Moravian College](#), Bethlehem, PA, April 15-16

- [ISAMA 2004](#), DePaul University, Chicago, IL, June 15-19
  - [Bridges 2004](#), Southwestern College, Winfield, KS, July 30-August 1
  - [MathCamp 2004](#), Colby College, Waterville, Maine
  - [University of Miami in Ohio](#), Oxford, OH, Oct 1-2
- 



This is me and [the snub truncated icosahedron](#) giving a talk recently at Stony Brook University.  
(photo by [Eric Demaine](#))

---

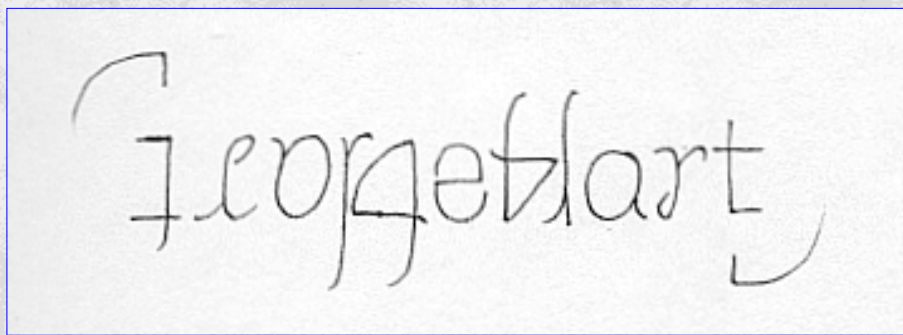

(click image for explanation)

---

Copyright 1998, 1999, 2000, 2001, 2002, 2003, George W. Hart

---



[\(advanced search\)](#)

Welcome to Earthship Biotechure - **10,561 members** and counting!

Monday, September 06 2004 @ 12:55 AM GMT

[contribute](#) | [Become a Member](#) | [My Account](#) | [Lost Passwords](#) | [Visit Us!](#) | [EARTHSHIP STORE](#) | [Image Gallery](#) | [Forum](#)

#### Contact Us!

Earthship Biotechure  
PO Box 1041  
Taos, NM, USA 87571  
[biotechure@earthship.org](mailto:biotechure@earthship.org)  
505.751.0462 (*tel.*)  
505.751.1005 (*fax*)

#### Topics

Home  
[BUILDINGS](#) (6/0)  
[EDUCATION](#) (14/0)  
[SYSTEMS](#) (9/0)  
[BioDiesel](#) (26/0)  
[TESTIMONIALS](#) (15/0)  
[KNOWLEDGEBASE](#)  
(0/0)  
[\\*Forum Archives](#)  
(408/0)

#### Resources

#### Solar Survival - Home of the Earthship

### [BUILDINGS](#) -| [EDUCATION](#) -| [SYSTEMS](#)

\* [INTERNATIONAL EARTHSHIP SUMMIT](#) \*  
**BRIGHTON, ENGLAND - OCTOBER 29 - 31, 2004**



*The Future of Housing: complete independence. complete comfort. complete civilization.*

#### EARTHSHIP STORE



[A Coming of Wizards](#)  
[\\$14.95](#)

#### Begin Here

- \* [At a Glance by the AP](#)
- \* [How to Proceed](#)
- \* [Intro Earthship Options](#)
- \* [Earthships for Sale](#)
- \* [Resume](#)
- \* [Visit Us!](#)

#### Google Ads

Books:

- \* [Comfort in Any Climate](#)
- \* [Volume I](#)
- \* [Volume II](#)
- \* [Volume III](#)
- \* [A Coming of Wizards](#)

[Testimonials](#)

[WebLinks](#)

[Surveys](#)

[Calendar of Events](#)

What's New

**STORIES**

No new stories

**COMMENTS** last 48 hrs

No new comments

**LINKS** last 2 wks

No recent new links

Events

**Site Events**

**Friday** 17-Sep -

**Sunday** 19-Sep

- [September Earthship Seminar](#)

**Friday** 29-Oct -

**Sunday** 31-Oct

- [International Earthship Summit 2004](#)

**Photo CD**  
\$10



over 140 images  
Earthship Designs  
Quicktime Movie

**Earthship Books**  
\$29.95 each



- \*How to Build Your Own
- \*Systems & Components
- \*Evolution Beyond Economics

**Intro Set**  
\$45



- \*Volume I: How to Build Your Own
- \*Comfort in Any Climate
- \*Worksheet
- \*Photo CD

**Nightly Rentals**

\$150 / night  
Experience the latest in sustainable, indendent living.



**Workshops**

three days hands on.



**Complete Library**  
\$130

- \*Earthship Volumes
- \*Comfort in Any Climate
- \*A Coming of Wizards
- \*101 Video
- \*Packaged Plan Book
- \*Worksheet
- \*Photo CD

Forumposts

Order By:[New Views Posts](#)

Latest 5 Forum Posts

▶ [Phoenix Earthship](#)

By: Admin

On: 08/31/04 19:18 PM

Views 109 Replies 1

▶ [your email address..](#)

By: [emmanuel2012](#)

On: 08/31/04 13:08 PM

Views 64 Replies 0

▶ [announcement for d..](#)

By: [emmanuel2012](#)

On: 08/31/04 01:20 AM

Views 72 Replies 0

▶ [Canadian Earthship..](#)

By: Jimmy

On: 08/30/04 23:10 PM

Views 627 Replies 5

▶ [SCOTLAND is excite..](#)

By: Henry

On: 08/25/04 20:19 PM

Views 238 Replies 2

Vote

Who's Online

Guest Users: 7

User Functions

Username:

Password:

Don't have an account yet? Sign up as a [New User](#)

Buy an Earthship!

financing, insurance & furnished.



Construction Drawings

Designed to meet & exceed standard building codes.

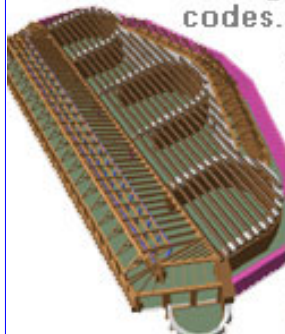

Builders Special

- \*Comfort in Any Climate book
- \*Earthship 101 video
- \*Intro CDROM
- \*Detail Book



Would you financially support an Earthship BioFuels facility?

- yes! monthly
- yes! a little sometimes
- maybe
- no!
- yes, but not money

[Results](#)

110 votes | [1 comments](#)

Renewable Energy Roundup



Saturday, September 04 2004 @ 02:47 AM GMT

Contributed by: [mmyers1](#)

<http://www.theroundup.org/>



September 24 - 26, 2004  
Fredericksburg, Texas

See Y'all There!!

[Post a comment](#) [ Views: 2 ]

Vote

What Earthship product would you like to see?

- More Books
- More Videos
- DVDs
- Gift certificates
- More Image
- Downloads
- T-shirts



To Governor Bill Richardson



Monday, August 30 2004 @ 02:10 PM GMT

Contributed by: [Admin](#)

In Support of Sustainable Lifestyle,  
from KTAO Solar Radio



[read more](#) (279 words)

[Post a comment](#) [ Views: 57 ]

Bitterroot Tour of Green Homes to emphasize energy efficiency



Friday, August 13 2004 @ 04:09 PM GMT

Contributed by: [Admin](#)

By MICHAEL REDSTONE for the Missoulian



The Bitterroot Tour of Green Homes will visit five energy-efficient homes demonstrating alternative building technologies from 1 to 5 p.m. Saturday.

The homes visited on the tour will include stress panel construction with a grid tie-in solar system; two earthship designs with solar power and gray-water recycling systems; and a straw bale home.

[read more](#) (151 words)

[Post a comment](#) [ Views: 157 ]

Sweatshirts

Tools

[Results](#)

191 votes | [0 comments](#)

Vote

## My Earthship

I have an earthship book/video

My friend has an earthship book

I am building my earthship

I will buy my earthship

I live in my earthship

[Results](#)

290 votes

### Fire Safety & BioDiesel Regulations



Monday, August 09 2004 @ 02:52 PM GMT

Contributed by: [Admin](#)

I just had a talk with a public information officer from a fire department in Washington who has been assigned to write a press release on biodiesel homebrewers and on any safety issues that we present to fire fighting personnel.



[read more](#) (643 words)

[Post a comment](#) [ **Views: 192** ]

### BioDiesel Production: Common Sense



Monday, August 09 2004 @ 02:50 PM GMT

Contributed by: [Admin](#)

If one would only study the MSDS which, by law, must come with every hazardous item sold, accidents would be greatly reduced and common sense would be the order of the day, and night.



[read more](#) (211 words)

[Post a comment](#) [ **Views: 130** ]

### International Earthship Summit 2004



Sunday, August 08 2004 @ 09:48 PM GMT

Contributed by: [Admin](#)

Brighton, England

October 29th-31st



Want to learn more about sustainable housing?

Water harvesting?

Independent, renewable power systems?

Recycled and natural building materials?

[read more](#) (267 words)

[Post a comment](#) [ Views: 943 ]

### U.S. EPA: Scrap Tire Management



Monday, July 26 2004 @ 06:23 PM GMT

Contributed by: [Admin](#)

There are at least 300 million scrap tires in stockpiles in the U.S. In addition, approximately 281 million scrap tires were generated in 2001.



[read more](#) (211 words)

[Post a comment](#) [ Views: 220 ]

### Record number of U.S. tires being recycled



Monday, July 26 2004 @ 06:20 PM GMT

Contributed by: [Admin](#)

WASHINGTON (Reuters) -- A record 80 percent of old tires were recycled for other uses including fuel and playground equipment in 2003, according to a U.S. industry report released Wednesday.



[read more](#) (270 words)

[Post a comment](#) [ **Views: 184** ]

### 2nd Annual Lakota Hemp Days



Monday, July 26 2004 @ 06:16 PM GMT

Contributed by: [Admin](#)

You're Invited: Alex White Plume, his family, Hemphasis Magazine, the South Dakota Industrial Hemp Council, and those involved with the Lakota Hemp Project invite you to attend the 2nd Annual Lakota Hemp Days on the Pine Ridge Reservation this August 25th through 29th.



[read more](#) (1606 words)

[Post a comment](#) [ **Views: 194** ]

### Soy diesel seeks market



Friday, July 09 2004 @ 04:54 AM GMT

Contributed by: [Admin](#)

Expensive, clean-burning, it could benefit state's farmers

By SHEILA B. LALWANI

slalwani@journalssentinel.com

aledonia - Living on 230 acres of lush green land, A. Royse Myers, a wealthy and retired businessman, could do a lot of things with his time.



[read more](#) (938 words)

[Post a comment](#) [ **Views: 161** ]

Previous [1](#) [2](#) [3](#) [4](#) [5](#) [6](#) [7](#) [8](#) [9](#) [10](#) [Next](#)

Created this page in 0.85 seconds

Copyright © 2004 Earthship Biotecture  
All trademarks and copyrights on this page are owned by their respective owners.



*Craig Henritzy- architect*  
*510 . 526 . 8602 8 Indian Rock Path BerkeleyCA*



*Architecture*



*Solar House*



*Projects in the Works*



*Commercial*



*Craftsman Style Houses  
... early projects*



*Family*



*Sunhawk*



*Santa Cruz Mountain House*

*Ancient design for the future*

 *concept design methodology*



[Site Map](#) | [Search](#) | [Home](#)



- [What's New](#)
- [Inside EEBA](#)
- [Membership](#)
- [EEBA Alliances](#)
- [Building Technology](#)
- [EEBA Resources](#)
- [Communications](#)
- [Events Calendar](#)
- [EEBA Institute](#)
- [Online Bookstore](#)
- [Job Center](#)
- [Related Sites](#)

# Welcome to the Energy & Environmental Building Association (EEBA)



EEBA promotes the awareness, education and development of energy efficient, environmentally responsible buildings and communities. The strength of the organization lies in the diversity and talent of its membership, which includes: architects, builders, developers, manufacturers, engineers, utilities, code officials, researchers, educators, and environmentalists.



## [Building America: Houses that Work Seminars](#)

- October 2, 2004 - Grand Junction, CO

## Breaking News

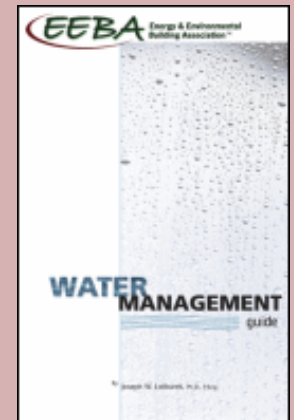

### [EEBA's Revised Water Management Guide is now available.](#)

Order yours today!

### [Call For Nominations](#)

2004 EEBA Excellence in Building Awards

### [Building Science Discussion Email List](#)

Sign-up today to ask your questions and get feedback from others in the building science arena.

### [EEBA Institute Online Courses Now Available](#)

March 30, 2004

### [EEBA 2004 Building](#)



Click on image for more information

- December 3, 2004 - Stockton, CA
- February 1, 2005 - Grand Rapids, MI
- February 2, 2005 - Detroit, MI
- February 17, 2005 - Traverse City, MI

**Solutions Conference to be held in conjunction with the Sunbelt Builders Show**

**Register for the EEBA Institute MasterBuilder or Professional Certification Program**

PDF Registration Form

**Reward someone today with a Gift Certificate from EEBA's Online Bookstore!**

Call 952.881.1098.

---

[What's New](#) | [Inside EEBA](#) | [Member Directory](#) | [EEBA Alliances](#) | [Building Technology Communications](#) | [Events Calendar](#) | [EEBA Institute](#) | [Online Bookstore](#) | [Job Center](#) | [Members Corner](#) | [Other Sites](#) | [Site Map](#) | [Search](#) | [Home](#)

---

**© 2003 Energy and Environmental Building Association**

10740 Lyndale Avenue South, Suite 10W, Bloomington, MN 55420-5615

952.881.1098 fax: 952.881.3048 [information@eeba.org](mailto:information@eeba.org)

Send comments or suggestions on the web site to: [webmaster@eeba.org](mailto:webmaster@eeba.org)



[greendesign.net is for sale!](#)

[Get Info](#)

[Sewing Machine/](#)

[Trade Show/](#)

[Stores Online/](#)

[Fashion Schools/](#)

[Milan](#)

Search results for **design**.

### [The Adobe® Creative Suite](#)

Web site development software suite includes Adobe Photoshop, Illustrator, Golive, Indesign 2.0 and Acrobat. Watch a video tour or download a demo. Click here to play.

[www.adobe.com](http://www.adobe.com)

### [Design Training Programs](#)

Find the design school that's right for you. Request a free InfoPak and start earning your degree today.

[design-schools.org](http://design-schools.org)

### [Autodesk Design](#)

Autodesk software can help your design team get better-quality products to market faster. Create, manage and share your designs.

[usa.Autodesk.com](http://usa.Autodesk.com)

### [The Creative Circus Design School](#)

Our nationally accredited school offers advertising students training in copywriting, art direction, design, and photography.

[www.creativecircus.net](http://www.creativecircus.net)

### [Become a Designer with Creative Academy](#)

Discover now our master in creative management and master of arts for design. Work effectively for a luxury brand with super-talented designers. Download application and enroll.



[SEEQMAIL LOGIN](#)

[FREE WEBMAIL](#)

No annoying pop-ups!  
[SIGN UP NOW!](#)

[New York, NY](#) 67F ☁

[Chicago, IL](#) 82F ☀

[Los Angeles](#) 97F ☀

**Your Weather**

[BuyDomains.com](#)  
Over 400,000 Domains For Sale...

[LinkDesign.com](#)  
[LadiesFashion.com](#)  
[MensClothes.com](#)  
[KidsFashion.com](#)

## RELATED LINKS

[WEB HOSTING](#)

[WEB DESIGN](#)

[ECOMMERCE](#)

[WEB SITE DEVELOPMENT](#)

[WEB DESIGN COMPANY](#)

[WEB DESIGNER](#)

[WEB HOSTING PLAN](#)

[PERSONAL WEB HOSTING](#)

## HEADLINE NEWS

[Brits and Pieces;](#)

[London-Inspired, Casual Mix](#)

[Make Hot Men's Looks for Fall](#)

[FASHION POLICE; Dressin' La](#)

[Vida Loca; Latin Grammys Latest in Awards-...](#)

[A Complicated Craft](#)

[La Fashionaria: Big is Better in Fashion World at Last](#)

[Grainne So Good](#)

[More Top News](#) >>

[www.performix.it](http://www.performix.it)

[CasualClothes.com](http://CasualClothes.com)

[AthleticShirts.com](http://AthleticShirts.com)

[More Results](#) >>

[more](#) ::

[Home](#) • [About SEEQ](#)

© 2004 Seeq.com

# WoodWise

Co-op America's WoodWise Program

*Working to preserve forests by reducing the demand for wood products and promoting sustainable alternatives.*

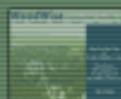

## WoodWise Consumer Guide

Use our practical tips and resources to help preserve forests in your everyday life



## The Magazine PAPER Project

Encourage magazine publishers to make environmental commitments



## Forest Issues

Learn more about the movement to preserve the world's forests – and how you can be involved

**Take Action:** Ask Condé Nast to print its magazines on recycled paper

**Students:** Click here for Campus PAPER Project information

[About Us](#) | [Join Co-op America](#) | [Contact Us](#)

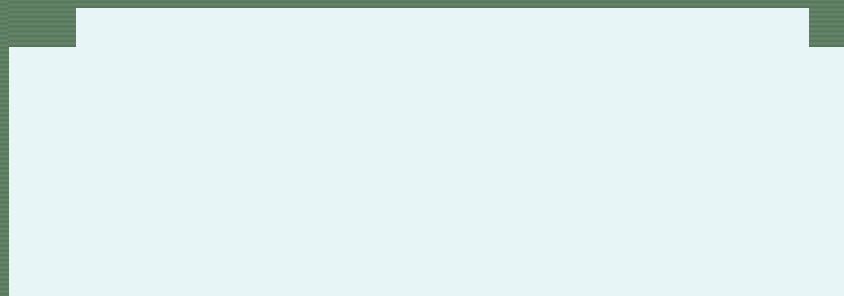

Site maintained by [Co-op America](#). All content Copyright © Co-op American 2002  
Site designed by [Viscraft.com](#)

## Sierra Solar



Thank you for ordering  
FirstWorld shared web hosting service.



Invitational Home Page and Outpost,- Placards, Portals and Projects. My Internet point-of-contact. File your contact info with me. Applescript Database. Linksgate Portal System- Contribute URLS, Pool shared links. Anon Salon, Burning Man,

# bradleygreen.com

|                                                                                                |                                       |
|------------------------------------------------------------------------------------------------|---------------------------------------|
| Your Name ( <i>real or fictitious, please</i> )                                                | Your E-Mail Address ( <i>please</i> ) |
|                                                                                                |                                       |
| Monitor Size-<br>Palm Top      Kiosk<br>Small            14"<br>15"               17"<br>Large | Write a note: ( <i>optional</i> )     |



- WHAT'S NEW
- ON SALE
- MUST GO

# AMERICAN SCIENCE & SURPLUS

INCREDIBLE STUFF, UNBELIEVABLE PRICES! Est. About 1947

▼ SHOP BY CATEGORY

- ▶ Adult and Kid Toys
- ▶ Arts and Crafts
- ▶ Batteries and Power
- ▶ Communications and Electronics
- ▶ Containers
- ▶ Drives and Wheels
- ▶ Electrical Parts
- ▶ Hardware
- ▶ House and Garden
- ▶ Kits and Models
- ▶ Lab Supplies and Equipment
- ▶ Lamps, Sockets and Wiring
- ▶ Materials and Magnets
- ▶ Militaria
- ▶ Motors, Blowers and Pumps
- ▶ Office Supplies
- ▶ Optics
- ▶ Out and About
- ▶ School Items
- ▶ Switches
- ▶ Tools
- ▶ Robot Parts

USE YOUR CATALOG TO EXPRESS SHOP



ENTER WORDS OR ITEM #

SHOP BY SPECIALS

**Welcome to our ever-changing pile of incredible stuff at unbelievable prices!**

Items Just off the Truck    New Items Added Every Week

**BIG Pencil Box**

It looks like a super-sized pencil box, and it's long enough to easily hold a 12" ruler and a slew of desk supplies, but the 13-1/4" x 5" x 2-1/2" plastic Spacemaker box is multi-talented. The textured, transparent red lid snaps shut over a translucent white bottom, and hides clutter in a car trunk, workshop, craft or sewing room, or even a kitchen drawer. Stackable!



click for photo

31856 SPACEMAKER BOX \$1.95 / **Buy Me**  
EACH



Jarvis' Idea Corner

- [Help for the Stymied Surpie](#)
- [I'm a proud A.S.&S. user!](#)
- [Jarvis says you need a...](#)
- [Items Flying Out the Door](#)
- [The Dusties](#)
- [Our Top Shelf](#)
- [Got some extra change?](#)
- [Who is Jarvis?](#)

Back To Basics 🧠

It could have been called an Alabama Buzzer after Alabama Vest, the man who invented it. Or a Clegghorn, after Thaddeus Von Clegg, the clock master who fabricated the first one. But the hand-crafted 4-3/4" long steel instrument was a simple amusement, and the 1840s were a simple time. So it's simply a kazoo.



92395 KAZOO \$2.50 / EACH [Buy Me](#)



Fine Writing 🧠

Our each is a pack of (3) Z-Line" mechanical pencils in assorted barrel colors -- probably one each in red, green and blue. A cap with a pocket clip hides an eraser. They come, and can be refilled, with 0.5 mm lead. And they're cheap enough that you need several for home, and several more for the office.



35272 0.5MM PENCILS \$0.95 / EACH [Buy Me](#)

Cast Carvings! 🧠

You've found a way to save money, you crafty little artist! Now you can enhance your projects with these incredibly priced, three-dimensional, flat-backed Fairies of the Garden from Accent Design's" Home Collection. The delicate polyresin "carvings" just need your finishing touches -- that would be glue, and paint, and imagination. So far, we've seen Hyacinth, Poppy, Daffodil, Rose and Daisy in both 2-1/4" and 3", but there may be others. Package of (6), with at least (2) different.



35330 RESIN FAIRIES \$2.95 / PKG(6) [Buy Me](#)

[FAQ](#) : [Shipping Info](#) : [Contact Us](#) : [Printed Catalog](#) : [Retail Stores](#)  
[Our Manifesto](#) : [Links](#) : [Link to Us](#) : [Privacy Statement](#) :  
[labwarehouse.com](http://labwarehouse.com)

© American Science & Surplus

1-847-647-0011

A  [Gorilla Polymedia](#) Production

## Can't find your favorite Science website?



Edmund Scientifics (the inventor of the famous [Astroscan telescope](#)) is a leading supplier of science products including Celestron telescopes and binoculars, Night Owl night vision goggles, spotting scopes, rangefinders, microscopes, digital microscopes, prepared microscope slides, magnifiers, weather instruments, magnets, scales, robotics, air toys, radiometers, laser pointers, dissecting kits, labware, solar cells, celestial guides, globes, fossils, rock tumblers, metal detectors, unique lighting devices, chemistry sets, science fair components, and hundreds of odd and unusual science toys.

Please visit our website at <http://www.scientificsonline.com>. Please bookmark our new web address for future reference.



Edmund Industrial Optics is known worldwide for optical expertise in the manufacturing and integration of optical components. Our product line includes lenses, prisms and filters, which are ideal for industry, research and prototyping. We have extensive selections of imaging lenses, cameras, illumination, and lasers. Our commitment to OEM is backed by testing equipment, manufacturing facilities, special discounts and just-in-time shipping.

Our website can now be found at <http://www.edmundoptics.com>. Please bookmark our new web address for future reference.



Science Kit & Boreal Laboratories is a leading provider of science education products to K-12 teachers, home-schoolers, and science hobbyists throughout the United States. Our science education product lines cover a wide range of disciplines including [Biology](#), [Chemistry](#), [Earth Science](#), [Elementary](#), [Forensics](#), [Physics](#) and [Scientific Inquiry](#). We carry a diverse selection of [Scholar Chemicals](#) and [General Laboratory Supplies](#). We also offer our own [Boreal Microscope](#) and [Teacher Developed, Classroom Tested](#) product lines.

Please visit our website at <http://www.sciencekit.com>. Please bookmark our new web address for future reference.



Anchor Optical Surplus offers only experimental grade lenses. These lenses are seconds and overstocks and because of their low price and limited quantities they are not supported with any technical data. Only limited supplies are available.

Our website can now be found at <http://www.anchoroptical.com>. Please bookmark our new web address for future reference.

# GEODESIC DOMES

## HISTORY



50 foot dome by [Cascade Domes and Shelters](#)

The first contemporary geodesic dome on record is [Walter Bauersfeld's](#), who realized the utility of projecting the constellations on the inner surface of an icosasphere, [Omnimax-style](#), thereby creating a breakthrough planetarium in Jena, Germany, in 1922.

Fuller derived [his geodesic dome](#) from general principles independently of Bauresfeld, just as he derived the [octet truss](#) without knowing of [Alexander Graham Bell's](#) implementation of this same naturally occurring phenomenon.

Fuller's geodesic spheres and domes emerged synergetically from his philosophical "[explorations in the geometry of thinking](#)". In this self-discipline, the variably frequenced icosasphere links up with the jitterbug and [sphere packing](#) concepts (see [dome geometry](#)).

The spherical high frequency icosahedron also suggests a grid of triangles which may be used to transfer global data from a sphere to an unfoldable icosahedron (another concept that would have excited Bauersfeld). The geodesic dome and the [Fuller Projection](#) both derive from the same general principles.

### *For further reading*

- For more on Fuller's domes, see J. Baldwin's excellent [page on domes](#) at the WNET [Bucky web site](#). And read his book, *Bucky Works*.
- [Kiyoshi Kuromiya re EPCOT](#)
- [James Fischer re EPCOT](#)
- [Picture of the South Pole dome](#) (slated for replacement by the NSF)

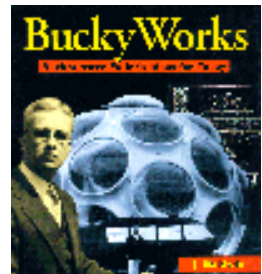

## FUTURE?

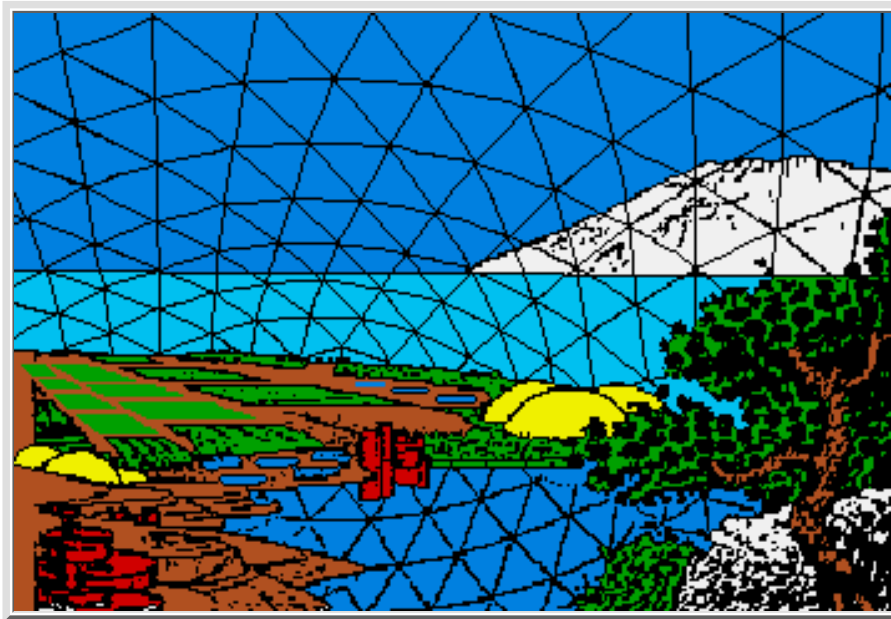

[jm]

Fuller anticipated that domes, along other alternative dwelling designs, would likely become artifacts within a new World Livingry Service Industry. Economies of scale would give people affordable housing options, along with ways to seamlessly connect with multimedia-based work-study telecommunication systems. The new dwelling machines would deploy alongside more traditional neighborhood structures and different cultures would customize them to integrate with local designs and routines.

Some models would feature a very high degree of energy autonomy, and their deployment in remote areas would be without lasting disruption of the ecosystem -- a supporting tripod would make it unnecessary to pour concrete, and helicopter delivery and pickup would keep construction crews and equipment from despoiling the landscape.

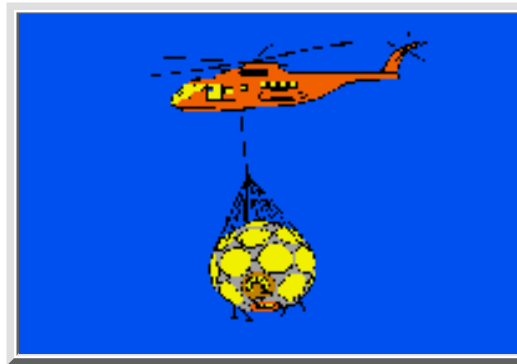

[jm]

*For further reading*

- [Pillow Dome and other Dwelling Machine Prototypes](#)
- [Brainstorming on BuckyWorks](#)
- The [Project Renaissance model](#) for prototyping in the public sector
- [Synergetics, Inc.: a case study in the history of geodesic dome design](#)
- Air deliverable clinics and disease management units (DMUs) -- under development

---

[Domes](#) | [History](#) | [Geometry](#) | [Providers](#) | [Prototypes](#)

Synergetics on the Web  
maintained by [Kirby Uner](#)



# GEODESIC DOMES

## THE GEOMETRY

---

### DOMES ARE PARTS OF SPHERES



Geodesic domes are fractional parts of complete geodesic spheres. Actual structures range from less than 5% to 100% (a full sphere). The [Spaceship Earth](#) Pavilion constructed by Tishman Construction for AT&T at Disney's Epcot is the best-known example of a full sphere.

---

### DOMES HAVE VARIOUS FREQUENCIES

Geodesic spheres and domes come in various *frequencies*. The frequency of a dome relates to the number of smaller triangles into which it is subdivided. A high frequency dome has more triangular components and is more smoothly curved and sphere-like. If your web browser is Java-enabled, you can interact with the exhibit on Frequency at right.

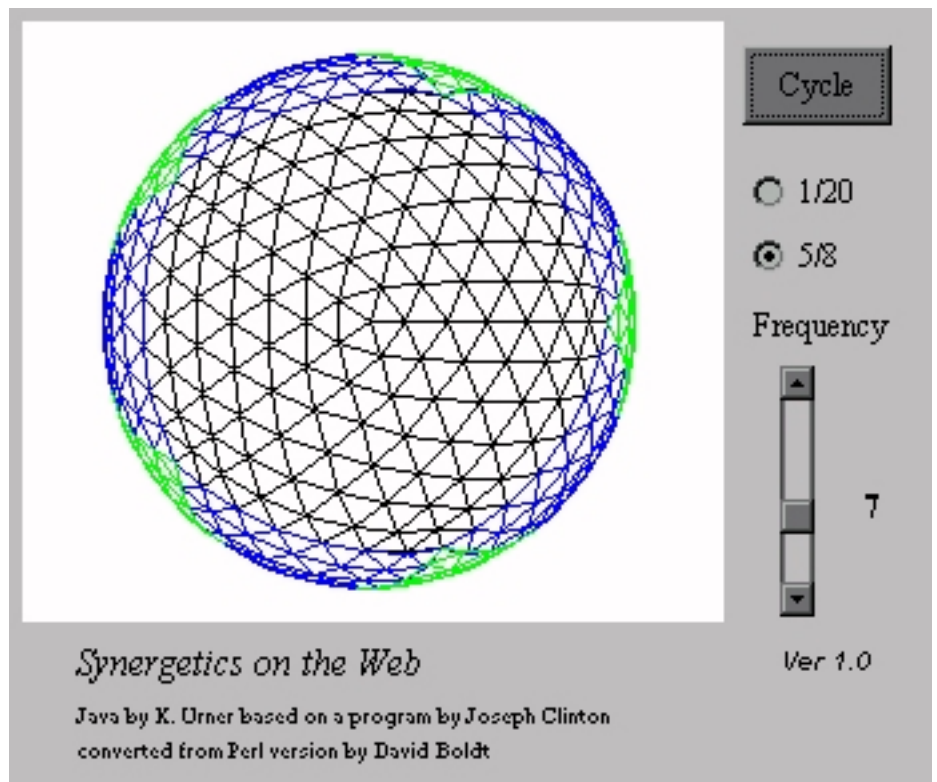

## DOMES RELATE TO SPHERE PACKING

Fuller realized that spheres packed around a nuclear sphere in successive layers give a [cuboctahedral](#) shape, which may be distorted into an icosahedron or octahedron via what he called the [jitterbug transformation](#).

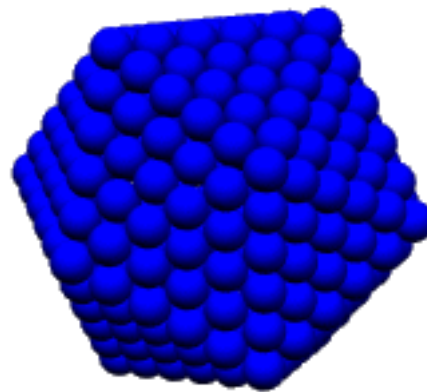

*5-frequency*



animated GIF by [Richard Hawkins](#)

The network of rods between adjacent spheres in a hollow icosahedral packing

gives the framework for the classic geodesic sphere. Geodesic domes may also be based on other polyhedra, such as the octahedron and tetrahedron.

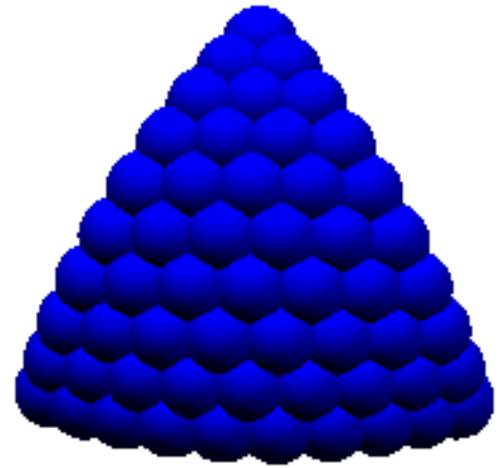

*9-frequency*

## DOMES COME IN CLASSES

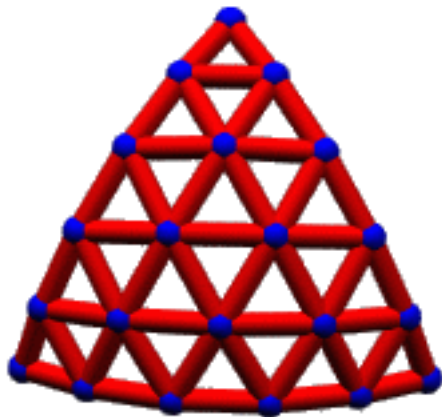

*Class I*

The classic geodesic sphere is composed of 20 curved triangles, each of which corresponds to one facet of the icosahedron, a 20-faceted polyhedron.

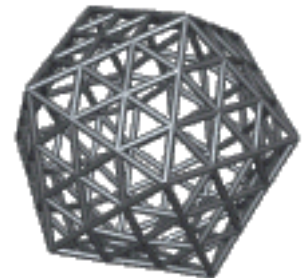

Each of the 20 triangles is curved because it is subdivided into smaller triangles, the corners of which are all pushed out to a constant distance from the sphere's center. The pattern used for this subdividing into smaller triangles is used to classify domes into classes I, II and III.

*For further reading*

- [Brainstorming on BuckyWorks](#)
- Re Epcot "geosphere" [\[1\]](#)[\[2\]](#)[\[3\]](#)[\[4\]](#)
- The [Project Renaissance model](#) for prototyping in the public sector

[Domes](#) | [History](#) | [Geometry](#) | [Providers](#) | [Prototypes](#)



*[Synergetics on the Web](#)*  
maintained by [Kirby Urner](#)

# 1. Introduction

Buckminster Fuller (1895-1983) is the renowned inventor of the geodesic dome, the world game, and a new system of mathematics called *synergetics*. He was a polymath whose writings and lectures touched upon every aspect of the human condition. He was a "new-former" pointing out, exploring and prototyping designs in numerous, previously uncharted areas of science and humanity. His greatest writings were *Critical Path*, *Synergetics* (2 volumes), and posthumously *Cosmography*. Since his physical death a class of recently discovered allotropes of carbon, the fullerenes, have been named in his honor.

A note on the compilation of this material. I tried to preserve as much about the original authors as possible. Some citations are in brackets before the text, others follow it. Most material is directly taken from the mailing lists and newsgroups (with minor editing to correct typos, a bit of streamlining, etc.,).

*BEWARE OF OUTDATED INFORMATION.*

Please follow-up with discussion and questions to [bit.listserv.geodesic](mailto:bit.listserv.geodesic) or to one of the mailing lists such the one described in section [List Geodesic](#) or in the section on [Related Mailing Lists](#).

## 2. Synergetics

In its broadest sense *synergetics* is Fuller's hypothesized coordinate system of Universe --- both in its physical and metaphysical aspects. Fuller's system of epistemography and mathematical-physics attempts to disclose how Nature actually operates --- her ``operational mathematics." Fuller claimed that synergetics could be understood by children (though they probably couldn't comprehend his books on the subject). He published this material in his essay ``Omni-directional Halo" (in *No More Secondhand God*), *Synergetics: Explorations in the Geometry of Thinking*, *Synergetics 2: Further Explorations in the Geometry of Thinking*, and *Cosmography*. *Cosmography* is probably the easiest to read for people unfamiliar with Fuller's prose style. An ``interleaved" version of *Synergetics* and *Synergetics 2* is available on the Web at <http://www.rwgrayprojects.com/synergetics/synergetics.html>.

From my own study of synergetics, I'm convinced that Bucky did in fact identify the coordinate system used by Nature. But I would add the caveat that he didn't get too far along in developing it. Fuller points to what the coordinate system is in broad strokes. He gives many penetrating insights and new discoveries, but the synergetics coordinate system needs a lot more development (and integration) before it will be possible to use it as the operative model in all of Science.

Tip to students of synergetics: Build models.

The essay [Reading Synergetics: Some Tips](#) offers useful help for anyone struggling to read *Synergetics*.

[From Kirby Urner]

**Synergetics:** A metaphoric language for communicating experiences using geometric concepts.

Thinking is the tuning in/out of systems. Systems are spherical networks of interrelated points of interest. The density of points is a measure of a system's ``frequency" -- super high frequency systems approach sphericity.

The minimal system with the fewest possible points is a tetrahedron -- four points make a primitive volume with an inside and an outside. The canonical tetrahedron has a volume of one.

The tetrahedron may be sliced into 24 irregular tetrahedra (12 left handed, 12 right handed) called ``A modules." The octahedron is comprised of 48 A and 48 B modules of equal volume = 4 x the volume of the tetrahedron. A and B modules may be used to assemble the cube (3 tetravolumes), rhombic dodecahedron (6 tetravolumes), and the Coupler (1 tetravolume). The Coupler, with the same volume as the tetrahedron (1), is an irregular octahedron that packs together to fill space without gaps.

Radiation is explosive outwardly while Gravitation is an implosive squeezing at 90 degrees to Radiation, i.e. is circumferential. Metaphysically, Gravity networks points of interest into systems of interrelated thoughts while Radiation drains away the sense of our systems and turns them into meaningless noise. Radiation is compression, Gravity is tension. Radiation is Entropy. Gravity is Love. Clearly this is not Physics but a more metaphorical language for communicating experiences using geometric concepts. This is Synergetics.

[Ed: I think Fuller's synergetics describes real physics. Though it is true as Kirby points out that Bucky's presentation is more ``descriptive" than ``hard" physics. I contend that because Fuller is ``right on" in his description, it is up to us to find the ``hard" physics interpretation behind his ``metaphors." ]

[Typed in by Kurt Przybilla]

[From [Synergetics \[900.20-900.33\]](#)]

900.20 Synergetics

900.21 Synergetics is a book about models: humanly conceptual models; lucidly conceptual models; primitively simple models; rationally intertransforming models; and the primitively simple numbers uniquely and holistically identifying those models and their intertransformative, generalized and special case, number-value accountings.

900.30 Model vs. Form

900.31 Model is generalization; form is special case.

900.32 The brain in its coordination of the sensing of each special case experience apprehends forms. Forms are special case. Models are generalizations of interrelationships. Models are inherently systemic. Forms are special case systems. Mind can conceptualize models. Brains can apprehend forms.

900.33 Forms have size. Models are sizeless, representing conceptuality independent of size.

- Bucky, *Synergetics 2*

Bucky went far in describing experience in terms of the experientially derived model, discovering along the way the synergetically surprising benefits to build structures based upon the special case structures designed using the generalized principles understood using this evermore useful mentality.

[From [Synergetics \[200.001-201.03\]](#)]

200.001 Definition: Synergetics

200.01 Synergetics promulgates a system of mensuration employing 60-degree vectorial coordination comprehensive to both physics and chemistry, and to both arithmetic and geometry, in rational whole numbers.

200.02 Synergetics originates in the assumption that dimension must be physical; that conceptuality is metaphysical and independent of size; and that a triangle is a triangle independent of size.

200.03 Since physical Universe is entirely energetic, all dimension must be energetic. Synergetics is energetic geometry since it identifies energy with number. Energetic geometry employs 60-degree coordination because that is nature's way to closest-pack spheres.

200.04 Synergetics provides geometrical conceptuality in respect to energy quanta. In synergetics, the energy as mass is constant, and nonlimit frequency is variable.

200.05 Vectors and tensors constitute all elementary definition.

201.00 Experientially Founded Mathematics

201.01 The mathematics involved in synergetics consists of topology combined with vectorial geometry. Synergetics derives from experientially invoked mathematics. Experientially invoked mathematics shows how we may measure and coordinate omnirationally, energetically, arithmetically, geometrically, chemically, volumetrically, crystallographically, vectorially, topologically, and energy-quantum-wise in terms of the tetrahedron.

201.02 Since the measurement of light's relative swiftness, which is far from instantaneous, the classical concepts of instant Universe and the mathematicians' instant lines have become both inadequate and invalid for inclusion in synergetics.

201.03 Synergetics makes possible rational, whole-number, low-integer quantation of all the important geometries of experience because the tetrahedron, the octahedron, the rhombic dodecahedron, the cube, and the vector equilibrium embrace and comprise all the lattices of all the atoms.

-Bucky, *Synergetics*

The isotropic vector matrix provides a model for thinking - for thought - a model more flexible than the

squarebox X-Y-Z cubist mindframe, a clearly defined mathematical and physical model, an organic matrix based on the closest packing of spheres, bubbles, atoms. A model which attempts to explain everything, much more than any linguistically linear metaphor can ever manage.

It provides a structure in which to think about any structure or system. Whether you want to discuss why people first built dome shaped huts, why St. Peter's cathedral was the largest space man had domed until Bucky came along, why planets and stars are spherical, the structure of the atom, the structure of complex carbon molecules scientists worldwide are building, or dome homes we wish to build.

I dream of building many. The nicest is portable, made of the highest quality, light weight alloys, easily affordable and assembles almost anywhere on the planet by the average human and friends in about a day. It will utilize the best solar technology, all technology comprehensively integrated to improve living.

## [2.1 What is a tetrahedron \(tetra\), octahedron \(octa\), and an icosahedron \(icosa\)?](#)

These are the three omni-triangulated, omni-symmetrical, stable, space structures in Universe. The tetra has 4 vertices (crossings), 6 edges (vectors) and 4 faces (openings). The octa has 6 crossings, 12 vectors, and 8 openings. The icosahedron has 12 crossings, 30 vectors, and 20 openings. The Greeks called these three figures "platonic solids." They are very important in synergetics.

[From Vincent J. Matsko]

For those interested in group theory, from a group theoretical perspective, we can view the symmetry groups of the tetrahedron and the octahedron as subgroups of the symmetry group of the icosahedron (with reflections included) - so that, in a sense, the tetrahedron and octahedron are "children" of the icosahedron.

## [2.2 What is "synergy"?](#)

[From [Synergetics \[101.01-102.00\]](#)]

"Synergy means behavior of whole systems unpredicted by the behavior of their parts taken separately.

"Synergy means behavior of integral, aggregate, whole systems unpredicted by behaviors of any of their components or subassemblies of their components taken separately from the whole."

[From Blaine A. D'Amico.]

Fuller's clearest example of "behavior of whole systems unpredicted by the behavior of the parts" is mass attraction. The Earth and the Moon maintain their relationship through an interattraction of their respective masses. This mass attraction (gravity being a special case of mass attraction) is a function of the mass of the two bodies AND THEIR DISTANCE FROM ONE ANOTHER. The scientific law governing this attraction states that if you halve the distance between the two bodies you quadruple the attraction and vice-versa (i.e. double the distance and the attraction is 1/4 the original). This generalized principle (the law of mass attraction) is a synergy because if either body is considered separately there is no attractive force to examine. The law of mass attraction is mathematically exact and exists only as a function of the whole system. It is therefore a Synergy.

## [2.3 What is Fuller's definition of "Universe"?](#)

[From [Synergetics \[301.00-302.00\]](#)]

"Universe is the aggregate of all humanity's consciously apprehended and communicated nonsimultaneous and

only partially overlapping experiences.

`` `Aggregate' means sum-totally but nonunitarily conceptual as of any one moment. `Consciousness' means an awareness of the otherness. `Apprehension' means information furnished by those wave frequencies tunable within man's limited sensorial spectrum. `Communicated' means informing self or others. `Nonsimultaneous' means not occurring at the same time. `Overlapping' is used because every event has a duration, and their initiatings and terminatings are most often of different duration. Neither the set of all `experiences' nor the set of all the words used to describe them are instantly reviewable nor are they of the same length. Experiences are either involuntary (subjective) or voluntary (objective), and all experiences, both physical and metaphysical, are finite because each begins and ends."

## **2.4 What is the `Isotropic Vector Matrix' (IVM)?**

[From [Synergetics \[410.06\]](#)]

``So I then went on to say if all the energy conditions were everywhere the same, then all the vectors would be the same length and all of them would interact at the same angle. I then explored experimentally to discover whether this `isotropic vector matrix' as so employed in matrix calculus, played with empty sets of symbols on flat sheets of paper, could be realized in actual modeling. ..." He then describes his kindergarten discovery of the octet-truss (octahedrons + tetrahedrons in an all-space filling array).

[From [Synergetics \[420.01\]](#)]

``When the centers of equiradius spheres in closest packing are joined by most economical lines, i.e., by geodesic vectorial lines, an isotropic vector matrix is disclosed -- `isotropic' meaning `everywhere the same,' `isotropic vector' meaning `everywhere the same energy conditions.' This matrix constitutes an array of equilateral triangles that corresponds with the comprehensive coordination of nature's most economical, most comfortable, structural interrelationships employing 60-degree association and disassociation. Remove the spheres and leave the vectors, and you have the octahedron-tetrahedron complex, the octet truss, the isotropic vector matrix."

## **2.5 What is an octet truss?**

[Mitch Amiano]

An Octetruss, to use the trademarked moniker, is an OCTahedral and TETrahedral complementary grid implemented in such a way as to form a structural truss. A truss is an engineering mechanism for dispersing loads across a relatively long span, to enable coverage of large, primarily horizontal areas with a minimum of underpinning supports (posts). Most trusses appear to be arranged to act independently of one another, whereas the members of an Octetruss are all part of the whole unit. Octetruss is not the only such truss system. Other geometries have been used to create omnidirectional truss systems; the more general name for any one of these systems is a `space frame'.

It should be very well known that Alexander Graham Bell built Octahedral/Tetrahedral trusses and used them for enormous kites and flying machines. I saw some *very* old films of Bell and one of his octet configuration kites; it seemed to be one of his hobbies.

[Hal Adams]

Most trade publications periodically have articles on space frames. You might try ``Architecture" a monthly publication of the American Institute of Architects, ``Engineering News Record" an engineering weekly. You can check the ``Art Index" which has an index of all articles from design publications. A good general structural book is *Why Buildings Stand Up* by Mario Salvadori, published by McGraw Hill paperbacks.

[Bruce T. Lael] The following quote comes from Hugh Kenner's book *Bucky: A Guided tour of Buckminster Fuller*, c.1973

``...What are we to make, for instance, of Alexander Graham Bell's infatuation about the tetrahedron?

``About two years after little Bucky's adventure with the toothpicks and the peas, the veteran inventor of telephony perceived in the tetrahedron a figure of singular virtue. It is the three-dimensional equivalent of the triangle, holding its form with invincible tenacity. It is the minimum space enclosure, with four identical sides nothing simpler can be envisaged. Having of all space enclosures the maximum structure in proportion to its content, it has therefore the maximum attainable strength. Bell's mind moved to performance per pound and to aeronautics, and in the very summer before the Wrights flew he wrote in his son-in-law's *National Geographic* of the virtues of a tetrahedral configuration in kites. Such a kite will not easily lose lift, and Bell's idea that the future of aeronautics lay in a design which wouldn't tend to kill the pilot in case of a stall led him to hundreds of experiments with kites composed of many tetrahedral cells, as many as 1300.

``In 1905, such a kite powered by a feeble breeze, lifted a man some thirty feet into the air ....

``...He did erect, on his Nova Scotia island, a tetrahedral tower, its seventy-two foot legs meeting tripod fashion five stories above the ground. Each leg was subdivided into four-foot tetrahedral cells of half-inch pipe, and each cell could support two tons without signs of distress. Bell had effected about 1907 one of the periodical rediscoveries of the oc-tet configuration Bucky stumbled onto in kindergarten, and moreover has used it in a practical structure. He seems not to have applied for a patent and the tetrahedral tower was dismantled after a decade. Bucky had very possibly never heard of it when he came upon the principle yet again during his geometrical work of the 1940's and wrote to his patent lawyer."

## **I wondered if hexagonal closest packing forms an IVM? Also, is a diamond cubic structure the same as an IVM? [Steve Mather]**

HCP allows infinite permutations as successive layers of spheres do not need to lie over top a specific hole in the layer 2 down. HCP is not a restrictive enough packing method to generate the IVM per se.

The IVM is equivalent to the face-centered cubic packing (FCC). I believe all diamond atoms occupy FCC positions, but leave others empty. Buckminsterfullerene will pack into an IVM (appropriately), and, with potassium wedged in some of the interstices, become a superconductor. (See section [What are Fullerenes? and Buckyballs](#) for more on the fullerenes.) --- Kirby

## **What are some good ways to build sphere packing models?**

[From Blaine A. D'Amico.]

I use various sized Styrofoam (yes I know its not a green material) balls in my classes. They are very easy to work with.

[From Chris Fearnley]

Ping pong balls are wonderful. I use a tacky tape type stuff to bind them together (this helps me to dis-assemble and then re-assemble them into new shapes). I got about two gross to work with - very fun and educational. I prefer the sticky tape to glue, less messy, reversible and pliable to adjust for physical imperfections.

[Charlie Hendricksen]

Some years ago I took a delightful course in ``Patterns in Nature." We made models of the various crystal structures and geometric models using Duco cement and the plastic beads from bead chains from the import shop (Pier One). Cheap, the right size (about 5mm), and best of all many colors.

## 2.6 What is the "vector equilibrium" (VE)?

[From [Synergetics \[205.01\]](#)]

"The geometrical model of energy configurations in synergetics is developed from a symmetrical cluster of spheres, in which each sphere is a model of a field of energy all of whose forces tend to coordinate themselves, shuntingly or pulsatively, and only momentarily in positive or negative asymmetrical patterns relative to, but never congruent with, the eternality of the vector equilibrium. The vectors connecting the centers of the adjacent spheres are identical in length and angular relationship. The forces of the field of energy represented by each sphere interoscillate through the symmetry of equilibrium to various asymmetries, never pausing at equilibrium. The vector equilibrium itself is only a referential pattern of conceptual relationships at which nature never pauses."

## 2.7 What is the "jitterbug"?

[ Making this model will greatly ease understanding of the jitterbug transformation described below. I use 6" dowels joined together with surgical tubing. Cut the surgical tubing into 2" pieces. Use a washer to form a four-valent, flexible vertex joining two pieces of the surgical tubing or insert one piece of 2" tubing into a hole (you must cut it yourself) in another 2" piece of tubing to create the vertex. The diameter of the surgical tubing should be very slightly (1/16") smaller in diameter than the dowels. You will need 24 such struts and 12 such vertices. Geometers call the shape of the VE a "cuboctahedron." ]

[From [Synergetics \[460.01-460.05\]](#)]

"The 'jitterbug' is the finitely closed, external vector structuring of a vector-equilibrium model constructed with 24 struts, each representing the push-pull, action-and-reaction, local compression vectors, all of them cohered tensionally to one another's ends by flexible joints that carry only tension across themselves, so that the whole system of only-locally-effective compression vectors is comprehensively cohered by omniembracing continuous four sliced hexagonal cycles' tension.

"When the vector-equilibrium 'jitterbug' assembly of eight triangles and six squares is opened, it may be hand-held in the omnisymmetry conformation of the vector equilibrium 'idealized nothingness of absolute middlelessness.' If one of the vector equilibrium's triangles is held by both hands in the following manner - with that triangle horizontal and parallel to and above a tabletop; with one of its apexes pointed away from the holder and the balance of the jitterbug system dangling symmetrically; with the opposite and lowest triangle, opposite to the one held just parallel to and contacting the tabletop, with one of its apexes pointed toward the individual who is handholding the jitterbug - and then the top triangle is deliberately lowered toward the triangle resting on the table without allowing either the triangle on the table or the triangle in the operator's hands to rotate (keeping hands clear of the rest of the system), the whole vector equilibrium array will be seen to be both rotating equatorially, parallel to the table but not rotations its polar-axis triangles, the top one of which the operating individual is hand-lowering, while carefully avoiding any horizontal rotation of, the top triangle in respect to which its opposite triangle, resting frictionally on the table, is also neither rotating horizontally nor moving in any direction at all.

"While the equatorial rotating results from the top triangle's rotationless lowering, it will also be seen that the whole vector-equilibrium array is contracting symmetrically, that is, all of its 12 symmetrically radiated vertexes move synchronously and symmetrically toward the common volumetric center of the spherically chorded vector equilibrium. As it contracts comprehensively and always symmetrically, it goes through a series of geometrical-transformation stages. It becomes first an icosahedron and then an octahedron, with all of its vertexes approaching one another symmetrically and without twisting its axis.

"At the octahedron stage of omnisymmetrical contraction, all the vectors (strut edges) are doubled together in



tight parallel, with the vector equilibrium's 24 struts now producing two 12-strut-edged octahedra congruent with one another. If the top triangle of the composite octahedron (which is the triangle hand-held from the start, which had never been rotated, but only lowered with each of its three vertexes approaching exactly perpendicularly toward the table) is now rotated 60 degrees and lowered further, the whole structural system will transform swiftly into a tetrahedron with its original 24 edges now quadrupled together in the six-edge pattern of the tetrahedron, with four tetrahedra now congruent with one another. Organic chemists would describe it as a quadrivalent tetrahedral structure.

``Finally, the model of the tetrahedron turns itself inside out and oscillates between inside and outside phases. It does this as three of its four triangular faces hinge open around its base triangle like a flower bud's petals opening and hinging beyond the horizontal plane closing the tetrahedron bud below the base triangle."

[From Blaine A. D'Amico.]

For a full (and quite mind boggling) discussion of these Jitterbug Transformers see ``The Complete set of Jitterbug Transformers and the analysis of their motion" by H.F. Verheyen in COMPUTERS, MATH AND APPLICATIONS Vol 17, No. 1-3 pp. 203-250, 1989.

## 2.8 What is a sphere?

[From *Synergetics* - typed in by Kurt Przybilla]

[224.07](#) Sphere: The Greeks defined the sphere as a surface outwardly equidistant in all directions from a point. As defined, the Greeks' sphere's surface was an absolute continuum, subdividing all the Universe outside it from all the Universe inside it; wherefore, the Universe outside could be dispensed with and the interior eternally conserved. We find local spherical systems of Universe are definite rather than infinite as presupposed by the calculus's erroneous assumption of 360-degree-ness of surface plane azimuth around every point on a sphere. All spheres consist of a high-frequency constellation of event points, all of which are approximately equidistant from one central event point. All the points in the surface of a sphere may be interconnected. Most economically interconnected, they will subdivide the surface of the sphere into an omnitriangulated spherical web matrix. As the frequency of triangular subdivisions of spherical constellation of omnitriangulated points approaches subvisibility, the *difference* between the sums of the angles around all the vertex points and the numbers of vertexes, multiplied by 360 degrees, remains constantly 720 degrees, which is the sum of the angles of two times unity (of 360 degrees), which equals one tetrahedron.

## 2.9 What is Fuller's concept of ``space?"

[From [Synergetics 2 \[100.62-100.63\]](#)]

``[One reason for human incomprehensibility of the findings of science] is our preoccupation with the sense of static, fixed ``space" as so much unoccupied geometry imposed by square, cubic, perpendicular, and parallel attempts at coordination, rather than regarding ``space" as being merely systemic angle-and-frequency information that is presently non-tuned-in within the physical, sensorial range of tunability of the electromagnetic sensing equipment with which we personally have been organically endowed.

``The somethingness here and the nothingness there of statically interarrayed ``space" conceptioning is vacated as we realize that the infratunable is subvisible high-frequency eventing, which we speak of as matter, while the ultratunable is radiation, which we speak of as space. The tunable is special case, sensorially apprehensible episoding."

[From Chris Fearnley]

Space is ``systemic angle-and-frequency information" because like all awareness it is patterned systemically and

hence polyvertexially. It is information because the angle-and-frequency constituted system can be resolved into bits, 20-questions-wise.

Space is ``presently non-tuned-in within the physical, sensorial range" because we are presently not receiving electromagnetic energy or information to our eyes, ears, nose, tongue or skin. But space is identifiable as a metaphysical system -- it is ``out there."

[Kirby Urner's contributions.] Space, the Final Untuned

Vis-a-vis whatever is in experience at the moment, is a vast otherness, which is by definition not tuned. That is space, the field of potential experience, I would say. Or maybe the field of ``unmeant meanings" (no experience of that at this time). The trichotomy of ``outside system, system, inside system" or ``ultra-system-infra" is a generic description of that system (e.g. ``belief system"). The ``space of the untuned" or ``final frontier" of a specific system is whatever that system cannot tune in. We all live in the space of our ignorance.

Space as ``ultratunable radiation"

Before people knew about clusters of galaxies, or this galaxy for that matter, or ``outer space" in general, they had yet to receive the energy through their instruments that would inform them of this ``space" and its contents. The only way we have a concept of ``space" is owing to our receiving energy. Relates to your dwelling on ``experience" which Fuller equates with the ``tuned" (vs untuned). What we tune is energetic. The far apartness of the galaxies, their infrequency, is what made them so ultratunable (unexperiential) for such a long time.

## **2.10 What is a ``system?"**

[From [Synergetics \[400.011-02\]](#)]

``A system is the first subdivision of Universe. It divides all the Universe into six parts: first, all the universal events occurring geometrically outside the system; second, all the universal events occurring geometrically inside the system; third, all the universal events occurring nonsimultaneously, remotely, and unrelatedly prior to the system events; fourth, the Universe events occurring nonsimultaneously, remotely, and unrelatedly subsequent to the system events; fifth, all the geometrically arrayed set of events constituting the system itself; and sixth, all the Universe events occurring synchronously and or coincidentally to and with the systematic set of events uniquely considered.

``A system is the first subdivision of Universe into a conceivable entity separating all that is nonsimultaneously and geometrically outside the system, ergo irrelevant, from all that is nonsimultaneously and geometrically inside and irrelevant to the system; it is the remainder of Universe that conceptually constitutes the system's set of conceptually tunable and geometrical interrelatibility of events. ...

``All systems are polyhedra. Systems having insiderness and outsiderness must return upon themselves in a plurality of directions and are therefore interiorally concave and exteriorally convex. Because concaveness reflectively concentrates radiation impinging upon it and convexity diffuses radiation impinging upon it, concavity and convexity are fundamentally different, and therefore every system has an always and only coexisting inward and outward functionally differentiated complementarity. Any one system has only one insiderness and only one outsiderness. ..."

## **2.11 What is the ``minimal system?"**

The tetrahedron, of course.

[From Gary Lawrence Murphy]

The minimum system is an entity distinct from the rest of universe. The division is between the consideration set

and the irrelevant; there will be leaks because no system is an island ;-), but for design purposes, the boundary defines the extent of energy interchange as represented by the concavity of the tetrahedral interior.

The four components [of our friend the tetrahedron] are four sub-tunable systems, only resolvable as a single point, but a system none the less. Between these, we have Euler's rules for relative abundance of topological features, so if we can identify four stellar partners, we can postulate 6 interaction pairs and four interaction 'facets;' we can also look at the non-simultaneousness of the pair-interaction vertex stars as potential leak points (in reality, each is probably involved in a myriad of other tetrahedrally-thinkable systems) or in Fuller's terms, shunting-off points.

## **2.12 What are the A and B quanta modules?**

[From Chris Fearnley]

Take a tetrahedron. Hold the opposite vertices in turn (two pairs). Spin the tetra. Use a "knife" to cut the tetra where the "great circle" from the spinning would cut it. You now have the 24 A quanta modules of the tetra (12 positive, 12 negative in orientation). Take 1/8th of an octahedron (it's simple to see that the only way to do this is to extract the tetrahedron formed by the center of the octa and the three vertices that form one of its faces). Divide this into 6 equal parts (put the octa face on the table and use the edge bisectors). Note the line from the center of the octa to the center-face of the octa in the 1/8th octa. (It will be on the inside of the last division into 6 parts.) Find it's midpoint and slice the 1/48th octas along this midpoint, dividing the original octa into 96 pieces. The piece of the 1/96th octa that is 1/6th of the face of the octa is our old friend the A module. The B module is the other part. They have the same volume though the shapes differ.

## **2.13 What is the "omnidirectional halo?"**

[This relates to Fuller's epistemography. From [Synergetics \[501.10-501.12\]](#)]

"Any conceptual thought is a system and is structured tetrahedrally. This is because all conceptuality is polyhedral. The sums of all the angles around all the vertexes - even crocodile, or a 10,000-frequency geodesic (which is what the Earth really is) - will always be 720 degrees less than the number of vertexes time 360 degrees.

"The difference between nonconceptual, nonsimultaneous Universe and thinkability is always two tetrahedra: one as macro, to complete the convex localness outside the system, and one as micro, to complete the concave localness inside the system, to add up to finite but nonconceptual Universe. Thus the thinkable system takeout from Universe has a 'left-out' outside irrelevancy tetrahedron and a 'left-in' inside irrelevancy tetrahedron.

"You have to have the starkly nonvisible to provide the complementary tetrahedron to account for the visibility, since concave and convex are not the same. That stark invisible reality of the nonconceptual macro- and micro-tetrahedra also have to have this 720-degree elegance. But the invisible outside tetrahedron was equally stark. The finite but nonconceptual inness and outness: that is the Omnidirectional Halo."

## **2.14 What does Fuller mean by 4D?**

[From Kirby Urner]

Fuller used 4D to refer to the 4 rays from a central hub that omnisymmetrically define an expanding volume (e.g. the four lines from the center of a tetrahedron to its four vertices). The Cartesian system consists of 6 rays from the origin defining an expanding cube. The expanding tetrahedron uses/defines volume more economically, Bucky claimed.

[From Clifford J. Nelson]

The four dimensions refer to the movement of the four enclosing planes of a tetrahedron, not to rays to the vertexes.

## **2.15 Does synergetics provide an extension or modification of the `scientific method'?**

I've been thinking lately: Does Bucky offer in SYNERGETICS an extension of the scientific method? The definition of Universe ``The aggregate of all humanity's consciously apprehended and communicated (to self or others) experiences." Together with Fuller's notion of thinking as the systemic process of sorting experiences into three broad sets: the macroscopic irrelevant, the microscopic irrelevant, the lucidly relevant set. This is his omnidirectional halo. I think it provides a means of organizing our thinking to make it more effective. Isn't this what the scientific method is supposed to do? Moreover, the dynamic nature of synergetics implies that we need not get stuck permanently in paradigms as Thomas Kuhn suggests. Maybe synergetics is transparadigmatic. --- C. Fearnley

Most definitely. Fuller did not choose the name Comprehensive Anticipatory Design SCIENCE lightly. Like all of Fuller's language the name was carefully chosen. I feel that your characterization of Synergetics as an extension of the scientific method is absolutely true. In fact this is one of Fuller's main criticisms of traditional geometry, that it is not science; meaning that it is not ``... setting in order the facts of experience" but farther constructing an imaginary Universe out of non existent points, lines, and planes. --- Blaine A. D'Amico

## **2.16 Are there connections between synergetics and fullerenes (besides the name, of course)?**

The connections that I see between Synergetics and the Fullerenes are manifold. First, Carbon is a tetrahedral atom. It would seem logical that even if there were exceptions to Fuller's tetrahedral concept of the shape of space, Carbon would surely obey these geometric principles (if the principles are true.) Fuller's discussions of tetrahedral bonding are remarkably similar to Linus Pauling's illustrations in ``The Architecture of Molecules," for example. --- Blaine A. D'Amico

(See section [What are Fullerenes? and Buckyballs](#) for more on the fullerenes.)

## **2.17 Why use synergetics' conversion factors and other irrationals?**

[From [Synergetics \[410.02\]](#)]

``The omnirational associating and disassociating of chemistry - always joining in whole low-order numbers, as for instance H(2)O and never H(pi)O - persuaded me that if I could discover nature's comprehensive coordination, it would prove to be omnirational despite academic geometry's fortuitous development and employment of transcendental irrational numbers and other 'pure,' nonexperimentally demonstrable, incommensurable integer relationships."

[From Mitch Amiano]

Why does he so often make use of square root of 2, and to approximations of pi? It seems in fact that he actively uses them, but only as approximations, and with a synergetic conversion factor.

[From Kiyoshi Kuromiya]

I believe Fuller uses synergetic conversion factors simply as handy "fudge factors" and, if he had his way in the world, there would be no need for conversions, because everyone would use an entirely rational number system--or even more, a system consisting entirely of whole numbers. The use of the square root of two, I believe, is simply to illustrate principles of alloying, and like in the other case, could be dispensed with, if everyone were used to proofs that only relied on whole numbers.

[From Kirby Urner]

Relevant here is that giant Scheherazade number -- abbrev. Sz -- Fuller suggests would rationalize trigonometry. Adding lots of primes makes some sense, and a screen with that many pixels could certainly give us adequate resolution to submolecular levels, all with whole number coordinates. Second-root-of-two would be a shorthand symbol within a computational notation with a granular, integer underpinning. Given a grainy nature, with no absolute positions as represented by continuing irrational numbers to umpteen digits, I can see how Fuller felt no need to take the Number Theory idea of irrationality as a concept implemented in nature. But our symbols, our "root of 2" notations, continue to be useful, just as they always have.

I don't think Sz numbers make the number theory idea of irrationals go away. The problem was never "too few primes" in our base. The proof that the 2nd root of 2 is irrational has nothing to do with primes, more with an *reductio ad absurdum* showing it's neither true nor false that the root of 2 is even or odd ... anyway, I don't think Fuller is arguing that mathematicians have been wrong all these years in their own terms -- just that nature doesn't need to continue pi or other fractions according to some infinite rules. No time for that.

[From Mitch Amiano]

Given that Synergetics rejects irrationals, and given a modeling of nature based upon an integer representation with a specific sub-molecular resolution, could we not calculate the square root of 2 as a rational number?

This is what carpenters do every time they check the accuracy of a square layout by measuring from corner to corner. The resolution of their measurements is at a significantly higher level, in terms of fractional inches.

An example of measurement rationalization can be seen when moving from a relatively large base unit - the inch - to a relatively small one - the millimeter. More of the numbers are represented as whole integers.

Thus, the operational square root of 2 is 1.40625" when measured in thirty-seconds of an inch on a 1"x1" square, or 37mm when measured in millimeters.

[From Vincent J. Matsko]

Re: The irrationality of the height of an equilateral triangle: Again, I think it a matter of perspective. One may take an easy way out (I often do) and say that the square of the ratio of the height of an equilateral triangle to its edge is 3/4. Voila, a rational number! Or alternatively, sometimes an expression involving square roots may be described as the solution of a quadratic equation with integer coefficients (i.e., the golden ratio is a root of  $x^2 = x + 1$ ).

Now on another level, this is unsatisfactory, and I can't offer a good answer. Allow me a suggestion: change the comparison. For example, what is the ratio of the volume of a regular tetrahedron to the volume of a cube when both have the same edge length? Answer: irrational and irrelevant! Look through Fuller, and you never see (as least not to my recollection) two such figures. One only encounters a tetrahedron and the circumscribing cube. In this case, the ratio of the volumes is 1/3.

Thus, not every "ratio" is rational; it depends upon what one takes the ratio of. And setting a standard is not simple. I believe, for example, that Williams in his book about structure gives data for the Archimedean solids relative to an edge length of one, which I find wholly unsatisfactory. Here is my choice for the "basic" Platonic solids: Begin with a tetrahedron, circumscribe a cube, and for the octahedron, take the dual to the cube (in the sense that the edge of duals perpendicularly bisect each other). Now the cube may in turn be inscribed in a

dodecahedron, whose dual is an icosahedron. Now compute ratios of volumes of these figures, not those with edge length of one! For it is these figures which ``naturally" occur in concert with each other.

For those ratios involving icosahedra/dodecahedra, one must be satisfied with rationals and the golden ratio as well. In fact, I am inclined to submit that the golden ratio be given honorary ``rational" status!

[From Chris Fearnley]

This reminds me of the ``canonical form" problem in mathematics. I realized in college that the notion of canonical form is ridiculous. Who cares if you have a sqrt() in the denominator of a fraction? Isn't a fraction of fractions still a fraction? If expressions not in canonical form are ``bad" then doesn't that taint the whole derivation? Of course NOT! For synergetics calculations we are defining a new aesthetic for canonical form. One that is more geometrically intuitive and hence explainable to young children. From this perspective, it doesn't matter if we need to do ``ugly" calculations to get some result - just put it in canonical (synergetic) form at the end. And by trying to do whole derivations entirely in synergetics (canonical) we accomplish the dual objectives of getting a clear geometrical representation and it's the one Nature is actually using in her transformings and intertransformings.

When reading synergetics it struck me that perhaps there are two basic phases in the Universe - tetra and icosahedron. Your regular polyhedra hierarchy may be just another way of looking at the three fundamental geometrical forms in Universe - my so-called canonical (rational) forms.

## 2.18 What is ``precession?"

[From Chris Fearnley]

I think the simplest first-order definition of precession is the side effects of a system in motion (generally occurring at 90 degrees to the direction of motion).

[Blaine D'Amico]

Bucky said that precessional effects are what most people label ``side effects." i.e., I teach a person to fish so he can feed his family (Direct effect). One of his no longer hungry children now can focus in school and goes on to become an important scientist (precessional effect).

[From Gerry Segal]

My college physics books defines precession as:

``a complex motion executed by a rotating body subjected to torque, by a conical locus of the axis"

That's quite a mouthful. Bucky gets even more complex. In [Synergetics \[533.08\]](#), he defines precession as:

``the intereffect of individually operating cosmic systems upon one another. Since Universe is an aggregate of individually operative systems, all of the intersystem effects of the Universe are precessional, and the 180-degree imposed forces usually result in redirectional resultants of 90 degrees."

A beautiful example is given in [Synergetics \[417.00\]](#). Here two exact sets of 60 Closest-packed spheres (wedges) are rotated 90-degrees and twisted (torque). An unexpected and marvelous result is a perfect 8 ball edged, 7-frequency tetrahedron that is formed.

I doubt that I have been successful in helping you understand precession. But I do know that if you take the time and build the models you'll have an underlying sense of the meaning that provides the basis of understanding that the written word only hints at.

[From Leo Elliott]

The clearest example I recall Bucky giving of the notion of ``precession" was that from the viewpoint of a waterbug or a jellyfish on the surface of the water, directly in the path of some big ship, which will send out precessional waves slightly ahead of the bow, thereby alerting the astute bug or jellyfish that something big is indeed on the way.

[From David Worrall]

Imagine a pebble dropped into a pond. The pebble goes to the bottom (closer to the centre of gravity of the earth!) The wave created moves outwards, at 90 degrees, precessionally, to the pebble.

[From Kirby Urner]

``Precession" in synergetics shows up as the relationship between two sides of the same generalized principle coin. Gravity begets radiation begets gravity. Tension begets compression begets tension. Pull on two ends of a rope, and its strands are squeezed even more tightly together. Where two very general aspects of nature always and only co-exist, and their relationship is generally precessional.

Synergetics is unlike traditional physics in its insistence on gravity as a circumferential pulling together (and thereby implosive), versus a radial explosiveness emanating from the center -- a 90 degree relationship. The Sun is a giant squeeze ball. Strands of thought are likewise circumferentially implosive, nonlinear hypertext countervailing against vs the information explosion.

By extension, ``precession" refers to nature's way of getting the job done at 90 degrees to human selfishness and ignorance. We ``do the right things for the wrong reasons." The graduating from Class II to Class I evolution which Fuller anticipates involves our starting to do the right things for the right reasons, like you don't need the Cold War to have the space program to have higher living standard spin-off technologies (goodies yielding at 90-degrees to ignorance and fear). We don't have time for that kind of bumbling anymore.

## **2.19 What is the equation for finding the volume of a pyramid? [Steve Mather]**

[From Chris Fearnley]

The issue of volume measure is dependent on the choice of the unit of volume. I recommend choosing the tetrahedron as the unit of volume. Then by subdividing the octahedron and tetrahedron into ``building blocks" fascinating relationships will be discovered. Try building some models too!

[From Kirby Urner]

I agree with Chris F. -- using Fuller's regular P-lengthed tetrahedron as a unit of volume is a good beginning. A regular P-edged octahedron will have 4 times the tetra's volume, while a cube with a P-lengthed diagonal will have 3 times the tetra's volume. That means a cube of diagonal P has 3/4 the volume of an octahedron of edge P. Say P=1. The corresponding cube of diagonal 1 has a volume of about 0.354 (conventional math), and so the octahedron has a volume of 4/3 that, or 0.471 (again, conventional math). If we multiply both results by the Synergetics Constant, we get a cube of volume 0.3750000 (precise) and an octahedron of volume 1/2. Those are the nice volumes we'd like, given a simple edge of 1. Note that the tetrahedron of edge 1 has a volume of 1/8. That's because of how the Synergetics Constant is derived. The so-called ``prime vector" between any 2 adjacent spheres in the icomatrix is of Cartesian length 2 (these are unit-radius spheres after all). So the Synergetics Constant is the ratio between the volume of a prime vector diagonaled cube in Synergetics (=3) and the corresponding cube in XYZ geometry (2nd-root of 2 to the third power).

[From Martin Roller]

Kirby Urner writes:

>By the way, there *is* a formula that provides the volume of  
>*any* tetrahedron given its 6 edges as inputs. It's a monster  
>formula, derived by Leonhard Euler. I doubt I could write it  
>understandably in ASCII.

Let ABCD be a tetrahedron with sides

$$\begin{aligned} a &= AD, & b &= BD, & c &= CD, \\ p &= BC, & q &= CA, & r &= AB. \end{aligned}$$

The volume V of the tetrahedron can be computed from the determinant of a 5-by-5 matrix as follows (here ^2 means taking squares).

$$288 V^2 = \begin{vmatrix} 0 & r^2 & q^2 & a^2 & 1 \\ r^2 & 0 & p^2 & b^2 & 1 \\ q^2 & p^2 & 0 & c^2 & 1 \\ a^2 & b^2 & c^2 & 0 & 1 \\ 1 & 1 & 1 & 1 & 0 \end{vmatrix}$$

[From Kirby Urner] Euler's equation for any Tetrahedron w/ edges p,q,r,s,t,u,v:

$$\begin{aligned} M = & (2qrt)^2 \\ & - [q^2(r^2+t^2-u^2)]^2 \\ & - [r^2(q^2+t^2-v^2)]^2 \\ & - t^2(q^2+r^2-s^2)^2 \end{aligned}$$

substitute above M in equation below (V=Volume)

$$V = 1/12 [M + (r^2+t^2-u^2)(q^2+t^2-v^2)(q^2+r^2-s^2)]^{.5}$$

This looks a lot more complicated than the determinant expression, but then a determinant is short-hand for a long messy expression. Anyway, both give the same answers. Then you can multiply by the Synergetics Constant to give the volume relative to a Tetrahedron defined by 4 adjacent unit-radius spheres of volume one.

## 2.20 How to communicate synergetically?

[From Kevin Sahr]

[Synergetics] seems to have the potential to be used as a mathematical basis for "communicating experiences" or for otherwise describing them in a precise way.

Though I agree with this in principle, I've never seen anyone actually use it for this purpose. For instance, can anyone out there right now communicate an experience to me using Synergetics? Even a "toy" example would be useful for discussion, but I'm thinking more along the lines of communicating some unique thought/constellation of thoughts to me; something that could not be well communicated using ordinary english sentences, but which would be unambiguously communicated to me by a set of geometrical relationships that, say, could be stored in a computer.

[From Chris Fearnley]

I think these synergetics explanations are not meant to replace ordinary english, but to supplement it. I think when you start (perhaps even at a metaphorical level) to examine the complex of interrelationships in an



``english" story, you find deeper meaning. The synergetics patterns are there but our minds CAN (are capable of) dealing with these synergetics patters at an ``unconscious" level. By trying to enumerate the precise geometry, you slow the normal geometric patterning - break the flow of thought. I suggest that by awareness of the inherent synergetic side of thinking, we can (as sort-of a side effect) find new relationships and understand more deeply the (initially obscured) relationships inherent in your ``story." In other words synergetics probably does not supply a (logicians') decision procedure for unfolding a story, but rather a ``mystics" science for appreciating relationships which before synergetics would have been left outside of cognition realization. In this synergetics science previously ``impossible" ideas can become clear. Now you asked for an example of synergetics' application to understanding stories. Perhaps a new paragraph is in order?

Just some random thoughts. Antivirals may cure AIDS: AZT may be the answer! Well, synergetics suggests that we need to find ALL the relationships involved in our subject of concern. So we must look at the whole system. We now discover that the human body is chock full of viruses and bacteria. So it becomes clear that just by fighting the viral component of disease, we may be missing some vital components of disease. Perhaps AIDS is not a bad virus, but a ``good" virus that through some co-factor some problem develops that is unrelated to the actual viral mechanisms. In sum, by looking at all the factors and keeping a clear sight of inside-outside phenomena, we can begin to appreciate that the AZT craze of recent years, may be too simplistic a view of the situation. So with recent reports suggesting that AZT is mostly ineffective in improving the quality of life of AIDS patients. In conclusion, because synergetics asks us to consider the WHOLE complex of factors in inside-outside relationships, a disciplined thinker can be more skeptical of false eureka's and more sober when the false theories of yesterday are debunked. English's problem is that it doesn't provide the discipline of thinking that synergetics demands.

Hope that helps.

[From Kevin Sahr]

I agree that synergetics is important in the role you give it in your discussion and example, but I think reading Synergetics makes clear that Fuller was very much interested in ``trying to enumerate the precise geometry." Synergetics consists of the types of principles you point out (i.e., look at the whole system, etc.), but it also consists of some very precise geometric statements (ie., the A-module break-down of the tetrahedron mentioned in the original post). So I guess I might re-phrase my original question: can anyone give me an example similar to Chris' AIDS example but applying, say, anything having to do with A and/or B (or, even T & E Quanta :-)) modules? Or maybe (a little bit less esoteric) the Jitterbug?

[From Kirby Urner]

Is Synergetics actually useful for communicating experience? Fuller's writings suggest how bare bones Synergetics supports fleshier metaphors in Critical Path and Grunch of Giants -- Fuller considered them all one magnum opus, viewed from different angles.

The non-simultaneity of only partially over lapping events, some far apart in time and space, makes the tuning in of relations among these events a discipline. Fuller felt he was revealing some of these larger patterns in Critical Path. I find many of his visions tough to swallow, but that's another conversation. Like, where's the evidence for submarine aircraft carriers?

Since reading Fuller, I've done mental gymnastics to ``feel" myself driving on the surface of a planet, stuck on by gravity, but not oriented in an up/down Universe. Once in New Mexico, a felt I was hanging upside down (my driving was unimpaired).

More, though, it's the word building associations, lying in the dark thinking of all the metaphysical communications going around the world (networking, diplomacy, broadcasting, satellites, telephone, exchange programs, advertising) as a circumferential countering of more physical explosions of violence (bomb blasts, big and small, gun fire). Not that some communications, such as inflaming of nationalist, racist sentiments and xenophobia, aren't also conducive to violence (wrong picture to think of communication as intrinsically

beneficent -- can be entropic in the extreme).

As for whether "precise" or "refined" synergetics, using A & B mods etc, is useful for communicating experience... well, to communicate precise geometric models and pictures certainly -- my ability to visual the face centered cubic lattice of crystallography, and to understand the design of geodesic spheres and the dymaxion map certainly owes a lot to synergetics. But I think Kevin's question is more about whether electronics, molecular physics, quantum mechanics or the like may be illuminated by geometric descriptions -- is a kind of "narrative mathematics" possible, in which your read "hard science" information more the way you read english syntax, than reading the usual mathematical symbolry? Fuller makes many attempts to talk about quanta, electron orbitals, energy transfer, stellar mechanics, using his language. I think we know what such narrative, or operational mathematics might look like. The question is whether these models have any experiential validity. Part of the problem, as Fuller saw it, is that geometric modeling of the physical world fell out of favor some decades ago, when the math left experiential visualization in the dust. So getting back to geometric models is tough with or without the help of a geometric narrative-style language.

[From Chris Fearnley]

Synergetics is subtitled "Explorations in the geometry of thinking" - not explorations in the geometrical shape of an idea, argument, discussion. Fuller's geometry is very dynamical. It shifts even more quickly than science's theories about the origin of life on Earth (grin). So if I understand correctly, you're asking for an example describing how an intertransforming isotropic vector matrix pulsating through it's full periodicities (with A and B models as an integral part of the whole apparatus) can model the evolving process of "casting out irrelevancies" to focus thinking more-and-more on the system in question (the requested example). I think this would be impossible to do in a general fashion. Perhaps one could examine their own thought patterns carefully enough to see which thoughts correspond to which A-Module pulsations, but I think this would be difficult especially given the fact that by examining the process of our thinking we alter it in unpredictable ways. I think Fuller's theories on the dynamics of thinking can only be "proven" with high-level, fundamental reasoning w.r.t. the nature of the geometry itself and its "uncovering" of the mysteries of thinking (the process, the verbs not the nouns). By exploring the fundamental logic of the basis of thinking in Synergetics, I convinced myself that in general Fuller is "right on the money," but I have been unable to apply his work in the static way in which you would like to see it. (See Fuller's essay "Omnidirectional Halo" in *No More Secondhand God* which is the essay which when "unfolded" turned into *Synergetics*.)

[From Kevin Sahr]

Again, I think this kind of thing is important, but "geometric modeling of the physical world" is not what I was getting at - what I'm after is geometric modeling of the *metaphysical* world, the world of mind. A lot of people are interested in Synergetics as throwing light on things which fall within the realm of the hard sciences (ie., molecular configuration (Buckyballs), civil engineering (octet trusses), etc.), and certainly I think Synergetics will repay any time spent with it by practitioners in those fields. But, to come out of the closet, my own interest is in mathematical models of how we think (and how we might think more effectively!), specifically those models which are computer programmable. I think that Bucky saw Synergetics as very relevant to that type of "science," and I think he would have claimed that that relevance extends even to the more mathematically esoteric elements of his theories. I'm just trying to figure-out what that relevance might be!

By the way, I'm not claiming that Bucky himself always saw such a relevance in all of the "generalized principles" he discovered; often I think he was just cataloging such principles in hopes they might be useful to someone in the future. But I *am* claiming that I think Bucky would have argued that there *must* be some such relevance for all these principles. And I think it's clear that he saw relevance in areas that I do not yet.

Again, to turn to the concrete. I apologize for not having the exact quote in front of me, but Bucky wrote in Synergetics something to the effect that the Jitterbug recapitulates the phenomenology of all experience. In what way is this true? If this is so, then shouldn't it be the case that we could take any experience (including any thought or line of thought) and in some sense map it onto the Jitterbug?

[From Leo Elliott]

Interesting discussion on the nature of synergetics as science, as linguistics, and how Bucky may have conceived their pattern-integrity. Interesting enough to make me pull out some ancient transcriptions of a 1976 "Being With Bucky" gathering out in SF...

Like Kevin Sahr, I must confess that, as a non-scientific type, the appeal of Synergetics always seemed to come more from the notion, implied or explicit, that all Bucky's perusings and perambulations pertained at least as much to the metaphysical as to the physical, that somehow 'thought' itself was structured in the form of A and B quanta modules, or their equivalents... As a former devotee of *The Urantia Book* I used to get quite excited about all the triadic expressions of 'universe reality' presented therein, things like "thing/meaning/value" or "fact/idea/relation" or "origin/nature/destiny," an attraction I now view as part of a basic rhetorical appeal that somehow reinforced, in a starry-eyed-seventies way, Fuller's own novel rhetoric.

I suppose that if the 'return to modelability' that Bucky spoke of was part of his life enterprise, then perhaps a first step was a 'return to speakability' -- and as any hereon who may have been fortunate enough to hear Bucky live (for me only once) may attest, it was an experience of sitting on the edge of my chair for three hours, straining to keep up with the thinking of a man three times my age, and at the end of which left wondering if perhaps Bucky weren't receiving some kind of alien transmissions through his hearing aids. I still had that feeling when listening to these tapes again, almost twenty years down the road.

Is it fair to say that Bucky's written grammar and syntax was at least as complex and intricate as his oral presentation? I know Bucky took a lot of flak from those whose eyes glazed over after the same sentence went longer than two minutes or twenty -or-so lines, but somehow whenever I tried to find any grammatical or syntactical error(s), none showed up, and while I never actually did so, I had the feeling that one could even diagram his sentences. There is a great photograph in E.J. Applewhite's *Cosmic Fishing* which shows a page of galley proof, supposedly ready to go to press, which Bucky had filled the margins of with corrections and revisions, never being content with saying something, on paper or in person, just the way he had said it even the day before.

So in answer to queries for metaphysical specimens of synergetics, I can only think of Fuller's written works, and his oral presentations as such have been preserved in various archives.

I also believe Bucky spoke of his 'prayers' being different every day, and how "it also seems illogical to remind God of anything." If any are interested I have a version or two of at least one specimen of the Bucky-version of the Lord's Prayer, which at least on the tape -started out- as an "our father" type soliloquy, but which in typical fashion mutated several paragraphs later into something else. I attach below my own specimen of fullerspeak, written in the best syner-linguistics I could muster.

Is it also fair to say that Bucky's speaking and writing styles were as close to identical as any rhetoric in the collective recollection?

Our tetrahedron  
who art in geometry  
hollowed by thy concavity  
thy convexity come  
thy system be dome  
on Urth  
as it is in Universe.  
Give us this eternity  
our daily integrity  
and fore-give us our dis-integrations  
as we fore-give those  
who dis-integrate around us.

And lead us only in -- to synte-gration  
and de-livery us from entropic monofocus  
on material self-interest  
universe within Universe  
amen.

lhe

13 May 1977

## **2.21 Modeling suggestions?**

[From Clif White]

Try this the next time you have some time, newspaper, a dowel and some masking tape.

All that newspaper laying around your house can be made into large structures that are surprising strong as well.

Simply roll a sheet of newspaper around a 1/2" dowel secure the end of the roll with a bit of tape and slip out the dowel and then repeat procedure to make another strut.

Using your stock of newly created struts, secure the ends to form joints using more masking tape. (Don't use a lot of tape at the ends.) Form triangles and then tetrahedrons along with octahedrons and you will begin to make a large scale octet truss system that will quickly fill up your room.

You will be amazed at how strong this system is!

This is a great activity for a bunch of kids. You can make all sorts of polyhedra quickly and cheaply. A production line of strut makers, and joiners can really pump out the structures. My kids love this activity.

[From Christopher Rywalt]

The other day I was wandering through Star Magic -- another one of those science toy-type stores -- when I was about to complain that I never could find anything very interesting in such a store. Just as I began to speak, however, my friend said, ``Sure, you play with the useless stuff and walk right past that thing you've been looking for for months." And he pointed me at a little kit called a Vector Flexor. I don't know how many of you have run into this, but its rather neat. It's basically colored sticks and rubber tubes, and the rubber tubes can be assembled into an X shape and the sticks stuck into them to make a vector equilibrium. It's pretty cool, because it can be made to jitterbug and it comes with a pretty detailed insert explaining what it is and even refers the buyer to several of Bucky's books.

[From Mitch C. Amiano]

I note that, in Fuller's Octetruss patent, there is an implementation disclosed in which the struts are formed by the overlapping edges of aluminum triangular plates with 3 flanges. I tinkered with an alternative (overlapping faces & flanges) form of the same thing in paper. I decided that with a few extensions and mating pieces it could be a real modeling kit; the major drawback being that the paper models were not self-aligning like plastic or metal formed plates would be, so large models tended to show signs of twisting.

I then took some empty 1-gallon polyethylene water containers, stripped the labels off, cut off and layered the flat sides, and melted them together carefully in a 375-450 degree oven, to get a ~1/8th inch thick laminated sheet. I cut and shaped a plastic prototype of an octet plate of my revised design. It's about 3cm high, and looks pretty neat - but I think my wife would get X-( mad if I do it again soon: melted polyethylene smell even with the fans on and windows open.

## **2.22 What applications of synergetics are being discovered?**

Here I want to include references to work that shows how useful Fuller's synergetics ideas are and have been - To persuade the skeptical :)

[From Ed Applewhite]

Satellite sensing data displayed for first time on geodesic triangular-tetrahedral grid

``Scientific American." (January 1991) reported that researchers at the Los Alamos National Laboratory turned a technique for modeling explosions into one that simulates climatic change.

``It relies on meshes made of half a million tetrahedrons. . . .Every tetrahedron covers an area no wider than 30 kilometers. . . . In the event of a disturbance such as a hurricane, these meshes would twist. Conventional models which use rigid meshes of rectangular bricks, typically lack the resolution to portray such comparatively local phenomena." (The graphics accompanying this article demonstrate the kind of applied geodesics that Buckminster Fuller had in mind.)

## **What is Kirby Urner's storyboarding concept?**

[From Kirby Urner]

What'd be nice to have is a large inventory of artfully produced synergetics clips *in the public domain* which personal workspace enthusiasts (e.g. me) could inload, edit/recombine, and outload to the network. Over time, we'd build up quite a library. In the short term, I don't think Internet is the place to communicate these high bandwidth scenarios so much as a place to verbally fantasize them or give info about how to get them through other channels (e.g. the mail). Most realistically, I think a CD-ROM of Synergetics Clip Art, stills, short animations, pictures of artifacts, inventions, Bucky's prose and poetry, who's who contact lists etc would be the ideal evolutionary tool to galvanize the incipient Design Scientists among us to get to work. As the dial-up and downloading of visual video clips becomes more available, then we can move our collection to a more public archives.

Again, I think these metaphysical assets should be public domain (even though the CD-ROMs themselves will cost) to encourage users to incorporate them freely into works of their own, and to upload these for downloading by others in turn, and so on. That'll be the metaphysical/fantasy part: out in the real world, we'll be sharing our storyboards with TV producers to get Hollywood-style storyboards enacted big time, on a bigger scale. Any mass infusion of domed domiciles would be televised for sure.

Best to work with the entertainment industry from the inside out, rather than expecting Design Science to take off on the side some place, and have TV news people come running to ``the scene." No. The Design Science revolution will start right in the studio, when the map behind Dan Rather's head stops looking so stupidly distorted.

## **2.23 Is it possible to develop an operational pi?**

[From Mitch C. Amiano]

I am trying to develop a procedure for giving the ratio of the circumference to the average radius of certain circle-like polyhedrals, as a function of the number of outer chords on the polynomial edge. The constraints I have (arbitrarily) placed require that the polyhedron be formed by a whole number of equivalent triangles placed about a center point. The triangles have (at least) two identical edge lengths (of unit length) which are the radii of a circle circumscribing the polyhedron, and one (outer) edge in common with the formed polyhedron.

As an example: for a hexavertexion (hexagon) with an outer radius of 1, there are six equivalent triangles which happen to be equilateral; the outer edge also has a length of 1. The frequency of subdivision is 6 (the number of outer edges). The average diameter is  $1 + \sqrt{3}/2$ . The approximation of pi for this case is  $6/[1 + \sqrt{3}/2] = 3.2154\dots$  which itself is irrational, but at least it seems to have some relationship to the polyhedron.

[From Robert L. Read]

From the formula for regular polygons in *CRC Standard Mathematical Tables*, Edition #27, page 122, the inner radius of a regular polygon (the radius of the inscribed circle) is  $(r = 1/2 * s * \cot(180/n))$ , where  $\cot$  is cotangent,  $n$  is the number of sides, and  $s$  is the length of the chord on the outside edge. The radius of the circumscribed circle is  $(R = 1/2 * s * \csc(180/n))$ , where  $\csc$  is cosecant. Since the circumference of the  $n$ -gon is  $(n * s)$ , we can write the ratio of circumference to ``average radius'' (if you mean by that, as you apparently do, the average of the maximum and minimum, which is not obviously the same as what you would get by calculating the average over an infinite number of rays via calculus, but it might be) as:

$n * s / ((r + R) / 2)$ , which by algebra is equal to

$2 * n * s / (r + R)$ , which by substituting the above formulae is,

$2 * n * s / (1/2 * s * \cot(180/n) + 1/2 * s * \csc(180/n))$ , and so the  $s$ 's can be crossed out of the top and bottom and we get:

$2 * n / (0.5 * \cot(180/n) + 0.5 * \csc(180/n))$ , which is a function only of  $n$ , which is what we desire, and can be cleaned up to:

$4 * n / (\cot(180/n) + \csc(180/n))$

which, since  $\cot$  and  $\csc$  are kind of a pain we can replace with  $\sin$  and  $\cos$  via identities that we should all remember but happily can be found on page 135 ( $\cot x = \cos(x) / \sin(x)$  and  $\csc(x) = 1/\sin(x)$ ).

Then with a little more algebra we get the easy-to-use-if-you-have-a-calculator formula:

$\text{circumference} / \text{av. radius} (n) = (4 * n * \sin(180 / n)) / (1 + \cos(180/n))$

And, BTW, it works, I checked it at a few values.

[From Kirby Urner]

Nature is not using PI, nor are humans (part of nature). All computer-based and calculator-based representations of PI are truncated to the number of digits internal storage permits. Even those gazillion digit Cray monsters terminate (and besides, are not used in practice in any calculations). Bucky's argument that nature does not use irrational numbers is pretty straightforward: you have never used an irrational number in your life: all computations with root-of-two, pi, e and so forth are definite, terminated. We call them ``approximations'' just as we say all lines are ``approximations'' of perfectly straight ones. Bucky simply starts with what's right in front of us, in our everyday experience, and says ``not approximations of anything, this is what simply *is* -- no perfectly straight lines and no ultimate value of PI actually exist or gets used for anything in nature."

...

So are we agreed that what Bucky was advocating was a `grainy-pi' using a super scheherezade number with tons of primes folded in? Like, the Babylonians chose 360 because of its easy divisibility. People came up with `Grads" (on most calculators) dividing the circle into 100 degrees -- for the true die-hard decimal-heads. So Bucky, in true Babylonian fashion, but acknowledging the new level of computing power we've attained, suggested replacing 360 with a number with a great many more primes worked in. The idea would be to then generate a table of trig functions that always `came out" to some rational number. The whole set-up would be `grainy" but I think it was Bucky's contention that we would find such a system to be sufficient to cover nature's `scalables" -- i.e. we would have a rational trigonometry of enough accuracy to do subatomics, architecture etc.

I have no clear understanding of what it would look like to carry this out in practice. Sounds like a job for a computer language. My question here though is: does anyone have a different understanding of what Bucky meant? And, yes, what about the phenomenal utility of such numbers as e, sqrt(2) etc? Although here, again, my earlier assertion is relevant: our computers only carry out our symbols to a finite number of numbers for crunching purposes in any case, so the question `can we get along without computing with nonterminating irrationals?" is moot in any case -- we get along fine right now.

[From Mitch C. Amiano]

Given that there is no infinite precision in practice and in Universe, we must decide what precision to use. The most common approach is to just use however many digits our calculator gives us, which is usually too many, and get a bigger calculator if its not enough. Generally, the precision we need is determined by the size of our bolt-holes and the elasticity of the materials we're working with.

For any working environment we could define a necessary precision (higher for steel than wood, higher for wood than plastic) and develop tables of fundamentals values, such as the ratio of circumference to diameter for an n-gon, expressed as fractions in simplest form that would be accurate enough for that application. (The decimal expansion could be used, but often we would find much simpler fractions that are accurate enough.) This would have a certain pleasing simplicity, but, on the other hand, it has no really obvious advantage over an over-precise description. However, it seems worth investigating, because if some pattern could be detected, then we would gain not only an engineering tool, but a tool for understanding, which is one of the wonderful things about many of Fuller's inventions.

[From Vincent J. Matsko]

It is possible, beginning with a hexagon, to perform the `irrational" approximations [to pi] by doubling the number of sides each time (rather than increasing by one) so that the appropriate half-angle formulae may be used to calculate sines and cosines without any knowledge of pi.

Re: The practicality of pi: I have done quite a bit of solid geometry (Fuller was inspirational for me), and I have never had occasion to use pi. I think the natural choice of `unit" for angles to be `revolutions," thus the range 0-360 degrees is just the range 0-1. Now these numbers are `dimensionless," being interpreted as the fraction of the area of a circle that the sector cut out by the angle occupies.

Now let's take the discussion to three dimensions. We wish to have a measure of solid angle so that we may discuss spacefilling ideas. So define the measure of a solid angle to be that fraction of a sphere (centered at the vertex of the angle) cut out by the solid angle. If A, B, and C are the measures of the dihedral angles of a solid angle, and the measure of the angle is  $\frac{1}{2}(A + B + C - 1/2)$ . Example: Take the corner of a cube. Each dihedral angle has measure  $\frac{1}{4}$  (i.e., 90 degrees). So the measure of the solid angle determined by a corner is  $\frac{1}{2}(\frac{1}{4} + \frac{1}{4} + \frac{1}{4} - \frac{1}{2}) = \frac{1}{8}$ . Now in a cubic packing of space, 8 corners of the cube meet at a point, so it makes sense that each corner should occupy `one-eighth of the space" about the vertex of that corner. (This formula for a solid angle is derived from a standard result (in the CRC, e.g.) for the area of a spherical triangle by changing the units to revolutions and by dividing by the surface area of the sphere in question (so as to yield a ratio rather than an `absolute" area).)

As far as a generalization goes: (1) for an n-hedral angle with dihedral angles  $A_1, \dots, A_n$ , the formula for the

measure of the solid angle is  $1/2(A_1 + A_2 + \dots + A_n + 1 - n/2)$ , which reduces to the above for  $n = 3$ . (2)  
 However, in higher dimensions, there is no simple formula. Coxeter addresses the issue briefly in his *Regular Polytopes*, where he includes a formidable 4D formula derived by Schlafli. It's really rather nasty looking, if I must say.

Thus, we may talk of solid angles in 3D without needing to bring in pi, the results being, I believe, more geometrically intuitive. And, being that Fuller's rather discrete geometry really never concerns itself with circles or spheres (I suppose excepting sphere packings), pi is not really needed.

[From Kirby Urner]

I've come up with an algorithm for deriving pi that uses no trig, just Pythagoras. Involves filling a unit circle with a fractal pattern of similar triangles, thereby approaching pi as an *area* (vs circumference). The algorithm is easiest expressed as a short computer program:

---

```

-----
pi=2
hypot=2^0.5
FOR n=1 TO 30
    height=1-(1-(hypot/2)^2)^0.5
    newhypot=(height^2+(hypot/2)^2)^0.5
    newarea=1/2*height*hypot
    pi=pi+2^(n+1)*newarea
    ? pi
    hypot=newhypot
ENDFOR
-----

```

The output of which (from the line reading '? pi') reads:

```

First 5 terms:
    2.828427124746190000
    3.061467458920718000
    3.121445152258052000
    3.136548490545939000
    3.140331156954753000
    <stuff deleted>

```

```

Last 7 terms:
    3.141592653589789000
    3.141592653589793000
    3.141592653589793000
    3.141592653589793000
    3.141592653589793000
    3.141592653589793000
    3.141592653589793000

```

---

As you can see, I reach the limits of my computer's accuracy (using this particular programming language) at about 25 iterations.

There's some specific geometric reasoning that led to this algorithm of course, which involves starting with an inscribed square (2 triangles) and successively bisecting outer edges (hypotenuses) to create a series of smaller



and smaller similar triangles pushing into the unfilled arc regions. As the triangles get smaller, their numbers multiply exponentially, hence the fractal-like (self-similar) nature of the algorithm.

Inscribe a square in a circle. Now imagine the mid-edges of the square moving out to touch the circle, making 4 triangles using each of the square's edges as a base. Now have the outer mid-edges of those new triangles move out to the circumference again, making more, smaller triangles. Repeat until the computer runs out of significant digits.

This is not a picture of a pie with narrower and narrower slices, all converging at the center. It's a pie with big sections at the center and smaller and smaller ones pressing out towards the edge of the circle.

This method may have already been published many times, but I derived it from scratch I'm proud to say.

I've further simplified, or at least re-expressed, an algorithm for generating pi without using trig functions.

Those interested should rewrite using conventional notation. [] means subscript. ^ means "raised to power" e.g. 2<sup>0.5</sup> means "2 to the one-half" or "2nd root of 2." SIGMA means one of those Greek summation symbols (just a fancy symbol for a programmer's DO-loop)...

$$(1) \quad h[0]=2$$

$$(2) \quad h[i+1]=(2-(4-h[i]^2)^{.5})^{.5}$$

$$(3) \quad \text{pi}=\text{SIGMA}\{(2^i)*h[i]*(1-1/2*(4-h[i]^2)^{.5})\}$$

where (i=0,1,2...)

[Expansion]

$$h[0]=2$$

$$h[1]=\text{SQRT}(2)$$

$$h[2]=\text{SQRT}(2-\text{SQRT}(2))$$

$$h[3]=\text{SQRT}(2-\text{SQRT}(2+\text{SQRT}(2)))$$

$$h[4]=\text{SQRT}(2-\text{SQRT}(2+\text{SQRT}(2)))$$

$$h[5]=\text{SQRT}(2-\text{SQRT}(2+\text{SQRT}(2+\text{SQRT}(2))))$$

...

$$h[n]=\text{SQRT}(2-\text{SQRT}(2+\text{SQRT}(2+\text{SQRT}(2+\dots))))\dots$$

The above succession of terms derives from

$$h[0]=2$$

$$h[i+1]=\text{SQRT}(2-\text{SQRT}(4-h[i]^2))$$

Another way of expressing the continued radical:

$$i=0\dots n$$

$$k[0]=0$$

$$h[0]=2$$

$$k[i+1]=\text{SQRT}(2+k[i])$$

$$h[i+1]=\text{SQRT}(2-k[i])$$

In other words, you start with h[0]=2, then plug that in to the left side of expression (2) to get h[1], plug h[1] in to get h[2] and so on. Expression (3) is a summation of terms indexed on i where i=0,1,2,3,4... and so on, as long as you want to continue. Note the term 2<sup>i</sup> -- a successive doubling with each new term in the series, reflective of the doubling number of smaller and smaller triangles, the area of which is provided by the next two terms (a base\*height expression).

I've also simplified the computer program a bit:

---

```
area = 0
hypot=2
FOR n=0 TO 25
    height=1-(1-(hypot/2)^2)^0.5
    area=area+2^n*height*hypot
    hypot=(height^2+(hypot/2)^2)^0.5
ENDFOR
? area
```

---

After 25 iterations, area should = pi to 15 decimals.

[From Kiyoshi Kuromiya]

I thought I would share part of an article ("Cosmic Noise") by George Johnson in today's New York Times (7/9/94):

"In trying to construct a science of science, people like Dr. Chaitin and Dr. Landauer are questioning some of the deepest assumptions of their craft. Since Newton, scientific laws have been expressed in the form of differential equations, which have exact solutions, and with the so-called real numbers, which can be expressed as infinitely long decimal expansions. Pi equals 3.14159 ....

"In practice, science inevitably falls short of this ideal of infinite precision. In quantum physics, the simplest atom--hydrogen, with one proton and one electron--can be described precisely. But the equation for the helium atom, with its additional proton--is intractable. We must make do with good approximations. Estimates of the size of the shards of the Shoemaker-Levy comet vary so widely that some scientists predict there will be no measurable impact on Jupiter at all.

"Science has long operated on the assumption that space is continuous, with infinitely many points between two marks on a line. Mathematicians have calculated pi beyond a billion decimal places. But 61 decimal places are enough to describe a circle girding the visible universe with a deviation of less than a single Planck length--a unit 10-to the twentieth power (1 followed by 20 zeroes) times smaller than a proton. This seems as close to perfectly circular as a real circle can be. Do the rest of the decimal places have any meaning?

"The mathematician Herman Weyl once said that the belief in an infinite continuum of numbers `taxes the strength of our faith hardly less than the doctrines of the early Fathers of the Church or the Scholastic philosophers of the Middle Ages.'

"Few scientists are ready to abandon differential equations and real numbers for the more realistic mathematics Dr. Chaitin is proposing. but in seeking a foundation for science, everything is up for grabs, including the universality of mathematics.

"For centuries philosophers have debated whether mathematics is invented or discovered. Taking a middle ground, the 19th-century mathematician Leopold Kronecker declared, `God made the integers; all else is the work of man.'

"Einstein, it seems, went even further. Even the integers, he wrote, are obviously an invention of the human mind, a self-created tool which simplifies the ordering of certain sensory experiences."

## **2.24 What are Koski's and Kajikawa's modules?**

[From Kirby Urner]

David Koski is a master of the self-similar tetrahedron fractal. He uses the golden ratio (phi -- not pi) to scale T modules. Phi-scaled T-mods of various sizes actually pack together to make cubes, icosahedra and other 5-fold symmetric solids. Even more shapes may be made if variant modules, each assembled from 6 of the 7 unique edges of the golden cuboid\* are admitted to the phi-scaled building-block inventory.

Yasushi Kajikawa of the Synergetics Institute in Japan has a competing module set for assembling 5-fold symmetric shapes, and a hypercard stack for the Macintosh to show how it works. Kajikawa's work was actually published in Scientific American (Japanese edition only) whereas David Koski's work is as yet unpublished.

The literature of module sets, finding a minimum inventory of building blocks for assembling a wide variety of shapes (ala Fuller's Mite, KYTE, SYTE discussion) is fairly large. There's that dome architect from Iceland who's into it, and that book on particle physics which tries to model quantum mechanics using polyhedra (Fuller pushed in this direction of course).

## **2.25 What is Richard Hawkins' curVE model?**

[From Richard Hawkins]

I have made a model based on the Vector Equilibrium using quadrants (90 degree arcs) in place of straight lines. Visualize a cube with circular faces. All of the circumferentials (no radials in this model) are equidistant from the center of gravity; facilitating motion. View the model as 4 groups of 6 quadrants each forming "circuits" analogous to the 4 hexagonal components of the VE (cuboctahedron). Locate a rotating armature (straight-line structure) with its pivot point at the center of gravity and ends at opposing points on one of the 4 "circuits." (I have used 4 different colors to help differentiate these in the model.) Animate the armature to make a complete revolution (keyframes at the beginning of each quadrant) around each "circuit," alternating continuously through the 4 different axes of rotation (4-D). Grouping another armature at 90 degrees centered to the first produced a surprising (to me) result. For each revolution around a "circuit" by the first armature, the grouped armature tracks opposing spherical triangles twice. It bobs and weaves! Sorry if this verbal description is not easy to visualize.

One picture of this model is available by anonymous ftp [switchboard.ftp.com/bucky/curVE.jpg](ftp://switchboard.ftp.com/bucky/curVE.jpg).

## **2.26 Fuller's Synergetics and Sex Identity.**

[From Chris Fearnley]

In the Humanities Citation Index I found an article by Prudence Allen, R.S.M (Concordia University) in International Philosophical Quarterly 32(1):3-16 entitled "Fuller's *Synergetics* and Sex Complementarity."

The article had several very interesting features. First, she provides a test-case example of Fuller's principle that the minimum conceptual system is structured tetrahedrally.

Concept of Male Concept of Female Description

=====  
first vertex: male female Primarily Biological second vertex: masculinity femininity Primarily Psychic (cultural) third vertex: femininity masculinity " fourth vertex: man woman As individuality

Allen argues that this tetrahedron of Male and Female is both historically and philosophically tantalizing (if not valid).

Second, Allen looks at Fuller's concepts of complementarity and parity (and implicitly the concepts of system, integrity, events, inter-relationships of events in a system - well, basically the whole of Fuller's epistemography) in application to sex identity. She also evaluates several of Fuller's references to male-female complementarity (*Synergetics*: [1210](#), [511.12](#), [1076.11-12](#), [1024.15](#), and others). She quotes Fuller's article "Goddesses of the Twenty-First Century" in *Saturday Review* 14:(2 March 1986). (Has anyone seen this article?)

"Women are tensional and continuous. Each new female as well as male life comes from the womb of the women. We have, then, the new female life as a series of expanding waves, the new ever emerging from within the older wave. Women are continuous. ...

"Males are discontinuous. The new life is noncontiguous to the previous male life. Men are, then, islanded, individual discontinuities."

Finally, I noticed that Allen's article is a very interesting piece of scholarly applied synergetics and synergetics' philosophy. She really understands Fuller's philosophy of systems and its inherent complementarity, parity and synergy. Her only real criticism was that Fuller didn't take the next step to viewing man as a person in community and woman as a person in community. Although I don't recall any references to a philosophy of humans in community in *Synergetics* (besides the electronic voting), I think we need to review Fuller's essays in *Ekistics* before we can safely claim that Fuller didn't develop any specific thinking regarding communities. Overall, this is a good read for the Fuller scholar looking for philosophical applications to synergetics.

[BTW, there is another philosophical essay by Derek A. Kelly "The Philosophy of R. Buckminster Fuller" in *International Philosophical Quarterly* 22(1982): 295-314. This long essay disappointed me as the author does not seem to have integrated all the pieces of Fuller's philosophy. Well, in my opinion (based on a very cursory examination) Kelly didn't comprehend the full meaning of Fuller's concepts. I'll have to read this one more carefully before passing final judgment.]

## **[2.27 Tips for reading \*Synergetics\*.](#)**

<http://www.cjfeanley.com/synergetics.essay.html> provides some tips for reading *Synergetics*.

---

[Next](#) [Previous](#) [Contents](#)

## **3. Fuller's Ideas About Human Society: Critical Path**

Fuller was interested and made contributions on a wide range of issues in the area academics call the "social sciences". Much of this work addressed economics. He published several studies of industrial trends. There was the famous 1940 issue of Fortune magazine which he inspired. In the 1960s the [Design Science Decade Documents](#) were published. Fuller advocated the principle of "ephemeralization" or doing "more with less." Fuller founded the world game which explores the task of making the world work for 100% of humanity. His major publications in this area are *Critical Path* and *Grunch of Giants* wherein he also gives a unique perspective of the history of humans on Earth.

### **3.1 What is the Design Science Revolution?**

The "Design Science Revolution" references Fuller's program of applying the principles of science to solving the problems of humanity in an aggressive, anticipatory and comprehensive manner. The principle of ephemeralization shows we can accomplish more and more functionality with less and less energy, material and time investment, "we are now able to do so much with so little that we can provide for the basic needs of 100% of humanity without disadvantaging anyone." In contradistinction his "archenemy," Obnoxico Inc., which tries to make money out of thin air (or rocks) with little or no appreciable benefit to humankind. Fuller suggests that by taking the design principles of Universe (as described in *Synergetics* and elsewhere) and our consciously developed values, we can emerge from the present-day "dark ages" and prosper like never before in history.

Pat Salisbury has an excellent web page describing [Comprehensive Anticipatory Design Science](#).

### **When will the Design Science Revolution begin?**

[From Chris Fearnley] The Design Science Revolution has *already* begun

During the 1980s, under the smoke screen of republican conservatism conveniently provided by the mass media, large numbers of individuals and groups have begun to organize the resources available to them to understand the world and begin the process of working for 100% of humanity. Here are some events that suggest that Earth may be entering the design science revolution as predicted by Buckminster Fuller: World Game grew to be an Institute, World Resources Institute was formed (c. 1982), The World Watch Institute began publishing a yearly State of the World Report, home computing explodes in numbers and quality and became ubiquitous, BBSing becomes an institution for intercommunication,

[From Unknown]

Some of my colleagues have been doing realtime strategizing where NEWIDEA="global design science revolution." Fuller's hypothesis was that lag times in social acceptance of new artifacts is a function of a natural gestation rate associated with different technological arenas e.g. novelty electronics proceed from drawing boards to end-users in a matter of years, whereas adoption of fundamental changes in household architecture is measured in decades. Obviously changes occur along different scales (geologic thru atomic). Some NEWIDEAs come with glacial-paced agendas that no amount of cleverness in strategy will accelerate beyond a top limit.

[From Kirby Urner]

Storyboarding for Design Science Drama: Some Pro-Net Propaganda by Kirby Urner June 12, 1994

In *Grunch of Giants*, Bucky Fuller cast the community of networkers in the role of David versus the supranational corporate Goliath. As in any good tale, the archetypal opposition (compression) provides a foreground plot against a contextual background of eternal principles (tension). Behind the scenes we ever rediscover what teachers call "the

unity of opposites." David and Goliath are two aspects of the same psyche. We have met the enemy and the enemy is us.

The Internet is abuzz with rumors of huge conglomerates positioning for an all-out invasion. The funky, free and informal usefulness of a shared, non-hierarchical, decentralized, self-monitoring culture will be conquered by a culture of greed and aggressiveness. The world of commercial television, which has already invaded public schools, will storm into our peaceable kingdom to haul us as slaves in chains before our new corporate masters. We shall once again be cast as consumers of dumbed down infotainment carefully purged any content that might offend the sponsors. Everything will cost, nothing will be reusable or recopyable, and stories of these carefree days will be as legends in the ears of our children. The evil Grunch will have won.

In Bucky's tale, the now omnipresent computer is on the side of Good. The global financial number cruncher keeps crunching away and crunching away and always comes up with the same surprising answer: we humans now, today, have the requisite physical and metaphysical assets in inventory to stage a great world play about the coming of age of our species. Late night religious broadcasting of the hopeless poverty in our world, ever in need of our guilt-derived dollars, might be supplanted by a new kind of program about actually ending death by starvation -- forever. Props in our new world dramas: domes hanging from helicopters; graphical dymaxion map displays; computer monitors aglow with designs for livingry, ready for distribution on a massive scale, instead of killingry, (already massively distributed).

What Bucky hoped is that our youthful, globally networked generation, so full of promise, would stand up to the onrushing Goliath. He encouraged us to look at lawyer-capitalism's (LAWCAP's) shareholder enterprises as ghost ships on automatic pilot, the great pirates who once steered them having long ago passed from the scene. Crews of bewildered and superstitious bureaucrats still go through the motions, reciting their mindless mantras passed on as wisdom. But LAWCAP's big picture accounts, steeped in Dark Ages obfuscation and contrived to sound paternal and profound, are becoming less and less a source of comfort in these uncharted waters. The crew members are beginning to awaken to the reality of their situation. They cling to our nets for survival.

Bucky knew the limited liability, legally irresponsible, soulless creatures of LAWCAP's accounting hadn't the humanity nor intelligence to navigate successfully in cyberspace. LAWCAP reflexes are all out of synch with what world game positions now need filling. The you-or-me never-enough-for-both great global tragedy is swiftly losing market share. Hollywood-style media extravaganzas, now in storyboard phase, need a new kind of star. Newscasters and media pundits with no knowledge of designer dwellings built for multimedia, no grasp of grand strategy maps minus their political overlays, no sense of what it means to surf freely through the Net, have a lot of homework ahead of them.

Our time is now. We, the global networkers, the world game players of today, have inherited the experimental prototype community of tomorrow. A giant BuckyBall stands at the center of Disney's EPCOT, Grunch's central shrine. The logo-language of corporate heraldry is destined to transform in the context of this world around web, a hypertext tapestry into which all of our metaphysical assets will be interwoven. Employing the know-how wealth amassed for us by our brilliant and courageous forbearers, we will make of this earth what the great pirates of old never dared wish for, except maybe in their most private prayers: a world in which our highest human values are consistent with the roles we are destined to play -- a great tragedy no longer. Let the show begin!

## **What about increased unemployment from DSR and automation innovations?**

[Ross Keatinge's question and my reply]

```
> I recently read an article in an Australian Electronics
> magazine where the author is discussing unemployment,
> redundancies etc and the general topic of technology doing the
> work previously done by people.
>
> Like the author of this article, I am very much in favour of
```

- > using technology to do more with less but am struggling to
- > come up with an answer to the question of just what DOES
- > happen to the factory worker replaced by a robot or the office
- > clerk replaced by a computer?

I think it depends upon what you think the purpose of employment is. I think the goal of a job is to eliminate that job. Therefore, from my perspective unemployment is a virtue and the economy had better learn to appreciate and value it. We need to solve this problem quickly because in the current economy Fuller's profesy of ``more with less'' is being conducted with a vengeance: even highly skilled people are finding their jobs and departments eliminated at very high frequencies.

But what is the individual to do in an economy that obeys Fuller's laws of empheralization, but does not (at this point) support the ``victims'' of the modern economy. I think this is where another Fuller principle comes in: What is the purpose of humans in Universe? ``To gather information and to solve problems.'' So it would behoove the individual to aggressively take up the task of becoming a general problem-solver (say during your next period of unemployment <grin>). Already it is clear the the economy does not really sport skills or experience; it seems that only can-do problem-solving is rewarded. OK, but what happens when our problem-solver finishes their job? Well, they go onto solve even more difficult problems. I think Fuller called this utopia. (Though the displaced factory worker or office clerk may disagree. It is sad but the Universe seems to work the way it works and it does not seem to support certain jobs or skills.)

[From Kirby Urner]

I think the missing puzzle piece vis-a-vis automation and unemployment in Fuller's thinking is in Education Automation.

The goal is not to render humans useless but to free them to perform metaphysical tasks with their minds. Setting up an economics to give people ``tenure'' in a more metaphysically driven economy does not seem all that far-fetched, given the information superhighway and all that rot.

Digital media are inherently copiable without limit, giving everyone access to tremendous cultural riches. But making it expensive by making it scarce is still the only way we can figure to ``earn a living.'' So the FBI will continue warning us not to copy videos etc. But, in principle, we have what it takes, metaphysical resource wise, to raise living standards in a Global University context.

...

What Bucky may have been saying, to the chagrin of LAWCAP [LAWyer CAPitalism], is that a system which does *not* hold basic living necessities hostage pending proof of your usefulness to society, but rather supplies a workstation to all and lets each individual seek excellence (or not), will come out ahead in the innovation and creativity department. There are *lots* of ways to meter a digital product's usefulness to others, and even to reward its authors accordingly, but *without* forcing us into *earning a living* behaviors. So many digital properties are vitally useful, but simply do not fit into the ``earning a living from revenues on sales'' framework. In fact, its the infinite copiability of digital media that makes ``earning a living from revenues on sales'' a system that gets us actively militating to inhibit technology, with handicapped CD copiers, dongles, other anti-copying schemes. We've made photo-duplicating an item (leaving it for others to also use and duplicate) a crime called ``Piracy.'' Imagine a pirate ship coming alongside, snapping polaroids of your treasure chest, and dashing off, cackling. Such is piracy. (Again, I'm not personally into using a lot of pirated software, but I've seen whole countries sustaining their economies on same, without the foreign exchange to ``make it all legal'' and question a LAWCAP new world order (i.e. the GATT) that would permanently make metaphysical assets artificially, suffocatingly unacquirable in an economy desperate for such assets).

## 3.2 What is the "cosmic accounting system?" --- Fuller's Economics.

[Typed in by Pat Salsbury.] The following is an excerpt from *Critical Path* by R. Buckminster ("Bucky") Fuller. (Copyright 1981, St. Martin's Press, NY -- pp. 262-263)

"...We have pointed out that the geologist Francois de Chardenedes wrote for me a scenario of the technology of nature's producing petroleum which disclosed that the amount of energy employed by nature as heat and pressure for the amount of time required to produce each gallon of petroleum, if paid for at the rate at which the public utilities now charge retail customers for electricity, must cost over a million dollars a gallon. Combine that information with the discovery that approximately 60 percent of the employed in U.S. America are working at tasks that are not producing any life support. Jobs of inspectors-of-inspectors; jobs with insurance companies that induce people to bet that their house is going to be destroyed by fire while the insurance company bets that it isn't. All these are negative preoccupations...jobs with the underwriting of insurance underwriters by other insurance underwriters -- people checking up on one another in all the different departments of the Treasury, the Internal Revenue, FBI, CIA, and in counterespionage. About 60 percent of all human activity in America is not producing any physical life protection, life support, or development accommodation, which physical life support alone constitutes real wealth.

"The majority of Americans reach their jobs by automobile, probably averaging four gallons a day -- thereby, each is spending four million real cosmic-physical-Universe dollars a day without producing any physical Universe life-support wealth accredited in the energy-time -- metabolic -- accounting system eternally governing regenerative Universe. Humans are designed to learn how to survive only through trial-and-error-won knowledge. Long-known errors are, however, no longer cosmically tolerated. The 350 trillion cosmic dollars a day wasted by the 60 percent of no-wealth-producing human job-holders in the U.S.A., together with the \$19 quadrillion a day wasted by the no-wealth-producing human job-holders in all other automobiles-to-work countries, also can no longer be cosmically tolerated.

"Today we have computers that enable us to answer some very big questions if all the relevant data is fed into the computer and all the questions are properly asked. As for instance, "Which would cost society the least: to carry on as at present, trying politically to create more no-wealth-producing jobs, or paying everybody handsome fellowships to stay at home and save all those million-dollar-each gallons of petroleum?" Stated evermore succinctly, the big question will be: "Which costs more -- paying all present job-holders a billionaire's lifelong \$400,000-a-day fellowship to stay at home, or having them each spend \$4 million a day to commute to work?" Every computer will declare it to be much less expensive to pay people not to go to work. The same computers will also quickly reveal that there is no way in which each and every human could each day spend \$400,000 staying at the most expensive hotels and doing equally expensive things; they could rarely spend 4000 of the 1980-deflated dollars a day, which is only 1 percent of a billionaire's daily income."

[From Ross Keatinge]

The most fundamental message I have got from his writings is about wealth. I cringe when I hear or read about a 'worldwide recession' and a 'depressed economy'. I know it sounds like common sense but I find it difficult to get people to realize that it is all our own doing. I work for a company which among other things does foreign exchange dealing. I'm not directly involved in but I always find it amusing when they talk about 'The Market' as if it is some alien entity which we have no control over. There has been some currency crises in recent times and I hear phrases like "Everybody is watching the market very closely today," or "I hope the dollar doesn't drop any further today."

I tend to see the population of the Earth as similar to a group of people living on an island with plenty of natural resources but some are starving because the people can't get their act together even though they have the technology to transport resources around the island. The latest 'Time' has a bit about the huge stockpiles of food in Europe they don't quite know what to do with (posted 1 Oct 1993).

[From Kirby Urner]

Bucky defined wealth as life support. Some feel wealth is what humans get credit for because it is produced through



their work. This is also the Marxist view: that only labor creates value. Given Bucky's definition, we see the sun and ecosystems as wealth-producing, but outside the cash system. Most of our life support (wealth) is not owing to human labor, but to automated, cybernetic, natural processes. Agriculture is hard work, but it wouldn't happen at all without nature's contribution. Given Fuller's "cosmic accounting" (looking at wealth production with or without human components), it appears that no matter how hard we work, we individually get more life support than we produce. We do not "pay our own way" as a species.

There's no way that you, born a helpless baby just decades ago, could possibly pay your debts to humanity for all the assets you use in life, including the words you use free of charge. Humans don't pay the sun for powering the earth or take much credit for all the automatic wealth creation that goes on around us constantly, cashlessly. Humans get to work, yes, but they don't get to take credit for everything they produce. Ultimately we're distributing wealth to children (average global age: 15) and generations yet unborn -- no way they can pay their own way.

I think the institution called The Library is fundamental to democracy and wonder what will happen to this institution in the digital age. What does it mean to "borrow" a digital asset when making a copy also leaves it on the shelf? Trying to make information assets fit the mold of real estate assets when talking about "intellectual property" is to seriously mix metaphors. Information assets are not English country estates.

Human language is more like an ecosystem asset than a capitalist one: we work with it without paying for the privilege. But language is not just a pile of words in the dictionary. Language is sense, knowledge, a way of ordering experience. The question is: how quickly will certain intellectual assets cross the line from cash-accounted assets to ecosystemic ones -- how quickly will our metaphysical work be subsumed within Language? How will language masters be rewarded, if not with cash revenue from end users? Encryption and computerization offer the possibility of trafficking in zillions of currencies. You will gain access to assets you have demonstrated your ability to expertly use. Same as now.

Fuller's point in *Critical Path* was that even many of those gainfully employed (not counting disemployed-through-automation) are doing nothing very vital to the creation of sustainable life support systems. Market pricing is just the tip of the iceberg of a system of pushes and pulls. At the far end of the cheap jeans is the barrel of a gun, pointed at people who cannot prove legal tenure to the land their ancestors farmed for generations. The prices we pay have a lot of brute force behind them, not just self-interested parties freely making choices. Making cash scarce to keep it valuable, by making those who have it fear the miserable state of those who do not, is a coercive system, not a freedom-loving one.

Cold cash is just one of many "currencies" -- the most liquidly convertible (provided it is one of the globally acceptable "hard" ones). I'm a big fan of wiring workstations to systems which dispense credits redeemable "in kind." E.g. hours spent completing multimedia session on *Insects of the World* gets you tickets to the science museum and a \$40 credit at a book store. The museum and bookstore are also receiving lots of non-cash redeemables for their services. Not barter exactly, but not pure liquid either. Computers make it practical to electronify wealth distribution games that accomplish the movement of goods in services in more channeled, designed structures. Not big brother though, since no central planning authority -- just lots of dial-in "games" with costs and rewards, likely to attract those with a self-interest in playing. Those are the details. From a distance, it looks like a planet full of professors on tenure, working hard, doing more metaphysical stuff than before.

[Karl Vogel replies]

No one has deliberately set out to "make" cash scarce. Earth does NOT give us everything we need without requiring any productive work on our part; if we want food, we have to grow it or get it from someone who has grown it. This can be done in one of two ways; peacefully through trade or otherwise.

[Kevin Sahr replies]

I think these two viewpoints define the crux of the debate. And I (and I think Bucky) would have to agree more with Kirby. Capitalism is based on scarcity, and those with a deeply vested interest in the status quo (or a simple fear of change, which I think we all share to some extent), will fight any efforts to, say, develop cheap renewable sources of energy which threaten the scarcity and thus the value of their sources of income. In the long run, we each individually and as a society suffer from this. I've heard the argument that the mechanics of a free-market economy

will eventually overcome such inertia, but I find the idea that we live in anything even close to a free-market economy to be absurd.

I find Bucky's vision of a society of scientist/artists who are self-fulfilled in the very act of creation/learning to be inspiring. The problem, of course, is how we get from here to there. I do not claim to have the answer. However, I think that the dawning of the information age is going to make it very difficult for people to, at the very least, delude themselves into thinking that we do not live in an economy of enforced scarcity. Because information, by its very nature, only has value in a capitalist economy to the extent that it is deliberately "made" scarce. If I have an HDTV with a digital recorder capable of perfect reproduction of "Jurassic Park," and a fiber optic link direct to a digital copy of that movie, then someone is going to have to introduce a deliberate "mechanism of scarcity" to keep me from copying it. If I have a computer on my desktop capable of creating, from a hardware/software standpoint, the dinosaur sequences from "Jurassic Park," then the only thing of real value in JP is Steven Spielberg's creativity (and that of the other artists that participated in its making). Once Spielberg (or anyone else) no longer needs Hollywood's money to make a movie like JP, and no longer needs their distribution channels (because everyone has equal access to the net -- unless we CHOOSE to make access "scarce") then what is to stop him from just making his movies out of the sheer pleasure of it and giving copies freely to anyone who wants them? As we move closer and closer to an "information standard" of value in our economy, I think the old economic models we've been using are in for a crisis. I, for one, hope it will be a fatal crisis.

If everyone gives freely of themselves without expecting anything in return, we will all have more than we could ever possibly dream. And because this makes so much sense, that must be where the universe is headed. To me that's really what Bucky was all about. What a beautiful being!

[From Leo Elliott]

What has become *really* important (economically) is not the product (movie, book, code, net, etc.) of the artist (scientist, Spielberg, et al.), but rather the "enforced scarcity" you've recently been battling around? What drives the GRUNCH economy is not the production of goods and services, as standard economic theory might have it, but rather the perpetual maintenance of scarcities, such that once an item becomes abundant and low-cost, then production shifts to the new style, the movie sequel, the next year's model, etc.

What has come about is the denigration, to the point of debility, of what Bucky may have called the ability to maintain secrets, industrial, military, or otherwise (recall his tales of how civilization was advanced on the high seas with one nation getting the jump on another, as via the development of guns with longer ranges, by always keeping secret their more-with-lessing capabilities -- now these more-with-lessing capabilities seem to be developing, mutating (dare I say evolving) faster than the old Giants' abilities to keep up with them, witness Aldrich Ames.)

Some may reference this to the Summer '93 issue of *Whole Earth Review*, wherein Stewart Brand prefaced Kevin Kelly's article on "Cyberspace, E-Money, and the Technologies of Disconnection" (pp. 40-59) as follows:

"This one is a world-changer. Personal encryption may be as revolutionary as personal computers in transforming the web of human communications...

"Since I am allied with cypherpunks and their program, I feel cheerfully duty-bound to raise a question or two, such as: 'If the real world is awkward to work with and full of cops, and if electronic cyberspace is easy to work with and has no effective cops (thanks to universal encryption) AND is where all the money is, what does that suggest about the future of crime?' "

Thus in some odd extension of value-added marxian economics, the old-model consumer of mainline value-added products (folks who might pay the full ticket price to go see Jurassic Park in a bigscreen theater) becomes ever less significant in the economic factoring to those who would add value by passing lesser imitations around (videos or associated dino mdse)... which I *think* leads somewhere back towards Bucky's "ephemeralization" of economic processes. The "value added" manifest on the nets would simply be represented by the "passing on" of data, in the hope/probability that it will assume "added value" as info and/or entertainment on the receiving end.

[From Mark Stowe]

It is my strong personal recommendation that everyone unfamiliar with the game theory/evolutionary modeling of altruistic behavior, would do well to read up in this area (an adequate if less than inspired starting point would be the article on page 76 of the March 1994, Scientific American). Capitalism is currently a necessary evil in my view because of the presence of "defectors:" those whose power grows at the expense of those who volunteer their labor. Essentially my hope for the future lies with my belief that on-line communities provide unprecedented possibilities for getting around this problem, because 1) they provide enormous power to organize boycotts and otherwise isolate defectors and 2) they increase the power of the altruists by virtue of the fact that altruistic creations in an on-line community (helpful programs, enjoyable works of art) last much longer (the normal rules of entropy do not apply). I think that the problem of cheaters in an on-line community as discussed in the article on page 90 of the same Sci-Am issue can be overcome by a number of technological tricks.

### **3.3 What is the World Game?**

[Keyed in by Patrick G. Salsbury.] This is an excerpt from *The Essential Whole Earth Catalog* (Doubleday & Company, Inc., Garden City, NY) p. 89

#### **THE WORLD GAME**

"To make the World work / for 100% of Humanity / In the shortest possible time / Through spontaneous cooperation / Without ecological offense / Or the disadvantage of anyone."

Buckminster Fuller initiated the World Game in 1969 as one means of accomplishing this worthy goal. The idea is that with enough data on world resources and their distribution (including accumulated technology and problem-solving skills), the world's citizens will do what's best for all. Fuller assumed that once it was obvious that there was enough of everything to go around, people would stop fighting wars and get to work making the world work -- if not as a utopia at least not continuing the current suicidal path. World Game is still developing. Recent sessions use an enormous basketball-court-size map in order to more easily visualize various strategies as they are suggested by participants. A formidable software database called Global Data Manager allows individuals to play with the numbers on their PCs.

#### **What is the World Game Institute?**

[Dane Winberg of the World Game Institute sent me this contribution.]

World Game Institute is a non-profit, non-partisan, global education and research organization dedicated to developing and disseminating problem solving and educational tools. World Game was conceived by world renowned architect, philosopher and visionary, R. Buckminster Fuller as a creative problem solving tool whose goal is to "make the world work for 100% of humanity in the shortest possible time, through spontaneous cooperation and without ecological offense or the disadvantage of anyone."

#### **Global Recall 2.0 -**

A computer atlas featuring 300 world, regional and country maps and 600 data indicators for all countries; 18 essays on current global problems; a Solutions Lab section where you can describe your ideas for global solutions and compare them to real-world data. Comprised of several linked HyperCard stacks, available for Macintosh computers. Regular data updates.

#### **Global Data Manager -**

Available for DOS or Macintosh (currently only for system 6), GDM displays data on population, food, energy, education, natural resources, economics, etc. for the world, all continents and all countries. Separately sold disks of data from World Bank, World Resources Institute, UN.

#### **World Game Workshops -**

Interactive global simulations conducted for elementary and high schools, community groups, universities and corporations; adapted with an emphasis on world geography, history, current events, global issues, patterns of

development, strategic options and sustainable solutions to local and global problems.

### **World View Map for the Playground -**

A basketball court-sized world map is painted on elementary school playgrounds; includes an activities manual for several subject areas.

### **World View Map for the Classroom -**

A smaller roll-out version of the playground map for indoor use.

World Game Institute  
3215 Race Street  
Philadelphia, PA 19104-2597  
Phone: (215)387-0220 Fax: (215)387-3009  
Web: <http://www.worldgame.org/>

>We're interested in knowing more about any World Game group in Seattle.  
>-- Kirby & Nick in  
>Portland, Oregon

Contact: Chuck Dingee  
Pacific Northwest Regional Representative  
PO Box 2681,  
Bellingham, WA 98227-2681  
Tel: (206) 647-5106 Fax: (206) 647-5106 (ext 77#)

Chuck was for many years in charge of putting on World Game workshops from the Philadelphia office.

[Posted by Ian Wells] INTRODUCTION TO THE WORLD GAME INSTITUTE

The World Game Institute is a non-profit research and education organization dedicated to developing technological and interactive tools for global problem solving. Among our many products and programs are:

- Computer software products for researchers, primary and secondary schools, policy makers and others who need global information at their fingertips to help them create problem solving strategies that work.
- Participatory workshops conducted for corporations, national governments, universities high schools and world organizations that demonstrate in real terms the distribution of resources around the world, and methods of using those resources to provide a quality standard of life for all humans without destroying the planet.
- Museum exhibits which display the status of resource distribution around the world, and which demonstrate the impact of environmental, military and agricultural policy.
- Publications which disseminate research methods and solutions for global problems, and demonstrating creative uses for the tools developed by the World Game Institute.
- Playground maps of the world, supplied with teacher's training manuals and activities to make global education fun.

The World Game was created by R. Buckminster Fuller, the eminent geometer, architect and thinker, as a creative alternative to war games. Participants in World Game workshops learn to see the world in terms of one population sharing the wealth of one planet, and ``win" the Game when they meet the basic health, education, welfare and survival needs of the world's population. In its more sophisticated versions, the World Game also acts as a simulation and laboratory, used by policy makers, corporations and diplomats and world leaders to devise efficient problem solving strategies.

&ast;&ast;&ast;The preceding was uploaded to CompuServe several months ago. The World Game Workshop, while conceived by Fuller, does not resemble the original Workshops closely at all. Neither is the World Game Institute actively involved in disseminating information about Fuller or pursuing his ``synergetics" theory, per se. His theories are a jumping off point for the Institute, but we are not solely involved in propagating his teachings

alone.

Susan Caskey

## What are the World Game Institutes "games" like?

Did you know that some scientists have determined that the air could cleanse itself of all pollutants in TWO WEEKS if polluting stopped for that period of time?

Did you know that all nuclear warheads would be non-explosive in 18-22 years if no tritium was replaced in them?

Briefly, The World Game is a three hour experience including a 1 1/2 hour trading simulation game played on a dymaxion projection of the Earth. Lots of slides and music is used to make it entertaining as well as educational. Fuller's intent was to design a game that would be an alternative to war games.

Although the game content deals with many issues besides the environment such as hunger, nuclear proliferation, and education, the ideas of cooperation and coordination are pervasive and based on up-to-the-moment data on all of the issues.

Costs are dependent on number of workshops to be held, distance traveled, etc. Figure around \$3500 and up. But it is worth it! Often our district will spend anywhere from \$5000- \$10,000 for a speaker for an evening seminar. So don't flinch at the money yet.

Janet Whitaker Rio Salado Community College Phoenix, Arizona

## What is Global Data Manager (GDM)?

To quote from the GDM manual: "If information is power, Global Data Manager is a powerful tool. Its intended purpose is to make accessible the vast amounts of statistical data upon which all fundamental resource allocation decisions in the world are made... Global Data Manager makes available for the first time, in an easy to use personal data computer format, the vital statistics of the world. Its purpose is to integrate into one system the world's most complete inventory of global data into an easy to use, personal computer based, problem analysis and solving system that is accessible to the researcher, policy maker, social activist, student, teacher, media and general public"

Ian Wells Director, Social Impact Group Boston Computer Society

## Does the World Game offer any solutions to the World Hunger Problem?

I just latched onto a copy of *Ho-Ping: Food for Everyone*, by Medard Gabel [ED: Medard Gabel is the executive director of the World Game Institute.] It is INCREDIBLE! It addresses the World's Food supply/distribution problems from a holistic, comprehensive, design science approach. That is, by considering the ENTIRE planet, and 100% of humanity in all its study. --- Patrick Salisbury

## 3.4 What were Fuller's views on religion and God?

The following is a quote from pages 116 and 117 of *Ideas and Integrity* by R. Buckminster Fuller. (c) 1963. The actual passage is taken from something he wrote on Sunday, Nov. 7th, 1942. It is interesting to note how accurate the statements seem to be in our present time, despite their age. I got a kick out of them in light of the recent scandals in religious circles and all the other goings on. The statements come from Chapter Six of the Book. It is entitled "I Figure" and these two words are meant to proceed each of the ideas presented in the chapter. --- Patrick Salisbury, 1-11-90

"...that the people are now more deeply conscious than ever before in history of the existence and functioning principles of universal, inexorable physical laws; of the pervading, quietly counseling truth within each and every one of us; of the power of love; and--each man by himself--of his own developing, dynamic relationship with his

own conception of the Almightyness of the All-Knowing.

``...that our contemporaries just don't wear their faith on their sleeves anymore.

``...that people have removed faith from their sleeves because they found out for themselves that faith is much too important for careless display. Now they are willing to wait out the days and years for the truthful events, encouraged individually from within; and the more frequently the dramatic phrases advertising love, patriotism, fervent belief, morals, and good fellowship are plagiarized, appropriated and exhibited in the show windows of the world by the propaganda whips for indirect and ulterior motives, no matter how meager the compromise--the more do people withdraw within themselves and shun taking issue with the nauseating perversions, though eternally exhibiting quiet indifference, nonchalance or even cultivating seemingly ignorant acceptance."

## **How did Bucky's ``Ever Rethinking the Lord's Prayer" go?**

[Well, he came up with a new version each night! But here is one version posted by Leo Elliott.]

The following is a transcription from a 1976 ``Being With Bucky," New Dimensions Tapes, side 15 (parsing and punctuation by transcriptionist).

Our God, who art in we even,  
even we who know most intimately  
of our own weaknesses, failures, faults, and outright sins  
our selfishness, fear and cupidity,  
of our moments of jealousy, rage and hate  
secret cover-ups, lies and self-deceits  
God even of we

Our God -- our intuitively-apprehended comprehensive-admonisher  
Omni-experienced is your identity,  
the everywhere and everywhen evolving omnireality  
is your presence

and as the reality differs uniquely from moment to moment  
in respect to each individual  
so do you speak to each  
in exquisitely relevant, instructive terms  
regarding that which the individual  
can most effectively do  
not in behalf of self  
but in behalf of all humanity

and Thus in support of the intellectual functioning of humans  
thereby in local universe support  
of the eternal integrity of omniregenerative universe  
which is God.

As omniexperience, you have given us  
overwhelming manifest  
of your complete knowledge  
your complete comprehension  
your complete concern  
your complete wisdom  
your complete responsibility  
your complete co-ordination

your complete competence to cope  
with any and all problems  
and of your utter reliability  
always so to do  
Yours, dear God, is all the glory.

\* \* \*

We oft-times think of ourselves  
as independent individuals  
able to get on by ourselves  
by our own wits  
forgetting altogether  
that we did not invent those wits  
nor the incredibly complex, 99.9% automated  
biological organisms  
nor the rest of the universe  
with which they interfunction,  
all of which is entirely  
the prior competent conceptioning  
only of God.  
Yes dear God, yours is all the Glory.

You are the totally mysterious  
eternal integrity, both comprehensively  
and incisively governing  
the omni-intercomplementation and omni-interaccommodation  
of all physical and metaphysical experiences  
of ever and everywhere  
separately and complexedly intertransforming  
omni-regenerative universe.

You are the synergetic integral of all truths.  
We have absolute trust and faith in you  
and we wish of you  
awe-inspiredly, thankfully, rejoicingly and lovingly --  
for it's spontaneously feasible  
for humans to be wishful of the truth  
in awe of the truth  
thankful for the truth  
to rejoice in the truth  
and to love the truth  
and to love all the truths combined  
for all truths are omni-interaccommodative  
as are all the  
only mathematically-statable generalized principles  
discovered by human minds,  
experimentally verified by science  
to be externally governing  
complex interrelationships of physical universe.

\* \* \*

Truths and principles never contradict one another.  
They are all concurrently omni-interaccommodative  
and all the truths are metaphysical cognitions  
by humans  
of special-case realizations  
of eternally-valid generalized principles.

It is only through many repeated experiences and recognitions  
of the eternal principles  
their non-contradicting interaccommodations  
that each individual human  
progressively and only intuitively discovers the existence of  
eternal principles and their special-case manifests  
and the truths of everyday events  
and all the truths, as our lives discover them,  
trend to integrate in synergetic perfection  
beyond the special-case experiencing  
of inherently terminal  
ergo inherently limited  
human conceptioning, comprehension and communication...

### **3.5 What is the Global Energy Grid idea?**

[From *Critical Path* by RBF, 1981, p. 206.]

``It is engineeringly demonstrable that there is no known way to deliver energy safely from one part of the world to another in larger quantities and in swifter manner than by high-voltage-conducted `electricity.' For the first half of the twentieth century the limit-distance of technically practical deliverability of electricity was 350 miles. As a consequence of the post-World War II space program's employment and advancement of the invisible metallurgical, chemical, and electronics more-with-lessing technology, twenty-five years ago it became technically feasible and expedient to employ ultra-high-voltage and superconductivity, which can deliver electrical energy within a radial range of 1500 miles from the system's dynamo generators.

``To the World Game seminar of 1969 I presented my integrated, world-around, high-voltage electrical energy network concept. Employing the new 1500-mile transmission reach, this network made it technically feasible to span the Bering Straits to integrate the Alaskan U.S.A. and Canadian networks with Russia's grid, which had recently been extended eastward into northern Siberia and Kamchatka to harness with hydroelectric dams the several powerful northwardly flowing rivers of northeasternmost U.S.S.R. This proposed network would interlink the daylight half of the world with the nighttime half.

``Electrical-energy integration of the night and day regions of the Earth will bring all the capacity into use at all times, thus overnight doubling the generating capacity of humanity because it will integrate all the most extreme night and day peaks and valleys. From the Bering Straits, Europe and Africa will be integrated westwardly through the U.S.S.R., and China, Southeast Asia; India will become network integrated southwardly through the U.S.S.R. Central and South America will be integrated southwardly through Canada, the U.S.A., and Mexico."

[From The GENI website.]

[GENI](#), Global Energy Network International Global Energy Network Institute was founded in 1986 by Peter Meisen to investigate the idea of Dr. R. Buckminster Fuller, proposing a global electric energy grid as the number one priority to solve many of the world's most pressing problems.



## **3.6 What is a ``trimtab?''**

[From Blaine A. D'Amico.]

A Trimtab is a tiny flap that controls the rudder on a ship or airplane. When the rudder needs to be moved, this tiny ``trimtab" is adjusted which creates a low pressure area on one side and turns the rudder. Bucky used the word to illustrate what the little individual can do to ``turn the great ship of state." He also noted that the ship has [ already ] passed the point where the turn is occurring. This might be a comfort to those on the bow wondering if we have missed our chance to change course.

Bucky's gravestone says simply ``Call me TRIMTAB"

## **3.7 Was Bucky a socialist?**

Not exactly. Though he did speak fondly of socialism (mainly the ``take care of everyone" and the ``plan ahead" ideas in socialism). The following exchange clarifies this a bit.

Blaine A. D'Amico: Fuller said nothing about redistribution. His Design Science revolution is based in raising the living standard of the `have-nots' and `have-lesses' without taking away from the haves. This is done through ephemeralization ``more with less."

Patrick G. Salsbury: He did, however, discuss DISTRIBUTION, and how the intelligent application of that could solve problems like global food shortages, etc.

## **3.8 What were Fuller's views on Education?**

Fuller's book [Education Automation](#) is a primary source.

[From Robert L Lamons]

I am anamored with his writings on education. For someone that had so much difficulty with standard education models he did quite well. I first read about his theory on ``Education" in *Operating manual for Spaceship Earth*, chapters 3,4 and 5 I believe. I have read his other books on education too. All lead to the same conclusion, that education is active and must be sought, not something that you can sit down and drink up as someone pours it out to you. We have modeled our educational theories after this and are now ``organically" homeschooling our 5 children. That is what we like most about Bucky.

## **3.9 What is the difference between ``Class I" and ``Class II" evolution?**

[ *Critical Path*, p. 229-30 ]

``Class-two evolutionary trendings are all those events that seem to be resultant upon human initiative-taking or political reforms that adjust to the changes wrought by the progressive introduction of environment- altering artifacts. All the class-two evolutionary events tend to flatter human ego and persuade humanity to deceive itself by taking credit for favorable changes in circumstances while blaming other humans or `acts of God' for unfavorable changes. It therefore assumes that humanity is running the Universe wherefore, if its power-structure leaders decide that is is valid to cash in all of nature's available riches to further enrich the present rich or to protect them militarily from attacks by their assumed enemies - all at the cost of terminating human presence on planet Earth - that is the power-structure leader's divine privilege.

``All the class-one evolutionary trending is utterly transcendental to any human vision, planning, manipulation, and

corruption. Class-one evolution accounts for humans' presence on Earth. It accounts for their having always been born naked, helpless for months, and inexperienced - ergo, ignorant, hungry, thirsty, curious, and therefore fated to learn how to survive only through trial-and-error-won, progressive accumulation of experience. Class-one evolution accounted for humanity's all-unexpected invention of verbal (aural, sound) communication, and thereby the integration of the experience-won information of the many, whereby the integrated information of the many increased the capability of humanity at large to cope with the exigencies of life. It is class-one evolution that led, after the progressive integration of the total experience-won information, to the unpredicted invention of writing or visual communication, by means of which the dead could speak to the living and within which total written information history human mind from time to time discovered repetitive patterns, which in turn sometimes led to the discovery of generalized scientific principles."

## **3.10 How to house humanity? And other reflections on Making the World work.**

Housing humanity was Fuller's motivation for designing the Dymaxion House and the Geodesic Dome (See section [Geodesic Domes](#) for more on the Dome). Fuller designed them because of the tremendous waste and inadequacy of cube-based dwellings. Also see sections [What was Fuller's ``floating city?''](#) and [Old Man's River City Project \(circular cities\)?](#) on re-designing cities.

[From Kirby Urner]

And I'm one of the *lucky* ones! I've got indoor plumbing and heat! No way we can supply the world's billions with these assets using the sadly obsolete construction methods of yesteryear, perpetuated with cosmetic improvements decade after decade. The USA living standard cannot be replicated globally, nor should it be, as inappropriate, wasteful and Dark Aged as it is! May the Chinese do it better!

A story on the radio the other day said metal is becoming more popular among construction workers in this age of dwindling forests and climbing lumber prices. For one thing, you can screw instead of nail. Imagine, pro-metal propaganda on the radio -- in Oregon! The lumber industry is fighting back, saying mines are at least as damaging to the environment as logging. But Fuller's point was that the majority of the metals we need are already mined, and can be recycled over and over (the dwellings will be designed with recycling in mind, kind of like the Germans have been doing with some models of BMW).

The old housing stock won't disappear -- decades of remodeling await the avid remodelers. But I wish those of us who are being pushed to the periphery by high housing costs had more to look forward to than mobile home courts. I'm always passing these mobile homes on the backs of trucks on the freeway -- Caution Wide Load. Why do helicopter deliveries from the local dealer to less paved over and bulldozed environs sound so far out and ``futuristic?" Fuller's little energy-harvesting, grid-autonomous units, constellated in remote little campus-communities, would make ideal living and learning environments -- good places for children.

[From Leo Elliott]

``Why do helicopter deliveries... sound so far out and `futuristic'?"

I think the most telling answer is implied in a word contained in Kirby's next sentence:

``Fuller's little energy-harvesting, grid-autonomous units, constellated in remote little campus-communities..."

the key word being ``grid-autonomous." As per *Grunch of Giants*, pushers do not like it when users decide they want to ``grow their own," be it homes, domes, education, or local support systems. Supposedly the dymaxion bathroom, mentioned here previously, received rave reviews until the plumbers unions of the time found out that it would be completely user-installable, thus depriving them of their ``standard fees."

I would suspect that it has been this whole notion of de-centralized energy systems (centrifugal energy flow/centripetal info flow) which has, over the years, aside from Fuller's personal suasions and disuasions, been the

most threatening (to the ``giants'') aspect of his overall program -- live anywhere you want, do what you want, all paid for by the dole, which itself will be more than paid for by the return on investment of those marvelous discoveries and inventions made by the less-than-1% who would produce the most wonderful synergy-revealing artifacts.

[From Kirby Urner]

Leo Elliott writes:

> I would suspect that it has been this whole notion of de-centralized energy  
> systems... which has... been the most threatening (to the ``giants'') aspect  
> of [Fuller's] overall program

Perhaps, perhaps. But think of the business interests in *favor* too: a huge aftermarket in user-installables (similar to computer component add-ons). Cellular phone and fax demands, satellite TV, the education and info-tainment dialup video needs of remotely deployed home-schoolers, a growing sector of under/unemployed defense workers with aerospace savvy... And the utility grids will *still* have LA, Paris and Tokyo to power. Its not like a sprinkling of grid-autonomous dust is going to spell `lights out' in the sprawling megalopolis already covering the planet. Moreover, Fuller was hardly ``anti-grid" what with his bi-hemispheric vision of same...

Recall that ``the industry industry missed" (July 1932, Fortune magazine) was initially very appealing to industrialists in the pre-war 30s, including such as GE -- was briefly subject of what we'd nowadays call ``media hype." The unions (along with the banks and county zoning boards) might have killed it, but the duck was lame to begin with -- or at least this is what Fuller says in retrospect: ``Fortune made the mistake of assuming `the industry industry missed' had at last come of age... Evolution was clearly intent on postponing the inception of the livingry service industry until humanity had graduated from its pre-twentieth century condition as a planet of remote nations... all of which waited upon the completion of a world-around network of ... telephones ... and jumbo jet airplanes." (*Grunch of Giants*, pp xvii-iii).

[From Kirby Urner]

Adequate shelter for all humans is possible. Not using forest products though. I think what tent life and Fuller's homes have in common is energy-autonomy. With a Fuller unit, I can plunk down in the middle of nowhere. The tripod of my Fly's Eye is adjustable for bumpy, slopey terrain. I didn't have to rip a road through the wilderness to get it here. I didn't have to pour a foundation or bulldoze or whatever. Say I'm a student of ecology. A university consortium has these ``remote campus deployment" units that programs rent for a few weeks or months. Whole little communities deploy, doing minimal damage to the environment, make their studies (staying in touch with cellular Internet etc.), and leave. The noisy helicopter part only comes at the beginning and the end, and maybe once a week during the middle.

I say we look at cities as huge campuses (the ``city as campus" metaphor) and all humans as would-be students in a Global University. Work-study options, life-long ``learning a living" scenarios give you access to all kinds of facilities, travel. Fuller computed that our global energy budget (solar derived) gave us enough to offer fellowships to all those impoverished and living in shanty towns, minus any really good education. I think many families in the Philippines would jump at the chance to enroll in the Global University. If you like the outdoors life, and growing food, or fishing, well, that can be arranged.

### **3.11 Was Bucky an ``optimist" or a ``pessimist"?**

[Fuller quote from 1928 typed in by Leo Elliott]

``A pessimist is one who `believes' the world to be rapidly diminishing to complete materialism, and looks only to the past with pleasure.

``An optimist is one who `believes' in no fact of undelectable presence and looks only to the future for happiness.

``An individual is one, who, happy in the present time, perceives the relative progression of the spheres. Being

unselfish, is he jealous of neither past nor future. Thus does he stay time."

## **3.12 What about Fuller's plan for a nationless world?**

[From Kirby Urner.]

### SOME THOUGHTS ON NATIONS FROM A FULLER FAN

Nationalism seems a bankrupt strategy for mapping ethnic/cultural distinctions to geography, which as too few dimensions to accommodate the interweavings of affinity. For all their drawbacks, notice how corporations support the trappings of nationhood, with logos, mottos, CEO-prezes, image/identity stuff, but without blocking off huge areas of the map. Corporate cultures hang together globally with dispersed campus settings wired by commlinks and frequent flyers. In this sense, I think Serbia, Inc. or Israel, Inc. or Palestine, Inc. -- global networks with no huge territorial claims -- would better accommodate the complex topology of ``we" groupings.

Phasing in Fuller's nationless map doesn't mean declaring that nations don't exist, or waiting for some revolution. We're just de-emphasizing their importance. And I still think USA has a bright future, not so much as a territory as a democratic system for providing goods and services. Governments are systems, inherently global. You can log in to USA OS (USA operating system) from wherever. Much as it is today -- I send email to mom & dad @usaid.gov in Africa.

To be a Fullerian, philosophically, is, I believe, to say ``enough with the silly nation-state idea already!" That doesn't mean I don't pay taxes, or vote for this or that. But I'm not interested in deciding the boundaries between Israel and Syria or Serbia and Bosnia. That's a jigsaw puzzle that's hopeless to the core. Lets get folks into domes and such, and online. With multimedia and a future to live for, life will again seem too precious to waste in war to defend the future of some obsolete institution called ``nation." That was the real purpose of the Spaceship Earth metaphor: not to make earth seem mechanistic (Jeremy Rifkin's criticism) but to make it seem apolitical.

[From leo elliott]

No argument from me that nationalism presents some definitely grunchy, special case, anachronistic modes of ownership, which seems to be the prime directive in these various hideous nationalistic horror theaters (Rwanda, Bosnia, etc.). I might still have some reservations about there being a darker side to corporationalism that would lead me to suspect that, benign as it may sometimes seem, it would hardly make the world apolitical -- maybe affect the political dialog, but I doubt it would erase the greed or fear or whatever it is that lies at the core of the mort-gaging system of accounting which, imo, is squeezing the forward-lookingness out of more and more arenas. (I am still debating whether to view Schindler-style commercialism as a testament that, even in the ultimate debasement of dialog that war represents, that there is at least some common dialect of commerce that will still be spoken (representing, presumably, some still-commonly-agreed-upon standards of value), or whether to view Schindler's efforts as outrageous exploitation.)

---

[Next](#) [Previous](#) [Contents](#)

## 4. Geodesic Domes

Fuller invented the Geodesic Dome in the late 1940s to demonstrate some ideas about housing and "energetic-synergetic geometry" which he had developed during WWII. This invention built on his two decade old quest to improve the housing of humanity. It represents a brilliant demonstration of his synergetics principles; and in the right circumstances it could solve some of the pressing housing problems of today (a housing crisis which Fuller predicted back in 1927).

### 4.1 What is a geodesic dome?

[From Robert T. Bowers' paper on Domes last posted to GEODESIC in 1989.]

A geodesic dome is a type of structure shaped like a piece of a sphere or a ball. This structure is comprised of a complex network of triangles that form a roughly spherical surface. The more complex the network of triangles, the more closely the dome approximates the shape of a true sphere [sic].

By using triangles of various sizes, a sphere can be symmetrically divided by thirty-one great circles. A great circle is the largest circle that can be drawn around a sphere, like the lines of latitude [ED: he means longitude] around the earth, or the equator. Each of these lines divide the sphere into two halves, hence the term geodesic, which is from the Latin meaning "earth dividing."

[From Mitch Amiano]

The dome is a structure with the highest ratio of enclosed area to external surface area, and in which all structural members are equal contributors to the whole. There are many sizes of triangles in a geodesic [ED: dome], depending on the frequency of subdivision of the underlying spherical polyhedron. The cross section of a geodesic [ED: dome] approximates a great-circle line.

### Do domes really weigh less than their component materials?

[From Pat Salisbury]

Well, the structures weigh less when completed because of the air-mass inside the dome. When it's heated warmer than the outside air, it has a net lifting effect (like a hot-air balloon).

This is almost unnoticeable in smaller structures, like houses, but, as with other things about geodesics, being as they're based upon spheres, the effect increases geometrically with size. So you'd be able to notice it in a sports stadium, and a sphere more than a half mile in diameter would be able to float in the air with only a 1 degree F difference in temperature!

### What about underground concrete domes?

[From Randy Burns.]

Underground concrete domes are rather interesting

- 1) They can use chemical sealing and landscaping to avoid leakage problems associated with wooden domes.
- 2) They are *extremely* strong. Britz [see [Dome References](#) for more on Britz] has obtained extremely low insurance rates on his structures. The insurance company tested one building by driving a D8 Caterpillar tractor on top of the house!
- 3) There's little hassle involved in dealing with materials that were really standardized for use building boxes. The only specialized tools are the forms, everything else can easily be used off the shelf.
- 4) They can be quite aesthetic. Britz has shown that you can build developments where the houses can't really see each other.
- 5) They are *cheap* and easy to heat, cheap enough that you can build a much larger structure than you might using conventional housing and use standard room divider technology to split the thing up into room.

## What are geotangent domes?

[Keyed in by Patrick G. Salsbury.]

The following is quoted from "Scientific American" in the September 1989 issue. (Pages 102-104)

Surpassing the Buck (Geometry decrees a new dome)

"I started with the universe--as an organization of energy systems of which all our experiences and possible experiences are only local instances. I could have ended up with a pair of flying slippers." -R. Buckminster Fuller

Buckminster Fuller never did design a pair of flying slippers. Yet he became famous for an invention that seemed almost magical: the geodesic dome, an assemblage of triangular trusses that grows stronger as it grows larger. Some dispute that Fuller originated the geodesic dome; in *Science a la Mode*, physicist and author Tony Rothman argues that the Carl Zeiss Optical Company built and patented the first geodesic dome in Germany during the 1920's. Nevertheless, in the wake of Fuller's 1954 patent, thousands of domes sprung up as homes and civic centers--even as caps on oil-storage tanks. Moreover, in a spirit that Fuller would have heartily applauded, hundreds of inventors have tinkered with dome designs, looking for improved versions. Now one has found a way to design a completely different sort of dome.

In May, J. Craig Yacoe, a retired engineer, won patent number 4,825,602 for a "geotangent dome," made up of pentagons and hexagons, that promises to be more versatile than its geodesic predecessor. Since Fuller's dome is based on a sphere, cutting it anywhere but precisely along its equator means that the triangles at the bottom will tilt inward or outward. In contrast, Yacoe's dome, which has a circular base, follows the curve of an ellipsoid. Builders can consequently pick the dimensions they need, Yacoe says. And his design ensures that the polygons at the base of his dome always meet the ground at right angles, making it easier to build than a geodesic dome. He hopes these features will prove a winning combination.

Although Fuller predicted that a million domes would be built by the mid-1980's, the number is closer to 50,000. Domes are nonetheless still going up in surprising places. A 265-foot-wide geodesic dome is part of a new pavilion at Walt Disney World's Epcot Center in Florida. A bright blue 360-foot-high dome houses a shopping center in downtown Ankara, Turkey. Stockholm, Sweden, boasts a 280-foot-high dome enclosing a new civic center.

Dome design is governed by some basic principles. A sphere can be covered with precisely 20 equilateral triangles; for a geodesic dome, those triangles are carved into smaller ones of different sizes. But to cover a sphere or ellipsoid with various sizes of pentagons and hexagons required another technique, Yacoe says.

Yacoe eventually realized that he could build a dome of polygonal panels guided by the principle that one point on each side of every panel had to be tangent to (or touch) an imaginary circumscribed dome. With the assistance of William E. Davis, a retired mathematician, he set out to describe the problem mathematically.

They began with a ring of at least six congruent pentagons wrapped around the equator of an imaginary ellipse. The task: find the lengths of the sides and the interior angles of the polygons that form the next ring.

To do so for an ellipsoidal dome, they imagined inscribing an ellipse inside each polygon. Each ellipse touched another at one point; at these points, the sides of the polygons would also be tangent to a circumscribed ellipsoid. But where, precisely, should the points be located? Yacoe and Davis guessed, then plugged the numbers into equations that describe ellipses and intersecting planes. Aided by a personal computer, they methodically tested many guesses until the equations balanced. Using the tangent points, Yacoe and Davis could then calculate the dimensions and interior angles of the corresponding polygons and so build the next ring of the dome.

After receiving the patent, Yacoe promptly set up a consulting firm to license his patents. He says dome-home builders have shown considerable interest, as has Spitz, Inc., a maker of planetariums located near Yacoe in Chadds Ford, Pa. Yacoe has also proposed that the National Aeronautics and Space Administration consider a geotangent structure as part of a space station. -E.C.

## What are the advantages (and disadvantages) of Dome Life?

asemon@esu.edu (Alan Semon) writes:

>I was once interested in the idea of living in a geodesic dome home and,  
>to the best of my recollection, these are some of the advantages:

- >  
>1. Heating and cooling the home become more efficient due to the fact  
>that there are fewer (even no) corners where heat may be trapped. The  
>overall air flow in a dome is substantially better than in a  
>conventionally constructed home (straight walls and such).  
>  
>...and there is less surface area per square foot of living space = less  
heat loss.
- >2. Many dome home designs allow the option of using larger lumber for  
>the dome. 2x6's or 2x8's instead of the usual 2x4's, although this is  
>an option in ANY home, it seems to be more commonly done in dome home  
>construction.  
>  
Although for many areas of the US, there is no financial advantage to  
using 2x6 construction. A dome with R-14 throughout can outperform a  
well insulated conventional house of comparable S/F.
- >3. For those solar minded people, the placement of the solar collectors  
>on the ``roof'' is less critical due to the curved nature of the top of  
>the structure.  
>  
>4. The inherent strength of the dome makes it suitable for either  
>earth-bermed or even earth covered construction techniques. In the case  
>of more common construction techniques, the structural members'  
>dimensions usually need to be completely reworked in order to carry the  
>extra weight.  
>  
>5. Hell, they LOOK pretty neat! This might be a problem in certain  
>areas which one of those laws which say that all homes in an area MUST  
>conform to certain guidelines concerning their architecture (bummer,  
>huh? :-)).

-jg

[Based in part on a Brewer Eddy post]

The curved walls in a dome require either custom furnishings, 100% prefab design, or an ``open spaces'' approach. Each of these would be an advantage or disadvantage in one person's eyes or another's.

Mass producing domes is easy, greatly reduces the cost and could solve many of the housing shortage problems worldwide (especially emergency housing needs).

## **How to use solar panels in domes? [Kerri Brochard]**

[From Tom Dosemagen]

I have a dome and tried to find solar panels to be installed on the dome. I had no luck finding such a beast so I installed 320 square feet of panels on the ground close to the dome and ran all connections under ground into the basement. I live in south central Wisconsin and my experience with solar is not the greatest. My system works fine, but in order for the system to work the sun has to shine. That doesn't happen a lot here until late February or early March. My advice to people in our part of country is to take the money you were going to spend on solar and invest it. Then take your interest money and pay for conventional heat. My dome is 44 feet in diameter and with a 90% efficient furnace and my total heating bill for one season is right around \$350.00. My exterior walls are framed with 2x6's. With thicker dome walls I'm sure that I could lower my heating costs by quite a bit.

## 4.2 Dome Math: What you've all been waiting for!!!

### Dome Theory

[From Kirby Urner.]

The edges of a geodesic dome are *not* all the same length. The angstrom measurements between neighboring carbon atoms in a fullerene are likewise not equal.

Domes come in three Classes (I, II and III). The classification system has to do with laying an equilateral triangle down on a grid of smaller equilateral triangles, lining up corners with corners -- either aligning the triangle with the grid (I), turning it 90 degrees to bisect grid triangles (II), or rotating it discretely to have it cut skewly across the grid (III).

20 of these triangles make an icosahedron which is then placed within a circumscribing sphere. The vertexes of the triangles' internal points, defined by the grid pattern, define radii with the circumscribing sphere's center. By pushing each vertex further out along the segments so defined, until each is made equidistant from the center, an omnitriangulated geodesic sphere is formed (orthonormal projection I think cartographers call this). Again, resulting surface edge lengths are not all the same length. The resulting mesh will always contain 12 sets of 5 triangles organized into pentagons, the rest into hexagons.

The Class I version of the algorithm above always creates  $20F^2$  surface facets where  $F=1$  gives the icosahedron itself. The external point population will be  $10F^2+2$ . Since points plus facets = edges plus 2 (Euler), you will get  $30F^2$  edges.  $F$  is what Fuller called the Frequency of the geodesic sphere and, in the Class I case, corresponds to the number of grid intervals along any one of the 20 triangle edges.

Note: "buckyballs" in the sense of "fullerenes" are not omnitriangulated (the edges internal to the 12 pentagons and  $n$  hexagons have been removed) and come in infinitely more varieties than the above algorithm allows. The above algorithm is limited to generating point groups with icosahedral symmetry -- a minority of the fullerenes are symmetrical in this way, although  $C_{60}$ , the most prevalent, is a derivative of the Class I structure.

[From Ben Williams]

Andrew Norris writes:

```
>1/ Given a dodecahedron with the edges of length unity, what is
> the radius of the sphere that would enclose this body?
>
>2/ For the above case, construct each pentagon out of triangles.
> What are the angles required so that new center-node of the
> pentagon just touches the enclosing sphere?
```

This is just a 2 frequency (what-is-referred-to-in-Domebook II-as) triacon geodesic sphere. Funny you should mention that: Back in June when I first discovered this newsgroup, I got reinterested in my old hobby of building mathematical models (and R B Fuller as well). So I went through the laborious process of calculating the strut lengths to build a 2v triacon sphere (what you just described above) out of toothpicks. I have it hanging up over my monitor right now. I wish I could show how I used geometry and such to figure all the necessary lengths out. What I do is start out with a drawing of a dodecahedron projected onto a plane -- if it is oriented correctly, you will get a 2-d figure that you can use to deduce the information you want from it. (To get this figure, think of a dodecahedron made out of struts (such as toothpicks) standing on one of its edges on a sheet of paper out in the sun with the sun directly overhead. The shadow on the paper will be this figure.) These are the lengths I derived

$E$  = length of edge of dodecahedron Distance of edge of dodecahedron from center:

$$E_r = ( (3 + \sqrt{5})/4 ) * E$$

1/2 distance between non-adjacent vertices of face of dodecahedron:

$$b = ( (\sqrt{5}+1)/4 ) * E$$

given a face of dodecahedron, distance between vertex and opposite edge:

$$h = ( ( \sqrt{5 + 2*\sqrt{5}} ) / 2 ) * E$$



distance from center of dodecahedron to one of its vertices (your question 1):

$$R = \text{sqrt}((9 + 3*\text{sqrt}(5))/8) * E$$

given a face of dodecahedron, distance from its center to an edge:

$$l = b/h * E_r$$

distance from center of face of dodecahedron to center of dodecahedron:

$$m = E_r/h * E_r$$

given face of dodecahedron, distance from center to vertex:

$$t = h-l$$

length of one of those struts going from a vertex of dodecahedron up to point above center of face but on the enclosing sphere:

$$S = \text{sqrt}(t^2 + (R-m)^2)$$

Now, to derive the angles of one of those triangles whose side lengths I have just determined, you would need to do this:

$$A1 = 2 * \arcsin ((E/2)/S)$$

This is the angle of the top corners of the 5 triangles which are arched above one of the faces of the dodecahedron. My calculator gives me this angle in degrees: 67.66866319 Notice it is slightly less than the 72 degrees it would be if they were flat on the face of the dodecahedron. Now the other two angles of each of the triangles are simply derived via:

$$A2 \text{ and } A3 = (180 - A1) / 2$$

I get a value of 56.1656684 degrees for these two angles.

## What are the basics of Spherical Trigonometry?

On Sat, 18 Dec 1993 03:11:53 GMT <scimatec5@UOFT02.UTOLEDO.EDU> said:

>Hey all,

> A while back I asked about calculating chord factors. I found the  
>equation that without which I don't think I could have done it (by the way I  
>was successful)-- it's a formula for calculating w/any spherical right  
>triangle. The formula is  $\sin a = \sin A * \sin c$ .

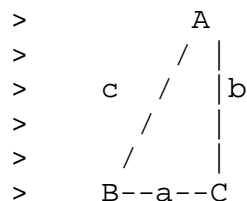

>I'm sure you're all familiar w/it, but is there any other equation that would  
>be just as helpful.

This is by Napier's rules. Here is Napier's circle:

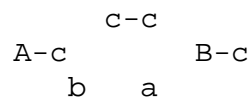

where -c means the complement (or 90 degrees - (minus) the arclength measure). A, B are angles, C is the right angle and a, b, c are the sides opposite A, B, and C, respectively. There are two rules:

### Rule 1:

The sine of any unknown part is equal to the product of the cosines of the two known opposite parts. Or  $\sin = \cos * \cos$  of the OPPOSITE parts.

## Rule 2:

The sine of any unknown part is equal to the product of the tangents of its two known adjacent parts. Or  $\sin = \tan * \tan$  of the ADJACENT parts.

Your formula is the same because  $90 - c = 90 - c$  and  $\sin(90 - c) = \cos(c)$ . Examples:  $\sin(b) = \tan(A - c) \tan(a)$  or  $\sin(b) = \cos(c) \cos(B - c)$ .

>

>

Chris Fearnley

Steve Mather

## How to tessellate a sphere?

[From an old comp.graphics FAQ, posted by Christopher McRae 14 Apr 1993.] One simple way is to do recursive subdivision into triangles. The base of the recursion is an octahedron, and then each level divides each triangle into four smaller ones. Jon Leech [leech@cs.unc.edu](mailto:leech@cs.unc.edu) has posted a nice routine called `sphere.c` that generates the coordinates. It's available for FTP on <ftp://ee.lbl.gov> and [weed eater.math.yale.edu](ftp://weed eater.math.yale.edu).

## Chord Factors - the nitty gritty.

First choose a tessellation of the sphere (icosa, octa, tetra, elliptical or really just about anything. Second use geometry and spherical trig to determine the surface arclengths for the specific tessellation. Third observe that in any circle a central angle cuts off an arc with the same exact measure. Next, calculate the chord factors:  $cf = 2 \sin(\theta/2)$ , where  $\theta$  is the central angle. Finally, multiply each chord factor by the radius of your dome.

Several dome books use the term "alternate" to refer to Class I domes (actually it seems Joe Clinton in his paper on domes has determined several methods for class I subdivisions - his method I is the "alternate" form). The other popular subdividing scheme is based on the rhombic triacontrahedron and is called "triacon."

[From Steve Mather]

Hey all, I have some questions to ask about the trigonometry behind geodesic domes. Remarkably, I've understood what I've encountered so far, and am well on my way to calculating the the chord factors for a 5v icosa alternate (Why? when I can look it up in a book? Well, I figured I'd prove to myself I can.) I've been able to find those along the direct projection from the icosahedron (are 0.198147431 w/central angle of 11.3716678 degrees, 0.231597598 w/central angle of 13.29940137, and 0.245346417 w/central angle of 14.09281254 accurate beginnings for the outside?

[A big thanks to Steve for calculating and typing in all this for us!!! I'm not certain about the results, but he did such a careful job that I suspect they are correct. I'm sure someone will check this more carefully. Please let me know of any problems.]

The letters begin at the bottom of the horizontal edges to the triangle, from "a" to whatever letter (depending upon the frequency -- "a" is the very bottom, as well as the sides.) The numbers are the chord factors.

The way I calculated my factors was like this:

I took the frequency (f) and divided the degree of the central angle of that frequency. I then multiplied this number times the number of rows down the row of lines are (check figure.) I took the sine of this number and multiplied it times the sine of the face angle (the angle between the great circles) to find the sine of half of the angle across the row (whew-- is this making any sense? =) I then multiply this angle times two and divide by the number of rows down (check second sentence and figure.)

This gives me the angle of the geodesic I want. I then take these numbers and divide by two, take the sine and multiply by two, to find the chord factor. These chord factors are multiplied times the radius to get their lengths.

Here are the equations used:

f= frequency

n= number of rows

A= face angle

All numbers are in degrees

$$2 \sin^{-1}((\sin((63.43494885/f)*n))*\sin A))$$

(the extra ") shouldn't be there. sorry, my computer's acting up, and for some reason I can't delete it.) That was the equation for getting the geodesic. The chord factors are done from those by the following equation:

$$\text{Angle} = v \cdot 2 \sin (v/2)$$

2v icosahedron:      b= 0.6257378602  
                                  a= 0.5465330581

3v:                      c= 0.4240625600  
                                  b= 0.4038282455  
                                  a= 0.3669588162

4v:                      d= 0.3212440714  
                                  c= 0.3128689301  
                                  b= 0.2980880630  
                                  a= 0.2759044843

5v:                      e= 0.2581842991  
                                  d= 0.2539357295  
                                  c= 0.2465769121  
                                  b= 0.2357285878  
                                  a= 0.2209776479

6v:                      f= 0.2156929803  
                                  e= 0.2132468999  
                                  d= 0.2090569265  
                                  c= 0.2029619174  
                                  b= 0.1947619676  
                                  a= 0.1842631079

7v:                      g= 0.1851588097  
                                  f= 0.1836232302  
                                  e= 0.1810112024  
                                  d= 0.1772461840  
                                  c= 0.1722282186  
                                  b= 0.1658460763  
                                  a= 0.1579992952

8v:                      h= 0.1621725970  
                                  g= 0.1611459677  
                                  f= 0.1594077788  
                                  e= 0.1569181915  
                                  d= 0.1536238835  
                                  c= 0.1494619675  
                                  b= 0.1443671359  
                                  a= 0.1382831736

9v:                      i= 0.1442501297  
                                  h= 0.1435301153  
                                  g= 0.1423149814  
                                  f= 0.1405824320  
                                  e= 0.1383022055

d= 0.1354375402  
c= 0.1319478012  
b= 0.1277927679  
a= 0.1229389715

10v: j= 0.1298874025  
i= 0.1293630412  
h= 0.1284801673  
g= 0.1272255402  
f= 0.1255810391  
e= 0.1235242767  
d= 0.1210296754  
c= 0.1180702193  
b= 0.1146200925  
a= 0.1106583339

11v: k= 0.1181213623  
j= 0.1177276963  
i= 0.1170660293  
h= 0.1161281074  
g= 0.1149025743  
f= 0.1133752524  
e= 0.1115296266  
d= 0.1093476232  
c= 0.1068107860  
b= 0.1039019434  
a= 0.1006074045

12v l= 0.1083071374  
k= 0.1080040870  
j= 0.1074954030  
i= 0.1067757281  
h= 0.1058376643  
g= 0.1046719125  
f= 0.1032675068  
e= 0.1016121871  
d= 0.09969296006  
c= 0.09749689909  
b= 0.09501222476  
a= 0.09222967293

13v m= 0.09999681431  
l= 0.09975856278  
k= 0.09935906240  
j= 0.09879471539  
i= 0.09806054042  
h= 0.09715024635  
g= 0.09605635362  
f= 0.09477038423  
e= 0.09328314541  
d= 0.09158513461  
c= 0.08966709201  
b= 0.08752071743  
a= 0.08513955025

14v n= 0.09286965560  
m= 0.09267896531

l= 0.09235948034  
k= 0.09190871293  
j= 0.09132321201  
i= 0.09059860431  
h= 0.08972966070  
g= 0.08871039868  
f= 0.08753423341  
e= 0.08619419334  
d= 0.08468321460  
c= 0.08299452818  
b= 0.08112214654  
a= 0.07906144555

15v           o= 0.08668999531  
              n= 0.08653500116  
              m= 0.08627549580  
              l= 0.08590971508  
              k= 0.08543520816  
              j= 0.08484886148  
              i= 0.08414693683  
              h= 0.08332512917  
              g= 0.08237865120  
              f= 0.08130235310  
              e= 0.07955142649  
              d= 0.07873891823  
              c= 0.07724141051  
              b= 0.07559395328  
              a= 0.07379316114

Octahedron geodesics:  
alternate only

2v:           b= 1.0000000000 (exact)  
              a= 0.7653668647

3v:           c= 0.7071067812  
              b= 0.6471948470  
              a= 0.5176380902

4v:           d= 0.5411961001  
              c= 0.5176380902  
              b= 0.4701651493  
              a= 0.3901806440

5v:           e= 0.4370160244  
              d= 0.4253582426  
              c= 0.4032283118  
              b= 0.3667034258  
              a= 0.3128689301

6v:           f= 0.3360254038  
              e= 0.3594040993  
              d= 0.3472963553  
              c= 0.3280400675  
              b= 0.2996195680  
              a= 0.2610523844

7v:                   g= 0.3146921227  
                      f= 0.3105694162  
                      e= 0.3032077023  
                      d= 0.2918376001  
                      c= 0.2754043542  
                      b= 0.2528648441  
                      a= 0.2239289522

I hope I typed those all in right.

## 4.3 How to build a geodesic dome?

[From Trevor Blake]

If there is any one Frequently Asked Question online in the 'Fuller School' (an unsupervised collection of mailing lists, Web pages and other online forums relating to R. Buckminster Fuller ) it is ``How do I build a geodesic dome?''

Trevor's web page, [How to Build a Geodesic Dome](#), isn't comprehensive but might get you started.

## 4.4 Did Fuller invent the Dome?

[From Lloyd Kahn]

Fuller did not invent the geodesic dome. It was invented by Walter Bauersfeld of the Zeiss Optical Works in Jena, Germany in 1922, and the first use of it was as a planetarium on the roof of Zeiss that year.

[Geodesic Domes and Charts of the Heavens](#) gives further background.

[From Chris Fearnley]

However, Fuller was awarded several patents for the dome. Among them are US patent #2682235 (1954), US patent #288171 (1959), US patent #2905113 (1959), US patent #2914074 (1959), etc. Moreover, Fuller was the one who popularized the technology and pointed out the dome's advantages and the reasons for its great strength.

Since Bauersfeld conceived of his structure merely as a planetarium projector (a truly impressive feat) whereas Fuller had a more comprehensive vision of the geometrical and engineering significance of the dome. Which man should win history's designation as "The inventor of the dome"? I'll let the historians and the pundits debate that one.

## 4.5 Dome References

### **Geodesic Dome websites**

The locations of Dome websites changes frequently. The FAQ editor maintains a listing at <http://www.CJFearnley.com/buckyrefs.html#geodesicdomes>. Kirby Urner maintains one at <http://www.grunch.net/synergetics/domes/domeman.html>, and the Buckminster Fuller Institute maintains a list at <http://www.bfi.org/domes/makers.htm>.

### **Dome Vendors**

The list below has been enhanced by contributions from Joe Moore, Gary Lawrence Murphy, Garnet MacPhee, Robert Holder, and Matthew V. J. Whalen. This list is alphabetical. AT&T's [AnyWho service](#) provides a way to check for current information about any company including these vendors.

Affordable Dome Ceilings Inc  
Melbourne, FL 32935

Updated: Oct 2002  
Tel: 321-259-759

Aluminum Geodesic Domes and Spheres Updated: Oct 2002  
2111 Southwest 31st Avenue Edwin O'Toole  
Hollywood, FL 33021 Tel: 954-963-2341 Fax:

American Geodesics, Inc. Updated: Oct 2002  
1505 Webster St. Ben Rose  
Richmond VA 23220-2319 Tel: 804-643-3184  
a.k.a. Semispheres Building Systems

American Ingenuity, Inc. Updated: Oct 2002  
8777 Holiday Springs Road  
Rockledge, FL 32955-5805 Tel: 321-639-8777  
Planning kit; Video; EPS Foam covered w/concrete Shells  
<http://www.aidomes.com/>

Applied Geodesics, Inc. Updated: Nov 2002  
P.O. Box 61741  
Vancouver, WA. 98660 Tel: 877-518-1110  
<http://www.agidomes.com/>

Asphalt Sealcoating Products Updated: Oct 2002  
2111 Sw 31st Avenue  
Hollywood, FL 33021 Tel: 305-625-9436

Astro-Tec Inc Updated: Oct 2002  
550 Elm Ridge Avenue  
Canal Fulton, OH 44614 Tel: 330 854 2209  
<http://www.astro-tec.com/>

Charter Industries Inc Dome Strctrs Updated: Oct 2002  
5325 Barclay Drive  
Raleigh, NC 27606 Tel: 919-859-1872

Common Wealth Solar Svcs. Updated: Oct 2002  
12433 Autumn Sun Lane  
Ashland VA, 23005 Tel: 804-798-5371  
<http://www.commonwealthsolar.com/>

Conservatek Updated: Nov 2002  
498 Loop 336 E.  
Conroe, TX 77301 Tel: 800-880-3663 Fax: 936-539-5355  
<http://www.conservatek.com/>

Deery Development Inc Updated: Oct 2002  
28101 South Yates Avenue  
Beecher, IL 60401 Tel: 708-946-9292

Dome Inc Updated: Oct 2002  
2550 University Avenue West  
Saint Paul, MN 55114 Tel: 612-333-3663  
<http://www.domeincorporated.com/>

Domelite of Arizona Updated: Oct 2002  
Phoenix, AZ 85034 Tel: 602-264-6631  
<http://www.domeliteaz.com/>

Domes America, Inc. Updated: Oct 2002

126 S. Villa Ave. Bob Casey  
Villa Park, IL 60181 Tel: 630-993-1801  
Fax: (630) 993 1809  
800-323-5548  
<http://www.arcat.com/arcatcos/cos32/arc32021.cfm>

Domes Northwest Updated: Nov 2002  
335 Vedelwood Drive  
Sandpoint, Idaho 83864 Tel: 208-255-4840  
<http://www.domesnorthwest.com/>

Domtec International Updated: Oct 2002  
4355 N Haroldsen Drive  
Idaho Falls, ID 83401 Tel: 208-522-5520  
<http://www.domtec.com/>

Econ-O-Dome Updated: Oct 2002  
RR 1, Box 295B  
Sullivan, IL 61951 Tel: 1-888-DOME-LUV (1-888-366-3588)  
<http://www.one-eleven.net/econodome/>  
fazechange@one-eleven.net

Energy Structures, Inc. Updated: Oct 2002  
893 Wilson Avenue Joe & Kevin Frawley  
St. Paul, MN 55106 Tel: 651-772-3559 Fax: 612-772-1207  
800-334-8144  
<http://www.intlist.com/>

Fourth Dimension Housing Updated: Oct 2002  
190 N. Livingston Bay Rd.  
Camano Island, WA 98282 Tel: 360-387-1438  
<http://www.archdome.com/> 1-888-301-7715

Geocon Manufacturing Inc Updated: Oct 2002  
1502 Antelope Road  
White City, OR 97503 Tel: 541 826 4545

Geodesic Domes and Homes Co. Updated: Oct 2002  
P.O. Box 575 Larry Knackstedt Ray Howard  
Whitehouse, TX 75791 Tel: 903-839-2000  
<http://www.domehomes.com/> Fax: (903) 839 7228  
(800) 825-2389  
email: sales@domehomes.com  
<http://www.domehomes.com>

GeoDomes Woodworks Updated: Oct 2002  
6876 Indiana Avenue, Suite L Bob Davies & Glenn Van Doren  
Riverside, CA 92501 Tel: 909-787-8800 Fax: 909-787-7089  
Home Planning Guide; Wood kits

Geometrica, Inc. Updated: Nov 2002  
908 Town & Country Blvd., Suite 330  
Houston, TX 77024 Tel: 713-722-7555 Fax: 713-722-0331  
<http://www.geometrica.com/>

Geo Tech Systems. Inc. Updated: Nov 2002  
Corporate Office



775 Bunker Hill Rd.  
South Tamworth, NH 03883                      Tel: 603-323-8180  
<http://www.domes.to/>

Hexadome                                              Updated: Nov 2002  
Glencor International  
PO Box 519  
Mount Compass  
South Australia 5210                      Tel: (08) 8556 8701  
<http://members.ozemail.com.au/~hexadome/>

Good Karma Domes                                      Updated: Nov 2002  
James Lynch  
3531 S.W. 42nd street  
Oklahoma City, OK 73119                      Tel: 405-685-4822  
<http://www.goodkarmadomes.com/>

Growing Spaces                                      Updated: Nov 2002  
P.O. Box 5518  
Pagosa Springs, CO 81147                      Tel: 800-753-9333  
<http://geodesic-greenhouse-kits.com>

Hexadome                                              Updated: Oct 2002  
Gene Hopster  
El Cajon, CA 92020                      Tel: 619 440 0434

Key Dome Inc.                                              Updated: Oct 2002  
10393 Southwest 186th                      Peter Vanderklaaw  
Miami, FL 33157                              Tel: 305-233-9000  
[From Bruce Carroll]: If your looking just for plans/blueprints, try Key  
Domes, in Miama, FL (305)-665-3541. They have 3 different types of plans  
(foam/concrete, plywood on 2X4/6, and plywood panels).

KCS (KingDomes)                                      Updated: Oct 2002  
P.O. Box 980427                              Einar Thorstein  
Houston, TX 77098                              Tel:                              Fax:  
EDC Booklet (European design, 163 solutions, kits, math)  
<http://www.mmedia.is/kingdome/>

Littlewood Geodesic Domes                              Updated: Nov 2002  
3814a - 53a Street  
Wetaskiwin, Alberta  
Canada T9A 2T7                              Tel: (780) 352-2569 or 497-0513  
<http://www.freenet.edmonton.ab.ca/domes/>

Monolithic Constructors, Inc.                              Updated: Oct 2002  
177 Dome Park Place                              Tel (972)483-7423 - Fax (972)483-6662  
Italy, TX 76651                              Tel: 800-608-0001                      Fax:  
Video; Free brochure; Concrete Domes  
<http://www.monolithicdome.com/>

Natural Spaces Domes                                      Updated: Nov 2002  
37955 Bridge Road,                              Dennis Johnson  
North Branch, MN 55056                      Tel: 800-733-7107                      Fax:  
Local Phone: 651 674 4292  
``All About Domes``; Video; Wood kits; Dome building classes  
[Tom Dosemagen] Inquire about their ``All About Domes`` book. Dennis has

developed two different hub and strut systems for constructing domes. The people at Natural Spaces, who have been in the dome business for over 20 years, feel that the best way to insulate a dome is with fiberglass insulation.

<http://www.naturalspacesdomes.com/>

Natural Habitat Domes Updated: Oct 2002  
N4981 County Road "S"  
Plymouth, WI 53073 Tel: 920 893 5308  
<http://www.naturalhabitatdomes.com/>

New Age Construction Co. Updated: Nov 2002  
13288-T Domes Ridge  
Duncanville, AL 35456 Tel: 205-758-1996  
<http://www.newagedomeconstruction.com/>

Northface Unverified  
999 Harrison Court Bruce Hamilton  
Berkeley, CA 94710 Tel: 415-527-9700 Fax:

Oregon Dome, Inc. Updated: May 1999  
25331 Jeans Rd. Roger & Linda Boothe  
Veneta, OR 97487 Tel: 541-935-5444  
Phone: (800) 572-8943  
<http://www.domes.com/>

Pacific Domes Updated: Nov 2002  
247 Granite Street  
Ashland, OR 97520 Tel: 1-541-488-7737  
1-888-488-8127  
<http://www.pacificdomes.com/>

P.D. Structures Updated: Nov 2002  
180-4 Poplar St. Robert Gray  
Rochester, NY 14620 Tel: 585-256-3918  
[rwgray@rwgrayprojects.com](mailto:rwgray@rwgrayprojects.com)  
<http://www.rwgrayprojects.com/company/company.html>  
Pillow Domes

Pond-Brook Products Unverified  
P.O. Box 301 Gladys Payne  
Franklin Lakes, NJ 07412 Tel: Fax:  
Hexa-Pent Dome Plans

Precision Structures LLC Updated: Oct 2002  
2565 Potter St.  
Eugene, OR 97405 Tel: Fax:  
Book: ``Professional Dome Plans''; See Mother Earth News, 1-90  
A book of detailed shop drawings and formulas for building wood framed,  
3v icosahedron, panelized geodesic domes.  
<http://www.domeplans.com/>

Shadow Wood Domes Inc Updated: Nov 2002  
15250 South Paradise Lane  
Mulino, OR 97042 Tel: 503 829 6370  
AnyWho Categories: Dome Structures

Shelter Systems-OL Updated: Nov 2002  
224 Walnut St. Bob Gillis  
Menlo Park, CA 95060 Tel: 650-323-6202 Fax: 650-323-1220  
Large dome tents, greenhouses, etc.  
<http://www.shelter-systems.com/>

Solardome Industries Ltd. Updated: Nov 2002  
P.O. Box 767  
Southampton, SO16 7UA  
United Kingdom Tel: +44 (0) 23 80 767676  
<http://www.solardome.co.uk/>

Starnet International Corp. Updated: Nov 2002  
200 Hope St.  
Longwood, FL 32750 Tel: 407-830-1199 Fax: 407-830-1817  
<http://starnetint.com/>

Stromberg's Chicks & Gamebirds Updated: Nov 2002  
100 York Street  
Pine River, 4, MN 56474 Tel: 218-587-2222 Fax:  
Starplate struts to build a dome shed/greenhouse up to 14' diam  
[http://www.strombergschickens.com/starplate\\_building\\_system/starplate\\_index.htm](http://www.strombergschickens.com/starplate_building_system/starplate_index.htm)

Synapse Domes (name may be defunct) Updated: Nov 2002  
Marshall Brasil and Scott Sims  
Brasel & Sims Construction Co  
1290 N 2 St  
Lander, WY 82520  
307-332-5773  
This company may involve the principles from Synapse Domes. I have not been able to verify. No websites could be found.

Temcor Updated: Nov 2002  
PO Box 48008  
150 West Walnut Street, Suite 150  
Gardena, CA 90248 Don Richter Tel: 310-523-2322  
800-421-2263 within US  
Large aluminum commercial domes  
<http://www.temcor.com/>

Timberline Geodesics Inc Updated: Nov 2002  
2015 Blake Street Robert M. Singer  
Berkeley, CA 94704 Tel: 510-849-4481 Fax: 510-849-3265  
Catalog; Video Tape; Wood kits  
Toll-Free: 800-366-3466 (1-800-DOME-HOME)  
<http://www.domehome.com/>

Ultraflote Corp. Updated: Nov 2002  
8558-T Katy Freeway, Suite 100  
Houston, TX 77024 1809 Tel: 713-461-2100 Fax: 713-461-2213

Western Poly Dome Updated: Nov 2002  
23430 High Bridge Road  
Monroe, WA 98272 Tel: 360 794 4645

Worldflower Garden Domes Updated: Nov 2002

P.O. Box 2103  
Georgetown, Tx. 78627  
<http://www.gardendome.com/>

Tel: 512 863 2762

SouthEastDomes.com & TacoDome.co are Divisions of:  
World Merchandising Company Updated: Nov 2002  
160 Bream Lane  
Kingston, TN 37763  
David Martin Tel: 865-376-2161  
<http://david.martiniiii.tripod.com/index-2.html>

## Other Dome References

DOMES is (was?) a magazine about the geodesic dome (ISSN 1041-1607). Published quarterly by:

Hoflin Publishing Ltd.  
4401 Zephyr Street  
Wheat Ridge, Colorado 80033-3299  
Phone 303/420-2222 (7:30 am to 3:30 pm Denver time)

Thomas Register of American Manufacturers Updated: May 1999  
One Penn Plaza  
New York, NY 10001 Tel: 212-695-0500 Fax:  
See Volumes 1-10: Products & Services (in most libraries)

Thomas' web page is at <http://www.thomasregister.com/>

National Dome Council Updated: May 1999  
1201 15th Street, N.W.  
Washington, DC 20005 Tel: 800-368-5242, ext. 576  
<http://www.buildingsystems.org/btgdg.html>

[From Alex Soojung-Kim Pang]

The two Domebooks -- Domebook, and Domebook Two -- were published in the early 1970s and are now out of print. They were written in much the same fashion as the Whole Earth Catalog, with readers sending in descriptions of their experiences and problems with domes, and the book's staff arranging the pieces, working in photographs and line drawings, etc. They are still often available in libraries, or through university interlibrary-loan. The full citation is:

Lloyd Kahn, et al. Domebook (One). Los Gatos: Pacific Domes, 1970. Lloyd Kahn, et al. Domebook Two. Bolinas, CA: Pacific, 1971. (Distributed by Random House)

[Editor: Warning: The math in these books is known to be inaccurate.]

There was also a book edited by John Prentis (or Prentis, maybe) called The Dome Builders Handbook (Philadelphia: Running Dog Press, ca. 1975). There were two editions of this, as well.

Lloyd Kahn has published three other books that contain information on dome-building: Shelter (which described a wide variety of self-built homes from all over the world), Shelter II (ISBN 0-394-50219), and a pamphlet called Refried Domes (Bolinas: Shelter Publications, 1990) (ISBN 0-936070-10-2). The latter contains the chord factors and angles for 8-frequency domes (critical information, and unavailable anywhere else as far as I can tell), suggestions about construction, and some second thoughts about domes as permanent shelter. If these books are not in your bookstore, you can order them directly from

Shelter Publications  
Home Book Service  
P.O. Box 279  
Bolinas, CA 94924

<http://www.shelterpub.com/>

If you're interested in learning something about the history of domes in the counterculture, look up Charles Jencks and William Chaitkin, *Architecture Today* (New York: Harry Abrams, 1982). The magazine *Futurist* has also published a couple articles on domes in the last couple years.

Another book to look for Steve Baer, *Dome Cookbook* (Lama Publications, 1968); as I recall, it has tables for computing strut lengths and some useful information about dome construction.

[From Alex Soojung-Kim Pang, 25 Feb 1992]

Gene Hopster, *How to Design and Build Your Dome Home*  
(Tucson: HP Books, 1981)

Edward M. Duke, *A Study of the Geodesic Dome Applied  
to Housing* (Monticello: Council of Planning  
Librarians, 1973)

John Fontanetta, *Building a Solar-Heated Geodesic Greenhouse*  
(Charlotte, VT: Garden Way, 1979)

[From Garnet MacPhee in NOV 1989.]

There is a national association.

National Association of Dome Home Manufacturers  
2506 Gross Point Road  
Evanston, Illinois 60201

[From Gary Lawrence Murphy and Chris McRae]

Hugh Kenner's "Geodesic Math and How to Use It" Berkeley : University of California Press, c1976. xi, 172 p. : ill. ; 22 cm. (ISBN 0-520-02924-0) This is an excellent book for the hobbyist model builder, but also shows geometric derivations for a number of approaches to carving up the surface of a sphere into the smallest practical number of different shaped parts, which is the key matter in dome fabrication. The book also discusses tensegrity designs, although I believe Hugh has since release a volume devoted to tensegrity. For those without calculators :-), the appendix of the book lists the dome-vertex values for many practical frequencies in the basic polyhedral forms.

[From Alex Soojung-Kim Pang, 25 Feb 1992]

A technically useful book is Edward Popko, *Geodesics* (Detroit: U. Detroit press, 1968). It has lots of photographs, plans for domes made from a whole host of materials, different assembly methods, etc..

[From Matthew Clark, 28 Apr 1993.] Enchanted West, Inc. manufactures lightweight, precision-molded, fiberglass panels for building geodesic domes. Contact us at [mclark@scf.nmsu.edu](mailto:mclark@scf.nmsu.edu) for more information.

[Posted Dec 1991 by Randy Burns]

Another alternative is concrete, earth sheltered domes. These aren't necessarily geodesic structures. Still, they may well be closer to nearing widespread commercial use than most geodesic structures.

Three Companies involved in this:

Utopia Designs, Eugene OR (founded by Norm Waterbury)

These are definitely oriented to the do-it-yourselfer. They specialize in selling forms and blueprints for domes build using inflatable forms.

EarthShips, Eugene, OR

This company was founded by Richard Britz, author of the *Edible City Resource Manual*. They specialize in turnkey structures and are more oriented towards larger developments. Britz does wonderful architectural drawings.

Monolithic Structures, Idaho and Stockton CA

These folks are primarily involved in building \_large\_ structures, mainly industrial buildings and grain silo's.

[More concrete companies from Russell Miller. 1994]

The following three companies deal with concrete shell domes, some of which are geodesic, but none of which are specifically ``Earth Sheltered."

|                                                                                                                           |                                                                        |
|---------------------------------------------------------------------------------------------------------------------------|------------------------------------------------------------------------|
| American Ingenuity inc.<br>8777 Holiday Springs Road<br>Rockledge, Fl<br>32955-5805<br>407-639-8777<br>407-639-8778 (fax) | 40' dia kit: \$13,058<br>Video = \$8<br>Address current as of: 1994-05 |
|---------------------------------------------------------------------------------------------------------------------------|------------------------------------------------------------------------|

|                                                                          |                                                              |
|--------------------------------------------------------------------------|--------------------------------------------------------------|
| Key Dome Engineering inc.<br>P.O. Box 430253<br>South Miami, FL<br>33143 | Plans only<br>Info pack = \$5<br>Address current as of: 1989 |
|--------------------------------------------------------------------------|--------------------------------------------------------------|

|                                                                                                                                    |                                                                               |
|------------------------------------------------------------------------------------------------------------------------------------|-------------------------------------------------------------------------------|
| Monolithic Constructors inc.<br>1 Dome Park Place<br>P.O. Box 479<br>Italy, TX<br>76651-0479<br>214-483-7454<br>214-483-6662 (fax) | 40' dia dome kit: \$2300<br>Video available<br>Address current as of: 1994-02 |
|------------------------------------------------------------------------------------------------------------------------------------|-------------------------------------------------------------------------------|

|                                |                                                                 |
|--------------------------------|-----------------------------------------------------------------|
| Build Your Own Geodesic Model: | A.G.S. Products<br>2111 SW 31 Avenue<br>Pembroke Park, FL 33009 |
|--------------------------------|-----------------------------------------------------------------|

[From Ross Keatinge, 2 Oct 1993]

I know of two dome manufacturers in Australia:

``The Dome Company' at ``Tapitallee' near Nowra NSW. They make house and garden domes 5, 7 and 10 metre diameter. I think they also produce them in kitsets so they may be able to help with hubs etc.

|                 |                                                                        |                    |
|-----------------|------------------------------------------------------------------------|--------------------|
| The contact is: | Rob Lusher<br>The Dome Company<br>PO Box 3043<br>Nth Nowra<br>NSW 2541 | Phone (044) 460452 |
|-----------------|------------------------------------------------------------------------|--------------------|

Tapitallee is a rainforest retreat centre who run seminars on alternative technologies etc as well as personal growth type stuff. I gather some of their buildings are domes. I'm thinking of spending some time there.

|               |                                                              |                     |
|---------------|--------------------------------------------------------------|---------------------|
| The other is: | Bretcod Geodesic Domes<br>27 Allawah Street<br>Blacktown NSW | Phone (02) 621-7952 |
|---------------|--------------------------------------------------------------|---------------------|

He makes all sorts of domes. Since his business is selling completely built domes I'm not sure how helpful he would be.

---

[Next](#) [Previous](#) [Contents](#)

## 5. Other Inventions

Fuller was a tinkerer and made many small tools both to explain his principles and to perform useful tasks. All of his patented inventions can be found in his book *Inventions: The Patented Works of R. Buckminster Fuller*. His second most esteemed invention is "tensegrity" or tensional-integrity structures (See section [Who was Kenneth Snelson and what was his role in the invention of tensegrities?](#) for Kenneth Snelson's role in this.).

### 5.1 What is a tensegrity model?

"The word 'tensegrity' is an invention: a contraction of 'tensional integrity.'

[From [Synergetics \[700.011\]](#)]

"Tensegrity describes a structural-relationship principle in which structural shape is guaranteed by the finitely closed, comprehensively continuous, tensional behaviors of the system and not by the discontinuous and exclusively local compressional member behaviors. Tensegrity provides the ability to yield increasingly without ultimately breaking or coming asunder."

[From Blaine A. D'Amico.]

Fuller stated as a general principle that "tension and compression always and only coexist." There is no way to have tension without corresponding compressional forces in the structure. A tensegrity is a continuous tension - discontinuous compression structure. This is distinguished from traditional structuring which is continuous compression and discontinuous tension.

[From Kirby Urner]

Tensegrity structures employ tension primarily and compression secondarily. In pure tensegrity, compression members (i.e. metal rods) do not touch one another but provide rigidity within a network of tensed cables. Not only domes, but towers (and many sculptures) have successfully employed tensegrity principles. For Fuller, tensegrities manifested his philosophy: that nature uses tension primarily and compression secondarily (whereas humans often misguidedly do the reverse). Although he developed geodesic structures for the Marine Corps and Strategic Air Command, none of these were "tensegrities" exactly. Tensegritoy, available from most museum giftshops and teacher supply catalogs, admirably teaches about tensegrity.

### How to Build Tensegrities?

[From Daryl Bunce]

To me, one of the best tools for help with building Tensegrity systems was/is *An Introduction to Tensegrity* by Anthony Pugh, LOC: TA658.2 P85x, copyright 1976, University of California Press, ISBN: 0-520-02996-8 (cloth/hard) or 0-520-03055-9 (paper), 121pp.

I suggest reading the first few pages of Appendix A then running out and purchasing some .75" dowel (see below) *then* start on page 1.

For struts: dowel (wooden rods) 3 feet long (standard US size), with a diameter = .75 inches. Cut with a fine-toothed saw into 9 inch lengths. Repeat until happy with amount (you'll need more, eventually). Take some 18-gauge wire brads (those nails with virtually no head), about an inch to 1.5 inches long and blunt the points. Warning: Use of steel nails, pins, etc. can be dangerous. Pound two nails into each strut end, with a wide gap between them and at least .5 inches protruding from the wood:

```
                //  
                /  -----o  
STRUT (yeah, right) /  -----o  two brads, repeat for other end  
                //  
                //
```

---

Repeat procedure for all ends of struts. Using rubber bands (#14, 2 inches, or #12, 1.5 inches) hung over one brad/strut, you should be able to model some Tensegrities. BTW: If there were only one brad at each end, the rubber bands have more of a tendency to slip off.

If your rubber bands are still slipping off, stretch one from one end to the other of the same strut before modeling. When you are ready to incorporate this strut, unhook this band, slide a band from the other strut onto a brad on this strut, and hook the original band back on over the new one. (Follow that?)

Most of the above was summarized from Mr. Pugh's book in one way or another.

[From chris@COGNET.UCLA.EDU]

There is a company called Plastruct which makes little plastic components for building various sorts of models. They are located in the City of Industry (I think (greater L.A. area)), California. Any good hobby or architectural supply shop in your area should have a catalog. I warn you, however, that their models are somewhat limited and the plastic tubes used for struts tend to split.

There is also a company in England somewhere which actually owns the design upon which the Plastruct models are based. The components they make are somewhat larger, I believe, and perhaps of higher quality.

If anyone is really interested in more details, I can dig up the names and numbers for you. In general, a good resource for this kind of information is the *Thomas Register of American Manufacturers*, which can be found in many large libraries.

[From Michael Justice, 23 Mar 1992]

Real Goods sells something called a "tensegritoy," which looks kinda cute. To quote from their latest micro-catalog:

#### EXPLORE ARCHITECTURE BUCKY FULLER STYLE

Tensegritoy is an ingenious new construction puzzle that provides fun and intellectual challenge for children over ten. Based on R. Buckminster Fuller's ideas of tensegrity (tension and integrity) over 100 intriguing shapes can be built. The structures can bounce, roll, or seemingly float in the air. With the colorful components you can construct a basic four-sided figure, a helix or a geodesic dome, or explore architecture and the arrangement of DNA! The 32-page illustrated instruction booklet provides lots of how-to ideas. This is truly an affordable learning experience.

90-412 TENSEGRITROY . . . \$29

Real Goods is a yuppie "alternative energy / environmental / whatever-we- can-make-a-buck-on" :- ) mail-order house. 1-800-762-7325 for orders.

[From Patrick G. Salsbury]

Well, Tensegrity Systems, Inc., manufactures the Tensegritoy (tm) and I've seen models built from combined sets that are a meter or more in diameter.

[From Jim Flanagan]

I have found that the cheapest/easiest method for making tensegrity struts is to buy thousands of bamboo skewers, chop



off the pointy bits, and bind two (or more, depending on the tension in the model) together with rubber bands thus:

==x=====x==

then take another rubber band insert it between the two sticks at one end, then with half a turn drag it down to the other end and hook it in there. One completed strut. With practice one person can make a good deal of these in an evening. A hint for keeping the structure together while building is to use another band to keep a connection firm (sometimes a connection will slip. Spectacular explosions attest to the amount of tension is held in one of these structures...).

~~~~  
//  
==x=====x=x=  
//  
//  
//  
~~~~

If you use tan colored bands and tan sticks the aesthetic is better in my opinion. If you twist the bands more than once (but an odd number) you get more tension (which is necessary for higher freq. structures).

[From Mitch Amiano]

**Resources:**

Check out a good boating supply shop. They make use of a number of tensile materials and fasteners.

**Tension members:**

Boating supply shops carry in bulk what might cost you \$\$\$ to get pre-cut: rope, cables, and that elastic cloth cordage (like the kind used in the Tensegritoy). The elastic cord cost about \$13 for a 50 foot roll.

**Tough Tension members:**

Nylon coated steel cable, 3/32 inch, with crimpable aluminum cable sleeves. Use the sleeves to make loops in the cable ends. Cable can be accurately measured by looping around two nails set in a block of wood and pulled tight. Sleeves can be crimped on one at a time. The nylon coating makes it less likely to have wire splinters, and makes for a neater finish.

**Taking up slack:**

Tiny turnbuckles. expensive at >50 cents a pop. Jim Flanagan's idea to increase the tension of the rubber bands by twisting them will work here, too. You just won't be able to twist up very much. Many forms of strain relief hardware can also be used to give springiness to inflexible cables.

**Compression members:**

Aluminum or brass tubing, 3/8 inch diameter. Aluminum costs about \$1 a foot, while brass is about twice as expensive. Neither is hard to cut, given a midget pipe cutter, about \$5.

**Fastening members together:**

A hollow tube may be plugged with a variety of screw anchors, both metal and plastic. Then a small bolt or screw stock can be securely mounted. Some washers are all that's needed to complete the connection if you chose to use bolts. For screw stock, you also need nuts, and can use round-ended chromed nuts for a finer finishing. For both, cable or rope loops can simply be looped on. Make sure the loop is smaller than the washer, or it might slip.

[From Mitch Amiano]

Has anyone seen the in-line cable clamps used for utility-pole guy wires? The clamps do not have any perpendicular bolts, and have a U loop on the ground side (which is tied down). The steel cable goes right through the unit unbroken and untwisted, leaving a small stub of cable out the U loop end. The cable has no connection with the U loop itself - that is part of the connector housing. Finally, the unit is about 6 or 7 (~15cm) inches long, cone shaped, and about an inch and 3/4 thick (~8cm).

The reason I ask, is because it appears to be an ideal connector for a variety of tensegrities - one which I had conceptualized but for which I had not found a good implementation. Does anyone know if similar units exist for other size factors (esp. for desktop modeling), or know if the internal design relies on the use of pincers/teeth to grip? (The latter would make the design less attractive for monofilament lines.)

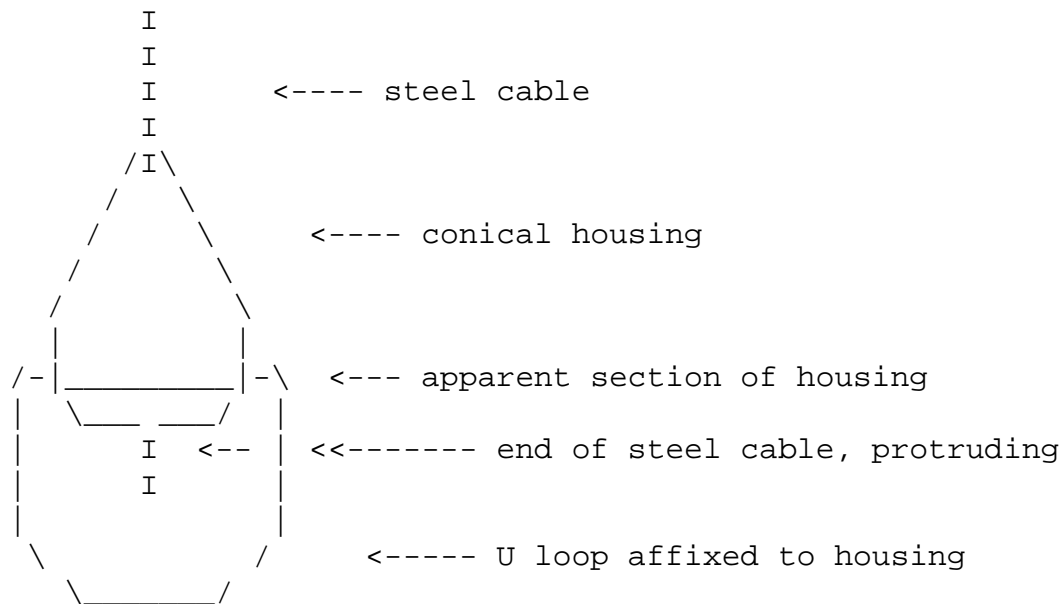

[From H. Jeffrey Rosen]

In-line cable fixtures are commonly stocked by manufacturers and distributors of wire rope. A quick scan of my yellow pages at that category identified a source of many sizes of the U-bolt style clamps used for antenna guy lines. Surely such providers exist in most areas, and can steer you to the particular gadget you seek.

If not, here's the number of the place I contacted:

AYERS WIRE ROPE SERVICE, INC., JACKSON SC (803) 827-1419

## Who was Kenneth Snelson and what was his role in the invention of tensegrities?

Fuller began writing, speaking and thinking about coexistent tension and compression in the 1920's - see his first book *4D Time Lock*. He complained of having no good model to explain these principles. Then Snelson attended several of Fuller's lectures at Black Mountain College in the summer of 1948. In the winter of 1948 Snelson built the first tensegrity structure consisting of two ``X"-shaped figures one suspended above the other in a sea of tension. He showed Fuller this model in the summer of 1949. After this initial contact both men developed the concept of tensegrity in unique and independent ways. Snelson designed large magnificent tensegrity sculptures while Fuller built large tensegrity spheres to demonstrate his synergetics (at that time he called it Energetic Geometry). Both Fuller and Snelson patented their structures.

I think the quote below shows that both Fuller and Snelson acknowledged each other's contribution. Given Fuller's disdain for footnotes and other forms of formal citations, he occasionally implied more credit than is his due. However, it seems to me that he documented Snelson's contribution sufficiently. Claims that Fuller stole Snelson's work are unsubstantiated. Also, claims by some of Fuller's admirers that Snelson stole from Fuller, ignore the breakthrough in design that Snelson contributed.

[From *Kenneth Snelson, an Exhibition* organized by Douglas G. Schultz; essay by H.N. Fox, p.23 ]

``In a letter from Fuller to Snelson dated December 22, 1949, Fuller states, 'In all my public lectures I tell of your original demonstration of discontinuous-pressure- (com-pressure) and continuous tension structural advantage; - in which right makes light [ ? ] in a prototype structure, - the ready reproduction of which properly incorporated in fundamental structures, may advance the spontaneous good will and understanding of mankind by many centuries. The

event was one of those 'it happens' events, but demonstrates how the important events happen where the atmosphere is most favorable. If you had demonstrated this structure to an art audience it would not have rung the bell it rang in me, who had been seeking this structure in Energetic Geometry. That you were excited by the later E.G. [Energetic Geometry], into spontaneous articulation of the solution, also demonstrates the importance of good faith of colleagues of this frontier. The name Kenneth Snelson will come to be known as a true pioneer of the realized good life and good will...'

## **5.2 What are ``cloud nines?''**

[``Cloud nines'' are floating geodesic spheres. The following extract from a paper posted to GEODESIC by Robert T. Bowers explains the idea.] ``When considering a geodesic sphere, the weight of the sphere is a function of the surface of the sphere. The amount the sphere is lifted by warm air is a function of the volume of the sphere. In mathematical terms, weight is a function of the radius squared, while volume is a function of the radius cubed. This is very significant. Even as the radius of a sphere increases, thus increasing the sphere's weight, the lift of the sphere increases more. If you image a sphere that could grow larger, as the sphere gained a little weight, it would gain much lift.

``Buckminster Fuller proposed that as spheres of great size are considered, the amount of air enclosed grows huge compared to the weight of the sphere. Of a sphere with a radius of 1320 feet, the weight of the enclosed air is 1000 times greater than the weight of the sphere's structure. If that volume of air was heated only one degree, the sphere would begin to float!

``Of course, domes of even greater sizes would be required if that sphere were to carry any additional weight. But it is not inconceivable that floating geodesic spheres could carry aloft entire communities. Perhaps the concept of a floating dome of one half a mile diameter is too much for most people to seriously consider. Regardless, it does demonstrate the scope of projects that are made possible with geodesic domes." -Robert T. Bowers Fuller quote from *I Seem To Be A Verb*

Came across this small description which I thought might interest some people who haven't seen it before ...

Geodesic spheres larger than half-a-mile in diameter can be floated in the air, like clouds. Draped with polyethylene curtains -- to retard night-time air intake -- the spheres would be light enough to remain aloft, at preferred altitudes.

``Cloud nines" one mile in diameter could house thousands of people, whose weight would be negligible. Passengers could pass from ``cloud" to ``cloud," or from ``cloud" to ground, as the ``clouds" float around the Earth or are anchored to mountain tops. The ``clouds" could become food factories by impounding sunlight."

-- David Paschall-Zimbel

## **5.3 What is ``dymaxion?''**

``Dymaxion" is a name coined by a friend [ED: an advertising man actually] of Bucky's which is a contraction of the words ``DYnamic" (or DYnamism, depending on your sources), ``MAXimum," and ``ION;" three words that he noticed Bucky used often in his speech when describing things.

Dymaxion, and also 4-D (4th Dimension) became trademarks of Bucky's and were frequently used on his products: -The Dymaxion 4-D House -The Dymaxion Car -The Dymaxion Deployment Unit (war-relief housing) -The Dymaxion Dwelling Machine (An improvement on the Dymaxion 4-D House) - Patrick G. Salsbury

## **5.4 What was the ``Dymaxion Car?''**

``The Dymaxion Car was a teardrop-shaped (least air resistance), 3-wheeled, rear-wheel (single) steering, 21 foot long, Aluminum bodied auto, designed by Bucky to achieve maximum output and service with minimum material input. It was about 6 feet tall (Kinda like a big van), seated the driver and 10 passengers, weighed less than 1000 lbs., went 120 miles/hr on a 90 horsepower engine, and got between 30-50 miles to the gallon of gas! (Depending on your sources,

again.)

``It was eventually supposed to be developed into a flying vehicle, held aloft on ``jet-stilts" (downward facing thrusters of some sort) so as to make all of ``Spaceship Earth" accessible to humans and make it so they could have a house ANYWHERE (on top of a mountain, in a desert, etc. [his Dymaxion Houses were self-sustaining, and didn't need to be tied into powersewer/water lines]/) and still get around to go to work or whatnot. But only the car portion of the ``Dymaxion Omnidirectional Human Transport" (Flying car) was developed, because at the time of development (1933-4), Jet technology was either non-existent, or not capable of the task." - Patrick G. Salsbury

There is a Dymaxion car in the William F. Harrah Automobile Museum in Reno, NV. Very strange-looking vehicle indeed, and I was surprised to find out that it was from the 1930's. -Dan Howell dhowell.escp8@xerox.com

## 5.5 What is a ``fog gun?"

The ``fog gun" was an invention Bucky developed as a water saving alternative to the wastefulness of showers. While Bucky was in the navy, he noted that, while standing on the deck of a ship, in the spray and mist of the sea, nothing seems to stay on your skin for very long. Not even grease. He reasoned that it must have something to do with the abrasive action of the tiny water droplets, so he developed a device that atomized the water (like a perfume bottle with the little bulb that you squeeze to get perfume mist) and ejected it at high speed. He dubbed this the ``fog gun" and found that it worked very well for cleaning a person off without soap (I'm not sure how he did hair, though) and without wasting a lot of water. (The ``gun" could clean a family of four with *1 PINT* of water!) -Pat Salsbury

## 5.6 What was Fuller's ``floating city?"

Around 1967, Bucky Fuller was put in charge of the Triton project for the Dept. of Housing and Urban Development (HUD) (You know, one of the current gov't departments under investigation for all sorts of scandals! ;^)

Triton was a concept for an anchored floating city that would be located just offshore and connected with bridges and such to the mainland. It was a collection of tetrahedral structures with apartments and such. The model looked very interesting!

You can see some photos of the model in ``The Artifacts of Buckminster Fuller," along with technical drawings of just about everything else he ever designed! :) -Pat Salsbury

[Typed in by Charles Nicoll] Reprinted from *Critical Path*, (1981, St Martin's Press) by Buckminster Fuller, p. 332.

``In the early 1960s I was commissioned by a Japanese patron to design one of my tetrahedral floating cities for Tokyo Bay.

``Three-quarters of our planet Earth is covered with water, most of which may float organic cities.

``Floating cities pay no rent to landlords. They are situated on the water, which they desalinate and recirculate in many useful and nonpolluting ways. They are ships with all an ocean ship's technical autonomy, but they are also ships that will always be anchored. They don't have to go anywhere. Their shape and its human-life accommodations are not compromised, as must be the shape of the living quarters of ships whose hull shapes are constructed so that they may slip, fishlike, at high speed through the water and high seas with maximum economy.

``Floating cities are designed with the most buoyantly stable conformation of deep-sea bell-buoys. Their omni-surface-terraced, slop-faced, tetrahedral structuring is employed to avoid the lethal threat of precipitous falls by humans from vertically sheer high-rising buildings.

``The tetrahedron has the most surface with the least volume of all polyhedra. As such, it provides the most possible 'outside' living. Its sloping external surface is adequate for all its occupants to enjoy their own private, outside, tiered-terracing, garden homes. These are most economically serviced from the common, omni-nearest-possible center of volume of all polyhedra.

``All the mechanical organics of a floating city are situated low in its hull for maximum stability. All the shopping centers and other communal service facilities are inside the structure; tennis courts and other athletic facilities are on the top deck. When suitable, the floating cities are equipped with 'alongside' or interiorly lagooned marinas for the safe mooring of the sail- and powerboats of the floating-city occupants. When moored in protected waters, the floating cities may be connected to the land by bridgeways.

``In 1966 my Japanese patron died, and the United States Department of Housing and Urban Development commissioned me to carry out full design and economic analysis of the floating tetrahedral city for potential U.S.A use. With my associates I completed the design and study as well as a scaled-down model. The studies showed that the fabricating and operating costs were such that a floating city could sustain a high standard of living, yet be economically occupiable at a rental so low as to be just above that rated as the 'poverty' level by HUD authorities. The secretary of HUD sent the drawings, engineering studies, and economic analysis to the Secretary of the Navy, who ordered the Navy's Bureau of Ships to analyze the project for its 'water-worthiness,' stability, and organic capability. The Bureau of Ships verified all our calculations and found the design to be practical and 'water-worthy.' The Secretary of the Navy then sent the project to the US Navy's Bureau of Yards and Docks, where its fabrication and assembly procedures and cost were analyzed on a basis of the 'floating city' being built in a shipyard as are aircraft carriers and other vessels. The cost analysis of the Navy Department came out within 10 percent of our cost - which bore out its occupiability at rental just above the poverty class.

``At this point the city of Baltimore became interested in acquiring the first such floating city for anchorage just offshore in Chesapeake Bay, adjacent to Baltimore's waterfront. At this time President Lyndon Johnson's Democratic party went out of power. President Johnson took the model with him and installed it in his LBJ Texas library. The city of Baltimore's politicians went out of favor with the Nixon administration, and the whole project languished. The city of Toronto, Ontario, Canada, and other cities of the U.S.A are interested in the possibility of acquiring such floating cities. Chances of one being inaugurated are now improving.

``In relation to such floating cities it is to be noted that they are completely designed under one authority, and when they become obsolete, they are scrapped and melted and the materials go into subsequent production of a greatly advanced model whose improvements are based on earlier experiences as well as the general interim advances of all technology.

``There are three types of floating cities: There is one for protected harbor waters, one for semiprotected waters, and one for unprotected deep-sea installations. The deep-sea type is supported by submarine pontoons positioned under the turbulence, with their centers of buoyancy 100 feet below the ocean's surface. Structural columns rise from the submarine pontoons outwardly through the water to support the floating city high above the crests of the greatest waves, which thus pass innocuously below the city's lowest flooring, as rivers flow under great bridges. The deep-sea, deeply pontooned floating cities will be as motionless in respect to our planet as are islanded or land-based cities.

``There are also deep-sea spherical and cylindrical geodesic floating cities whose hulls are positioned entirely below the ocean surface turbulence. Only their vertical entrance towers penetrate outwardly through the disturbed surface waters. The occupants of submarine cities with their vertical towers penetrating outwardly above water can be serviced by helicopters landing on the tower-top platforms. Such pontooned or hulled submarine cities also can provide safe mid-ocean docking for atomic-powered cargo- and passenger-carrying submarine transports. With their submarine hulls locked together below the turbulence, a safe passageway can be opened between them.

``Even in mild weather docking cannot be done on the open water surface of the ocean. Even the mildest 'old-sea' or ground swells would roll any two ocean ships' great tonnages into disastrous hull-smashing clashes. Relative mass attraction is proportional to the product of the masses of the interchanges. When any two oceangoing steel vessels come within 'critical proximity,' their interattraction is fourfolded every time the distance between them is halved. This chain-attraction-increasing force pulls them sideways toward one another, ultimately to touch and chew up one another's skins - that is, unless one is maneuvered in time backward or forward away from the other. Land harbors are essential for surface docking or inter-tie-up of ships of any size. There are relatively few big-ship harbors in the world. This fact, and the world-around scarcity of such good harbors as Athens' Piraeus, France's Cherbourg, Italy's Venice, the U.S.A's New York, or Tokyo's Yokohama, have greatly affected the geographical patterning of world history. The new ability to transfer cargoes at sea could completely alter world economic balances and could bring ships once more into economic competition with airplanes. The recent decades' development of seventy-knot submerged speed of the great atomic submarines, complemented by floating cities, could herald the beginning of a new era of subsurface oceanic traffic.

``In due time small cruising yachts also will be able to sail or power around the world in safe, one-day runs from one protected floating city's harbor to the next."

[From Jim Fiegenschue, 12 Oct 1993]

If you are interested in studying and solving some of the practical problems of floating habitations (such as anchoring, survival of storms, etc.) you might contact Sten Sjostrand, the architect who designed The Saigon Floating Hotel. The first and to my knowledge still the only floating resort hotel in the world, it was built in Singapore for about \$22 million in 1987-8 US dollars. Another \$5.5 million of furniture and accessories were added, plus a \$2.5 million special anchor system, so this is a serious professional project. The 7-story hotel has 200 guest rooms, a lavish lobby, a swimming pool(!), a tennis court, a night club, a sauna, a gymnasium, small shops, several restaurants, two cocktail bars, a library, fully equipped conference rooms, post office, sewage treatment plants, facilities for mooring sail boats and yachts, an underwater observatory, and a marine laboratory. Originally opened for business as the Four Seasons Barrier Reef Resort in 1988 over the Australian Great Barrier Reef, it was a big draw for scuba divers. All waste- disposal machinery is sealed off completely to protect the environment. It is currently owned by the Japanese company EIE, who operate it offshore Saigon.

You can possibly reach Sten Sjostrand through the Atlantis Project, which is currently raising funds to build a floating city/nation to be called Oceania. Their newsletter, called Chain Breaker, is located at 4132 S. Rainbow Blvd, Suite 387; Las Vegas, Nevada 89103. Phone: 702 897-8418.

[From Bill Kovarik]

There's a book called ``Engineers Dreams" which depicts a floating city as a mid-Atlantic airport plan from the 1940s. Sometime in the 1970s the University of Hawaii designed a floating city, and you can get the book on interlibrary loan. I know the Virginia Tech architecture school library has it, if you can't find it anywhere else. Both the airport and the Hawaii ideas dealt with structural engineering problems primarily.

There are important reasons to consider floating cities as resources for the not too distant future, I believe.

A very important need is for factories for processing renewable energy resources which would be too expensive or too ecologically disruptive to collect on land. Of course, the most problematic aspect of renewable energy is its dispersed nature. It must be collected and concentrated, and the process of doing that can raise costs to a non-competitive level with fossil energy.

For many decades, biochemical engineers have looked to marine biomass resources as being possible to cultivate in enormous quantities without creating ecological disruptions. As early as 1918 the Pasteur Institute was engaged in the study of renewable liquid fuels like methyl and ethyl alcohol from kelp. They were able to produce about 10 gallons of fuel alcohol per ton using an acid hydrolysis method. This is very old technology; better methods are available today.

In the late 1970s and early 80s tremendous new attention focused on renewable resources, and marine biomass was the subject of a good deal of study. One of the most important was the Marine Biomass Energy Conversion Technology Research Committee of the Japan Ocean Industries Association. In one study they found that a 50 kg / m<sup>2</sup> per year was the average productivity of both Sargassum and Laminaria type kelp. I don't know if they investigated the various energy production scenarios or what their final figures are, but you could probably find out pretty quickly.

If we converted kelp to renewable liquid energy at the rate of 10 gallons per ton, what do we get? Lets assume one ton (1,000 kg) is grown on 20 square meters and produces 10 gallons. To make a million gallons we need an area of 200 square kilometers. To make a billion gallons would take a 2,000 square mile area, and to replace just the gasoline used in the U.S. (100 billion gallons a year) with alcohol from marine biomass would take a 40,000 square kilometer area -- around the size of Ireland and Cuba. Of course, more efficient processes and enhanced production could decrease the necessary size, but there would be little problem finding space in the ocean for an extra 40,000 kilometers somewhere. You would hope that the final cost of this liquid fuel was within a tolerable range, lets say \$1.20 (US prices) to \$5.00 per gallon (European fuel prices).

OK, what about the waste products. When the kelp is hydrolized we get this goopy green leftover glop -- some of it could go to other chemical processes and some could be returned to the sea, along with treated sewage from the city, to fertilize the kelp beds for future harvests.

How do you support the rest of the city? Ocean Thermal Energy Conversion (OTEC) for electricity and fish farming and hydroponics for food, other light manufacturing, some mining of deep sea minerals -- those are possibilities.

What is impossible to make at sea? Probably heavy industrial processes, such as steel mills, aluminum refining, textiles, etc.

Who would live there? Given the need for dignified employment in many developing nations, I would think that you could find millions of people willing to become "kelpers." If developing nations would divert financial resources out of the petroleum sector and into sustainable development, it could vastly raise the standard of living of some of the poorest people on earth and solve a large portion of the environmental crisis at the same time.

You can see (squint hard, now) some of the visions of Huxley or Fuller or even Dwayne Andreas in play here, and we can see the outline of a real solution to the world energy / environmental crisis in the development of floating cities that produce renewable energy and food.

[From Steve Mather]

One possibility in "floating cities" that I recently came across is the "Mining" Magnesium. Allegedly it can be obtained from sea water. Volvo developed a car back in the eighties (unfortunately they only developed it, it never went into production) that was made of a significant amounts of magnesium for its weight and because it avoided damaging mining practices. It's called the Volvo LCP 2000. Allegedly it gets anywhere from 56 to 81 (tops, 100) mpg, and, being a diesel, will run on nearly anything. For more info write Bob Austin of Volvo of America Corporation, Rockleigh, New Jersey, 07647; or call (201) 768-7300.

## [5.7 What was the Old Man's River City Project \(circular cities\)?](#)

This was Fuller's design science approach to solving the housing crisis in East St. Louis.

Here are some excerpts from BF's CRITICAL PATH:

"For eminently mobile man, cities have become obsolete in terms of yesterday's functions - warehousing both new and formerly manufactured goods and housing immigrant factory workers...

"Old Man's River City, undertaken for East St. Louis, Illinois takes its name from the song first sung by Paul Robeson fifty years ago, which dramatized the life of Afro-American blacks who lived along the south-of-St. Louis banks of the Mississippi River...

"I originally came to East St. Louis to discuss the design and possible realization of the Old Man River's City, having been asked to do so by East St. Louis community leaders themselves... It is moon-crater-shaped: the crater's truncated cone top opening is a half-mile in diameter, rim-to-rim, while the truncated mountain itself is a mile in diameter at its base ring. The city has a one-mile-diameter geodesic, quarter-sphere transparent umbrella mounted high above it to permit full, all-around viewing below the umbrella's bottom perimeter. The top of the dome roof is 1000 feet high. The bottom rim of the umbrella dome is 500 feet above the surrounding terrain, while the crater-top esplanade, looks 250 feet radially inward from the umbrella's bottom, is at the same 500-foot height. From the esplanade the truncated mountain cone slopes downwardly, inward and outward, to ground level 500 feet below.

"The moon crater's inward and outward, exterior-surface slopes each consist of fifty terraces - the terrace floors are tiered vertically ten feet above or below one another. All the inwardly, downwardly sloping sides of the moon crater's terraced cone are used for communal life; its outward-sloping, tree-planted terraces are entirely for private life dwelling."

If you want all the details see CRITICAL PATH pages 315-323. [C. Fearnley]

[From Alex Soojung-Kim Pang.]

The Old Man River project never got off the drawing boards. It was mainly the work of Washington University architecture prof James Fitzgibbon. He had a long relationship with Fuller, extending back to the early 1950s.

Fitzgibbon had designed a domed city to be built on Frobisher Bay in Canada in 1956, and Old Man River was an extension and expansion of that earlier plan. It was also designed to address problems that architects, planners, and policy-makers considered central in the late 1960s and early 1970s, viz. racial segregation, urban decay, and economic growth in the inner cities.

Old Man River would have provided housing and services for several thousand families in the most depressed section of St. Louis. It would have been built and managed by a non-profit corporation, and taken something like 20 years to complete; in Fitzgibbon's evocative phrase, it would have been not only good housing, but a "job machine," a huge project creating new industries in the area by virtue of its immensity. Fuller claimed that it would be the incubator of a new classless, raceless society. However, it never got anything close to the \$1 billion required to build it, and the St. Louis municipal government never seemed to have taken it seriously.

[ See section [Fuller's `failures.'](#) for more commentary on this project. ]

## **5.8 What was the Dymaxion Deployment Unit?**

[From Jay Rozen.]

Alden Hatch, in his "At Home in the Universe," describes BF's "Dymaxion Deployment Unit" (DDU), a circular structure which BF intended as cheap civilian housing. From 1940 to Pearl Harbor, they were manufactured for Allied troops and sent all over the world.

[From Pat Salsbury]

For more pictures of the D.D.U., or the other stuff Bucky worked on, check "The Dymaxion World of Buckminster Fuller." For blueprints and such, (not necessarily in a size that is legible all the time! ;) ) try "The Artifacts of Buckminster Fuller"

## **5.9 What is the Dymaxion Map?**

The Dymaxion Map is Fuller's attempt to provide the best all-at-once view (therefore flat and not globe-shaped) of the Whole Earth. His solution is based on projecting the globe onto an icosahedron and then unfolding the icosahedron (making it flat). His design was awarded U.S. Patent 2,393,676 in 1946.

### **Details about the Dymaxion Map.**

[From Kirby Urner]

It's an icosahedron with its 20 triangles subdivided to give new vertices, which are pushed out equi-radially to approximate a sphere. The icosahedron is an intermediate stage between this high frequency icosahedron sphere and the final unfolding into a flat projection.

[From Christopher L. Weeks]

Over my recent X-mas break from school, I had the opportunity to visit the semi-new St. Louis Science Center. Among many interesting and some not-so interesting displays there was a dymaxion globe with magnetic panels holding the map sections to its surface. It was a great puzzle to take them all off and assemble them flat on the surface provided. The display briefly noted that it was called a dymaxion map, and didn't mention Bucky at all. There is also an hourly(?) laser show on a huge (three-story tall) dymaxion map. Again no mention of Bucky. But it is exposure.

[From Sarah Lum]

[The] world map interface, which many of us feel is replete with desirable futuristic connotations, not to mention real advantages.

minimal distortion including in high latitudes no sinus cuts into land masses apolitically polar-centric

hardwired in the literature to civilian deployment strategies on a scale that would arm-chair military masterminds feel



right @ home

World Game sells its Global Recall software which shows data on the map -- the deflated, unfolded, orthonormal, omnitriangulated icosaspheric projection.

DISCLAIMER: I am not in any way connected or affiliated with the World Game Institute. This is not to be construed as a sales pitch by a party with a direct or even indirect financial interest in success of World Game, Inc.

## **5.10 What was the Dymaxion House?**

[From Kirby Urner]

The Dymaxion House prototype, for instance, was more octagonal, suspended from a central "utility mast" -- a house on a pole.

---

[Next](#) [Previous](#) [Contents](#)

## 6. Miscellany

### 6.1 What are "fullerenes" and "buckyballs?"

SCIENCE magazine voted buckminsterfullerene "Molecule of the Year" in 1991.

[From Kenneth J. Fair.]

The exciting part of the discovery of C<sub>60</sub> molecules is that they are only the third naturally occurring form of carbon to be found (graphite and diamond of course being the first two). C<sub>60</sub> was first isolated from graphite (I think) in 1985.

As Paul Houle writes, C<sub>60</sub> is formed in the shape of a geodesic sphere (like the panels of a soccer ball), hence the name "buckminsterfullerene" or "buckyballs" for short. Each carbon has three sp<sup>2</sup> hybrid orbitals and the fourth electron of each carbon resides in a delocalized pi orbital that ranges over the entire ball (like benzene).

The physical appearance of C<sub>60</sub> is very much similar to graphite, as are some of its physical properties. C<sub>60</sub>, unlike graphite, can be dissolved in benzene to form a translucent amber solution.

Other developments of buckyballs:

- 1) Radicalization - Besides just the pure C<sub>60</sub> form, researchers at Rice have added hydrogen molecules to the carbon junctures to form molecules such as C<sub>60</sub>H<sub>36</sub>. Also, work is progressing on making C<sub>60</sub> radical groupings (similar to benzene -> phenol).
- 2) Property measurement - Although many of the properties of C<sub>60</sub> are known, most of the properties of its compounds are still hazy.
- 3) Higher molecules - Other stable forms with greater numbers of carbons have been isolated as well, including C<sub>70</sub>, C<sub>72</sub>, and a couple of others I can't remember. All of these have geodesic shapes as classified by Buckminster Fuller and look like lopsided versions of the normal C<sub>60</sub> molecule.
- 4) Ionization - One can trap metallic ions such as Fe<sup>++</sup> and Mg<sup>++</sup> in the cage of the C<sub>60</sub> to make the molecule act as a very large ion.
- 5) Superconductivity - As far as I know, the 18K T<sub>c</sub> for C<sub>60</sub> is the correct figure. This of course is much lower than high-temperature superconductors, but this fact may be used in some way at a later date.

Kenneth J. Fair

[From Blaine A. D'Amico.]

I promised a citation for the best Fullerene book to date. It is titled *Fullerene C60; History, physics, Nanobiology, Nanotechnology*. North Holland Press by Djuro Koruga, Stuart Hameroff, James Withers, Raouf Loutfy, and Malur Sundareshan. The first chapter explores Fuller and Synergetics and the entire book is consistent with Fuller's Cosmography. Take a look.

[From Kevin Sahr]

This thread began in sci.math. Gets to the heart of what mathematics algorithms underlie the Dymaxion Projection.

Kirby Urner writes:

```
>  
> In article <2vs64v$av@gaia.ucs.orst.edu> sahr@thuja.FSL.ORST.EDU (Kevin  
Sahr) writes:  
> >From: sahr@thuja.FSL.ORST.EDU (Kevin Sahr)  
> >Subject: Re: The Icosahedral Projection (& ancient cartography)
```

```
> >Date: 11 Jul 1994 19:22:07 GMT
>
> >In article <2vqmu9$3to@omnifest.uwm.edu> mark@omnifest.uwm.edu (Mark Hopkins)>
>writes:
> >>
> >...history/motivation deleted...
> >>
> >>(2) The Icosahedral Projection
> >> This is a projection I discovered (rediscovered?) about 8 years ago. It
> >>consists of 20 triangular plates that can be arranged in a variety of ways.
> >>To date (to the best of my knowledge) it is the only reconfigurable
> >>projection.
> >>
> >...description deleted...
> >>
>
> >This projection you've discovered is extremely similar to R. Buckminster
> >Fuller's Dymaxion Airocean World Map in both motivation and conception,
> >though subtly (to me, at least!) different in execution. Bucky's projection
> >(which also individually projects each triangle of the spherical icosahedron)
> >has the advantage that all great circle arcs parallel to any of the edges
> >of a given icosahedron triangle are straight lines on the planar triangle,
> >and distances along these arcs are preserved on the planar triangle. It
> >has the disadvantage (big, big :( here!) that it does not seem to be
> >mathematically well-defined.
> >Kevin
>
> I believe the Fuller projection is mathematically well defined. The faces
> of an icoa are subdivided into similar equilateral triangles, which are
> pushed outward along radii from the sphere center to the surface (orthogonal
> projection). The mathematics for doing this, same as for the domes, is
> mathematically expressed and computer-implemented. And yes, more
> work needs to be done to popularize this map and its methods.
```

I don't believe your description of the projection method is correct; I don't think, for instance, that what you're saying (assuming I get your drift) would preserve distances along the great-circle arcs. I think what Fuller did was a bit more subtle than that; again I refer you to his "steel-straps and straws" illustration which appears in many of his books.

If you have any references or code for doing the Fuller projection I would be very interested in seeing it. The information I have is from an unpublished paper by Robert W. Gray of IBM, "Fuller's Dymaxion Map." In it he recounts how Fuller developed what he called a "three-way great circle grid" to use as a reference system for manually transcribing points off of a globe onto a Dymaxion Map, and this is the system which appears in Fuller's 1946 patent of the Dymaxion Map. However, before his death Fuller realized that when this grid was projected to the plane the intersections of the arcs did not form points, but little triangles (*Cosmography*, pg. 236). Gray's version of the projection suggests taking the average of the location of the vertexes of these little triangles to use as the projected point location. One of the things we are exploring is how this averaging affects the properties of the projection at various scales.

I do believe that the projection could be implemented "precisely" to an arbitrary degree of precision by recursively sub-dividing the spherical triangle until a point of interest lies within the specified precision of one of the sub-triangle vertices and then using the corresponding vertex on the sub-divided planar triangle as the position of the planar location of the point. But I need to spend more time looking for an analytic method of accelerating this procedure before it would be sufficiently efficient for our use.

But, I am more than open to being proved wrong about the mathematical nature of Fuller's projection! If you have more information I would appreciate hearing about it.

[From Kiyoshi Kuromiya]

Icosahedral projections (non-orthogonal) of the world have been proposed since the early years of the twentieth century. Fuller's projection is orthogonal and optimizes size and shape distortions of the land areas. But most importantly, places the vertices in such a way that when the icosahedral projection is unfolded into a planar map, none of the sinuses cut into any land areas. Therefore, it is the only world projection that minimizes size and shape distortions by distributing in equal proportion any existing pin-cushion distortion to the center of each of the twenty triangular faces.

In 1980, Chris Kitrick and Rob Grip, two engineers in Bucky's office developed the first computer generated projection of the Dymaxion Map (the three-way grid was computer generated and then data transferred). The Grip-Kitrick map is available from the Buckminster Fuller Institute in Santa Barbara, CA.

The triangular "weaving pattern" of the three-way triangular great circle grid that you mention (on page 236 of *Cosmography*), reconciles two basic ideas of synergetics: 1) that two lines cannot go through one point at the same time, 2) tensegrity models the reality that nothing in Universe touches anything else.

## What are some of the properties of the fullerenes?

[From Kirby Urner.]

Buckminsterfullerene (C60) is becoming ever easier to get in quantity and shows many interesting optical properties. It stops light -- the brighter the light the more effectively it stops it. Nano and pico-second laser pulses are effectively and instantly opaqued by small quantities of C60. A helmet visor treated with fullerene will instantly block an incoming laser beam -- the stronger the ray, the faster the face glass turns dark (cooler than those "photosensitive" sunglasses) (Patterson AFB in Ohio is studying such applications). Many other optical properties of the fullerenes are under study.

However, C60 remains forty times more expensive than gold. As Smalley put it "it's the yield, stupid" -- i.e. the central issue facing fullerene researchers, in Smalley's opinion, is how to get more of it. The Smalley team approach of using parabolic mirrors to sun-generate fullerenes (to produce "sunnyballs") appears to be a potentially promising approach. Concentrated sunlight has less of the damaging frequencies in high-powered lasers that apparently to inhibit fullerene formation from vaporized carbon).

Fullerene is quite reactive and can be used as a building block in other structures. In some crystal formations, doped with potassium for example, it conducts electricity with no resistance (is a superconductor).

[From Mitch Amiano]

[One potentially useful property is] C-60's peculiarly large capacity internal space - for instance, researching its use as a carrier for other molecules or as a molecular filter material. Something recently in the news was a test-tube finding that C-60 fits into a protein binding site on the HIV virus, thus preventing replication.

The buckyball attaches to a molecular binding site of an enzyme necessary for it's reproduction. Perhaps "fits in" is a better term, since I am not certain the buckyball attaches in the same way a protein molecule would. I think it is more or less the geometry of the thing that does the trick.

[From Kurt Przybilla. In reply to a question about boron and fullerenes]

From: Encyclopedia of Applied Physics, Vol. 6 1993 VCH Publishers

p.520 "A second method is the substitutional doping of an impurity atom with a different valence state for a carbon atom on the surface of a fullerene ball. Since a carbon atom is so small, and since the average nearest-neighbor C-C distance ac-c on the C60 surface is only 1.44 Å (angstrom) (Johnson et al., 1992), the only species that can be substituted for a carbon atom on the C60 ball surface is boron, making the charged ball p type. Smalley and co-workers have demonstrated that it is possible to replace more than one carbon atom by boron on a given ball (Smalley, 1991). Also for graphite, the only substitutional dopant is boron, and for the same reasons as for C60. However, for diamond, which has larger C-C nearest neighbor distance of ac-c+1.544 Å, both boron and nitrogen can enter the lattice substitutionally (Feild, 1979). It has also been reported that it is possible to place a potassium atom endohoronally inside the C60 ball while at the same time substituting aa boron for a carbon atom on the surface of the ball (Smalley, 1991)."

The first method of doping deals with "endohedral" doping of rare earth, or alkali-metal ions. The third deals with similar dopants introduced between adjacent balls (intercalation)

There are over 20 pages of very good information in this source. I recommend it to all.

[From H. Jeffrey Rosen]

Those of us interested in Fullerenes will be thrilled by the publication of a letter to NATURE, the weekly international science journal, in that periodical's May 5 issue.

It seems that NASA's Long Duration Exposure experiment, which orbited for nearly six years and was recovered for analysis four years ago, showed traces of carbonaceous matter in a cratered aluminum panel - matter which has been found to contain traces of Carbon 60 and other Fullerenes.

This news provides direct evidence that Fullerenes either exist spontaneously in Universe, or can be formed in space.

## How can the non-triangulated buckyball be stable? <[ Christopher Rywalt ]

[From Steve Mather]

The Buckyball is triangulated by the electron's "want" to be as far away from each other as possible. The triangulation is along force lines between the three electron clouds (they are center bodied "planar" triangles) with the tensile parts as the force lines and the clouds as the compression members.

A

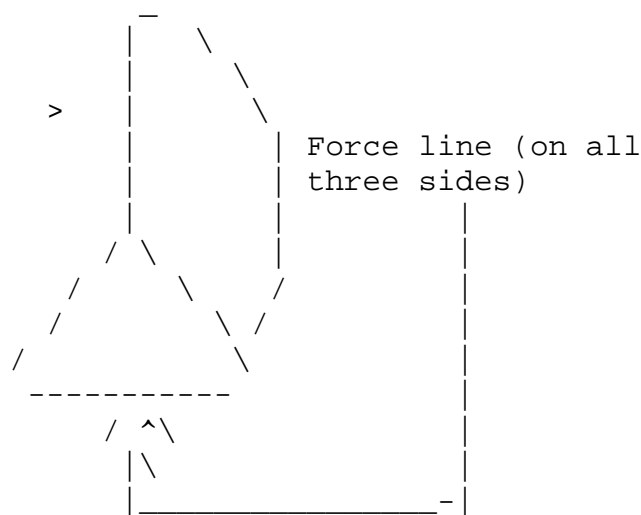

[From Christopher Rywalt]

According to Richard Smalley -- this is one thing he told us at Science Kick -- C60 has been found in the layer of earth that marks the boundary between the Cretaceous and the Triassic periods. This layer is very dark and is rich in carbon and is what leads current science to believe the last of the dinosaurs were wiped out in massive fires. This is not really a rare kind of rock formation; it's just not that easy to stumble on.

Also, Smalley told us that C60 -- as well as other fullerenes -- are formed from something as simple as a candle. The explanation was that what's glowing in a candle is actually soot -- carbon -- which, as it reaches the "edge" of the candle's "flame," cools so that it no longer glows. If you wave your hand at the air over a candle flame, you're waving away airborne carbon atoms, and among them, fullerenes.

[From Steve Mather]

C60 and C70 sublime considerably between 750 and 850C. They oxidize at 550 to 650C.

The larger fullerenes are more graphitic in that they have larger areas (20 of them) that are graphitic in properties (i.e. hexagon sheets.) They are harder (sometimes impossible) to dissolve in aromatic solvents and their CRYSTAL structure is more difficult to to break apart. The individual molecules, however are less stable the larger they get.

As such, they sublime (whole molecules) at a higher temperature, but oxidize at lower temperatures than smaller fullerenes (such as C60 and C70).

By sublime, I don't mean that the molecules break apart into their component atoms, those atoms forming a gas, but rather the molecules break away from the crystal and form a gas.

In fact, one way to purify fullerenes, to get just the fullerenes one needs, is heating them up to 700 C, which breaks up the crystal, and collecting the cooled soot from particular spots where it cools. Different fullerenes travel different distances.

Further reading on fullerenes (although not the most recent) can be found in *Fullerenes*, ed. George S. Hammond and Valerie J. Kuck, pub. American Chemical Society, 1992 and *Buckminsterfullerenes*, ed. W. Edward Billups and Marco A. Cuifolini.

## What are ``buckytubes?''

Richard Smalley of Rice University believes these may hold promise in building an elevator to space as first proposed by Arthur C. Clarke in ``Fountains of Paradise." Bucky tubes may be tensionally stronger than diamond.

[From Kirby Urner.]

Buckytubes are super fine fillaments made of hexagonal ``chickenwire" carbon mesh.

[From ``Buckymania'' in The Magazine of Fantasy and Science Fiction - typed in by Bruce Sterling.]

``Carbon-fiber is a high-tech construction material which has been seeing a lot of use lately in tennis rackets, bicycles, and high-performance aircraft. It's already the strongest fiber known. This makes the discovery of ``buckytubes" even more striking. A buckytube is carbon-fiber with a difference: it's a buckyball extruded into a long continuous cylinder comprised of one single superstrong molecule."

## What are ``endohedral fullerenes?''

[From Kirby Urner.]

Fullerenes with atoms or clusters of atoms inside, the so-called ``endohedral fullerenes," are presently extremely difficult to isolate in quantity and their properties are as yet poorly understood (no one yet knows, for example, if crystals of same will superconduct, as does  $K_3C_{60}$  -- potassium atoms in all the interstices in a  $C_{60}$  crystal packing). The suggested notation for endohedrals, by the way, is  $X@C_n$ , e.g.  $K@C_{60}$  (potassium atom inside  $C_{60}$ ).

## How can I make my own bucky balls?

The question of how to make your own ``bucky balls" is completely answered in the Jan. '94 issue of the American Journal of Physics p85-8. The title of the article is ``Production and separation of  $C_{60}$  and  $C_{70}$  as an undergraduate experiment." Though I haven't attempted myself, the authors give a detailed account of the steps and apparatus necessary to produce your own ``bucky balls."

## 6.2 What is Biosphere II?

[Note this is not really Fuller related, but keeps coming up on the list. From Carl Dichter.]

``Biosphere I" is the earth. Basically, a whole ecology that is encapsulated by the atmosphere and needs nothing except solar power to continue living ``forever."

``Biosphere II" is an attempt by some scientists/entrepreneurs to model its behavior with (either 4 or 6, can't remember) people, plants, and animals in a metal and glass enclosure.

The enclosure looks something like this from the side:

---



It's made out of a triangular latticework of aluminum, with glass panels, not in a dome configuration: more like four-sided pyramids. Supposedly, each of these panels costs \$20,000 to install, seal, and test.

Inside of the ``sphere" are little climate/life zones. These each have mini geological features, like an ``ocean," ``mountain," ``desert." These zone vary as much as possible considering they share the same air. They've planned the amount of each type of life form they can support.

## **6.3 What were Fuller's early years like?**

[From Leo Elliot]

Bucky was raised in Maine, and according to his own story, squandered the money his family had staked him to for his Harvard education by going down to NYC to take out the entire chorus line of the Ziegfield Follies (the original wild and crazy guy?). After getting kicked out, reinstated, and kicked out again, Bucky ended up at the Naval academy, where, so he says, he was amongst the last of the classes to be trained in such things as full command authority, meaning that he was given the type of education that trained him in all phases of naval operations, on the premise that should he be on a boat that was attacked, all the superior officers lost, etc., then he would have to take over the ship.

Among his accomplishments was the design of a type of crane for the retrieval of airplanes that overshot the runways of aircraft carriers.

Prior to his epiphany in Lake Michigan in 1927, he also worked in a family business designing some type of construction brick. He tried several other types of work, but basically felt as though he was a failure at all/most of them, and in addition lost an infant daughter to spinal meningitis which he blamed on himself, attributing the disease to the poor living conditions he afforded his young family in some gangster-infested tenement in Chicago, all leading up to his being ready to throw himself into Lake Michigan in 1927.

## 6.4 Was Fuller formally educated?

Regarding his honorary doctorates the "Basic Biography" (available from the Buckminster Fuller Institute) lists 40 such degrees in a comprehensive list ranging from Doctor of Design, Laws, fine arts, Engineering, humane letters, literature, humanities, and science. He was granted Professional licenses as an architect in New York (1974) and Ohio (1979). - Blaine A. D'Amico

I remember reading in a biography (can't remember which) that Bucky made two false starts at college and didn't finish either time. - Bill Long

## 6.5 Bibliography: Culled from many postings

[Culled from postings by Blaine D'Amico, Gary Lawrence Murphy, Jim Lutz, and this editor's research]

### BIBLIOGRAPHY BOOKS INCLUDING ORIGINAL MATERIAL BY R. BUCKMINSTER FULLER

4D time lock [by] Buckminster Fuller. Albuquerque, N.M., Lama Foundation [c1972] x, 148 p. illus. 27 cm. Published in 1930 under title: 4D.

And It Came to Pass, Not to Stay -- New York : Macmillan, c1976. 157 p. ; 22 cm.

Approaching the Benign Environment. / [by] R. Buckminster Fuller, Eric A. Walker [and] James R. Killian, Jr. Pref. by Taylor Littleton. [New York], Collier Books, [1970]. 160 p. 20 cm. Contents: Education for comprehensivity, by R. B. Fuller.--Engineers and the nation's future, by E. A. Walker.-- Toward a working partnership of the sciences and humanities, by J. R. Killian, Jr. (The Franklin lectures in the sciences and humanities, 1st ser.)

The artifacts of R. Buckminster Fuller : a comprehensive collection of his designs and drawings / edited with descriptions by James Ward. -- New York: Garland, 1984. 4 v. : ill. ; 31 cm. Includes bibliographies. Contents: v. 1. The Dymaxion experiment, 1926-1943 -- v. 2. Dymaxion deployment, 1927-1946 -- v. 3. The geodesic revolution, part 1, 1947-1959 -- v. 4. The geodesic revolution, part 2, 1960-1983. [This is a huge collection of Fuller's technical papers, blueprints, etc. Its a tremendous resource. --- Alex Soojung-Kim Pang]

Buckminster Fuller: An Autobiographical Monologue Scenario (St. Martin's Press, c1981.)  
Must reading for any Fuller student. Contains numerous stills from movies of Fuller.

The Buckminster Fuller reader / edited and introduced by James Meller. London, Cape, 1970. 383 p., 16 plates. illus., facsim., map. 23 cm. Bibliography: p. 371-373.

Critical Path. adjuvant Kiyoshi Kuromiya. -- New York : St. Martin's Press, c1981. xxxviii, 471 p. : ill. ; 24 cm. Includes index.



A complete scientific and sociological examination of human history, solutions to current problems of humanity and future trends for ``cosmic evolution.''

Cosmography: A Posthumous Scenario for the Future of Humanity.

adjuvant: Kiyoshi Kuromiya. Macmillan Publishing Company, c1992. viii, 271 p. Includes index. (ISBN 0-02-541850-5).

Design for the real world; human ecology and social change [by] Victor Papanek. With an introd. by R. Buckminster Fuller. [1st American ed.] New York, Pantheon Books [1972, c1971] xxviii, 339 p. illus. 21 cm. Bibliography: p. [311]-339.

The Dymaxion World of Buckminster Fuller [by] Robert Marks and R.

Buckminster Fuller. Garden City, N.Y., Anchor Books, 1973 [c1960] 246 p. illus. 26 cm. ``Slightly revised Anchor Press edition.''

A pictorial and written retrospective of Fuller's work and thought.

Earth, inc. [by] R. Buckminster Fuller. Garden City, N.Y., Anchor Press, 1973. 180 p. illus. 21 cm.

Education Automation : Freeing the Scholar to return to his Studies, a discourse before the Southern Illinois University, Edwardsville Campus Planning Committee, April 22, 1961 / Foreword by Charles D. Tenney. Carbondale, Southern Illinois University Press, [c1962]. 88 p. 22 cm. (Southern Illinois University occasional publication.)

Fuller's diagnosis of and solution to the education crisis.

Energy, Earth, and everyone : a global energy strategy for spaceship Earth / by Medard Gabel, with the World Game Workshop ; with a foreword by R. Buckminster Fuller, and an afterword by Stewart Brand. -- San Francisco : Straight Arrow Books ; [New York] : distributed by Simon and Schuster, c1975. 160 p. : ill. ; 20 x 29 cm. Cover title. Bibliography: p. 153.

Expanded cinema. Youngblood, Gene / Introd. by R. Buckminster Fuller.

[1st ed.]. New York, Dutton, 1970. 432 p. illus. (part col.), ports. 21 cm. (Dutton paperback original, D263.)

Bibliography: p. 421-425.

Generation of Narcissus. With an introd. by R. Buckminster Fuller. [1st ed.] Boston, Little, Brown [1971] xii, 266 p. 22 cm.

Grunch of Giants. -- New York : St. Martin's Press, 1983. xxviii, 98 p. Includes index.

Fuller's analysis of the international banking system where he advises the world that the current economic systems have been robbed by multinational corporate giants. GRUNCH = Gross Universal Cash Heist. Fascinating reading.

Humans in Universe. Buckminster Fuller, Anwar Dil. -- 1st American ed.

-- New York : Moutin, c1983. 235 p. : ill. ; 26 cm. Includes bibliographical references and index.

Conversations between Fuller and Indian Philosopher Anwar Dil.

Ideas and Integrities : a spontaneous autobiographical disclosure edited by Robert W. Marks. --1st Collier Books ed. -- New York : Collier Books, a division of Macmillan Pub. Co., 1969. 318 p., [32] p. of plates : ill., charts, ports. ; 20 cm. Includes index.

Intuition. foreword by Norman Cousins. -- 2nd ed. -- San Luis Obispo, Calif. : Impact Publishers, 1983. 223 p. ; 21 cm.  
Blank verse describing humanity, mind, Universe and Synergy.

Inventions: The Patented Works of R. Buckminster Fuller. -- 1st ed. -- New York : St. Martin's Press, c1983. xxxii, 316 p. : ill., plans, ports. ; 32 cm.

Actual copies of Fuller's collected patents with historical and instructive notes by Fuller. Also contains Fuller's apologia mia vita in which Fuller describes his life strategy and discoveries.

Inventory of World Resources: Human Trends and Needs. [1963-1965]  
Document 1: By R. Buckminster Fuller and John McHale [1963]  
Document 2: The Design Initiative by R. Buckminster Fuller [1964]  
Document 3: Comprehensive Thinking by R. Buckminster Fuller [1965]  
Document 4: The Ten Year Program by John McHale [1965]

I Seem To Be A Verb, by Buckminster Fuller and Quentin Fiore.

Mindstyles, lifestyles : a comprehensive overview of today's life-changing philosophies / by Nathaniel Lande ; introd., Hans Selye ; conclusion, R. Buckminster Fuller ; col. ill., Corita Kent. -- Los Angeles : Price/Stern/Sloan, c1976. 495 p. : ill. ; 28 cm. Includes index. Bibliography: p. 492-494.

Naga: cultural origins in Siam and the West Pacific / Sumet Jumsai ; with contributions by R. Buckminster Fuller. -- Singapore ; New York : Oxford University Press, 1988. xvi, 183 p., [16] p. of plates : ill. (some col.) ; 26 cm. Includes index. Bibliography: p. 179-181.

Nine Chains to the Moon Philadelphia, J. B. Lippincott Company [c1938] xvi, 405 p. illus., 2 fold. diagr. 24 cm. Maps on lining-papers. Reissued Carbondale, Ill., Southern Illinois University Press, [1963]. 375 p. illus. 22 cm.

No more secondhand God; and other writings. Carbondale, Southern Illinois University Press, [1963]. 163 p. illus. 22 cm. (Southern Illinois University occasional publication.)

Operating Manual for Spaceship Earth. [New York] Simon and Schuster [1970, c1969] 143 p. 21 cm. (A Touchstone/Clarion book 20783) First paperback printing, 1970. Includes index.  
Fuller's seminal work regarding the relationship of humanity to the environment and planetary planning. World history takes on

a new meaning and significance. A primer on Synergetics.

A Question of Priorities, New Strategies for Our Urbanized World / [by] Edward Higbee. With an introd. by R. Buckminster Fuller. New York, Morrow, 1970. xxxiv, 214 p. 22 cm. Bibliography: p. [199]-203.

R. Buckminster Fuller on Education. edited by Peter H. Wagschal and Robert D. Kahn. -- Amherst : University of Massachusetts Press, 1979. 192 p. : ill. ; 21 cm. [See Education Automation]

A sculptor's world. [Noguchi, Isamu] / Foreword by R. Buckminster Fuller. [1st U.S. ed.]. New York, Harper and Row, [1968]. 259 p. 268 illus. (part col.). 27 cm.

Synergetics: Explorations in the Geometry of Thinking. [by] R. Buckminster Fuller in collaboration with E. J. Applewhite. Pref. and contribution by Arthur L. Loeb. New York, Macmillan [1975] xxxii, 876 p. illus. 24 cm. Bibliography: p. 875-876.

Synergetics II: Further Explorations in the Geometry of Thinking  
These two books comprise the collected geometric modeling system developed and used by Fuller in the development of his explanation of the ``coordinate system of nature.' ' Fuller claimed that Synergetics could be understood by a 5 year old.

Synergetics Dictionary : the Mind of Buckminster Fuller : with an introduction and appendices / compiled and edited by E.J. Applewhite. -- New York : Garland, 1986. 4 v. ; 32 cm. Includes bibliographies.

Synergetic Stew: Explorations in Dymaxion Dining. Philadelphia, Buckminster Fuller Institute, 1982. 118 p. Includes index.

Tetrascroll: A Cosmic Fairy Tale: Goldilocks and the Three Bears. New York, St. Martin's Press [1975,1982] xxvii, 129 p. illus. Introduction by Amei Wallach.  
Wonderful tale of Goldilocks and the three bears in which Goldi learns General Systems Theory and Synergetic geometry through real world examples.

This or else ... : a master plan for India's survival / by Dinshaw J. Dastur. -- Bombay : Jaico Pub. House, 1974. x [i.e. xvii], 184 p. ; 22 cm. Includes a foreword by R. Buckminster Fuller.

Uncommon sense : the life and thought of Ludwig von Bertalanffy (1901-1972), father of general systems theory / [by] Mark Davidson ; foreword by R. Buckminster Fuller ; introduction by Kenneth E. Boulding. -- 1st ed. -- Los Angeles : J.P. Tarcher ; Boston : Distributed by Houghton Mifflin Co., c1983. 247 p. ; 25 cm. Bibliography: p. 229-236. Includes index.

Untitled epic poem on the history of industrialization. Highlands [N.C], J. Williams, 1962. 227 p. 20 cm. (Jargon, 44.)

Utopia or Oblivion: the Prospects for Humanity. With an introduction by Stephen Mullin. [London] Allen Lane The Penguin Press [c1970] 416 p. illus. 23 cm. Includes bibliography.

BOOKS ABOUT R. BUCKMINSTER FULLER OR RELATING TO HIS WORK

Aaseng, Nathan. More with Less : the Future World of Buckminster Fuller (Minneapolis : Lerner Publications, c1986.) Ninth grade reading level. Excellent introduction into Synergetics and Fuller's significance in general

Applewhite, E. J. Cosmic fishing : an account of writing Synergetics with Buckminster Fuller. (New York : Macmillan, c1977.) xvi, 157 p. ; 25 cm.

Applewhite, E. J. Paradise Mislaid : birth, death and the human predicament of being biological / E.J. Applewhite. -- 1st ed. -- New York : St. Martin's Press, 1991. xii, 480 p. ; 25 cm. Includes bibliographical references (p. 439-458) and index. ``A Thomas Dunne book.''

Edmondson, Amy C. A Fuller explanation : the synergetic geometry of R. Buckminster Fuller / Amy C. Edmondson. -- Boston : Birkhauser, c1987. xx, 302 p. : ill. ; 25 cm. -- (Design science collection.) ``A Pro scientia viva title.''

Includes index. Bibliography: p. [287]. Fuller Superb, plain english explanation of Synergetics from a mathematician who worked with Fuller for the last three years of his life. Part of the Design Science collection.

Gabel, Medard. Energy, Earth, and everyone : a global energy strategy for spaceship Earth [See Energy, Earth, and Everyone]

Gabel, Medard. Ho-Ping: Food for Everyone , strategies to eliminate hunger on spaceship Earth / by Medard Gabel, with the World Game laboratory. Anchor Books, c1979. 272 p. : ill. ; 20 x 29 cm. Includes bibliographic references.

Grimaldi, Roberto. R. Buckminster Fuller : 1895-1983. Roma : Officina, 1990. 121 p. (Dizionario monografico degli architetti moderni e contemporanei ; 2)

Hatch, Alden, (1898-), Buckminster Fuller: at home in the universe. New York, Crown [1974] vii, 279 p. illus. 24 cm.

Kenner, Hugh. Bucky; a guided tour of Buckminster Fuller. New York, Morrow, 1973. 338 p. illus. 21 cm. Bibliography: p. 327-331.

Hugh Kenner's ``Geodesic Math and How to Use It'' Berkeley : University of California Press, c1976. xi, 172 p. : ill. ; 22 cm. (ISBN 0-520-02924-0) This is an excellent book for the hobbyist model builder, but also shows geometric derivations for a number of approaches to carving up the surface of a sphere into the smallest practical number of different shaped parts, which is the key matter in dome fabrication. The book also discusses

tensegrity designs, although I believe Hugh has since release a volume devoted to tensegrity. For those without calculators :-), the appendix of the book lists the dome-vertex values for many practical frequencies in the basic polyhedral forms.

McHale, John. R. Buckminster Fuller. New York, Braziller, 1962. 127 p. illus. (Makers of contemporary architecture) Includes bibliography.

Reese, K.M.

Certain activities of R. Buckminster Fuller. (Newscripts)  
Chemical and Engineering News v71, n4 (Jan 25, 1993):60.

Abstract: R. Buckminster Fuller, for whom the fullerene was named, invented the geodesic dome in 1933. He also designed the Dymaxion car with a body made of duralumin. The car had three wheels, a teardrop shape and a maximum speed of 120 miles per hour with 40 miles to the gallon. It can be parked in a space only a foot longer than itself. The Dymaxion car can also be rotated 360 degrees within its own length.

Robertson, Donald W. Mind's eye of Richard Buckminster Fuller / by Donald W. Robertson. -- New York : St. Martin's Press, [1983?], c1974. 109 p. : ill. ; 22 cm. Reprint. Originally published: 1st ed. New York : Vantage Press, c1974. Includes bibliographical references.

Sieden, Lloyd Steven. Buckminster Fuller's universe : an appreciation / Lloyd Steven Sieden; foreword by Norman Cousins. -- New York : Plenum Press, c1989. xvii, 511 p. : ill. ; 22 cm. Includes index. Bibliography: p. 449-498.

Snyder, Robert. R. Buckminster Fuller: an autobiographical monologue/scenario / documented and edited by Robert Synder. -- New York : St. Martin's Press, c1980. 218 p. : ill. ; 28 cm.

Fuller's earth : a day with Bucky and the kids / [edited] by Richard J. Brenneman. -- 1st ed. -- New York : St. Martin's Press, c1984. x, 180 p. : ill. ; 22 cm. Includes index. Bibliography: p. 163-166.

Bucky for Beginners

Workbook style lesson plans for Synergetic activities. A must for teachers.

Shaping space : a polyhedral approach / Marjorie Senechal and George Fleck, editors. -- Boston : Birkhauser, 1988. xx, 284 p. : ill. ; 28 cm. -- (Design science collection.) ``A Pro scientia viva title.' ' Includes material from the Shaping Space Conference held at Smith College, Apr. 6-8, 1984. Includes index. Bibliography: p. 266-271.

Also from the Design Science collection. The proceedings of a conference on polyhedral theory. A wealth of information including a useful article entitled ``Polyhedral in the curriculum.' '

[ From Alex Soojung-Kim Pang. ]

Wendell Barry in "Speaking for Words" has an excellent critique of Fuller's writing style.

There are also a number of magazine articles, published mainly in the 1950s to 1970s, that profile Fuller and give "day in the life" views of him. These have been indexed in a bio-bibliography published by Vance (which does a lot of these for public figures) available at your university library.

## [6.6 Organizations and Corporations mentioned on GEODESIC \(incomplete and dated\)](#)

BFI: The Buckminster Fuller Institute (latest address)

Buckminster Fuller Institute  
111 N. Main Street  
Sebastopol, CA 95472  
Phone: 707-824-2242

1994: [From Kurt Przybilla.]

The best polyhedral modeling kit I've seen is available from [Edmund Scientific](#). It is called a "Star Structure Construction Set." Although it is a little pricey at \$25, the vector joints are the best I've found. They resemble stars with 12 points. The struts are hollow tubes that fit on the stars. Though the book it comes with is a little lame, it explains how to make some of the more basic shapes. The main disadvantage is that the struts are all the same length which makes domes difficult. Edmund Scientific has a wonderful catalog that everyone should have their own copy of. The number listed in it to request a catalog is (609) 573-6858. To order directly (609) 573-6250. The set is catalog number G52,060. Probably the most widely available kit on the market are made by a company out of Oregon called Ikosa Kits. Though they are inexpensive and come in various sizes, they are really nothing more than shishkebab sticks with sections of plastic tubing which you must pierce yourself to make joints. They are available in new age toys stores like Star Magic.

[From Anton Bakker]

The [Zome-Tool](#) by Biocrystals in Bolder Colorado is a good tool. The large kit cost ~ \$600 A contact person is Marc Pellitier.

[From Carey W. Mason, Oct '92]

I have recently completed owner-builder construction of 2 geodesic domes. After some research, I selected the dome-shell kits from Robert Kirkpatrick in Ft. McCoy, Fla. These kits are "Pease"-type domes as opposed to "Hub-and-Strut" construction.

Kirkpatrick's kits (I have a 39' and a 45') are each constructed of two sizes of triangles, pre-assembled, reinforced, braced, with plywood attached for the outer surface, and the outer surface coated with elastomeric polymer. We assembled the triangles into pentagons (small tri's) and half hexagons (larger tri's) and then lifted by crane to assemble the shells. The first taking two days, the second in one day (thanks to setting the angle of the section with a magnetic protractor before craning it into position). This \$10 Kirkpatrick trick saved several hundred dollars in crane time, etc.

Here's Bob Kirkpatrick's info:

Rt 2, Box 2862  
Ft McCoy, Fl 32134  
(904) 6853235

[From Kurt Przybilla]

The best polyhedral modeling kit I've seen is available from Edmund Scientific. It is called a "Star Structure

Construction Set." Although it is a little pricey at \$25, the vector joints are the best I've found. They resemble stars with 12 points. The struts are hollow tubes that fit on the stars. Though the book it comes with is a little lame, it explains how to make some of the more basic shapes. The main disadvantage is that the struts are all the same length which makes domes difficult. Edmund Scientific has a wonderful catalog that everyone should have their own copy of. The number listed to request a catalog is (609) 573-6858. To order directly (609) 573-6250. Probably the most widely available kit on the market is made by a company out of Oregon called Ikosa Kits. Though they are inexpensive and come in various sizes, they are really nothing more than shishkab sticks with sections of plastic tubing which you must pierce yourself to make joints. They are available in new age toys stores like Star Magic.

[From David Roach]

ORB Factory Ltd., 5 Umlah's Road, Halifax, Nova Scotia, B3P 2G6 Phone: (902) 477-9570. This is a small company and the owner's name is Steven Kay. The company makes what Steve calls ``Transformational geometry toys," which are primarily wire, tube and coil based products, based on geometric principles.

[From Pat Salisbury]

My Synergy Ball is being produced by Design Science Toys, of Tivoli, NY. They're the people who make the Tensegritoys, Octabug, Hoberman Sphere, and a slew of other geodesic and geometry based toys. They've got a nifty catalog which you can get by phoning 1-800-227-2316.

In case you weren't here 4-5 years ago when I first designed the Synergy Ball and discussed it here, it's a paper model of a 30-strut tensegrity, and makes a sphere ~9" across which exhibits quite amazing strength when fully assembled. It comes in either red or blue and is priced to retail at under \$5. I think you can get 'em from the factory for less.

Oh, and if you build one, be sure to hang it up with a bit of thread. It looks MUCH better when it can turn in the air currents and casts really nifty shadows on the walls. Especially when you have multiple candles burning! ;^)

## [6.7 Computer tools \(may or may not be useful to dome design or synergetics' modeling\).](#)

There are several quality tools for doing mathematics and geometry. [Yacas](#) is a general purpose computer algebra system. Graphs can be made with [gnuplot](#). [Pari-GP](#) is a very good high-precision calculator tool for Unix, DOS, MS-Windows, Macs, Atari, Amiga, and even VAXen. [POV-Ray](#) is good for generating photo-realistic (or simply perspective) images. Rick Bono wrote a program [dome](#) for generating geodesic domes and spheres. [SpringDance](#) is popular for exploring geometry and tensegrity structures. Many people like [Mathematica](#) and its competitor [Maple](#). [Geomview](#) is a program for looking at and interactively manipulating 3D objects. One of the reasons I use [Debian GNU/Linux](#) for my computing environment is because of all the quality tools for [mathematical](#) work that work out of the ``box" (including calc, gnuplot, POV-Ray, felt, dome, scilab, yacas, etc).

[From Ben Discoe]

Anyone interested in the geometry mentioned in [\\_Synergetics\\_](#) (and has access to a computer running 3D Studio R3) could check out a free program (on the net as HEDRA.ZIP) which purports to create a very wide variety of polyhedral forms. I don't think 3D Studio will let you easily raise the forms to higher frequencies, though.

[From Kirby Urner]

I've seen some interesting Synergetics on the Mac: Yasushi Kajikawa did a new module system for assembling icosahedra and other shapes in that 5-fold symmetric family -- 5-fold stuff is IN these days. He used HyperCard with XMD calls to MacroMind Director I think it was -- the individual movie frames were developed in Mathematica. Lots of polyhedra exploding into parts -- looked like car repair manuals for abstract geometric shapes. Music too. The text was all in Japanese. Robert Orenstein tried to get an English edition together -- he also got a jitterbug transformation to run entirely from within Mathematica. Looked cool!

[From Robert L. Read]

`Felt' is a structural analysis program that is freely available under the GNU Public License (GPL). It is written and maintained by Jason Gobat (jgobat@ucsd.edu) and Darren Atkinson (atkinson@ucsd.edu).

It allows you to input a geometry of a structure, assign material types to various components, add on continuous forces like roof loads and specific forces like a 10,000 pound weight at a certain point, and then compute the forces in each member.

[Editor: The Felt website is located at <http://felt.sourceforge.net/>. Debian GNU/Linux users can check out <http://www.debian.org/Packages/stable/science/felt.html>.]

## **6.8 Fuller's ``failures.''**

[From Alex Soojung-Kim Pang - See [Old Man's River City Project \(circular cities\)?](#) for background.]

It is also interesting to note that this [Old Man River City] was the most modest of a series of urban renewal projects that Fuller was involved in at the time: his proposals for floating cities, renovation of Harlem (which involved tearing down all the buildings and erecting a series of apartment blocks that looked like nuclear plant cooling towers), and floating spherical cities all date from this period. Ironically, they represent a kind of technocratic vision that many of Fuller's followers in the counterculture rejected, though the tension between the ``Whole Earth Catalog" and ``Domebook" interpretation of Bucky and the Bucky that was proposing to build cooling towers on Harlem never became strong.

[From Leo Elliott]

Ross Keatinge raises some interesting speculations about Bucky's self-promotions and possible over-estimations of his projects' current or future feasibilities. The oldest one I can specifically recall, that seemed the most ordinary, was his ``dymaxion bath" (part of the dymaxion house?), illustrated in Marks' ``The Dymaxion World of Buckminster Fuller" -- supposedly this two-piece, user-assemblable bath-utility would provide all the normal bath amenities (shower, tub, toilet, sink) with the additional economy of being able to take a very cleansing shower on only about a pint of water, an idea which Bucky says he got from watching how clean the engine-room sailors would get once they came up on deck and stood in the spray of a strong sea mist for a while -- ? Not sure of any data/research ever done by the soap or the plumbing-fixture companies on this particular claim, but according to Bucky, the dymaxion bath (which would also be serviceable in a recto-house, one presumes?) got nixed once the plumbers unions found out how little labor-time it would take to install, possibly even circumventing any requirements for their professional services at all.

So how much of Bucky's self-promotion was hot air, and how much has been demonstrated? As I recall, some of the materials prescribed for both the dymaxion house and bath were of the order of plastics, which hadn't come into existence yet. Bucky used to say he decided, after studying the various timelags that he saw existing in various industries between the inception of an idea and its practical application (the most egregious of which, 50 years, he saw existing in the housing/construction industries), that he wanted to live his lifeplan 50 years out from the rest of humanity, thereby avoiding the carping of the critics: ``I do not care that I am not understood, but I do not like to be misunderstood." (rough paraphrase.)

It would seem, from the posthumous discovery of the Fullerenes, that at least some of Bucky's visions were spot on.

## **6.9 Where would you encourage your best friend to start in the Fuller literature? (For maximum ease of mastery) [Jeff Perth]**

[ See [Bibliography](#) for full citations. *Cosmography* is a great introduction. *Critical Path* is also very good. [Synergetics](#) (both volumes) can be started immediately, but be prepared to build lots of models to clarify the text (and/or set it aside for awhile when the going gets tough : ) Several fun but less complete works are *Operating Manual for Spaceship Earth*, *Tetrascroll: Goldilocks and the Three Bears: A Cosmic Fairy Tale*, *No More Secondhand God: And Other*



*Writings, and Grunch of Giants.* ]

[From Leo Elliott]

I would highly recommend, for those who may wish to see the genesis of some of Bucky's ideas, a review of his 1938 ``Nine Chains to the Moon."

## **6.10 Quotes and Coinages.**

``Dare to be Naive" -RBF in ``Moral of the Work" in [Synergetics](#). ``Ownership is onerous" -RBF [From Kirby Urner]

Greetings ``buckyophiles!' ' <-- term coined by Gene Fowler,  
the armed-robber poet-founder  
of the Regeniusing Project.

[From Chris Fearnley]

I have my favorite Fuller quotes on the web at

<http://www.CJFearnley.com/cgi-bin/cjf-fortunes.pl?srchstr=Fuller&name=Submit>.

## **6.11 Bucky: humanitarian or cold-hearted technocrat --- The value of a man?**

[Admittedly to call the below thread distilled wisdom is pushing it. Maybe I will think up some way to edit it down into some pithy conclusion, but not today, sorry. Perhaps you like this lengthly discussion? E-mail me with commentary.]

[From Gerry Segal]

Some of R.B.Fuller's actions especially regarding the invention of tensegrity structures and his involvement with Werner Erhardt, EST and World Hunger project do not say much about the man.

It's his ideas, and through his ideas his hope for people that become important. I.B. Singer, the Nobel Laureate writer once asked if he would like to meet and talk with Leo Tolstoy said That while he read every word of Tolstoy he wouldn't cross the street to talk with him. His human failings might destroy the ideas he placed in his mind.

[From Alex Soojung-Kim Pang]

Gerry Segal points to what I think is an important question in evaluating Fuller's life and the value of his work. Having concentrated much of my attention on Fuller's inventive activity, I tend to evaluate him in terms of his work with and for the Marines, Strategic Air Command, Department of Commerce, etc.; and a study of this side of his life reveals a Fuller who was a vigorous Cold War technocrat, relatively unconcerned with the things for which he is now remembered-- his philosophical work, his geometry, etc..

I think there is value in trying to evaluate him on the basis of his ideas, since in the last 20+ years of his life he was essentially a public philosopher, not so much an inventor. But this raises another thorny problem, that of trying to measure the impact of those ideas, particularly from about the mid-1960s on. The fact that Fuller could both have the *Whole Earth Catalog* dedicated to him, AND at the same time be condemned by Theodore Roszak (author of *Making of the Counterculture*) as the Ultimate Technocrat (and therefore an intellectual conspirator in a system that has produced the evils of materialism, ecological despoilation, exploitative labor systems, etc.) points to a fundamental problem of reading and interpretation: what do Fuller's ideas ``really" mean? What should we make of, and how should we evaluate, interpretations of his ideas?

For example, in collecting accounts of Fuller's speeches in the late 1960s and 1970s (published in underground newspapers, mainstream magazines, and professional and trade journals), I've found that there developed a set of tropes

describing Fuller's impact on his audience. It went something like this: "Fuller gave a four-hour marathon lecture that left his audience exhausted but exhilarated, dazzled by his vision and enthusiasm. Few members of the audience could follow exactly what he said, but it was the tone and Fuller's presentation that really mattered." Statements like these, it seems to me, make problematic claims about the value of his ideas, even as they stand as a testimony to his powers of self-presentation and ability to inspire audiences. Many people obviously came away from these talks feeling that they had seen something profound; but few, I am coming to believe, actually came away with any kind of grounding in Fuller's intellectual system. There was a huge difference between the read Fuller and the performed Fuller; that difference is the key to understanding how he could be honored by Stewart Brand and vilified by Theodore Roszak; and it raises deep questions about the value of his ideas and the importance of his life and work in the long run. These are questions I'm puzzling through, and which I intend to address in my book on Fuller and the dome; I'm not yet sure if he ultimately deserves a larger place in history, a smaller one, or the place he has now.

[From Kirby Urner]

The charge that Fuller is a "cold warrior" stems from his work with/for the US government. Geodesic domes had a strategic value from the beginning. On the other hand, more than most academics, and certainly most architects and engineers, Fuller has done much to vilify capitalism, or LAWCAP as he called it ("lawyer capitalism"). The dust jacket of his book *Grunch of Giants* proclaims it as "more subversive of the property and profit values of the capitalist system than anything dreamed of since Karl Marx." Yes, Ronald Reagan awarded him the Medal of Freedom. Yes, around the same time Fuller declared the "USA we have known is now bankrupt and extinct." A curious mixture of pro-entrepreneurialism and individual initiative, and anti-corporatism. Too curious for some. I think Fuller's critics are often in the business of gathering second hand sources and citing other critics (e.g. Roszak) vs. tackling the subject material directly. Second hand criticisms are often cursory and do not reflect serious scholarship. On the other hand, indictments of this or that aspect of Fuller's work by people who really know their stuff are worth airing and I look forward to any such debates online. I have some criticisms of my own to share, if and when these seem relevant.

Gordon C. Muth III writes:

```
> fuller was naive to believe that because he had come  
> up with a better way to live that the world at large  
> would one day accept it.
```

Well, if he thought his vision was *exactly* what would bear out, yes. But I think his longing for a world without so much deprivation at the basic survival level was just the broad brush strokes. His little blurbs on the back of other futurists' books (e.g. Gerard O'Neill's -- a maglev guy) show that he was open-minded enough to endorse other visions. Of course he thought his inventions would have a role to play. But many inventors have thought this, and were not naive to think it -- was Edison naive to think the light bulb would catch on?

BTW, I think there *is* a basic shortage of adequate housing even now. I like Fuller's idea of converting a lot of downtown office space to dorm/workspace units, while wiring the suburbs for "learning a living" in a tele-democracy. That would cut back on the mad ebb and flow of millions of tons of steel (i.e. cars) to and from "the office" (hi honey, I'm home).  
-Kirby Urner

## **6.12 What was the nature of Fuller's involvement with Werner Erhardt, EST and the World Hunger Project?** **[Lance Fletcher]**

[From Kirby Urner]

Around 1980, Werner Erhard rediscovered Fuller and found Fuller's lifelong commitments (to serve "omnihumanity") were illustrative of his own "making the world work for everyone" motto. Fuller appeared jointly with Erhard in Madison Square Gardens, where Erhard delivered emotional praise and Fuller spoke for several hours about the need to promote tetrahedra over cubes as a way of saving humanity (I was not present -- as an est graduate, I was getting the newsletter and read about it, and this sparked my renewed interest in Fuller and sent me off to read *Critical Path*)... Fuller's grandson, Jaime, did the est Training and for some time there was overlap in interest and volunteers. Asked what Fuller thought of Erhard on the Larry King show, Fuller said he thought he was "a good boy" or something to that effect

(contrary to Erhard's own assertions that he was "bad" -- in the Michael Jackson sense perhaps).

EST was supposed to be in lower case, meaning "to be" in latin. But for legal reasons (you can't name a corporation using italicized, lower case latin), it was also an acronym for Erhard Seminars Training. The Training took place over 2 weekends. 250 or so trainees would commit to sticking it through to the end after being briefed on what was to take place and after being given opportunities to leave. They were also not to chew gum, snack or leave for the bathroom except at scheduled breaks ("bathroom at will" people sat in the back row, for anyone with medical conditions requiring exceptions to the norm). The first weekend especially was a hard-hitting oral delivery that many labeled a "tearing down" and which earned est trainers the title of "verbal marines." Trainings were not advertised but graduates were strongly encouraged to "share their experience" of the training. At its peak, EST was active in many cities both statewide and overseas. Many books came out on the subject, and a biography. Erhard later got into racing cars (Formula One) to discover "what works" in organizations. Although many were strongly critical of Erhard's work, I think knee-jerk responses, either pro or con, are inappropriate vis-a-vis a complex and of course not unflawed enterprise. Walter Kaufmann, a well-known Princeton philosophy prof, was one of my teachers at the time, and he spoke highly of the est Training, which he had done the previous summer. He made it sound quite interesting so I enrolled.

The World Hunger Project was developed to promote the idea that World Hunger was a problem that could be solved, that only the political will to solve the problem was absent (i.e. food shortages were not the root problem). Erhard helped found the organization and Fuller was on the Board (of Advisors or Directors I'm not sure). The WHP was controversial because it was primarily a marketing and public relations enterprise aimed at changing attitudes i.e. awakening peoples desire to truly end death by starvation as a significant problem on the planet ("an idea whose time has come"). Because the money went to propagandize this cause, vs to actual relief workers or food shipments, it was branded by many as a sham and as further proof that Erhard was a con artist. Many have never forgiven Fuller for getting mixed up with Erhard's work, but as a "do your own thinking" type, Fuller was never one to let others' opinions be the determining factor.

[From Leo Elliott]

This business of self-promotion would certainly make him a fit with Werner Erhard, from what I have been able to make of the man and his movement. (btw, I am a more recent graduate of the kinder, gentler est, now the Forum, run by Landmark Ed. out of Alexandria, VA; last I heard Werner was off in Russia, drumming up new business, and letting his reputation get settled here in the states). I have an old Crawdaddy magazine account of the great encounter between the two magnates of consciousness, and the somewhat skeptical writer definitely presents Erhard as one who is trying to cop a hit off Fuller's prestige; hard to imagine, but if the account is correct, Erhard backs down from Fuller when Fuller disagrees with the est-imation that brain=mind.

I find it also interesting that, even now, the Forum-est, like Scientology, is billed as a "technology" (vs. what?, a psychotherapy?, a pyramid-marketing scheme?).

## **6.13 What were relations like between Fuller and his Students?**

[From Alex Soojung-Kim Pang]

Kirby writes:

>Die-hard Fuller apologists may suspect the master was playing hard ball  
>with his former student -- learn to self-promote, kid, like I did, cuz  
>no one else will do it for you.

This seems like a bit of a stretch, even for the best apologists-- "I'm stealing from you for your own good, it will make you stronger." I would like to propose an alternative, that Fuller's relationship with Snelson [Ed: See section [Who was Kenneth Snelson and what was his role in the invention of tensegrities](#) for some context] can be seen as an example of the problematic relations Fuller had with students in this period, problematic because of claims Fuller made as sponsor and inspiration of their work, and disputes over the ownership of ideas and artifacts.

It comes as no surprise to readers of this list that Fuller was always concerned to maintain control over his intellectual

property rights. Aside from the financial strain losing control of inventions brings to inventors, there are deeper worries about losing other links between you and your creation-- how it is used, who it is associated with, etc.. Fuller required students to sign statements in which they swore to "protect my proprietary rights," as he told an architecture professor. "In return for their pledges," he continued,

"I agree to provide them with unrestrained, unguarded disclosures of my evolving thoughts concerning unique experiences and emerging inventions."

So far not a bad bargain. But Fuller made very large claims about the relative contributions he made to a student's work, and who ultimately owned the fruits of a student's labor. At Washington University in 1955, for example, after students complained that they had not been given sufficient credit for their work in developing a prototype dome, Fuller fired back to the Architecture School Dean:

"It must be remembered that the Dome was manufactured... ONLY because I had an experience-fertilized teleological design backlog.... It is true that every student was responsible for some phase of ORIGINAL design conceptioning, but none of them must make the mistake of thinking... that they have been responsible for teleologic processes as yet beyond the limits of their experience and capacity.... The thesis students only designed the sub-complex forwarding requirements of my preconceived comprehensive solution."

Now, once this is decoded, it contains a truly remarkable claim. What I think Fuller is saying-- and this is the interpretation drawn by several Architecture School professors-- is that because he developed the mathematics by which domes were designed, and he IMAGINED the work that students would do under him, that *students had no claim whatsoever to authorship or anything they did under Fuller's direction*. The message was not "learn to self-promote, kid," but rather "because I imagined all this before I came here-- and because you're not old enough to have done any of this on your own-- I own this work, and you don't. The fact that YOU actually did the work is of not the slightest consequence."

This is hardly the only example of arguments Fuller had with students and colleagues over the division of spoils and attribution of authorship in collaborative projects; throughout, Fuller maintained that HIS participation was necessary for work to be done, and that this was sufficient to establish exclusive ownership of prototypes and ideas. He ultimately broke with the NC State School of Design, which had been a generous provider of support and apparently gracious host to him, over precisely such issues.

In E.M. Forster's *Maurice*, (Lord Risley) declares, "Words ARE deeds." For Fuller, if my take on him is right, imagining was doing, and moreover, it was ownership.

[From Kirby Urner]

My feeling is that Fuller wanted to be the Father of Great Gifts to Humanity (and I personally acknowledge him for being precisely that) but in no way an anonymous benefactor. In Fuller's vision, intellectual property conventions might well dissipate over the long haul (a lot of what he meant by "creating artificial scarcity" in the chapter "Legally Piggily" of Critical Path I read as an implicit indictment of modern-day intellectual property conventions), but he wanted his "ownership" of his contribution to be writ large in the pages of history.

Most of us came to know Fuller when he was already famous ("best known American genius" or however the cliché goes), but for years he struggled in relative obscurity, developing that Ralph Nader mentality that says "how can I sleep when the Corporations are working 24 hours a day, seven days a week, all around the globe?" Given the way Disney, Inc. effaces Fuller's contribution to Epcot, the way that Philadelphia museum [above postings] uses his map without attribution, the way Synergetics is ignored, the way individuals in general are removed from the picture to make them feel appropriately helpless in the face of Corporate all-powerfulness, I can understand where Fuller's conditioned reflexes come from. He is downright *furious* in some dimension. Students, guiltless and innocent, felt the onslaught of this guy's life's mission to buck the tide of history, which is about (felt Fuller) making ownership of critical assets the sole privilege of literally soulless legal fictions called Corporations.

That Fuller's jealous guarding and hoarding of credit-to-himself for what he felt was proof of the glory of God makes him even more the caricature -- at bottom was not a selfish drivenness to make money, but an ethical principle. To my way of thinking, none of this makes him more pathetic or ugly, but only shows how starved we as individuals are for acknowledgment, how imprisoned we feel as cogs in the machine. Without getting too maudlin, I think Werner Erhard felt precisely this in Fuller, his deep hunger for acknowledgment, and I am grateful to Erhard for offering wholehearted

gratitude to Fuller at Madison Square Gardens.

[From Gerry Segal]

Bob Stubenrauch of Canton Ohio wrote a letter in today's (18 Oct 1993) ``New York Times:"

``The awesome earthquake in India with its tremendous loss of life brought back memories of two weeks with Buckminster Fuller, the engineer and inventor, 40 years ago.

``I was working for a custom photo lab in New York. Mr. Fuller brought in a notebook, every page filled with his crabbed notes and wonderful sketches of his ideas. For two weeks I printed photo reproductions of that notebook, while Mr. Fuller chatted at my side in the darkroom.

``One of his dazzling concepts was for housing the poor people of India. He had planned a huge factory and airport complex for that purpose. In the factory were assembly lines producing lightweight geodesic domes, the walls covered in a heavy transparent plastic.

``Each dome had a ring mount at the peak, and as it came off the line a waiting helicopter would hook up and fly off with the dome swinging below. The sketches showed a sky full of these choppers in formation, flying off to a prepared site to set down an instant town.

``Fuller's estimated cost per unit (this was very low-wage India of the early 50s) was \$40.

``It is a sad irony that ancient traditions, like the dangerous use of unsupported clay or stone blocks, continue, when visionary concepts like Fuller's could have saved thousands of lives if implemented for housing. It was accepted, and hundreds of domes built, for our early-warning radar outpost in Alaska, the DEW line of cold-war days.

``New technology is always first embraced by the military, a sad commentary on the priorities of governments."

Mr. Stubenrauch was right. The structural tension-compression equilibrium of the domes would have saved massive amounts of life. We communicate in this electronic environment on an electronic highway that also grew from the loins of the Defense Department ARPANET. Maybe we can use this and other lists to help create the development of innovative ideas without using the ``rearview mirror" approach of the military. We have to do it to get through what Bucky called Humankind's ``Final Exam."

[From Alex Soojung-Kim Pang]

I read the ``New York Times" letter with interest, since it was the first citation I'd seen of Fuller's thinking on using domes as emergency shelters. And certainly Mr. Stubenrauch is right to raise the question of whether military ``first use" of high technology speaks well of the values of the society supporting that military. However, while Fuller may have had sketches in his notebook showing domes airlifted to the Third World, and in the early 1960s did a couple short courses in architecture schools on the use of indigenous materials (especially bamboo) in dome-building, it is important to remember that the dome's use by the military happened not in spite of Fuller, but because of him.

In fact, in reviewing Fuller's research in the 1950s, I find that he never presented students with the challenge of using the dome to solve Third World housing problems. He had a carefully-managed network of small consulting firms, architecture schools in which he held visiting lectureships, and a good-sized group of student volunteers (he was, in fact, an able if unusual manager who was deeply concerned with questions of securing patrons, exerting control over intellectual property rights, etc.) in this period, and they spent most of their time working on military and civilian defense applications of the dome. The initial studies for the DEW line domes, for example, were done by Fuller and students (mainly students) at MIT; studies for the Marine Corps were conducted at MIT, Tulane, NC State, and Virginia Tech. Other students designed automated cotton mills in geodesic domes, and worked under Fuller on designing private and public structures that could withstand atomic bomb blasts. Studies of how the dome could be put to more humanitarian uses, in contrast, seem to have received almost no formal attention from Fuller or his students.

This is not to say that Fuller was not interested in the dome being used in the Third World; but his vision, at least as described to his military patrons, was rather more complex and perhaps more sinister than Mr. Stubenrauch reports. Fuller articulated this vision in letters now held in the Marine Corps Historical Center archives; in them, he complimented the Corps for their interest in using domes in forward logistics plans (in which domes, filled with aircraft repair equipment, would be rushed to contested areas in the Third World at the first sign of Communist mischief,

shortening logistics lines and allowing stronger support for air wings), and that they had discovered the key to winning to the Cold War. To quote:

``The Marine Corps [has created] an unexpectedly double-barrelled gun: one barrel for the hot war, one barrel for the cool war. The hot war barrel of the Geodesic structures weapon will function in the manner we have outlined above [e.g. in providing logistics and repair facilities for aircraft]... The cool barrel of the Geodesic structures weapon-inadvertently adopted by the Marine Corps -- is the barrel which can now hit directly, instantly, and effectively at the heart of every peace-time economic pattern the world around...

``The logic governing the possibility of our winning the cool war runs as follows: controlled environment is the comprehensive package which contains and permits the uniquely high vantage functionings of industrialization. And it is towards industrialization that peoples of the world now direct the war-detouring hopes of swift emancipation from all the fundamental physical disadvantages and lethal deficiencies.... And, every function of further world-around industrialization is dependent upon the accelerated realization of comprehensively deployable environment controls....

``The swift delivery half-way around the world ... of all manner of controlled environment structures ... is a first requirement of all integrated agricultural and industrial economics - from farm buildings to factories, to governments, to homes.... If world man can witness the economically realized production of controlled environments capable of converting to man's unprecedented advantage the most hostile environment events of converting to man's unprecedented advantage the most hostile environmental events ... then world man's intuitive response will be to focus his hopes of swiftest emancipation from 'what ails him' toward the heart of the American economy and the democratic processes which provide the synergetic strength of the U.S.A."

Fuller's other writings and speeches from this period deliver (broadly) the same message: that domes, filled with power stations, hospitals, factories, etc., preassembled in the United States and airlifted to underdeveloped countries, would yield overnight industrialization and the reconstitution of these nations into American-style societies and economies. This vision is a far cry from the emergency shelters; it is also the one Fuller invested more in, and in which he was more interested. The domes weren't empty, either in a literal or political sense.

[From Kirby Urner]

Alex --

I cannot initially agree with your thesis, although I might see your points better with further elaboration.

True, Fuller was well-nigh incomprehensible to a large percentage of his listeners, partly because he threw out words like ``tetrahedron" with high frequency (a glaze-over word), but mostly because he used what people called his ``boardroom drawl" -- he slurred his words together pretty seriously.

Nevertheless, what came out of his mouth, transcribed, does not appear so divergent from what he wrote (I have 40 hours of transcribed audiotape in my collection to compare with his books). I really don't think differences in the spoken vs. printed Fuller accounts for the Whole Earth vs. Roszak dichotomy.

Like any lifelong writer, Fuller recapitulates and recontextualizes his earlier writings in later texts, trying to give his readers a sense of what *he* thinks is relevant. His early work for the Dept of Commerce & Forbes Magazine, he later tells us, was important because it got people to measure wealth in terms of energy use per capita, vs tonnage of raw materials per capita. His emphasis back then, as later, was on ``doing more with less" -- the Dymaxion House being the paradigm example. Time to get away from the idea that higher living standards involves consuming more ``stuff" per capita -- or even more energy, ultimately.

My personal feeling is that Roszak is fundamentally suspicious of Fuller's assertion that ``artifacts" make a bigger difference than political movements. To Roszak's ears, Fuller is promoting a ``quick fix" through technology, offering as a solution what appears to have gotten us into such deep waters in the first place. The Whole Earth folks, on the other hand, are not technophobic but trend more towards the Cyberpunkish end of the spectrum, these days embracing VR and the Internet as part of their preferred future. Both are reading/hearing the same text and reacting according to their predilections. Both currents were part of the counter-culture, so it is not surprising that the counter-culture was schizophrenic about Fuller.

Fuller himself was a New England Transcendentalist, in the mold of Emerson and his great aunt, Margaret Fuller. He was a mystic. In Fuller's universe, technology is synonymous with the physical. Nature is the supreme architect and

technophile, her creatures being far and away more sophisticated than anything humans have themselves consciously invented. For Fuller, the technology vs nature dichotomy did not exist and he was dismayed that the counter-culture might throw out the technology baby with the evil-uses-of-same bath water.

In sum, I think, as you do, that Fuller was controversial, but not because his listeners and his readers were getting (or not getting) seriously different pictures of the man.

[And more from Kirby]

The fact remains, that in presenting US Marine readers with visions of made-in-the-USA living standards, to be spread around the globe to "make the world safe for democracy," Fuller is (1) replacing fantasies of ultimate killingry with visions of livingry as the primary means to the desired end (victory for the USA) and (2) casting the problem as one of "detouring war" -- a goal shared by all sides in the 'cool war' (thus common ground with the enemy is established).

I think it is Fuller's ultimate faith in the power of *artifacts* and visions focusing on same, that allows him to work in ways that, from a political point of view, are ideologically inconsistent. How can he sound like such a cold warrior and still be the "gentle genius" of 1960s pop culture? I think we need to take Fuller at his word here: he was radically *apolitical* and willing to propagandize livingry artifacts in whatever ways would speak to his primary audience, in the this case the defense establishment.

I don't have a problem with these ideological positions once I see the common thread throughout: only by raising living standards globally can we detour war. Obviously a Third World (both inside and outside USA national boundaries) in constant need of emergency shelters cannot be the end for which we are striving. The goal was to raise living standards -- and since the USA is not living at the standard Fuller envisioned either, it is not the case that his futurism was merely a projection of contemporary USA living standards on the rest of the world. USA people are living in squalor, in pathetic housing, under onerous and fearful conditions compared to where Fuller hoped we would be by this time.

[From Leo Elliott]

To take Fuller at his word, that he wanted to live, by design, fifty years ahead of his time (that being the longest time-lag, existing in the housing industry, between the inception of an idea and its practical application), one might hypothesize that Fuller was simply good at self-promoting his novel technologies, which often appeared as self-promotion of his intellect, especially since some of his technologies were being designed for materials, or social systems, which had yet to come to pass...

However I would take issue with Alex's statement that "There was a huge difference between the read Fuller and the performed Fuller." While I only saw Fuller live one time in my life, which conforms to Alex's trope of "exhausted but exhilarated, dazzled by his vision and enthusiasm," I have several days of tapes, which, perhaps because they are more controllable than a stage presentation, permit a closer look at the visionary language and how he constructed these scenarios, and also permit of less exhaustion, coming as the tape cassette does, in controllable dosage.

However, my point is that serious concentration on some of Fuller's texts has at times led to exhaustion as well; I am reminded of a picture in Applewhite's *Cosmic Fishing* supposedly depicting a galley proof of a page from one of Fuller's books, supposedly ready for typesetting, in which Fuller practically rewrote the entire text in the margins. His seemingly off-the-wall ("precessional") spinoffs in his oral deliveries are similar, imo, to the tangential approach Fuller used in many of his texts, to illustrate some common theme or idea. Whilst it may appear, to the casual observer, as stream-of-consciousness writing OR speaking (and mind you, I'm not saying it wasn't -- in fact, I've often wondered, in my more mystical moments, if RBF wasn't channelling some Ancient of Days up there on stage! ;) -- despite the appearance of stream-of-consciousness, I've found a great sense of awe, at times, at being brought back, completely from left field, to the starting point of the argument. The great Ah-haaa ...

## **6.14 What is GENESIS II?**

[From Kirby Urner]

Was chatting with Russ Chu the other night -- he's a long time BFI affiliate and good with hands-on artifact-making. Worked with Terry Gwilliam on tensegrity furniture and stuff ...

Anyway, I was asking him about the GENESIS II in the LA area. A dozen domes (looks like 1 doz. eggs?) sits by the freeway, sheltering the homeless.

NPR (Natl Public Radio) did a spot the other evening. Russ says American Temporary Shelter, Inc. is behind those fiberglass domes, which appear to be about 5/8ths of an icosasphere -- I don't know what frequency.

The cost, as I hear from NPR (Natl Public Radio) is about \$6500 per unit.

[From Brady Thompson]

There was a short article on the project GENESIS II reprinted in the Toronto Star from a LA Times article. As I recall, the cost of the units was about \$8,000 U.S. and the interior lining was ferro-concrete.

[From Kirby Urner]

Just got my most recent TrimTab from the Buckminster Fuller Institute today. It has some of the information I was looking for about that community for the homeless in LA. Here are some excerpts:

``The domes are made of fiberglass and are similar in structure to plywood domes. They are 20' in diameter and have many windows. Each dome takes only two to three hours to assemble allowing for speedy construction for the whole community ... The whole community can be put up in only five weeks ...

Craig Chamberlain, who worked with Buckminster Fuller in the 1970s, has helped Ted Hayes [ head of Justiceville/Homeless USA ] with the specifics of the dome construction ... A sample of each type of domes was on display in the Los Angeles location. These structures included a kitchen with two of everything, a laundry room with multiple washers and dryers, a dome with four individual bathrooms and showers, and the shelter dome split into two private bedrooms.

On November 5th Genesis 1, a one-acre community of 18 Omnisphere domes in downtown Los Angeles celebrated its grand opening as the first pilot dome village. Funded by ARCO, the domes were erected by homeless workers and the American Temporary Housing Corporation. If the first year is successful, Justiceville/Homeless USA hopes to erect such villages in other cities. Hopefully, Hayes and his volunteers have started a continuing trend of solving our shelter needs by doing more with less."

Article by Melinda McDonald, BFI TrimTab Bulletin, Fall/Winter 1993 contact: JHUSA 1316 Wilshire Blvd, LA, CA 90017 (213) 483-8783 for more info.

## **6.15 Could Fuller's proposed Very Large Structures work?**

[From Martin Roller]

Buckminster Fuller claims in several of his books, that using dome constructions one could build arbitrarily large structures, the only constraint would be the available material (see e.g. the sketches of floating spheres of diameter one mile or a bubble enclosing Manhattan in *The Dymaxion World*). Frei Otto, a German architect, argues that this is still impossible, nobody could build a structure (arc, roof etc.) spanning one mile, say.

Does anybody know Fuller's precise calculations for the structural stability of domes or more details of Otto's case against it? Who is right?

[Chris Fearnley]

Since no one has ever built such Very Large Structures, we can't know for certain. But in dome theory the key variable is radius and no restrictions are placed on its value. So there is no reason to suspect that they wouldn't work. In fact geometrically the only way they could break were if a joint popped or strut broke. This is why Fuller suggests using very high frequency geodesics for large structures.



## **6.16 Why did Fuller apply for patents?**

In *Critical Path* p. 149 Fuller writes:

``I did not take out the patents to make money but only to document and demonstrate what the inventive little individual can accomplish, and to prove documentably the socioeconomic existence of such unique industrialization lags. ...

``Now that I have proven that an individual can be world-effective while eschewing either money or political advantage-making, I do my best to discourage others from taking patents, which almost never `pay-off' to the inventor. My patent taking was to effect a `bridgehead' accreditation to more effective employment of humanity's potentials."

[From Kirby Urner.]

Highly recommended:

``The Economy of Ideas: A framework for rethinking patents and copyrights in the Digital Age (Everything you know about intellectual property is wrong)." By John Perry Barlow in the March 94 issue of WIRED. Barlow is co-founder of the Electronic Frontier Foundation and lyricist for the Grateful Dead.

``Perhaps those who are part of the problem will simply quarantine themselves in court, while those who are part of the solution will create a new society based, at first, on piracy and freebooting. It may well be that when the current system of intellectual property law has collapsed, as seems inevitable, that no new legal structure will arise in its place."

## **6.17 Is there a Bucky CD-ROM available?**

There is periodic talk of people working on this. Here are some relevant postings.

[From Blaine A. D'Amico.]

Ed Applewhite has succeeded in interesting the Voyager company in publishing an ``Expanded Book" (multimedia) on Fuller and Synergetics. The challenge now is producing the product.

This would obviously be different from the clips that you are suggesting. However such a CD-ROM would certainly ease the development of this expanded book and other projects.

I'm slowly collecting the equipment to capture some of my video and sound footage into digital format.

[From Kirby Urner]

A thumbnail history of the scanning project: Russell Chu, Robert Orenstein, and Hal Hildebrand donated a lot of resources and time, to get a prototype IBM clone set up at the institute. Bonnie Goldstein (BFI staff) had earlier sketched out the scanning project in a document, with input from these folks.

Hal's first donated motherboard wasn't powerful enough, so Russ helped out and got a 386DX with 8MB RAM. Hal is/was a super high powered SmallTalk programmer then with a document scanning defense contractor and the idea was to scan ``Everything I Know" as the basic text -- that's a transcribed version of spoken cassette tapes. This would form a core to which other materials could later be linked, hypertext fashion.

Hal's SmallTalk program was to be the receptacle and retrieval system. Robert Orenstein was sort of lining up to apprentice under Hal to learn enough SmallTalk to help out (Hal lived in the Bay Area, far enough from BFI to make tech support tough).

But all these folks are/were busy busy earning livings. And SmallTalk is a pretty steep learning curve (I tried, got as far as the 4D turtle I described earlier -- my hardware was inadequate too back then, although later Russ gave me his 386DX motherboard, and now I have a 486...never understood Hal's document handling system).

Hal drifted off to form his own small business to market a multi-user SmallTalk operating system called Tensegrity. Russ (in construction) moved to Seattle and got married. Robert is still in LA and continues doing trainings for Ingres. The Institute itself got caught up in needing to move away from LA.

So ... no progress on the scanning front. The idea of using ``Everything I Know'' as one backbone scenario through a hypertext archives seems valid, although the transcript itself has the drawback of being transcribed speech -- not as polished syntax (but a good read nevertheless).

[From H. Jeffrey Rosen]

The recent thread RE the scanning project recalls a proposal I made to the BFI over a decade ago, while I was working as a videodisc specialist in the aerospace industry. My idea was/is to marry a videodisc based image archive to Bucky's scanned written/spoken works.

The last time I saw Bucky was in Pasadena, about eight months before he passed away. I mentioned my concept to him, proudly admitting that it was his vision in *Education Automation* which had inspired me.

He nodded gently, staring at me with those incredibly deep eyes, and said with a hint of regret, ``Y'know, I've been meaning to do that."'

I spent many afternoons at the house in Pacific Palisades with the Synergetics Discussion Group reviewing flowcharts, hypertext schemes and the index of videotapes compiled by Applewhite. We were all very excited about what the new interactive technology was offering us, and how the BFI could use it to make Synergetics more widely understood.

Even in my local discussion group in Long Beach, I explored ways to popularize the ideas of RBF in the media, designing what I called ``Commercials for Sanity'' which would have run on public access cable TV.

Sadly, Allegra had to postpone consideration of the proposal indefinitely, citing high equipment costs and shortages of human resources. After all, the BFI had only just moved to LA, and most of the volunteer help was busy figuring out where to store stuff.

So now that the text-scanning discussion is taking form, I'd once again like to offer this idea to the Bucky Fans on the Internet: a holistic (spherical) curriculum model, based on fundamental (synergetic) design concepts, as the human interface/front end of an all-inclusive, ever expanding hypermedia database.

Users will subscribe to the service through the BFI on a fee-for-use basis, allowing BFI to waive fees in particular cases at first, and perhaps altogether, after the value of the tool has grown, in favor of a royalty-based agreement with the users of the info.

The design curriculum allows tailoring of the interface to all ages and cultures. The hypermedia links the written, spoken, transcribed words of Bucky, his confederates, associates, critics, biographers etc. with the vast archive of images, models, pencil sketches, movies, videotapes etc. which are detailed in the Applewhite index, and which have been growing, I'm sure, over the past decade.

This tool is an achievable goal. It requires the support of the BFI, and the determined labor of people who believe both in the value of information and the future of humanity.

## **6.18 Why is overspecialization dangerous?**

[From *Synergetics* - typed in by Kurt Przybilla]

We are in an age that assumes the narrowing trends of specialization to be logical, natural, and desirable. Consequently, society expects all earnestly responsible communication to be crisply brief. Advancing science has now discovered that all the known cases of biological extinction have been caused by overspecialization, whose concentration of only selected genes sacrifices general adaptability. Thus the specialist's brief for pinpointing brevity is dubious. In the meantime, humanity has been deprived of comprehensive understanding.

## **6.19 Letters from Bucky to Mark A. Burginger.**

[From Mark A. Burginger]

The following letters and more are available at Mark's website

<http://www.burginger.com/STRUCTURE/Bucky%27s%20Letters/>.

## Letter #1

R. BUCKMINISTER FULLER · 3501 Market Street, Philadelphia, Pa. 19104 · USA · (215) 387-5400 · CABLE:  
``BUCKY"

· University Professor Emeritus Southern Illinois University University of Pennsylvania · World Fellow in Residence  
University City Science Center

February 11, 1980

Dear Mark Burginger:

I think very well of your drawings of the prismatic polyhedral system and other systems. You are an excellent geometrical illustrator and you're clearly doing your own thinking regarding the nature of structure. I went a long time before anyone looked at my work. I'm particularly interested in your photon package drawing as inspired by SYNERGETICS. Your complete system should not be up-and-down but in-and-out. Your interlocking of shell groups, represents good thinking and good drawing.

I wish you well.

Faithfully, Signed: Buckminster Fuller

Buckminster Fuller

Mr. Mark Burginger 2288 Lucretia Ave. #3 San Jose, CA 95122

BF/kk

· Architectural Societies Royal Institute of British Architects, Honorary Fellow Royal Architectural Institute of Canada, Honorary Fellow American Architectural Institute of Architects, Fellow Mexican College and Institute of Architects, Member Society of Venezuelan Architects, Honorary Member Israel Institute of Engineers and Architects, Honorary Member Zentralvereiningug Der Architekten Asterreichs (Austria), Honorary Member Association of Siamese Architects Under Royal Patronage, Honorary Member

## Letter #2

R. BUCKMINISTER FULLER · 3501 Market Street, Philadelphia, Pa. 19104 · USA · (215) 387-5400 · CABLE:  
``BUCKY"

· University Professor Emeritus Southern Illinois University University of Pennsylvania · World Fellow in Residence  
University City Science Center

June 25, 1981

Dear Mark Burginger:

Far from taking offense at the beautiful drawing that you sent me in which you did incorporate ideas of my own, it is so well done I'm having your framed copy mounted in my office.

Congratulations on your drawings for your stainless steel sculpture to be installed in the Lompoc City Hall.

Faithfully, Signed: Buckminster Fuller

Buckminster Fuller Mr. Mark Burginger 1341 Branham Lane San Jose, CA 95118

jb

· Architectural Societies Royal Institute of British Architects, Honorary Fellow Royal Architectural Institute of Canada, Honorary Fellow American Architectural Institute of Architects, Fellow Mexican College and Institute of Architects, Member Society of Venezuelan Architects, Honorary Member Israel Institute of Engineers and Architects, Honorary

Member Zentralvereinigung Der Architekten Asterreichs (Austria), Honorary Member Association of Siamese Architects Under Royal Patronage, Honorary Member

## Letter #3

R. BUCKMINISTER FULLER · 3501 Market Street, Philadelphia, Pa. 19104 · USA · (215) 387-5400 · CABLE: ``BUCKY"

· University Professor Emeritus Southern Illinois University University of Pennsylvania · World Fellow in Residence University City Science Center

February 11, 1980

Dear Mark,

What a beautiful picture of lightning. Thank you so much.

Faithfully, Signed: Bucky

Buckminster Fuller

Mr. Mark Burginger 1341 Branham Lane San Jose, CA 95118

BF/aem

· Architectural Societies Royal Institute of British Architects, Honorary Fellow Royal Architectural Institute of Canada, Honorary Fellow American Architectural Institute of Architects, Fellow Mexican College and Institute of Architects, Member Society of Venezuelan Architects, Honorary Member Israel Institute of Engineers and Architects, Honorary Member Zentralvereinigung Der Architekten Asterreichs (Austria), Honorary Member Association of Siamese Architects Under Royal Patronage, Honorary Member

## Letter #4

R. BUCKMINISTER FULLER · 3501 Market Street, Philadelphia, Pa. 19104 · USA · (215) 387-5400 · CABLE: ``BUCKY"

· University Professor Emeritus Southern Illinois University University of Pennsylvania · World Fellow in Residence University City Science Center

November 14, 1981

Dear Mark Burginger,

Thank you for yours of October 27, and its photographs of the truncated icosahedron with modular form attachments. It may be a good idea; it may accelerate development of the mass production units.

Warmly, Faithfully, Signed: Buckminster Fuller

Buckminster Fuller Mr. Mark Burginger 1341 Branham Lane San Jose, CA 95118

BF/aem

· Architectural Societies Royal Institute of British Architects, Honorary Fellow Royal Architectural Institute of Canada, Honorary Fellow American Architectural Institute of Architects, Fellow Mexican College and Institute of Architects, Member Society of Venezuelan Architects, Honorary Member Israel Institute of Engineers and Architects, Honorary Member Zentralvereinigung Der Architekten Asterreichs (Austria), Honorary Member Association of Siamese Architects Under Royal Patronage, Honorary Member

---

[Next](#) [Previous](#) [Contents](#)

Next [Previous](#) [Contents](#)

---

## 7. Net Resources

### 7.1 The current version of the FAQ is on the Web

<http://www.CJFearnley.com/fuller-faq.html>.

### 7.2 On-line Discussion Forums

This section cataloges the on-line discussion forums related to Buckminster Fuller work.

#### **List Geodesic: [geodesic@listserv.buffalo.edu](mailto:geodesic@listserv.buffalo.edu)**

[From MONTHLY POSTING\* - GEODESIC 'how-to' info by Patrick Salsbury]

GEODESIC is a forum for the discussion of the ideas and creations relating to the work of R. Buckminster (Bucky) Fuller. Topics range from geodesic math to world hunger; floating cities to autonomous housing, and little bit of everything in between. Other lists that focuses more specifically on some of these topics can be found on the [Reality Sculptors Website](#).

To subscribe, send mail to [LISTSERV@LISTSERV.ACSU.BUFFALO.EDU](mailto:LISTSERV@LISTSERV.ACSU.BUFFALO.EDU) and in the body of your letter put the line:

```
SUB GEODESIC <Your Real Name>
```

A web page to signon is available here: <http://listserv.acsu.buffalo.edu/user/sub.html>

The list is gatewayed to USENET as [bit.listserv.geodesic](mailto:bit.listserv.geodesic).

#### LIST ARCHIVES:

Listserv itself is keeping archives of the list, dating back to June, 1992. Send a note to [listserv@listserv.acsu.buffalo.edu](mailto:listserv@listserv.acsu.buffalo.edu) with this message in the BODY of the note:

#### INDEX GEODESIC

You can get help on other Listserv commands by putting the line HELP into the body of the note. (Can be in the same message.)

Web-searchable archives for the lists are available at:  
<http://listserv.acsu.buffalo.edu/archives/geodesic.html>.

Most of the archives are mirrored at [List Geodesic Archive \(mirror\)](#).

## Synergeo

[Synergeo](#) is an unmoderated, public read access, only members can post, mailing list for all those forward thinkers interested in synergetics, geometry, geodesics, tensegrity, and other topics related to R. Buckminster Fuller's work. Set up by Ken Brown in March, 2000 to fill the void left by [Synergetics-L](#).

[From Karl Erickson]

[geomodel](#) mailing list for discussing primarily physical model-building.

[The Struck community](#) has a mailing list, to subscribe to the list, send email to [majordomo@xs4all.nl](mailto:majordomo@xs4all.nl) with the message body ``subscribe struck."

The [Tetworld](#) mailing list and web site are based on Fuller's World Game idea.

## MSN Buckminster Fuller Community

Joe S Moore setup [this MSN resource](#) on Buckminster Fuller.

## 7.3 Web Resources

The Buckminster Fuller Institute's home page is at <http://www.bfi.org/>.

This editor maintains a list of Fuller related URLs at <http://www.CJFearnley.com/buckyrefs.html>.

The World Game Institute's (WGI) home page is <http://www.worldgame.org/>.

## Books by R. Buckminster Fuller on the Internet

*Synergetics* and *Synergetics 2* can be found at <http://www.rwgrayprojects.com/synergetics/synergetics.html>.

*Operating Manual for Spaceship Earth* can be found at [http://www.bfi.org/operating\\_manual.htm](http://www.bfi.org/operating_manual.htm).

*Education Automation* can be found at [http://www.bfi.org/operating\\_manual.htm](http://www.bfi.org/operating_manual.htm).

*Grunch of Giants* can be found at [http://www.bfi.org/grunch\\_of\\_giants.htm](http://www.bfi.org/grunch_of_giants.htm).

*A Fuller Explanation: The Synergetic Geometry of R. Buckminster Fuller* can be found at <http://www.angelfire.com/mt/marksomers/40.html>.

---

Next [Previous Contents](#)

# BUCKMINSTER FULLER INSTITUTE

|                  |                      |                        |                        |                    |                   |       |             |
|------------------|----------------------|------------------------|------------------------|--------------------|-------------------|-------|-------------|
| home             | membership           | donations              | store                  | sitemap            |                   |       |             |
| ABOUT<br>the bfi | HUMANITY'S<br>option | WHO IS<br>r.b. fuller? | BOOKS AND<br>resources | COMMUNITY<br>links | DESIGN<br>science | DOMES | SYNERGETICS |

The documents were produced by Fuller and edited by John McHale, from 1965 to 1975, and remain an important educational tool. McHale summarized the intent of this work “as merely to provide a swift and comprehensive glance at certain fundamental trends in man’s present relation to the environment and indicate broadly how these trendings may relate to the forward task of assessing more completely mans present and future needs.”

“,, So evolution seems to have some very powerful curves which you (the World Resources Inventory staff) are trying to find - not trying to invent” –RBF, World Game, Doc 1, 1971

Original books digitized by volunteers: Tony McKinley, Ed Lynch, John Collins, Bill Johnson, Suzy Evans, Michael Paterra.

## VOLUMES IN THE WORLD RESOURCES INVENTORY (World Design Science Decade)

World Resources Inventory  
Southern Illinois University  
Carbondale, Illinois U.S.A.

- Phase I (1963) Document 1: [Inventory of World Resources Human Trends and Needs](#) by R. Buckminster Fuller and John McHale
- Phase I (1964) Document 2: The Design Initiative by R. Buckminster Fuller
- Phase I (1965) Document 3: [Comprehensive Thinking](#) by R. Buckminster Fuller
- Phase I (1965) Document 4: The Ten Year Program by R. Buckminster Fuller and John McHale
- Phase II (1967) Document 5: [Comprehensive Design Strategy](#) by R. Buckminster Fuller
- Phase II (1967) Document 6: The Ecological Context Energy and Materials by John McHale
- Document I: The World Game (1971) [The World Game: Integrative Resource Utilization Planning Tool](#) by R. Buckminster Fuller.

Phase I (1963) Document 1

## INVENTORY OF WORLD RESOURCES HUMAN TRENDS AND NEEDS

### WORLD DESIGN SCIENCE DECADE 1965 - 1975

FIVE TWO YEAR PHASES OF A WORLD RETOOLING DESIGN PROPOSED TO THE INTERNATIONAL UNION OF ARCHITECTS FOR ADOPTION BY WORLD ARCHITECTURAL SCHOOLS

| Page     | Size   | PDF                                         |
|----------|--------|---------------------------------------------|
| I1_Book  | 4,172k | <a href="#">Full Book</a>                   |
| I1_Cts   | 6k     | <a href="#">CONTENTS</a>                    |
| I1_Title | 675k   | <a href="#">Title Page and Front Matter</a> |

|          |        |                                                                                          |
|----------|--------|------------------------------------------------------------------------------------------|
| I1_Pref  | 11k    | <a href="#">Preface</a>                                                                  |
| I1_Ltr   | 30k    | <a href="#">New Forms vs. Reforms</a>                                                    |
| I1_3_18  | 646k   | <a href="#">MAN IN UNIVERSE</a>                                                          |
| I1_19_26 | 443k   | <a href="#">INDUSTRIALIZATION</a>                                                        |
| I1_27_34 | 207k   | <a href="#">WORLD ENERGY</a>                                                             |
| I1_35_50 | 1,926k | <a href="#">WORLD RESOURCES, HUMAN TRENDS AND NEEDS</a>                                  |
| I1_51_62 | 38k    | <a href="#">Appendix A: Letter to World Architectural Students-R. Buckminster Fuller</a> |
| I1_63_70 | 294k   | <a href="#">Appendix B: Forward Procedure</a>                                            |
| I1_Bibli | 44k    | <a href="#">BIBLIOGRAPHY</a>                                                             |

Phase I (1965) Document 3

COMPREHENSIVE THINKING

**WORLD DESIGN SCIENCE DECADE 1965 - 1975**

FIVE TWO YEAR PHASES OF A WORLD RETOOLING DESIGN PROPOSED TO THE INTERNATIONAL UNION OF ARCHITECTS FOR ADOPTION BY WORLD ARCHITECTURAL SCHOOLS

**Page Size PDF**

|          |      |                                                                                          |
|----------|------|------------------------------------------------------------------------------------------|
| I3_Cts   | 4k   | <a href="#">Contents</a>                                                                 |
| I3_Title | 21k  | <a href="#">Title Page and front matter</a>                                              |
| I3_Frwd  | 119k | <a href="#">Foreword by John McHale, May, 1965</a>                                       |
| 1        | 49k  | <a href="#">INTRODUCTION TO HALO</a>                                                     |
| 7        | 75k  | <a href="#">OMNI-DIRECTIONAL HALO</a>                                                    |
| 27       | 144k | <a href="#">PROFILE OF THE INDUSTRIAL REVOLUTION</a>                                     |
| 33       | 215k | <a href="#">VENUS PROXIMITY DAY</a>                                                      |
| 61       | 31k  | <a href="#">WAVE TRANSFORMATIONS OF THE CITY</a>                                         |
| 65       | 80k  | <a href="#">PROSPECTS FOR HUMANITY</a>                                                   |
| 79       | 240k | <a href="#">GEOSOCIAL REVOLUTION</a>                                                     |
|          |      | <a href="#">Appendix A: Resolution on Theme of Architectural Education, for the UIII</a> |
| 111      | 18k  | <a href="#">World Congress of the I.U.A.,<br/>Paris, France, 1965</a>                    |
| 115      | 13k  | <a href="#">BIBLIOGRAPHY</a>                                                             |

Phase II, (1967) Document 5

COMPREHENSIVE DESIGN STRATEGY

**WORLD DESIGN SCIENCE DECADE 1965 - 1975**



| <b>Page</b> | <b>Size</b> | <b>PDF</b>                                                                        |
|-------------|-------------|-----------------------------------------------------------------------------------|
| ALL         | 1.7 MB      | <a href="#">Document 5</a>                                                        |
|             |             | Contents                                                                          |
| 1           | 76 k        | <a href="#">Man With a Chronofile</a>                                             |
| 9           | 52 k        | <a href="#">Introduction to Design Strategy</a>                                   |
| 15          | 268 k       | <a href="#">Design Strategy</a>                                                   |
| 51          |             | Addendum to Design                                                                |
| 61          |             | Vision 65 Keynote Address                                                         |
| 74          |             | Vision 65 Summary Address                                                         |
| 87          |             | World Game - How to Make the World Work                                           |
| 91          |             | Appendix A: Three Student Project Documentation Briefs with Photos, Illustrations |
| 127         |             | Appendix B: R. Buckminster Fuller Booklist                                        |

## **THE WORLD GAME: INTEGRATIVE RESOURCE UTILIZATION PLANNING TOOL - By R. Buckminster Fuller**

Fundamentals of Satisfaction of the Needs and Trends by the Resources through the WORLD GAME.

- A. Philosophy
- B. Design

| <b>Page</b> | <b>Size</b> | <b>PDF</b>                                                  |
|-------------|-------------|-------------------------------------------------------------|
| 3.9Mb       |             | <a href="#">Full Book</a>                                   |
| 13k         |             | <a href="#">Title</a>                                       |
| iv          | 11k         | <a href="#">Other Volumes in World Resources Inventory*</a> |
| vii         | 18k         | <a href="#">List of Charts, Tables, Maps</a>                |
| ix          | 13k         | <a href="#">Preface</a>                                     |

### **A . WORLD GAME SCENARIO**

|    |       |                                                                                                                             |
|----|-------|-----------------------------------------------------------------------------------------------------------------------------|
| 1  | 49k   | <a href="#">A.1 Preamble and Memorandum to those interested in playing World Game</a>                                       |
| 7  | 287k  | <a href="#">A.2 R. Buckminster Fuller's Presentation to U.S. Congressional Sub-Committee on World Game</a>                  |
| 47 | 1.6Mb | <a href="#">A.3 Fortune Magazine Resource Inventory of 1940 and Data Sources (published manifest of work begun in 1927)</a> |
| 75 | 784k  | <a href="#">A.4 The Fuller Dymaxion Sky/Ocean World Projection; World I/World II</a>                                        |
| 83 | 50k   | <a href="#">A.5 Telegram to Senator Edmund Muskie</a>                                                                       |

**B. WORLD GAME PACKET**

This section presents the rudimentary procedures involved in playing World Game. It does not attempt to be definitive in its procedural suggestions, but merely offers guidelines for those wishing to start a World Game effort, either individually or as an academic program.

- 89            [B.1 Fuller Statement on World Game](#)
- 91      8k      B.2 Design Science by R. B. Fuller
- 95      325k    [B.3 How and Where to Begin by M. Gabel](#)
- 101     48k      [B.4 World Game “World View”/frames of reference by M. Gabel](#)
- 107     23k      [B.5 World Game Format Outline for Scenarios by M. Gabel](#)
- 111     39k      [B.6 World Game Pre-Scenario Integration Outlines by M. Gabel](#)

**C. INFORMATION TO BEGIN STUDYING WORLD GAME**

- 115     67k      [C.1 Fuller Research Techniques for Compiling and Displaying Data by M. Paterra](#)
- 121     145k    [C.2 Examples of Data Handling Techniques by B. O’Regan and M.Gabel](#)
- 135     8k       [C.3 Published Data Sources on World Resources](#)
- 137     17k      [C.4 Data Centers with Additional World Resources Data Availability](#)
- 141     99k      [C.5 World Resources Inventory via Satellite](#)

**D. READINGS**

- 143            D.1 Universal Requirement for a Dwelling Advantage by R.B.Fuller
- 149            D.2 Conning Tower, Geoscope/Miniearth by R. B. Fuller
- 157            D.3 Population Control Dynamism of Universe/No Race, No Class by R. B. Fuller
- 169            D.4 World Game Systems Theory by R. B. Fuller and T. Turner
- 173      128k    [D.5 Prospects for Humanity by R. B. Fuller \(reprinted from Saturday Review\)](#)

**APPENDIX**

- 181      19k      [Organizing a World Game Operation/Various Options](#)

**World Game/1971/Document 1**

...the number of babies. I found, after the Civil War, and after World War I, and World War II, momentarily for about five years, they had more babies. And man didn’t really consciously do that-the young people did not consciously do this. There was a bulge. When you knocked out a lot of people, it broke the smooth curve-she bulged. It was stuck for about five years, and it was during that five years after World War II that all the great talk began about the population explosion. When the people were not dying on one hand, and making more babies to make up for their kids that got killed in the war. So evolution seems to have some very powerful curves which you (the World Resources Inventory staff) are trying to find-not trying to invent.

Contact for help – [tonymck@imagebiz.com](mailto:tonymck@imagebiz.com) – can't wait to hear from you.

Published here with permission ©2001 Estate of Buckminster Fuller.

Find:

[Humanity's Option](#) | [About the BFI](#) | [News](#) | [Community & Links](#) | [Glossary](#)  
[Who is Buckminster Fuller?](#) | [Home](#) | [Membership](#) | [Store](#) | [Sitemap](#) | [Contact Us](#)

Comprehensive Anticipatory Design Science  
An Introduction  
Patrick G. Salsbury  
<salsbury@sculptors.com>  
01-02-00

Comprehensive Anticipatory Design Science, or "Design Science" for short, is a wide-ranging field of study, which focuses on the process of how to go about solving problems. It was pioneered in the early Twentieth Century by R. Buckminster Fuller, and has now expanded to include several generations of architects, planners, engineers, and designers.

It is Comprehensive because it seeks to find an underlying problem or issue, and solve for that general case, rather than for only one specific instance of a problem. For example, one of my primary interests is in understanding the causes of, and designing solutions for, the problems of homelessness on a global scale; Not simply why one person is homeless on the street in my town, or in yours, but why we have more than 400 million homeless people all around the world.

It is Anticipatory because the Design Scientist seeks to understand not just the problem at hand, but how this problem, or similar ones, may manifest themselves over time. Also, to try and foresee what problems a proposed "solution" might bring up, and to plan accordingly. The Design Scientist incorporates statistical data, demographics and population studies, economic data, and current events, to try and forecast trends and figure out where we're heading, collectively, so we can minimize surprises when we get there.

Design itself is the creative aspect of problem solving. It is the process of analyzing your problem, studying other areas that may have supporting technologies to help you, selecting appropriate resources and tools, coming up with the part, system, drawing, idea or whatever is needed to address the issue at hand, and then implementing the solution. Very often, this process must be repeated through numerous iterations, refining and correcting as you go along.

The Science aspect is also crucial. Design Science is not quite like other fields of design, such as interior, graphic, clothing, or artistic design. Nor is it exactly like industrial, computer, or mechanical design. Rather, it incorporates elements of all of these fields, and many others. It draws upon artistic elements, as well as scientific and engineering elements. Employing the Scientific Method to measure, observe, and refine solutions allows one to arrive at solutions that work not just once, but over and over, and in a variety of situations.

An example can probably help to illustrate the general-systems approach that Design Scientists often employ.

Take the issue of having a clean and reliable supply of drinking water. Everyone needs it, and people in developed countries often take it for granted, but in most of the world, there are no taps, and where there are, the water that comes out often isn't trustworthy. In many countries, people will sometimes walk for miles and wait for hours, every day, in order to get water for themselves and their families. In fact, current estimates are that approximately one billion people on this planet do not have safe supplies of drinking water. This, coupled with poor sanitation, contributes to approximately eighty percent of the world's sickness. (see note 1) So, if we could take care of the water problem, we'd also manage to eradicate about 4/5 of the cases of sickness, worldwide. Not a bad side-effect.

A Design Science approach might look at political, economic, and engineering factors (as well as various others), trying to draw upon the strengths of each, while also trying to minimize the drawbacks and weak points. For example, we find that a large, centralized system is both expensive to construct, and difficult to maintain. One break in a strategic pipeline can leave thousands of homes without water.

Drawing from the design philosophy of the Internet, we find that a decentralized model can be very robust, easily maintained in parallel by many individuals, and is able to withstand the ravages of Nature, as well as malicious intent. Dispensing with the accepted municipal model of a centralized water-treatment plant, various large reservoirs and hundreds or thousands of miles of pipes, we are free to explore alternatives. There are a surprising number of them.

Of course, rain catchment is one very simple method. It is employed in many tropical and sub-tropical zones, where humidity is high and rain is regular. Snow-melt is another good source, in the colder regions of the planet. Small filter and purification systems are readily available for homes, allowing many people who live away from municipal systems to draw water from local streams, rivers, and ponds. Atmospheric condensing is another possibility (see note 2), as is capturing the micro-droplets in fog with large, sail-like arrangements of fabric or plastic sheeting.

There are certainly many other ways of approaching the problem. Some are suitable for many areas. Others are most suited for just a few specialized regions. It's up to the Design Scientist to try and determine the most efficient and elegant solution, given the location and scope of the project, available resources, funding, etc. By taking an open-ended approach, he or she may come up with half a dozen or more workable solutions, none of which look like the traditionally accepted models, and which are perhaps less expensive, quicker-to-implement, and more stable than the conventional ideas.

The Design Scientist thus aims to study as many different fields, and become as well-versed in them, as possible. Then he or she may draw upon those various resources to integrate and synthesize, and arrive at new solutions to some very old (and some as-yet-unseen) problems.

In closing, I feel that the overall generalist philosophy of the Design Scientist is well summed-up by a quote from Robert A. Heinlein's character, Lazarus Long:

"A human being should be able to change a diaper, plan an invasion, butcher a hog, conn a ship, design a building, write a sonnet, balance accounts, build a wall, set a bone, comfort the dying, take orders, give orders, cooperate, act alone, solve equations, analyze a new problem, pitch manure, program a computer, cook a tasty meal, fight efficiently, die gallantly. Specialization is for insects."

-----

Footnotes:

(1) UN Development Program, as quoted in "Naked Body", Summer 1998. Printed by The Body Shop

(2) There is further info on atmospheric condensing and water-related issues at the Reality Sculptors web site: <http://reality.sculptors.com/>

Most Recent Update: 01/19/00

[Subscribe to GENI Newsletter](#)

---

The GENI Initiative:

\* Two billion people on this planet have no electricity.

How can we make the world work for 100% of humanity

*in the shortest possible time through spontaneous cooperation  
without ecological damage or disadvantage to anyone?*

(purpose of the World Game™)

***100% of humanity?***

[Click Here to Enter](#)

# The GENI Initiative

A Solution to Global Problems

\* Text of the animated graphical presentation above

[Subscribe to GENI Newsletter](#)

[Download Flash Player](#)

## BUCKMINSTER FULLER INSTITUTE

|                  |                      |                        |                        |                    |                   |         |             |
|------------------|----------------------|------------------------|------------------------|--------------------|-------------------|---------|-------------|
| home             | membership           |                        | donations              |                    | store             | sitemap |             |
| ABOUT<br>the bfi | HUMANITY'S<br>option | WHO IS<br>r.b. fuller? | BOOKS AND<br>resources | COMMUNITY<br>links | DESIGN<br>science | DOMES   | SYNERGETICS |

Education Automation 1 [2](#) [3](#) [4](#) [5](#)

**Education Automation, Freeing the Scholar to Return to His Studies**  
**Foreword by CHARLES D. TENNEY**

SOUTHERN ILLINOIS UNIVERSITY PRESS, CARBONDALE AND EDWARDSVILLE  
 FEFFER & SIMONS, INC., LONDON AND AMSTERDAM

Copyright 1962

ISBN 0-8093-0137-7

Library of Congress Catalog Card Number 62 - 17620

My feeling about today's meeting with you is first, that it is a tremendous privilege as a human being to stand with other human beings who are concerned fundamentally and deeply, as you are, with the process and further implementation of education and to be allowed to disclose to you what I think I have discovered regarding education's trending evolutionary needs. I am quite confident that the Southern Illinois University's new Edwardsville Campus studies are uniquely important.

Because President Morris has mentioned it in his introduction of me to this meeting, let me begin with some of my own student experiences at Harvard, for what I have to offer to you today springs from my several educational experiences. I am a New Englander, and I entered Harvard immaturely. I was too puerilely in love with a special, romantic, mythical Harvard of my own conjuring an Olympian world of super athletes and alluring, grown-up, worldly heroes. I was the fifth generation of a direct line of fathers and their sons attending Harvard College. I arrived there in 1913 before World War I and found myself primarily involved in phases of Harvard that were completely irrelevant to Harvard's educational system. For instance, because I had been quarterback on a preparatory school team whose quarterbacks before me had frequently become quarterbacks of the Harvard football team, I had hoped that I too might follow that precedent, but I broke my knee, and that ambition was frustrated. Just before entering college I was painfully jilted in my first schoolboy into-love-falling. Though I had entered Harvard with honor grades I obtained only "good" to "passing" marks in my college work, which I adolescently looked upon as a chore done only to earn the right to live in the Harvard community. But above all, I was confronted with social problems of clubs and so forth. The Harvard clubs played a role in those days very different from today. The problems they generated were solved by the great House system that was inaugurated after World War I. My father died when I was quite young, and though my family was relatively poor I had come to Harvard from a preparatory school for quite well-to-do families. I soon saw that I wasn't going to be included in the clubs as I might have been if I had been very wealthy or had a father looking out for me, for much of the clubs' membership was prearranged by the clubs' graduate committees. I was shockingly surprised by the looming situation. I hadn't anticipated these social developments. I suddenly saw a class system existing in Harvard of which I had never dreamed. I was not aware up to that moment that there was a social class system and that there were different grades of citizens. My thoughts had been idealistically democratic. Some people had good luck and others bad, but not because they were not equal. I considered myself about to be ostracized or compassionately tolerated by the boys I had grown up with. I felt that my social degradation would bring disgrace to my family. If I had gone to another college where I knew no one, it would not have mattered at all to me whether or not I was taken into some society. It was being dropped by all those who had been my friends that hurt, even though I knew



that they had almost nothing to do with the selecting. I became panicky about that disintegration of my idealistic Harvard world, went on a pretended "lark," cut classes, and was "fired."

Out of college, I went to work and worked hard. In no time at all, reports went to Harvard that I was a good and able boy and that I really ought to go back to college; so Harvard took me back. However, I was now considered a social maverick, and I saw none of my old friends; it hurt too much. Again I cut classes, spent all my year's allowance, and once more was "fired." After my second "firing" I again worked very hard. If World War I hadn't come along, I am sure the university would have taken me back again, and I am sure I would have been "fired" again. Each time I returned to Harvard I entered a world of gnawing apprehensions, not an educational institution, and that was the problem.

But I did get an education in due and slow course—but an education largely of my own inquiring, experimenting, and self-disciplining. Forty-seven years later Harvard's Dean Bundy, who is now one of Kennedy's White House advisors, invited me to come back to Harvard in 1962 to be the Charles Eliot Norton Professor of Poetry. This is regarded as an honor. The Norton professorship is a one-year appointment. The chair was founded because its donor felt that the university needed to bring in individuals who on their own initiative have long undertaken objective realizations reflecting the wisdom harvested by the educators, which realizations might tend to regenerate the vigor of the university world. Harvard fills this professorship with men who are artists, playwrights, authors, architects, and poets. The word poet in this professorship of poetry is a very general term for a person who puts things together in an era of great specialization wherein most people are differentiating or "taking" things apart. Demonstrated capability in the integration of ideas is the general qualification for this professorship. I am able to accept the Norton professorship for 1961-62 even though I am a professor on the faculty of Southern Illinois University because I have to be in residence at Harvard only for the months of February and March, 1962, when I am officially absent from Carbondale.

In the last thirty years of the half century that has passed since my Harvard fiasco, I have been invited as a lecturer, critic, or experimental seminarist to visit 106 universities around the world, and many of them quite frequently. I have had appointments, for instance, to Princeton University nine times, starting back in 1929, M. I. T. eight times, North Carolina State eight times, University of Michigan five times, Cornell University four times, and that's the way it has gone. There have been many revisits, and all of my visits have been entirely a consequence of their inviting me to come. I developed a self-discipline long ago regarding exploration on the science, technology, philosophic, and economic frontiers which requires that I must not spend any time asking people to listen to me or to look at what I may be doing. If, however, what I am discovering seems to be of interest to others and they ask me what it is that I am working on, I will tell them. I am quite confident that if in the evolutionary processes we deliberately attempt direct personal exploitation of the economic advantages accruing to our personal scientific explorations, we inadvertently become preoccupied and prejudiced with the item we have to sell and are no longer free to explore scientifically with a wholesome intellectual integrity.

By my own rules, I may not profess any special preoccupation or capability. I am a random element. Considering these self-imposed conditions, I am happy that I have been asked back to the universities, and I am happy that several of them have seen fit to give me an honorary degree. At Washington University, where I had been a one-month visiting critic and lecturer for four successive years, the University gave me a degree of Doctor of Science, "with all the rights and privileges thereunto attached." I feel that this was not an exclusively honorary degree; the circumstances were akin to those of a doctoral candidate. My degree was voted unanimously by the University faculty as a direct consequence of my campus work. Though I have degrees awarded by other leading universities under similar working or earned circumstances as Doctor of Arts, Doctor of Design, and Doctor of Humanities, I am confident that I am not professionally classifiable. I do know, however, from personal experience that there is nothing even mildly extraordinary about me except that I think I am durable and inquisitive in a comprehensive

pattern. I have learned much; but I don't know very much; but what I have learned, I have learned by trial and error. And I have great confidence in the meager store of wisdom that I have secured.

As a consequence of my university visiting, I have had about two thousand students who have worked with me in different parts of the world. As I go around the world I find these students active and doing well. When I arrive in New Delhi, Nairobi, or Beirut I find that the students know that I am coming. They are waiting for me with programs they have arranged, and I am able to assess the effect of the kind of learning and communication we have shared. I am confident that the boys I have worked with are trending to become strong citizens around the world. That, I find, is one of the best tests of the validity of whatever communicable wisdom I may have harvested and disbursed from my experiences.

My experience is now world-around. During one-third of a century of experimental work, I have been operating on the philosophic premise that all thoughts and all experiences can be translated much farther than just into words and abstract thought patterns. I saw that they can be translated into patterns which may be realized in various physical projections by which we can alter the physical environment itself and thereby induce other men to subconsciously alter their ecological patterning. My own conclusion is that man has been given the capability to alter and accelerate the evolutionary transformation of the a priori physical environment that is to participate objectively, directly, and consciously in universal evolution and I assume that the great, complex integrity of omni-coordinate and inter-accommodative yet periodically unique and nonsimultaneously co-operative generalized principles, and their myriad of special case realizations, all of which we speak of as universe and may think intuitively of as God, is an intellectual invention system which counts on man's employing these capabilities. If he does not do so consciously, events will transpire so that he functions subconsciously in the inexorable evolutionary transformations.

As a consequence of man's having the faculty to apprehend patterns external to himself and the capability of altering those patterns, interesting changes in the conscious relationship of man to universe are now multiplying in evidence. Unlike any of the other living species, man has succeeded both consciously and subconsciously in greatly altering his fundamental ecological patterning. None of the other living species have altered their ecological patterning. All the species other than man are distinguishable throughout geologic and biologic history by their approximately unaltered ecological patterning. In the last half-century, man has graduated from a local twelve-mile radius daily domain into a world around multi-thousand-miles radius daily domain, as a consequence of his ability to alter his own ecological patterning.

I have for a third of a century been convinced that thoughts must be translated into patterns that can be articulated out of the organized capabilities of man and that these patterns, which can be translated from our thoughts into physical actions, then become utterly impersonal facilities that begin when adopted in emergencies to change the relative advantage of man spontaneously and subconsciously with respect to his total environment. It is a philosophic requirement of my comprehensive working hypotheses that the intellectually-projected tools which result in new ecological patternings must give man, consciously appreciable, advantage increase. My experience shows that these impersonal tools tend to eliminate many of the errors of conceptioning that men who have not translated their thoughts into experimental physical undertakings have heretofore imposed upon one another as inherited conventional thoughts and misinterpretations of their respective experiences misconceptions which they have hopefully and lovingly gone on relaying for ages from one generation to the next.

I am convinced that humanity is characterized by extraordinary love for its new life and yet has been misinforming its new life to such an extent that the new life is continually at a greater disadvantage than it would be if abandoned in the wilderness by the parents. For an instance of misconception extension there is my own case. I was born in 1895. The airplane was invented when I was nine years old. Up to the time I was nine years old, the idea that man could fly was held to be preposterous, and anybody could tell

you so. My own boyhood attempts to make flying machines were considered wasted time. I have lived deeply into the period when flying is no longer impossible, but nonetheless a period in which the supremely ruling social conventions and economic dogma have continued to presuppose a non-flying-man ecology.

My daughter was not born into the kind of a world that I was; so she doesn't have to struggle to sustain the validity of the particular set of spontaneously-logical conceptions that were pronounced "impossible" in my day, nor need she deal with the seemingly illogical concepts that the older life thought to be "evident" and "obvious" in my day. The new life is continually born into a set of conditions where it is easier for it to acquire more accurate information, generated almost entirely outside of family life and folklore, regarding what is going on in human affairs and in nature in general; and, therefore, the new life has the advantage of much more unshaken intellectual courage with respect to the total experiences than have its as yet living elders who have had to overcome these errors, but who retain deep-rooted delusively-conditioned, subconscious reflexes.

As a startling consequence of the as yet prevalent and almost total misconceptioning regarding traditional education, both formal and informal, I have heard the following problem discussed among leading scientists. A serious question arises when a university student demonstrates extraordinary capability in science as judged by our present academic criteria. The exceptionally high-ranking student has completed his graduate work, and if enabled to develop further there is high probability that he might be able to make important contributions to science and there through to society. There are funds available to foster the super education of this promising individual, but first there is a decision to be made concerning resources much more important than money. This man is going to have to be associated with some of the senior, proven, living scientists<some of the very rare great men<in order for the latter to find out whether the neophyte is a real front-rank scientist. The neophyte is going to have to be given the opportunity to grow in that association with the proven great one. Therefore, society is going to have to risk wasting some of the preciously meager remaining lifetime of its proven, really high-powered intellects, should the candidate fail to demonstrate exceptional capability. Whether that risk is warranted becomes the strategic question. As a consequence, the kind of examination procedure that our science foundations and other science leaders have developed is one in which they explore to discover whether this capable student is able to unlearn everything he has learned, because experience has shown that that is what he is going to have to do if he is to become a front-rank scientist. The frontiers of science are such that almost every morning many of our hypotheses of yesterday are found inadequate or in error. So great is the frontier acceleration that now in a year of such events much of yesterday's conceptioning becomes obsolete.

I said I started a number of years ago exploring for ways in which the individual could employ his experience analytically to reorganize patterns around him by design of impersonal tools. To be effective, this reorganization must incorporate the latest knowledge gained by man. It also should make it an increasingly facile matter for the new life to apprehend what is going on. It should eliminate the necessity of new life asking questions of people who don't know the answers, thereby avoiding cluttering up the new minds with bad answers which would soon have to be discarded. I felt that the evolving inventory of information "decontaminated" through competent design might be "piped" right into the environment of the home. Please remember my philosophy is one which had always to be translated into inanimate artifacts. My self-discipline ruled that it would be all right for me to talk after I had translated my philosophy and thoughts into actions and artifacts, but I must never talk about the thoughts until I have developed a physical invention<not a social reform.

That is the philosophy I evolved in 1927 when at thirty-two I began my own thinking. I have been operating since then on the 1927 premises, looking exploratorily for tasks that needed to be done, which would, when done, provide tool complexes that would begin to operate inanimately at higher advantage for the new life. I am the opposite of a reformer; I am what I call a new former. The new form must be

spontaneously complimentary to the innate faculties and capabilities of life. I am quite confident that humanity is born with its total intellectual capability already on inventory and that human beings do not add anything to any other human being in the way of faculties and capacities. What usually happens in the educational process is that the faculties are dulled, overloaded, stuffed and paralyzed, so that by the time that most people are mature they have lost use of many of their innate capabilities. My long-time hope is that we may soon begin to realize what we are doing and may alter the "education" process in such a way as only to help the new life to demonstrate some of its very powerful innate capabilities.

I went to the World Affairs Conference in Colorado last week. At the meeting were many important individuals—the ambassadors of Ghana, Nigeria, and so forth. Also participating were economists, sociologists, and scientists, and among them was a Yale scientist, Dr. Omar Moore. Dr. Omar Moore, you may recall, was reported on in Time magazine last year. At Yale University in the Child Study Clinic, he began to be suspicious that there were drives in human beings other than those of fear and longing which have been the assumed fundamental drives. He developed a hypothetical working assumption that there was a drive of the new life to demonstrate competence, and began working with his own child when she was two and one-half years old. He took an electric typewriter and colored the keys to correspond with the touch system. He then colored his child's fingernails to correspond with the keys each finger should operate. He had a hidden electric key, and when she didn't match the correct finger to the typewriter key the circuit was not closed. When she put the correctly colored finger on it the key worked, and quickly she learned to match her fingers to the proper keys. Every time she touched a key with the proper finger, not only did it print on the paper, but a big letter also came up in a window. By the time the child was three she was typing swiftly with the touch system the stories that were generated in her imagination. She seemed to find it just as easy to communicate this way as by talking. Dr. Moore's community and a number of his colleagues who happened to live in the same little town became fascinated, and began working experimentally with their children. There was a wave of excitement. These men say they used to like to get the children to bed early so they could have the evening to themselves, but now they hate to have the children go to bed early because everyone is so excited and stimulated by what this new life is demonstrating in capacity and capability. These are just some of the inklings corroborating what I am saying regarding very powerful faculties born in the human being which, if given the opportunity, may very readily regenerate to higher advantage for other men.

As a consequence of my kind of technically objective philosophy, I have had wide and copious experiences and firsthand practice in mechanics and structures. I am an engineer by tutorial work with one of our country's leading engineers of the 1920's; I am capable in the general world of physics and mildly capable in the world of chemistry; I am a mathematical explorer. I have been able to translate many of my philosophies into physical inventions in gap areas where there have been no previously recognized functions whatsoever—where people have not thought of the problems as being soluble by some device, but soluble only by social procedure reforms. As a consequence, I have developed quite a number of unprecedented devices and structures. At the present there are almost two thousand of my geodesic domes in forty countries around the world. All of those structures are of an unprecedented type. They were patentable in the countries around the world because they were unprecedented and were not included in structural engineering theory and therefore were true inventions. They enclose environments at about 1 per cent of the invested weight of resources of comparable volume enclosed by conventional structures with which you are familiar. They had to meet the hurricanes, the snow loads, and so forth. My structures are also earthquake proof; most of their comparable conventional counterparts are not. I have found it possible to do much more with less.

I have been able to demonstrate that there are important patterns to be employed by men and that there are inherently available ways of thinking which are simple and logical. My exploration into mathematics has disclosed extraordinary and comprehensive mathematical patternings of nature. I am quite confident that I have discovered the coordinate system employed by nature itself, in contradistinction to the

arbitrarily adopted X,Y,Z system which science employs and by virtue of which it translates its calculus through analytical geometry into informations which can be used technically.

[next >>](#)

Find:

[Humanity's Option](#) | [About the BFI](#) | [News](#) | [Community & Links](#) | [Glossary](#)  
[Who is Buckminster Fuller?](#) | [Home](#) | [Membership](#) | [Store](#) | [Sitemap](#) | [Contact Us](#)

[BACK](#)[INDEX](#)[HOME](#)

## Geodesic Domes and Charts of the Heavens

The world's first lightweight steel structural framework was built on the roof of the Carl Zeiss optical works in Jena, Germany in 1922. When covered with ferro cement the structure became the first thin-shell concrete structure in history. What is even more remarkable about the dome is that it was almost incidental to a spectacular scientific and technical accomplishment: invention of the planetarium projector. The inventor of the projector and the dome was Dr. Walter Bauersfeld, chief designed at the Zeiss works. A brief history of the astronomical devices that led to these inventions follows; it is a story of the foremost breakthrough in astronomers' attempts to "create the illusion of the mysterious, silent march of the worlds of nature."

Although the concept of the sky as a sphere may have occurred as early as 2,000 BC in China, it is recorded that in the 6th century BC. the Greek Anaximander taught that the stars and planets pass not only above, but beneath the earth. Greece's first scientific astronomer, Eudoxus of Cnidos (about 400 - 355 BC) constructed the first known complete celestial globe, which became the model for future globes. In 73 BC, in Italy, a white marble statue was discovered, depicting the god Atlas supporting a celestial sphere which is 26" in diameter. On the sphere are inscribed not only constellations, but circles representing the elliptic boundaries of the zodiac, and the major parallel circles.

Many globes and charts of the heavens appeared after (and before) the Farnese Globe; but the first real instruments of astronomy were the armillary spheres, which consisted of a framework of circular rings representing the various astronomical circles, and horizontal rings to indicate the horizon, equator, elliptic (path of the sun) and a vertical ring for the meridian. One such device, the Gottorp Armillary Sphere, built in 1653 by Andreas Busch was a marvel of craftsmanship and art, mechanized to show movement of the sun and with six silver angels representing the known planets. The part of the framework bearing the equator was made to rotate with respect to the zodiac at a rate corresponding to one revolution in 25,000 years, which is the rate of the precessional motion of the earth.

A remarkable device, also constructed by Busch in Germany in 1664, was the Gottorp Globe, a water-powered 3 1/2 ton, 10 foot diameter sphere that rotated once every 24 hours. Inside it was a platform for 12 persons and on its interior was a map of the sky with gilded stars. All other globes to that time had shown the sky from the unnatural position of the observer on the outside of the celestial sphere.

Early in the 18th century, a fine mechanical planetarium was built by John Rowley for Charles Boyle, fourth earl of Orrery. Called the "Orrery", similar instruments since have borne the same name. These devices incorporated the "new" concept of the solar system originally proposed by Copernicus, that the earth was round and revolved around the sun once a year.

In 1758 a large globe was built by Roger Long at Cambridge. It was 18 feet in diameter and accommodated 30 people. In 1913 Dr. Wallace Atwood, director of the Chicago Academy of Science designed and built a 15 foot diameter electrically driven globe that is

still in use today.

The difficulty faced by astronomers at this point in history was constructing a globe to accommodate a much larger audience. In 1913 the Carl Zeiss optical works of Germany understood the problem of designing a huge sphere that would both hold a large number of people and show the motions of the planets as well as the stars. After much work, no satisfactory solution was found. Then in 1919, just after the end of World War I, Dr. Walter Bauersfeld of Zeiss:

*...caught an entirely different idea: reversing the plan of a mechanically rotatable hollow sphere with illuminated images of the stars, he transferred the entire mechanism for the movements to a collection of projectors which would project luminous images of the stars on to a stationary white hemispherical dome of much larger dimensions than those originally conceived. Within the dome, the centre of which would be occupied by the projectors, all would be in darkness. By means of suitable mechanisms the projectors would be moved and guided so that their illuminated images of the heavenly bodies would conform on the dome to the motions which actually occur in nature...<sup>1</sup>*

For five years a large staff of scientists, engineers and mechanics worked with Bauersfeld at the huge Zeiss plant in Jena, Germany to design the projector and the projection dome.

*The projection of the starry sky required a certain number of projectors, arranged in the center of the dome. Each projector should illuminate an area of the same size as the dome. If the vertices of an icosahedron are cut in such a way that the new surface consists of 12 pentagons and 20 hexagons the area within each is nearly of the same size. The projectors are arranged in the centers of the pentagons and hexagons and produce 32 starfields on the same dome. (Actually only 31, since one area is used for the support.)...<sup>2</sup>*

To test the projector Bauersfeld needed a hemispheric dome as a replica of the sky. It had to be lightweight, as it was to be placed on the roof of the Zeiss factory in Jena. He built a light iron rod framework, the design a highly sub-divided icosahedron, with great circle arcs. Thus both the dome frame and the projection pattern were derived from the icosahedron.

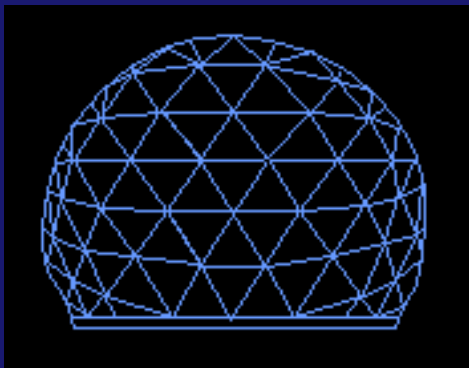

Not until the complex skeleton (3,480 struts accurate in length to 2/1,000 of an inch) was complete did Bauersfeld seek professional construction advice.

*We planned to cover it first with a fine network of thin wire in order to embed the whole construction in a layer of gypsum of about 1 1/2" thickness. But gypsum did not appear admirable because it could not be waterproofed and so we inquired of an engineer of Dyckerhoff and Widmann, who were engaged with factory buildings of ferro concrete for the Zeiss Works, if he could not suggest a waterproof cement of viscous consistency by a hose similar to that of fire-fighters. If in the interior of your framework we fix to it a wooden shield of suitable spherical curvature, against which we sprinkle cement in thin layers one after another we can avoid the concrete running off the inclined surfaces. Within a few days the cement will be stiff, we take away the shield and you get a fine smooth surface in the interior of the dome which is to be sprinkled by a white colour to represent an ideal surface for the projection. 3*

Basing their design on the thickness ratio of an egg shell to its diameter, Bauersfeld, and Mr. Franz Dischinger and Dr. Ulrich Finsterwalder of Dyckerhoff and Widmann then built the world's first lightweight thin shell concrete dome. Although the firm did not again use the icosahedral dome geometry, the invention was perfected in later structures and made possible clear spans of lighter weight than was previously possible.

In August 1923 the heavens were for the first time accurately reproduced in all their brilliance on the Jena rooftop dome. The stars and individual motions of the planets appeared on the dome's interior and the effect was so startling that even the men who designed the planetarium were astonished, as were early spectators. Newspapers referred to it as the "wonder of Jena".

As the planetarium began to be widely publicized, representatives from large cities in Germany asked Carl Zeiss to sell them planetaria of this kind. This caused the inventors to redesign the first projector which showed only the skies over Munich, to a model that could be used anywhere in the world. 25 of the latter were subsequently built and in May, 1930, the Adler Planetarium opened in Chicago - America's first projection planetarium.

The great circle" principle used in the Jena dome has been in use in the Orient for centuries to weave fish traps, hats and baskets. And the same principle is evident in a remarkable sculpture in China's Summer Palace of a lion holding what appears to be a five frequency geodesic sphere under its claw.

Buckminster Fuller advanced the popularization and commercialization of polyhedral buildings in the United States and is best known for his application of the word geodesic to this type of polyhedral framework.

"Geodesics have an infinite proliferation of possible branches, at the whim of subatomic indeterminism.",

Jack Williamson, *The Legion of Time*

---

<sup>1</sup> *From the Arratus Globe to the Zeiss Planetarium*, Helmet, Werner, Publ. Gustav Fischer, Stuttgart, 1957. (Available only from Carl Zeiss, N.Y.)

2. Letter to Shelter Publications from Dr. W. Degenhard, Carl Zeiss, June 19, 1973.

3. James Clayton Lecture: *Projection Planetarium and Shell Construction* at Institution of Mechanical Engineering, London, May 10, 1957 by Professor Walter Bauersfeld.

---

Reprinted With Permission from Shelter, © 1973, Shelter Publications, Inc., Bolinas, Calif.

### Other Resources



[Chris Fearnley's R. Buckminster Fuller FAQ](#)  
[Ken Snelson's Tensegrity Structures](#)

[TOP](#)

[BACK](#)

[INDEX](#)

[HOME](#)

# Chris Fearnley's List of Buckminster Fuller Resources on the Internet

## Sites with a General Perspective on The Work of R. Buckminster Fuller

1. [Buckminster Fuller Institute \(BFI\)](#)
2. [Bucky Fuller FAQ](#)
3. [Buckminster Fuller Virtual Institute](#)
4. [Buckminster Fuller; From Wikipedia, the free encyclopedia.](#)
5. [Buckminster Fuller Quotes; From Wikipedia, the free encyclopedia.](#)
6. [Fuller, Richard Buckminster](#)
7. [Fuller \(R. Buckminster\) Papers](#)

## Sites Relating to Synergetics

1. [Synergetics by R. Buckminster Fuller --- Full Text On-Line](#)
2. [A Fuller Explanation: The Synergetic Geometry of R. Buckminster Fuller by Amy Edmondson --- Full Text On-Line](#)
3. [The Synergeticists](#)
4. [Synergeticists of the NorthEast Corridor \(SNEC\)](#)
5. [Synergetics on the Web](#)
6. [Applied Synergetics Home Page](#)
7. [Richard Hawkins Synergetic Geometry](#)
8. [Robert W. Gray's Notes to R. Buckminster Fuller's Work](#)
9. [Russell Chu's Hope Page](#)
10. [George W. Hart --- Index](#)
11. [Trevor Blake's Synergetics Site](#)
12. [Steve Waterman's Closest Packing of Spheres Research"](#)
13. [Flexible Polyhedra](#)
14. [The Math Forum](#)
15. [Center for Tetrahedron Studies](#)
16. [An Introduction to the Energetic-Synergetic Geometry of R. Buckminster Fuller](#)

# Sites Relating to Fuller's Ideas About Human Society

1. [GENI: A Working Solution to the Worlds Problems ! Global Energy Network International](#)
2. [World Game Institute](#)
3. [Critical Path Project](#)
4. [Whole Systems](#)
5. [New Civilization Network](#)
6. [News for a Synergic Earth](#)
7. [Global Ecovillage Network](#)
8. [Sonic Bloom](#)
9. [Design Science University](#)

# Sites Relating to Geodesic Domes

1. [Geodesic Dome Housing Manufacturers - dome housing](#)
2. [EcoBusiness Links Directory of Geodesic Dome Homes](#)
3. [Geometrica Inc.](#)
4. [Professional Dome Plans](#)
5. [Pacific Dome](#)
6. [Timberline Geodesics](#)
7. [Walt's Dome Page](#)
8. [Geodesics Unlimited](#)
9. [The DomeHome Companion Web Site](#)
10. [BFI Dome Manufacturers Listings](#)
11. [American Ingenuity, Inc.](#)
12. [Astro-Tec Inc.](#)
13. [Dome Incorporated](#)
14. [Geodesic Domes and Homes](#)
15. [Domtec International](#)
16. [Fourth Dimension Housing](#)
17. [Applied Geodesics, Inc.](#)
18. [Albata Geodesics](#)

19. [Energy Structures, Inc.](#)
20. [Conservatek](#)
21. [Econ-O-Dome](#)
22. [Geo Tech Systems. Inc.](#)
23. [Good Karma Domes](#)
24. [Lydick's Domes Unlimited](#)
25. [SouthEast Domes](#)
26. [SouthEast Domes](#)
27. [Pacific Domes](#)
28. [The Horton Dome](#)
29. [Hexadome](#)
30. [Kwickset Konstruction Kits Dome Homes](#)
31. [Natural Spaces Domes](#)
32. [Natural Habitat Domes](#)
33. [Worldflower Garden Domes](#)
34. [Oregon Dome, Inc.](#)
35. [The Dome Company](#)
36. [Igla-Desic Structures](#)
37. [Littlewood Geodesic Domes](#)
38. [Archway Construction & Consulting](#)
39. [Project Bio/Home](#)
40. [Solardome Industries Ltd.](#)
41. [Domes Northwest](#)
42. [Temcor](#)
43. [Growing Spaces, Inc.](#)
44. [markt's \(geodesic\) Dome page](#)
45. [New Age Construction Co.](#)
46. [Shelter Systems](#)
47. [Starnet International Corp.](#)
48. [Common Wealth Solar Svs.](#)
49. [Starplate Building System](#)
50. [Dome Corporation Of North America](#)
51. [Institute for Lightweight Structures](#)

52. [Geodesic Structures by Steve Miller](#)
53. [Domeartifacts.com](#)
54. [J. W. Rich's and Geodesics NZ](#)
55. [Starship-Enterprises.Com](#)
56. [Vector-Edge Dodecahedron Geodesic Dome](#)
57. [Growing Spaces](#)
58. [SYNERGETICS, INC.](#)
59. [Geodome](#)
60. [Geodesic Domes and Charts of the Heavens](#)
61. [Autonomous Housing](#)
62. [Advanced Geodesic Domes](#)
63. [Vacono](#)
64. [RBF Dome NFP](#)
65. [Geodesic Clubhouse](#)

## Other Inventions of Bucky Fuller

1. [Dymaxion Car](#)
2. [Fuller's Dymaxion House](#)
3. [Mathematics and Tensegrity](#)
4. [A Technology for Designing Tensegrity Domes and Spheres](#)

## Sites Relating to Fullerene Science

1. [Fullerenes At Widener](#)
2. [Kim Allen's Fullerene Page](#)
3. [Stony Brook Buckyball Home Page](#)
4. [Geometry Of Fullerenes](#)
5. [Fullerene Science Module](#)
6. [Carbon Cages: LBL Scientists Study Fullerenes](#)

## Miscellaneous Sites

1. [Christopher J. Fearnley](#)
2. [R. W. Gray](#)

3. [Kirby Uner](#)
4. [Bob Burkhardt's Website](#)
5. [Mark Somers](#)
6. [Design Science Toys](#)
7. [A Fuller Vision: Working Assets Radio with Laura Flanders](#)
8. [Interview between John Cage and P3](#)
9. [Bucky Fuller at SIUC](#)
10. [Mark Burginger Main Page](#)
11. [Mark Burginger](#)
12. [Nystrom Home Page](#)
13. [SpaceshipEARTH](#)
14. [The Planet's Friendly Genius - Buckminster Fuller By Mary Bellis](#)
15. [Tetworld Center for Peace and Global Strategic Gaming](#)
16. [Pat Salsbury's "Reality Sculptors" Web Site](#)
17. [Michael Stutz](#)
18. [A site about connecting the arts and sciences](#)
19. [A \(Buckminster\) Fuller Universe](#)
20. [The Bucky Fuller Travelling Miracle Medicine Show](#)
21. [Blaine A. D'Amico's web site](#)
22. [Portrait of the Atom as a Force Diagram in Space](#)
23. [1946 Fortune Article](#)
24. [3D freeCAD](#)
25. [Compression and Tension are good; Torque's a Killer.](#)
26. [Nature's Structural Elements](#)
27. [Victor Acevedo](#)
28. [Polymorf, Inc.](#)
29. [Living Machines](#)
30. [Paul Fernhout: Themes: OHS / DKR vs. Design Science](#)
31. [Buckminster Fuller: Illusive Mutant Artist by Victoria Vesna](#)
32. [The Design-Science Revolution of R. Buckminster Fuller](#)
33. [The Design-Science Revolution of R. Buckminster Fuller Outlined And Expanded by Libby Hubbard](#)
34. [Elser's Screw](#)

35. [Waterman Polyhedra: Convex Hulls in the IVM](#)
36. [biagio di carlo's Site](#)
37. [Natural Synergies](#)
38. [OS 012](#)
39. [wrmDesign](#)
40. [Buckminster Fuller's Tetrascroll: Oklahoma City Museum of Art](#)
41. [R. Buckminster Fuller](#)
42. [Buckminster Fuller On PBS](#)
43. [WNET: Bucky Fuller Dymaxion House](#)
44. [WNET: Bucky Fuller Dymaxion Bathroom](#)
45. [R. Buckminster Fuller](#)
46. [R. Buckminster Fuller \(Bucky\)](#)
47. [R. Buckminster Fuller - The Isamu Noguchi Garden Museum](#)
48. [Buckminster Fuller Essential Links](#)
49. [Artist: F: BUCKMINSTER FULLER](#)
50. [Ask Jeeves: Fuller](#)
51. [Architecture--Wright and Fuller](#)
52. [Buckminster Fuller Links](#)
53. [TAFa: Toward a Fuller Awareness](#)
54. [Bonnie DeVarco Portfolio](#)
55. [Stafford Beer](#)
56. [Buckminster Fuller Postage Stamp](#)
57. [The Fuller Edutainment Company, Inc.](#)
58. [Ecological Engineering: THE BIO-REMEDIATION BARGE](#)
59. [Dymax Emergency Shelters](#)
60. [Alain LOBEL Architect](#)
61. [EARTHscope](#)
62. [Nick Consoletti](#)
63. [R. Buckminster Fuller - The Isamu Noguchi Garden Museum](#)
64. [Presidential Medal of Freedom Recipient R. Buckminster Fuller](#)
65. [Buckyball: a C60 molecule](#)
66. [The Buckyball: An Excruciatingly Researched Report](#)
67. [Ratech Industries - Radomes](#)

68. [What is a geodesic dome - Architecture Glossary](#)
  69. [3d model of the dymaxion car](#)
  70. [Serebella: Arts, Architecture, History, Architects, F, Fuller, Richard Buckminster](#)
  71. [Buckminster Fuller Paraphrased](#)
  72. [Synergetics](#)
  73. [From Platonic bodies to geodesic spheres, fullerenes, and virus](#)
  74. [The geodesic works of Richard Buckminster Fuller, 1948-68 : \(the universe as a home of man\) Yunn Chii Wong](#)
- 

## Author Information

Contact the author at [Chris@CJFearnley.com](mailto:Chris@CJFearnley.com). View the author's home page at <http://www.CJFearnley.com/>.



# DOME MANUFACTURERS, VENDORS AND CONSULTANTS

See below for information about how to get a listing.

Check out my [main page on geodesic domes](#) for more links. Some additional resources are listed at the [bottom](#) of this page.

| Manufacturer                                                                                                       | Contact Info                                                                                                                                         | Notes                                                                                                        | Verified       |
|--------------------------------------------------------------------------------------------------------------------|------------------------------------------------------------------------------------------------------------------------------------------------------|--------------------------------------------------------------------------------------------------------------|----------------|
| <a href="#">Albata Geodesics</a><br>900 C.R. 795<br>Montevallo, Al.<br>35115                                       | Al and Patricia Burson<br>Tel: (205) 665-7505<br><a href="mailto:domeblder@aol.com">domeblder@aol.com</a>                                            | custom built kits,<br>design work and<br>floor plans all kits<br>come color coded<br>and easy to<br>assemble | Spring<br>2000 |
| Aluminum Geodesic<br>Spheres (AGS)<br>4019 West Park<br>Road<br>Hollywood, FL<br>33021                             | Edwin O'Toole<br>Tel: 305-625-9436                                                                                                                   | none                                                                                                         | Summer<br>1994 |
| Aluminium<br>Rheinfelden GmbH -<br><a href="#">VACONO</a><br>Friedrichstr. 80<br>D-79618<br>Rheinfelden<br>Germany | Dr. M. Miermeister<br>Tel. : (+49)(0)7623 / 93511<br>Fax : (+49)(0)7623 / 93547<br>E-mail : <a href="mailto:vacono@vacono.com">vacono@vacono.com</a> | all aluminium<br>geodesic dome roof<br>VACONODOME®                                                           | Spring<br>1997 |
| American Ingenuity<br>8777 Holiday<br>Springs Road<br>Rockledge, FL<br>32955-5805                                  | Tel: 407-639-8777<br>Fax: 407-639-8778                                                                                                               | Planning Kit \$10;<br>Video \$8; EPS<br>Foam covered<br>w/concrete Shells                                    | May 1995       |
| <a href="#">Conservatek<br/>Industries, Inc.</a><br>498 Loop 336 East<br>Conroe, TX 77301                          | <a href="mailto:info@conservatek.com">info@conservatek.com</a><br>Tel: 409-539-1747<br>Fax: 409-539-5355<br>Toll free: 800-880-DOME                  | Manufactures of<br>aluminum domes<br>and aluminum<br>covers                                                  | April,<br>1997 |

|                                                                                                |                                                                                                                                                     |                                                                                                                                                                       |                       |
|------------------------------------------------------------------------------------------------|-----------------------------------------------------------------------------------------------------------------------------------------------------|-----------------------------------------------------------------------------------------------------------------------------------------------------------------------|-----------------------|
| <p><a href="#">CSC Domes</a><br/>Rt 1, Box 233<br/>St. Peter, MN 56082</p>                     | <p>Tel: 1-800-445-7547<br/><a href="#">LUCO Inc.</a></p>                                                                                            | <p>Low-cost, temporary, inflatable geodesic, plastic covered domes. Semi-permanent, steel pipe frame, aluminum or wood geodesic domes with covers. Easy assembly.</p> | <p>?</p>              |
| <p>Dome Incorporated<br/>2550 University Ave.<br/>W.,<br/>Suite 455<br/>St. Paul, MN 55114</p> | <p>Blair F. Wolfram<br/>Tel: 612-333-3663<br/>Email:<br/><a href="mailto:thedomeguy@domeincorporated.com">thedomeguy@domeincorporated.com</a></p>   | <p>Steel frame geodesic domes, glass triangle windows, 2' diameter to 74' diameter. Any frequency. Steel, wood or polymers. High performance housing.</p>             | <p>December, 2001</p> |
| <p>Domes America<br/>6345 West Jolie Road<br/>Countryside, IL 60525</p>                        | <p>Tel: 708-579-9400</p>                                                                                                                            | <p>none</p>                                                                                                                                                           | <p>?</p>              |
| <p><a href="#">Domes International, Inc.</a><br/>P.O. Box 137<br/>Golden, MS 38847</p>         | <p>Theresa &amp; Hugh Mayhew<br/>Voice: 1-888-454-7390<br/>Fax: 1-662-454-3098<br/><a href="mailto:domes@domesintl.com">domes@domesintl.com</a></p> | <p>Energy-efficient, low-maintenance, fiber-glass dome homes</p>                                                                                                      | <p>April, 2000</p>    |
| <p><a href="#">Domes Northwest</a><br/>319 N. Marguerite Road<br/>Spokane Valley, WA 99212</p> | <p>Theresa &amp; Hugh Mayhew<br/>Voice: (208) 691-9996<br/><a href="mailto:Hugh@domesnorthwest.com">Hugh@domesnorthwest.com</a></p>                 | <p>Wood dome kits for residential or commercial structures. Dome building school offered. Assistance in design through construction available.</p>                    | <p>June, 2004</p>     |

|                                                                                               |                                                                                                |                                                                                       |                   |
|-----------------------------------------------------------------------------------------------|------------------------------------------------------------------------------------------------|---------------------------------------------------------------------------------------|-------------------|
| <a href="#">Domespace</a>                                                                     | Voice: 212-906-0175<br>Fax: 212-906-0176<br><a href="mailto:vencat@aol.com">vencat@aol.com</a> | Plans, construction<br>(non-geodesic)                                                 | April,<br>1997    |
| DomEstic Designs<br>P.O. Box 4203<br>Bellevue, WA 98009                                       | none                                                                                           | none                                                                                  | ?                 |
| <a href="#">Energy Structures, Inc.</a><br>893 Wilson Avenue<br>St.Paul, MN 55106             | <a href="#">Kevin Frawley</a><br>Tel: 800-334-8144<br>Fax: 612-772-1207                        | Super-insulated<br>dome homes,<br>cabins, commercial<br>structures. Free<br>catalog.  | Fall 1998         |
| <a href="#">Geo Tech Systems</a><br>1725 Kingwood St.<br>#5<br>Florence, Oregon<br>97439      | Tel: 541-997-5786<br>Fax: 541-997-5786<br><a href="#">John Hackett</a>                         | tensioned fabric<br>domes, aluminum,<br>fiberglass, and<br>PVC frames, 12' to<br>100' | February,<br>2001 |
| <a href="#">Geodesic Domes, Inc.</a> (GDI)<br>10290 Davison Road<br>Davison, MI 48423         | Carlos McCarter<br>Tel: 313-653-2383                                                           | Brochure \$8; Wood<br>kits                                                            | Oct 1990          |
| <a href="#">Geodesic Domes &amp; Homes</a><br>P.O. Box 575<br>Whitehouse, Texas<br>57591      | Larry and Srandra Knackstedt<br><a href="mailto:sales@domehomes.com">sales@domehomes.com</a>   | Info packet \$10                                                                      | November,<br>1997 |
| GeoDomes<br>Woodworks<br>6876 Indiana<br>Avenue, Suite L<br>Riverside, CA 92514               | Bob Davies & Glenn Van Doren<br>Tel: 909-787-8800<br>Fax: 909-787-7089                         | Home Planning<br>Guide \$15; Wood<br>kits starting at<br>\$10,000                     | Summer<br>1994    |
| <a href="#">Geometrica, Inc.</a><br>908 Town & Country<br>Blvd. Ste. 330<br>Houston, TX 77024 | <a href="#">Mr. Luis Enrico</a><br>Tel: (713)722-7555<br>Fax: (713)722-0331                    | large commercial<br>and industrial<br>geodesic domes<br>and Freedomes®                | August,<br>1997   |

|                                                                                                       |                                                                                                                           |                                                                                                                                                            |                       |
|-------------------------------------------------------------------------------------------------------|---------------------------------------------------------------------------------------------------------------------------|------------------------------------------------------------------------------------------------------------------------------------------------------------|-----------------------|
| <p><a href="#">Good Karma Domes</a><br/>3531 S.W. 42nd Street<br/>Oklahoma City, OK 73119</p>         | <p><a href="#">James Lynch</a><br/>Tel: (405) 685-4822</p>                                                                | <p>Plans and kits (hubless bolt-together design), heat-efficient insulated domes.</p>                                                                      | <p>June, 1999</p>     |
| <p><a href="#">Hexadome</a><br/>P.O. Box 2351<br/>La Mesa, CA 91943</p>                               | <p>Eugene E. Hopster<br/>619-440-0434</p>                                                                                 | <p>Free Video; Wood kits</p>                                                                                                                               | <p>April, 1997</p>    |
| <p><a href="#">Inflatable Domes LLC</a><br/>9864 E.Grand River, Brighton, Michigan, 48114, U.S.A.</p> | <p>Voice: [1]-888-410-1686<br/>Backup: [1]-888-862-6528<br/><a href="#">Jesse Johnson</a></p>                             | <p>Light weight inflatable dome made of portable panels, connected with velcro-type material to cover sports fields and construction sites</p>             | <p>February, 2001</p> |
| <p><a href="#">Island Domes</a><br/>Libra Farms</p>                                                   | <p><a href="mailto:Pokchoy@aol.com">Pokchoy@aol.com</a><br/>610-489-6256</p>                                              | <p>Metal tube frame, PVC laminate skin, hydroponics</p>                                                                                                    | <p>July, 1999</p>     |
| <p><a href="#">Keystone Domes</a><br/>313 Patterson Lane<br/>Belle Vernon, PA 15012</p>               | <p>(412) 579-6127<br/>Fax (724) 929-3696<br/><a href="mailto:keyinfo@keystonedomes.com">keyinfo@keystonedomes.com</a></p> | <p>designs/builds large dome-shaped structures for storage of bulk materials, also culverts and tunnels. Short construction times, lower overall cost.</p> | <p>November, 1999</p> |
| <p><a href="#">KingDomes</a><br/>P.O. Box 980427<br/>Houston, TX 77098</p>                            | <p><a href="#">Einar Thorsteinn</a></p>                                                                                   | <p>EDC Booklet \$20 (European design, 163 solutions, kits, math)</p>                                                                                       | <p>Winter 1995</p>    |
| <p><a href="#">Kwickset Konstruction Kits</a><br/>Australia</p>                                       | <p><a href="#">Klaus Zimmer</a></p>                                                                                       | <p>Dome home plans, build-it-yourself kits</p>                                                                                                             | <p>Spring 1999</p>    |

|                                                                                                                     |                                                                                                                               |                                                                                                                                                                                                              |                    |
|---------------------------------------------------------------------------------------------------------------------|-------------------------------------------------------------------------------------------------------------------------------|--------------------------------------------------------------------------------------------------------------------------------------------------------------------------------------------------------------|--------------------|
| <p><a href="#">Littlewood Geodesic Domes</a><br/>7208 80 Ave<br/>Edmonton, Alberta<br/>Canada T6B 0C6</p>           | <p>Tel: (403) 463-3004 or 970-3802<br/><a href="mailto:geodome@freenet.edmonton.ab.ca">geodome@freenet.edmonton.ab.ca</a></p> | <p>Wood frame, low cost relocatable shelters, frame kit with durable covering</p>                                                                                                                            | <p>Dec 1997</p>    |
| <p><a href="#">Lobel Frame</a><br/>31 rue Varenque<br/>92340 Bourg La Reine<br/>France</p>                          | <p>Tel: +33(0)146645325<br/>Fax: +33(0)146641591<br/><a href="#">Alain Lobel</a></p>                                          | <p>Architect: Space Structures<br/>Forms and structures generated by identical elements</p>                                                                                                                  | <p>Nov 2000</p>    |
| <p><a href="#">Lydick's Domes Unlimited</a><br/>173 Harvey Rd.<br/>Sarver PA 16055</p>                              | <p>Tel: 412 353 0098<br/>Fax: 412 353 0098<br/><a href="mailto:domeking@nauticom.net">domeking@nauticom.net</a></p>           | <p>Supplying wood frame, panelized domes up to 134' in dia. Free supervision on installation of up to 60' domes. Color catalogs, videos, construction manuals, and in house drafting and design services</p> | <p>Jan 1996</p>    |
| <p><a href="#">Guy Massicotte</a></p>                                                                               | <p><a href="mailto:geodome@sympatico.ca">geodome@sympatico.ca</a></p>                                                         | <p>geodesic dome designs</p>                                                                                                                                                                                 | <p>Feb 1997</p>    |
| <p><a href="#">Monolithic Constructors, Inc.</a><br/>P.O. Box 479-W<br/>One Dome Park Place<br/>Italy, TX 76651</p> | <p>Voice: 972 483-7423<br/>Fax: 972 483-6662<br/><a href="mailto:mail@monolithicdome.com">mail@monolithicdome.com</a></p>     | <p>\$19.95 Video; Free brochure; Concrete Domes</p>                                                                                                                                                          | <p>April, 1997</p> |
| <p>Nation's Hoop Carpenters<br/>P.O. Box 45<br/>Boyertown, PA 19512</p>                                             | <p>Steven J. Kennedy</p>                                                                                                      | <p>Metal, wood &amp; cement domes</p>                                                                                                                                                                        | <p>Summer 1994</p> |

|                                                                                                          |                                                                                                                                                                                            |                                                                                                                                                                                    |                       |
|----------------------------------------------------------------------------------------------------------|--------------------------------------------------------------------------------------------------------------------------------------------------------------------------------------------|------------------------------------------------------------------------------------------------------------------------------------------------------------------------------------|-----------------------|
| <p><a href="#">Natural Space Domes</a><br/>37955 Bridge Road<br/>North Branch, MN<br/>55056</p>          | <p>Dennis &amp; Janet Johnson<br/>Tel: 612-674-4292<br/>Toll free: 800-733-7107<br/>Fax: 612-674-5005<br/><a href="mailto:info@naturalspacesdomes.com">info@naturalspacesdomes.com</a></p> | <p>Super-insulated wood frame domes; Catalog &amp; price list - special \$3; 49 min &amp;quot;Tour of Domes" video - \$20; 94 page plan book - \$11; dome constuction schools.</p> | <p>April, 1997</p>    |
| <p>North Face, The<br/>999 Harrison Court<br/>Berkeley, CA 94710</p>                                     | <p>Hal Klopp &amp; Bruce Hamilton<br/>Tel: 415-527-9700</p>                                                                                                                                | <p>Geodesic Tents</p>                                                                                                                                                              | <p>?</p>              |
| <p><a href="#">Observa-DOME Laboratories, Inc.</a><br/>371 Commerce Park Drive<br/>Jackson, MS 39213</p> | <p>Tel: 601-982-3333<br/><a href="mailto:odl@misnet.com">odl@misnet.com</a></p>                                                                                                            | <p>Observatory domes, missile silo covers. Note: these are not geodesic designs</p>                                                                                                | <p>April, 1997</p>    |
| <p><a href="#">Oregon Dome, Inc.</a><br/>3215 Meadow Lane<br/>Eugene, OR 97402</p>                       | <p>Linda Boothe or Nathan Burke<br/>(800) 572-8943<br/>Fax: 541) 689-9275<br/><a href="mailto:oregon@domes.com">oregon@domes.com</a></p>                                                   | <p>free info, guide to construction management for \$42.95</p>                                                                                                                     | <p>April, 1997</p>    |
| <p><a href="#">Pacific Domes</a><br/>247 Granite St.<br/>Ashland, OR 97520</p>                           | <p>Tel: 888-488-8127<br/><a href="mailto:info@pacificdomes.com">info@pacificdomes.com</a></p>                                                                                              | <p>Geo domes made from canvas and galvanized steel tubing, 12-44 feet in diameter, catalog</p>                                                                                     | <p>November, 1999</p> |
| <p>Pond-Brook Products<br/>P.O. Box 301<br/>Franklin Lakes, NJ<br/>07412</p>                             | <p>Gladys Payne</p>                                                                                                                                                                        | <p>Hexa-Pent Dome Plans \$20</p>                                                                                                                                                   | <p>?</p>              |
| <p><a href="#">Precision Structures LLC</a><br/>2565 Potter Street<br/>Eugene, OR 97405</p>              | <p><a href="mailto:info@domeplans.com">info@domeplans.com</a></p>                                                                                                                          | <p>Professional Dome Plans: Simple, detailed shop drawings and formulas for building 3v icosadomes.</p>                                                                            | <p>Summer 2002</p>    |

|                                                                                            |                                                                                                                          |                                                                                                                                                                                                    |                  |
|--------------------------------------------------------------------------------------------|--------------------------------------------------------------------------------------------------------------------------|----------------------------------------------------------------------------------------------------------------------------------------------------------------------------------------------------|------------------|
| Semispheres<br>1505 Webster Street<br>Richmond, VA<br>23220                                | Tel: 804-643-3184                                                                                                        | none                                                                                                                                                                                               | ?                |
| <a href="#">Shelter Systems</a><br>224 West O'Connor<br>Menlo Park, CA<br>94025            | Bob Gillis<br>Tel: Voice: 415-323-6202<br>Fax: 415-323-1220<br><a href="mailto:shelter@best.com">shelter@best.com</a>    | Send \$1 for info;<br>Large dome tents,<br>greenhouses, etc.                                                                                                                                       | Janurary<br>1996 |
| <a href="#">Spitz Inc.</a><br>P.O. Box 198, Route<br>1<br>Chadds Ford, PA<br>19317         | Tel: (610) 459-5200<br>Fax: (610) 459-3830<br><a href="mailto:spitz@libertynet.org">spitz@libertynet.org</a>             | manufacturer of<br>domed screens for<br>planetariums and<br>omni theaters                                                                                                                          | April,<br>1997   |
| <a href="#">Starnet International</a><br>200 Hope Street<br>Longwood, Florida<br>32750 USA | (407) 830-1199<br>Fax: (407) 830-1817<br><a href="mailto:starnetint@aol.com">starnetint@aol.com</a>                      | designers,<br>engineers,<br>fabricators &<br>assemblers of<br>spaceframes,<br>arches & dome<br>enclosures with<br>integrated metal<br>decking,<br>membrane, glass &<br>acrylic cladding<br>options | August<br>1996   |
| Stromberg's Chicks<br>& Gamebirds<br>P.O. Box 400<br>Pine River, 4, MN<br>56474            | Tel: 218-587-2222                                                                                                        | \$39.95 for Starplate<br>struts to build a<br>dome<br>shed/greenhouse up<br>to 14' diam                                                                                                            | ?                |
| Storex Systems Inc.<br>6772 Martin Street<br>PO Box 41<br>Pine River<br>Rome, NY 13440     | Tel: 315-339-5151<br><a href="mailto:storex@newport.ntcnet.com">storex@newport.ntcnet.com</a>                            | Wood frame domes<br>from 30' in<br>diameter to 150' in<br>diameter                                                                                                                                 | April,<br>1996   |
| <a href="#">Synergetics, Inc.</a><br>122 Cox Ave.<br>Raleigh, NC 97206                     | Tel: 919-832-4011<br>Fax: 919-832-4011<br><a href="mailto:Synergetics@worldnet.att.net">Synergetics@worldnet.att.net</a> | in business since<br>1954, many large<br>projects to its name                                                                                                                                      | July, 1999       |

|                                                                                                                   |                                                                                                                                      |                                                                                                                               |                           |
|-------------------------------------------------------------------------------------------------------------------|--------------------------------------------------------------------------------------------------------------------------------------|-------------------------------------------------------------------------------------------------------------------------------|---------------------------|
| <p><a href="#">TEMCOR</a><br/>PO Box 6256<br/>24724 South<br/>Wilmington Ave<br/>Carson, CA 90749</p>             | <p>Clark Margolf<br/>Tel: (310) 549-4311<br/>or: (800) 421-2263<br/>Fax: (310) 549-4588</p>                                          | <p>Large aluminum<br/>commercial domes</p>                                                                                    | <p>February,<br/>2001</p> |
| <p><a href="#">The Dome Company</a><br/>47 Edward St.<br/>Sylvania Heights<br/>Sydney, NSW 2224<br/>Australia</p> | <p>Rob Lusher<br/>Tel/Fax: (02) 95226283<br/><a href="mailto:domeco@wr.com.au">domeco@wr.com.au</a></p>                              | <p>smaller type<br/>domes, particularly<br/>kit-set frames for<br/>shadehouses etc.</p>                                       | <p>May, 1998</p>          |
| <p><a href="#">Timberline<br/>Geodesics</a><br/>2015 Blake Street<br/>Berkeley, CA 94704</p>                      | <p>Robert M. Singer<br/>Tel: 800-DOME-HOME<br/>Fax: 510-849-3265<br/><a href="mailto:info@domehome.com">info@domehome.com</a></p>    | <p>Catalog \$12; Video<br/>\$15; Wood kits</p>                                                                                | <p>Spring<br/>1996</p>    |
| <p>Tobel Domes<br/>P.O. Box 310<br/>Lakeside, CA 92040</p>                                                        | <p>Tom Boyle<br/>Tel: 619-443-6503<br/>Fax: 619-443-1108</p>                                                                         | <p>Geodesic Dome<br/>kits to 130' Dia<br/>construction,<br/>roofing services<br/>Plan/photo catalog<br/>\$14</p>              | <p>Winter,<br/>1995</p>   |
| <p><a href="#">Topsider Homes</a><br/>P.O. BOX 1490<br/>Clemmons NC<br/>27012</p>                                 | <p>Tel: 910-766-9300</p>                                                                                                             | <p>Round homes, not<br/>domes</p>                                                                                             | <p>?</p>                  |
| <p><a href="#">Ultraflote<br/>Corporation</a><br/>8558 Katy Frwy<br/>Suite 100<br/>Houston, Texas<br/>77024</p>   | <p>Tel: 713-461-2100<br/>Fax: 713-461-2100<br/><a href="mailto:dome@ultraflote.com">dome@ultraflote.com</a></p>                      | <p>floating tank covers<br/>and aluminum<br/>geodesic<br/>Ultradome, for the<br/>petroleum industry<br/>and other sectors</p> | <p>May, 1998</p>          |
| <p><a href="#">Western Wood<br/>Structures, Inc.</a><br/>PO Box 130<br/>Tualatin, Oregon,<br/>97062</p>           | <p>Tel: 503 692-6900<br/>or 800 547-5411(USA)<br/>Fax: 503 692-6434<br/><a href="mailto:wysi@teleport.com">wysi@teleport.com</a></p> | <p>Timber domes,<br/>some of the largest<br/>in the world</p>                                                                 | <p>November,<br/>1996</p> |



|                                                                                         |                                                                       |                                          |               |
|-----------------------------------------------------------------------------------------|-----------------------------------------------------------------------|------------------------------------------|---------------|
| <a href="#">WorldFlower Garden Domes</a><br>P.O. Box 3123<br>Fort Worth, Texas<br>76113 | Tel: 888-945-3311<br>Fax: 817 921-6795<br><a href="#">Ernie Aiken</a> | Dome kits for gardens, related functions | October, 1997 |
|-----------------------------------------------------------------------------------------|-----------------------------------------------------------------------|------------------------------------------|---------------|

## For further information see:

| Publication                                                                                                                                                                                                                                                            | Contact Info                             | Notes                                                     | Verified    |
|------------------------------------------------------------------------------------------------------------------------------------------------------------------------------------------------------------------------------------------------------------------------|------------------------------------------|-----------------------------------------------------------|-------------|
| Thomas Register of American Manufacturers<br>One Penn Plaza<br>New York, NY 10001                                                                                                                                                                                      | Tel:<br>212-695-0500                     | See Volumes 1-10: Products & Services (in most libraries) | 1994        |
| National Association of Dome Manufacturers<br>2506 Gross Point Road<br>Evanston, IL 60201                                                                                                                                                                              | none                                     | none                                                      | Summer 1994 |
| National Dome Council<br>15th & "M" Streets, NW<br>Washington, DC 20005                                                                                                                                                                                                | Tel:<br>202-822-0576                     | none                                                      | ?           |
| <a href="#">DOME</a> (magazine)<br>4401 Zepher Street<br>Wheat Ridge, CO 80033                                                                                                                                                                                         | Donald R. Hoflin<br>Tel:<br>303-934-5656 | Quarterly;<br>\$40/yr                                     | Summer 1994 |
| Email list devoted to geodesic dome homes: <i>DomeHome-H</i> . The list is owned by Hoflin Publishing, publishers of DOME magazine. To subscribe, send an email with the SUBJECT subscribe to <a href="mailto:DomeHome-H@h19.hoflin.com">DomeHome-H@h19.hoflin.com</a> |                                          |                                                           |             |

This list was initially based on a list provided by [Joe Moore](#), the independent Bucky Fuller scholar. These days, I like to hear directly from officially authorized company representatives (e.g. owners, marketing) to request a listing, change of info, or deletion. I don't have time to scour the web, publications, and so on, nor do I necessarily list companies that people post about, but don't work for directly (the companies in question might not want a listing at my site, for whatever reason, or might want one with different information than what some third party provides).

Having a listing on this page does not constitute an endorsement by 4D Solutions (I have no intention of evaluating or rating all of these products and services). I may have had business

relationships with some of these firms (e.g. been a customer, consultant, financeer or co-designer) or perhaps will in the future -- but that's irrelevant insofar as just getting a listing is concerned. I don't need to know you or have had any dealings with your company to give you a listing. Just send me ([Kirby](#)) some [email](#).

I am not experienced in home building myself (a little touching-up with caulk and spackle is about my speed) and currently live in a 1905 box home, not a dome. You can ask me questions about domes, but likely I'll just refer you back to this page, which will connect you to people a lot more knowledgable and experienced than I in the domes department.

For an even more complete listing of dome suppliers, check [Michael Rader's listing](#) and useful [web site on domes](#).

---

Synergetics on the Web  
maintained by [Kirby Urner](#)

## BUCKMINSTER FULLER INSTITUTE

|                  |                      |                        |                        |                    |                   |       |             |
|------------------|----------------------|------------------------|------------------------|--------------------|-------------------|-------|-------------|
| home             | membership           |                        | donations              | store              | sitemap           |       |             |
| ABOUT<br>the bfi | HUMANITY'S<br>option | WHO IS<br>r.b. fuller? | BOOKS AND<br>resources | COMMUNITY<br>links | DESIGN<br>science | DOMES | SYNERGETICS |

Dome Resources

[Dome Manufacturers](#)

[Dome Architectural/Design](#)

[Additional Information and Links](#)

### DOMES MANUFACTURERS

#### **Aluminum Geodesic Spheres**

Specializes in aluminum geodesic domes and spheres and geodesic modeling kits. Has a 6' playdome.

**Building types:** Specialized

**Market area:** worldwide

2111 Southwest 31st Avenue

Pembroke Park, FL 33009

Edwin O'Toole (954) 963 2341

#### **American Geodesics, Inc.**

Exclusive manufacturer of the Semispheres® super-insulated building system, consisting of prefabricated expanded polystyrene (EPS) foam panels which are covered after assembly with a site-applied, fiberglass reinforced cement plaster.

**Building types:** Single family

**Market area:** U.S.

1505 Webster St.

Richmond VA 23220-2319

Ben Rose (804) 643-3184

#### **American Ingenuity, Inc.**

Manufactures dome building kits which use a system of pre-finished component panels. They use fiber reinforced concrete and rigid foam and offer consulting services. They offer a warranty in case hurricanes and earthquakes and a six month assembly time

**Building types:** 22'-60' size, single family, commercial

**Market area:** U.S., Canada

**Website:** <http://www.aidomes.com>

#### **DOMES INC.**

Blair F. Wolfram

2550 University Ave. W.,

Suite 455

St. Paul, MN 55114

Phone 612-333-3663 fax 651-647-1200

e-mail [thedomeguy@domeincorporated.com](mailto:thedomeguy@domeincorporated.com)

<http://www.domeincorporated.com>

#### **Domes America, Inc.**

Wood domes, crews provided. One-day construction, high standards and custom designs. Caters to

do-it-yourselfers.

**Building types:** Steel geodesic dome frames, glass triangle windows, from 2' diameter to 74' diameter any frequency. Steel, wood or polymers. High performance housing.

**Market area:** Not limited by space

Building codes: Meets U.S. codes

126 S. Villa Ave.

Villa Park, IL 60181

Bob Casey (630) 993 1801

**Fax:** (630) 993 1809

### Dome Technology

Specializes in construction of monolithic domes

**Building type:** monolithic dome (super-insulated steel-reinforced concrete dome)

**Market Area:** worldwide

Barry or Randy South (208) 529-0833

### **DOMES USA**

**Building types:** Single family residential & commercial modular fiberglass dome building system. Systems can be tailored to individual applications and systems can be built world wide to a turnkey unit.

**Market Area:** U.S. & worldwide

Manufactured and distributed by: DOMES USA

87272 507th ave

Page, NE 68766

866-366-3769

**Website:** <http://www.domedr.com>

**Email:** [domedr@nrtv.org](mailto:domedr@nrtv.org)

### **Econ-O-Dome**

**Building types:** Single family & Commercial

**Market Area:** U.S. & worldwide

**Manufactured and distributed by:** Faze Change Produx

RR 1, Box 295B

Sullivan, IL 61951

1-888-DOME-LUV (1-888-366-3588)

**Website:** <http://www.one-eleven.net/econodome>

**Email:** [fazechange@one-eleven.net](mailto:fazechange@one-eleven.net)

### **Geodesic Domes and Homes Co.**

Yellow pine and plywood domes.

Only 6-10 hrs. assembly time.

**Building types:** single-family, multifamily, commercial, churches

**Market area:** Worldwide

P. O. Box 575

Whitehouse TX 75791

Larry Knackstedt (903) 839-2000 or

(800) 825 2389

**Fax:** (903) 839 7228

**Email:** [sales@domehomes.com](mailto:sales@domehomes.com)

**Website:** <http://www.domehomes.com>

### **Geodesics Unlimited**

Specializes in design of geodesic structures of all shapes and sizes. Manufactures tents, stage covers, shelters of various kinds, theatre and workshop structures. Aluminium, wood, plastic, canvas, pvc. Now working on greenhousing. Plans lampshades, residential housing, stadia, and spaceships.

**Market area:** worldwide. **Specialism:** custom design.

The Hayloft, Atlow Moat, Winn Lane, Atlow, Ashbourne, DE6 1NS, UK.

John Moon: 01335 370661 (UK)

**Fax:** 01335 372813 (UK)

**Email:** [john\\_moon@geodesics-unlimited.com](mailto:john_moon@geodesics-unlimited.com)

**Website:** [www.geodesics-unlimited.com](http://www.geodesics-unlimited.com)

### **Growing Spaces, Inc.**

Manufactures, sells and installs the "growing dome" geodesic greenhouse kit.

**Building types:** Wood struts, aluminum hubs, polycarbonate glazing

**Market area:** North America

P.O. Box 5518

Pagosa Springs, CO 81147

Udgar Parsons, (800) 753-9333

### **Monolithic Dome Institute**

Specializes in airforms, design & construction of monolithic domes, promoting and educating via articles, conferences and web site

**Building type:** monolithic dome (super-insulated steel-reinforced concrete dome)

**Market area:** worldwide

177 Dome Park Place

Italy, TX 76651

David South (972) 483-7423

### **Natural Spaces Inc.**

Wood dome design, manufacture and construction. Will provide crews or you can do-it-yourself. Offer 5 and 10 yr. guarantees. Has dome school.

**Building types:** Single-family, multifamily, commercial, and institutional.

**Market area:** Worldwide

37955 Bridge Road

North Branch MN 55056

Dennis Johnson (651) 674-4292

or (800) 733-7107

**Fax:** (651) 674-5005

**Website:** <http://www.naturalspacesdomes.com>

**Email:** [djohnson@naturalspacesdomes.com](mailto:djohnson@naturalspacesdomes.com)

### **New Age Construction Co.**

Geodesic dome construction and consulting with 30 years experience

**Building types:** erect all reputable dome manufacturer's kits; custom build to more rigid specs when standard kits don't spec out; build any and all types of geodesic domes including Lexan and repair / re-roof existing domes

**Market area:** Worldwide

13288 Domes Ridge

Duncanville Alabama 35456

John E. Johnson (205) 758 1996

[Newageco@dbtech.net](mailto:Newageco@dbtech.net)

[www.newagedomeconstruction.com](http://www.newagedomeconstruction.com)

### **Oregon Dome Inc.**

Douglas Fir and OSB sheathing for panel dome kit.

DF and OSB panel dome kits, large and small. Many designs. One day to two days assembly at site.

**Building types:** Single-family, multifamily, commercial. worship spaces

**Market area:** Worldwide

Building codes: Meets UBC, BOCA, SBCCI International.

25331 Jeans Road

Vaneta, OR 97487

Linda Boothe (541) 935-5444

(800) 572 8943

**Fax:** (541) 935-5812

**Website:** [www.domes.com](http://www.domes.com)

**Email:** [oregon@domes.com](mailto:oregon@domes.com)

### **Pacific Domes**

**Building types:** all climate family shelter, guest house, workshop, art/yoga/dance studio

247 Granite Street

Ashland, OR 97520

(541) 488 8127

(888) 488 8127

**Website:** [www.PacificDomes.com](http://www.PacificDomes.com)

### **Shelter Systems**

Geodesic yurts, domes, tents and greenhouses.

**Building types:** 6'-30' temporary and semi-permanent portable shelters. Emergency relief shelters. Average set-up time 30 minutes.

**Market area:** Worldwide

224 W. O'Connor St.

Menlo Park, CA 94025

Bob Gillis (650) 323 6202

Fax (650) 323 1220

**Website:** <http://www.shelter-systems.com>

### **Timberline Geodesics Inc.**

Complete line of easy to assemble wooden domes and floorplans with a one year guarantee. Less than a week assembly time.

**Building types:** Single family, commercial

**Market area:** Worldwide

2015 Blake Street

Berkeley CA 94704

Robert Singer (510) 849-4481

or (800) DOMEHOME

**Website:** <http://www.domehome.com>

### **Temcor**

Sales of clearspan large aluminum domes and related structures.

**Building types:** Commercial, industrial

**Market area:** Worldwide

24724 S. Wilmington Ave  
Carson CA 90745  
Bob Dagenais (310) 549-4311  
**Email:** [temcor@compuserve.com](mailto:temcor@compuserve.com)

#### ARCHITECTURAL/DESIGN

##### **Fuller, Sadao & Zung**

Architectural and design firm specializing in geodesics.  
P. O. Box 6238  
Cleveland OH 44101  
Thomas Zung  
(216) 752 3500  
**Email:** [fuller.zadao.zung@worldnet.att.net](mailto:fuller.zadao.zung@worldnet.att.net)

#### ADDITIONAL INFORMATION/HOTLINES

##### [American Ingenuity Dome Homes](#)

Antennas for Communication  
Radomes, dishes etc., including geodesic constructions

##### [Building A Dome Home](#)

Book and/or CD-ROM compiled by a couple in Oregon who built a dome which includes all the stages, pitfalls, tips and tricks, and a 3-D animated construction of a dome.

##### [Yoshiaki Araki](#)

[Dome Project](#) web pages, links to M.C. Escher.

##### [DOME readme-J](#)

Japanese version of the user's manual for DOME 4.6, the freeware created by Rick Bono. Operating the freeware does not require English comprehension. This manual could help Japanese people take advantage of the freeware and help them learn and design their own geodesic dome.

##### [Dome Village](#)

Justiceville/Homeless USA, a 501(c)3 non-profit organization

##### [Dome Magazine](#)

Hoflin Publishing Ltd.  
4401 Zephyr Street  
Wheat Ridge, CO 80033-3299  
(303) 420-2222

##### [The Dome Lady](#)

Specializing in financing and refinancing geodesic domes worldwide.

##### [Earth360.com](#)

Web site put together by Bill Lauritzen, some of which is devoted to Geodesic Domes as well as other comprehensive issues.

##### [Geodesic Domes Page by Chris Fearnley](#)

##### [Geodesic Domes Pages by Kirby Urner](#)

##### [Geodesic Domes Pages by Rick Bono](#)

also features Geodesic Dome Design software

### [GreenClips](#)

GreenClips is a summary of news on sustainable building design and related government and business issues published every two weeks.

This site is devoted to Geodesic Domes as well as other comprehensive issues put together by Bill Lauritzen:  
<http://www.EARTH360.com>

### **Hexadomes**

Pre-fab panelized design which can be completed at ground level and assembled quickly and safely. Licenses the design to builders, architects, and supplies blueprints through division called DOMEPLANS. Offer do-it-yourself kits. Have book called How to Design and Build Your Dome Home by Gene Hopster to warn of unsafe variations on the dome design.

Box 2351

La Mesa CA 92020

(619) 401-7572

**Email:** [hexadome@adnc.com](mailto:hexadome@adnc.com)

**Website:** <http://www.jinet.com/hexadome>

### [Jay Salsburg's Home Page](#)

Many unique, original, and interesting items including reference documentation, images, and science on Geodesics and Buckminster Fuller may be found here. A small part of my research into the Fly's Eye Dome and BuckminsterFullerine Dome is shown in images and virtual reality.

### [Kathleen Schrock](#)

Web slides showing construction of Cape Cod geodesic dome home

### [Michael Rader's Geodesic Domes - Structures and Homes](#)

Comprehensive site on geodesic domes with a focus on manufacturers/builders of geodesic dome homes and small yard structures (rather than companies whose primary business is commercial/industrial domes). Includes dome manufacturers, chord factors, book resource and more.

### **National Dome Council**

National organization with membership comprised of manufacturers of geodesic dome buildings.

15th & M Streets, N.W.

Washington D.C. 20005

(202) 822-0576

**Website:** <http://www.buildingsystems.org>

### [Oregon Domes](#)

Maintains a list of domes for sale

### [P.A.T.H](#)

The Partnership for Advancing Technology in Housing

### [Professional Dome Plans](#)

A book of detailed shop drawings and formulas for building wood framed, 3 frequency, panel domes.

Website: <http://www.domeplans.com>

### [Timberline Domes](#)

### [Walt Venable](#)



[Walt's Dome Page](#) (lots of links)

Find:

[Humanity's Option](#) | [About the BFI](#) | [News](#) | [Community & Links](#) | [Glossary](#)  
[Who is Buckminster Fuller?](#) | [Home](#) | [Membership](#) | [Store](#) | [Sitemap](#) | [Contact Us](#)



Finding People, Places,  
and Businesses

[HOME](#)   [YELLOW PAGES](#)   [WHITE PAGES](#)   [REVERSE LOOKUP](#)   [HELP](#)

- › [International](#)
- › [Maps](#)
- › [Area Codes](#)
- › [Toll-Free](#)

› [Credit Center](#)

[LowerMyBills](#)  
[Refinance Now with](#)  
[Low Mortgage Rates](#)

[Quicken Loans](#)  
[Get a \\$300K](#)  
[Mortgage for](#)  
[\\$1,050/Month!](#)

[Coolsavings](#)  
[Free Samples &](#)  
[Coupons For all your](#)  
[needs](#)

### FIND A BUSINESS



Business Name *or* Category *Required*

City

State

Zip

Name

Category

### FIND A PERSON



Last Name *Required*

First Name

TIP: Try just the 1st 4 letters

TIP: Use only the 1st letter

City

State

Zip

› [Search Tips](#)

WEB SEARCH

› [Advanced Search](#)

### SPONSORED LINKS

[Classmates.com](#)

[Find old friends and  
reconnect with them!](#)

[Prospect411](#)

[Gain New Customers  
- Power Your  
Business](#)



- › [Reverse Lookups in Batch & a hit](#)
- › [Get your Free Credit Report](#)
- › [View Homes for Sale Nationwide](#)

- › [Find Old Friends or Anyone](#)
- › [Complete a Survey & Get a Free Vacation](#)
- › [Get Your Home's Value](#)

[Home](#) | [About AnyWho](#) | [Help](#)

[Terms and Conditions.](#) [AT&T Privacy Policy.](#)

Copyright 2003 AT&T Corp. All Rights Reserved.

## Search ThomasRegister<sup>®</sup>

### Welcome Back ThomasRegister user

(If you are not ThomasRegister user , please  
[Log-In here](#) or [Register Now.](#))

I am searching for a:

For help with your search, please use our [Search  
Tips.](#)

**Product or Service  
Company Name  
Brand Name**

*Containing the words:*

## Welcome to ThomasRegister.com

Thomas Register is the most comprehensive online resource for finding companies and products manufactured in North America where you can:

- Place orders online
- View and download millions of Computer Aided Design (CAD) drawings
- View thousands of online company catalogs and websites

## Visit ThomasSpec<sup>SM</sup>

Thomas Register's industry specific destination for manufacturing software evaluation, mechanical and electromechanical component searching, or select custom quotes to submit RFQs and receive bids for custom made components.

Select one:

[Software Evaluation and Selection](#)  
[Electromechanical Product Catalog](#)  
[Custom Quotes](#)

# Buckminster Fuller

From [Wikipedia](#), the free encyclopedia.

**Richard Buckminster "Bucky" Fuller** ([July 12, 1895](#) - [July 1, 1983](#)) was an [American visionary](#), [designer](#), [architect](#), [inventor](#), and [writer](#).



## Contents

[1 Achievements](#)

[2 Biography](#)

[3 Concepts and buildings](#)

[4 Literature](#)

[5 Secondary literature](#)

[6 External links](#)

[[edit](#)]

## Achievements

Fuller became famous for his huge [geodesic domes](#), which can be seen as part of military [radar](#) stations, city halls, and exhibition attractions. Their construction is based on extending basic principles to build simple [tensegrity](#) structures ([tetrahedron](#), [octahedron](#), and the closest packing of [spheres](#)). Built in this way they are extremely lightweight and stable. After getting a first patent for

his domes in [1954](#), Fuller went on to explore nature's constructing principles to find solutions for designs in many areas of human life. He designed and built a safer, [aerodynamic Dymaxion car](#), a more accurate [Dymaxion Map](#), energy-efficient and low-cost [Dymaxion houses](#) (the term "[Dymaxion](#)" is contracted from DYNAMIC MAXimum tensION), radically strong and light [tensegrity](#) structures and much more. He also introduced [synergetics](#), which explores holistic engineering structures in nature (long before the term [synergy](#) became popular).

One of Fuller's Dymaxion Houses is on display as a permanent exhibit at the [Henry Ford Museum](#) in Dearborn, Michigan. It has several innovative features, including revolving dresser drawers, a fine-mist shower that reduces water consumption and variable siting for enhanced atmospheric circulation. According to Fuller biographer Steve Crooks, the house was designed to be delivered in two cylindrical packages, with interior color panels available at local dealers' stores. The house was designed to rotate around a central mast to take advantage of natural winds for cooling and circulation.



**The American Pavilion of [Expo '67](#)**, by R. Buckminster Fuller, now the Biosphère, on [Île Sainte-Hélène, Montreal](#). A geodesic dome is a structure developed by Buckminster Fuller in the [1940s](#) in line with his "synergetic" thinking.

His most lasting insights may be geometric. He claimed that the natural analytic geometry of the universe was based on arrays of tetrahedra. He developed this in several ways, from the close-packing of spheres and the number of compressive or tensile members required to stabilize an object in space. Some deep confirming results were that the strongest possible homogenous truss is cyclically tetrahedral, and all solids constructed of regular polygons, except the [icosahedron](#), have a volume that is an integral number of unit-tetrahedrons.

Buckminster Fuller was one of the first to propagate a [systemic worldview](#) (see 'Operating manual for Spaceship Earth', 'Synergetics') and explored principles of [energy](#) and material efficiency in the fields of [architecture](#), engineering and design.

A new [allotrope](#) of [carbon](#) ([fullerene](#)) and a particular molecule of that allotrope

([buckminsterfullerene](#) or buckyballs) have been named after him.

Fuller coined the term (but did not invent) *tensegrity*. He also coined the phrases *world around* and Spaceship Earth.

On [July 12, 2004](#) the [United States Post Office](#) released a new commemorative stamp honoring Buckminster Fuller on the 50th anniversary of his patent for the geodesic dome and on the occasion of his 109th birthday.

[[edit](#)]

## Biography

Fuller was born on [July 12, 1895](#) in Milton, [Massachusetts](#), the son of Richard **Buckminster** and Caroline Wolcott (Andrews) **Fuller**. He began studying at [Harvard](#) but was expelled from the university twice: firstly, for entertaining an entire dance troupe; and secondly, for his "irresponsibility and lack of interest". He served in the [US Navy](#) in [World War I](#). In [1927](#) at the age of 32, [bankrupt](#) and jobless, living in inferior housing in [Chicago](#), he saw his beloved young daughter Alexandra die of pneumonia in winter. He felt responsible, and this drove him to drink and the verge of [suicide](#). At the last moment he decided instead to embark on "an experiment, to find what a single individual can contribute to changing the world and benefiting all humanity." For the next half-century Buckminster Fuller contributed a wide range of ideas, designs and inventions to the world, particularly in the areas of practical, inexpensive shelter and transportation. Documenting his life, philosophy and ideas scrupulously in a daily [diary](#) and in 28 publications, Fuller was ultimately to be awarded 25 US patents and over 50 honorary doctorates.

His international career took off after the success of his huge [geodesic domes](#) in the [1950s](#). Now working as a designer, scientist, developer, and writer, for many years he also lectured all over the world on design. In [1965](#) Fuller inaugurated the [World Design Science Decade](#) (1965-[1975](#)) at the meeting of the [International Union of Architects](#) in [Paris](#). This was (in his own words) devoted to *applying the principles of science to solving the problems of humanity*.

On [January 16, 1970](#) Fuller received the Gold Medal award from the [American Institute of Architects](#) and has also received numerous other awards and honorary degrees.

He died at the age of 88, a [guru](#) of the design, architecture, and 'alternative' communities. It is said that while visiting his comatose wife in hospital, he said "She's waiting for me," closed his eyes, and died of a heart attack within 2 hours. His wife died 36 hours later.

Fuller was friends with Boston artist [Pietro Pezzati](#).

[[edit](#)]

# Concepts and buildings

Patent list: <http://www.bfi.org/patentlist.htm>

His concepts and buildings include:

- [Dymaxion house](#) (1928) See [autonomous building](#)
- Aerodynamic [Dymaxion car](#) (1933)
- Prefabricated compact bathroom cell (1937)
- [Dymaxion Map](#) of the world (1946)
- Buildings (1943)
- [Tensegrity](#) structures (1949)
- [Geodesic dome](#) for Ford Motor Company (1953)
- Patent on [geodesic domes](#) (1954)
- The [World Game](#) (1961) and the [World Game Institute](#) (1972)

[[edit](#)]

## Literature

His publications include:

- *4-D Timelock* (1928)
- *Nine Chains to the Moon* (1938)
- *Untitled Epic Poem on the History of Industrialization* (1962)
- *Education Automation: Freeing the Scholar to Return to his Studies* (1962, [ISBN 0-8093-0137-7](#))
- *Operating Manual for Spaceship Earth* (1969, [ISBN 0525474331](#)) - online at [http://www.bfi.org/operating\\_manual.htm](http://www.bfi.org/operating_manual.htm)
- *Your Private Sky* ([ISBN 3907044886](#))
- *Ideas and Integrities* (1969, ASIN 0020926308)
- *Utopia or Oblivion: The Prospects for Humanity* (1969, ASIN 0713901349)
- *Approaching the Benign Environment* (1970)
- *I Seem to Be a Verb* (1970)
- *No More Secondhand God and Other Writings*
- *Intuition* (1973, ASIN 0385012446)
- *Buckminster Fuller to Children of Earth* (1972)
- *Earth, Inc.* (1973)
- *Synergetics: Explorations in the Geometry of Thinking* (1975, [ISBN 0-02-541870-X](#)) -



online at <http://www.rwgrayprojects.com/synergetics/synergetics.html>

- *Tetrascroll: Goldilocks and the Three Bears: A Cosmic Fairy Tale* (1975)
- *And It Came to Pass -- Not to Stay* (1976, ASIN 0025418106)
- *R. Buckminster Fuller on Education* (1979, ASIN 0870232762)
- *Critical Path* (1981, [ISBN 0-312-17491-8](#))
- *Synergetics 2: Futher Explorations in the Geometry of Thinking* (1983)
- *Grunch of Giants* (1983, [ISBN 0-312-35194-1](#))
- *Inventions the Patented Works of R. Buckminster Fuller* (1983)
- *Cosmography* (1992, posthumous)

[[edit](#)]

## Secondary literature

A discussion of his work on geometry and systems appears in [A Fuller Explanation](#) (<http://www.angelfire.com/mt/marksomers/40.html>) by Amy C. Edmondson. Buckminster Fuller also appears as a character in [Paul Wühr](#)'s book "Das falsche Buch". His former student J. Baldwin wrote *BuckyWorks: Buckminster Fuller's Ideas for Today* ([ISBN 0471198129](#))

[[edit](#)]

## External links

- [WikiQuote: Buckminster Fuller](#) ([http://quote.wikipedia.org/wiki/Buckminster\\_Fuller](http://quote.wikipedia.org/wiki/Buckminster_Fuller))
- [Buckminster Fuller Institute](#) (<http://www.bfi.org>): With several complete works online.
- [Notes to R. Buckminster Fuller's Work](#) (<http://www.rwgrayprojects.com/rbfnnotes/toc.html>)
- [Synergetics on the Web](#) (<http://www.grunch.net/synergetics/>)
- [Build Genius: Zome System](#) (<http://www.zometool.com/>)
- [FAQ - R. Buckminster Fuller](#) (<http://www.cjfeanley.com/fuller-faq.html>)
- [Fuller, R. Buckminster](#) (<http://www.newciv.org/worldtrans/whole/bucky.html>) - includes list of books written by and about Fuller
- [R. Buckminster Fuller on PBS](#) (<http://www.thirteen.org/bucky>)
- [USPS Press Release](#) ([http://www.usps.com/communications/news/stamps/2004/sr04\\_043.htm](http://www.usps.com/communications/news/stamps/2004/sr04_043.htm)) - Information about Fuller's commemorative postage stamp
- [Wired News Article](#) ([http://www.wired.com/news/culture/0,1284,64155,00.html?tw=wn\\_tophead\\_5](http://www.wired.com/news/culture/0,1284,64155,00.html?tw=wn_tophead_5))

Retrieved from "[http://en.wikipedia.org/wiki/Buckminster\\_Fuller](http://en.wikipedia.org/wiki/Buckminster_Fuller)"

**Categories:** [U.S. architects](#) | [Inventors](#)

## Views

- [Article](#)
- [Discussion](#)
- [Edit this page](#)
- [History](#)

## Personal tools

- [Create an account or log in](#)

## Navigation

- [Main Page](#)
- [Community portal](#)
- [Current events](#)
- [Recent changes](#)
- [Random page](#)
- [Help](#)
- [Donations](#)

## Search

## Toolbox

- [What links here](#)
- [Related changes](#)
- [Special pages](#)

## In other languages

- [Deutsch](#)
- [Français](#)
- [à,ž](#)

- [Português](#)

[MediaWiki](#)

[GNU Free Documentation License](#)

- This page was last modified 03:10, 1 Sep 2004.
- All text is available under the terms of the [GNU Free Documentation License](#) (see [Copyrights](#) for details).
- [About Wikipedia](#)
- [Disclaimers](#)

[DOE Home](#)

[Offices & Facilities](#)

[About DOE](#)

[Press Room](#)

SEARCH

- [National Security](#)
- [Energy Sources](#)
- [Energy Efficiency](#)
- [Environment](#)
- [Energy Prices & Trends](#)
- [Science & Technology](#)
- [Health](#)
- [Safety & Security](#)



[Department of Energy Continues "Hydrogen 101" Education Workshop Series in Portland, OR](#)

➡ [August 31, 2004](#)

[Energy, Labor Departments Open California Benefits Assistance Center for Nuclear Weapons...](#)

➡ [August 27, 2004](#)

Science Education Initiative  
Secretary of Energy Abraham launches STARS, the "Scientists Teaching and Reaching Students" initiative. [More >](#)

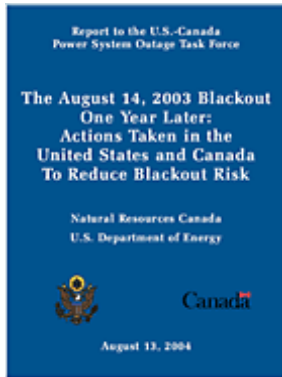

**Power Blackout: One Year Later**

On August 14, 2003, the largest power blackout in North American history affected eight U.S. States and the Province of Ontario, leaving up to 50 million people with no electricity. In its new report, "The August 14, 2003 Blackout, One Year Later: Actions Taken in the United States and Canada to Reduce Blackout Risk," the joint U.S.-Canadian task force assigned to determine the cause of the blackout releases a follow-up report. [More >](#)

INFORMATION FOR...

- [Doing Business with DOE](#)
- [DOE Careers](#)
- [Competitive Sourcing](#)
- [Consumers](#)
- [Researchers](#)
- [Teachers & Students](#)
- [Kids](#)



[Accessibility](#) | [Contact Us](#) | [No Fear Act Data](#) | [Phone Book](#) | [Events](#) | [Site Map](#) | [Privacy](#) | [FOIA](#) | [Plug-Ins](#) |

[Request For Comments](#)



[Home](#) | [Site Map](#) | [A-Z Index](#) | [EERE Information Center](#)

Search

# Search Help

## Using Symbols

| Symbol     | Example                | Search results                                                             |
|------------|------------------------|----------------------------------------------------------------------------|
| none       | solar energy           | Finds results that contain either or both of these words.                  |
| quotes     | "solar energy"         | Finds results that contain this phrase.                                    |
| plus signs | +biomass +gasification | Finds results that contain both these words.                               |
| minus sign | lighting -daylighting  | Finds results that contain the word lighting but not the word daylighting. |

## Other Techniques

| Technique         | Example            | Search results                                                                                                                                                                  |
|-------------------|--------------------|---------------------------------------------------------------------------------------------------------------------------------------------------------------------------------|
| word variations   | truck              | Finds results that contain the words truck, trucks, trucking, trucked, etc.                                                                                                     |
| lower case words  | wind               | Finds results that contain the words wind, Wind, WIND, etc.<br><br>Use lower case to find words with and without capital letters.                                               |
| capital letters   | WIND<br>Wind       | Finds results that contain these capitalized words.<br><br>Use capital letters only if you want exact matches on words, for example, names of people, places, or organizations. |
| title:            | title:geothermal   | Finds results that contain this word in the document title.                                                                                                                     |
| title: and quotes | title:"fuel cells" | Finds results that contain this phrase in the document title.                                                                                                                   |

[More detailed search](#) help is also available.

[Webmaster](#)

| [Security](#)

& [Privacy](#) |

[EERE](#)

[Home](#)

U.S.  
Department  
of Energy

Content

Last

Updated:

02/07/2003

# Site Map

## [U.S. Department of Energy](#) **Office of Energy Efficiency and Renewable Energy (EERE)**

*Bringing you a prosperous future where energy is clean, abundant, reliable, and affordable.*

### **EERE Offices**

[Golden Field Office](#)

[Regional Offices](#)

### **EERE Programs**

[Biomass Program](#)

[Building Technologies Program](#)

[Distributed Energy Program](#)

[Federal Energy Management Program](#)

[FreedomCAR & Vehicle Technologies Program](#)

[Geothermal Technologies Program](#)

[Hydrogen, Fuel Cells, & Infrastructure Program](#)

[Industrial Technologies Program](#)

[Solar Energy Technologies Program](#)

[Wind & Hydropower Technologies Program](#)

[Weatherization & Intergovernmental Program](#)

### **Energy Information Portal**

A directory of energy efficiency and renewable energy technologies

### **Energy Efficiency**

[Buildings](#) | [Industry](#) | [Transportation](#) | [Power](#)

### **Renewable Energy**

[Bioenergy](#) | [Geothermal](#) | [Hydrogen](#) | [Hydropower](#) |  
[Ocean](#) | [Solar](#) | [Wind](#)

### **Topics**

[Education](#) | [Financing](#) | [News](#) | [Solicitations](#)

## **Users**

[Consumers](#) | [Kids](#) | [States](#)

## **Finding Your Way Around EERE the Web Site**

[Search](#)

[Alphabetical Listing of Sites](#)

[Webmaster](#)

[Feedback](#)

[Subscribe to EREN Network News](#)

[Add a Site Request](#)

[Security and Privacy Notices](#)

[Disclaimer](#)

[Home](#)





# EERE Information Center

The EERE Information Center answers questions on EERE's products, services, and 11 technology programs, refers callers to the most appropriate EERE resources, and refers qualified callers to the appropriate expert networks.

Technical and programmatic information for the residential, commercial, institutional, industrial and transportation sectors is also immediately available through [The Energy Information Portal](#).

Other ways to find the information you need include:

- Visiting the [EERE Online Catalog](#)
- Visiting the [Energy Savers: A Consumer Guide to Energy Efficiency and Renewable Energy Web site](#)
- [Searching](#) EERE's Web site for online resources
- Browsing [EERE's Consumer Fact Sheets](#)
- Browsing EERE's [Commercial/Institutional Resources](#)
- Reviewing EERE's [Industrial Information, Tools and Publications](#)

You may contact the EERE Information Center with questions on EERE's products, services, and 11 technology programs by calling 1-877-EERE-INF (1-877-337-3463) or by completing and submitting the form below. A customer service specialist or energy expert at the EERE Information Center will respond to your inquiry.

Fields with asterisks are required. Please note that we are only able to respond to inquiries from the United States.

|                                     |                  |
|-------------------------------------|------------------|
| <b>First Name*:</b>                 | <b>MI:</b>       |
| <b>Last Name*:</b>                  |                  |
| <b>Title:</b>                       |                  |
| <b>Organization:</b>                |                  |
| <b>Address 1*:</b>                  |                  |
| <b>Address 2:</b>                   |                  |
| <b>City*:</b>                       |                  |
| <b>State*:</b>                      | <b>Zip Code:</b> |
| <b>Phone:</b>                       |                  |
| <b>Fax:</b>                         |                  |
| <b>E-mail*:</b>                     |                  |
| <b>Profession*:</b>                 |                  |
| <b>Please input your question*:</b> |                  |

If you have difficulty submitting this form, contact the EERE Information Center by calling 1-877-EERE-INF (1-877-337-3463).

The EERE Information Center is a service of DOE's [Office of Energy Efficiency and Renewable Energy](#).

 [Printable Version](#)

[Webmaster](#)

| [Security](#)

& [Privacy](#) |

[EERE](#)

[Home](#)

U.S.  
Department  
of Energy

Content

Last

Updated:

08/31/2004



## EERE News

[◀ EERE News Home](#)[About the Newsletter](#)[EERE Press Releases](#)[EERE Network News  
Archives](#)[Related Links](#)

*This is an excerpt from [EERE Network News](#), a weekly electronic newsletter.*

[Search Help](#) ▶ [More Search Options](#)▶ 

August 09, 2004

## DOE Awards \$16 Million for 162 Efficiency, Renewable Energy Projects

DOE announced on August 9th that it will grant more than \$16.3 million to 162 energy projects in 43 states and the District of Columbia as part of its State Energy Program. The Special Projects competitive grants include 66 "Clean Cities" grants to support the deployment of alternative fuels and alternative-fueled vehicles; 33 "Rebuild America" grants to assist community-based partnerships in improving the energy performance of commercial, government, multifamily, and public-housing buildings; 16 grants to support states' building codes and standards activities; 14 grants to encourage energy efficiency in energy-intensive industries and to support educational programs for industrial energy efficiency; 7 grants to support regional application centers to help deploy combined cooling, heating, and power technologies; 7 grants to promote biomass technologies; 6 "Building America" grants to build highly energy-efficient houses; 5 grants to support projects of the Federal Energy Management Program; 5 grants to measure wind energy resources at heights of 100 meters or more; and 3 grants to deploy solar energy technologies on polluted "brownfield" sites. See the [DOE press release](#).

[Webmaster](#)[| Security  
& Privacy |](#)[News](#)[Home |](#)[EERE](#)[Home](#)U.S.  
Department  
of Energy

Content

Last

Updated:

August 09,  
2004



## EERE News

[◀ EERE News Home](#)[About the Newsletter](#)[EERE Press Releases](#)[EERE Network News Archives](#)[Related Links](#)

*This is an excerpt from [EERE Network News](#), a weekly electronic newsletter.*

[Search Help](#) ▶ [More Search Options](#)  
▶ Search

July 30, 2004

## DOE Begins Process to Set New Efficiency Standards for Energy Equipment

DOE announced on July 30th that it is issuing new advance notices of proposed rulemaking for energy efficiency standards for residential furnaces and boilers, commercial air conditioners and heat pumps, and the transformers that utilities use in their electrical distribution systems. Compared to the total U.S. energy use of about 97 quadrillion Btus (quads) per year, residential furnaces and boilers currently use 4.6 quads, commercial air conditioners and heat pumps use 0.7 quads, and distribution transformers use 1.6 quads. DOE published an "Advanced Notice of Proposed Rulemaking" in the July 29th Federal Register for each of the three product categories, and will be holding public meetings on the proposed changes in late September. See the [DOE press release](#), and the proposed standards for [residential furnaces and boilers](#), [commercial air conditioners and heat pumps](#), and [distribution transformers](#).

Energy efficiency standards are part of DOE's Appliance and Commercial Equipment Standards Program. To date, energy efficiency standards have saved 7.9 quads of energy and have saved the nation \$31.3 billion in reduced energy bills. Existing energy efficiency standards are projected to save another 73.7 quads and \$147.4 billion between now and 2030. See the [Appliance and Commercial Equipment Standards Web site](#).



If adopted, efficiency standards would result in more energy-efficient heating equipment in U.S. homes.

*Credit:* Warren Gretz, NREL

[Webmaster](#)[| Security & Privacy |](#)[News](#)[Home |](#)[EERE](#)[Home](#)U.S.  
Department  
of EnergyContent  
Last

Updated:  
July 30,  
2004



## EERE News

[◀ EERE News Home](#)[About the Newsletter](#)[EERE Press Releases](#)[EERE Network News Archives](#)[Related Links](#)

*This is an excerpt from [EERE Network News](#), a weekly electronic newsletter.*

[Search Help](#) ▶ [More Search Options](#)▶ **July 29, 2004**

# DOE Awards \$94.8 Million to Weatherize Homes in 20 States

DOE awarded \$94.8 million to 20 states on July 1st to improve the energy efficiency of the homes of low-income families. Such families spend an average of 14 percent of their income on energy, compared with 3.5 percent for the average U.S. family. Weatherization reduces an average home's energy costs by \$218 a year.

Secretary of Energy Spencer Abraham announced on July 27th and July 29th the award of [\\$1.13 million to Arizona](#), [5.48 million to Colorado](#), [\\$2.93 million to Georgia](#), [\\$13.85 million to Illinois](#), [\\$4.52 million to Kentucky](#), [\\$2.65 million to Maryland](#), [\\$9.86 million to Minnesota](#), [\\$6 million to Missouri](#), [\\$2.49 million to Nebraska](#), [\\$835,429 to Nevada](#), [\\$1.72 million to New Mexico](#), [\\$4.16 million to North Carolina](#), [\\$2.5 million to North Dakota](#), [\\$14.71 million to Pennsylvania](#), [\\$1.92 million to South Dakota](#), [\\$4.18 million to Tennessee](#), [\\$2.08 million to Utah](#), [\\$4.02 million to Virginia](#), [\\$8.57 million to Wisconsin](#), and [\\$1.17 million to Wyoming](#).

DOE's Weatherization Assistance Program performs energy audits to identify the most cost-effective measures for each home, which typically include adding insulation, reducing air infiltration, servicing the heating and cooling systems, and providing health and safety diagnostic services. For every dollar spent, weatherization returns \$1.40 in energy savings over the life of the measures. The program is delivered through the states and 970 local agencies, and gives priority to low-income households with elderly members, people with disabilities, and children. See the [Weatherization Assistance Program Web site](#).

[Webmaster](#)[| Security & Privacy |](#)[News](#)[Home |](#)[EERE](#)[Home](#)U.S.  
Department  
of Energy

Content

Last

Updated:

July 29,

2004



## EERE News

### About the Newsletter

### EERE Press Releases

### EERE Network News Archives

### Related Links

EERE's newsletter, the *EERE Network News*, covers national and international energy efficiency and renewable energy news and events, as well as new EERE Web sites and energy facts. If you would like this newsletter emailed to you weekly, [subscribe here](#).



**September 01, 2004**

### [News and Events](#)

- [Colorado Utility Seeks 500 Megawatts of Renewable Energy](#)
- [After 20 Years, California Solar Project Reaches 3.2 Megawatts](#)
- [Arizona Utilities Expand Solar Energy Incentives](#)
- [Solar Car Sets Record Distance, but Tragedy Mars Related Tour](#)
- [UPS Deploys Three Fuel-Cell-Powered Delivery Trucks](#)
- [California Hydrogen Highway Network Gains Momentum](#)

### [Energy Connections](#)

- EIA Examines the Long-Term Longevity of Petroleum

## News and Events

### Colorado Utility Seeks 500 Megawatts of Renewable Energy

Xcel Energy announced in mid-August that it intends to add up to 500 megawatts of renewable energy to its energy supply in Colorado. The utility earned approval for the plan from the Colorado Public Utility Commission on August 11th, and issued a request for proposals on August 17th. The utility seeks power generated from wind, solar, biomass, or geothermal energy, as well as from waste sources or from

[Search Help](#) ▶ [More Search Options](#)

▶ Search

### ■ FEATURES

Subscribe to  
**EERE**  
 Network News



hydropower plants that are 20 megawatts or less in capacity. Xcel Energy will accept bids for power purchase contracts extending between 5 and 30 years. Proposals are due on November 23rd for the renewable power facilities, which must be in operation by the end of 2006. See the Xcel Energy [press release](#), or go directly to the [request for proposals](#).

## After 20 Years, California Solar Project Reaches 3.2 Megawatts

California's Sacramento Municipal Utility District (SMUD) dedicated new solar power arrays on August 24th at the site of one of its first major solar installations, located about 25 miles southeast of Sacramento, near the now-closed Rancho Seco nuclear power plant. The new arrays increase the solar power capacity at the site to 3.2 megawatts. The site's first solar project—a one-megawatt system called PV1—was installed 20 years ago, and those solar arrays are still operating at about 80 percent of their original performance.

Including the solar panels that SMUD has installed on parking structures, homes, and other buildings, the utility now has a total installed solar power capacity of 8.3 megawatts. In the past year, the utility has drawn on renewable energy sources for 9 percent of its electricity supply, and the utility has committed to increase that percentage to 20 percent by 2011. See the SMUD press release ([PDF 98 KB](#)). [Download Acrobat Reader](#).

## Arizona Utilities Expand Solar Energy Incentives

Two Arizona utilities are offering new or expanded incentives for their customers to install solar power systems. Following approval by the Arizona Corporation Commissioners in early August, Tucson Electric Power (TEP) has expanded its solar power incentives to provide a subsidy of up to \$3,000 per kilowatt of rated direct-current capacity for a limited number of solar power systems, and \$2,000 per kilowatt of rated alternating-current capacity. TEP will not provide maintenance for systems earning the higher subsidy. According to TEP, solar power systems could also qualify for up to \$1,000 in state tax credits. UniSource Energy Services (UES), TEP's sister company, is offering the same incentives. UES has also started a voluntary program for customers to add \$2 to their monthly electric bill to support solar power projects in the UES service territory. See the press releases from [TEP](#), [UES](#) and the [ACC](#).

## Solar Car Sets Record Distance, but Tragedy Mars Related Tour

An intrepid team of solar car enthusiasts from Canada's University of Waterloo has set a world



record for the longest journey by a solar-powered car. Called the Midnight Sun North American tour, the trip started from the campus in Waterloo, Ontario, crossed Canada to Vancouver, then headed



down through Seattle and down the length of California. On August 26th, the team crossed the border into Arizona, surpassing the world-record distance of 7,043.5 kilometers (4,376.6 miles) set by Queen's University in July 2000. The team is now setting its sights on an unofficial record of 13,054 kilometers (8,111 miles) set in Australia. See the [University of Waterloo press release](#).

As of August 30th, the team had left Terrell, Texas, heading for Little Rock, Arkansas, and had traveled more than 10,000 kilometers (6,214 miles). Although the team originally planned to travel a total of 19,336 kilometers, or just over 12,000 miles, they have decided to bypass the Southeast, since Hurricane Frances is expected to bring unfavorable weather into the region by the Labor Day weekend. See the "[Tour News](#)" section of the [Midnight Sun North American tour Web site](#), and check on the [status of Frances](#) from the National Hurricane Center.

Sadly, another Canadian solar car tour ended in tragedy on August 12th. The Canadian Solar Tour featured solar cars from six universities in Ontario and Quebec and was meant to travel from Windsor, Ontario, to Quebec City, Quebec. Near Waterloo, Andrew Frow, a University of Toronto student, was involved in a two-car crash and was killed. The tour was cancelled, and a memorial service was held on August 19th in honor of the 21-year-old engineering student. A memorial scholarship has also been established in Andrew Frow's name. The accident remains under investigation. See the [August 12th](#) and [August 23rd](#) announcements from the University of Toronto.

## UPS Deploys Three Fuel-Cell-Powered Delivery Trucks

UPS announced on August 26th that it will place three fuel-cell-powered delivery trucks in service in California and Michigan. DaimlerChrysler is providing the vehicles, which are a fuel-cell version of the Dodge Sprinter delivery truck. The new vehicles have a range of about 155 miles and accelerate as well

as current UPS vehicles. And thanks to housing the fuel-cell system in the floor, the vehicles also boast a 10 percent increase in cargo capacity compared to the



UPS is using three fuel-cell-powered Dodge Sprinters as delivery vehicles. *Credit: UPS*

the diesel-powered version of the Sprinter. The UPS announcement was made in Los Angeles, where the first vehicle was deployed; the other two vehicles will be placed into service in Sacramento, California, and Ann Arbor, Michigan. See the [UPS press release](#).

The new delivery vehicles are a step up in size for UPS, which has been using a DaimlerChrysler "F-Cell" vehicle on a daily express-delivery route in Ann Arbor, Michigan, since February. See the [story](#) from the June 23rd edition of the EERE Network News.

## California Hydrogen Highway Network Gains Momentum

California's Hydrogen Highway Network is moving ahead with the opening of a new hydrogen fueling station in southern California and plans for three more fueling stations underway. In mid-August, the South Coast Air Quality Management District (AQMD) opened one of southern California's first hydrogen fueling stations at its headquarters in Diamond Bar, east of Los Angeles. The publicly available station, built by Stuart Energy, is among the first of 13 hydrogen fueling stations slated for construction in four southern California counties. To help implement that plan, Air Products announced in mid-August that it will build three fueling stations for AQMD, collaborating with Proton Energy Systems, Inc. on two of the stations. The new fueling stations will be located in Burbank, Riverside, and Santa Ana, and should be completed in 2005. See the press releases from [AQMD](#) and [Air Products](#).

According to Texaco Ovonic Hydrogen Storage Systems LLC (TOHS), the AQMD is also looking ahead to the vehicles that will fuel up at those stations. By next spring, the AQMD will add five hybrid sedans with hydrogen fuel tanks using TOHS' solid hydrogen storage system, which works by absorbing hydrogen in a metal powder. The California Fuel Cell Partnership (CaFCP) is also looking ahead, and released a study in mid-August on the safety of parking hydrogen vehicles in garages. The study found that even non-ventilated garages can safely house hydrogen vehicles, so long as the vehicles are equipped with

hydrogen leak detectors and automated hydrogen shut-off valves. See the press releases from [TOHS](#) and [CaFCP](#).

The California Hydrogen Highway Network initiative, established in April by executive order of Governor Schwarzenegger, aims to install a network of 150 to 200 hydrogen fueling stations throughout California by 2010. See the [California Hydrogen Highway Network Web site](#).

## Energy Connections

### EIA Examines the Long-Term Longevity of Petroleum

In the wake of recent high oil prices, DOE's Energy Information Administration (EIA) has re-released a July 2000 study that examined the long-term prospects for world petroleum supplies. As noted in that study, the critical event in world oil production will be when it hits its peak, since any decline in oil production would leave some oil demand unsatisfied, and would likely lead to significant price increases. Drawing on oil resource estimates from the U.S. Geological Survey (which the authors believe to be conservative), the study finds a wide range of potential dates for the peak in oil production, ranging from 2021 to 2112, although either extreme is unlikely. Using a demand growth of 2 percent per year (the EIA currently projects a growth of [1.9 percent per year through 2025](#)), and using the mean value for the amount of oil reserves, the study predicts petroleum production will hit its peak in 2037.

The authors point out, however, that the study examines only conventional crude oil resources, and does not consider unconventional sources such as tar sands and very heavy oils. The authors also note that a greater use of gasoline-saving technologies, such as hybrid and fuel-cell vehicles, could significantly extend the worldwide production of crude oil. See the EIA report, "[Long-Term World Oil Supply Scenarios](#)."

[Webmaster](#)  
| [Security](#)  
& [Privacy](#) |  
[EERE](#)  
[Home](#)

U.S.  
Department  
of Energy

Content  
Last  
Updated:  
08/31/2004



## EERE News

[◀ EERE News Home](#)[About the Newsletter](#)[EERE Press Releases](#)[EERE Network News Archives](#)[Related Links](#)

# About the Newsletter

[Search Help](#) ▶ [More Search Options](#)▶ [Search](#)

*EERE Network News* is a weekly newsletter covering energy efficiency and renewable energy news and events, new sites on EERE, and energy facts and tips. To subscribe, fill out the form below. To see previous issues visit the [News Archives](#).

If you have any questions about *EERE Network News* or about subscribing, please send them to [the editor](#).

[Unsubscribe](#)[Subscription Change](#)

## Subscribe

The information you provide will help EERE better serve your needs. The mailing list addresses are never sold, rented, distributed or disclosed in any way.

**Name:****Complete email address:****What is your affiliation/organization (name)?****Which of these groups best describes your affiliation/organization?**

- |                             |                             |
|-----------------------------|-----------------------------|
| Commercial - large business | National Laboratory         |
| Commercial - small business | Not-for-Profit Organization |
| Consultant                  | State/Local Government      |
| Consumer/Private Citizen    | Student                     |
| Educator                    | Utility                     |
| Federal Government          | Other                       |
| Media                       | Other                       |

**What are your areas of interest? (Select as many as apply)****Renewable Energy**

- Biomass Energy
- Geothermal Energy
- Hydrogen and Fuel Cells
- Hydropower
- Ocean Energy
- Solar Energy
- Wind Energy

**Energy Efficiency**

- Buildings
- Industry
- Transportation
- Utilities

**Distributed Energy**

Other  
Other

[Webmaster](#)

| [Security](#)  
& [Privacy](#) |

[News](#)

[Home](#) |

[EERE](#)

[Home](#)

U.S.  
Department  
of Energy

Content

Last

Updated:

06/09/04

| [Adobe home page](#) | [access.adobe.com](http://access.adobe.com) |

**Update Advisory:** Adobe Systems encourages you to update to the latest release of Adobe Reader, version 6.0.2.

**New update:** Adobe Reader 6.0.2

Once you have successfully installed Adobe Reader 6.0.1, you may install the new 6.0.2 update. From within Adobe Reader 6.0.1, go to the Help menu, choose Updates, and follow the instructions.

## Adobe Reader download page

Below are quick links to the latest versions of Adobe® Reader® software. These links are followed by a more complete set of links to Adobe Reader in other languages. If you are distributing Adobe Reader 6.0.1, use the full version rather than the basic version. The full version includes accessibility, search, multimedia, and eBook support, as well as Adobe Photoshop® Album slide show and electronic card support. This will help ensure that recipients have access to all available functions for Adobe Reader. For more information on accessibility and Adobe Reader, including non-MSAA solutions, visit [access.adobe.com](http://access.adobe.com).

To find and download earlier versions of Adobe Reader, go to the [Adobe Reader archive page](#).

### The latest versions of Adobe Reader, by version:

[Adobe Reader 6.0.2, update only](#)

[Adobe Reader 6.0.2, full version](#)

[Adobe Reader 6.0.2, basic version](#)

[Adobe Reader 6.0.1, full version](#)

[Adobe Reader 6.0.1, basic version](#)

[Adobe Reader 6.0, full version](#)

[Acrobat Reader for Pocket PC 2002 \(all models - ARM, X-Scale\)](#)

[Adobe Reader for Palm OS® 3.0](#)

[Acrobat Reader for Symbian OS](#)

[Acrobat Reader 5.0.9](#)

[Acrobat Reader 3.0](#)

### Adobe Reader 6.0.2, update only

*Note: this download is an update only; it is not a full version of Adobe Reader. For the languages listed below, you must have version 6.0.1 already installed on your system.*

[Adobe Reader 6.0.2 update — English for Windows®, 4.2MB](#)

[Adobe Reader 6.0.2 update — English for Mac, 4.5MB](#)

[Adobe Reader 6.0.2 update — French for Windows, 4.2MB](#)

[Adobe Reader 6.0.2 update — French for Mac, 4.5MB](#)

[Adobe Reader 6.0.2 update — German for Windows, 4.2MB](#)

[Adobe Reader 6.0.2 update — German for Mac, 4.5MB](#)

[Adobe Reader 6.0.2 update — Japanese for Windows, 14.2MB](#)

[Adobe Reader 6.0.2 update — Japanese for Mac, 4.5MB](#)

- [Adobe Reader 6.0.2 update — Dutch for Windows, 4.2MB](#)
- [Adobe Reader 6.0.2 update — Dutch for Mac, 4.5MB](#)
- [Adobe Reader 6.0.2 update — Danish for Windows, 4.2MB](#)
- [Adobe Reader 6.0.2 update — Danish for Mac, 4.5MB](#)
- [Adobe Reader 6.0.2 update — Finnish for Windows, 4.2MB](#)
- [Adobe Reader 6.0.2 update — Finnish for Mac, 4.5MB](#)
- [Adobe Reader 6.0.2 update — Norwegian for Windows, 4.2MB](#)
- [Adobe Reader 6.0.2 update — Norwegian for Mac, 4.5MB](#)
- [Adobe Reader 6.0.2 update — Swedish for Windows, 4.2MB](#)
- [Adobe Reader 6.0.2 update — Swedish for Mac, 4.5MB](#)
- [Adobe Reader 6.0.2 update — Chinese Simplified for Windows, 4.2MB](#)
- [Adobe Reader 6.0.2 update — Chinese Simplified for Mac, 4.5MB](#)
- [Adobe Reader 6.0.2 update — Chinese Traditional for Windows, 4.2MB](#)
- [Adobe Reader 6.0.2 update — Chinese Traditional for Mac, 4.5MB](#)
- [Adobe Reader 6.0.2 update — Korean for Windows, 4.2MB](#)
- [Adobe Reader 6.0.2 update — Korean for Mac, 4.5MB](#)
- [Adobe Reader 6.0.2 update — Italian for Windows, 4.2MB](#)
- [Adobe Reader 6.0.2 update — Italian for Mac, 4.5MB](#)
- [Adobe Reader 6.0.2 update — Portuguese for Windows, 4.2MB](#)
- [Adobe Reader 6.0.2 update — Portuguese for Mac, 4.5MB](#)
- [Adobe Reader 6.0.2 update — Spanish for Windows, 4.2MB](#)
- [Adobe Reader 6.0.2 update — Spanish for Mac, 4.5MB](#)

### **Adobe Reader 6.0.2, full version**

*These downloads of Adobe Reader have already been updated to version 6.0.2.*

- [Adobe Reader 6.0.2 Czech \(Central European\) for Macintosh, 32.1MB](#)
- [Adobe Reader 6.0.2 Czech \(Central European\) for Windows, 21.1MB](#)
- [Adobe Reader 6.0.2 English \(Central European\) for Macintosh, 29.0MB](#)
- [Adobe Reader 6.0.2 English \(Central European\) for Windows, 19.0MB](#)
- [Adobe Reader 6.0.2 Greek \(Central European\) for Windows, 19.7MB](#)
- [Adobe Reader 6.0.2 Greek \(Central European\) for Macintosh, 31.4MB](#)
- [Adobe Reader 6.0.2 Hungarian \(Central European\) for Windows, 20.6MB](#)
- [Adobe Reader 6.0.2 Hungarian \(Central European\) for Macintosh, 32.3MB](#)
- [Adobe Reader 6.0.2 Polish \(Central European\) for Windows, 20.7MB](#)
- [Adobe Reader 6.0.2 Polish \(Central European\) for Macintosh, 31.6MB](#)
- [Adobe Reader 6.0.2 Russian \(Central European\) for Macintosh, 31.4MB](#)
- [Adobe Reader 6.0.2 Russian \(Central European\) for Windows, 19.7MB](#)
- [Adobe Reader 6.0.2 Turkish \(Central European\) for Windows, 19.6MB](#)
- [Adobe Reader 6.0.2 Turkish \(Central European\) for Macintosh, 31.4MB](#)

### **Adobe Reader 6.0.2, basic version**

*These downloads of Adobe Reader have already been updated to version 6.0.2.*

[Adobe Reader 6.0.2 Czech \(Central European\) for Macintosh, 22.4MB](#)  
[Adobe Reader 6.0.2 Czech \(Central European\) for Windows, 13.0MB](#)  
[Adobe Reader 6.0.2 English \(Central European\) for Macintosh, 20.5MB](#)  
[Adobe Reader 6.0.2 English \(Central European\) for Windows, 11.8MB](#)  
[Adobe Reader 6.0.2 Greek \(Central European\) for Windows, 12.5MB](#)  
[Adobe Reader 6.0.2 Greek \(Central European\) for Macintosh, 21.9MB](#)  
[Adobe Reader 6.0.2 Hungarian \(Central European\) for Windows, 13.3MB](#)  
[Adobe Reader 6.0.2 Hungarian \(Central European\) for Macintosh, 22.8MB](#)  
[Adobe Reader 6.0.2 Polish \(Central European\) for Windows, 12.5MB](#)  
[Adobe Reader 6.0.2 Polish \(Central European\) for Macintosh, 21.9MB](#)  
[Adobe Reader 6.0.2 Russian \(Central European\) for Macintosh, 21.9MB](#)  
[Adobe Reader 6.0.2 Russian \(Central European\) for Windows, 12.4MB](#)  
[Adobe Reader 6.0.2 Turkish \(Central European\) for Windows, 12.6MB](#)  
[Adobe Reader 6.0.2 Turkish \(Central European\) for Macintosh, 22.0MB](#)

### **Adobe Reader 6.0.1, full version**

[Adobe Reader 6.0.1 Chinese \(Simplified\) for Windows, 24.8MB](#)  
[Adobe Reader 6.0.1 Chinese \(Simplified\) for Macintosh, 33.8MB](#)  
[Adobe Reader 6.0.1 Chinese \(Traditional\) for Macintosh, 29.3MB](#)  
[Adobe Reader 6.0.1 Chinese \(Traditional\) for Windows, 22.0MB](#)  
[Adobe Reader 6.0.1 Danish for Windows, 16.4MB](#)  
[Adobe Reader 6.0.1 Danish for Macintosh, 22.4MB](#)  
[Adobe Reader 6.0.1 Dutch for Windows, 17.4MB](#)  
[Adobe Reader 6.0.1 Dutch for Macintosh, 22.4MB](#)  
[Adobe Reader 6.0.1 English for Windows, 15.9MB](#)  
[Adobe Reader 6.0.1 English for Macintosh, 21.0MB](#)  
[Adobe Reader 6.0.1 Finnish for Windows, 16.4MB](#)  
[Adobe Reader 6.0.1 Finnish for Macintosh, 22.4MB](#)  
[Adobe Reader 6.0.1 French for Windows, 17.9MB](#)  
[Adobe Reader 6.0.1 French for Macintosh, 22.6MB](#)  
[Adobe Reader 6.0.1 German for Windows, 17.8MB](#)  
[Adobe Reader 6.0.1 German for Macintosh, 22.6MB](#)  
[Adobe Reader 6.0.1 Italian for Macintosh, 22.6MB](#)  
[Adobe Reader 6.0.1 Italian for Windows, 17.6MB](#)  
[Adobe Reader 6.0.1 Japanese for Windows, 17.3MB](#)  
[Adobe Reader 6.0.1 Japanese for Macintosh, 23.0MB](#)  
[Adobe Reader 6.0.1 Korean for Macintosh, 25.7MB](#)  
[Adobe Reader 6.0.1 Korean for Windows, 19.0MB](#)  
[Adobe Reader 6.0.1 Norwegian for Macintosh, 22.4MB](#)  
[Adobe Reader 6.0.1 Norwegian for Windows, 16.4MB](#)  
[Adobe Reader 6.0.1 Portuguese for Windows, 16.4MB](#)



[Adobe Reader 6.0.1 Portuguese for Macintosh, 22.4MB](#)

[Adobe Reader 6.0.1 Spanish for Macintosh, 22.9MB](#)

[Adobe Reader 6.0.1 Spanish for Windows, 17.7MB](#)

[Adobe Reader 6.0.1 Swedish for Macintosh, 22.4MB](#)

[Adobe Reader 6.0.1 Swedish for Windows, 17.5MB](#)

### **Adobe Reader 6.0.1, basic version**

[Adobe Reader 6.0.1 Chinese \(Simplified\) for Windows, 17.7MB](#)

[Adobe Reader 6.0.1 Chinese \(Simplified\) for Macintosh, 26.1MB](#)

[Adobe Reader 6.0.1 Chinese \(Traditional\) for Macintosh, 21.7MB](#)

[Adobe Reader 6.0.1 Chinese \(Traditional\) for Windows, 15.0MB](#)

[Adobe Reader 6.0.1 Danish for Windows, 9.8MB](#)

[Adobe Reader 6.0.1 Danish for Macintosh, 15.0MB](#)

[Adobe Reader 6.0.1 Dutch for Windows, 9.8MB](#)

[Adobe Reader 6.0.1 Dutch for Macintosh, 15.0MB](#)

[Adobe Reader 6.0.1 English for Windows, 8.7MB](#)

[Adobe Reader 6.0.1 English for Macintosh, 14.2MB](#)

[Adobe Reader 6.0.1 Finnish for Windows, 9.8MB](#)

[Adobe Reader 6.0.1 Finnish for Macintosh, 15.0MB](#)

[Adobe Reader 6.0.1 French for Windows, 9.4MB](#)

[Adobe Reader 6.0.1 French for Macintosh, 14.8MB](#)

[Adobe Reader 6.0.1 German for Windows, 9.4MB](#)

[Adobe Reader 6.0.1 German for Macintosh, 14.8MB](#)

[Adobe Reader 6.0.1 Italian for Macintosh, 14.8MB](#)

[Adobe Reader 6.0.1 Italian for Windows, 9.4MB](#)

[Adobe Reader 6.0.1 Japanese for Windows, 10.3MB](#)

[Adobe Reader 6.0.1 Japanese for Macintosh, 15.2MB](#)

[Adobe Reader 6.0.1 Korean for Macintosh, 18.0MB](#)

[Adobe Reader 6.0.1 Korean for Windows, 12.0MB](#)

[Adobe Reader 6.0.1 Norwegian for Macintosh, 15.0MB](#)

[Adobe Reader 6.0.1 Norwegian for Windows, 9.8MB](#)

[Adobe Reader 6.0.1 Portuguese for Windows, 9.3MB](#)

[Adobe Reader 6.0.1 Portuguese for Macintosh, 14.6MB](#)

[Adobe Reader 6.0.1 Spanish for Macintosh, 15.1MB](#)

[Adobe Reader 6.0.1 Spanish for Windows, 9.5MB](#)

[Adobe Reader 6.0.1 Swedish for Macintosh, 15.0MB](#)

[Adobe Reader 6.0.1 Swedish for Windows, 9.8MB](#)

### **Adobe Reader 6.0, full version**

[Adobe Reader 6.0 Arabic \(Middle Eastern\) for Windows, 12.2MB](#)

[Adobe Reader 6.0 English \(Middle Eastern\) for Macintosh, 20.2MB](#)

[Adobe Reader 6.0 English \(Middle Eastern\) for Windows, 11.3MB](#)

[Adobe Reader 6.0 French \(Middle Eastern\) for Windows, 12.1MB](#)

[Adobe Reader 6.0 French \(Middle Eastern\) for Macintosh, 21.4MB](#)

[Adobe Reader 6.0 Hebrew \(Middle Eastern\) for Windows, 13.7MB](#)

**Acrobat Reader for Pocket PC 2002 (all models - ARM, X-Scale)**

[Acrobat Reader for Pocket PC \(Windows only\) English, 8.4MB](#)

[Acrobat Reader for Pocket PC \(Windows only\) French, 8.4MB](#)

[Acrobat Reader for Pocket PC \(Windows only\) German, 8.3MB](#)

[Acrobat Reader for Pocket PC \(Windows only\) Italian, 8.3MB](#)

[Acrobat Reader for Pocket PC \(Windows only\) Japanese, 10.1MB](#)

[Acrobat Reader for Pocket PC \(Windows only\) Spanish, 8.3MB](#)

**Adobe Reader for Palm OS, version 3.0**

[Adobe Reader for Palm OS English \(Windows\), 9.4MB](#)

[Adobe Reader for Palm OS English \(Macintosh\), 8.7MB](#)

[Adobe Reader for Palm OS French \(Windows\), 9.2MB](#)

[Adobe Reader for Palm OS French \(Macintosh\), 8.7MB](#)

[Adobe Reader for Palm OS German \(Windows\), 9.1MB](#)

[Adobe Reader for Palm OS German \(Macintosh\), 9.0MB](#)

[Adobe Reader for Palm OS Italian \(Windows\), 9.1MB](#)

[Adobe Reader for Palm OS Italian \(Macintosh\), 8.6MB](#)

[Adobe Reader for Palm OS Japanese \(Macintosh\), 8.8MB](#)

[Adobe Reader for Palm OS Japanese \(Windows\), 9.4MB](#)

[Adobe Reader for Palm OS Spanish \(Windows\), 9.1MB](#)

[Adobe Reader for Palm OS Spanish \(Macintosh\), 8.6MB](#)

**Acrobat Reader for Symbian OS (Nokia Communicator 9000 series), version 1.0**

[Acrobat Reader for Symbian OS, version 1.0 \(Windows only, Nokia Communicator 9000 series\) English, 0.7MB](#)

[Acrobat Reader for Symbian OS, version 1.0 \(Windows only, Nokia Communicator 9000 series\) French, 0.8MB](#)

[Acrobat Reader for Symbian OS, version 1.0 \(Windows only, Nokia Communicator 9000 series\) German, 0.8MB](#)

[Acrobat Reader for Symbian OS, version 1.0 \(Windows only, Nokia Communicator 9000 series\) Italian, 0.8MB](#)

[Acrobat Reader for Symbian OS, version 1.0 \(Windows only, Nokia Communicator 9000 series\) Spanish, 0.8MB](#)

**Acrobat Reader 5.0.9**

[Acrobat Reader 5.0.9 English with Search for IBM® AIX®, 18.0MB](#)

[Acrobat Reader 5.0.9 English with Search for Sun® Solaris® SPARC®, 9.5MB](#)

[Acrobat Reader 5.0.9 English with Search for HP-UX, 14.2MB](#)

[Acrobat Reader 5.0.9 English for Linux®, 8.9MB](#)

## **Acrobat Reader 3.0**

[Acrobat Reader 3.0 Dutch for OS/2® Warp, 4.2MB](#)

[Acrobat Reader 3.0 English for OS/2 Warp, 4.0MB](#)

[Acrobat Reader 3.0 French for OS/2 Warp, 4.1MB](#)

[Acrobat Reader 3.0 German for OS/2 Warp, 4.2MB](#)

[Acrobat Reader 3.0 Italian for OS/2 Warp, 4.1MB](#)

[Acrobat Reader 3.0 Spanish for OS/2 Warp, 4.1MB](#)

[Acrobat Reader 3.0 Swedish for OS/2 Warp, 4.1MB](#)

## **Adobe Acrobat Mirror Sites**

[Planet PDF: latest versions](#)

Copyright © 2004 Adobe Systems Incorporated. All rights reserved.

- [Terms of Use](#)
- [Privacy Policy](#)
- [Accessibility](#)
- [Avoid software piracy](#)
- [Permissions and trademarks](#)
- [Product License Agreements](#)



Bringing you a  
prosperous future  
where energy is clean,  
abundant, reliable,  
and affordable

FreedomCAR





Spencer Abraham,  
Secretary of Energy

David Garman,  
Assistant Secretary,  
Energy Efficiency and  
Renewable Energy

# A Strong Energy Portfolio for a Strong America

To Our Readers,

If you think about it, the clearest way to define national security is being prepared for the unexpected.

In light of the oil crises, reliability concerns, price volatility, and changes in environmental policies over the last three decades, one thing we know for certain about energy markets is that they can throw us quite a curve—and that we need to be prepared.

The President's National Energy Policy lays out a plan to prepare America for greater energy independence. Of the 105 components of the policy, 54—more than half—pertain to the importance of increasing energy efficiency or expanding our use of renewable energy.

The Office of Energy Efficiency and Renewable Energy (EERE) leads the charge for far-reaching technological change, to conserve and diversify the energy sources used to fuel America, and to lay the foundation for independence from imported oil. We pursue a diverse portfolio of research, development, and demonstration, all with one ultimate aim: to bring you a prosperous future where energy is abundant, reliable, and affordable.

Sincerely,

Spencer Abraham  
and  
David Garman

Energy efficiency and clean, renewable energy will mean a stronger economy, cleaner environment, and greater energy independence for America. By investing in technology breakthroughs today, our nation can look forward to a more resilient economy and secure future.

Far-reaching technology changes will be essential to America's energy future. Working with a wide array of partners, the Department of Energy's Office of Energy Efficiency and Renewable Energy (EERE) invests in a portfolio of energy technologies that will:

- Enhance our *energy security*, reducing our vulnerability to supply uncertainties brought about by emergencies such as storms, floods, or even future terrorist attacks on America's energy infrastructure.
- Increase our *economic security*, promoting industrial productivity, and ensuring reliable electricity and abundant, affordable energy to power economic growth.
- Improve our *environmental security*, reducing the emissions related to energy production and use, and conserving our natural environment.

The EERE portfolio includes technologies that will **dramatically reduce energy demand** in the residential, commercial, industrial, government, and transportation sectors; **increase and diversify energy supply**, with a focus on renewable domestic sources; upgrade the reliability of our national **energy infrastructure**; facilitate the emergence of **hydrogen technologies** as a vital part of our energy future; and **reduce our reliance on imported oil**.

## Making wise and productive use of energy

Conserving energy is a key part of the EERE equation. EERE's extensive research programs include efforts to improve the energy efficiency of vehicles, appliances, and buildings. The goal: to provide consumers with high levels of performance with less

▶

*As the nation's largest single energy user, the federal government is committed to using energy wisely in its own facilities and fleets throughout the country. Thanks to the efforts of the Federal Energy Management Program, government facilities are helping to lead the way in adopting energy-efficient and renewable technologies, and are on track to reduce energy use by 35 percent in 2010, compared to 1985. Achieving this goal will save taxpayers more than \$750 million per year.*



consumption of electricity, petroleum, and natural gas. Similarly, in the area of industrial technologies, EERE partners with manufacturers to improve yields, save energy, and improve environmental performance. Energy efficiency not only returns bottom-line cost savings, but also makes wise use of our nation's valuable energy resources and enhances environmental protection.

EERE develops energy-efficiency product standards and, with the Environmental Protection Agency, encourages consumer purchase of ENERGY STAR® products that exceed these standards. Together with state and community partners, EERE also provides a wide array of educational and technical assistance to help individuals, businesses, industries, schools, and local governments put energy-efficiency technologies and practices to work.

## Bringing renewable energy sources on line

Energy efficiency alone will not fill the gap between future energy demand and supply. Fortunately, America is blessed with a tremendous renewable resource base that can contribute substantially to our energy needs, especially for electricity generation. The challenge is to harness these resources in a cost-effective, competitive manner.

Our nation's investments to date are beginning to pay off, bringing several renewable energy sources within striking distance of cost-competitiveness with conventional sources. With continued R&D by government and the private sector, we will see a wealth of renewable energy supplies entering the marketplace over the next 20 years, from wind, biomass, geothermal, and solar technologies. We will also keep our abundant hydropower resources on line, through environmentally friendly technologies.



▶

*Americans enjoy the value provided by Energy Star® products, which are promoted in a joint effort by DOE and the Environmental Protection Agency. Innovations by manufacturers mean that today's most efficient washing machines use less than half the water and two-thirds the energy of five-year-old machines, while doing a better job on laundry. From refrigerators and computers, to light bulbs and air conditioners, Energy Star® products provide energy-efficient choices for consumers.*

## Ensuring reliable delivery of energy

Ensuring the reliable delivery of high-quality electricity is increasingly important in our digital economy. Yet many components of our nation's electricity infrastructure are aging and in need of replacement. That's why EERE is conducting research to improve the reliability and performance of the transmission system, through such technologies as high-temperature superconducting cable, advanced management tools, and technologies to create a smart, reliable electricity grid.

Distributed generation—using small units to generate electricity at the site where it is consumed—is another part of the solution. Ultimately, many of our nation's buildings could generate their own power from distributed and renewable resources, and our factories will become energy parks that produce energy as well as use it.

Distributed electricity generation will make our energy infrastructure more reliable and less vulnerable to disruption, and reduce the need for new power plants to meet peak demand. The EERE portfolio includes research on microturbines,



Courtesy Cargill Dow

▲ *Cutting-edge technologies for producing power, liquid fuels, and products from biomass can turn American farms and forests into tremendous resources to meet future energy needs and lessen our nation's dependence on foreign oil. EERE focuses its biomass R&D on cellulosic ethanol, gasification, and the integrated biorefinery concept for economically producing biobased products.*

reciprocating engines, fuel cells, combined heat and power systems, energy storage devices, and communications and controls systems, as well as many renewable technologies that may be well suited to distributed applications.

## Transitioning to a hydrogen economy

Our nation currently depends on petroleum—56 percent of which is imported—to fulfill virtually all our transportation energy needs. Oil imports add about \$109 billion per year to our nation's balance of payments deficit.

EERE is working on several fronts to reduce our dependence on imported oil: by developing technologies that may double or even triple the fuel efficiency of current vehicles; by bringing down the cost of alternative fuels, including ethanol and biodiesel; by developing technologies to improve the competitiveness and fuel economy of hybrid vehicles; by partnering with the trucking industry on prototype heavy-duty vehicles with improved fuel efficiency; and by promoting tax incentives to get more efficient cars and light trucks on the road as soon as possible.

The most far-reaching effort of all is FreedomCAR—a cooperative research initiative that teams DaimlerChrysler, Ford, and General Motors with industrial suppliers, national laboratories, and universities. FreedomCAR targets a dramatic long-term goal: the development of emissions-free and petroleum-free

vehicles. The effort focuses on the long-term, high-risk research needed to develop safe, affordable, and dependable hydrogen fuel cells to power our vehicles and the hydrogen production, storage, and distribution infrastructure to support them. President Bush has announced a Hydrogen Fuel Initiative, a new national commitment to move hydrogen fuel cell cars from the laboratory to the showroom.

Hydrogen and fuel cell technologies ultimately can lead to vehicles requiring no foreign oil and emitting nothing more than water vapor—all without sacrificing performance or freedom of choice. Hydrogen and fuel cell systems, a top priority of President Bush; can play multiple roles in our energy future, not only powering our vehicles, but also providing electricity and thermal energy for factories, office buildings, and, ultimately, residences.

Industrial productivity improvements also hold promise for decreasing our dependence on foreign oil. Reducing energy consumption in this fuel-flexible sector of our economy makes more natural gas available to displace oil in other applications.

## Renewable energy within reach

*Public and private R&D partnerships have made renewable energy technologies dramatically more cost effective than they were just two decades ago. With sustained R&D, our nation will have a range of economical, reliable renewable options for meeting tomorrow's energy needs.*

- **Wind:** R&D investments to date have lowered the cost of wind energy from about 80 cents per kilowatt-hour in current dollars in 1980 to as little as 4 cents per kilowatt-hour today. By 2010, EERE targets a cost of 3 cents per kilowatt-hour in those regions of the country with competitive wind resources. EERE also focuses R&D on low wind speed turbines designed to make wind energy more economically attractive in areas of the nation closer to population and load centers.
- **Biomass:** R&D has reduced the price of power from gasified biomass residues from 20 cents per kilowatt-hour in 1980 to a range of 7 to 10 cents per kilowatt-hour today. With sustained R&D efforts, EERE believes that a cost of 4 to 6 cents per kilowatt-hour is within reach by 2010.
- **Geothermal:** R&D has reduced the cost of power from new geothermal plants from about 15 cents per kilowatt-hour in 1985 to a range of 5 to 8 cents per kilowatt-hour today.
- **Solar:** The first commercially available PV panels in the early 1980s produced power at a cost of about \$2 per kilowatt-hour. Today, these systems can deliver electricity for as low as 20 to 38 cents per kilowatt-hour. Through further R&D advances, EERE's goal for 2020 is to reduce this cost to 5 cents per kilowatt-hour to the end customer. One focus of solar research will be the achievement of cost-effective "Zero Net Energy Buildings," or buildings that produce on average as much energy as they use.





# Making a Real Difference in Our Nation's Energy Choices

Technological improvements are only as valuable as the benefits they actually provide. That's why EERE focuses not only on research and development, but on demonstrating and applying clean energy technologies in ways that can make a real difference in our everyday lives as Americans.

Through six DOE regional offices, EERE actively supports communities, businesses, and individuals in deploying energy-efficiency and renewable energy technologies and practices, matching client needs with a variety of DOE resources and programs. EERE also works closely with states through the State

Energy Program, providing grants for clean energy technologies.

A wide array of EERE programs provide "hands-on" assistance to communities and businesses. **Rebuild America** creates a national network of public-private partnerships engaged in improving energy

efficiency in commercial, school, and multifamily buildings. Local action plans reduce energy costs, with savings used to modernize buildings and revitalize communities. **Energy Smart Schools**, a part of Rebuild America, focuses on helping K-12 schools lower their energy costs and create better learning environments. **Clean Cities** partnerships promote increased use of alternative-fuel vehicles through approximately 80 local coalitions around the country.

The **Weatherization Assistance Program** works with state agencies and local service providers to weatherize homes of low-income Americans. **ENERGY STAR**® teams with manufacturers and retailers to provide consumers with more energy-efficient choices in appliances, furnaces, air conditioners, lights, windows, and other products.



Effective partnerships—such as Rebuild America and its Energy Smart Schools campaign—are vital to meeting our nation's energy challenges. EERE's partners include , companies, universities, research organizations, and other Federal agencies, as well as Congress. EERE's field office in Golden, Colorado, develops and manages many of these important activities.



▲  
*In its first 25 years, the Weatherization Program has weatherized the homes of over five million low-income American families. Weatherization permanently reduces energy bills of client families—by an average of \$300 per year—and also enhances property values, brings dollars into the local economy, improves the tax base, generates jobs, and develops job skills. Combining both energy and non-energy benefits, the Weatherization Program produces \$3.71 in returns for clients and communities for every dollar invested. The benefits are so significant that the President has committed \$1.4 billion over the coming decade to continue making low-income family homes more affordable and comfortable.*

Together, these EERE activities support the widespread deployment and use of clean energy technologies, helping our communities, families, industries, and businesses make a real difference—in our nation’s energy choices, and in our everyday lives.



## **EERE research focuses on solutions to revitalize America’s energy future**

- Biomass
- Building Technologies
- Distributed Energy & Electric Reliability
- Federal Energy Management
- FreedomCAR & Vehicle Technologies
- Geothermal
- Hydrogen, Fuel Cells, & Infrastructure Technologies
- Industrial Technologies
- Solar
- Weatherization & Intergovernmental
- Wind & Hydropower

## **For More Information**

DOE's six regional offices serve as our front line, delivering energy-efficient and renewable energy technologies to states, communities, and businesses. Contact the regional office in your area for more information.

Central Regional Office  
303-275-4826  
[www.eere.energy.gov/regions/central](http://www.eere.energy.gov/regions/central)

Mid-Atlantic Regional Office  
215-656-6950  
[www.eere.energy.gov/regions/mid-atlantic](http://www.eere.energy.gov/regions/mid-atlantic)

Midwest Regional Office  
312-353-6749  
[www.eere.energy.gov/regions/midwest](http://www.eere.energy.gov/regions/midwest)

Northeast Regional Office  
617-565-9700  
[www.eere.energy.gov/regions/northeast](http://www.eere.energy.gov/regions/northeast)

Southeast Regional Office  
404-562-0555  
[www.eere.energy.gov/regions/southeast](http://www.eere.energy.gov/regions/southeast)

Western Regional Office  
206-553-1004  
[www.eere.energy.gov/regions/western](http://www.eere.energy.gov/regions/western)

For more information about DOE's Office of Energy Efficiency and Renewable Energy programs, call 1-877-EERE-INF or visit [www.eere.energy.gov](http://www.eere.energy.gov)



U.S. Department of Energy  
Energy Efficiency and Renewable Energy

sources

industry

weatherization

energy





## Buildings



### Buildings Organizations & Resources

- ▶ [U.S. Department of Energy](#)
- ▶ [U.S. Federal Government](#)
- ▶ [U.S. State & Local](#)
- ▶ [U.S. Trade & Nonprofit](#)
- ▶ [U.S. Universities and Research Institutes](#)
- ▶ [International Organizations](#)
- ▶ [Discussion Groups](#)
- ▶ [Newsletters & Magazines](#)
- ▶ [Products & Services](#)

## Buildings Topics

This section focuses on saving energy in buildings. Two renewable energy sources that can save energy in buildings are discussed separately: [solar energy](#) and [geothermal heat pumps](#).

[More basic information about building energy efficiency is also available.](#)

## Technologies

### [Building Envelope](#)

The building envelope includes everything that separates the interior of a building from the outdoor environment, including the windows, walls, foundation, basement slab, ceiling, roof, and insulation.

### [Space Heating and Cooling](#)

Energy-efficient heating and cooling of buildings are aided through the use of automated controls, ventilation, improved duct systems, and advanced technologies.

### [Water Heating](#)

Energy-efficient water heating combined with water-efficient appliances and fixtures will save water, energy, and money.

### [Lighting](#)

Compact fluorescent light bulbs and other efficient lighting technologies save energy and money.

### [Appliances](#)

Energy-efficient options are available for clothes washers and dryers, refrigerators, freezers, dishwashers, ovens, and stoves.

### [Office Equipment and Building Electrical Equipment](#)

Most office equipment wastes energy as it sits idle; equipment with built-in power management features can greatly reduce energy use by switching to low-energy mode when not in use. Energy-efficient motors and transformers are also available.

## Issues

### [Specific Types of Buildings](#)

Special programs exist to encourage energy efficiency in schools and federal buildings. Energy efficiency also helps those who live in affordable housing maintain affordable energy bills.

### [Building Energy Codes](#)

### Buildings News

- [Arizona Utilities Expand Solar Energy Incentives](#)  
September 01, 2004
- [California Plans to Install Solar Power on One Million Homes](#)  
August 25, 2004
- [Northwest Alliance Devotes \\$14 Million to Energy Efficiency](#)  
August 25, 2004

Building energy codes are generally set on the state level. Model codes have been established at the national level, but these are usually modified to meet specific needs within each state.

### **[Efficiency Standards](#)**

Energy efficiency standards for appliances are promulgated by the U.S. Department of Energy.

### **[Energy Audits](#)**

A variety of tools and technologies are used to evaluate the energy efficiency of buildings.

### **[Financing](#)**

Special financing is available that recognizes the savings due to energy efficiency, which allow the building owner to assume greater monthly mortgage payments. Some energy-efficient financing is based on the [Home Energy Rating System \(HERS\)](#).

### **[Whole-Building Design](#)**

Whole-building design takes an integrative approach to building design so that all elements of the building help achieve an optimal energy performance. The building has to interact effectively with the outdoor environment — a concept known as climate-responsive architecture. A variety of [design tools](#) are available.

### **[Commissioning, Operation, and Maintenance](#)**

Designing a building is only half the battle; it must be put into commission correctly, then operated and maintained correctly. [Measurement and verification of building performance](#) is an important aspect of commissioning new buildings.

### **[Landscaping for Energy Efficiency](#)**

Landscaping can improve a building's energy performance. Trees and bushes can provide shading or block a prevailing wind, as can [earth berms](#).

### **[Urban Heat Islands](#)**

In urban areas, building energy efficiency is hampered by higher urban temperatures, an effect known as urban heat islands.

[Webmaster](#)

| [Security](#)

& [Privacy](#) |

[EERE](#)

[Home](#)

U.S.  
Department  
of Energy

Content  
Last  
Updated:  
08/31/2004



## Industry



### Industry Organizations & Resources

- › [U.S. Department of Energy](#)
- › [U.S. State & Local](#)
- › [U.S. Trade & Nonprofit](#)
- › [U.S. Universities and Research Institutes](#)
- › [International Organizations](#)
- › [Newsletters & Magazines](#)
- › [Products & Services](#)

## Industry Topics

Industry uses more than one-third of all the energy used in the United States. Most of the energy industry uses is supplied from natural gas and petroleum, with electricity coming in a distant third, followed closely by coal. Certain industries, for instance steel production, require a large amount of energy per unit of product, and are the best candidates on which to focus energy-efficiency efforts.

[More basic information about industrial energy efficiency is also available.](#)

## Technologies

### [Industry-Specific Technologies](#)

Efforts to develop energy-efficient technologies are focused on the most energy-intensive industries, including [agriculture](#), the [aluminum industry](#), the [chemical industry](#), the [forest products industry](#), the [glass industry](#), the [metalcasting industry](#), the [mining industry](#), the [petroleum industry](#), and the [steel industry](#). Much of the work in agriculture and the chemical industry focuses on producing bioproducts from agricultural crops. See the [Biobased Chemicals and Materials page](#) of the Bioenergy section for more information.

### [Combined Heat and Power Systems](#)

The onsite production of electricity is particularly attractive to industries that can also make use of the waste heat. Such combined heat and power (CHP) systems — also called cogeneration systems — achieve higher thermal efficiencies than stand-alone power plants.

### [Motors](#)

Motor-driven equipment accounts for 64% of the electricity consumed by U.S. industries. Energy-efficient motors can cut this energy use by at least 12%.

### [Steam Systems](#)

Over 45% of all the fuel burned by U.S. manufacturers is consumed to raise steam. A typical industrial facility can realize steam savings of 20% by improving its steam system. Simple approaches to improving energy performance include [insulating steam and condensate return lines](#), stopping any [steam leaks](#), and maintaining [steam traps](#). [Condensate return](#) to the boiler is essential for energy efficiency.

### [Compressed Air Systems](#)

### Industry News

- [EIA Examines the Long-Term Longevity of Petroleum](#)  
September 01, 2004
- [Northwest Alliance Devotes \\$14 Million to Energy Efficiency](#)  
August 25, 2004
- [Wisconsin Residents Save \\$20 Million on Energy](#)  
August 18, 2004

Optimization of compressed air systems can provide energy-efficiency improvements of 20–50%. Many industries use compressed air systems as power sources for tools and equipment used for pressurizing, atomizing, agitating, and mixing applications. [Compressors](#) using [variable-speed drives](#) are saving energy, while simple measures like detecting and fixing [air leaks](#) remain all-important.

### [Continuous Fiber Ceramic Composites \(CFCC\)](#)

These composites are light, strong, corrosion resistant, and capable of performing in high temperature environments, without the brittleness of pure ceramics.

### [Combustion](#)

[Boilers](#) and [furnaces](#), rely on advanced [burners](#) to operate cleanly and efficiently. [Emissions](#) of pollutants such as [nitrous oxides \(NO<sub>x</sub>\)](#) are always of concern in combustion processes.

### [Sensors and Controls](#)

All industrial systems rely on sensors and controls. Advanced sensors and control systems can allow processes to operate at their optimal conditions.

## Issues

### [Industrial Energy Assessments](#)

Just as homes need energy audits, industries need energy assessments to identify the areas they can focus on for energy savings.

### [Financing](#)

A variety of financing sources are available to fund industrial energy efficiency improvements.

[Webmaster](#)

| [Security](#)  
& [Privacy](#) |

[EERE](#)

[Home](#)

U.S.  
Department  
of Energy

Content  
Last  
Updated:  
08/31/2004



## Power



**Distributed Energy  
Program Web Site** ▶

### Power Organizations & Resources

- ▶ [U.S. Department of Energy](#)
- ▶ [U.S. Federal Government](#)
- ▶ [U.S. State & Local](#)
- ▶ [U.S. Trade & Nonprofit](#)
- ▶ [U.S. Universities and Research Institutes](#)
- ▶ [International Organizations](#)
- ▶ [Discussion Groups](#)
- ▶ [Newsletters & Magazines](#)
- ▶ [Products & Services](#)

## Power Topics

Many power companies have programs that encourage their customers to invest in energy efficiency products that lower consumer energy bills, delay the need for new electrical generation capacity, and reduce the emission of greenhouse gases and other pollutants. Technologies that maximize the efficient generation, transmission, and storage of energy are fundamental to such programs. Renewable electricity generating technologies also play a major role in many programs and are discussed separately under the [solar](#), [geothermal](#), [bioenergy](#), [ocean](#), [wind](#), [hydropower](#), and [hydrogen](#) headings on EREN.

[More basic information about energy efficiency in the power industry is also available.](#)

## Technologies

### [Superconductivity](#)

Superconducting materials have the ability to conduct electrical current with no resistance and extremely low energy losses. Their capacity to efficiently handle large amounts of current can be applied to electric devices and to electricity transmission.

### [Energy Storage](#)

Energy storage can improve the efficiency and reliability of the electric utility system by reducing the requirements for spinning reserves to meet peak power demands, making better use of efficient baseload generation, and allowing greater use of intermittent renewable energy technologies. Energy storage technologies include utility battery storage, flywheel storage, superconducting magnetic energy storage, compressed air energy storage, pumped hydropower, and supercapacitors.

## Issues

### [Demand-Side Management \(DSM\)](#)

DSM refers to actions taken on the customer's side of the meter to change the amount or timing of energy consumption. Utility DSM programs offer a variety of measures that can reduce energy consumption and consumer energy expenses.

### [Distributed Generation](#)

Small, modular electricity generators sited close to the customer load can enable utilities to defer or eliminate costly investments in transmission and distribution system upgrades, and provide

### Power News

- [California Plans to Install Solar Power on One Million Homes](#)  
August 25, 2004
- [Northwest Alliance Devotes \\$14 Million to Energy Efficiency](#)  
August 25, 2004
- [The August 14 Blackout: One Year Later](#)  
August 18, 2004



customers with more reliable energy supplies and a cleaner environment.

### [Electricity Industry Restructuring](#)

Utility deregulation has the potential to bring greater customer choice among energy products and suppliers. Electricity rates could also drop, as the price of energy will be determined less by federal and state regulations and more by energy supply and demand.

### [Electricity Reliability](#)

A stable and reliable electricity grid is the backbone of modern society. With the electricity industry being restructured, additional demands are being placed on the grid, making it even more important to maintain reliability standards.

[Webmaster](#)

| [Security](#)

& [Privacy](#) |

[EERE](#)

[Home](#)

U.S.  
Department  
of Energy

Content  
Last  
Updated:  
08/24/2004



## Transportation



### Transportation Organizations & Resources

- › [U.S. Department of Energy](#)
- › [U.S. Federal Government](#)
- › [U.S. State & Local](#)
- › [U.S. Trade & Nonprofit](#)
- › [U.S. Universities and Research Institutes](#)
- › [International Organizations](#)
- › [Discussion Groups](#)
- › [Newsletters & Magazines](#)
- › [Products & Services](#)

## Transportation Topics

Transportation accounts for 65% of U.S. oil consumption and is the predominant source of air pollution. New transportation technologies are intended to improve the efficiency and emissions of vehicles using petroleum-based fuels, provide cleaner-burning alternative fuels, and reduce the quantity of miles individual vehicles travel on our roads and highways.

[More basic information about transportation energy efficiency is also available.](#)

## Technologies and Approaches

### [Improved Petroleum-Based Fuels](#)

Improved gasoline and diesel fuel will improve performance and reduce emissions.

### [Improved Petroleum-Based Vehicles](#)

New technologies such as hybrid electric vehicles and fuel cells may double or triple the efficiency of current vehicles.

### [Alternative Fuels](#)

Non-petroleum or "alternative" fuels such as natural gas and ethanol can be used instead of gasoline in vehicles. Although not usually thought of as a "fuel," electricity can provide an alternative to gasoline when used in electric vehicles.

### [Alternative Fuel Vehicles](#)

Alternative fuel vehicles use alternative fuels instead of gasoline or diesel fuel.

### [Components](#)

Research on advanced engines, drives, and other components will enable progress in other areas.

### [Materials](#)

Materials being examined for alternative and advanced vehicles include plastics, composites, lightweight metals, ceramics, and catalysts. Special applications include engines, natural gas storage tanks, and catalytic converters.

## Issues

### [Reducing Vehicle Miles Traveled](#)

A variety of approaches can be employed to slow the growth of vehicles on the road and the miles they travel. Mass transit,

### Transportation News

- [Solar Car Sets Record Distance, but Tragedy Mars Related Tour](#)  
September 01, 2004
- [UPS Deploys Three Fuel-Cell-Powered Delivery Trucks](#)  
September 01, 2004
- [California Hydrogen Highway Network Gains Momentum](#)  
September 01, 2004

telecommuting, and "smart transportation" are just a few of the approaches that could contribute to a sustainable transportation future.

### [Air Emissions and Standards](#)

The transportation sector is currently the dominant source of air pollution in the United States. Emissions standards and fuel economy standards work together to address this issue. Fuel economy standards also help to reduce U.S. petroleum consumption.

### [Petroleum Supply and Demand](#)

Estimates of worldwide petroleum resources vary substantially, but many reports suggest that resources will be readily accessible for about the next 50 years. Demand for petroleum continues to rise dramatically around the world, fueled by economic development and growth.

### [Alternative Fuel Infrastructure](#)

The existing gasoline and diesel infrastructure represents hundreds of billions of dollars of investment over many years. To be widely used, alternative fuels may require similar investments in fuel infrastructure. Thus far, most attention has been focused on the development of [ethanol](#), [methanol](#), [natural gas](#), [propane](#), and [hydrogen](#) infrastructures.

### [Regulations, Laws, and Incentives](#)

There are various rules and regulations that require certain fleet types to purchase and operate alternative fuel vehicles. In addition, there are federal and state incentives available for fleets and private individuals to help offset any incremental cost of purchasing these vehicles. Existing tax incentives can help individuals who buy alternative fuel vehicles.

[Webmaster](#)

| [Security](#)

& [Privacy](#) |

[EERE](#)

[Home](#)

U.S.  
Department  
of Energy

Content

Last

Updated:

08/31/2004



# Energy Savers *A consumer guide to energy efficiency and renewable energy*

[Home Improvements](#) | [Heat & Cool](#) | [Buy Clean Electricity](#) | [Make Clean Electricity](#) | [Buy Vehicles](#) | [Information Resources](#)

[Search Help](#) ▶ [More Search Options](#)

▶ [Search](#)

[EERE Information Center](#)

## ■ FEATURES

**Learn About  
Green Power  
Markets**



**Energy Saving  
Tips for Your  
Home or Business**



**ENERGY SAVERS**  
Online Booklet



**Assistance for Low Income  
Families** ▶

**Manufacturers:  
Lower Your Energy Bill** ▶

Interested in saving money by making your home or small business more energy efficient? Want to use renewable energy to heat or power your home or small business? This site is your guide to the world of renewable energy and energy efficiency options.

## What do you want to do?

### Information resources

▶ [Fact sheets](#)

▶ [Technology reports](#)

▶ [Resources & reading lists](#)

▶ [Interactive evaluation tools](#)

▶ [Animations](#)

▶ [Glossary](#)

### How a wind turbine works



View our interactive animation to learn how a wind turbine works and how it can be used.

Note: Best viewed in Internet Explorer; Requires the Flash Player. [Text Version](#)

## State-specific information

Learn what's going on in your state, or find someone to help you with your project.



 [Printable Version](#)

[Webmaster](#)

| [Security](#)

& [Privacy](#) |

[EERE](#)

[Home](#)

U.S.  
Department  
of Energy

Content

Last

Updated:

09/02/2004



U.S. Department of Energy  
**Energy Efficiency and Renewable Energy**

[EERE Home](#)

## EERE Kids *Dr. E's Energy Lab*

[Search Help](#) ▶ [More Search Options](#)

▶ [Search](#)

[EERE Information Center](#)

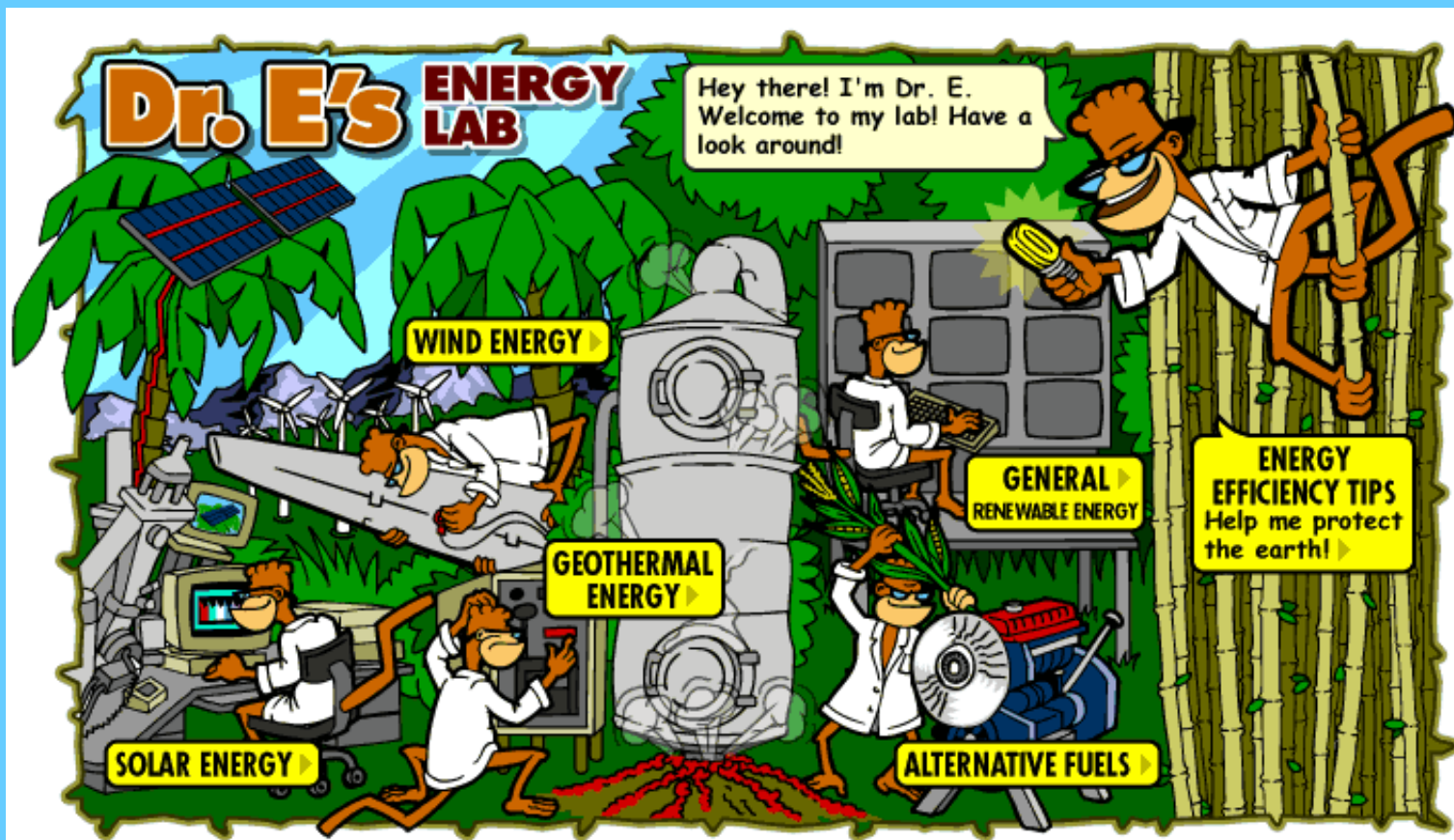

[Webmaster](#)

| [Security](#)

& [Privacy](#) |

[EERE](#)

[Home](#)

U.S.  
Department  
of Energy

Content

Last

Updated:

09/18/2003



## State Energy Portal

**Information Resources**

**Financial Opportunities**

**Projects**

**State Policies & Options**

Comfortable, efficient homes. Fuel-saving hybrid vehicles. Renewable fuels for utility power generation. States are embracing energy efficiency and renewable energy options across the land.



The State Energy Portal provides users with access to the full range of state energy efficiency and renewable energy information.

Federal, state, and local policymakers; energy professionals; government employees; researchers; energy consumers; energy activists; students; and educators interested in what is happening in the states will all find information of interest on this site.

 [Printable Version](#)

[Search Help](#) ► [More Search Options](#)

► [Search](#)

[EERE Information Center](#)

### ■ EVENTS

[NARUC Summer Committee Meeting](#)

July 11-14, 2004

### ■ FEATURES

**Serving the States**  
**EERE's Regional**  
**Offices**



[Webmaster](#)  
 | [Security](#)  
 & [Privacy](#) |  
[EERE](#)  
[Home](#)

U.S.  
 Department  
 of Energy

Content  
 Last  
 Updated:  
 08/19/2004





## Bioenergy

[Biomass Web site](#)

### Bioenergy Organizations & Resources

- ▶ [U.S. Department of Energy](#)
- ▶ [U.S. Federal Government](#)
- ▶ [U.S. State & Local](#)
- ▶ [U.S. Trade & Nonprofit](#)
- ▶ [U.S. Universities and Research Institutes](#)
- ▶ [International Organizations](#)
- ▶ [Discussion Groups](#)
- ▶ [Newsletters & Magazines](#)
- ▶ [Products & Services](#)

## Bioenergy Topics

Bioenergy technologies use renewable biomass resources to produce an array of energy related products including electricity, liquid, solid, and gaseous fuels, heat, chemicals, and other materials. Bioenergy ranks second (to hydropower) in renewable U.S. primary energy production and accounts for three percent of the primary energy production in the United States.

[More basic information about bioenergy is also available.](#)

## Technologies

### Biomass Resources

The term "biomass" means any plant derived organic matter available on a renewable basis, including dedicated energy crops and trees, agricultural food and feed crops, agricultural crop wastes and residues, wood wastes and residues, aquatic plants, animal wastes, municipal wastes, and other waste materials. Handling technologies, collection logistics and infrastructure are important aspects of the biomass resource supply chain.

### Biopower

Biopower technologies are proven electricity generation options in the United States, with 10 gigawatts of installed capacity. All of today's capacity is based on mature direct-combustion technology. Future efficiency improvements will include co-firing of biomass in existing coal fired boilers and the introduction of high-efficiency gasification combined-cycle systems, fuel cell systems, and modular systems.

### Biofuels

A variety of fuels can be made from biomass resources, including the liquid fuels ethanol, methanol, biodiesel, Fischer-Tropsch diesel, and gaseous fuels such as hydrogen and methane. Biofuels research and development is composed of three main areas: producing the fuels, finding applications and uses of the fuels, and creating a distribution infrastructure.

### Biobased Chemicals and Materials

Biobased chemicals and materials are commercial or industrial products, other than food and feed, derived from biomass feedstocks. Biobased products include green chemicals, renewable plastics, natural fibers, and natural structural materials. Many of these products can replace products and materials traditionally derived from petrochemicals, but new and improved processing technologies will be required.

### Bioenergy News

- [Colorado Utility Seeks 500 Megawatts of Renewable Energy](#)  
September 01, 2004
- [EIA: U.S. Renewable Energy Use Up 3 Percent in 2003](#)  
August 25, 2004
- [USDA Announces Sign-Up for \\$150-Million Bioenergy Program](#)  
August 11, 2004

### [Integrated Bioenergy Systems and Assessments](#)

The economic, social, environmental, and ecological consequences in growing and using biomass are important to understand and consider when addressing technological, market, and policy issues associated with bioenergy systems.

[Webmaster](#)

| [Security](#)

& [Privacy](#) |

[EERE](#)

[Home](#)

U.S.

Department  
of Energy

Content

Last

Updated:

08/31/2004



## Geothermal



### Geothermal Organizations & Resources

- ▶ [U.S. Department of Energy](#)
- ▶ [U.S. Federal Government](#)
- ▶ [U.S. State & Local](#)
- ▶ [U.S. Trade & Nonprofit](#)
- ▶ [U.S. Universities and Research Institutes](#)
- ▶ [International Organizations](#)
- ▶ [Discussion Groups](#)
- ▶ [Newsletters & Magazines](#)
- ▶ [Products & Services](#)

## Geothermal Topics

Geothermal energy technologies use the heat of the earth for direct-use applications, geothermal heat pumps, and electrical power production. Research in all areas of geothermal development is helping to lower costs and expand its use. In the United States, most geothermal resources are concentrated in the West, but geothermal heat pumps can be used nearly anywhere.

[More basic information about geothermal energy is also available.](#)

## Technologies

### Exploration

Geological, geochemical, and geophysical techniques are used to locate geothermal resources.

### Drilling

Drilling for geothermal resources has been adapted from the oil industry. Improved drill bits, slimhole drilling, advanced instruments, and other drilling technologies are under development.

### Direct Use

Geothermal hot water near the Earth's surface can be used directly for heating buildings and as a heat supply for a variety of commercial and industrial uses. Geothermal direct use is particularly favored for greenhouses and aquaculture.

### Geothermal Heat Pumps

Geothermal heat pumps, or ground-source heat pumps, use the relatively constant temperature of soil or surface water as a heat source and sink for a heat pump, which provides heating and cooling for buildings.

### Electricity Production

Underground reservoirs of hot water or steam, heated by an upwelling of magma, can be tapped for electrical power production.

### Advanced Technologies

Advanced technologies will help manage geothermal resources for maximum power production, improve plant operating efficiencies, and develop new resources such as hot dry rock, geopressured brines, and magma.

## Issues

### Environment

Geothermal technologies release little or no air emissions.

### Geothermal News

- [Colorado Utility Seeks 500 Megawatts of Renewable Energy](#)  
September 01, 2004
- [EIA: U.S. Renewable Energy Use Up 3 Percent in 2003](#)  
August 25, 2004
- [EPA, GSA, and World Bank Seek to Buy Renewable Energy Credits](#)  
August 11, 2004

Geothermal power production produces much lower air emissions than conventional energy technologies.

### [Resources](#)

In the United States, geothermal resources are concentrated in the West, although low-temperature resources can also be found in the rest of the country. Geothermal heat pumps can be used nearly anywhere.

[Webmaster](#)

| [Security](#)

& [Privacy](#) |

[EERE](#)

[Home](#)

U.S.  
Department  
of Energy

Content  
Last  
Updated:  
08/31/2004



## Hydrogen



## Hydrogen, Fuel Cells & Infrastructure Technologies Program

### Hydrogen Organizations & Resources

- ▶ [U.S. Department of Energy](#)
- ▶ [U.S. Federal Government](#)
- ▶ [U.S. State & Local](#)
- ▶ [U.S. Trade & Nonprofit](#)
- ▶ [U.S. Universities and Research Institutes](#)
- ▶ [International Organizations](#)
- ▶ [Discussion Groups](#)
- ▶ [Newsletters & Magazines](#)
- ▶ [Products & Services](#)

## Hydrogen Topics

Hydrogen is the third most abundant element on the earth's surface, where it is found primarily in water (H<sub>2</sub>O) and organic compounds. It is generally produced from hydrocarbons or water; and when burned as a fuel, or converted to electricity, it joins with oxygen to again form water.

[More basic information about hydrogen energy is also available.](#)

## Technologies

### Production

Hydrogen is produced from sources such as natural gas, coal, gasoline, methanol, or biomass through the application of heat; from bacteria or algae through photosynthesis; or by using electricity or sunlight to split water into hydrogen and oxygen.

### Transport and Storage

The use of hydrogen as a fuel and energy carrier will require an infrastructure for safe and cost-effective hydrogen transport and storage.

### Fuel Cells

Hydrogen's potential use in fuel and energy applications includes powering vehicles, running turbines or fuel cells to produce electricity, and generating heat and electricity for buildings. The current focus is on hydrogen's use in fuel cells.

## Issues

### Safety

Hydrogen has an excellent safety record, and is as safe for transport, storage and use as many other fuels. Nevertheless, safety remains a top priority in all aspects of hydrogen energy. The hydrogen community addresses safety through stringent design and testing of [storage and transport concepts](#), and by developing [codes and standards](#) for all types of hydrogen-related equipment.

### The Hydrogen Economy

The vision of building an energy infrastructure that uses hydrogen as an energy carrier — a concept called the "hydrogen economy" — is considered the most likely path toward a full commercial application of hydrogen energy technologies.

### Hydrogen News

- [UPS Deploys Three Fuel-Cell-Powered Delivery Trucks](#)  
September 01, 2004
- [California Hydrogen Highway Network Gains Momentum](#)  
September 01, 2004
- [EIA: U.S. Renewable Energy Use Up 3 Percent in 2003](#)  
August 25, 2004

[Webmaster](#)

| [Security](#)

& Privacy |

[EERE](#)

[Home](#)

U.S.  
Department  
of Energy

Content

Last

Updated:

08/31/2004



## Hydropower



**Wind & Hydropower Technologies Program Web Site** ▶

### Hydropower Organizations & Resources

- ▶ [U.S. Department of Energy](#)
- ▶ [U.S. Federal Government](#)
- ▶ [U.S. State & Local](#)
- ▶ [U.S. Trade & Nonprofit](#)
- ▶ [U.S. Universities and Research Institutes](#)
- ▶ [International Organizations](#)
- ▶ [Discussion Groups](#)
- ▶ [Newsletters & Magazines](#)
- ▶ [Products & Services](#)

## Hydropower Topics

Hydropower (also called hydroelectric power) facilities in the United States can generate enough power to supply 28 million households with electricity, the equivalent of nearly 500 million barrels of oil. The total U.S. hydropower capacity—including pumped storage facilities—is about 95,000 megawatts. Researchers are working on [advanced turbine technologies](#) that will not only help maximize the use of hydropower but also minimize adverse environmental effects.

[More basic information about hydropower is also available.](#)

## Types of Hydropower

### Impoundment

An impoundment facility, typically a large hydropower system, uses a dam to store river water in a reservoir. The water may be released either to meet changing electricity needs or to maintain a constant reservoir level.

### Diversion

A diversion, sometimes called *run-of-river*, facility channels a portion of a river through a canal or penstock. It may not require the use of a dam.

### Pumped Storage

When the demand for electricity is low, a pumped storage facility stores energy by pumping water from a lower reservoir to an upper reservoir. During periods of high electrical demand, the water is released back to the lower reservoir to generate electricity.

## Sizes of Hydropower Plants

Facilities range in size from large power plants that supply many consumers with electricity to small and micro plants that individuals operate for their own energy needs or to sell power to utilities.

### Large Hydropower

Although definitions vary, DOE defines large hydropower as facilities that have a capacity of more than 30 megawatts.

### Small Hydropower

Although definitions vary, DOE defines small hydropower as facilities that have a capacity of 0.1 to 30 megawatts.

### Micro Hydropower

### Hydropower News

- [Colorado Utility Seeks 500 Megawatts of Renewable Energy](#)  
September 01, 2004
- [EIA: U.S. Renewable Energy Use Up 3 Percent in 2003](#)  
August 25, 2004
- [Public Renewables Partnership Informs Utilities About Renewable Energy](#)  
August 11, 2004

A micro hydropower plant has a capacity of up to 100 kilowatts (0.1 megawatts).

## Turbine Technologies

There are many types of turbines used for hydropower, and they are chosen based on their particular application and the height of standing water—referred to as "head"—available to drive them. The turning part of the turbine is called the runner. The most common turbines are as follows:

### Pelton Turbine

A Pelton turbine has one or more jets of water impinging on the buckets of a runner that looks like a water wheel. The Pelton turbines are used for high-head sites (50 feet to 6,000 feet) and can be as large as 200 megawatts.

### Francis Turbine

A Francis turbine has a runner with fixed vanes, usually nine or more. The water enters the turbine in a radial direction with respect to the shaft, and is discharged in an axial direction. Francis turbines will operate from 10 feet to 2,000 feet of head and can be as large as 800 megawatts.

### Propeller Turbine

A propeller has a runner with three to six fixed blades, like a boat propeller. The water passes through the runner and drives the blades. Propeller turbines can operate from 10 feet to 300 feet of head and can be as large as 100 megawatts. A Kaplan turbine is a type of propeller turbine in which the pitch of the blades can be changed to improve performance. Kaplan turbines can be as large as 400 megawatts.

## Issues

### Environmental Issues and Mitigation

Current hydropower technology, while essentially emission-free, can have undesirable environmental effects, such as fish injury and mortality from passage through turbines, as well as detrimental effects on the quality of downstream water. A variety of mitigation techniques are in use now, and environmentally friendly turbines are under development.

### Legal and Institutional Issues

Legal and institutional issues include federal licensing as well as state and local permits, laws for historic and cultural preservation, and recreational requirements.



[Webmaster](#)

| [Security](#)

& [Privacy](#) |

[EERE](#)

[Home](#)

U.S.  
Department  
of Energy

Content

Last

Updated:

08/31/2004



## Ocean

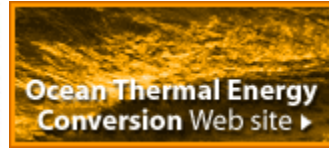

### Ocean Organizations & Resources

- ▶ [U.S. Department of Energy](#)
- ▶ [U.S. State & Local](#)
- ▶ [U.S. Trade & Nonprofit](#)
- ▶ [U.S. Universities and Research Institutes](#)
- ▶ [International Organizations](#)
- ▶ [Discussion Groups](#)
- ▶ [Newsletters & Magazines](#)
- ▶ [Products & Services](#)

## Ocean Topics

Ocean energy draws on the energy of ocean waves, tides, or on the thermal energy (heat) stored in the ocean.

[More basic information about ocean energy is also available.](#)

## Technologies

### [Wave Energy](#)

The total power of waves breaking on the world's coastlines is estimated at 2 to 3 million megawatts. In favorable locations, wave energy density can average 65 megawatts per mile of coastline.

### [Tidal Energy](#)

Tidal energy traditionally involves erecting a dam across the opening to a tidal basin. The dam includes a sluice that is opened to allow the tide to flow into the basin; the sluice is then closed, and as the sea level drops, traditional hydropower technologies can be used to generate electricity from the elevated water in the basin. Some researchers are also trying to extract energy directly from tidal flow streams.

### [Ocean Thermal Energy Conversion \(OTEC\) Systems](#)

A great amount of thermal energy (heat) is stored in the world's oceans. Each day, the oceans absorb enough heat from the sun to equal the thermal energy contained in 250 billion barrels of oil. OTEC systems convert this thermal energy into electricity — often while producing desalinated water.

### Ocean News

- [Wave Energy Device Provides Power to U.K. Grid](#)  
August 25, 2004
- [EIA: U.S. Renewable Energy Use Up 3 Percent in 2003](#)  
August 25, 2004
- [U.K. Provides \\$92-Million Fund to Advance Wave and Tidal Energy](#)  
August 11, 2004

[Webmaster](#)  
| [Security](#)  
& [Privacy](#) |  
[EERE](#)  
[Home](#)

U.S.  
Department  
of Energy

Content  
Last  
Updated:  
08/24/2004



## Solar



**Solar Energy Technologies Program Web Site** ▶

### Solar Organizations & Resources

- ▶ [U.S. Department of Energy](#)
- ▶ [U.S. Federal Government](#)
- ▶ [U.S. State & Local](#)
- ▶ [U.S. Trade & Nonprofit](#)
- ▶ [U.S. Universities and Research Institutes](#)
- ▶ [International Organizations](#)
- ▶ [Discussion Groups](#)
- ▶ [Newsletters & Magazines](#)
- ▶ [Products & Services](#)

## Solar Energy Topics

Solar technologies use the sun's energy and light to provide heat, light, hot water, electricity, and even cooling, for homes, businesses, and industry.

[More basic information about solar is also available.](#)

### Solar Technologies

#### [Photovoltaics \(PV\)](#)

Photovoltaic solar cells, which directly convert sunlight into electricity, are made of semiconducting materials. The simplest cells power watches and calculators and the like, while more complex systems can light houses and provide power to the electric grid.

#### [Passive Solar Heating, Cooling and Daylighting](#)

Buildings designed for passive solar and daylighting incorporate design features such as large south-facing windows and building materials that absorb and slowly release the sun's heat. No mechanical means are employed in passive solar heating. Incorporating passive solar designs can reduce heating bills as much as 50 percent. Passive solar designs can also include natural ventilation for cooling.

#### [Concentrating Solar Power](#)

Concentrating solar power technologies use reflective materials such as mirrors to concentrate the sun's energy. This concentrated heat energy is then converted into electricity.

#### [Solar Hot Water and Space Heating and Cooling](#)

Solar hot water heaters use the sun to heat either water or a heat-transfer fluid in collectors. A typical system will reduce the need for conventional water heating by about two-thirds. High-temperature solar water heaters can provide energy-efficient hot water and hot water heat for large commercial and industrial facilities.

## Issues

#### [Solar Resources](#)

Solar resource information provides data on how much solar energy is available to a collector and how it might vary from month to month, year to year, and location to location. Collecting this information requires a national network of solar radiation monitoring sites.

### Solar News

- [Colorado Utility Seeks 500 Megawatts of Renewable Energy](#)  
September 01, 2004
- [After 20 Years, California Solar Project Reaches 3.2 Megawatts](#)  
September 01, 2004
- [Arizona Utilities Expand Solar Energy Incentives](#)  
September 01, 2004

### [Solar Access](#)

The availability or access to unobstructed sunlight for use both in passive solar designs and active systems is protected by zoning laws and ordinances in many communities.

### [Green Power](#)

Consumer demand for clean renewable energy and the [deregulation](#) of the utilities industry have spurred growth in green power—solar, wind, geothermal steam, biomass, and small-scale hydroelectric sources of power. Small commercial solar power plants have begun serving some energy markets.

[Webmaster](#)

| [Security](#)

& [Privacy](#) |

[EERE](#)

[Home](#)

U.S.  
Department  
of Energy

Content

Last

Updated:

08/31/2004



## Wind



**Wind & Hydropower Technologies Program Web Site** ▶

### Wind Organizations & Resources

- ▶ [U.S. Department of Energy](#)
- ▶ [U.S. Federal Government](#)
- ▶ [U.S. State & Local](#)
- ▶ [U.S. Trade & Nonprofit](#)
- ▶ [U.S. Universities and Research Institutes](#)
- ▶ [International Organizations](#)
- ▶ [Discussion Groups](#)
- ▶ [Newsletters & Magazines](#)
- ▶ [Products & Services](#)

## Wind Energy Topics

Wind energy uses the energy in the wind for practical purposes like generating electricity, charging batteries, pumping water, or grinding grain. Large, modern wind turbines operate together in wind farms to produce electricity for utilities. Small turbines are used by homeowners and remote villages to help meet energy needs.

[More basic information about wind energy is also available.](#)

### Wind Energy Technologies

Modern wind turbines are divided into two major categories: horizontal axis turbines and vertical axis turbines. Old-fashioned windmills are still seen in many rural areas.

### Wind Turbine Use

Wind turbines are used around the world for many applications. Wind turbine use ranges from homeowners with single turbines to large wind farms with hundreds of turbines providing electricity to the power grid.

### Research

Research advances have helped drop the cost of energy from the wind dramatically during the last 20 years. Research is carried out by research labs, universities, and utility organizations.

### Wind Resource

The wind is the fuel source for wind energy. The United States has many areas with abundant winds, particularly in the Midwest and Great Plains. Understanding the wind resource is a crucial step in planning a wind energy project. Detailed knowledge of the wind at a site is needed to estimate the performance of a wind energy project.

### Environment

Wind energy is considered a green power technology because it has only minor impacts on the environment. Wind energy plants produce no air pollutants or greenhouse gases. However, any means of energy production impacts the environment in some way, and wind energy is no different.

### Economics

The cost of energy from the wind has dropped by 85% during the last 20 years. Incentives like the federal production tax credit and net metering provisions available in some areas improve the economics of wind energy.

### Wind News

- [Colorado Utility Seeks 500 Megawatts of Renewable Energy](#)  
September 01, 2004
- [EIA: U.S. Renewable Energy Use Up 3 Percent in 2003](#)  
August 25, 2004
- [California Approves New Transmission Line for Wind](#)  
August 18, 2004

[Webmaster](#)

| [Security](#)

& Privacy |

[EERE](#)

[Home](#)

U.S.  
Department  
of Energy

Content

Last

Updated:

08/31/2004



## Energy Education & Training

### Learning About Energy

Education Programs  
 Science Projects &  
 Activities  
 Lesson Plans &  
 Curriculum  
 Student Contests

### Student Resources for Reports on Energy

### Training & Careers

Continuing Education  
 Teacher Training  
 Careers & Jobs

### Higher Education Opportunities

Courses & Degrees  
 Internships &  
 Scholarships

### School Buildings & Buses

On this site you'll find links to educational and training resources on energy, particularly energy efficiency and renewable energy.



## Teachers and Parents

Find resources to help teach your students and children about energy. They can learn how energy works, how to conserve it, and how renewable energy helps our environment and energy security. You can also find energy educational opportunities for yourself.

## Students

Find ideas for energy-related science projects and resources to help you write reports on energy topics. If you're in high school, you can learn about energy careers and energy-related college degrees and programs. If you're in college, you can find information about energy-related internships and job listings.

## School Administrators

Find resources to help make your school buildings more energy efficient and about alternative fuel and vehicle technologies for school buses. You'll also find information on energy education programs.

## Energy Professionals

Find energy-related job listings and continuing education opportunities.

## Homeowners

Find training and classes to help you learn more about installing a renewable energy system in your home and about building energy-efficient homes.

 [Printable Version](#)

[Search Help](#) ► [More Search Options](#)

► [Search](#)

[EERE Information Center](#)

### FEATURES

Elementary Students  
**Dr. E's Energy Lab**



[Webmaster](#)

| [Security](#)  
& [Privacy](#) |

[EERE](#)

[Home](#)

U.S.  
Department  
of Energy

Content

Last

Updated:

08/19/2004





# Financing



**EERE**  
Information  
Center ▶

## Glossary of Terms

▶ A [glossary of terms](#) used in regards to energy-efficiency and renewable energy financing.

# Financing Solutions & Incentives

This site provides links to useful resources about financing and incentives for energy efficiency and renewable energy projects for the home, business, industry, utilities, and government.

## Homeowners

[Homeowners](#) can afford to take on energy efficiency and/or renewable energy projects with the help of the financing programs listed on this site. Find lenders and state-specific incentives as well as products and services to get you started.

## Small Businesses

If you have a [small business](#), you'll find that there are number of resources at your fingertips shifting toward energy efficiency and renewable energy sources. Loans and incentives are just a couple of the options available.

## Industry

For [industry](#), if you're trying to finance a new concept or idea for relating to energy efficiency or clean energy, check out the programs that will provide grants or seed money to set your idea in motion.

## Utilities

[Utilities](#) interested in generating or buying electricity from renewable energy sources can find information on financing, including incentives, experiences of other utility companies, and tools to measure efficiencies.

## State/Local Programs

[State and local](#) community programs can find effective financing solutions to lower costs and environmental impact. In addition, there's information on state-specific programs that fund sustainable energy initiatives and enterprises.

## Federal Buildings



In [federal buildings](#), a focus on energy efficiency and renewable energy helps the government reduce its costs. The Federal Energy Management Program lists a number of resources.

## **International**

For [international](#) renewable energy and energy efficiency projects, you can learn from examples of innovative financing solutions from around the world.

[Webmaster](#)

| [Security](#)

& [Privacy](#) |

[EERE](#)

[Home](#)

U.S.  
Department  
of Energy

Content

Last

Updated:  
02/18/2004



## About the Office of EERE

[Mission](#)[Strategic Plan](#)[Organization](#)[Contacts](#)[Budget](#)[Congressional Testimony](#)[Business Administration](#)[Solicitations](#)[Program Partners](#)[State Agreements](#)[Communication Standards](#)

In support of Secretary of Energy Spencer Abraham's Smart Energy Campaign to bring energy saving tips to Americans, the Office of Energy Efficiency and Renewable Energy (EERE) would like to draw your attention to our new consumer-oriented [Energy](#)

[Savers Website](#). We have created this site to help home and business owners reduce their use of natural gas and electricity. The many benefits of conservation include environmental benefits and consumer protection from rising energy costs.

Whether you rent, own a business, or run an industrial facility, you'll find cost-effective ways to manage energy in the [Energy Tips](#) section of the Web site. If you are a homeowner, you'll be able to download the [Energy Savers Booklet](#) from the site to find easy ways to help you reduce your home's energy use. You'll also find sections on how to purchase green power and how to make your own electricity from small wind and solar photovoltaic systems.

We at EERE offer this practical hands-on energy saving information to you, America's homeowners and business owners, and we ask you to join us as we pursue our vision of a prosperous future where energy is clean, abundant, reliable, and affordable.

 [Printable Version](#)



**David Garman**  
Assistant Secretary

[Search Help](#) ► [More Search Options](#)

► [Search](#)

[EERE Information Center](#)

### ■ NEWS

[DOE Awards \\$16 Million for 162 Efficiency, Renewable Energy Projects](#)

August 09, 2004

[DOE Begins Process to Set New Efficiency Standards for Energy Equipment](#)

July 30, 2004

[DOE Awards \\$94.8 Million to Weatherize Homes in 20 States](#)

July 29, 2004

[More EERE News](#)

### ■ FEATURES

**FY 2005  
EERE  
Budget-in-Brief**



[Webmaster](#)

| [Security & Privacy](#) |  
[EERE](#)  
[Home](#)

U.S.  
Department  
of Energy

Content  
Last  
Updated:

08/13/2004



# Biomass Program

[About the Program](#) | [Program Areas](#) | [Information Resources](#) | [Financial Opportunities](#) | [Technologies Deployment](#)

[Biomass Benefits](#) ▶  
[Biomass Today](#) ▶  
[Feedstocks](#) ▶  
[Conversion Technologies](#)  
     [Thermochemical Platform](#) ▶  
     [Sugar Platform](#) ▶  
[Products R&D](#) ▶  
[Integrated Biorefineries](#) ▶  
[Biomass Document Database](#) ▶

The U.S. Department of Energy (DOE) Biomass Program develops technology for conversion of biomass (plant-derived material) to valuable fuels, chemicals, materials and power, so as to reduce dependence on foreign oil and foster growth of biorefineries. Biomass is one of our most important energy resources. The largest U.S. renewable energy source every year since 2000, it also provides the only renewable alternative for liquid transportation fuel. Biomass use strengthens rural economies, decreases America's dependence on imported oil, avoids use of MTBE or other highly toxic fuel additives, reduces air and water pollution, and reduces greenhouse gas emissions. Today's [biomass uses](#) include [ethanol](#), [biodiesel](#), [biomass power](#), and [industrial process energy](#).

Tomorrow, [biorefineries](#) will use advanced technology such as [hydrolysis of cellulosic biomass to sugars and lignin](#) and [thermochemical conversion](#) of biomass to synthesis gas for fermentation and catalysis of these platform chemicals to produce slates of biopolymers and fuels. To expand the role of biomass in America's future, the DOE Office of the Biomass Program fosters biomass technologies with a balanced portfolio of research and development. While there are various other technologies for biomass conversion, the following graphic shows those that the Biomass Program is concentrating on, as outlined in its Multi-Year Technical Plan ([PDF 62.3 MB](#)) or summary ([PDF 228 KB](#)). [Download Acrobat Reader](#).

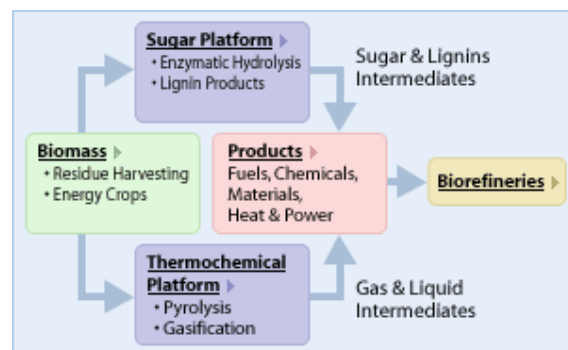

[Printable Version](#)

[Search Help](#) ▶ [More Search Options](#)

▶ [Search](#)

[EERE Information Center](#)

## NEWS

[EPA, GSA, and World Bank Seek to Buy Renewable Energy Credits](#)

August 11, 2004

[DOE Awards \\$16 Million for 162 Efficiency, Renewable Energy Projects](#)

August 9, 2004

[DOE and USDA Award \\$25 Million for Biomass Initiative](#)

July 16, 2004

[More News](#)

## EVENTS

[National Biodiesel Conference & Expo](#)

January 31, 2005 -  
February 2, 2005

[More Events](#)

## INFORMATION FOR

[Industry](#)

[Researchers](#)

[Policymakers](#)

[Consumers](#)

[Students](#)

## FEATURES

**Resources  
for  
Researchers**



[Webmaster](#)

| [Security](#)

& [Privacy](#) |

[EERE](#)

[Home](#)

U.S.  
Department  
of Energy

Content

Last

Updated:

August 11,  
2004



# Building Technologies Program

[About the Program](#) | [Program Areas](#) | [Information Resources](#) | [Financial Opportunities](#) | [Technologies Deployment](#)

## Research That Works!

DOE's Building Technologies Program works to improve the energy efficiency of our nation's buildings through innovative new technologies and better building practices.

[Research activities](#) advance the next generation of energy-efficient components, equipment, and materials, plus a whole-building approach that optimizes building performance and savings.

[Regulatory activities](#) improve building codes, appliance and equipment standards, and guidelines for efficient energy use.

Energy-efficient buildings use less energy and cost less to operate, saving money for homeowners and businesses alike. They also help the environment and our nation, improving our energy security as well as the everyday lives of Americans.

[Printable Version](#)

**Energy Solutions For Your Building**



- [Homes](#)
- [Multifamily](#)
- [Office](#)
- [Retail](#)
- [Health Care](#)
- [Lodging](#)
- [School](#)
- [University](#)
- [Government](#)
- [High Performance](#)

**Building Toolbox**



**A comprehensive guide for creating more efficient, affordable buildings**

- [Plan & Finance](#)
- [Design, Construct & Renovate](#)
- [Choose Building Components](#)
- [Operate & Maintain](#)
- [Software Tools](#)

[Search Help](#) ▶ [More Search Options](#) ▶  
 Search

[EERE Information Center](#)

### NEWS

[California Plans to Install Solar Power on One Million Homes](#)

August 25, 2004

[Building Technologies Program Constructs a New Web Site](#)

August 25, 2004

[New High-Efficiency High-Rise Breaks Ground in Manhattan](#)

August 11, 2004

[More News](#)

### EVENTS

[Remodeling Show 2004](#)

October 6-9, 2004

[More Events](#)

### FEATURES

**ENERGY SAVERS**

A consumer guide to saving energy and money in your home or business.

[Webmaster](#) |

[Security &](#)

[Privacy](#) |

[Building](#)

[Technologies](#)

[Program](#)

[Home](#) |

[EERE Home](#)

U.S.

Department  
of Energy

Content Last

Updated:

07/08/2004





# Distributed Energy Program

[About the Program](#) | [Program Areas](#) | [Information Resources](#) | [Financial Opportunities](#) | [Technologies](#) | [Deployment](#)

[Search Help](#) ▶ [More Search Options](#) ▶

[Site Map](#)

[EERE Information Center](#)

## ■ NEWS

[Two New Regional Combined Cooling, Heating and Power \(CHP\) Applications Centers are Announced](#)

August 9, 2004

[More News](#)

[Program Specific News...](#)

[Related News and Events...](#)

## ■ EVENTS

[5th Annual CHP Roadmap Workshop](#)

September 20-21, 2004

[More Events](#)

## ■ FEATURES

## Distributed Energy Technologies ▶

The Distributed Energy Technologies Subprogram supports research and development on a variety of small, modular energy generation devices including [reciprocating engines](#), [industrial turbines](#), [microturbines](#), and [thermally activated equipment](#). This equipment can be used by manufacturing plants, industrial facilities, commercial businesses, schools, hospitals, government agencies, and electric and gas utilities to reduce costs and environmental impacts, and increase electric reliability, power quality, and energy security.

## End-Use System Integration and Interface

The End-Use System Integration and Interface Subprogram supports research and development to assess the energy efficiency, economic, and environmental impacts of distributed energy technologies in a variety of applications and system configurations. Such configurations include [combined heat and power](#), on-site energy management, and demand response for peak load management.

*Distributed Energy offers solutions to many of the nation's most pressing energy and electric power problems, including blackouts and brownouts, energy price spikes, energy security concerns, power quality issues, rising energy costs, tighter emission standards, transmission bottlenecks, and the desire for greater control over energy costs. Distributed energy systems may be used by both energy producers and consumers, including electric and gas utilities, manufacturing plants,*



*industrial process industries, commercial buildings, schools, hospitals, and government agencies.*

Distributed energy systems have the potential to be a least-cost energy solution for meeting many types of energy needs. For example:

- power companies can install distributed energy systems in grid congested areas and operate them during peak periods
- facilities with needs for heating, cooling, and electric power can install combined heat and power systems or thermally activated heating and cooling devices to boost energy efficiency and reduce upstream

electricity needs

- businesses with needs for extremely high reliability (i.e. silicon chip manufacturing, financial centers, server farms, etc.), can install distributed energy systems to ensure that power is available whenever it is needed

Unfortunately, technical, economic, regulatory, and institutional barriers sometimes interfere with the installation of these technologies. That is why the DE Program has been established. The Distributed Energy Program supports cost-effective research and development programs aimed at lowering costs, reducing emissions, and improving reliability and

performance to expand opportunities for the installation of cost effective distributed energy equipment today and in the future.

 [Printable Version](#)

[Webmaster](#)

| [Security & Privacy](#) |

[EERE](#)

[Home](#)

U.S.  
Department  
of Energy

Content

Last

Updated:

07/13/2004



# Federal Energy Management Program

[About the Program](#) | [Program Areas](#) | [Information Resources](#) | [Financing Mechanisms](#) | [Technologies Services](#)

[Search Help](#) ▶ [More Search Options](#) ▶

[Site Map](#)

[EERE Information Center](#)

## ■ NEWS

[Federal Government Issues Six RFPs for Renewable Energy Certificates](#)

August 6, 2004

[DOE Proposes New Efficiency Standards for Energy Equipment](#)

August 4, 2004

[More News](#)

## ■ EVENTS

[FEMP Lights On-Line Course](#)

Ongoing

[5th Annual CHP Roadmap Workshop](#)

September 20-21, 2004

[More Events](#)

## ■ FEATURES

**2004 FEDERAL ENERGY AND WATER MANAGEMENT AWARDS**

**October is ENERGY AWARENESS MONTH**

As the largest energy consumer in the United States, the federal government has both a tremendous opportunity and a clear responsibility to lead by example with smart energy management. By promoting energy efficiency and the use of renewable energy resources at federal sites, the Federal Energy Management Program helps agencies save energy, save taxpayer dollars, and demonstrate leadership with responsible, cleaner energy choices.

About the Program: Learn more about FEMP, who to contact for help, and interagency working groups. [More](#)

Program Areas: Find out how to be smart about energy whether you're involved in construction, procurement, utility management, or operations and maintenance. [More](#)

Information Resources: Find publications, software, awareness materials, and other resources. [More](#)

Financing Mechanisms: Find out how to finance energy improvement projects. [More](#)

Technologies: Learn about energy efficient, renewable, distributed generation and combined heat and power, and water saving products for your

## Equipment Procurement ▶

Use FEMP's product recommendations and other useful tips to help you buy the most efficient equipment for your offices and facilities.

## New Construction / Retrofits ▶

Learn about how to design high performance buildings that save energy, save money, enhance indoor environmental quality, and help preserve the environment.

## Operations & Maintenance ▶

Learn how effective operations and maintenance can help you ensure reliability, safety, and energy at relatively low cost.

## Utility Management ▶

Find up to date information about energy markets, utility restructuring, renewable power purchasing, and load management opportunities that can help you manage costs, improve reliability, and reduce environmental impacts.

facilities. [More](#)

Services: Find out how FEMP can help you with assessment, project assistance and facilitation, utility management, training, and other outreach activities. [More](#)

 [Printable Version](#)

[Webmaster](#)

| [Security](#)  
& [Privacy](#) |

[EERE](#)

[Home](#)

U.S.  
Department  
of Energy

Content

Last

Updated:

08/06/2004



# FreedomCAR & Vehicle Technologies Program

[About the Program](#) | [Program Areas](#) | [Information Resources](#) | [Financial Opportunities](#) | [Technologies Deployment](#)

## Vehicle Systems ▶

Technologies that will significantly improve fuel economy, comply with projected emissions and safety regulations, and use domestically produced fuels

## Materials ▶

Lightweight, high-strength materials for improved energy efficiency without compromising safety, performance, recyclability, and cost

## Fuels ▶

New fuels and lubricants that can reduce our dependence on petroleum-based products with fewer environmental impacts

## Engines & Emission Control ▶

Innovative strategies for gasoline- and diesel-powered engines that offer efficiency and emissions improvements

 [Printable Version](#)

The FreedomCAR and Vehicle Technologies Program serves as the Executive Secretariat for the federal government for the [FreedomCAR and Fuel Partnership](#) and the [21st Century Truck Partnership](#), as well as conducting technical research and development activities that support these partnerships.

## FreedomCAR and Fuel Partnership

FreedomCAR is neither a car nor a prototype — instead, it represents a new approach to powering the vehicles of the future. The "CAR" in FreedomCAR stands for Cooperative Automotive Research between the U.S. Department of Energy, the U.S. Council for Automotive Research, and the energy industry.

FreedomCAR focuses government support on fundamental, high-risk research that applies to multiple passenger-vehicle models and emphasizes the development of fuel cells and hydrogen infrastructure technologies.

## 21st Century Truck Partnership

Addressing the challenges facing today's heavy-duty transportation sector requires that industry and government work together as partners to find new technologies and approaches for the future.

The 21st Century Truck Partnership brings together 16 industrial partners

[Search Help](#) ▶ [More Search Options](#) ▶  
Search

[Site Map](#)

[EERE Information Center](#)

### ■ NEWS

[GM Provides Hybrid Vehicles to the Republican National Convention](#)

August 25, 2004

[Report Shows Progress of Advanced LNG Technology in Heavy-Duty Trucks](#)

August 10, 2004

[DOE-funded Research Sparks Development of Manufacturing Technology Used in 2004 GM Production Vehicles](#)

July 27, 2004

[More News](#)

### ■ EVENTS

[43rd Annual International Trucking Show](#)

September 23-25, 2004

[More Events](#)

### ■ FACT OF THE WEEK

[Fact of the Week:](#) World Oil Reserves, Production, and Consumption, 2003

September 6, 2004

[More Facts](#)

### ■ FEATURES



**Oak Ridge Lab  
Assists NASCAR Teams**

and four federal government departments. Through cooperative research, the partners are developing a balanced portfolio of projects aimed at achieving key goals, coordinating their research activities as appropriate, and making effective use of the nation's research universities and national laboratories.



[Webmaster](#)  
| [Security](#)  
& [Privacy](#) |  
[EERE](#)  
[Home](#)

U.S.  
Department  
of Energy

Content  
Last  
Updated:  
September  
1, 2004





# Geothermal Technologies Program

[About the Program](#) | [Program Areas](#) | [Information Resources](#) | [Financial Opportunities](#) | [Technologies Deployment](#)

[Search Help](#) ► [More Search Options](#)

► [Search](#)

[EERE Information Center](#)

## ■ NEWS

[DOE Announces GRED-III and State Energy Program Grant Awardees](#)

August 11, 2004

[Public Renewables Partnership Informs Utilities About Renewable Energy](#)

August 11, 2004

[More News](#)

## ■ EVENTS

[2004 Geothermal Resources Council Annual Meeting and Geothermal Energy Trade Show](#)

August 29 — September 1, 2004

[More Events](#)

## ■ FEATURES

**Geothermal Resources Map**



**GEOPOWERING THE WEST**

**Why Geothermal?**

Utilities  
States

Environmental Groups



EERE's Geothermal Technologies Program works in partnership with U.S. industry to establish geothermal energy as an economically competitive contributor to the U.S. energy supply.

For more information on the Geothermal Technologies Program's key activities, see the Program Fact Sheet ([PDF 298 KB](#)) [Download Acrobat Reader](#).

[Printable Version](#)

## What is Geothermal Energy?

- [Geothermal basics](#), [FAQs](#), [history](#), [glossary](#), etc.
- Links for [homeowners](#), [industry](#) and [education](#)
- [Energy systems](#), [exploration and drilling](#), and [geoscience](#)
- [GeoPowering the West](#)
- [Power plants](#), [direct use](#), and [heat pumps](#)
- [Environmental impacts](#)
- [Economic impacts](#)
- [Laws and standards](#)



The Mammoth Pacific geothermal power plant, in northern California.

Information on the US Navy's Geothermal Program, A GAO Report ([PDF 1.8 MB](#)) [Download Arobat Reader](#).

[Webmaster](#)

| [Security](#)

& [Privacy](#) |

[EERE](#)

[Home](#)

U.S.  
Department  
of Energy

Content

Last

Updated:

August 11,  
2004



# Hydrogen, Fuel Cells & Infrastructure Technologies Program

[About the Program](#) | [Program Areas](#) | [Information Resources](#) | [Financial Opportunities](#) | [Technologies](#) | [Deployment](#)

[Search Help](#) ▶ [More Search Options](#)

▶ [Search](#)

[EERE Information Center](#)

## ■ NEWS

[DOE Discontinues On-Board Fuel Processor R&D](#)

August 6, 2004

[Secretary Abraham Announces Hydrogen Storage "Centers of Excellence"](#)

April 28, 2004

[More News](#)

## ■ EVENTS

[2004 Fuel Cell Seminar](#)

November 1-5, 2004

[More Events](#)

## ■ KEY PUBLICATIONS

[Program Guiding Documents](#)

[Hydrogen Publications](#)

[Fuel Cell Publications](#)

[Educational Materials](#)

[More Publications](#)

## ■ FEATURE

 Read and Review the **Multi-Year RD&D Plan**

Hydrogen and fuel cells have the potential to solve several major challenges facing America today: dependence on petroleum imports, poor air quality, and greenhouse gas emissions. The Hydrogen, Fuel Cells & Infrastructure Technologies Program is working with partners to accelerate the development and successful market introduction of these technologies.

## Learn About

### Site Updates

> [Proceedings of the HFCIT 2004 Annual Review](#)

> [Fuel Cell Vehicle Survey 2003](#)

> [\\$350 Million Awarded for Hydrogen Research](#)

> [New Solid Oxide Fuel Cell Solicitation](#)

### How a fuel cell works

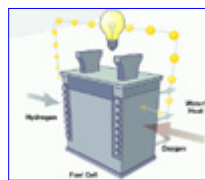

View our fuel cell animation to learn how a fuel cell uses hydrogen to produce electricity.

### Sign up for on-line news

[Register](#) with us if you'd like to receive current news—including notices about new reports, upcoming meetings, or solicitations issued—via email from DOE's Hydrogen, Fuel Cells & Infrastructure Technologies Program.

 [Printable Version](#)

[Webmaster](#)

| [Security](#)

& [Privacy](#) |

[EERE](#)

[Home](#)

U.S.  
Department  
of Energy

Content

Last

Updated:

07/13/2004



# Industrial Technologies Program

[About the Program](#) | [Program Areas](#) | [Information Resources](#) | [Financial Opportunities](#) | [Technologies Deployment](#)

The Industrial Technologies Program partners with U.S. industry to improve industrial energy efficiency and environmental performance. The program's primary role is to invest in high-risk, high-value research and development that will reduce industrial energy requirements while stimulating economic productivity and growth.

## Industrial Technology R&D ▶

Through a coordinated research and development (R&D) effort, the Industrial Technologies Program invests in leapfrog technologies that will produce dramatic energy and environmental benefits. Reducing industrial energy requirements will lower costs, reduce greenhouse gases and other emissions, and improve productivity.

## Industries of the Future ▶

Collaborative R&D partnerships are integral to advancing the Industrial Technologies Program mission. Through a process known as Industries of the Future, the Industrial Technologies Program partners with the most energy-intensive industries to effectively plan and implement a comprehensive R&D agenda. These vital industries—[aluminum](#), [chemicals](#), [forest products](#), [glass](#), [metal casting](#), [mining](#), [petroleum](#), and [steel](#)—account for the majority of industrial energy consumption, and represent the greatest opportunities to increase industrial energy efficiency.

## Crosscutting Technologies ▶

Crosscutting R&D targets efficiency opportunities in the use of enabling technologies that are common to many industrial processes. The widespread application of crosscutting technologies such as

## ■ FEATURED NEWS

Friday, August 13, 2004

### New Motor Master+ International Helps Evaluate Motors System Savings Potential

Motor systems account for approximately two-thirds of electricity used in industrial facilities. For manufacturers worldwide, this high level of energy use need not be a fact of production. Instead, it represents an efficiency opportunity in the making; and improved motor management practices could be the key that unlocks tremendous energy savings and emissions reductions.

To further assist energy managers with motor management decisions, the U. S. Department of Energy (DOE) announces a new international version of its popular MotorMaster+ software tool. The new tool, MotorMaster+ International, includes many of the capabilities and features of MotorMaster+; however

[Search Help](#) ▶ [More Search Options](#)

▶ [Search](#)

[Site Map](#)

[EERE Information Center](#)

## ■ NEWS

[DOE Releases CHP Guide for Boiler Owners and Operators](#)

September 2, 2004

[EIA Examines the Long-Term Longevity of Petroleum](#)

September 1, 2004

[Footprints Map Energy Efficiency Opportunities in U.S. Manufacturing & Mining](#)

August 20, 2004

[More News](#)

## ■ EVENTS

[Process Heating Assessment](#)

September 9, 2004

[More Events](#)

## ■ FEATURES

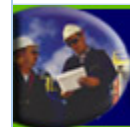

Partnering for Success  
**Featured Partner**

Industrial Technologies  
 releases its  
**Strategic Plan**

**Manufacturers:**  
**Lower Your Energy Bill ▶**

[combustion](#), [materials](#), [sensor and process control systems](#), and [industrial energy systems](#) such as combined heat and power provide the opportunity for small improvements to yield large energy savings.

### **Grand Challenges** ▶

Next generation manufacturing concepts often involve one or more core technology challenges that, if solved, can produce dramatic improvements in energy efficiency, environmental performance, and product quality. The emphasis on these "grand challenges" in the Industrial Technologies portfolio is expected to result in high-value projects that will yield substantial energy, environmental, and economic benefits.

 [Printable Version](#)

users can now conduct repair/replacement analysis on a broader range of motors. This includes motors tested under the Institute of Electrical and Electronic Engineers (IEEE) standard, and those tested using International Electrical Commission (IEC) methodology. This capability will be of great use to companies with overseas operations that are interested in improving motor system efficiency.

[More...](#)

### **BestPractices in Energy Management** ▶

The Industrial Technologies Program also offers energy saving solutions that can be implemented right away. Technical assistance activities such as [plant assessments](#), [system optimization software tools](#), [training](#), [information and technology dissemination](#), and [showcase demonstrations](#) are all available to stimulate near-term adoption of energy management best practices and technologies.

We invite you to explore the wide range of opportunities available to you and your industry to partner with the Industrial Technologies Program.

[Webmaster](#)  
| [Security & Privacy](#)  
[EERE](#)  
[Home](#)

U.S.  
Department  
of Energy

Content  
Last  
Updated:  
08/26/2004



# Solar Energy Technologies Program

[About the Program](#) | [Program Areas](#) | [Information Resources](#) | [Financial Opportunities](#) | [Technologies Deployment](#)

[Search Help](#) ► [More Search Options](#)

► [Search](#)

[EERE Information Center](#)

## ■ NEWS

[After 20 Years, California Solar Project Reaches 3.2 Megawatts](#)

September 1, 2004

[Solar Car Sets Record Distance, but Tragedy Mars Related Tour](#)

September 1, 2004

[Arizona Utilities Expand Solar Energy Incentives](#)

September 1, 2004

[More News](#)

## ■ EVENTS

[Solar Power 2004](#)

October 18-21, 2004

[DOE Solar Program Review Meeting](#)

October 25-28, 2004

[More Events](#)

## ■ FEATURES

### Got Solar?

Learn more about how you can use solar.



### Program Plan

(PDF 4.5 MB)

[Download Acrobat Reader](#)



## Concentrating Solar Power ►

CSP systems use reflective materials that concentrate the sun's heat energy to drive a generator that produces electricity.

## Photovoltaics ►

PV systems use semiconductor materials that convert sunlight directly to electricity.

## Solar Heating ►

Solar collectors absorb the sun's energy to provide low-temperature heat used directly for hot water or space heating for residential or commercial buildings.

## Solar Lighting ►

Parabolic collectors focus sunlight into a fiber optic system to illuminate building interiors with sunlight.

Welcome to the Web site for the Solar Energy Technologies program, one of 11 programs within the U.S. Department of Energy's Office of Energy Efficiency and Renewable Energy. We focus on developing solar energy technologies to power our world. We are motivated by a belief that science and technology, guided by purpose and vision, can deliver new energy resources that are clean, reliable, and secure.

The sun is the primary source for most forms of energy found on Earth. Solar energy is clean, abundant, widespread, and renewable. Various technologies capture this solar energy, concentrate it, store it, and convert it into other useful forms of energy:

- Low-grade thermal energy for heating our homes and businesses
- Medium-grade thermal energy for running some industrial processes
- High-grade thermal energy for driving turbines to generate electricity
- Electrical energy, converted directly from sunlight, to provide electricity for all of its myriad applications and even
- Chemical energy in hydrogen (via water splitting using

photovoltaic or thermochemical processes to split water), for use in fuel cells and a broad range of electrical, heating, and transportation applications.

Solar energy technologies have great potential to benefit our nation. They can diversify our energy supply, reduce our dependence on imported fuels, improve the quality of the air we breathe, offset greenhouse gas emissions, and stimulate our economy by creating jobs in the manufacturing and installation of solar energy systems.

 [Printable Version](#)

[Webmaster](#)

| [Security & Privacy](#) |

[EERE](#)

[Home](#)

U.S.  
Department  
of Energy

Content

Last

Updated:  
September  
1, 2004





# Weatherization & Intergovernmental Program

[About the Program](#) | [Program Areas](#) | [Information Resources](#) | [Financial Opportunities](#)

## Smart energy choices for...

### ▶ [Business & Commercial Buildings](#)

Energy assessment and management strategies, plus technologies and tools to create high performance buildings.

### ▶ [Homes](#)

Improving home energy performance, building new homes, finding ENERGY STAR products, and Weatherization assistance.

### ▶ [International](#)

Guidance for developing and implementing energy policy and projects.

### ▶ [Schools, Colleges & Universities](#)

Design guidelines for building high performance schools, plus simple energy improvements and hands-on teaching tools.

### ▶ [States, Communities & Local Governments](#)

Strategies for sustainable growth and development, resource efficiency, and economic development.

### ▶ [Transportation](#)

Information and tools for deploying alternative fuel vehicles, fleets, and supporting infrastructure.

### ▶ [Tribal Energy](#)

Promoting energy self-sufficiency and economic development on tribal lands.

## Where do I find...

### ▶ [Information, Tools and Technical Assistance?](#)

Resources to help you make energy-smart choices.

### ▶ [Weatherization assistance?](#)

Helping low-income families reduce their energy bills.

### ▶ [Financial Opportunities?](#)

Solicitations and grants for energy-saving projects and products.

### ▶ [Business development opportunities?](#)

Market assessments and commercialization models for new energy products, plus export assistance.

### ▶ [Information on policies and codes?](#)

Developing and implementing energy policy, plus the latest on building energy codes.

### ▶ [Partnership opportunities?](#)

How states, local governments, businesses, and associations become energy-saving partners with DOE.

[Search Help](#) ▶ [More Search Options](#)

▶ [Search](#)

[Site Map](#)

[EERE Information Center](#)

## ■ NEWS

[EPA Recognizes IdleAire for Anti-Idling Efforts](#)

May 19, 2004

[Solar Panels Teach While Generating Electricity](#)

June 18, 2004

[ENERGY STAR Extends Deadline for Awards Program](#)

June 18, 2004

[More News](#)

## ■ EVENTS

[World Renewable Energy Congress](#)

August 28, 2004 -  
September 3, 2004

[More Events](#)

## ■ FEATURES

[Locate Your State & Regional Contacts](#)



[Learn More About DOE Energy Research](#) ▶

[Find Information, Tools & Technical Assistance](#) ▶

## Program Areas

[Building Energy Codes](#)[Inventions and](#) [Tribal Energy](#)  
[Clean Cities](#) [Innovation](#) [Activities](#)  
[ENERGY STAR](#) [NICE3](#) [Weatherization](#)  
[International Activities](#) [Rebuild America](#) [Assistance](#)  
[State Energy Program](#)

 [Printable Version](#)

[Webmaster](#)

| [Security](#)  
& [Privacy](#) |

[EERE](#)

[Home](#)

U.S.  
Department  
of Energy

Content

Last

Updated:

June 18,  
2004



# Wind & Hydropower Technologies Program

[About the Program](#) | [Program Areas](#) | [Information Resources](#) | [Financial Opportunities](#) | [Technologies Deployment](#)

## Wind Energy

Wind energy is the world's fastest-growing energy technology. Today, the U.S. has more than 6,300 megawatts of



wind generating capacity. The Wind and Hydropower Technologies Program works with industry to develop the advanced technology needed to convert more of the nation's wind into electricity.

## Selected Wind Energy Topics

- [Wind Resources in the Upper Midwest](#)
- [Wind Energy Basics](#)
- [Low Wind Speed Turbine Technology](#)
- [Distributed Wind Energy Technology](#)
- [Wind Powering America](#)
- [Systems Integration](#)
- [Offshore Wind Turbines](#)
- Wind Energy Program Multi Year Technical Plan for 2004 - 2010 ([PDF 2.5 MB](#))  
[Download Acrobat Reader.](#)

## Hydropower

With 80,000 megawatts of generating capacity, hydropower is the nation's largest renewable electricity source. Working



with industry, the Wind and Hydropower Technologies Program pursues R&D to develop more environmentally friendly technologies to maintain the nation's existing hydropower capacity.

## Selected Hydropower Topics

- [Hydropower Basics](#)
- [Advanced Turbine Development](#)
- [Hydropower Integration with other Renewables](#)
- [Low-Head, Low-Power Resource Assessment](#)

[Search Help](#) ► [More Search Options](#)

► [Search](#)

[EERE Information Center](#)

### NEWS

[Colorado Utility Seeks 500 Megawatts of Renewable Energy](#)

September 1, 2004

[EIA: U.S. Renewable Energy Use Up 3 Percent in 2003](#)

August 25, 2004

[California Approves New Transmission Line for Wind](#)

August 18, 2004

[More News](#)

### EVENTS

[NASEO 2004 Annual Meeting](#)

September 28-30, 2004

[More Events](#)

### FEATURES

How a  
**Wind Turbine**  
Works



[Printable Version](#)

[Webmaster](#)

| [Security](#)

& [Privacy](#) |

[EERE](#)

[Home](#)

U.S.  
Department  
of Energy

Content

Last

Updated:  
September

01, 2004



## About the Office of EERE

[◀ About the Office Home](#)[Mission](#)[Strategic Plan](#)[Organization](#)[Contacts](#)[Budget](#)[Congressional Testimony](#)[Business Administration](#)[Program Execution Support](#)[Planning](#)[Budget Formulation](#)[Budget Execution](#)[Performance & Evaluation Analysis](#)[Information & Business Management](#)[Solicitations](#)[Program Partners](#)[State Agreements](#)[Communication Standards](#)

# Business Administration

The Deputy Assistant Secretary for Business Administration (DAS-BA) is the central organization for all EERE business products, processes, and systems. It provides a full suite of business services to EERE's Assistant Secretary, Board of Directors, Office of Communications and Outreach, Deputy Assistant Secretary for Technology Development, and Program Management Offices.

See the BA organizational chart ([PDF 44 KB](#)).  
[Download Acrobat Reader](#)

The DAS-BA is supported by three offices:

- [Program Execution Support](#)  
(administrative management policy direction and support – logistics – procurement and loan guarantee procedures - data entry support – contractor performance analysis – human resources – travel – training – space – records management – security)
- [Planning, Budget and Analysis](#)  
(corporate budget and Government Performance and Results Act (GPRA) – including budget development and execution; multi-year and strategic planning; performance and evaluation; benefits estimates and portfolio assessment; data; and corporate, crosscutting, and policy analysis)
  - [Planning](#)  
(corporate strategic planning and portfolio assessment, program multi-year planning)
  - [Budget Formulation](#)  
(corporate budget formulation, portfolio analysis)
  - [Budget Execution](#)  
(budget funding action documents, procurement and loan guarantee procedures, annual operating plans, fund transfers to laboratories, contractor budget data analysis)

[Search Help](#) ▶ [More Search Options](#)▶ [Search](#)[EERE Information Center](#)

### ■ NEWS

[DOE Awards \\$16 Million for 162 Efficiency, Renewable Energy Projects](#)

August 09, 2004

[DOE Begins Process to Set New Efficiency Standards for Energy Equipment](#)

July 30, 2004

[DOE Awards \\$94.8 Million to Weatherize Homes in 20 States](#)

July 29, 2004

[More EERE News](#)

### ■ FEATURES

**EERE Program Fact Sheets**

- [Performance and Evaluation](#)  
(annual performance plan facilitation, quarterly program performance reporting, accountability submissions, Program Assessment Rating Tool (PART) and related President's Management Agenda (PMA) and other performance documents)
- [Analysis](#)  
(data, facilitation of program evaluation, market analysis, benefits analysis, other corporate and crosscutting analysis, policy analysis)

- [Information and Business Management Systems](#)

(e-Government and program management systems collaboration – information technology systems development and maintenance – cyber security for EERE information systems – safety management and NEPA compliance – evaluation of EERE work by the National Labs – evaluation of National Lab facility requirements – analyses and management reviews of EERE programs – coordination of program and project management training)

DAS-BA also oversees the activities of the [Golden Field Office](#)

 [Printable Version](#)

[Webmaster](#)  
| [Security & Privacy](#) |  
[About the Office](#)  
[Home](#) |  
[EERE Home](#)

U.S.  
Department  
of Energy

Content  
Last  
Updated:  
04/30/2004



## Golden Field Office

[About the Office](#)

[Business Opportunities](#)

[Career Opportunities](#)

[Newsroom](#)

[Projects](#)

[Public Reading Room](#)

[Related Links](#)

[Search Help](#) ▶ [More Search Options](#) ▶

[Search](#)

[EERE Information Center](#)

The Golden Field Office works to bring renewable energy resources, such as wind and solar power, to the world. As the primary field agent for the U.S. Department of Energy's Office of Energy Efficiency and Renewable Energy (EE), Golden builds partnerships with the private sector to develop and transfer energy efficiency and renewable energy technologies.

By partnering with emerging industries and with universities, Golden develops and manages cost-shared projects that transfer technologies to the marketplace. Golden works closely with EE's six regional offices, the National Renewable Energy Laboratory (NREL), the private sector and other DOE laboratories. Through these collaborations, Golden takes pride in providing its partners with a strong understanding of business in a customer-service culture. With a focus on innovation, Golden offers technical expertise, working side-by-side with industry partners to achieve the very best in cutting-edge renewable energy technologies. Dedication to the customer and daily project management help partners achieve new energy choices for a cleaner environment.



[Webmaster](#)

| [Security](#)  
 & [Privacy](#) |

[EERE](#)

[Home](#)

U.S.  
 Department  
 of Energy

Content

Last

Updated:

08/04/2004



## EERE Regional Offices

The state and local partnerships that take place through the Regional Offices are the primary vehicle through which the Department of Energy meets the needs of individual citizens, cities, counties, and states across the nation. Read the Regional Office fact sheet ([PDF 869 KB](#)) for more information, [Download Acrobat Reader](#). Select a region below to learn more about partnerships and programs in particular states and communities.

[Search Help](#) ▶ [More Search Options](#)

▶ [Search](#)

[EERE Information Center](#)

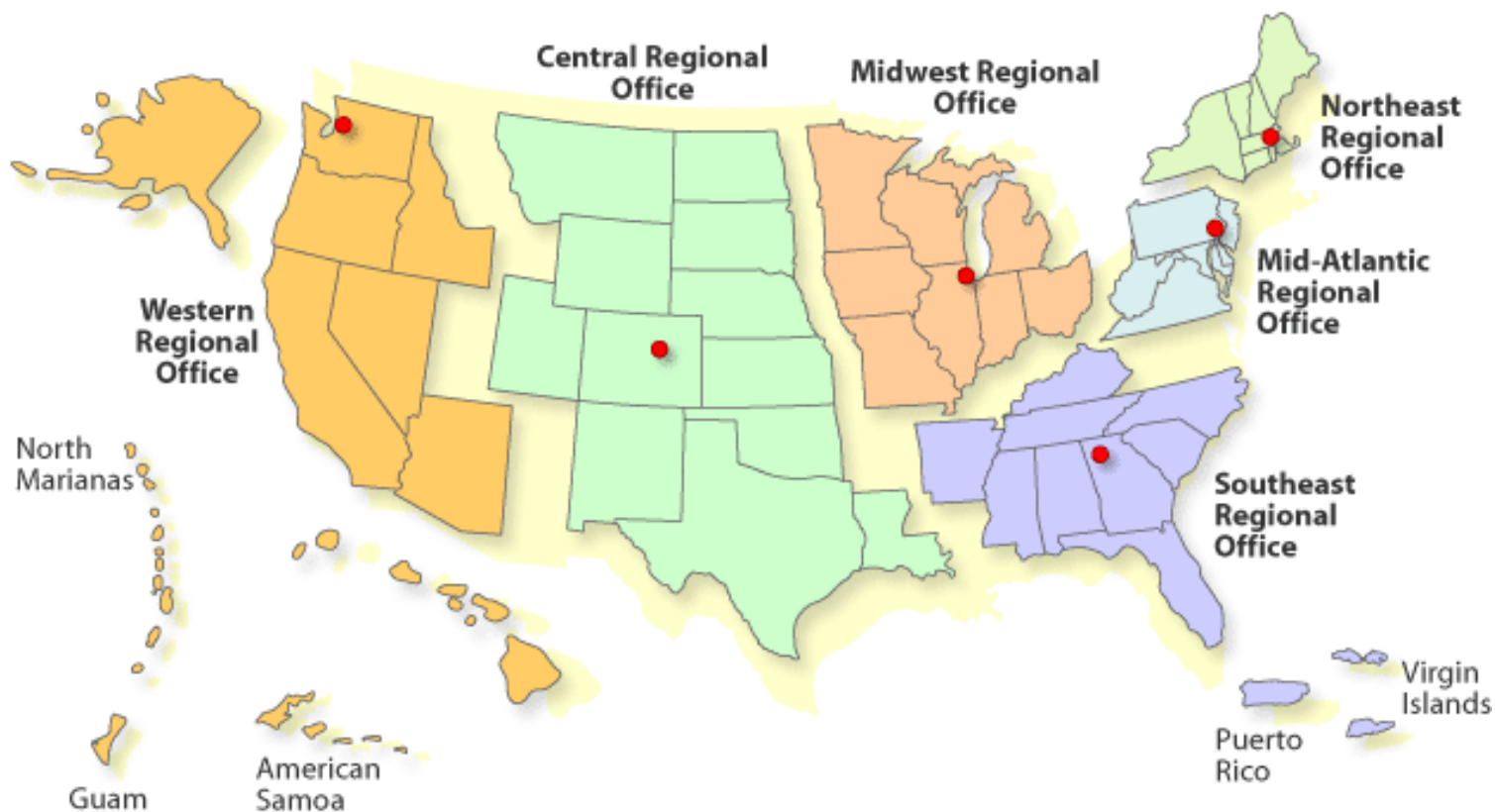



The Regional Offices of DOE's Office of Energy Efficiency and Renewable Energy (EERE) catalyze the implementation of energy-efficient and renewable energy strategies at the state and local level by:

- Working with states and communities to promote EERE programs
- Identifying and engaging community and state partners
- Integrating EERE programs with public and private sector activities.

 [Printable Version](#)

## U.S. Department of Energy Regional Offices

- [Central Regional Office](#)
- [Mid-Atlantic Regional Office](#)
- [Midwest Regional Office](#)
- [Northeast Regional Office](#)
- [Southeast Regional Office](#)
- [Western Regional Office](#)

[Webmaster](#)

| [Security](#)

& [Privacy](#) |

[EERE](#)

[Home](#)

U.S.  
Department  
of Energy

Content

Last

Updated:

08/19/2004



# DOE Laboratories

To accomplish its mission of strengthening America's energy security, environmental quality, and economic vitality, DOE's Office of Energy Efficiency and Renewable Energy works with a variety of national laboratories.

The following DOE laboratories conduct research and development of energy efficiency and renewable energy technologies:

- [Argonne National Laboratory](#)
- [Brookhaven National Laboratory](#)
- [Idaho National Engineering and Environmental Laboratory](#)
- [Lawrence Berkeley National Laboratory](#)
- [Lawrence Livermore National Laboratory](#)
- [Los Alamos National Laboratory](#)
- [National Energy Technology Laboratory](#)
- [National Renewable Energy Laboratory](#)
- [Oak Ridge National Laboratory](#)
- [Pacific Northwest National Laboratory](#)
- [Sandia National Laboratories](#)

 [Printable Version](#)

[Webmaster](#)

| [Security](#)  
& [Privacy](#) |

[EERE](#)

[Home](#)

U.S.  
Department  
of Energy

Content

Last

Updated:

03/02/2004



## About the Office of EERE

[◀ About the Office Home](#)[Mission](#)[Strategic Plan](#)[Organization](#)[Contacts](#)[Budget](#)[Congressional  
Testimony](#)[Business Administration](#)[Solicitations](#)[Program Partners](#)[State Agreements](#)[Communication  
Standards](#)[Search Help](#) ▶ [More Search Options](#)▶ [Search](#)[EERE Information Center](#)

### ■ FEATURES

**New State and Federal  
Collaborative Offers  
\$2.6 Million for Energy Projects**

## Solicitations

Much of the funding available to EERE is distributed to private firms, educational institutions, nonprofit organizations, state and local governments, Native American organizations, and individuals through competitive solicitations. EERE is strongly committed to partnerships to help ensure the eventual market acceptance of the technologies being developed.

## Access to Solicitations

EERE and its national laboratories conduct competitive procurements through a variety of procurement offices. The World Wide Web sites for the Department of Energy procurement offices which conduct EERE's procurements are listed below. DOE's Western Regional Office also publishes a [monthly compilation of solicitations](#) relating to energy efficiency, renewable energy, and sustainable development.

## Status of Solicitations

In addition, solicitation information may be accessed directly from certain EERE programs and offices. Sources of this funding information are provided below.

## DOE Procurement Offices

### [Golden Field Office](#)

Includes solicitations issued by Golden and EERE's Regional Offices.

### [DOE e-center - Doing Business with DOE](#)

### [Chicago Operations Office](#)

### [Oak Ridge Operations Office](#)

### [National Energy Technology Laboratory](#)

## National Laboratory Solicitations for EERE

[National Renewable Energy Laboratory \(NREL\)](#)

[Oak Ridge National Laboratory \(ORNL\)](#)

## EERE Program Solicitations

In addition, solicitation information may be accessed directly from certain EERE programs, as well as EERE partnership programs. Sources of this funding information are provided below.

[Federal Energy Management Program \(FEMP\)](#)

FEMP reduces the cost of Government by advancing energy efficiency, water conservation, and the use of solar and other renewable energy. FEMP solicitations may be directed toward energy management firms or may provide funding for other federal agencies. Solicitations are posted on the [What's New in FEMP page](#).

[Inventions and Innovations Program](#)

The Inventions and Innovations Program offers grants for the investigation of innovative ideas and inventions with commercial market potential that could save a significant amount of energy.

[NICE<sup>3</sup>: National Industrial Competitiveness Through Energy, Environment, Economics—Grants](#)

NICE<sup>3</sup> provides funding to state and industry partnerships for projects that develop and demonstrate advances in energy efficiency and clean production technologies for industry.

[FreedomCAR](#)

FreedomCAR is a government-industry program working to advance high-efficiency vehicles with a focus on fuel cells and hydrogen produced from renewable energy. DOE will carry out the program in partnership with the U.S. Council of Automotive Research, a cooperative organization formed by Ford Motor Company, General Motors Corporation, and DaimlerChrysler Corporation.

[State Energy Program](#)

The State Energy Program offer grants to states to help implement EERE programs in states or within local communities. Projects cover a wide range of programmatic areas, including Federal energy management, building codes and standards, alternative fuels, industrial efficiency, building efficiency, and renewable energy technologies.

[Photovoltaic Manufacturing Technology \(PVMaT\)](#)

PVMaT is a research and development (R&D) partnership between EERE and members of the U.S. photovoltaic (PV) industry. It is designed to help U.S. industry improve PV manufacturing processes and equipment.

 [Printable Version](#)

[Webmaster](#)

| [Security](#)

[& Privacy](#) |

[About the](#)

[Office](#)

[Home](#) |

[EERE](#)

[Home](#)

U.S.  
Department  
of Energy

Content

Last

Updated:

08/19/2004

[Home](#) | [Site Map](#) | [A-Z Index](#) | [EERE Information Center](#)

Search

# Webmaster

[Webmaster](#) - Here's where you can request help locating information on the EERE Web site.

[EERE Information Center](#) - The EERE Information Center answers questions on EERE's products, services, and 11 technology programs, refers callers to the most appropriate EERE resources, and refers qualified callers to the appropriate expert networks.

[Feedback](#) - If you have any suggestions on how we can make the EERE Web site better, we'd appreciate hearing them.

[Subscribe](#) - Register to receive EERE's weekly electronic newsletter, *EERE Network News*.

[Add a Site: Energy Information Portal](#) - Use this form to request a link to your Web site on EERE's Energy Information Portal.

[Webmaster](#)  
| [Security](#)  
& [Privacy](#) |  
[EERE](#)  
[Home](#)

U.S.  
Department  
of Energy

Content  
Last  
Updated:  
02/17/2004



# Security and Privacy Notices

## Security Notice

This Web site is part of a Federal computer system used to accomplish Federal functions. The Department of Energy monitors this Web site for security purposes to ensure it remains available to all users and to protect information in the system. By accessing this Web site, you are expressly consenting to these monitoring activities.

Unauthorized attempts to defeat or circumvent security features, to use the system for other than intended purposes, to deny service to authorized users, to access, obtain, alter, damage, or destroy information, or otherwise interfere with the system or its operation are prohibited. Evidence of such acts may be disclosed to law enforcement authorities and result in criminal prosecution under the Computer Fraud and Abuse Act of 1986 (Pub. L. 990474) and the National Information Infrastructure Protection Act of 1996 (Pub. L. 104-294), (18 U.S.C. 1030), or other applicable criminal laws.

## Privacy Notice

We collect no personal information about you when you visit a DOE Web site, unless otherwise stated, unless you choose to provide this information to us. However, we collect and store certain information automatically. What we collect and store automatically is:

- the Internet Protocol (IP) address of the domain from which you access the Internet (i.e. 123.456.789.012) whether yours individually or provided as a proxy by your Internet Service Provider (ISP) the date and time you access our site
- the pages you peruse (recorded by the text and graphics files that compose that page) and, the Internet address of the Website from which you linked directly to our site.

We use the summary statistics to help us make our site more useful to visitors, such as assessing what information is of most and least interest to visitors, and for other purposes such as determining the site's technical design specifications and identifying system performance or problem areas.

This information is NOT shared with anyone beyond the support staff to this home page, except when required by Law Enforcement investigation, and is used only as a source of anonymous statistical information.

## Comments Sent by E-mail

You may choose to provide us with personal information, as in an e-mail message containing your comments or questions. We use this information to improve our service to you or to respond to your

request. There are times when your message is forwarded, as e-mail, to other Department of Energy employees who may be better able to help you. Except for authorized law enforcement investigations, we do not share our e-mail with any other outside organizations.

[Webmaster](#)

| [Security](#)  
& [Privacy](#) |

[EERE](#)

[Home](#)

U.S.  
Department  
of Energy

Content

Last

Updated:

02/03/2003



[Home](#) | [Site Map](#) | [A-Z Index](#) | [EERE Information Center](#)[Search](#)

# Disclaimer

This system is made available by an agency of the United States Government. Neither the United States Government nor any agency thereof, nor any of their employees, makes any warranty, express or implied, or assumes any legal liability or responsibility for the accuracy, completeness, or usefulness of any information, apparatus, product or process disclosed, or represents that its use would not infringe privately owned rights.

Reference herein to any specific commercial product, process, or service by trade name, trademark, manufacturer, or otherwise, does not necessarily constitute or imply its endorsement, recommendation, or favoring by the United States Government or any agency thereof. The views and opinions of originators expressed herein do not necessarily state or reflect those of the United States Government or any agency thereof.

We reserve the right to make all decisions in regard to what material is added to the EERE Web site, including the right to reject submissions.

[Webmaster](#)[| Security](#)[& Privacy |](#)[EERE](#)[Home](#)

U.S.  
Department  
of Energy

Content

Last

Updated:

02/03/2003



## Dome Sizes

16ft Dome  
16ft Riser  
20ft Dome  
24ft Dome  
30ft Dome  
36ft Dome  
44ft Dome  
60ft Dome

## Why Domes

Shelters  
Event Dome  
Playground  
Greenhouse  
projection  
Mandala

## Features

Frame  
Covers  
Door  
Windows  
Wood Stove  
Screens  
Connecting  
Interiors  
Floors

## Extras

Winter Liners  
Insulation  
Skylight  
Air Chairs  
Eco Toilet  
Floating Bed

## Dome Line

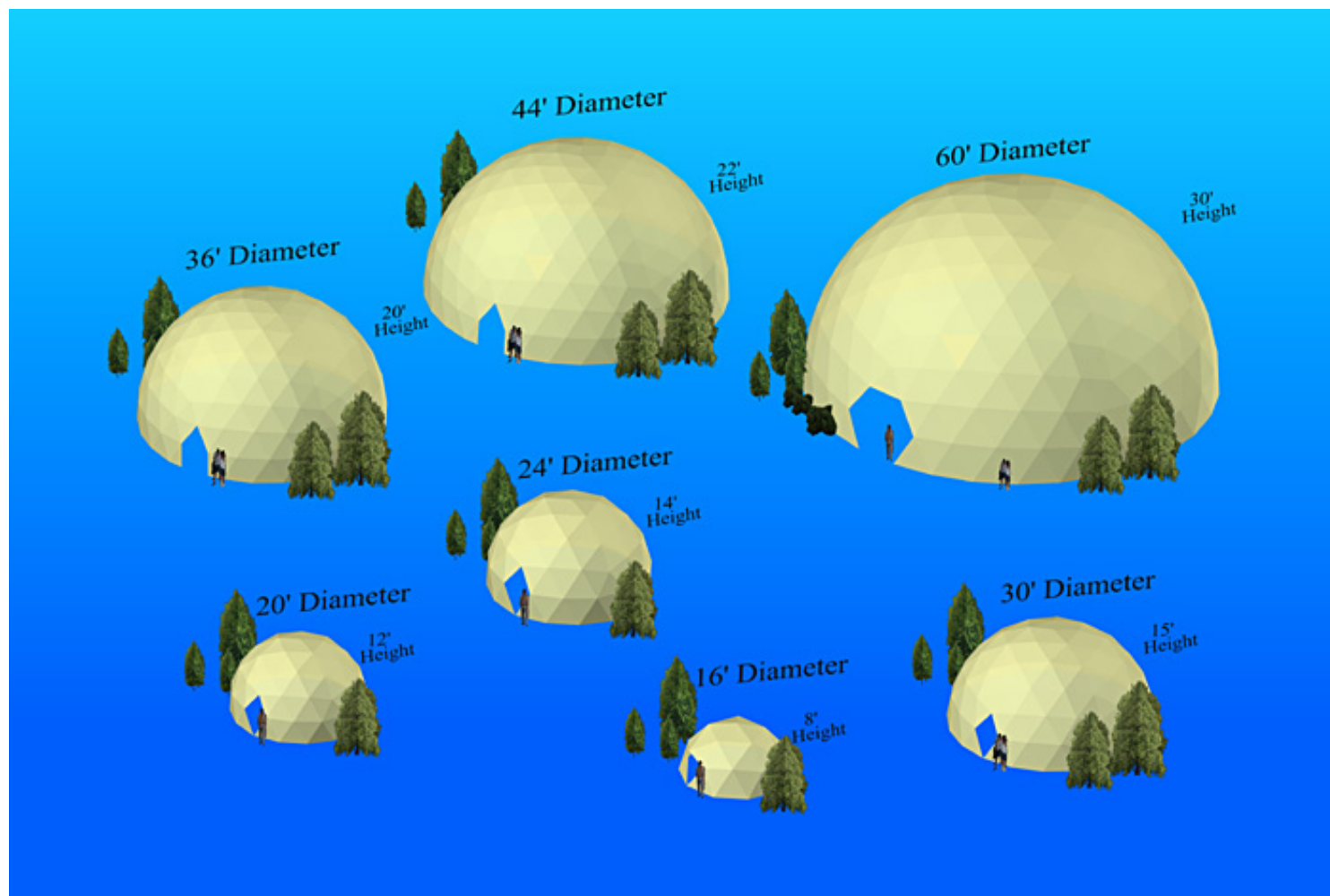

Email: [info@pacificdomes.com](mailto:info@pacificdomes.com)

247 Granite Street  
Ashland, OR 97520  
©2001 Pacific Domes

1-888-488-8127  
1-541-488-7737

## Technical Information

- Fabric Options
- Floor Plans
- Frame Diagrams
- Engineering Specs
- Anchoring
- Fabric Treatment

## Order Info

- Prices
- Shipping

## Contact Us

## Links

## Photos

## Mandalas





## Dome Sizes

16ft Dome  
16ft Riser  
20ft Dome  
24ft Dome  
30ft Dome  
36ft Dome  
44ft Dome  
60ft Dome

## Why Domes

Shelters  
Event Dome  
Playground  
Greenhouse  
projection  
Mandala

## Features

Frame  
Covers  
Door  
Windows  
Wood Stove  
Screens  
Connecting  
Interiors  
Floors

## Extras

Winter Liners  
Insulation  
Skylight  
Air Chairs  
Eco Toilet  
Floating Bed

## Technical Information

Fabric Options  
Floor Plans  
Frame Diagrams  
Engineering Specs  
Anchoring  
Fabric Treatment

## Order Info

Prices  
Shipping

## Contact Us

## Links

## Photos

## The Domes: 16 FT

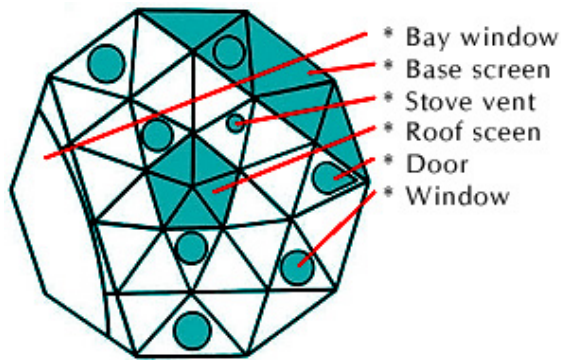

All shaded areas have screens provided



16 ft. dome interior bay window

### Features:

- Floor Area: 200 sq.
- Bay Window: 5 ft. tall x 14 ft. wide
- Frame Package: 5 ft. x 1 ft. x 1 ft.
- Ceiling Height: 8 1/2 ft.
- Dome Weight: 200 lbs.
- Cover Package: 2 1/2 ft. x 18 in. x 18 in
- Assembly time: 2 hours with a crew of 3 or 4 (double your first time).

### The 16 ft. dome package includes:

- Complete 3/4" galvanized steel tube frame with hardware
- Canvas cover with bay window (See [Fabric Options page](#) for choices)
- 6 round windows (2 ft. Diameter) with interchangeable screens
- 1 base screen
- Weather-tight door with screen
- Zip off roof with roof screen
- Stove vent flashing and pipe cap (When wood stove is not in use, a window is provided for stove hole)
- Hardware for anchoring dome to floor
- Dome Care Manual including Deck Plans and assembly instructions
- Custom window & door placements available
- Add \$250 for a Heavy Duty 1" frame
- [Deck Plans ready to download](#)

### Prices:

- 16 ft. Sun Coat Dome Package **\$3,200**
- 16 ft. Canopy Vinyl Dome Package **\$3,600**
- 16 ft. Canopy Plus Vinyl Dome Package **\$4,800**



Base screen, roof, door and window screens for summer ventilation.



16ft with extended deck and storage underneath.

Mandalas



**16ft in the Colorado Rockies camouflaged with  
gree Thermoshield.**

---

[Email: info@pacificdomes.com](mailto:info@pacificdomes.com)

247 Granite Street  
Ashland, OR 97520  
©2001 Pacific Domes

1-888-488-8127  
1-541-488-7737



### Dome Sizes

- 16ft Dome
- 16ft Riser
- 20ft Dome
- 24ft Dome
- 30ft Dome
- 36ft Dome
- 44ft Dome
- 60ft Dome

### Why Domes

- Shelters
- Event Dome
- Playground
- Greenhouse
- projection
- Mandala

### Features

- Frame
- Covers
- Door
- Windows
- Wood Stove
- Screens
- Connecting
- Interiors
- Floors

### Extras

- Winter Liners
- Insulation
- Skylight
- Air Chairs
- Eco Toilet
- Floating Bed

### Technical Information

- Fabric Options
- Floor Plans
- Frame Diagrams
- Engineering Specs
- Anchoring
- Fabric Treatment

### Order Info

- Prices
- Shipping

### Contact Us

### Links

### Photos

## The Domes: 16FT Riser

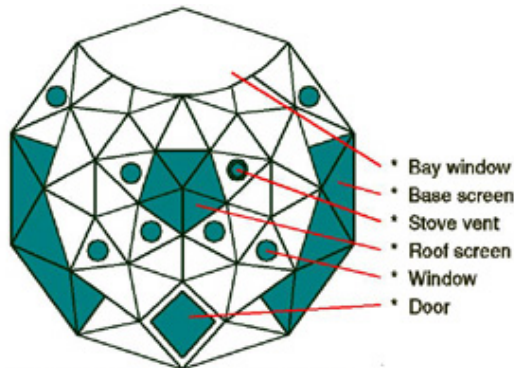

All shaded areas have screens provided.



Riser wall allows a pre-hung door option

### Features:

- Floor Area: 200 sq.
- Bay Window: 8 ft. tall x 11 ft. wide
- Frame Package: 5' x 18" x 18".
- Ceiling Height: 11 3/4 ft.
- Dome Weight: 390 lbs.
- Cover Package: 3 ft. x 20 in. x 20 in.
- Assembly time: 3 hours with a crew of 3 or 4 (double your first time).

### The 16 ft. Riser Wall Dome package includes:

- Complete 3/4" galvanized steel tube frame with hardware
- Canvas cover with bay window (See Fabric Options page for choices)
- 6 round windows (2 ft. Diameter) with interchangeable screens
- 2 base screens
- Weather-tight door with screen
- Zip off roof with roof screen
- Stove vent flashing and pipe cap (When wood stove is not in use, a window is provided for stove hole)
- Hardware for anchoring dome to floor
- Dome Care Manual including deck plans and assembly instructions
- Custom window & door placements available
- Add \$375 for a Heavy Duty 1" frame
- Deck Plans ready to download



Enjoy majestic views from your new dome



A full range of colors are available in vinyl fabric

Mandalas

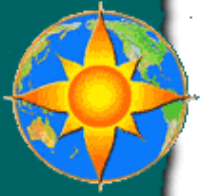

**Prices:**

- 16 ft. Riser Wall Event Skin Dome Package **\$2,800**
- 16 ft. Riser Wall Sun Coat Dome Package **\$4,000**
- 16 ft. Riser Wall Canopy Vinyl Dome Package **\$4,800**
- 16 ft. Riser Wall Canopy Plus Vinyl Dome Package **\$5,400**

---

[Email: info@pacificdomes.com](mailto:info@pacificdomes.com)

247 Granite Street  
Ashland, OR 97520  
©2001 Pacific Domes

1-888-488-8127  
1-541-488-7737



### Dome Sizes

- 16ft Dome
- 16ft Riser
- 20ft Dome
- 24ft Dome
- 30ft Dome
- 36ft Dome
- 44ft Dome
- 60ft Dome

### Why Domes

- Shelters
- Event Dome
- Playground
- Greenhouse
- projection
- Mandala

### Features

- Frame
- Covers
- Door
- Windows
- Wood Stove
- Screens
- Connecting
- Interiors
- Floors

### Extras

- Winter Liners
- Insulation
- Skylight
- Air Chairs
- Eco Toilet

## The Domes: 20 FT

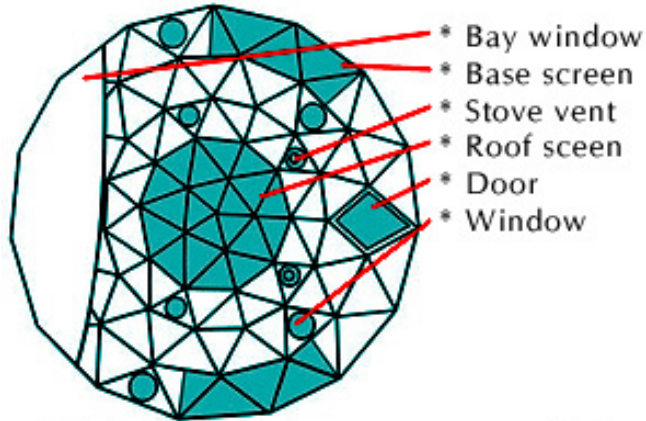

All shaded areas have screens provided

### Features:

- Floor Area: 300 sq.
- Bay Window: 7 ft. tall x 16 ft. wide
- Frame Package: 5 ft. x 18 in. x 1 ft.
- Ceiling Height: 12 ft.
- Dome Weight: 420 lbs.
- Cover Package: 3 ft. x 2 ft. x 2 ft.
- Assembly time: 3 1/2 hours with a crew of 3 or 4 (double your first time).



This 20' Dome went through hurricane Andrew in the Florida Keys and was undisturbed by 135 mile an hour winds.



Floating Bed  
Technical  
Information  
Fabric Options  
Floor Plans  
Frame Diagrams  
Engineering Specs  
Anchoring  
Fabric Treatment:

Order Info

Prices  
Shipping

Contact Us

Links

Photos

Mandalas



## The 20 ft. dome package includes:

- Complete 3/4" galvanized steel tube frame with hardware
- Canvas cover with bay window (See [Fabric Options page](#) for choices)
- 8 round windows (2 ft. Diameter) with interchangeable screens
- 2 base screens for maximum ventilation
- Weather-tight door with screen
- Zip off roof with roof screen
- Stove vent flashing and pipe cap (The stove flashing pocket is interchangeable with a window/screen set. There are two optional positions provided for easy access to the door for wood hauling.)
- Hardware for anchoring dome to floor
- Dome Care Manual including Deck Plans and assembly instructions
- Custom window & door placements available
- Add \$560 for a Heavy Duty 1" frame
- [Deck Plans ready to download](#)

## Prices:

- 20 ft. Sun Coat Dome Package **\$5,300**
- 20 ft. Canopy Vinyl Dome Package **\$6,600**
- 20 ft. Canopy Plus Vinyl Dome Package **\$7,600**



20ft dome. View from loft.



**20ft dome as second floor.**

---

[Pacific Domes](#)

247 Granite Street  
Ashland, OR 97520  
©2001 Pacific Domes

1-888-488-8127  
1-541-488-7737



## Dome Sizes

16ft Dome  
16ft Riser  
20ft Dome  
24ft Dome  
30ft Dome  
36ft Dome  
44ft Dome  
60ft Dome

## Why Domes

Shelters  
Event Dome  
Playground  
Greenhouse  
projection  
Mandala

## Features

Frame  
Covers  
Door  
Windows  
Wood Stove  
Screens  
Connecting  
Interiors  
Floors

## Extras

Winter Liners  
Insulation  
Skylight  
Air Chairs  
Eco Toilet  
Floating Bed

## Technical Information

Fabric Options  
Floor Plans  
Frame Diagrams  
Engineering Specs  
Anchoring  
Fabric Treatment

## Order Info

Prices  
Shipping

## Contact Us

## Links

## Photos

## The Domes: 24 FT

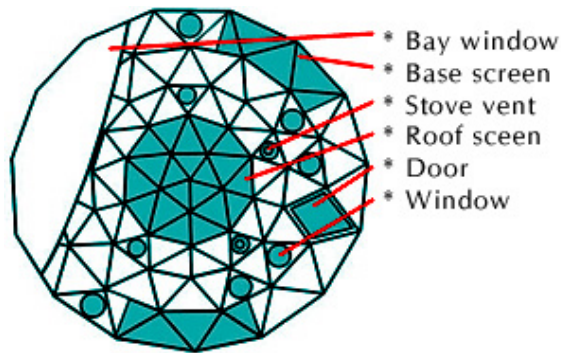

All shaded areas have screens provided



Meditation Dome at Madre Grande Monastery

### Features:

- Floor Area: 425 sq.
- Bay Window: 8 1/2 ft. tall x 20 ft. wide
- Frame Package: 5 ft. x 18 in. x 2 ft.
- Ceiling Height: 14 ft.
- Dome Weight: 490 lbs.
- Cover Package: 3 ft. x 2 ft. x 2 ft.
- Assembly time: 4 hours with a crew of 3 or 4 (double your first time).

### The 24 ft. dome package includes:

- Complete 3/4" galvanized steel tube frame with hardware
- Canvas cover with bay window (See [Fabric Options page](#) for choices)
- 10 round windows (2 ft. Diameter) with interchangeable screens
- 2 base screens for maximum ventilation
- Weather-tight door with screen
- Zip off roof with roof screen
- Stove vent flashing and pipe cap (The stove flashing pocket is interchangeable with a window/screen set. There are two optional positions provided for easy access to the door for wood hauling.)
- Hardware for anchoring dome to floor
- Dome Care Manual including Deck Plans and assembly instructions
- Custom window & door placements available
- Add \$630 for a Heavy Duty 1" frame
- [Deck Plans ready to download](#)

### Prices:

- 24 ft. Sun Coat Dome Package **\$7,800**
- 24 ft. Canopy Vinyl Dome Package **\$9,400**
- 24 ft. Canopy Plus Vinyl Dome Package **\$11,000**



24' dome ceiling with roof and screen in place



A year-round family dwelling in southern Oregon

# Mandalas

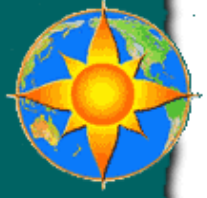

---

Email: [info@pacificdomes.com](mailto:info@pacificdomes.com)

247 Granite Street  
Ashland, OR 97520  
©2001 Pacific Domes

1-888-488-8127  
1-541-488-7737



## Dome Sizes

16ft Dome  
16ft Riser  
20ft Dome  
24ft Dome  
30ft Dome  
36ft Dome  
44ft Dome  
60ft Dome

## Why Domes

Shelters  
Event Dome  
Playground  
Greenhouse  
projection  
Mandala

## Features

Frame  
Covers  
Door  
Windows  
Wood Stove  
Screens  
Connecting  
Interiors  
Floors

## Extras

Winter Liners  
Insulation  
Skylight  
Air Chairs  
Eco Toilet  
Floating Bed

## Technical Information

Fabric Options  
Floor Plans  
Frame Diagrams  
Engineering Specs  
Anchoring  
Fabric Treatment

## Order Info

Prices  
Shipping

## Contact Us

## Links

## Photos

## The Domes: 30 FT

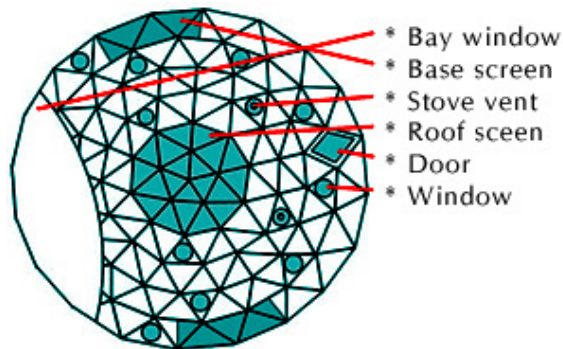

All shaded areas have screens provided



30 ft. dome interior and window

### Features:

- Floor Area: 700 sq.
- Bay Window: 11 ft. tall x 22 ft. wide
- Frame Package: 5 ft. x 18 in. x 2 ft.
- Ceiling Height: 15 ft.
- Dome Weight: 700 lbs.
- Cover Package: 3 ft. x 2 1/2 ft. x 2 ft.
- Assembly time: 10 hours with a crew of 4 (double your first time).

### The 30 ft. dome package includes:

- Complete 3/4" galvanized steel tube frame with hardware
- Canvas cover with bay window (See [Fabric Options page](#) for choices)
- 12 round windows (2 ft. Diameter) with interchangeable screens
- 2 base screens for maximum ventilation
- Weather-tight door with screen
- Zip off roof with roof screen
- Stove vent flashing and pipe cap (The stove flashing pocket is interchangeable with a window/screen set. There are two optional positions provided for easy access to the door for wood hauling.)
- Hardware for anchoring dome to floor
- Dome Care Manual including Deck Plans and assembly instructions
- Custom window & door placements available
- Add \$830 for a Heavy Duty 1" frame
- [Deck Plans ready to download](#)

### Prices:

- 30 ft. Sun Coat Dome Package **\$9,400**
- 30 ft. Canopy Vinyl Dome Package **\$11,600**
- 30 ft. Canopy Plus Vinyl Dome Package **\$13,800**



This 30ft Dome is a meditation dome at the Sunray Meditation Center in Bristol, VT

# Mandalas

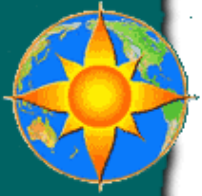

---

Email: [info@pacificdomes.com](mailto:info@pacificdomes.com)

247 Granite Street  
Ashland, OR 97520  
©2001 Pacific Domes

1-888-488-8127  
1-541-488-7737



## Dome Sizes

16ft Dome  
16ft Riser  
20ft Dome  
24ft Dome  
30ft Dome  
36ft Dome  
44ft Dome  
60ft Dome

## Why Domes

Shelters  
Event Dome  
Playground  
Greenhouse  
projection  
Mandala

## Features

Frame  
Covers  
Door  
Windows  
Wood Stove  
Screens  
Connecting  
Interiors  
Floors

## Extras

Winter Liners  
Insulation

## The Domes: 36 FT

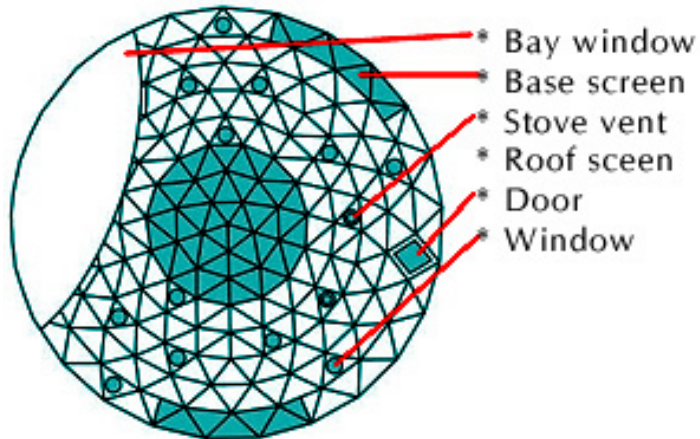

All shaded areas have screens provided

### Features:

- Floor Area: 1,018 sq.
- Bay Window: 15 ft. tall x 30 ft. wide
- Frame Package: 5 ft. x 2 ft. x 2 ft.
- Ceiling Height: 20 ft.
- Dome Weight: 1,000 lbs.
- Cover Package: 3 ft. x 2 1/2 ft. x 2 1/2 ft.
- Assembly time: 14 hours with a crew of 4 (double your first time).



**Connected Domes: 36 ft on the right.**



**Two Hoop Doors: One to the outside, and one connecting to another dome.**

Skylight  
Air Chairs  
Eco Toilet  
Floating Bed

## Technical Information

Fabric Options  
Floor Plans  
Frame Diagrams  
Engineering Specs  
Anchoring  
Fabric Treatment

## Order Info

Prices  
Shipping

## Contact Us

## Links

## Photos

## Mandalas



### The 36 ft. dome package includes:

- Complete 3/4" galvanized steel tube frame with hardware
- Canvas cover with bay window (See [Fabric Options page](#) for choices)
- 14 round windows (2 ft. Diameter) with interchangeable screens
- 2 base screens for maximum ventilation
- Weather-tight door with screen
- Zip off roof with roof screen
- Stove vent flashing and pipe cap (The stove flashing pocket is interchangeable with a window/screen set. There are two optional positions provided for easy access to the door for wood hauling.)
- Hardware for anchoring dome to floor
- Dome Care Manual including Deck Plans and assembly instructions
- Custom window & door placements available
- Add \$1400 for a Heavy Duty 1" frame
- [Deck Plans ready to download](#)

### Prices:

- 36 ft. Sun Coat Dome Package **\$14,900**
- 36 ft. Canopy Vinyl Dome Package **\$18,000**
- 36 ft. Canopy Plus Vinyl Dome Package **\$21,200**



**Kriya Yoga institute in Austin, Texas.**



**Kriya Yoga ceremony in the above 36 ft dome. Swami blesses all domes made by Pacific Domes.**





**(Right) Reflection in a Pond of a 36 ft  
Wedding Dome in Oregon.**



---

[Email: info@pacificdomes.com](mailto:info@pacificdomes.com)

247 Granite Street  
Ashland, OR 97520  
©2001 Pacific Domes

1-888-488-8127  
1-541-488-7737



## Dome Sizes

16ft Dome  
16ft Riser  
20ft Dome  
24ft Dome  
30ft Dome  
36ft Dome  
44ft Dome  
60ft Dome

## Why Domes

Shelters  
Event Dome  
Playground  
Greenhouse  
projection  
Mandala

## Features

Frame  
Covers  
Door  
Windows  
Wood Stove  
Screens  
Connecting  
Interiors  
Floors

## Extras

Winter Liners  
Insulation  
Skylight  
Air Chairs  
Eco Toilet  
Floating Bed

## Technical Information

Fabric Options  
Floor Plans  
Frame Diagrams  
Engineering Specs  
Anchoring  
Fabric Treatment

## Order Info

Prices  
Shipping

## Contact Us

## Links

## Photos

## The Domes: 44 FT

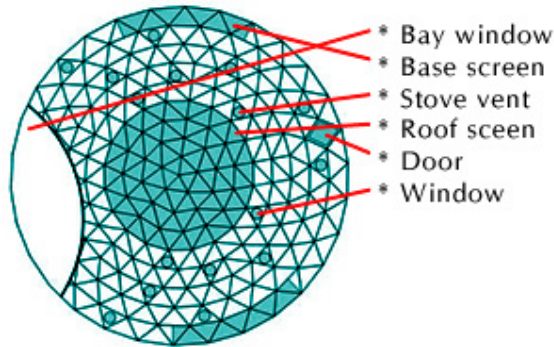

All shaded areas have screens provided



### Features:

- Floor Area: 1,520 sq.
- Bay Window: 15 ft. tall x 30 ft. wide
- Frame Package: 5 ft. x 3 ft. x 3 ft.
- Ceiling Height: 22 ft.
- Dome Weight: 1,500 lbs.
- Cover Package: 3 ft. x 3 ft. x 3 ft.
- Assembly time: 20 hours with a crew of 4 (double your first time).

### The 44 ft. dome package includes:

- Complete 3/4" galvanized steel tube frame with hardware
- Canvas cover with bay window (See [Fabric Options page](#) for choices)
- 16 round windows (2 ft. diameter) with interchangeable screens
- 2 base screens for maximum ventilation
- Weather-tight door with screen
- Zip off roof with roof screen
- Stove vent flashing and pipe cap. (The stove flashing pocket is interchangeable with a window/screen set. There are two optional positions provided for easy access to the door for wood hauling.)
- Hardware for anchoring dome to floor
- Dome Care Manual including Deck Plans and assembly instructions
- Custom window & door placements available
- Add \$2,600 for a Heavy Duty 1" frame
- [Deck Plans ready to download](#)

### Prices:

- 44ft. Sun Coat Dome Package **\$20,000**
- 44 ft. Canopy Vinyl Dome Package **\$24,300**
- 44 ft. Canopy Plus Vinyl Dome Package **\$30,000**



Mandalas

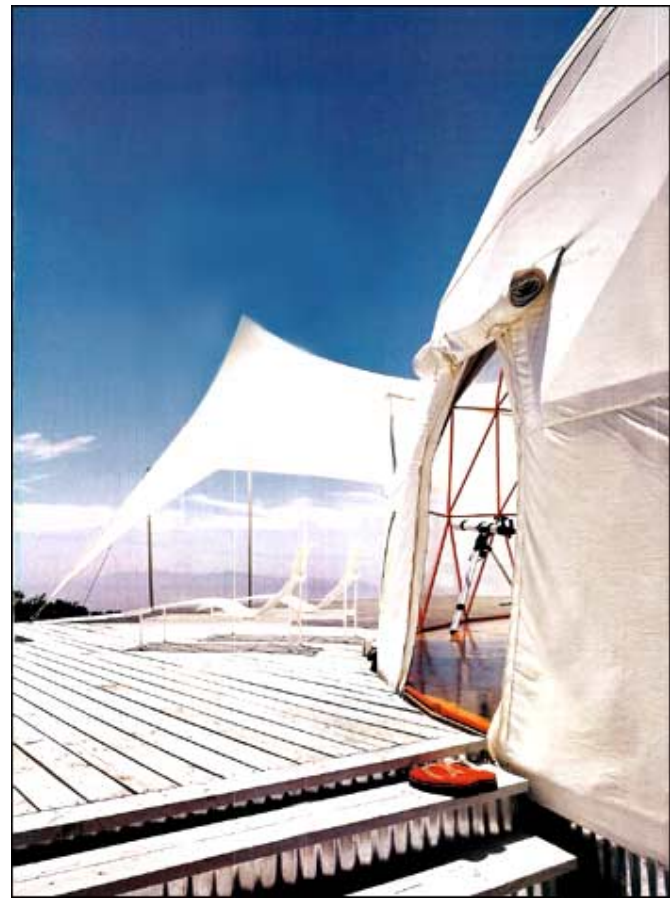

---

[Email: info@pacificdomes.com](mailto:info@pacificdomes.com)

247 Granite Street  
Ashland, OR 97520  
©2001 Pacific Domes

1-888-488-8127  
1-541-488-7737



## Dome Sizes

16ft Dome  
16ft Riser  
20ft Dome  
24ft Dome  
30ft Dome  
36ft Dome  
44ft Dome  
60ft Dome

## Why Domes

Shelters  
Event Dome  
Playground  
Greenhouse  
projection  
Mandala

## Features

Frame  
Covers  
Door  
Windows  
Wood Stove  
Screens  
Connecting  
Interiors  
Floors

## Extras

Winter Liners  
Insulation  
Skylight  
Air Chairs  
Eco Toilet  
Floating Bed

## Technical Information

Fabric Options  
Floor Plans  
Frame Diagrams  
Engineering Specs  
Anchoring  
Fabric Treatment

## Order Info

Prices  
Shipping

## Contact Us

## Links

## Photos

## The Domes: 60 FT

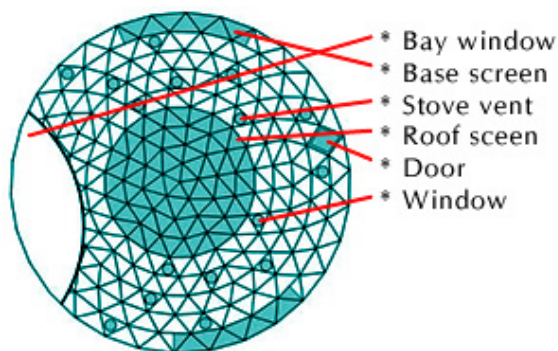

All shaded areas have screens provided



### Features:

- Floor Area: 2,800 sq.
- Bay Window: 20 ft. tall x 48 ft. wide
- Frame Package: 7 ft. x 4 ft. x 4 ft.
- Ceiling Height: 30 ft.
- Dome Weight: 2,500 lbs.
- Cover Package: 40" x 40" x 3 ft.
- Assembly time: 24 hours with a crew of 4 (double your first time).

### The 60 ft. dome package includes:

- Complete 1" galvanized steel tube frame with hardware
- Canvas cover with bay window (See [Fabric Options page](#) for choices)
- 18 round windows (3 ft. diameter) with interchangeable screens
- 2 base screens for maximum ventilation
- Weather-tight door with screen
- Zip off roof with roof screen
- Stove vent flashing and pipe cap. (The stove flashing pocket is interchangeable with a window/screen set. There are two optional positions provided for easy access to the door for wood hauling.)
- Hardware for anchoring dome to floor
- Dome Care Manual including Deck Plans and assembly instructions
- Custom window & door placements available

### Prices:

- 60 ft. Sun Coat Dome Package **\$38,200**
- 60 ft. Canopy Vinyl Dome Package **\$48,000**
- 60 ft. Canopy Plus Vinyl Dome Package **\$60,000**



Wedding Dome on Treasure Island, San Francisco, featuring our optional hexagonal door.



Custom 4 Frequency Taj Mahal Dome for events.

# Mandalas



---

[Email: info@pacificdomes.com](mailto:info@pacificdomes.com)

247 Granite Street  
Ashland, OR 97520  
©2001 Pacific Domes

1-888-488-8127  
1-541-488-7737



## The Domes

### Dome Sizes

- 16ft Dome
- 16ft Riser
- 20ft Dome
- 24ft Dome
- 30ft Dome
- 36ft Dome
- 44ft Dome
- 60ft Dome

### Why Domes

- Shelters
- Event Dome
- Playground
- Greenhouse
- projection
- Mandala

### Features

- Frame
- Covers
- Door
- Windows
- Wood Stove
- Screens
- Connecting
- Interiors
- Floors

### Extras

- Winter Liners
- Insulation
- Skylight
- Air Chairs
- Eco Toilet
- Floating Bed

### Technical Information

- Fabric Options
- Floor Plans
- Frame Diagrams
- Engineering Specs
- Anchoring
- Fabric Treatment

### Order Info

- Prices
- Shipping

**'The power of the world always works in circles, the sky is round, and I have heard the earth is round like a ball, and so are all the stars. The wind in its greatest power, whirls. Birds make their nests in circles, for theirs is the same religion as ours. The sun comes forth and goes down in a circle, the moon does the same. And both always come back to where they were. The life of**

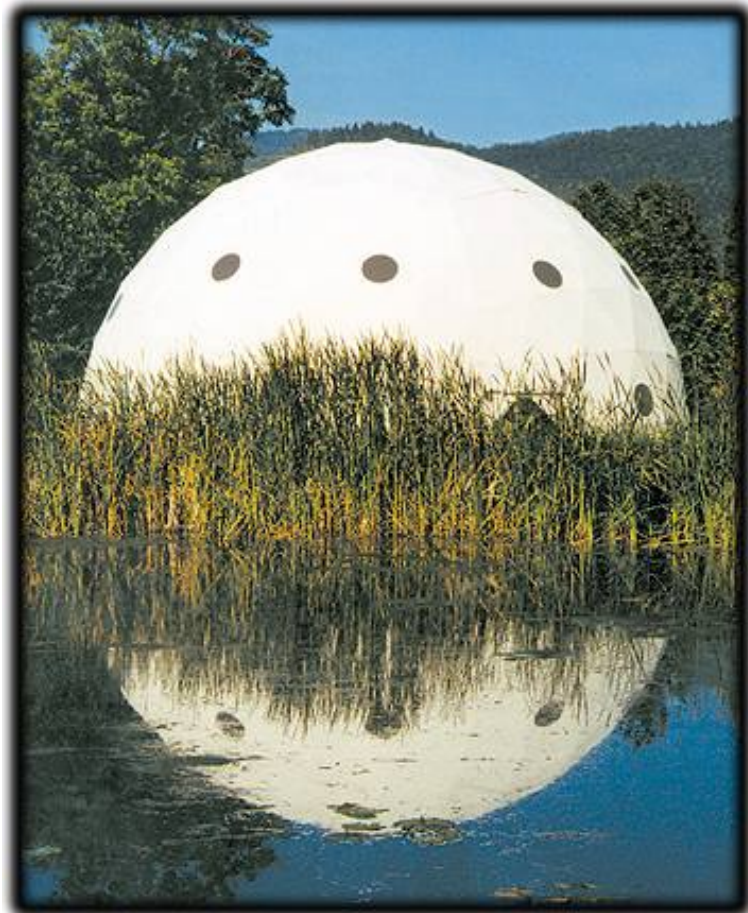

Contact Us

Links

Photos

Mandalas



**man is a  
circle  
from  
childhood  
to  
childhood.  
And so it  
is in  
everything  
where  
power  
moves."**

**\_\_\_\_\_ From  
Black Elk  
Speaks**

### **Why a Dome...**

- Energy efficient
- [Architecturally engineered](#)
- Easy to assemble and portable
- [Many windows for natural lightning](#)
- [Lots of screens for summer ventilation](#)
- [Insulative liners available](#)
- [Woodstove setup](#)
- Water resistant
- [Handles hurricane winds](#)
- [Holds heavy snow loads](#)
- Safe in earth quakes
- Fits in the trunk of your car
- [Sacred Geometry](#)

### **Uses of Pacific Domes...**

- Family dwelling
- Guest housing
- Workshops
- Artist's studio
- Dance and yoga studio
- Retreat space
- Wedding and parties
- Spa and pool covers
- Trade show booth
- Crisis relief shelter



**The 30ft Dome fits in a Ford Aerostar minivan, with only the rear seat removed**

---

[Email: info@pacificdomes.com](mailto:info@pacificdomes.com)

247 Granite Street  
Ashland, OR 97520  
©2001 Pacific Domes

1-888-488-8127  
1-541-488-7737





**Dome Sizes**

- 16ft Dome
- 16ft Riser
- 20ft Dome
- 24ft Dome
- 30ft Dome
- 36ft Dome
- 44ft Dome
- 60ft Dome

**Why Domes**

- Shelters
- Event Dome
- Playground
- Greenhouse
- projection
- Mandala

**Features**

- Frame
- Covers
- Door
- Windows
- Wood Stove
- Screens
- Connecting
- Interiors
- Floors

**Extras**

- Winter Liners
- Insulation
- Skylight
- Air Chairs
- Eco Toilet
- Floating Bed

**Technical Information**

- Fabric Options
- Floor Plans
- Frame Diagrams
- Engineering Spreadsheets
- Anchoring
- Fabric Treatment

**Order Info**

- Prices
- Shipping

**Contact Us**

**Links**

**Photos**

**The Domes: Event**

Our Event Domes are the hit of every trade show and music festival. They are made with our Event Cover which is a flame retardant, durable 100% polyester. It is lightweight for ease of setup and perfect for digital projections. The translucent fabric allows images to be seen on both the inside and outside of the Dome.

Pacific Domes frames are strong enough to support most lighting & sound equipment. (Check weights with our Sales Office) We recommend training with our installation crew for domes 36' diameter and up.

Each Event Dome comes with one hex door and a zip off roof. Custom features are available such as, windows, doors, connecting tunnels and skylights. We are now offering painted [Mandala Domes](#) as well.

**Prices**

- 16 ft. Event Dome Package **\$ 2,600**
- 20 ft. Event Dome Package **\$ 4,300**
- 24 ft. Event Dome Package **\$ 6,200**
- 30 ft. Event Dome Package **\$ 7,800**
- 36 ft. Event Dome Package **\$ 12,000**
- 44 ft. Event Dome Package **\$ 16,000**
- 60 ft. Event Dome Package **\$ 30,000**

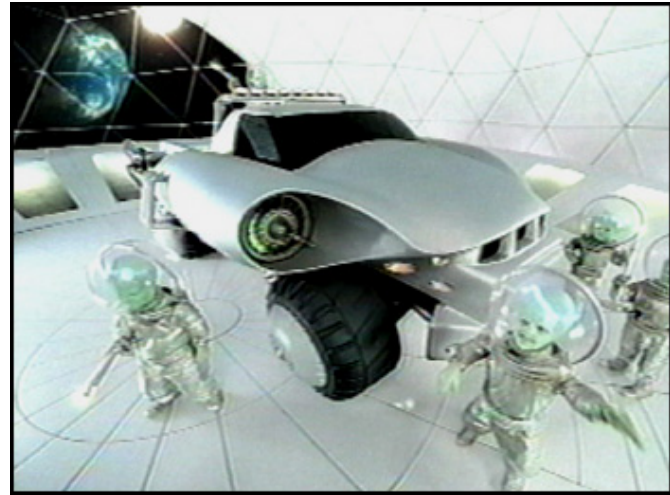

Custom 4 Frequency Taj Mahal Dome for events.

The following chart shows the floor space available and seating estimates:

| Dome Size | Size Square ft. | Row Seating | Buffet Dinner | Round & Stand Up Tables |
|-----------|-----------------|-------------|---------------|-------------------------|
| <b>16</b> | 200             | 34-40       | 25-30         | 20                      |
| <b>20</b> | 300             | 50-55       | 35-45         | 35                      |
| <b>24</b> | 425             | 72-87       | 63-73         | 43                      |
| <b>30</b> | 700             | 115-145     | 85-100        | 70                      |
| <b>36</b> | 1018            | 165-195     | 115-130       | 100                     |
| <b>44</b> | 1520            | 267-320     | 200-230       | 160                     |
| <b>60</b> | 2800            | 465-520     | 350-400       | 280                     |

Event rentals are available through [Dome Works](#).

Email: [info@pacificdomes.com](mailto:info@pacificdomes.com)

247 Granite Street  
 Ashland, OR 97520  
 ©2001 Pacific Domes

1-888-488-8127  
 1-541-488-7737

# Mandalas





# The Domes: Playground

It's a Climbing Dome, a Sandbox, and a Fort!



Multicolored, fire-retardant fabric with screen bottom and top vent to keep cool in the summer.

### Features:

- Kinder-dome 11 ft. diameter (6.5 ft. tall)
- Grade school dome 15 ft diameter (8.5 ft tall)
- Large, clear plastic window
- Dry in the rain
- Removable cover
- Multicolored, fire-retardant fabric
- Screen bottom and top vent to keep cool in the summer

### Prices:

- Kinder Dome
  - frame **\$1000**
  - cover **\$800**
- Grade School
  - frame **\$1300**
  - cover **\$1200**
- Call for a color powder coat price.



Kinder Frame for climbing

### Dome Sizes:

- 16ft Dome
- 16ft Riser
- 20ft Dome
- 24ft Dome
- 30ft Dome
- 36ft Dome
- 44ft Dome
- 60ft Dome

### Why Domes:

- Shelters
- Event Dome
- Playground
- Greenhouse
- projection
- Mandala

### Features:

- Frame
- Covers
- Door
- Windows
- Wood Stove
- Screens
- Connecting Interiors
- Floors

### Extras:

- Winter Liners
- Insulation
- Skylight
- Air Chairs
- Eco Toilet
- Floating Bed

### Technical Information:

- Fabric Options
- Floor Plans
- Frame Diagrams
- Engineering Specs
- Anchoring
- Fabric Treatment

### Order Info:

- Prices
- Shipping

### Contact Us:

### Links:

### Photos:

## Mandalas



[Email: info@pacificdomes.com](mailto:info@pacificdomes.com)

247 Granite Street  
Ashland, OR 97520  
©2001 Pacific Domes

1-888-488-8127  
1-541-488-7737



## Dome Sizes

16ft Dome  
16ft Riser  
20ft Dome  
24ft Dome  
30ft Dome  
36ft Dome  
44ft Dome  
60ft Dome

## Why Domes

Shelters  
Event Dome  
Playground  
Greenhouse  
projection  
Mandala

## Features

Frame  
Covers  
Door  
Windows  
Wood Stove  
Screens  
Connecting  
Interiors  
Floors

## Extras

Winter Liners  
Insulation  
Skylight  
Air Chairs  
Eco Toilet  
Floating Bed

## Technical Information

Fabric Options  
Floor Plans  
Frame Diagrams  
Engineering Specs  
Anchoring  
Fabric Treatment

## Order Info

Prices  
Shipping

## Contact Us

## Links

## Photos

## The Domes: Greenhouse

Pacific Domes Sun Dome covers are perfectly suited for long-term applications such as greenhouses, sunrooms, hot tub covers and pool covers. Made with 10mil 3 layer high density polyethylene. This material allows for 82% light transmission. Life expectancy is 3-8+ years depending on your elevation and UV exposure. Has a 3-year prorated warranty

Sun Domes are available in sized 12 ft. to 60 ft. diameter and are priced the same as our standard dome packages.



24 ft. dome with opaque greenhouse vinyl



16 ft. dome with clear marine vinyl



### The Sun Dome package includes:

- Sun Dome package includes
- Complete 3/4" galvanized steel tube frame
- Translucent greenhouse vinyl or clear marine vinyl, both with UV protection
- Base screens for maximum ventilation
- Weathertight door with door screen
- Interchangeable roof and shade screen
- Fan system included
- Stove vent flashing and pipe cap optional
- Dome Care Manual including Deck Plans and assembly instructions

### Prices:

- 16 ft. Sun Dome \$2,600
- 20 ft. Sun Dome \$4,300
- 24 ft. Sun Dome \$6,200
- 30 ft. Sun Dome \$7,800
- 36 ft. Sun Dome \$12,000
- 44 ft. Sun Dome \$16,000
- 60 ft. Sun Dome \$30,000

Email: [info@pacificdomes.com](mailto:info@pacificdomes.com)

247 Granite Street  
Ashland, OR 97520  
©2001 Pacific Domes

1-888-488-8127  
1-541-488-7737

Mandalas





## Dome Sizes

16ft Dome  
16ft Riser  
20ft Dome  
24ft Dome  
30ft Dome  
36ft Dome  
44ft Dome  
60ft Dome

## Why Domes

Shelters  
Event Dome  
Playground  
Greenhouse  
projection  
Mandala

## Features

Frame  
Covers  
Door  
Windows  
Wood Stove  
Screens  
Connecting  
Interiors  
Floors

## Extras

Winter Liners  
Insulation  
Skylight  
Air Chairs  
Eco Toilet  
Floating Bed

## Technical Information

Projection in Domes..... **coming soon.**

---

[Email: info@pacificdomes.com](mailto:info@pacificdomes.com)

247 Granite Street                      1-888-488-8127  
Ashland, OR 97520                      1-541-488-7737  
©2001 Pacific Domes

Fabric Options  
Floor Plans  
Frame Diagrams  
Engineering Specs  
Anchoring  
Fabric Treatment:

Order Info

Prices  
Shipping

Contact Us

Links

Photos

Mandalas







## Dome Sizes

16ft Dome  
16ft Riser  
20ft Dome  
24ft Dome  
30ft Dome  
36ft Dome  
44ft Dome  
60ft Dome

## Why Domes

Shelters  
Event Dome  
Playground  
Greenhouse  
projection  
Mandala

## Features

Frame  
Covers  
Door  
Windows  
Wood Stove  
Screens  
Connecting  
Interiors  
Floors

## Extras

Winter Liners  
Insulation  
Skylight  
Air Chairs  
Eco Toilet  
Floating Bed

## Technical Information

Fabric Options  
Floor Plans  
Frame Diagrams  
Engineering Specs  
Anchoring  
Fabric Treatment

## Order Info

Prices  
Shipping

## Contact Us

## Links

## Photos

## The Domes: Mandala

Design your own mandala or have our airbrush artists design one for you. Available in all the colors of the rainbow!

The mandala domes have been used for weddings, meditation and yoga gatherings, dance parties, and personal shelters.

### Prices:

To have a mandala painted on your dome add the below price to your normal dome price

|              | Complete dome | Roof only |
|--------------|---------------|-----------|
| 16'          | \$500         | \$250     |
| 16' w/ riser | \$750         | \$375     |
| 20'          | \$1000        | \$500     |
| 24'          | \$1500        | \$750     |
| 30'          | \$1900        | \$950     |
| 36'          | \$3000        | \$1500    |
| 44'          | \$4000        | \$2000    |
| 60'          | \$7500        | \$3800    |

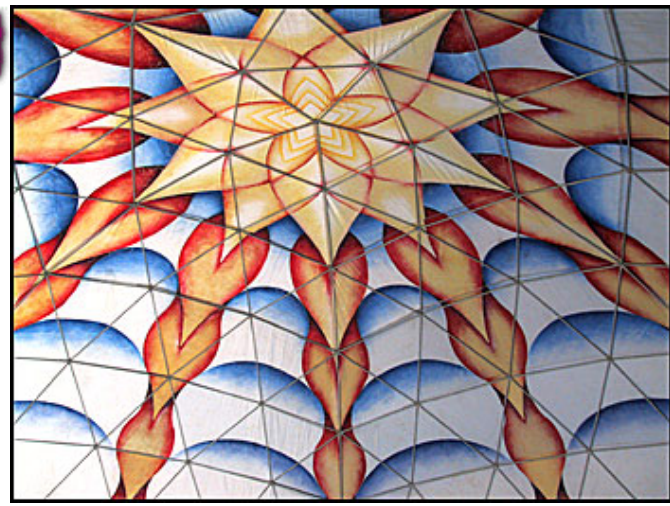

Email: [info@pacificdomes.com](mailto:info@pacificdomes.com)

247 Granite Street  
Ashland, OR 97520  
©2001 Pacific Domes

1-888-488-8127  
1-541-488-7737

# Mandalas

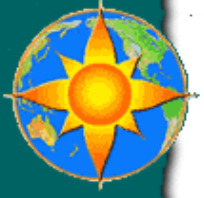



## Dome Sizes

16ft Dome  
16ft Riser  
20ft Dome  
24ft Dome  
30ft Dome  
36ft Dome  
44ft Dome  
60ft Dome

## Why Domes

Shelters  
Event Dome  
Playground  
Greenhouse  
projection  
Mandala

## Features

Frame  
Covers  
Door  
Windows  
Wood Stove  
Screens  
Connecting  
Interiors  
Floors

## Extras

Winter Liners  
Insulation  
Skylight  
Air Chairs

# Frames



Our frames are a geodesic design made of 3/4" galvanized steel tubing bolted together. The 16 ft. domes are a two frequency hemisphere. The 20 ft. and 24 ft. domes are a three frequency design divided at 5/8 of a sphere to increase ceiling height. The 30 ft. dome is a four frequency hemisphere. The 36 ft. dome is a five frequency design divided at 5/9 of a sphere. The 44 ft. and 60 ft. domes are a six frequency hemisphere.

The frames will support the use of hammocks and air chairs. They can hold a minimum of 20 lbs. of snow per square foot. We have an engineering program that will determine whether a Heavy Duty Frame made of 1" steel tubing is necessary in your area. All domes come with illustrations and instructions for easy frame assembly.

Eco Toilet  
Floating Bed

## Technical Information

Fabric Options  
Floor Plans  
Frame Diagrams  
Engineering Specs  
Anchoring  
Fabric Treatment

## Order Info

Prices  
Shipping

## Contact Us

## Links

## Photos

## Mandalas



### Dome Frames:

- 16 ft. Dome - \$ 640
- 16 ft. w/ Riser - \$ 960
- 20 ft. Dome - \$ 1,540
- 24 ft. Dome - \$ 1,840
- 30 ft. Dome - \$ 2,400
- 36 ft. Dome - \$ 3,850
- 44 ft. Dome - \$ 5,120
- 60 ft. Dome - \$10,620  
(60 ft. is a heavy duty frame)

### 36 ft frame with a hexdoor:

A scissor-lift is often used for set-up of larger domes, 36 ft and up.



## Heavy Duty Frames

Our standard dome package includes 3/4" diameter EMT frame tubing. We also offer a Heavy Duty Frame made of 1" diameter tubing for areas with heavy snowloads, or for climbing and aerobatics. We have an engineering program with a 200% safety margin that will determine whether a heavy-duty frame is necessary in your area. Heavy frames are useful when substantial snowpack and high winds occur at the same time.

### **Additional Charge for Heavy Duty Frames:**

- 16 ft. Dome - \$250
- 16 ft. w/ riser \$375
- 20 ft. Dome - \$560
- 24 ft. Dome - \$630
- 30 ft. Dome - \$830
- 36 ft. Dome - \$1,400
- 44 ft. Dome - \$2,600
- 60ft. Dome - (comes with heavy duty frame)



### **Powder Coated Frames**

Powder coating is a quality, colorful finish available for your dome frame. The colors will not fade or chip. There are many colors to choose from.



**Call for Additional Charge for Powder Coating:**

1-888-488-8127

1-541-488-7737

**Bucky Balls:**

Pacific Domes will custom make complete spheres, aka "Bucky Balls", in any diameter or frequency. These are perfect for trade show booths, [sacred geometry](#), or art forms.



---

[Email: info@pacificdomes.com](mailto:info@pacificdomes.com)

247 Granite Street  
Ashland, OR 97520  
©2001 Pacific Domes

1-888-488-8127  
1-541-488-7737





## Covers

### Dome Sizes

- 16ft Dome
- 16ft Riser
- 20ft Dome
- 24ft Dome
- 30ft Dome
- 36ft Dome
- 44ft Dome
- 60ft Dome

### Why Domes

- Shelters
- Event Dome
- Playground
- Greenhouse
- projection
- Mandala

### Features

- Frame
- Covers
- Door
- Windows
- Wood Stove
- Screens
- Connecting
- Interiors
- Floors

### Extras

- Winter Liners
- Insulation
- Skylight
- Air Chairs
- Eco Toilet
- Floating Bed

### Technical Information

- Fabric Options
- Floor Plans
- Frame Diagrams
- Engineering Specs
- Anchoring
- Fabric Treatment

### Order Info

- Prices
- Shipping

### Contact Us



Pacific Domes covers are made of durable, water resistant, mildew resistant and flame retardant canvas. The luminescent thin wall allows for solar passive heating. The canvas has a life expectancy of up to twenty years depending on the fabric used. We recommend different fabrics for various climates depending upon the UV exposure and humidity. [See our Fabric Options Page.](#)

## Windows



Links

Photos

Mandalas



30 ft. dome bay window

Our windows are made with clear boat vinyl and are extremely durable. Each dome comes with a large, sewn-in, bay window. Also included are round, 2 ft. diameter, removable windows, (3 ft. diameter in the 60 ft. dome) with interchangeable screens.



Removable window with screen

---

[Email: info@pacificdomes.com](mailto:info@pacificdomes.com)

247 Granite Street  
Ashland, OR 97520  
©2001 Pacific Domes

1-888-488-8127  
1-541-488-7737



## Dome Sizes

16ft Dome  
16ft Riser  
20ft Dome  
24ft Dome  
30ft Dome  
36ft Dome  
44ft Dome  
60ft Dome

## Why Domes

Shelters  
Event Dome  
Playground  
Greenhouse  
projection  
Mandala

## Features

Frame  
Covers  
Door  
Windows  
Wood Stove  
Screens  
Connecting  
Interiors  
Floors

## Extras

Winter Liners  
Insulation  
Skylight  
Air Chairs  
Eco Toilet  
Floating Bed

## Doors



Optional Pre-Hung Door



The Round Door

Our Pre-Hung Door Option allows for a normal opening and closing/lockable door installation. It also allows ease in connecting two domes. Our Round and Hexagonal Doors are perfect for events, each coming with a zip-close flap. The Round Door can also be used for connecting two domes. Our standard Fabric Door can be opened and zipped closed from the inside or outside. It can also be rolled up and tied open. The 16 ft. dome door is 4 ft. tall by 2 ft. wide. The 20 ft. to 60 ft. domes have a diamond shaped

## Technical Information

Fabric Options  
Floor Plans  
Frame Diagrams  
Engineering Specs  
Anchoring  
Fabric Treatment:

## Order Info

Prices  
Shipping

## Contact Us

## Links

## Photos

## Mandalas



door hole apron. 6 ft. tall by 3 ft. wide. We also offer an optional fabric special door for wheelchair access.

See [Price page](#)



Optional hexagonal door



16 ft. dome door



20 ft - 44 ft standard door



Optional special door

### Doors:

extra charge for:

**Pre hung door :** no extra charge

**Special Door:** \$150

**Hexagonal or Round Door:** \$300

### Extra Doors:

**Pre hung door :** \$200

**Special Door:** \$350

**Hexagonal or Round Door:** \$500

**Metal Reinforcement Hoop for Round Door** \$200



## Windows

### Dome Sizes

16ft Dome  
16ft Riser  
20ft Dome  
24ft Dome  
30ft Dome  
36ft Dome  
44ft Dome  
60ft Dome

### Why Domes

Shelters  
Event Dome  
Playground  
Greenhouse  
projection  
Mandala

### Features

Frame  
Covers  
Door  
Windows  
Wood Stove  
Screens  
Connecting  
Interiors  
Floors

### Extras

Winter Liners  
Insulation  
Skylight  
Air Chairs  
Eco Toilet  
Floating Bed

### Technical Information

Fabric Options  
Floor Plans  
Frame Diagrams  
Engineering Specs  
Anchoring  
Fabric Treatment

### Order Info

Prices  
Shipping

### Contact Us

### Links



30 ft. dome bay window



Removable window with screen

The windows are made with clear boat vinyl and are extremely durable. Each dome comes with a large, sewn-in, bay window. Also included are round, 2 ft. diameter, removable windows, (3 ft. diameter in the 60 ft. dome)

Photos

Mandalas



with  
interchangeable  
screens.

---

[Email: info@pacificdomes.com](mailto:info@pacificdomes.com)

247 Granite Street  
Ashland, OR 97520  
©2001 Pacific Domes

1-888-488-8127  
1-541-488-7737



## Dome Sizes

16ft Dome  
16ft Riser  
20ft Dome  
24ft Dome  
30ft Dome  
36ft Dome  
44ft Dome  
60ft Dome

## Why Domes

Shelters  
Event Dome  
Playground  
Greenhouse  
projection  
Mandala

## Features

Frame  
Covers  
Door  
Windows  
Wood Stove  
Screens  
Connecting  
Interiors  
Floors

## Extras

Winter Liners  
Insulation  
Skylight  
Air Chairs  
Eco Toilet  
Floating Bed

## Technical Information

Fabric Options  
Floor Plans

# Wood Stove



Each dome comes with a stove vent flashing and pipe cap for wood stove installation. Comfortable temperatures can be maintained inside the dome while snow flurries outside.

---

Email: [info@pacificdomes.com](mailto:info@pacificdomes.com)

247 Granite Street  
Ashland, OR 97520

1-888-488-8127  
1-541-488-7737

©2001 Pacific Domes

this web site is a [mediajam](#) creation

Frame Diagrams  
Engineering Specs  
Anchoring  
Fabric Treatment:

Order Info

Prices  
Shipping

Contact Us

Links

Photos

Mandalas





## Dome Sizes

- 16ft Dome
- 16ft Riser
- 20ft Dome
- 24ft Dome
- 30ft Dome
- 36ft Dome
- 44ft Dome
- 60ft Dome

## Why Domes

- Shelters
- Event Dome
- Playground
- Greenhouse
- projection
- Mandala

## Features

- Frame
- Covers
- Door
- Windows
- Wood Stove
- Screens
- Connecting
- Interiors
- Floors

## Extras

- Winter Liners
- Insulation
- Skylight
- Air Chairs

## Screens



20 ft. dome roof screen

Each dome comes with a zip off roof and a roof screen. The zipper design enables the roof to be opened partially or completely from the inside. The side wall zips open and has screening for increased ventilation. The door screen velcros on easily.



Eco Toilet  
Floating Bed

## Technical Information

Fabric Options  
Floor Plans  
Frame Diagrams  
Engineering Specs  
Anchoring  
Fabric Treatment

## Order Info

Prices  
Shipping

## Contact Us

## Links

## Photos

## Mandalas



16 ft. dome door screen



20 ft. dome base screen

---

[Email: info@pacificdomes.com](mailto:info@pacificdomes.com)

247 Granite Street  
Ashland, OR 97520  
©2001 Pacific Domes

1-888-488-8127  
1-541-488-7737





Connecting Domes..... **coming soon.**

## Dome Sizes

16ft Dome  
16ft Riser  
20ft Dome  
24ft Dome  
30ft Dome  
36ft Dome  
44ft Dome  
60ft Dome

## Why Domes

Shelters  
Event Dome  
Playground  
Greenhouse  
projection  
Mandala

## Features

Frame  
Covers  
Door  
Windows  
Wood Stove  
Screens  
Connecting  
Interiors  
Floors

## Extras

Winter Liners  
Insulation  
Skylight  
Air Chairs  
Eco Toilet  
Floating Bed

## Technical Information

---

[Email: info@pacificdomes.com](mailto:info@pacificdomes.com)

247 Granite Street                      1-888-488-8127  
Ashland, OR 97520                      1-541-488-7737  
©2001 Pacific Domes

Fabric Options  
Floor Plans  
Frame Diagrams  
Engineering Specs  
Anchoring  
Fabric Treatment:

Order Info

Prices  
Shipping

Contact Us

Links

Photos

Mandalas





## Dome Sizes

16ft Dome  
16ft Riser  
20ft Dome  
24ft Dome  
30ft Dome  
36ft Dome  
44ft Dome  
60ft Dome

## Why Domes

Shelters  
Event Dome  
Playground  
Greenhouse  
projection  
Mandala

## Features

Frame  
Covers  
Door  
Windows  
Wood Stove  
Screens  
Connecting  
Interiors  
Floors

## Extras

Winter Liners  
Insulation  
Skylight  
Air Chairs  
Eco Toilet  
Floating Bed

## Technical Information

Fabric Options  
Floor Plans

# Interior Design

The spacious feel and High ceilings of our domes create a beautiful space for interior design.



30 ft. dome - living room, 2 bedrooms, kitchen & bath

Domes have a ceiling high enough to accommodate a loft.



Sleeping lofts in 20 ft domes



Frame Diagrams  
Engineering Specs  
Anchoring  
Fabric Treatment

Order Info

Prices  
Shipping

Contact Us

Links

Photos

Mandalas



**Loft in 44ft Dome**

Clear Plexiglass loft 14 feet high in a 44 ft dome with corner of roof flap closed (above) and open to view the sky (right). The frame is powder coated orange. White back reflectix is wedged behind the frame for insulation.



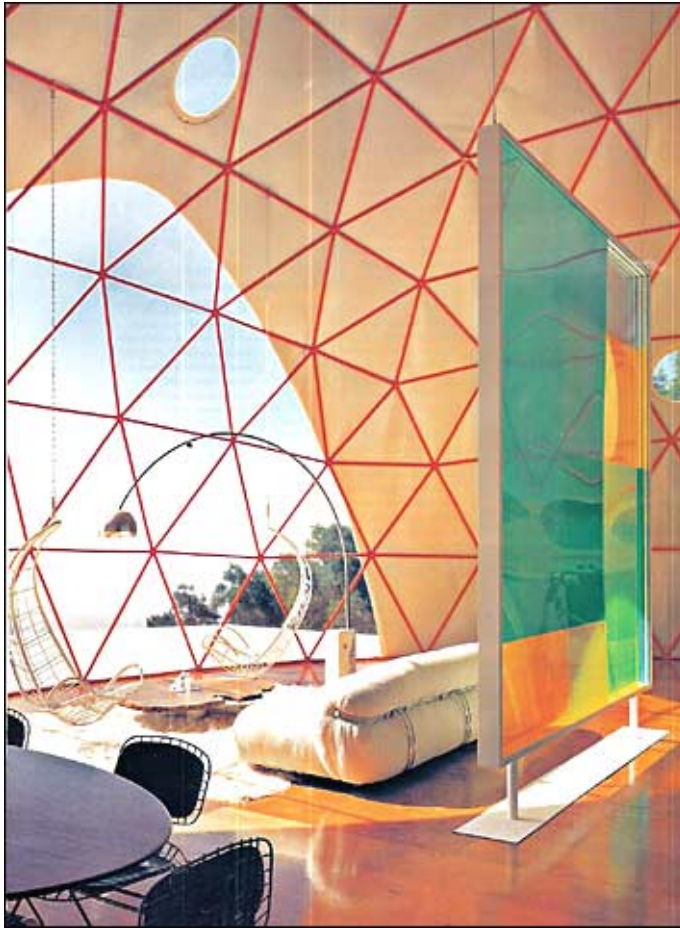

44 ft dome is interior designers home in Ojai, Ca.



"Beam me up, Scottie!"  
Designer's toilet. (above)

---

[Email: info@pacificdomes.com](mailto:info@pacificdomes.com)

247 Granite Street  
Ashland, OR 97520  
©2001 Pacific Domes

1-888-488-8127  
1-541-488-7737



## Dome Sizes

16ft Dome  
16ft Riser  
20ft Dome  
24ft Dome  
30ft Dome  
36ft Dome  
44ft Dome  
60ft Dome

## Why Domes

Shelters  
Event Dome  
Playground  
Greenhouse  
projection  
Mandala

## Features

Frame  
Covers  
Door  
Windows  
Wood Stove  
Screens  
Connecting  
Interiors  
Floors

## Extras

Winter Liners  
Insulation  
Skylight  
Air Chairs  
Eco Toilet  
Floating Bed

## Technical Information

Fabric Options  
Floor Plans  
Frame Diagrams  
Engineering Specs  
Anchoring  
Fabric Treatment

## Order Info

# Floors



24 ft. dome mandala floor

The Domes are designed to be used with one of our pre-designed floor plans. We offer three different plans: Portable Mandala floor plan, Stationary Joist floor plan, and the Perimeter Plan for use with an earthen floor. Some of our customers have used cob floors or poured a cement slab with radiant heating. Cement can be painted and coated with polyurethane. [Click here](#) to go to our floor plans download page.

[Email: info@pacificdomes.com](mailto:info@pacificdomes.com)

247 Granite Street  
Ashland, OR 97520  
©2001 Pacific Domes

1-888-488-8127  
1-541-488-7737

this web site is a [mediajam](#) creation



Prices  
Shipping

Contact Us

Links

Photos

Mandalas





## Dome Sizes

16ft Dome  
16ft Riser  
20ft Dome  
24ft Dome  
30ft Dome  
36ft Dome  
44ft Dome  
60ft Dome

## Why Domes

Shelters  
Event Dome  
Playground  
Greenhouse  
projection  
Mandala

## Features

Frame  
Covers  
Door  
Windows  
Wood Stove  
Screens  
Connecting  
Interiors  
Floors

## Extras

Winter Liners  
Insulation  
Skylight  
Air Chairs  
Eco Toilet  
Floating Bed

## Technical Information

Fabric Options  
Floor Plans  
Frame Diagrams  
Engineering Specs  
Anchoring  
Fabric Treatment

## Order Info

Prices  
Shipping

## Contact Us

# Winter Liners

**This 16 ft dome, 8000 feet high in the mountains of Telluride, Colorado, provides a cozy shelter. Painted green with our [Thermoshield](#) paint, it is camouflaged in the spring and summer.**



Pacific Dome liners are made of a light weight, flame retardant, white polyester. They tie to the inside of the frame and are easy to install. A matching big window is built into each liner and the round windows are left exposed and accessible for ventilation. For more temperate climates we offer the roof liner separately. For a small percentage of the cost of a full liner, you can have a large percentage of the insulative value with just the roof line. The liner can also be artistically painted with acrylic paint.

We offer a separate roofliner for temperate climates. It will provide about 50% of the insulative value of the complete winter liner for a small percentage of the cost. For moderate climates we recommend starting with the roof liner and, if necessary, adding the rest of the liner to complete it.

### Complete Winter Liner (shipping included):

16' \$1,130  
20' \$1,835  
24' \$2,680  
30' \$3,330  
36' \$5,170  
44' \$6,730  
60' \$12,500



Links

Photos

Mandalas



**Roof Liner (shipping included):**

- 16' \$150
- 20' \$350
- 24' \$500
- 30' \$550
- 36' \$850
- 44' \$1,400
- 60' \$2,600



---

[Email: info@pacificdomes.com](mailto:info@pacificdomes.com)

247 Granite Street  
Ashland, OR 97520  
©2001 Pacific Domes

1-888-488-8127  
1-541-488-7737



## Dome Sizes

16ft Dome  
16ft Riser  
20ft Dome  
24ft Dome  
30ft Dome  
36ft Dome  
44ft Dome  
60ft Dome

## Why Domes

Shelters  
Event Dome  
Playground  
Greenhouse  
projection  
Mandala

## Features

Frame  
Covers  
Door  
Windows  
Wood Stove  
Screens  
Connecting  
Interiors  
Floors

## Extras

Winter Liners  
Insulation  
Skylight  
Air Chairs  
Eco Toilet  
Floating Bed

## Technical Information

## Insulation

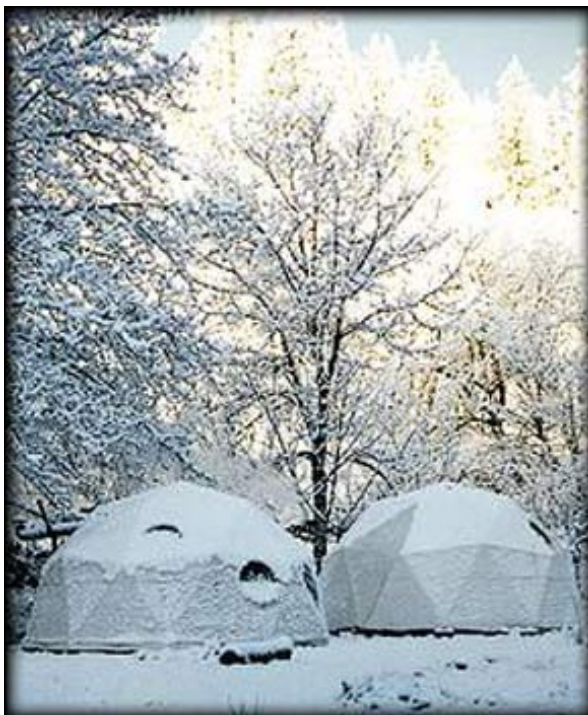

**Two 16 ft domes in Oregon**



**instilation of insulation**

Reflectix insulation consists of two layers of bubble pack with foil on either side. Cut into triangles, it is easy to install. The liner is then tied covering the reflectix, creating an approximate R value of 12. It is also available in White (on one side) for those who choose not to purchase a Winter Liner.

We have a customer in a 30ft dome with a complete winter liner and reflectix that reports 22 degree below zero and the dome maintains an even 65 to 70 degree with the wood stove going. If the fire dies out at night it never drops below 50.

Fabric Options  
Floor Plans  
Frame Diagrams  
Engineering Specs  
Anchoring  
Fabric Treatment:

Order Info

Prices  
Shipping

Contact Us

Links

Photos

Mandalas



**44 ft dome in California with white back Reflectix before canvas was put on.**



**Same dome showing interior. Reflectix allows orange powdercoated frame to show.**

**Reflectix Insulation Prices:**

**Complete Silver Reflectix:**

- 16 ft - \$235
- 20 ft - \$420
- 24 ft - \$510
- 30 ft - \$640
- 36 ft - \$940
- 44 ft - \$1,600
- 60 ft - \$3,200

**Complete White Back Reflectix:**

- 16 ft - \$250
- 20 ft - \$420
- 24 ft - \$550
- 30 ft - \$650
- 36 ft - \$980
- 44 ft - \$1,720
- 60 ft - \$3,600

**Roof Silver Reflectix:**

- 16 ft - \$ 75
- 20 ft - \$130
- 24 ft - \$140
- 30 ft - \$145
- 36 ft - \$185
- 44 ft - \$360
- 60 ft - \$690

**Roof White Back Reflectix:**

- 16 ft - \$ 75
- 20 ft - \$130
- 24 ft - \$140
- 30 ft - \$150
- 36 ft - \$185
- 44 ft - \$360
- 60 ft - \$690

**Prices include patterns, instructions, and tape.**

---

[Email: info@pacificdomes.com](mailto:info@pacificdomes.com)

247 Granite Street  
Ashland, OR 97520  
©2001 Pacific Domes

1-888-488-8127  
1-541-488-7737



## Dome Sizes

16ft Dome  
16ft Riser  
20ft Dome  
24ft Dome  
30ft Dome  
36ft Dome  
44ft Dome  
60ft Dome

## Why Domes

Shelters  
Event Dome  
Playground  
Greenhouse  
projection  
Mandala

## Features

Frame  
Covers  
Door  
Windows  
Wood Stove  
Screens  
Connecting  
Interiors  
Floors

## Extras

Winter Liners  
Insulation  
Skylight  
Air Chairs  
Eco Toilet  
Floating Bed

## Sky Light

Our optional skylight zips in, replacing the roof of any size dome. Made of UV resistant clear vinyl, the seams are RF welded. It is optional in our canopy line. There is an additional charge for a skylight in our Suncoat and Army Duck lines.

|                                  |               |
|----------------------------------|---------------|
| <b>Skylight in 16'</b>           | <b>\$350</b>  |
| <b>Skylight in 20', 24', 30'</b> | <b>\$500</b>  |
| <b>Skylight in 36'</b>           | <b>\$1000</b> |
| <b>Skylight in 44'</b>           | <b>\$1800</b> |
| <b>Skylight in 60'</b>           | <b>\$2400</b> |



a small skylight in the top pentagon only is also available for **\$350** in any dome.



## Technical Information

Fabric Options  
Floor Plans  
Frame Diagrams  
Engineering Specs  
Anchoring  
Fabric Treatment

## Order Info

Prices  
Shipping

## Contact Us

## Links

## Photos

## Mandalas



---

[Email: info@pacificdomes.com](mailto:info@pacificdomes.com)

247 Granite Street  
Ashland, OR 97520  
©2001 Pacific Domes

1-888-488-8127  
1-541-488-7737





# Air Chairs

## Dome Sizes

- 16ft Dome
- 16ft Riser
- 20ft Dome
- 24ft Dome
- 30ft Dome
- 36ft Dome
- 44ft Dome
- 60ft Dome

## Why Domes

- Shelters
- Event Dome
- Playground
- Greenhouse
- projection
- Mandala

## Features

- Frame
- Covers
- Door
- Windows
- Wood Stove
- Screens
- Connecting
- Interiors
- Floors

## Extras

- Winter Liners
- Insulation
- Skylight
- Air Chairs
- Eco Toilet
- Floating Bed

## Technical Information

- Fabric Options
- Floor Plans
- Frame Diagrams
- Engineering Specs
- Anchoring
- Fabric Treatment

## Order Info

- Prices
- Shipping



Enjoy your dome floating in the comfort of a Pacific Dome air chair. Hung from any hub, they will support up to 350 pounds. The fabric will not fade or mildew with outdoor use. Offered in adult and children sizes, the air chair makes a great swing.

**Air Chairs** (shipping & handling \$20): Available in Blue, Brown, Green, Red, Purple  
**Adult** - \$100  
**Child** - \$ 85  
**Footrest** - \$20



Available Colors

Contact Us

Links

Photos

Mandalas



---

[Email: info@pacificdomes.com](mailto:info@pacificdomes.com)

247 Granite Street  
Ashland, OR 97520  
©2001 Pacific Domes

1-888-488-8127  
1-541-488-7737



## Dome Sizes

16ft Dome  
16ft Riser  
20ft Dome  
24ft Dome  
30ft Dome  
36ft Dome  
44ft Dome  
60ft Dome

## Why Domes

Shelters  
Event Dome  
Playground  
Greenhouse  
projection  
Mandala

## Features

Frame  
Covers  
Door  
Windows  
Wood Stove  
Screens  
Connecting  
Interiors  
Floors

## Extras

Winter Liners  
Insulation  
Skylight  
Air Chairs  
Eco Toilet  
Floating Bed

## Technical Information

Fabric Options  
Floor Plans  
Frame Diagrams  
Engineering Specs  
Anchoring  
Fabric Treatment

# BioLet

## BioLet in a Pacific Dome!

Now in the sixth generation of continually improving product lines, BioLet Composting Toilets brought to you through Pacific Domes are as non-offensive and comfortable to use as regular flush toilets. However, the main advantage over flush toilets is that there is **no need for costly installations of water, sewer lines or connection to septic systems**. The BioLet Composting Toilet is a patented biological waste treatment system that evaporates excessive moisture and decomposes human waste with the help of nature's own microorganisms. The controlled supply of heat and air and the periodic mixing of the compost speeds up the decomposition processes and transforms human waste into a harmless, useful product. BioLet Composting Toilets do not pollute our lakes, streams, oceans, or the ground, and generate an end product beneficial for the soil without using valuable water.

[With 5 models to choose from](#), BioLet has the perfect solution for your Pacific Dome or just about anywhere a conventional toilet is not practical or economical. [Take a look](#).

There is always a BioLet model to meet your individual need!

BioLet composting toilets are efficient, compact and reliable appliances which can be easily installed in any Pacific Dome! All models are manufactured from durable, easy to clean ABS plastic and non-corroding stainless steel and are backed by over 25 years of experience, a three year limited warranty and toll free customer support! Choose the BioLet that is right for you from five different models!

## BioLet Models

| Toilet   | Full-Time    | Part-Time    | Occasional Overload* | Type         |
|----------|--------------|--------------|----------------------|--------------|
| XL       | 4 People     | 6 People     | 12 People            | Electric     |
| Deluxe   | 3 People     | 4 People     | 8 People             | Electric     |
| Standard | 3 People     | 4 People     | 8 People             | Electric     |
| Basic    | 2 People     | 3 People     | 6 People             | Non-Electric |
| NE       | 4 - 6 People | 4 - 6 People | 12 People            | Non-Electric |

\*Maximum 1 day

**The BioLet is easy to install in your  
PACIFIC DOME!**

Order Info

Prices

Shipping

Contact Us

Links

Photos

Mandalas



1. Fasten the BioLet to the wall or Dome strut.
2. Make a hole in the ceiling for the ventilation pipe. Ask for Dome fitting when ordering your Biolet.
3. Push the outer pipe into the roof flashing and seal it carefully.
4. Empty the bag of compost starter into the BioLet.
5. Plug into grounded outlet.
6. The BioLet is ready to be used in your Pacific Dome.

---

[Email: info@pacificdomes.com](mailto:info@pacificdomes.com)

247 Granite Street  
Ashland, OR 97520  
©2001 Pacific Domes

1-888-488-8127  
1-541-488-7737



### Dome Sizes

- 16ft Dome
- 16ft Riser
- 20ft Dome
- 24ft Dome
- 30ft Dome
- 36ft Dome
- 44ft Dome
- 60ft Dome

### Why Domes

- Shelters
- Event Dome
- Playground
- Greenhouse
- projection
- Mandala

### Features

- Frame
- Covers
- Door
- Windows
- Wood Stove
- Screens
- Connecting
- Interiors
- Floors

### Extras

- Winter Liners
- Insulation
- Skylight
- Air Chairs
- Eco Toilet
- Floating Bed

### Technical Information

- Fabric Options
- Floor Plans
- Frame Diagrams
- Engineering Specs
- Anchoring
- Fabric Treatment

### Order Info

- Prices
- Shipping

### Contact Us

### Links

### Photos

## The Floating Bed

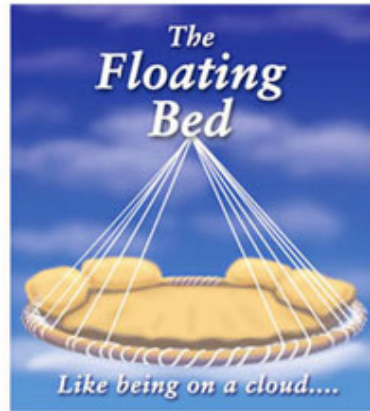

### All Beds have:

- Stainless Steel Frame, collapsible, can ship UPS, be checked as airline baggage.
- Highest quality Polyester Cascade Lines and Rope Net.
- All beds are weather resistant and UV resistant, suitable for outdoor use.

Beds A & B have

- Padded Frame Cover, Sunbrella outdoor fabric
- Memory Foam Mattress

### Frequently Asked Questions:

#### Where can I put it?

In the bedroom, recreation room as a sofa, use as a guest bed (hoist up against the ceiling, out of the way), as a hammock in your yard, or as a camp bed & tent (sleep cozy, above the wet ground). It can turn an unused space into your favorite place!

#### Can my ceiling hold it?

No problem. We have instructions and ceiling hardware to distribute the weight. We also have 4-pod stands, for fixed yard use, or portable use.

#### How strong is it?

Strong enough to easily hold 6 or more adults

#### Will the motion bother me?

For most people, no. In fact, after a few nights use, the question we usually get is, How can I make it rock more?

### Prices:

- **A-Bed:** \$3095 Large size Bed (8' x 6'), with padded frame, and memory foam mattress, rope net.
- **B-Bed:** \$2995 Regular size Bed (7' x 6'), with padded frame, and memory foam mattress, and rope net. (PIC)
- **C-Bed:** \$2495 Regular size outdoor Bed (7' x 6'), with stainless steel (unpadded) frame, rope net, with no mattress.

### Shipping

Box is 8x20x72 shipping \$50 in the

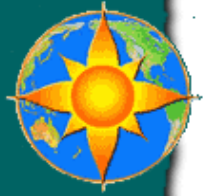

continental US, \$40 for the Memory  
Foam Mattress

## What's so great about The Floating Bed?

It's fun, romantic, yet practical And it looks pretty cool too. (Your friends can't wait to try it out.) But the other great feature is the better quality of rest you'll have. It feels like floating on a cloud. The suspension conforms to your body. Its unique 360° true pendulum motion creates a super-relaxed resting state. It gently rocks you to sleep. You will have more pleasant dreams. It's impossible to really explain it, but you'll know it, once you get in. Many people refuse to go back to an old-fashioned bed, after a night on the Floating Bed.

The hinges allow you to take it out of the box and set it up in minutes, once a suitable hanging ring is installed. It's lever action lets you choose your net tension, so the resting surface is very flat. Overhead suspension makes it safer, stable, and more fun than a hammock. It folds into a UPS-able box, that 1 person can carry. Can your bed do all that?

---

[Email: info@pacificdomes.com](mailto:info@pacificdomes.com)

247 Granite Street  
Ashland, OR 97520  
©2001 Pacific Domes

1-888-488-8127  
1-541-488-7737



**Dome Sizes**

- 16ft Dome
- 16ft Riser
- 20ft Dome
- 24ft Dome
- 30ft Dome
- 36ft Dome
- 44ft Dome
- 60ft Dome

**Why Domes**

- Shelters
- Event Dome
- Playground
- Greenhouse
- projection
- Mandala

**Features**

- Frame
- Covers
- Door
- Windows
- Wood Stove
- Screens
- Connecting
- Interiors
- Floors

**Extras**

- Winter Liners
- Insulation
- Skylight
- Air Chairs
- Eco Toilet
- Floating Bed

**Technical Information**

- Fabric Options
- Floor Plans
- Frame Diagrams
- Engineering Support
- Anchoring
- Fabric Treatment

**Order Info**

- Prices
- Shipping

# Fabric Options

**Suncoat (20 oz.)**

Suncoat is made of 100% cotton Army Duck with a water sealant, flame retardant, UV and mildew protectant finish. The luminescent wall allows for solar passive heating. It is our most natural and least expensive shelter system line. It has a five to ten year life expectancy. Our [Thermoshield paint](#), which comes in many colors, can extend the life indefinitely.

**Canopy FS™ (16 oz.) and Canopy Plus™ (19 oz.)**

Canopy FS™ and Canopy Plus™ consist of a polyester base fabric coated with a layer of vinyl and finished with a patented vinyl laminate. It is a backlit fabric, allowing for light penetration that equals or exceeds our natural fabrics. Both materials are waterproof and very resistant to UV, mildew, dirt and stains, and are easy to clean. Canopy FS has a life expectancy of 8-12 years. Canopy Plus takes Canopy FS to another level. With the addition of Rexam's Fluorex-P protective film we have maximized the resistance to UV, harsh weather, air pollutants, dirt and mildew. This product has a 12-20 year life expectancy.

**Canopy FS™ and Canopy Plus™ Color Options**



**Fabric Comparison Chart**

| Suncoat<br>100% cotton                   | Canopy FS Vinyl®                         | Canopy Plus® Vinyl                             | Event Cover 100% Polyester                                   |
|------------------------------------------|------------------------------------------|------------------------------------------------|--------------------------------------------------------------|
| • Flame resistant                        | • Flame resistant                        | • Flame resistant                              | • Flame Resistant                                            |
| • Water resistant                        | • Water resistant                        | • Water resistant                              | • Water resistant                                            |
| • Highly resistant to mildew             | • Highly resistant to mildew             | • Highly resistant to mildew                   | • Highly resistant to mildew                                 |
| • UV protected                           | • Highly Luminous                        | • Highly Luminous                              |                                                              |
| • 20 ounces per sq./yrd                  | • 16 oz./sq.yrd                          | • 19 oz./sq.yrd                                | • 4 oz./sq.yrd                                               |
| • Life Expectancy 5-10 years             | • Life Expectancy 8-12 years             | • Life Expectancy 12-20 years                  | • Life Expectancy for events 5 years (1 year continuous use) |
| • Pacific Domes offers a 5 year warranty | • Pacific Domes offers a 8 year warranty | • Pacific Domes offers a 12 year warranty      | • Pacific Domes offers a 1 year warranty                     |
|                                          |                                          | • Life Expectancy of Canopy Plus® 12-20 years. |                                                              |

**Package prices for different fabrics**

| Fabric               | Suncoat  | Canopy FS® | Canopy Plus® |
|----------------------|----------|------------|--------------|
| 16 ft. Dome Package  | \$ 3,200 | \$ 3,600   | \$ 4,800     |
| 16 ft. Riser Package | \$ 4,000 | \$ 4,800   | \$ 5,400     |
| 20 ft. Dome Package  | \$ 5,300 | \$ 6,600   | \$ 7,600     |
| 24 ft. Dome Package  | \$ 7,800 | \$9,400    | \$ 11,000    |

Contact Us

Links

Photos

Mandalas



|                     |                  |                  |                  |
|---------------------|------------------|------------------|------------------|
| 30 ft. Dome Package | <b>\$ 9,400</b>  | <b>\$ 11,600</b> | <b>\$ 13,800</b> |
| 36 ft. Dome Package | <b>\$ 14,900</b> | <b>\$ 18,000</b> | <b>\$ 21,200</b> |
| 44 ft. Dome Package | <b>\$ 20,000</b> | <b>\$ 24,300</b> | <b>\$ 30,000</b> |
| 60 ft. Dome Package | <b>\$ 38,200</b> | <b>\$ 48,000</b> | <b>\$ 60,000</b> |

**[Click here for Event Skin Prices](#)**

---

[Email: info@pacificdomes.com](mailto:info@pacificdomes.com)

247 Granite Street  
Ashland, OR 97520  
©2001 Pacific Domes

1-888-488-8127  
1-541-488-7737





## Dome Sizes

16ft Dome  
16ft Riser  
20ft Dome  
24ft Dome  
30ft Dome  
36ft Dome  
44ft Dome  
60ft Dome

## Why Domes

Shelters  
Event Dome  
Playground  
Greenhouse  
projection  
Mandala

## Features

Frame  
Covers  
Door  
Windows  
Wood Stove  
Screens  
Connecting  
Interiors  
Floors

## Extras

Winter Liners  
Insulation  
Skylight  
Air Chairs  
Eco Toilet  
Floating Bed

## Technical Information

Fabric Options  
Floor Plans  
Frame Diagrams  
Engineering Specs  
Anchoring  
Fabric Treatment

## Order Info

Prices  
Shipping

## Contact Us

# Floor Plans

The following deck plans are in Adobe Acrobat format. To download a file simply click on the associated plan. If you need Acrobat Reader click this link.



| Floorplans:                                           | Wood floor Material Estimate: Mid July '99             |
|-------------------------------------------------------|--------------------------------------------------------|
| <a href="#">16ft deck plan<br/>(and 16ft w/riser)</a> | 16' \$700 Pie 30 hrs \$600 Joist 50 hrs 200 sqft       |
| <a href="#">20ft deck plan</a>                        | 20' \$850 Pie 70 hrs \$700 Joist 50 hrs 425 sqft       |
| <a href="#">24ft deck plan</a>                        | 24' \$1200 Pie 85 hrs \$1050 Joist 60 hrs 425 sqft     |
| <a href="#">30ft deck plan</a>                        | 30' \$2000 Star 140 hrs \$1850 Joist 100 hrs 700 sqft  |
| <a href="#">36ft deck plan</a>                        | 36' \$2300 Star 200 hrs \$2100 Joist 150 hrs 1018 sqft |
| <a href="#">44ft deck plan</a>                        | 44' \$4500 Joist                                       |

## Cob Floors For Domes

Cob is a natural building material made from clay, sand, straw and water. Cob is an inexpensive alternative to wood or cement. Cob floors have an earthy and organic feel and can often be made from materials already available.

[Email: info@pacificdomes.com](mailto:info@pacificdomes.com)

247 Granite Street  
Ashland, OR 97520  
©2001 Pacific Domes

1-888-488-8127  
1-541-488-7737

Links

Photos

Mandalas

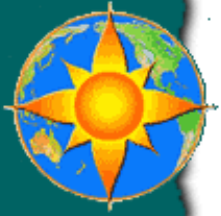



### Dome Sizes

- 16ft Dome
- 16ft Riser
- 20ft Dome
- 24ft Dome
- 30ft Dome
- 36ft Dome
- 44ft Dome
- 60ft Dome

### Why Domes

- Shelters
- Event Dome
- Playground
- Greenhouse
- projection
- Mandala

### Features

- Frame
- Covers
- Door
- Windows
- Wood Stove
- Screens
- Connecting
- Interiors
- Floors

### Extras

- Winter Liners
- Insulation
- Skylight
- Air Chairs
- Eco Toilet
- Floating Bed

## Frame Diagrams

### 16ft Dome Frame

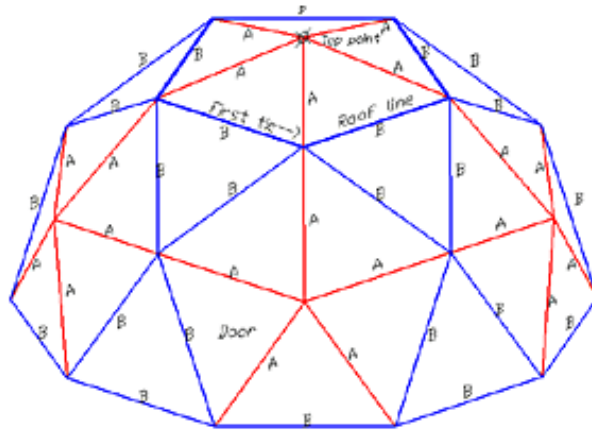

### 16ft Dome Frame w/ riser

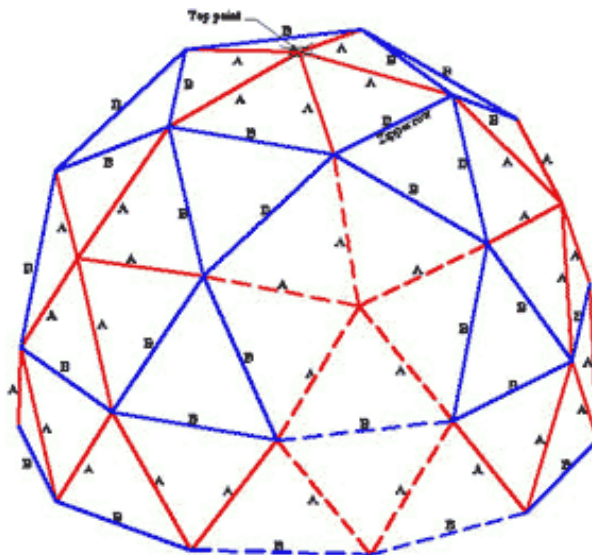

This pattern repeats itself 5 times  
Note the outside edges overlap

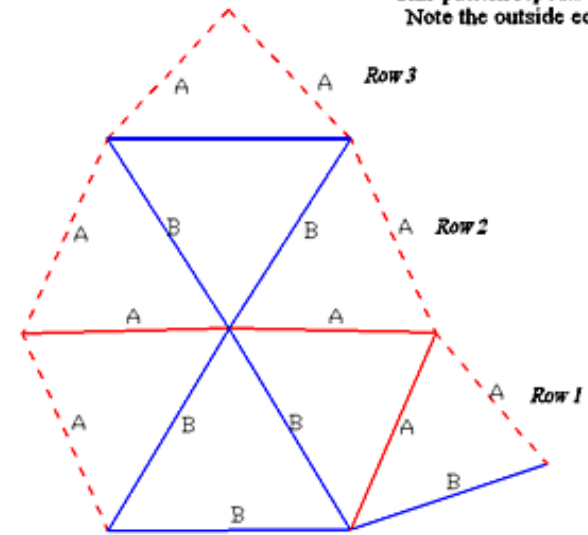

Technical Information

- Fabric Options
- Floor Plans
- Frame Diagrams
- Engineering Specs
- Anchoring
- Fabric Treatment

Order Info

- Prices
- Shipping

Contact Us

Links

Photos

Mandalas



### 20ft and 24ft Dome Frame

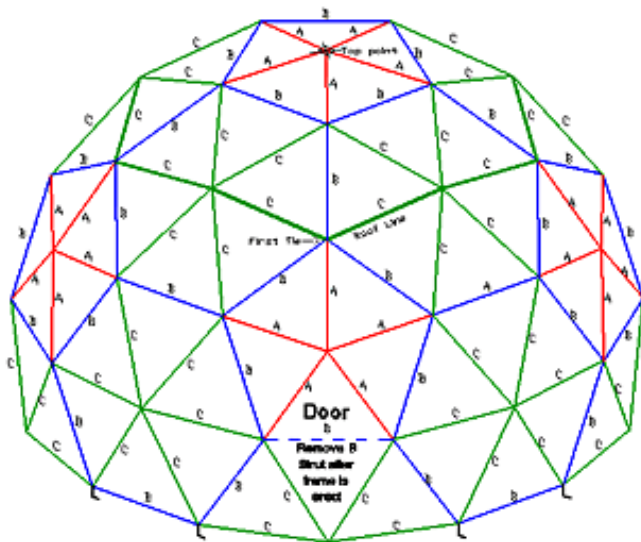

### 30ft Dome Frame

This pattern repeats itself five times. Note the outside edges overlap.

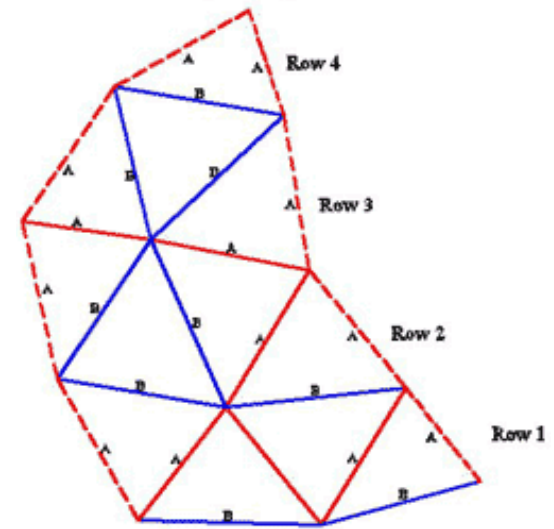

This pattern repeats itself 5 times. Note the outside edges overlap.

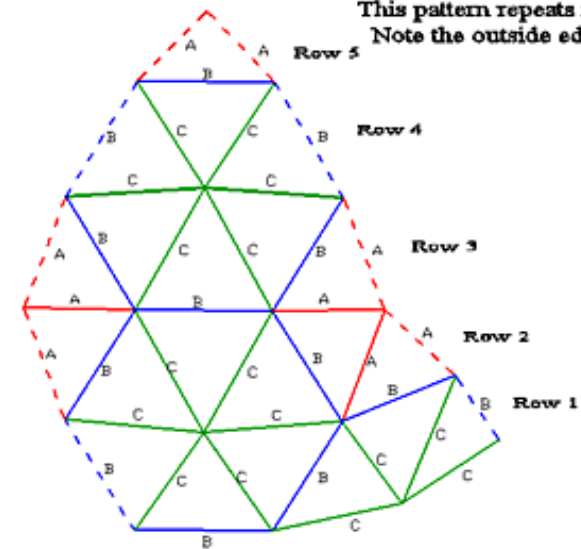

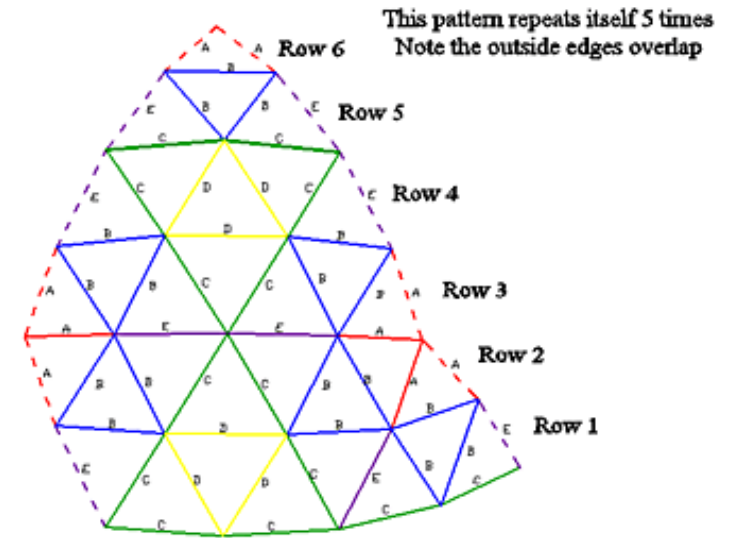
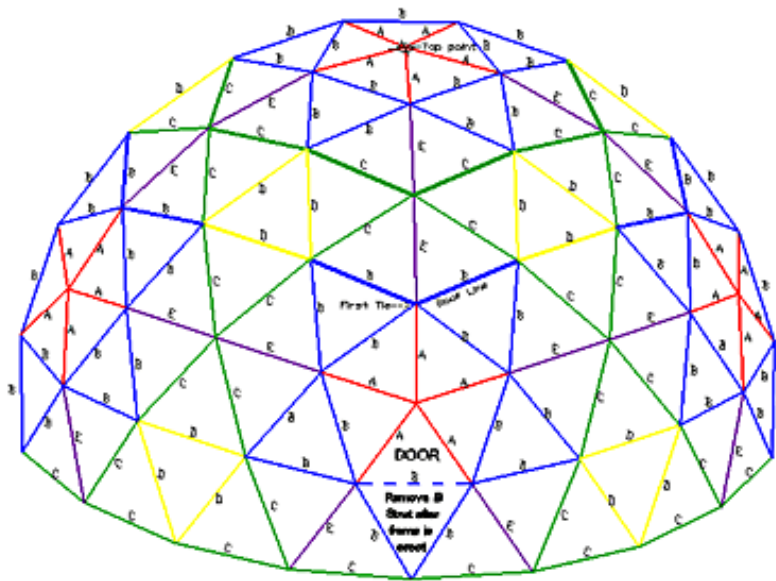

### 36ft Dome Frame

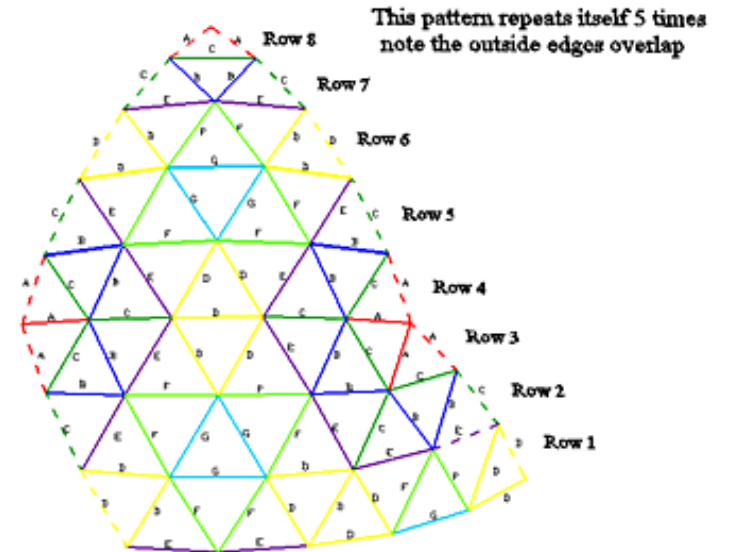
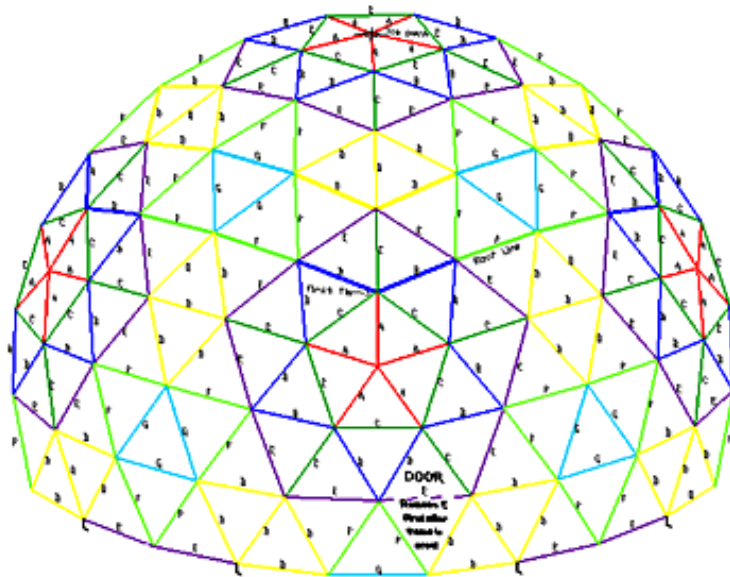

# 44ft and 60ft Dome Frame

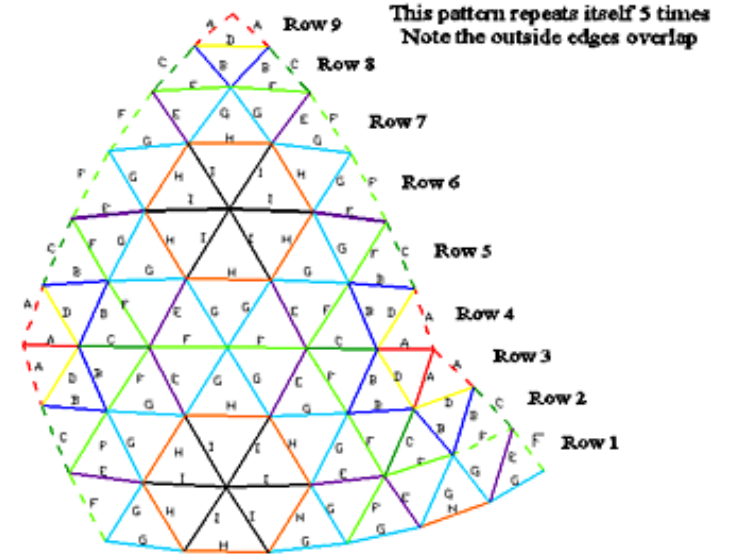
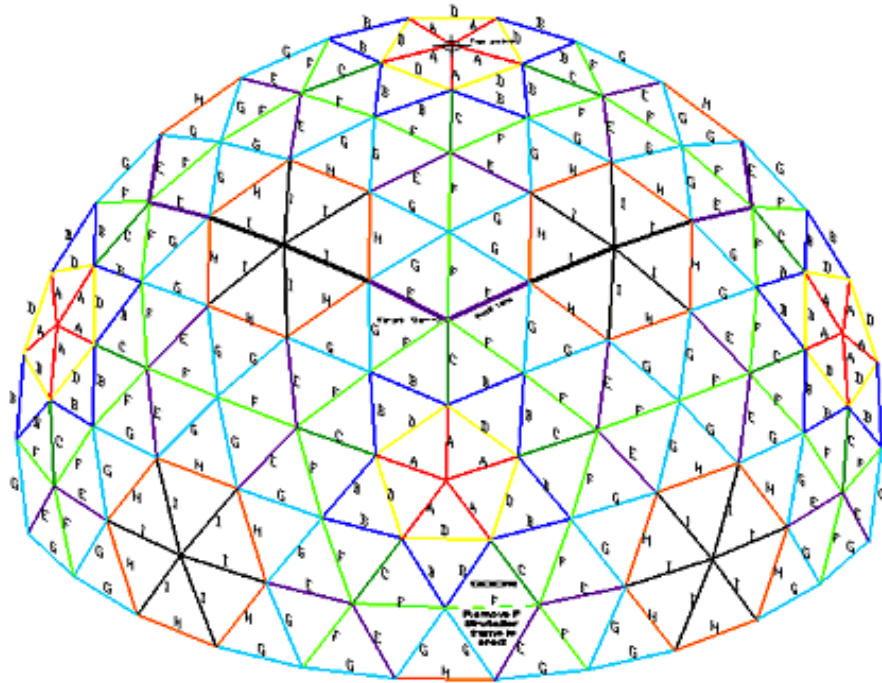

Email: [info@pacificdomes.com](mailto:info@pacificdomes.com)

247 Granite Street  
Ashland, OR 97520  
©2001 Pacific Domes

1-888-488-8127  
1-541-488-7737



## Dome Sizes

16ft Dome  
16ft Riser  
20ft Dome  
24ft Dome  
30ft Dome  
36ft Dome  
44ft Dome  
60ft Dome

## Why Domes

Shelters  
Event Dome  
Playground  
Greenhouse  
projection  
Mandala

## Features

Frame  
Covers  
Door  
Windows  
Wood Stove  
Screens  
Connecting  
Interiors  
Floors

## Extras

Winter Liners  
Insulation  
Skylight  
Air Chairs  
Eco Toilet  
Floating Bed

## Technical Information

# Engineering Specs

Pacific Domes are architecturally engineered by Waquidi Falicof, one of the only people on the planet with a PHD in Geodesic Design. Our Engineering program has a 200% safety margin. Engineering specifications are available upon request to all of our dome customers.

Below is a list of the maximum wind and snow loads for different tubing options available.

## Max Snow and Wind loads for 3/4", 1", and 1 1/4" EMT

|                 | <b>Max. Snow<br/>(lbs./sq. ft.)<br/>w/wind*</b> | <b>Max. Wind w/no<br/>snow***</b> |
|-----------------|-------------------------------------------------|-----------------------------------|
| 16' - 3/4"      | 20 @ 130 mph                                    | 150                               |
| 16' - 1"        | 45 @ 130 mph                                    | 195                               |
| 16' - 1<br>1/4" | 90 @ 130 mph                                    | 210                               |
| 20' - 3/4"      | 30 @ 130 mph                                    | 180                               |
| 20' - 1"        | 55 @ 130 mph                                    | 195                               |
| 20' - 1<br>1/4" | 90 @ 130 mph                                    | 205                               |
| 24' - 3/4"      | 20 @ 100 mph                                    | 125                               |
| 24' - 1"        | 40 @ 130 mph                                    | 160                               |
| 24' - 1<br>1/4" | 55 @ 130 mph                                    | 170                               |
| 30' - 3/4"      | 20 @ 95 mph                                     | 115                               |
| 30' - 1"        | 40 @ 110 mph                                    | 145                               |
| 30' - 1<br>1/4" | 50 @ 115 mph                                    | 155                               |

Fabric Options  
 Floor Plans  
 Frame Diagrams  
 Engineering Specs  
 Anchoring  
 Fabric Treatment:

## Order Info

Prices  
 Shipping

## Contact Us

## Links

## Photos

## Mandalas



|                                                    |              |     |
|----------------------------------------------------|--------------|-----|
|                                                    |              |     |
| 36' - 3/4"                                         | 20 @ 90 mph  | 110 |
| 36' - 1"                                           | 40 @ 90 mph  | 135 |
| 36' - 1<br>1/4"                                    | 45 @ 100 mph | 145 |
|                                                    |              |     |
| 44' - 3/4"                                         | 15 @ 75 mph  | 95  |
| 44' - 1"                                           | 30 @ 85 mph  | 120 |
| 44' - 1<br>1/4"                                    | 35 @ 90 mph  | 125 |
|                                                    |              |     |
| 60' - 3/4"                                         | n/a          |     |
| 60' - 1"                                           | 15 @ 50 mph  | 85  |
| 60' - 1<br>1/4"                                    | 20 @ 25 mph  | 90  |
|                                                    |              |     |
| *assume max. windload of 130 mph                   |              |     |
| ***assume proper anchoring to resist uplift forces |              |     |

[Email: info@pacificdomes.com](mailto:info@pacificdomes.com)

247 Granite Street  
 Ashland, OR 97520  
 ©2001 Pacific Domes

1-888-488-8127  
 1-541-488-7737





## Dome Sizes

16ft Dome  
16ft Riser  
20ft Dome  
24ft Dome  
30ft Dome  
36ft Dome  
44ft Dome  
60ft Dome

## Why Domes

Shelters  
Event Dome  
Playground  
Greenhouse  
projection  
Mandala

## Features

Frame  
Covers  
Door  
Windows  
Wood Stove  
Screens  
Connecting  
Interiors  
Floors

## Extras

Winter Liners  
Insulation  
Skylight  
Air Chairs  
Eco Toilet  
Floating Bed

## Technical Information

# Anchoring

## Anchoring Domes for High Wind Areas

Pacific Domes are designed to handle extreme winds. One of our 20 ft. domes survived 135 mph winds in Hurricane Andrew, and a 30' dome withstood 130 mph winds in the mountains of Chile. It is important to properly secure your dome to the ground if you live in an area with extreme winds or if your dome is not attached to a solid floor. We offer earth anchors for domes in high wind areas. Please contact us if you think your dome may require additional anchoring. The amount and size of anchors needed depends primarily on the size of the dome and the type of soil in your area. For anchoring Event Domes on asphalt - sandbags, water barrels, or asphalt anchors can be used. Pacific Domes is happy to assist in determining your anchoring requirements but cannot make decisions regarding engineering calculations

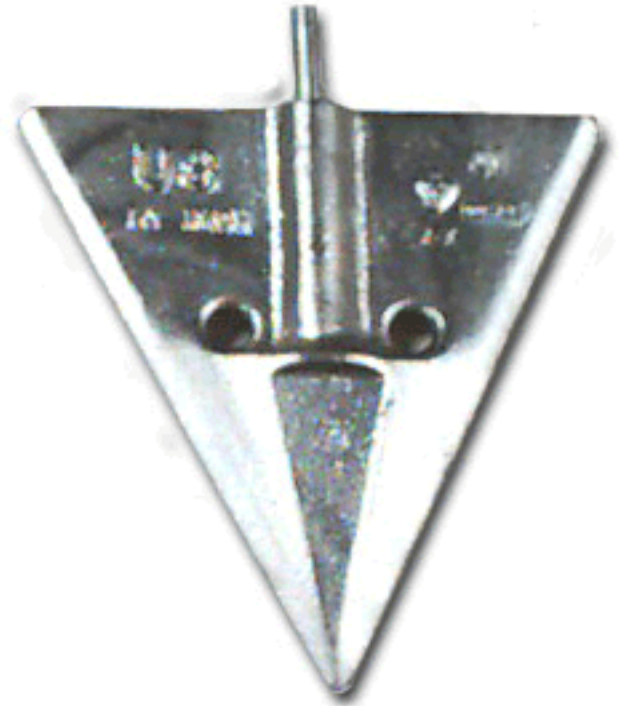

Fabric Options  
Floor Plans  
Frame Diagrams  
Engineering Specs  
Anchoring  
Fabric Treatment:

Order Info

Prices  
Shipping

Contact Us

Links

Photos

Mandalas



or other technical  
information specific to  
your situation.

[Check out Laconia Earth  
Anchors](#)

---

[Email: info@pacificdomes.com](mailto:info@pacificdomes.com)

247 Granite Street  
Ashland, OR 97520  
©2001 Pacific Domes

1-888-488-8127  
1-541-488-7737



## Dome Sizes

16ft Dome  
16ft Riser  
20ft Dome  
24ft Dome  
30ft Dome  
36ft Dome  
44ft Dome  
60ft Dome

## Why Domes

Shelters  
Event Dome  
Playground  
Greenhouse  
projection  
Mandala

## Features

Frame  
Covers  
Door  
Windows  
Wood Stove  
Screens  
Connecting  
Interiors  
Floors

## Extras

Winter Liners  
Insulation  
Skylight  
Air Chairs  
Eco Toilet  
Floating Bed

## Fabric Treatments

**Jump to:**

[Thermoshield/UV protection](#) " [Caulking](#) " [Waterproofing](#) " [Mildew Treatment](#)

## UV-Protection with Thermoshield comes in many colors



**Green Thermoshield Camouflages Michael's Dome in the Colorado Rockies. In the winter, with snow covered ground, he stays warm with elegant white thermoshield sprayed on the inside of his dome.**

Thermoshield is a non-toxic elastomeric paint available in many colors. It contains ceramic borosilicate microspheres that have been applied to space shuttles to prevent heat damage as they leave or re-enter the atmosphere. Tests have shown Thermoshield to have an R-value of 22 because of its reflective qualities. Coating the outside of your dome with Thermoshield will keep it cooler inside and protect the fabric from UV deterioration, thus extending the life of your dome cover. We recommend Thermoshield in areas with extreme UV exposure. When applied to the inside of the dome, it reflects heat back in and can cut utility use by 1/3. Thermoshield on the inside of the dome is more effective than our Reflectix and liner insulation packet. The dome will be heavier but remain portable with a thick coat of Thermoshield.

### **ADVANTAGES OF THERMOSHIELD:**

1. Extends the life of the fabric

## Technical Information

Fabric Options  
Floor Plans  
Frame Diagrams  
Engineering Specs  
Anchoring  
Fabric Treatment:

## Order Info

Prices  
Shipping

## Contact Us

## Links

## Photos

## Mandalas



2. Protects against ultraviolet light
3. Waterproofing guaranteed to last for 5 years with a good coat
4. Excellent insulation
5. Fire-resistant
6. Mildew-resistant
7. Variable permeability (moisture can escape but cannot get in)
8. Non-toxic in liquid and cured state
9. Cuts utility use by 1/3 when used on interior
10. Shows no sign of deterioration

**Thermoshield amounts per dome** (double these if you're coating both the inside and the outside)

- 16 ft. - 8 gallons
- 20 ft - 16 gallons
- 24 ft - 22 gallons
- 30 ft - 28 gallons
- 36 ft - 45 gallons
- 44 ft - 60 gallons
- 60 ft - 100 gallons

### PRICES:

\$40.00 per gallon (includes shipping within the United States)

\$40.00 per gallon for colors (Thermoshield color charts are available through Pacific Domes)

PLEASE NOTE: Thermoshield will reduce light penetration and breathability of the fabric.

## Caulking

Don't live with leaks! Lexel Clear Caulk will take care of any trouble spots. It has a 50 year warranty. It stays clear and can be applied in temperatures between 0 degrees and 100F to surfaces free of oil, dirt, frost and loose matter. It may take several hours to be tack free and 2-4 days to cure depending on the humidity. It can be purchased at most hardware stores.

## Waterproofing

Aquatite is a premium waterproofing compound recommended by Pacific Domes and the fabric manufacturer as the best waterproofing for canvas. Aquatite can be ordered through Pacific Domes.

### Aquatite Application Instructions:

You will need the following things on hand:

- an appropriate amount of Aquatite for your size dome
- some rags
- a sufficient size ladder to reach the roofline of the dome

- paint brushes, rollers, spray bottles or a hand-pump garden sprayer

The easiest way to apply Aquatite is with a hand-pump garden sprayer. A one or two gallon capacity sprayer is inexpensive and available from most granges or hardware stores. Please call Pacific Domes if you have questions. A spray bottle, brushes or rollers also work. Apply Aquatite on a dry and sunny day. Please note that the manufacturer strongly recommends keeping the fabric dry while the Aquatite is curing (24-48 hours after application).

1. If your dome is dirty, clean it using a mild soap solution and a soft scrub brush. Clean the window pockets well. If your dome has mildew on it, use a strong bleach solution to kill it (one part bleach to four parts water). A natural alternative to bleach can be found in the "Mildew Treatment" section of this website. Hose the canvas thoroughly to remove all the bleach salts so the bleach doesn't weaken the fabric. Make sure the fabric dries thoroughly before applying the water repellent.

2. If using a pump sprayer, use the circles of fabric that your dome frame came packed in to practice your spray stroke and to test the consistency of the sprayer.

3. Remove the vinyl windows. Apply an even coat of Aquatite to the exterior of your dome. We find it easiest to coat the main skin on the frame and the roof on a tarp. Use a brush to coat the fabric directly around the bay window and carry a rag to quickly wipe up any drips on the window.

4. Open up the round window frames with toothpicks. Apply Aquatite to the inside of the window frames. This will help protect the fabric from any dirt that may collect.

5. The fabric should stay dry for 24-48 hours after application.

Pacific Domes is not responsible for the outcome of your waterproofing job. If you have any questions or concerns please call us at (888) 488-8127.

## Mildew Treatment

Sponge down all mildew areas with a strong bleach solution (1 part bleach to 4 parts water). Wear gloves and have your dome well ventilated to avoid inhaling fumes. Mildew will turn pale when it dies. Hose the bleach salts off thoroughly. Avoid scrubbing off water repellent finish on fabric.

### Natural Mildew Treatment

One of our customers gave us this recipe as both a curative and a preventative for mildew growth.

Ingredients:

- 2 1/2 gallons water
- 20 drops Tea Tree Oil
- 1/4 cup Borax

- 1/2 cup white vinegar

**Mildew Prevention**

To prevent mildew keep your dome well ventilated and dry. Aquatite waterproofing will prevent mildew on Army Duck. Store your dome as dry as possible.

---

[Email: info@pacificdomes.com](mailto:info@pacificdomes.com)

247 Granite Street  
Ashland, OR 97520  
©2001 Pacific Domes

1-888-488-8127  
1-541-488-7737



## Dome Sizes

16ft Dome  
16ft Riser  
20ft Dome  
24ft Dome  
30ft Dome  
36ft Dome  
44ft Dome  
60ft Dome

## Why Domes

Shelters  
Event Dome  
Playground  
Greenhouse  
projection  
Mandala

## Features

Frame  
Covers  
Door  
Windows  
Wood Stove  
Screens  
Connecting  
Interiors  
Floors

## Extras

Winter Liners  
Insulation  
Skylight  
Air Chairs  
Eco Toilet  
Floating Bed

## Technical Information

Fabric Options  
Floor Plans  
Frame Diagrams  
Engineering Specs  
Anchoring  
Fabric Treatment

## Order Info

Prices  
Shipping

## Contact Us

## Links

## Photos

# Order Info

## Prices

### Each dome package includes:

- Complete 3/4" galvanized steel tube frame with hardware (1" on the 60ft dome)
- Canvas cover with bay window
- Round, removable windows with interchangeable screens
- Zip-off roof with interchangeable screen
- Base screens for maximum ventilation
- Weather-tight door with screen
- Stove vent flashing and pipe cap (stove flashing pocket is interchangeable with a window or screen)
- Hardware for anchoring dome to floor
- Dome Care Manual including floor plans and assembly instructions
- Custom window & door placements available

## Fabric Options

| Suncoat 100% Cotton                         | Canopy FS Vinyl®                            | Canopy Plus® Vinyl                                | Event Cover 100% Polyester                                         |
|---------------------------------------------|---------------------------------------------|---------------------------------------------------|--------------------------------------------------------------------|
| • Flame resistant                           | • Flame resistant                           | • Flame resistant                                 | • Flame Resistant                                                  |
| • Water resistant                           | • Water resistant                           | • Water resistant                                 | • Water resistant                                                  |
| • Highly resistant to mildew                | • Highly resistant to mildew                | • Highly resistant to mildew                      | • Highly resistant to mildew                                       |
| • UV protected                              | • Highly Luminous                           | • Highly Luminous                                 |                                                                    |
| • 20 ounces per sq./yrd                     | • 16 oz./sq.yrd                             | • 19 oz./sq.yrd                                   | • 4 oz./sq.yrd                                                     |
| • Life Expectancy<br>5-10 years             | • Life Expectancy<br>8-12 years             | • Life Expectancy<br>12-20 years                  | • Life Expectancy for events<br>5 years (1 year continuous<br>use) |
| • Pacific Domes offers a 5<br>year warranty | • Pacific Domes offers a 8<br>year warranty | • Pacific Domes offers a 12<br>year warranty      | • Pacific Domes offers a 1<br>year warranty                        |
|                                             |                                             | • Life Expectancy of Canopy<br>Plus® 12-20 years. |                                                                    |

## Fabric Prices per Dome size

| Fabric               | Suncoat   | Canopy FS® | Canopy Plus® |
|----------------------|-----------|------------|--------------|
| 16 ft. Dome Package  | \$ 3,200  | \$ 3,600   | \$ 4,800     |
| 16 ft. Riser Package | \$ 4,000  | \$ 4,800   | \$ 5,400     |
| 20 ft. Dome Package  | \$ 5,300  | \$ 6,600   | \$ 7,600     |
| 24 ft. Dome Package  | \$ 7,800  | \$9,400    | \$ 11,000    |
| 30 ft. Dome Package  | \$ 9,400  | \$ 11,600  | \$ 13,800    |
| 36 ft. Dome Package  | \$ 14,900 | \$ 18,000  | \$ 21,200    |
| 44 ft. Dome Package  | \$ 20,000 | \$ 24,300  | \$ 30,000    |
| 60 ft. Dome Package  | \$ 38,200 | \$ 48,000  | \$ 60,000    |

### [Click here for Event Skin Prices](#)

**Complete dome installation services offered. Call for details.**

**\* A 20% restock fee will be charged for all cancelled orders.**

## Extras

## Mandalas

**Doors:**

extra charge for:

**Prehung door** : no extra charge**Special Door:** \$150**Hexagonal or Round Door:** \$300**Extra Doors:****Prehung door** : \$200**Special Door:** \$350**Hexagonal or Round Door:** \$500**Skylight:** [see skylight page](#)**Winter Liners and Insulation:****Complete Winter Liner:**

16' \$1,130  
 20' \$1,835  
 24' \$2,680  
 30' \$3,330  
 36' \$5,170  
 44' \$6,730  
 60' \$12,500

**Roof Liner only:**

16 ft - \$140  
 20 ft - \$260  
 24 ft - \$300  
 30 ft - \$450  
 36 ft - \$800  
 44 ft - \$950  
 60 ft - \$1,600

**Complete Silver Reflectix:**

16 ft - \$235  
 20 ft - \$420  
 24 ft - \$510  
 30 ft - \$640  
 36 ft - \$940  
 44 ft - \$1,600  
 60 ft - \$3,200

**Complete White Back Reflectix:**

16 ft - \$250  
 20 ft - \$420  
 24 ft - \$550  
 30 ft - \$650  
 36 ft - \$980  
 44 ft - \$1,720  
 60 ft - \$3,600

**Roof Silver Reflectix:**

16 ft - \$ 75  
 20 ft - \$130  
 24 ft - \$140  
 30 ft - \$145  
 36 ft - \$185  
 44 ft - \$360  
 60 ft - \$690

**Roof White Back Reflectix:**

16 ft - \$ 75  
 20 ft - \$130  
 24 ft - \$140  
 30 ft - \$150  
 36 ft - \$185  
 44 ft - \$360  
 60 ft - \$690

**Prices include patterns, instructions, and tape.****Air Chairs:**

Adult - \$100  
 Child - \$ 85  
 Footrest - \$20

Available in Blue, Brown, Green, Red, Purple

**Floating Beds:****A-Bed:** \$3095 Large size Bed (8' x 6'), with padded frame, and memory foam mattress, rope net.**B-Bed:** \$2995 Regular size Bed (7' x 6'), with padded frame, and memory foam mattress, and rope net. (PIC)**C-Bed:** \$2495 Regular size outdoor Bed (7' x 6'), with stainless steel (unpadded) frame, rope net, with no mattress.**Dome Frames Only:**

16 ft. Dome - \$ 640  
 20 ft. Dome - \$ 1,540  
 24 ft. Dome - \$ 1,840  
 30 ft. Dome - \$ 2,400  
 36 ft. Dome - \$ 3,850  
 44 ft. Dome - \$ 5,120  
 60 ft. Dome - \$10,620  
 (60 ft. is a heavy duty frame)

**Additional Charge for Heavy Duty Frames:**

16 ft. Dome - \$250  
 20 ft. Dome - \$560  
 24 ft. Dome - \$630  
 30 ft. Dome - \$830  
 36 ft. Dome - \$1,400  
 44 ft. Dome - \$2,600

**Call for quote on Additional Charge for Powder Coating:**1-541-488-7737 **Toll Free:** 1-888-488-8127**Shipping Charges**

| Dome | Shipping Zones (see chart below) |   |   |   |   |   |   |
|------|----------------------------------|---|---|---|---|---|---|
| Size | 2                                | 3 | 4 | 5 | 6 | 7 | 8 |
|      |                                  |   |   |   |   |   |   |



|            |     |     |     |     |     |     |     |
|------------|-----|-----|-----|-----|-----|-----|-----|
| <b>16'</b> | 110 | 120 | 130 | 150 | 175 | 200 | 235 |
| <b>20'</b> | 190 | 215 | 230 | 260 | 305 | 355 | 405 |
| <b>24'</b> | 225 | 245 | 265 | 295 | 350 | 385 | 450 |

**30' to 60' domes are quoted individually based on your ZIP code. Please call for a quote.**

**(Shipping Frame only is 75% of normal shipping charge)**

### Shipping Zone Chart

| Zip Code | Zone | Zip Code | Zone | Zip Code | Zone | Zip Code | Zone |
|----------|------|----------|------|----------|------|----------|------|
| 004-005  | 8    | 516-560  | 7    | 734-739  | 6    | 919-929  | 5    |
| 010-089  | 8    | 561-562  | 6    | 740-745  | 7    | 930-939  | 4    |
| 100-339  | 8    | 563-564  | 7    | 746      | 6    | 940-942  | 3    |
| 342-374  | 8    | 565-576  | 6    | 747-789  | 7    | 7943     | 4    |
| 375      | 7    | 577      | 5    | 790-794  | 6    | 944-949  | 3    |
| 376-397  | 8    | 580-587  | 6    | 795-796  | 7    | 950-953  | 4    |
| 380-381  | 7    | 588-595  | 5    | 797-799  | 6    | 954      | 3    |
| 382-385  | 8    | 596-599  | 4    | 800-831  | 5    | 955      | 2    |
| 386-387  | 7    | 600-668  | 7    | 832-844  | 4    | 956-959  | 3    |
| 388-462  | 8    | 669-672  | 6    | 845      | 5    | 960      | 2    |
| 463-464  | 7    | 673      | 7    | 846-847  | 4    | 961      | 3    |
| 465-497  | 8    | 674-693  | 6    | 850-875  | 5    | 970-973  | 3    |
| 498-509  | 7    | 700-709  | 8    | 877-885  | 6    | 974-977  | 2    |
| 510-513  | 6    | 710-712  | 7    | 898-901  | 4    | 978      | 3    |
| 514      | 7    | 713-714  | 8    | 902-909  | 5    | 979-988  | 4    |
| 515      | 6    | 716-734  | 7    | 910-918  | 4    | 986      | 3    |
|          |      |          |      |          |      | 988-994  | 4    |

**Call Now to order  
1-888-488-8127**

**541-488-7737**

[Email: info@pacificdomes.com](mailto:info@pacificdomes.com)

247 Granite Street  
Ashland, OR 97520  
©2001 Pacific Domes

1-888-488-8127  
1-541-488-7737



## Dome Sizes

16ft Dome  
16ft Riser  
20ft Dome  
24ft Dome  
30ft Dome  
36ft Dome  
44ft Dome  
60ft Dome

## Why Domes

Shelters  
Event Dome  
Playground  
Greenhouse  
projection  
Mandala

## Features

Frame  
Covers  
Door  
Windows  
Wood Stove  
Screens  
Connecting  
Interiors  
Floors

## Extras

Winter Liners  
Insulation  
Skylight  
Air Chairs  
Eco Toilet  
Floating Bed

## Technical Information



247 Granite Street  
Ashland, OR 97520

[info@pacificdomes.com](mailto:info@pacificdomes.com)

**Please note that we can answer  
your  
questions most effectively by  
telephone.**

**Please call us:**

toll free:

**1-888-488-8127**

or:

**1-541-488-7737**

---

**Email:** [info@pacificdomes.com](mailto:info@pacificdomes.com)

247 Granite Street  
Ashland, OR 97520

1-888-488-8127  
1-541-488-7737

[Fabric Options](#)  
[Floor Plans](#)  
[Frame Diagrams](#)  
[Engineering Specs](#)  
[Anchoring](#)  
[Fabric Treatment](#)

[Order Info](#)

[Prices](#)  
[Shipping](#)

[Contact Us](#)

[Links](#)

[Photos](#)

[Mandalas](#)





## Dome Sizes

- 16ft Dome
- 16ft Riser
- 20ft Dome
- 24ft Dome
- 30ft Dome
- 36ft Dome
- 44ft Dome
- 60ft Dome

## Why Domes

- Shelters
- Event Dome
- Playground
- Greenhouse
- projection
- Mandala

## Features

- Frame
- Covers
- Door
- Windows
- Wood Stove
- Screens
- Connecting
- Interiors
- Floors

## Extras

- Winter Liners
- Insulation
- Skylight
- Air Chairs
- Eco Toilet
- Floating Bed

## Technical Information

LINKS..... **coming soon.**

---

[Email: info@pacificdomes.com](mailto:info@pacificdomes.com)

247 Granite Street    1-888-488-8127  
Ashland, OR 97520    1-541-488-7737

©2001 Pacific Domes

Fabric Options  
Floor Plans  
Frame Diagrams  
Engineering Specs  
Anchoring  
Fabric Treatment:

Order Info

Prices  
Shipping

Contact Us

Links

Photos

Mandalas





### Dome Sizes

- 16ft Dome
- 16ft Riser
- 20ft Dome
- 24ft Dome
- 30ft Dome
- 36ft Dome
- 44ft Dome
- 60ft Dome

### Why Domes

- Shelters
- Event Dome
- Playground
- Greenhouse
- projection
- Mandala

### Features

- Frame
- Covers
- Door
- Windows
- Wood Stove
- Screens
- Connecting
- Interiors
- Floors

### Extras

- Winter Liners
- Insulation
- Skylight
- Air Chairs
- Eco Toilet
- Floating Bed

### Technical Information

- Fabric Options
- Floor Plans
- Frame Diagrams
- Engineering Specs
- Anchoring
- Fabric Treatment

### Order Info

Below are some examples of the many domes which we offer. Click on any one of them for a larger size picture with testimonials from the owners.



Prices  
Shipping

Contact Us

Links

Photos

Mandalas



---

[Email: info@pacificdomes.com](mailto:info@pacificdomes.com)

247 Granite Street  
Ashland, OR 97520  
©2001 Pacific Domes

1-888-488-8127  
1-541-488-7737



## Dome Sizes

16ft Dome  
16ft Riser  
20ft Dome  
24ft Dome  
30ft Dome  
36ft Dome  
44ft Dome  
60ft Dome

## Why Domes

Shelters  
Event Dome  
Playground  
Greenhouse  
projection  
Mandala

## Features

Frame  
Covers  
Door  
Windows  
Wood Stove  
Screens  
Connecting  
Interiors  
Floors

## Extras

Winter Liners  
Insulation  
Skylight  
Air Chairs  
Eco Toilet  
Floating Bed

## Technical Information

# The Domes

## Geodesic Domes: A Sacred Space.

All of life is sacred.  
All of life is geometric.  
Thus geometry is the foundation of all of life.

Geometry is the universal language of creation.



**R. Buckminster Fuller** inventor, architect, engineer, mathematician, poet and cosmologist was one of the most enlightened mystics of the last century. Fuller was truly a man ahead of his time. The Theosophical Society believed he was the second coming of Christ, although he declined the position. One day, witnessed by several people, he was seen levitating 3 feet off the ground for many hours. During that time, a voice told him "everything you speak, from here forward, will be the truth." Shortly after that, Bucky created the Penta System of geodesic designs we use for our domes. His claim was that they create a sacred space where only the pure cosmic love field can emanate and lesser vibrations cannot enter.

His lifelong goal was the development of what he called Comprehensive Anticipatory Design Science the attempt to anticipate and solve humanity's major problems through the highest technology by providing more and more life support for everybody, with less and less resources.

Bucky is best known for the invention of the geodesic dome the lightest, strongest, and most cost-effective structure ever devised. The geodesic dome is able to cover more space without internal supports than any other enclosure. It becomes proportionally lighter and stronger the larger it is. The geodesic dome is a breakthrough in shelter, not



Fabric Options  
Floor Plans  
Frame Diagrams  
Engineering Specs  
Anchoring  
Fabric Treatment:

Order Info

Prices  
Shipping

Contact Us

Links

Photos

Mandalas



only in cost-effectiveness, but in ease of construction and energy efficiency. The geometry allows proper circulation of the ambient air with little energy input.

Bucky was an expert at observing nature and extrapolating its fundamental geometry. Fuller was part of a lineage of master geometers, one of which is credited with being the father of science and philosophy, Pythagoras. The Pythagorean schools and their knowledge of the music of the spheres are the foundation of inspiration for all of the famous geometers that followed from Plato to Kepler. All of them had a profound sense that the geometry found in nature is fundamental to creation. Now many new and exciting unification theories are using these fundamental geometries to solve complex space equations, which supports the view that geometry structures space, and is fundamental to creation.

Imagine yourself living in a highly structured space replicating the fundamental geometry of creation the same geometry at the root of heavenly spheres and of the molecules of your body. Many healers use the dome because they believe that geometry helps reorganize the cells of the body and hence improve health and creativity. Another advantage to the dome is that it can be used to remove stray electromagnetic waves by grounding the metal structure into the earth.

The ultimate geometry of creation is the sphere ie., atoms, molecules, the earth, the sun and the stars etc. All these spheres mathematically generate a point of singularity at the center where all waves cancel out to create stillness the Bindu point of ancient meditation practice. Although the dome is a hemisphere, it emulates these dynamics. Many meditators use the domes to enhance their practice with great success. Similarly, because of these spherical coordinates the acoustics inside the dome are phenomenal and exquisite. Chanting at the point of singularity in the center of the dome generates the effect of hearing yourself from within. Many musicians enjoy the dome for practice and performing.

For more info on R.Buckminster Fuller visit  
[www.bfi.org](http://www.bfi.org)

---

[Email: info@pacificdomes.com](mailto:info@pacificdomes.com)

247 Granite Street  
Ashland, OR 97520

1-888-488-8127  
1-541-488-7737

©2001 Pacific Domes

# Sky Lodge Tipis

(888) 488-8127



Sky Lodge Tipis are an innovation of the Sioux tipi design, with windows added to bring one even closer to nature. They create an ideal environment for many uses in the art of living:



- ▲ Family dwelling
- ▲ Ceremonial lodge
- ▲ Meditation space
- ▲ Guest housing
- ▲ Retreat centers
- ▲ Summer camps

## Key Features:

- ▲ Sun or Moon Skylight or Bay Window
- ▲ Removable round windows & screens
- ▲ Liner included
- ▲ Portable fire pit
- ▲ Easy to assemble and portable
- ▲ Water resistant
- ▲ Handles snow loads and winds



Sun Lodge featuring solar skylight



### Windows

The windows are made with clear vinyl and are extremely durable. They have a UV protectant and remain clear. Each tipi comes with either a Sun or Moon Skylight, or a Bay Window. The bay window is duplicated in the liner. Also included are round, 2 ft. diameter, removable windows with inter-changeable screens.

### Portable Fire Pit

A portable fire pit is provided with each tipi. This allows utilization of the entire floor area when fires are not in use. Convenient handles make it easy to discard the ashes.

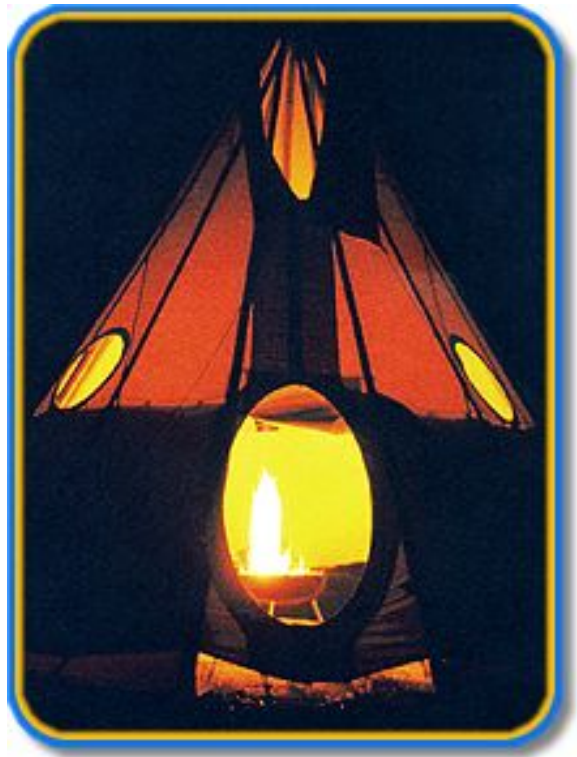

### Three skylight designs

#### Sun Lodge

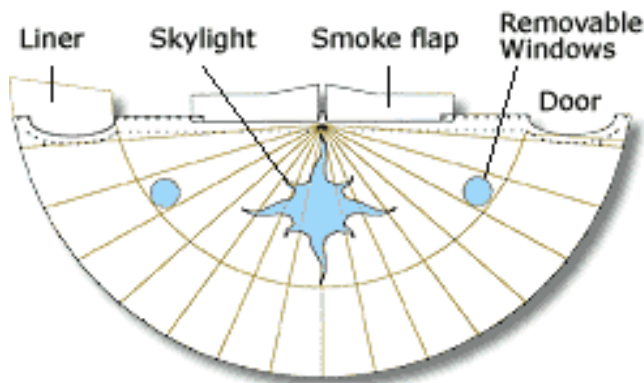

#### Moon Lodge

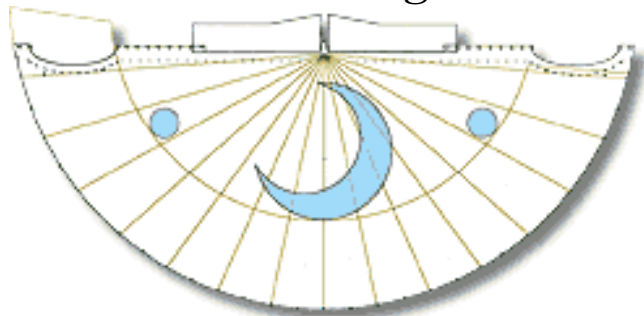

#### Bay Lodge

Sky Lodge Tipi Package includes:

- ▲ Cover
- ▲ Liner
- ▲ Skylight
- ▲ Windows
- ▲ Screens
- ▲ Poles
- ▲ Portable Fire Pit

Prices:

- 12 ft. diameter - \$1,205
- 14 ft. diameter - \$1,505
- 16 ft. diameter - \$1,675
- 18 ft. diameter - \$1,830
- 20 ft. diameter - \$2,065
- 22 ft. diameter - \$2,380
- 24 ft. diameter - \$2,650
- 28 ft. diameter - \$3,250

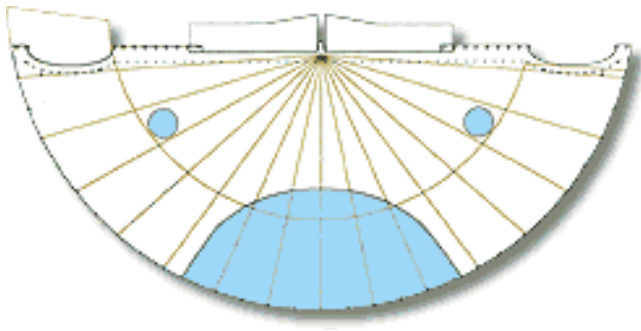

(888) 488-8127  
(541) 488-7737  
[www.skylodgetipis.com](http://www.skylodgetipis.com)  
247 Granite St., Ashland, OR





# Howard's Home Page

Home

Burning Man

Timefold

Band

Skating

Writing

Polymer Clay

Welcome to my home page.

This is the projection of me in cyberspace.

A mirror reflecting my life.

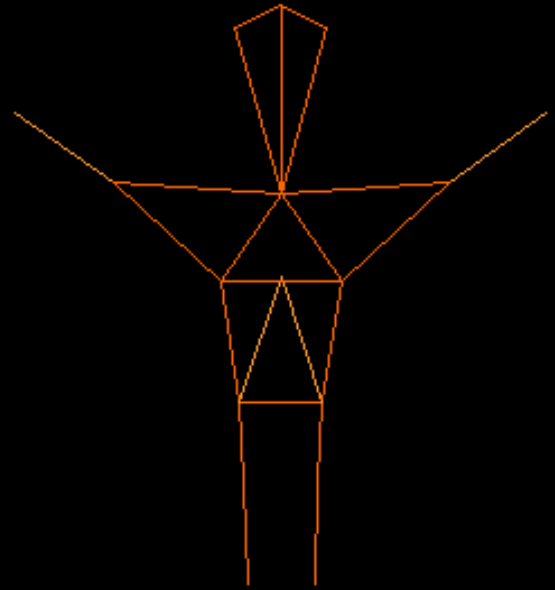

---

[hoco@timefold.com](mailto:hoco@timefold.com)



# Burning Man

[Home](#)

[Burning Man](#)

[Timefold](#)

[Band](#)

[Skating](#)

[Writing](#)

[Polymer Clay](#)

[3na the Jellyfish](#)

[The Home Dome](#)

[The Desert Nose](#)

[Roller Disco 2002](#)

[101](#)

[The Fishmobile](#)

[Camp Nose Fish 2004](#)

I can't wait for Burning Man 2000. I'm working on a few projects:

- CoolNeon Jellyfish  
It's Done! Check out the images of the finished jellyfish.
- Camp Sunscreen  
Check out the new web site!
- Spontaneous Tunes  
We're looking for musicians to jam with at Burning Man. We especially need one more guitar player, especially if they can sing leads.



~^~^~^~^~^~^~^~^~^~^~^~^~

The Burning Man  
towers o'er my dreams  
and calls to me at night  
He beckons from

the far horizon

fiery bright

'gainst starry sky

I don't know what he wants from me

I only know that I must go

My destined metamorphosis

waits beneath his pyric glow

The vision haunts

my waking hours

and will not fade or wan

til I'm absorbed in how to make

this pilgrimage

my muse demands

What sacrifices will I make?

What parts of me will perish?

but ohhhh....

the self I might become -

the vision that I cherish

~^~^~^~^~^~^~^~^~

Poem by Jim Dees

<http://www.totem2000.org>

# Timefold

[Home](#)

[Burning Man](#)

[Timefold](#)

[Band](#)

[Skating](#)

[Writing](#)

[Polymer Clay](#)

I run a business selling licenses to use an online training course I wrote about ClearCase.

You can find out all about it at my [TOES web site](#).

There is also a main [Timefold web site](#).



Problems? Contact the webmaster: [hoco@timefold.com](mailto:hoco@timefold.com)  
All information copyright 2000-2004 Howard Cohen. All rights reserved worldwide.

# Band

[Home](#)[Burning Man](#)[Timefold](#)[Band](#)[Skating](#)[Writing](#)[Polymer Clay](#)

I have the pleasure of playing with a great group of people in a band called [The Missing Notes](#).

We have a cool web site with a song list and an MP3 clip of us playing "Rock Around the Clock".

We have a [Gig](#) on 3/3/2000 at Linguini's in Alameda, beginning at 9:30 pm.



Problems? Contact the webmaster: [hoco@timefold.com](mailto:hoco@timefold.com)  
All information copyright 2000-2004 Howard Cohen. All rights reserved worldwide.

# Skating

[Home](#)[Burning Man](#)[Timefold](#)[Band](#)[Skating](#)[Writing](#)[Polymer Clay](#)[sfskaters.org](http://sfskaters.org)[Rollersoccer](#)[Howard's Skate Page](#)

Skating is the first sport I really fell in love with. Over the years I've gone from cheap hockey skates to expensive speedskates. I even tried [racing](#) once or twice. I actually skated from [San Francisco to Santa Cruz in 1996](#), after failing to make it there in [1995](#).

I also participated in some very long distance team skates. I skated from SF to LA as part of Team Victoria's Secret. Well, actually, Victoria Armigo was the Victoria. Also on our "team" was Paul Pillitteri and another fellow.

I was a support person for the [Skate Against Domestic Violence](#), which I later wrote an essay about. It was one of the most amazing adventures I've ever been on, and I made some incredible friends on the way.

I really got into the slalom and the summer of 1998 I spent a lot of time on the slalom course in Golden Gate Park.

Then I started playing [Rollersoccer](#) and I rediscovered skating again. I used to play soccer in high school but was never very good. I used to skate the the Lake Merced loop and then play rollersoccer, but I was so tired by then that playing goalie was about all I could handle. I found that I was a decent goalie and began taking it more seriously.

Now I play rollersoccer whenever I can, which is most Wednesdays. I am learning more about playing out in the field instead of just playing goalie. I finally figured out that my speedskates probably aren't the best skates for the job...

---

Problems? Contact the webmaster: [hoco@timefold.com](mailto:hoco@timefold.com)

All information copyright 2000-2004 Howard Cohen. All rights reserved worldwide.

# Writing

[Home](#)[Burning Man](#)[Timefold](#)[Band](#)[Skating](#)[Writing](#)[Polymer Clay](#)

## [Where Gravity Sleeps](#)

I have a number of writing projects. Here is an index of work you can access online:

- **[1996 San Francisco to Santa Cruz Roadskate](#)**

This is an account of my experience trying to skate about 100 miles in one day. (by Wille Makit and Betty Wont ;-)

- **[1996 Skate Against Domestic Violence](#)**

This piece tells a dramatic story about an attempt by seventeen women to skate over 700 miles to raise awareness about domestic violence.

- **[Where Gravity Sleeps](#)**

This is a Science Fiction novel, whose first chapter needs serious rework... or, maybe, just start with chapter two. ;-)

---

Problems? Contact the webmaster: [hoco@timefold.com](mailto:hoco@timefold.com)

All information copyright 2000-2004 Howard Cohen. All rights reserved worldwide.



# Polymer Clay

Home

Burning Man

Timefold

Band

Skating

Writing

Polymer Clay



Drawing by Michael Marx

All of my polymer clay pages can be found at:

[www.3ddoodle.com](http://www.3ddoodle.com)

---

Problems? Contact the webmaster: [hoco@timefold.com](mailto:hoco@timefold.com)

All information copyright 2000-2004 Howard Cohen. All rights reserved worldwide.

# Jellyfish (3na)

[Home](#)

[Burning Man](#)

[Timefold](#)

[Band](#)

[Skating](#)

[Writing](#)

[Polymer Clay](#)

## ▶ 3na the Jellyfish

[Images of 3na](#)

[Jellyfish Plans](#)

[Sea Nettle Images](#)

[Controls](#)

[Color Guns](#)

[Solar Charger](#)

[The Home Dome](#)

[The Desert Nose](#)

[Roller Disco 2002](#)

[101](#)

[The Fishmobile](#)

[Camp Nose Fish 2004](#)



3na the Jellyfish. Click Image for Larger Sized View

I've built an electric Jellyfish which I equipped with various lighting effects. I also have a mount to suspended over my bike for night-time aquatic-like roaming at Burning Man.

Her name is 3na.

---

Problems? Contact the webmaster: [hoco@timefold.com](mailto:hoco@timefold.com)

All information copyright 2000-2004 Howard Cohen. All rights reserved worldwide.

## Cutting Struts

[Home](#)

[Burning Man](#)

[Timefold](#)

[Band](#)

[Skating](#)

[Writing](#)

[Polymer Clay](#)

[3na the Jellyfish](#)

[The Home Dome](#)

▶ [Cutting Struts](#)

[Drilling Struts](#)

[Assembly](#)

[The Desert Nose](#)

[Roller Disco 2002](#)

[101](#)

[The Fishmobile](#)

[Camp Nose Fish 2004](#)



Before you begin working on your dome make sure you have a set of gloves and protective glasses or goggles for your eyes. Metal slivers **suck** and you should always use eye protection when working with tools and metal because debris can get flicked or thrown up into your face. When you have to repeat the same operation many times you have to make an extra effort to stay alert and remain careful.



This measuring jig is just a 2x4 with a block screwed on the end. I have added two screws at the end to help align and center the conduit and keep it secure while measuring it.



After you determine the length of each strut, place marks on the measuring tool and label them. I built a 3-frequency dome so I needed three different lengths: A, B and C.



After marking the conduit using the measuring jig, cut it using a pipe cutter. A pipe cutter is easy to use and creates no metal shavings like a hacksaw would. You rotate the cutter about the conduit, turning the handle a quarter turn each time.



Flatten the end using an arbor press or you could hammer them flat against a piece of steel. I added a 3 foot lever arm (piece of conduit) to the arm of the press to make it easier to crush the ends.

Don't forget: **You must place the welding seam of the conduit at a 45 degree angle with respect to the press base.** In other words, the weld seam cannot be at the top, bottom, or either side, but 45 degrees from any of those positions is OK.



This jig is simple to make -- it is just a 2x4 with a slot cut in the side perpendicular to the length of the 2x4. The slot must be just wide enough to fit a flattened end. You use this jig to ensure that when you flatten the other end of the strut it is in the same **plane** as the first end.

[Previous](#)   [Next](#)

---

Problems? Contact the webmaster: [hoco@timefold.com](mailto:hoco@timefold.com)  
All information copyright 2000-2004 Howard Cohen. All rights reserved worldwide.

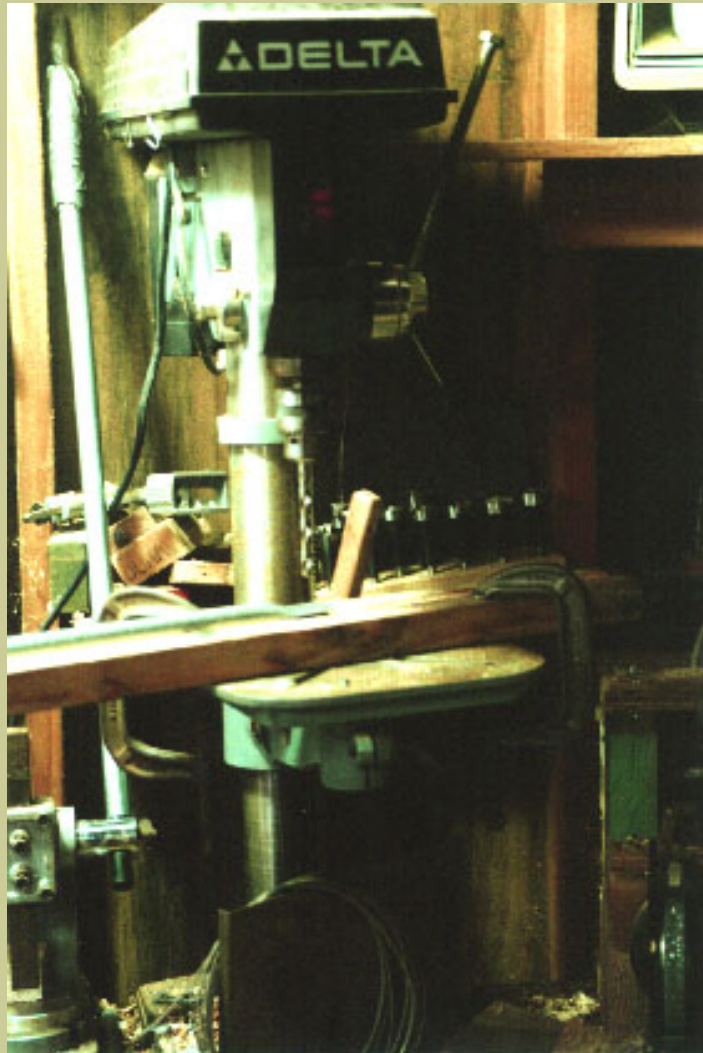

# Drilling Struts

[Home](#)[Burning Man](#)[Timefold](#)[Band](#)[Skating](#)[Writing](#)[Polymer Clay](#)[3na the Jellyfish](#)[The Home Dome](#)[Cutting Struts](#)[▶ Drilling Struts](#)[Assembly](#)[The Desert Nose](#)[Roller Disco 2002](#)[101](#)[The Fishmobile](#)[Camp Nose Fish 2004](#)

A drill press makes the drilling job a lot safer and easier. The jig is a 2x4 with a V about 3/4 inch deep cut into it lengthwise. I used a tablesaw, but if you don't have an easy way to make the cut, you can build up a channel by using two lengths of quarter-round moulding or even just two long strips of wood set just far enough apart so the conduit nestles securely between them.

It is important to clamp the jig is clamped to the drill-press table so you can drill holes in exactly the same position for struts of the same length.



Be sure that the drill is aligned exactly over the center and at the correct distance from the end of the strut.



Drilling the struts produces a lot of metal shavings. These are razor sharp and get stuck to your shoes, in your fingers, etc. Blow these away or use a brush. Don't brush them away with your fingers or

you'll get nasty metal slivers.

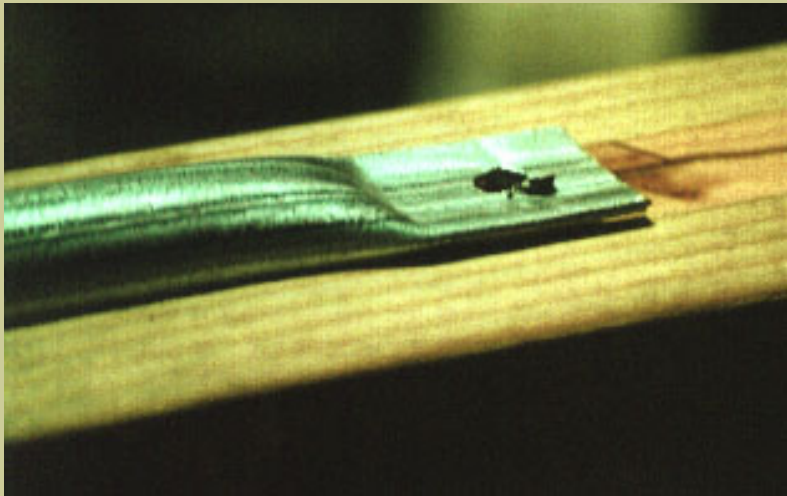

After drilling the strut and brushing away the metal shavings there will be some excess material around the hole (usually on the underside). This material is a result of the drilling process and is called **flash**. You must remove the flash or it will interfere with assembly and will probably cut someone badly when they grab a strut by its end.

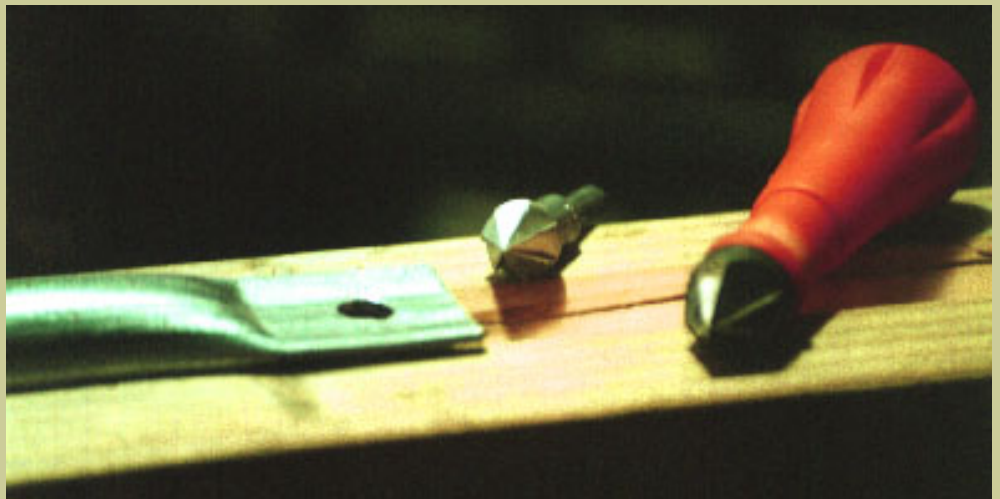

You can use a special **chamfer bit** in a hand drill or drill press, or use a **hand chamfering tool**. Removing the flash is pretty easy with one of these tools.

[Previous](#)   [Next](#)

---

Problems? Contact the webmaster: [hoco@timefold.com](mailto:hoco@timefold.com)

All information copyright 2000-2004 Howard Cohen. All rights reserved worldwide.

# Assembly

[Home](#)[Burning Man](#)[Timefold](#)[Band](#)[Skating](#)[Writing](#)[Polymer Clay](#)[3na the Jellyfish](#)[The Home Dome](#)[Cutting Struts](#)[Drilling Struts](#)[► Assembly](#)[The Desert Nose](#)[Roller Disco 2002](#)[101](#)[The Fishmobile](#)[Camp Nose Fish 2004](#)

Once the struts are built you assemble the dome by using 3/8" carriage bolts. The struts should be painted to both color code the different lengths as well as protect them from rust.

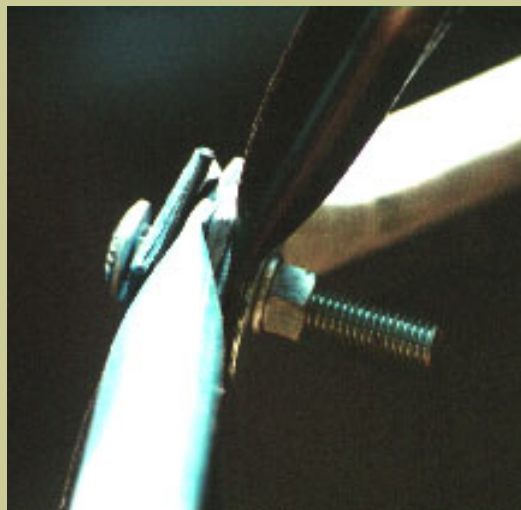

This is a side view of the strut connections. I used 2.5" long carriage bolts, which left about 1" sticking out inside. But you need some of that extra length to simplify assembly. In my dome there is little chance of bumping your head on these, but if your dome is a different size they might end up at head height. In which case you might want to drill a 1/4" hole in a

tennis ball and push it onto the inside to protect people's heads.



The finished dome, covered with a parachute. You can see my tent inside, and some chairs. My dome is 20' in diameter and about 8.5' tall.



This is a view inside the dome, looking at a large painted canvas which I have attached quite securely to the outside of the dome. The painting is of a chair, guitar, an easel and two windows. It was painted by Florentino Mendiola, an old friend of mine.

In front of the painting is a shelf supported by one custom-length strut. It attaches to two vertexes using a carriage bolt and a strip of steel with 3/8" holes for each. You can see my campstove and boombox on the shelf.



This is a closeup of the parachute canopy. You can see two black lines. These attach to the top/inside of the dome down the outside of the dome under the parachute. Then they slip through a reinforced hole at the edge of the parachute and back up to the top of the dome on the outside of the parachute. At the top they all go through a single 4" diameter steel ring and down inside the dome through a hole in the top of the parachute.

The end result is that the parachute can be raised up to "daytime mode" (as these photos show) simply by pulling on all the lines. In practice it takes effort to keep the lines from getting tangled. There are 15 lines, and they correspond to the 15 bottom vertexes of my dome.

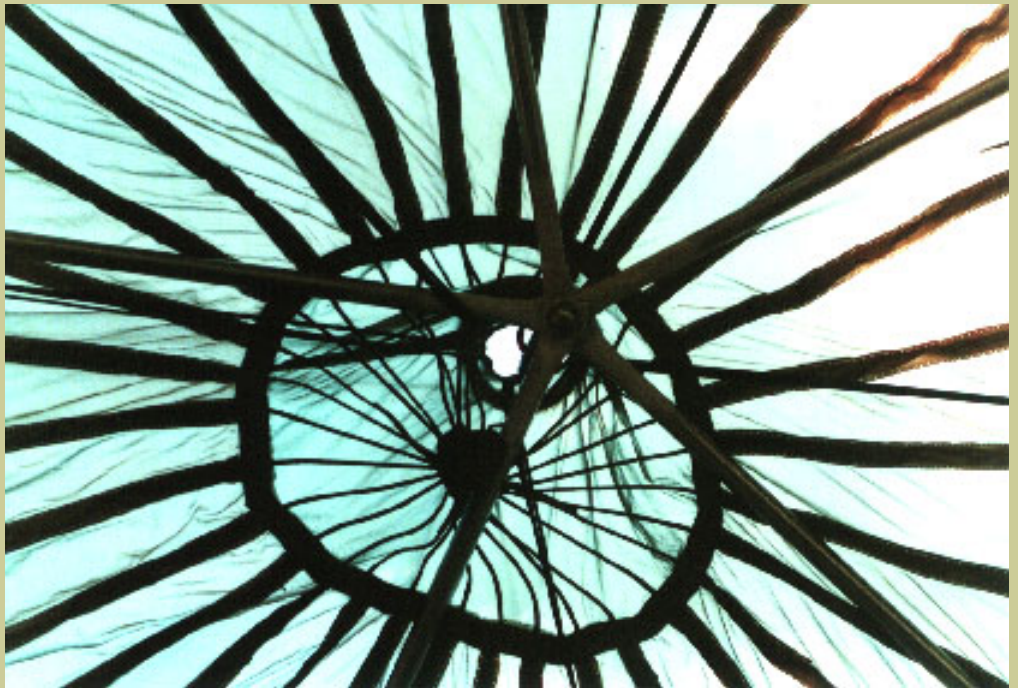

Looking up at the center of the top of the dome you can see five struts meeting. I actually used a 8" carriage bolt for this very top junction. It sticks out about 7" above the top of the dome and keeps the steel ring from

sliding down the side of the dome. Most of the lines and wide strips are just part of the parachute.



These rebar stakes are made by bending a 5' section of 1/2" rebar into a U shape. Rebar comes in 10' lengths, so I just had to cut them in half. I used a hacksaw for this -- it took about 100 strokes per cut. I made 15 U-stakes, one for each bottom vertex of my dome.

If that seems like overkill, consider that at Burning Man there can be gusts of up wind that exceed 60 miles/hour! When you consider that my dome might have the parachute covering it at the time, there is **a lot** of force from the wind on the dome. My dome is a 3/8 dome so it presents a lower profile to the wind, which also helps.

[Previous](#)

# Desert Nose

[Home](#)

[Burning Man](#)

[Timefold](#)

[Band](#)

[Skating](#)

[Writing](#)

[Polymer Clay](#)

[3na the Jellyfish](#)

[The Home Dome](#)

▶ [The Desert Nose](#)

[BM 2001 Photos](#)

[Images](#)

[Tim's Images](#)

[James' Images](#)

[Party Images](#)

[Strutology](#)

[Nose Plans](#)

[Building the Nose](#)

[Tarps](#)

[Nose Calculator](#)

[Building a Model](#)

[2002 Organizers](#)

[Roller Disco 2002](#)

[101](#)

[The Fishmobile](#)

[Camp Nose Fish 2004](#)



## Desert Nose

The Desert Nose will be back at Burning Man 2002, providing a cool place to chill-out amid the vast stimulation of Burning Man. It's a place to shelter from the dust and heat, get a view of Black Rock City and relax.

The Desert nose is a scaled up replica of Buckminster Fuller's nose. It is 15 feet tall, 30 feet wide, 30 feet deep. It has a second floor deck which seats 600 lbs of people. Inside the floor is carpeted and there is enough custom bench-type seating for 25 people. There is low volume "chill space" ambient and down tempo music and at night there is low-level color lighting.

This year there is a new and improvised cooling system that maximizes human coolage with a lot less wattage. Also, there is an awning over the deck area as a precaution in case it rains, and as a sun shade. The nose stereo has a new amplifier and there are new nose lighting fixtures. The nose phone, which has become infamous for its poor showing at last year's Burning Man has been rebuilt, to its original specs, and is in great working order. The septum is now covered in canvas instead of wood, which was burned last year because there was no space for it on the return trip.



But by far the biggest and most important change for the nose this year is that it got a paint job! Each of the nearly 320 struts (the awning adds several new struts) has been painted with a sorting color in its middle, and each end has been painted with three colored stripes. All the struts which meet at a given vertex are painted the same way, so it is easy to tell when a strut is out of place. This will make assembly in the desert much, much easier. In addition, each strut has a new label which is much, much, much easier to read now, from any orientation.

Last year I used an air compressor to spray water on people and then blow air past them. The water on their skin evaporated and they were quickly cooled. Very effective, but noisy and it consumed a lot of power.

The one resource in abundance at Burning Man is human energy. So, this year's cooling system taps some of that. We'll be using hand-pumped sprayers to mist people. These hold 2.5 gallons each and last a while after being pumped up.

To move air this year I'm using an electric fan bolted to the underside of the deck pointing down. This will move a lot more air than the compressor, and will be easier for people to control for themselves. It will also move air inside the nose and that will help cool the nose somewhat too.

The fan will run on electric power, assuming we're in center camp, where there is some 110v power. If the camp is on the Esplanade we may use a generator, or I could run the fan with 50 square feet of solar cells...

Why build a replica of Buckminster Fuller's nose? Well, it all started a couple of years ago...

I got the idea while I was driving back from Burning Man 2000 and reflecting on what worked and what didn't work with my [dome](#). It seemed that the wind blew in too much from the sides. Also, I wanted a door. Doors don't work well in domes -- they get weakened by adding a door. To make a door in a dome I figured I could make a strong "hoop" and enclose a door, or make a strong column and put a door on each side of it. When I imagined the latter -- a dome with two rounding doors side-by-side -- I immediately thought of a nose. The more I thought about it the more I liked the idea.

I wondered how I might build one and decided that the same technology used to build the dome could also work for the nose. And, if the nose was to be built as a geodesic structure it would be perhaps appropriate to build it based on Buckminster Fuller's nose. While he didn't actually invent the concepts of geodesic

structures, he certainly developed and popularized them.

I also feel personally aligned with one of his primary beliefs: that humans have advanced to the point where we have the "option to succeed" and the ability to raise the standard of living for everybody on the planet.

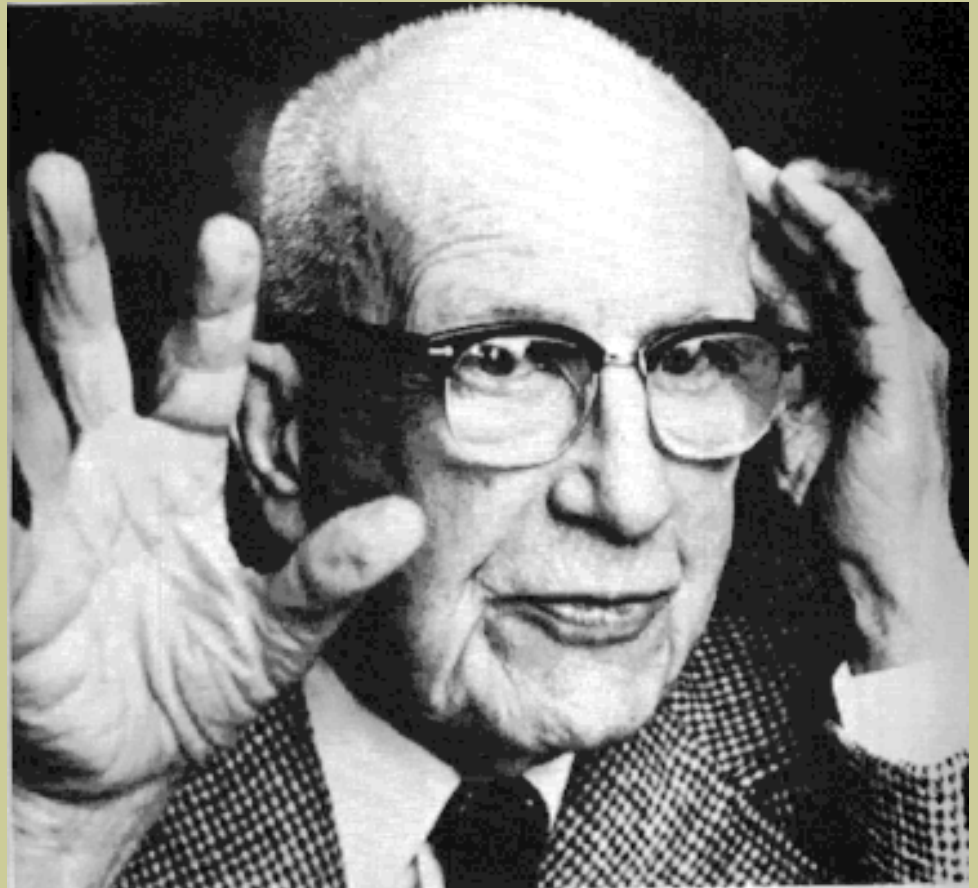

For more on Buckminster Fuller and his remarkable accomplishments, viewpoints and life check out these resources:

- [The Buckminster Fuller Institute](#)
- [The Buckminster Fuller FAQ](#)
- [Synergetics on the Web](#)
- [A short page about Buckminster Fuller \(Bucky\)](#)
- [Buckminster Fuller's Grand Strategy for Solving World Problems](#)

I decided to start by building a model. I built the model out of copper ground wire, which I soldered together. The nose would lay on the ground with the nostrils pointing away from the prevailing wind. I actually built only half of the model with all its struts. The other half just had a few large curved wires to suggest the entire shape.

Then I labeled all the vertices and all the struts. Some vertices

and struts were exactly on the center line, so there was only one of each. The rest there would have a left and right version (which would be identical).

Then I very carefully measured the X, Y and Z coordinates of each vertex and created a [data file](#) which contained the coordinates for each vertex number.

I also surveyed the model to determine which two vertices were connected by each numbered strut. I recorded this information in another [data file](#) which listed the two vertex numbers for each strut number, and whether the strut was on the center line or not.

Then I created a [program using Perl](#) which analyzed the two input files for various purposes, including:

- Applying a scaling factor to the data to let me see how big the nostril openings would be compared to the entire length, width and height.
- Calculating the actual length of each strut.
- Generating labels to be applied to each strut to identify it.
- Determining the order in which to cut struts to minimize wasted electrical conduit.

Then, I adapted the program to the web and created [Nose Calculator](#). This program accepts two data files from you and then generates data and images for them. It assumes you will be building a structure with a center line of symmetry.

In fact, the finished version will have 311 struts, ranging in length from less than 11" to over 12' (for some side stabilizing struts that lay on the ground).

Nose Width=21' 10 and 5/8"

Nose Length=25' 6"

Nose Height=14' 7 and 3/32"

Door Height=8' 5 and 1/8"

Deck Height=8' 0 and 7/8"

Look who was lurking among the struts of the Desert Nose...

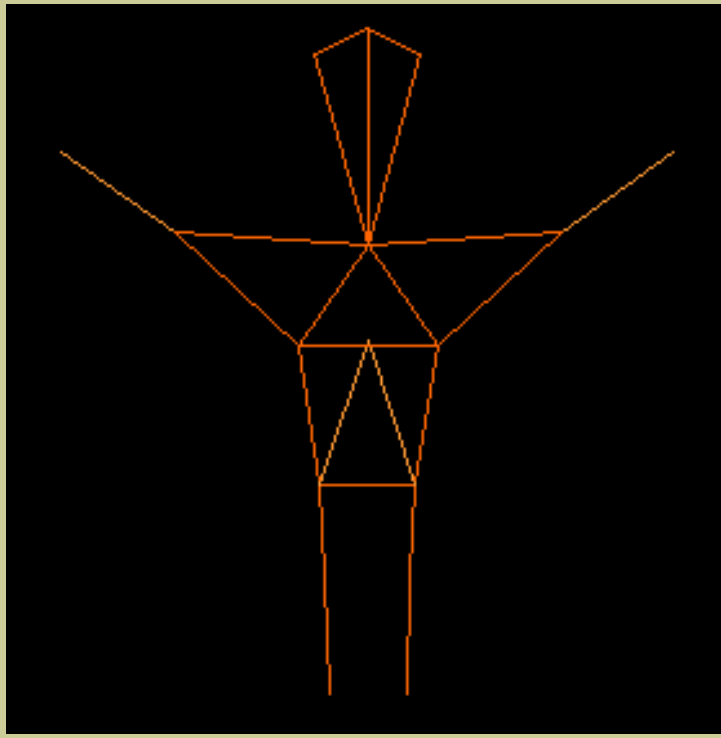

Struts 4, 5, 6, 7, 11, 13, 14, 15, 16, 17, 18, 19 and 91  
of the Desert Nose  
Courtesy of the [Nose Calculator](#)

---

Problems? Contact the webmaster: [hoco@timefold.com](mailto:hoco@timefold.com)  
All information copyright 2000-2004 Howard Cohen. All rights reserved worldwide.

# Roller Disco 2002

[Home](#)
[Burning Man](#)
[Timefold](#)
[Band](#)
[Skating](#)
[Writing](#)
[Polymer Clay](#)
[3na the Jellyfish](#)
[The Home Dome](#)
[The Desert Nose](#)

► [Roller Disco 2002](#)

[Theme Camp Plan](#)
[Participate!](#)
[Camp Calendar](#)
[Camp Checklist](#)
[Camp Members](#)
[Links](#)
[Contact Info](#)
[Camp News](#)
[Cleanup Plan](#)
[101](#)
[The Fishmobile](#)
[Camp Nose Fish 2004](#)

## Camp Roller Disco Web Annex

This corner of the web contains information about [Camp Roller Disco](#), a theme camp at Burning Man 2002.

Here you can:

- [Read about our camp plan](#)
  - [See a map of our Theme Camping Area](#)
  - [See a map of our Annex Camping Area](#)
  - [See the chart of our Tidepools](#)
- [Find out how to participate!](#)
- [Find out how to reach us](#)
- [Access some useful links](#)

Camp members will find the [Calendar](#) and [Checklist](#) pages useful, especially as Burning Man gets closer.

Here is the current camp location with respect to the rest of Burning Man. We've been placed in Center Camp.

Our main camp in green and our annex camp in violet. Click the image for a larger view of it (one you can actually read).

Go [here](#) to view more detailed plans.

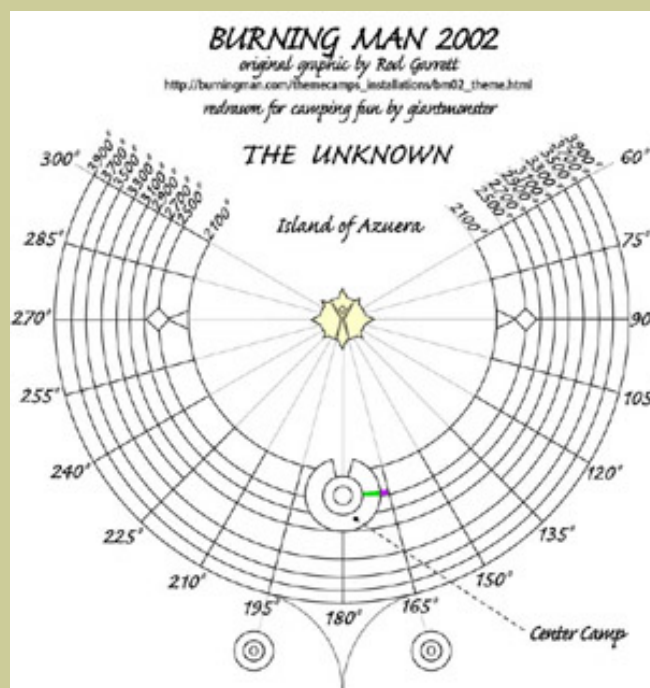

Problems? Contact the webmaster: [hoco@timefold.com](mailto:hoco@timefold.com)  
All information copyright 2000-2004 Howard Cohen. All rights reserved worldwide.

# 101

[Home](#)
[Burning Man](#)
[Timefold](#)
[Band](#)
[Skating](#)
[Writing](#)
[Polymer Clay](#)
[3na the Jellyfish](#)
[The Home Dome](#)
[The Desert Nose](#)
[Roller Disco 2002](#)

▶ [101](#)

[The Fishmobile](#)
[Camp Nose Fish 2004](#)

In 1999 a school of Kenny Schwartz's Playa Fish made their first big splash at Burning Man. At the very least they were ahead of their time. The theme for Burning Man 2002 is **The Floating World**. This year the playafish will join a sea of glowing creatures like no other on this planet.

This year I've made 101 (a name, not a number -- rhymes with Paul, but there's a zero in the middle.) He's an electrically controlled coolneon sea anemone. He has 144 separate coolneon segments.



[Photo by Cameragirl](#)

The segments are attached electrically to a control panel made of over 100 magnetic reed switches under a sheet of plexiglass. You pass a magnet over the control panel and the segments light up. **You can't break it, and you can't get it wrong.** (Um, don't take that as a challenge, ok?)

L01 joins [3na](#) as my coolneon interpretation of members of the cnidarian phylum (animals with stinging cells, including jellyfish, anemones, hydra, and corals). These are actually fascinating animals with remarkable adaptations and reproductive cycles. Some have a symbiotic

relationship with photosynthetic algae and are thus able to get energy from sunlight. Some are asexual, reproducing by leaving small slices of themselves behind as they move! Here's a few good links to learn more about them:

- [Cnidarian Home Page](#)
- [Field Guide to Anemone Fishes and Their Host Sea Anemones](#)

Here's a photo of 3na and 101 at the Flambe Lounge's 2002 Blue Ball, swimming away from all the activity.



[Photo by Cameragirl](#)

---

Problems? Contact the webmaster: [hoco@timefold.com](mailto:hoco@timefold.com)  
All information copyright 2000-2004 Howard Cohen. All rights reserved worldwide.



# The Fishmobile

[Home](#)

[Burning Man](#)

[Timefold](#)

[Band](#)

[Skating](#)

[Writing](#)

[Polymer Clay](#)

[3na the Jellyfish](#)

[The Home Dome](#)

[The Desert Nose](#)

[Roller Disco 2002](#)

[101](#)

▶ [The Fishmobile](#)

[Camp Nose Fish 2004](#)



The Fishmobile now has its own web site at:

[www.fishmobile.net](http://www.fishmobile.net)

---

Problems? Contact the webmaster: [hoco@timefold.com](mailto:hoco@timefold.com)

All information copyright 2000-2004 Howard Cohen. All rights reserved worldwide.

# Camp Nose Fish

[Home](#)

[Burning Man](#)

[Timefold](#)

[Band](#)

[Skating](#)

[Writing](#)

[Polymer Clay](#)

[3na the Jellyfish](#)

[The Home Dome](#)

[The Desert Nose](#)

[Roller Disco 2002](#)

[101](#)

[The Fishmobile](#)

▶ [Camp Nose Fish 2004](#)

[Nose Fish Calendar](#)

[Camp Members](#)

[Checklist](#)

[Web Links](#)

[Camp Contacts](#)

[Camp Layout](#)

[Cleanup Commitment](#)

[Elephant Nose Fish](#)

Welcome to the **Camp Nose Fish 2004** home page.

Our camp's theme is "less is more."

The camp has two main projects:

- [The Desert Nose](#) will return for its fourth year, providing interactive cooling during the hot part of the day
- [The Fishmobile](#) will be returning with its hopeful and useful message of positive personal transformation. It will be parked in our camp throughout the event.
- We are also hoping that Chris Pirazzi will bring his MEZ video screen, which is an interactive experience in real-time digital image processing.

We will be in the 3:00 Plaza right near Ranger Station Berlin.

We're proud this year to be on the Earth Guardian's "Leave No Trace Tour!" We'll be showing off our zero-impact shower, our numerous strut-based structures including examples of 1v, 2v and 3v domes, and the Great Unhot (the super-efficient people cooler in the Desert Nose).

Our camp will have a new windcloth shade area this year suspended from our camp's four domes. We'll be able to eat and get out of the heat inside our camp even when the nose is packed.

Everyone in our camp shares a solid and creative comittment to having **zero net impact** on the Playa. We do all we can within our camp to reduce waste and keep our waste under control, and we also clean up moop out on the playa and around the city to help make up for the fact that we can't really be perfectly zero impact.

Problems? Contact the webmaster: [hoco@timefold.com](mailto:hoco@timefold.com)  
All information copyright 2000-2004 Howard Cohen. All rights reserved worldwide.

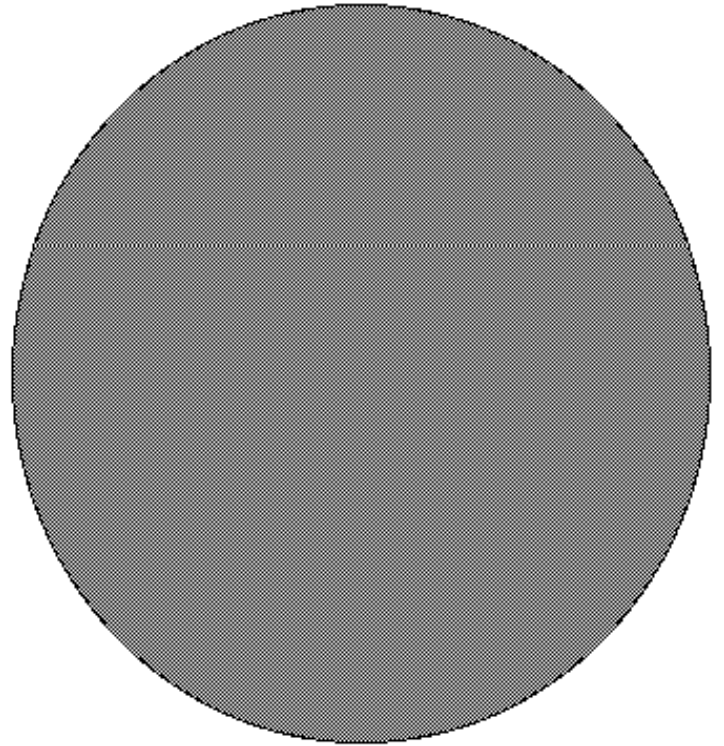
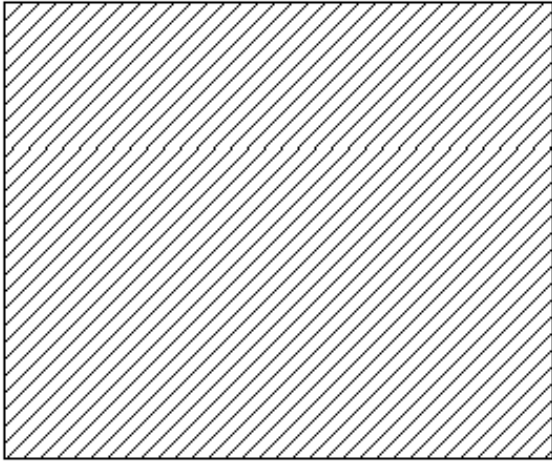

Tarp and dome, approximate relative sizes.

---

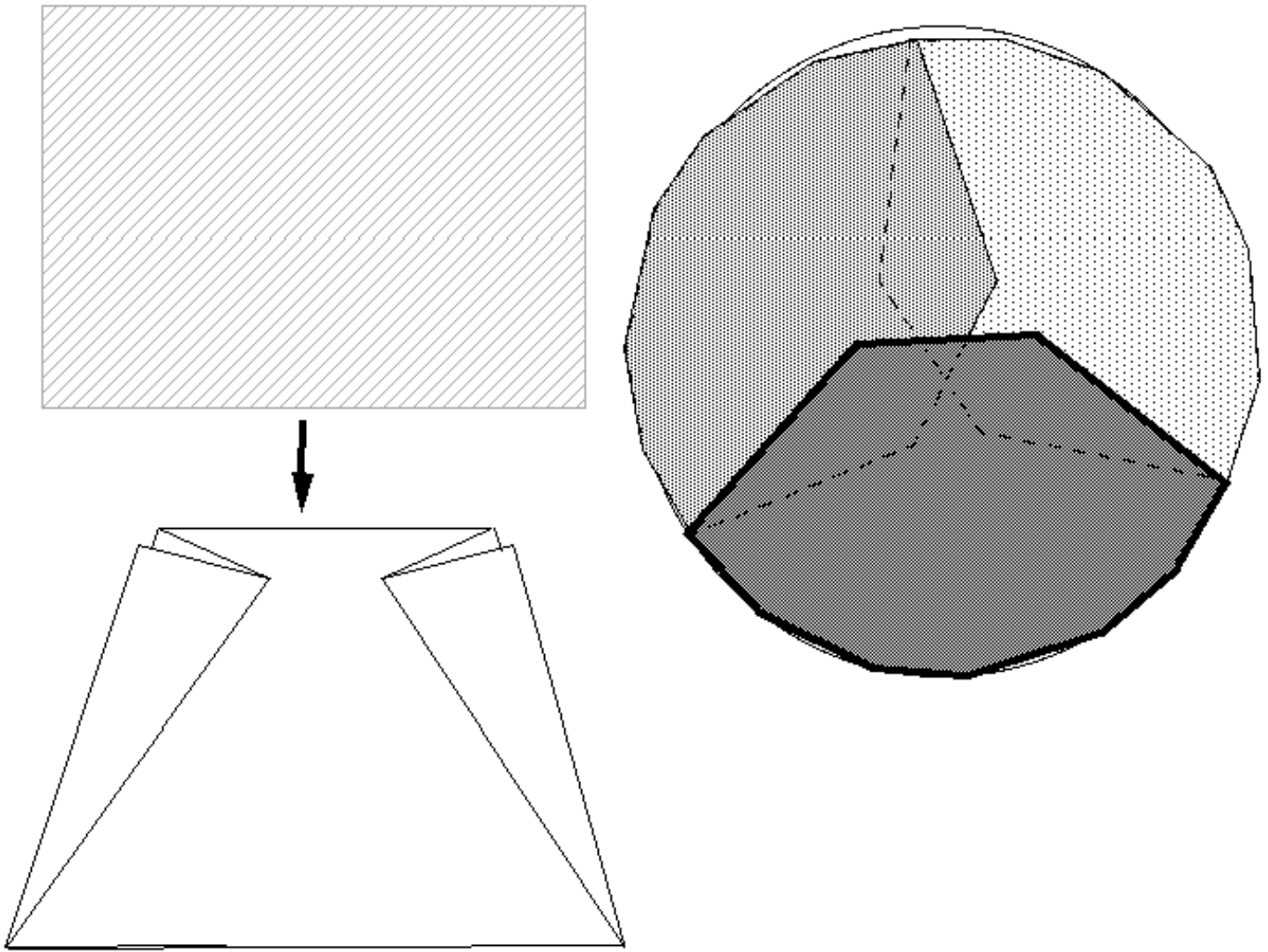

You can narrow the top (once the tarp's bottom edge is attached to the dome) by taking one large pleat on each side at the top. You end up with a trapezoid. Use multiple trapezoids to cover your dome.

---

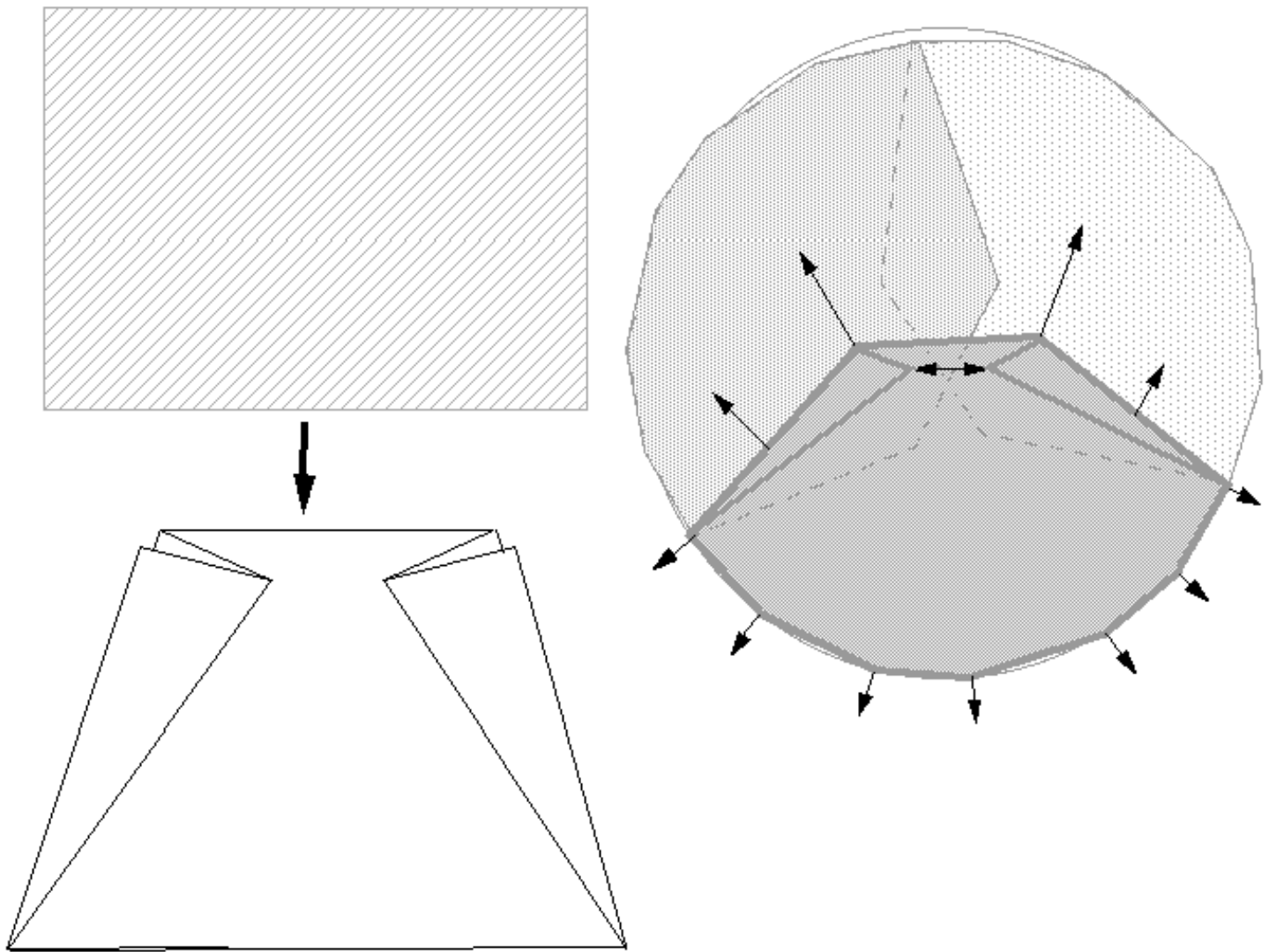

You can use some bungee cords and/or rope and/or bungee balls to secure the two closest grommets of the top edge and the two corner grommets with forces in opposite directions, so that the top tarps hold their positions.

When tarps cross each other, you can attach to any of these points:

- Any exposed strut.
- A grommet on an already mounted tarp.
- The base struts of the dome are always viable, even if you have to reach them with a length of rope. To cut synthetic rope: wrap with tape, cut, burn ends with lighter until fibers fuse, remove tape.
- To another bungee or rope that is itself secured to something.

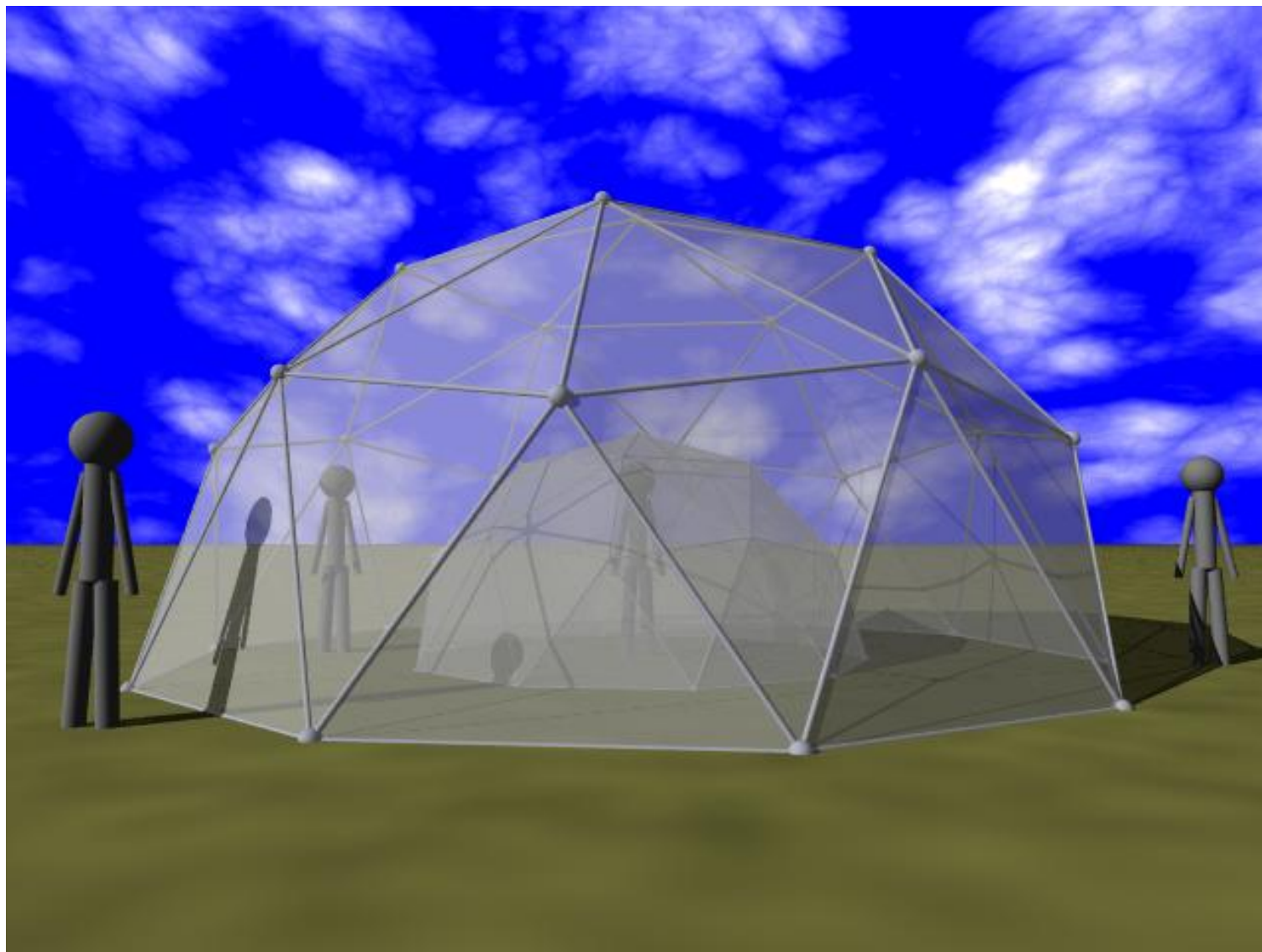





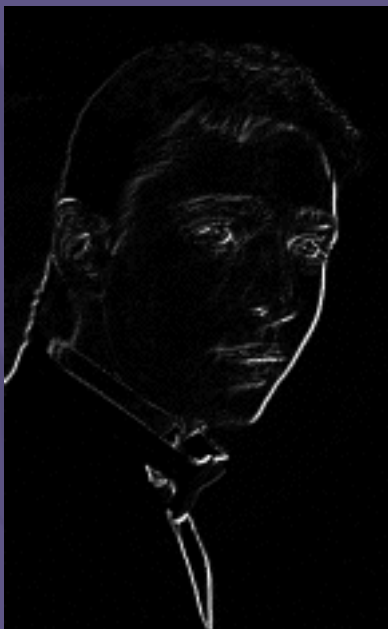

# Dr. Michael J. Gourlay

Research Scientist, Ph.D. Physics

NWRA / CoRA

office: (303) 415-9701 x 203

fax: (303) 415-9702

---

[trigonometry tutorial](#) [Hexaviruts](#)

[HOME](#) [ [research](#) [resume](#) [audio](#) ] [ [software](#) [Ogle](#) [Xmorph](#) ] [ [dome](#) [movies](#) [scrytch](#) [antarctica](#) ]

---

[Dr. Michael J. Gourlay](#) / [gourlay](#) at [colorado-research dot com](#)



# Gourlay goes to ANTARCTICA

## Penguins.

In the austral summer of 1997/1998 [I went South.](#)

I was surrounded by penguins.

[home](#) [ANTARCTICA](#) [audio](#) [dome](#) [movies](#) [research](#) [resume](#) [scrytch](#) [software](#)

## Reports from Antarctica by me

[Antarctic Diary](#) ([local copy](#)) by Sir Peter Maxwell Davies, whose trip overlapped mine.



### Antarctic Support Associates

ASA provided logistical support for all United States citizens who went to The Ice.

However, I did not going to a U.S. station so much of the ASA support is not relevant to me.

[Raytheon Polar Servides](#) took over the responsibilities of ASA.



### British Antarctica Survey

BAS is like ASA for the U.K. Since I am going to a British base, I dealt more with BAS than I did with ASA.

The BAS home page has out-dated information about the Antarctic Treaty so ignore that info if you choose to look at their link regarding the Treaty. They seem to give no indication that another treaty is in place as of a few years ago.



## Falkland Islands

I stopped at the Falkland Islands twice during this trip: On the way down and on the way back. This tiny country has only about 2000 people living there, and most of them live in Stanley, which is where I was.



## RRS James Clark Ross

The J.C.Ross is the British ice-breaker ship that I rode from Stanley, Falkland Islands.

These islands near the southern tip of South America are called either the Falklands or Malvinas, depending on whether you are British-oriented or Argentinian-oriented. I use the British names because they are the people toting my ass around.



## Rothera Research Station

I was stationed at [Rothera Research Station](#). This is on Adelaide Island, along the Antarctic Peninsula.



## ATRAD Radar enhancement

The reason I went to Antarctica is related to an [MF atmospheric radar](#) which our lab installed in 1996/1997. I upgraded software on the computer that obtains and processes data from the radar. I also assisted, in some grunt capacity, in the enhancement of the signal-to-noise ratio of that radar, which seems to have interference beyond levels in other, [similar radars elsewhere around the world](#) also operated through our research lab.



## The BAS Twin Otter Aircraft

This aircraft is used to transport supplies and people inland. They have skis so they can land on ice or snow. They occasionally need extra flight crew members to help out or just look out the window. I hoped to ride one of these inland.



## The BAS Dash-7 Aircraft

This aircraft is how I returned from Rothera to the Falklands. It is painted the same bright red color as everything else in Antarctica, including my Extreme Cold Weather gear.

Images on this web page owned by British Antarctic Survey are used with permission (via Linda Capper).

---

[Michael J. Gourlay](#) / gourlay at colorado-research dot com

[home](#) [antarctica](#) [audio](#) [music](#) [dome](#) [MOVIES](#) [research](#) [resume](#) [software](#)

## Internet Movie Database search

People ask me for movie recommendations. As a question out of context I can not easily answer. I find it hard to specify what are my "favorite" movies because that depends on my mood, on the genre, and other things.

## **Movies I would see any number of times**

I eventually recognized that despite how "good" I think a movie is (e.g., in terms of how well it was made or how easy it is to have a conversation about it in terms of film theory, or whatever) I find myself watching, talking about or thinking about the same movies repeatedly, even if I would not necessarily defend their quality. There are several movies I have seen a number of times and would readily see again. This criterion is a little more well defined to me than some arbitrary "rating" quantification system. For each of these distinguished movies I have also listed the director because often the same director has also made other stellar movies.

- [Blade Runner](#) (director's cut is preferred) ([Ridley Scott](#)) (also directed Legend, Black Rain, Thelma and Louise, 1942: Conquest of Paradise, G.I. Jane)
- [Apocalypse Now](#) ([Francis Ford Coppola](#)) (also directed The Godfather series, Rumble Fish, Bram Stoker's Dracula)
- [The Hunger](#) ([Tony Scott](#))
- [Miller's Crossing](#) ([Cohen Brothers](#)) (also directed Blood Simple, Raising Arizona, Barton Fink, The Hudsucker Proxy, Fargo, The Big Lebowski)
- [Fear and Loathing in Las Vegas](#) ([Terry Gilliam](#)) (also directed Jabberwocky, Time Bandits, Monty Python's The Meaning of Life, Brazil, The Fisher King, Twelve Monkeys; and wrote Life of Brian)
- [Dead Man](#) ([Jim Jarmusch](#)) (also directed [Ghost Dog: The Way of the Samurai](#))
- [The Adventures of Buckaroo Banzai](#) ([W.D. Richter](#))
- Any movie by [Hal Hartley](#): The Unbelievable Truth, Trust, Theory of Achievement, Surviving Desire, Ambition, Simple Men, Flirt, Amateur, Henry Fool
- [The Big Sleep](#) ([Howard Hawks](#))
- [Highlander](#) (look for director's cut) ([Russell Mulcahy](#))
- [Fight Club](#) ([David Fincher](#)) (also directed Alien3, Se7en, The Game)
- [The Matrix](#) ([Wachowski Brothers](#)) (also directed Bound)

## Notable Movies

Here I list other movies that I found remarkable, listed by director. This criterion is rather vague, but so is the question it tries to answer. I found these notable probably because they changed or disturbed me in some lasting way. If you like a movie by a particular director then there is a better than average chance that you will like other movies with the same director. A basic notion of Auteur theory is that the author of a movie is the director (as opposed to the writer, actors, producer, editor, or whoever).

- David Cronenberg: Naked Lunch, Crash
- Pavel Lungin: Taxi Blues
- Hal Ashby: Harold and Maude, Being There
- John Woo: The Killer (Die xue shuang xiong), A Better Tomorrow
- William Peter Blatty: The Ninth Configuration
- Larry Clark: Kids
- Godfrey Reggio: Koyaanisqatsi, Powwaqatsi, Naqoyqatsi. (cinematographer Ron Fricke also directed Baraka)
- Peter Chung: Aeon Flux
- Quentin Tarantino: Reservoir Dogs, Pulp Fiction, Jackie Brown
- Barbet Schroeder: Barfly
- Marc Caro, Jean-Pierre Jeunet: Delicatessen, City of Lost Children, Alien Resurrection (Caro was design supervisor)
- Gerald Potterton: Heavy Metal
- Tony Scott: True Romance
- Oliver Stone: Natural Born Killers, Platoon
- Barry Sonnenfeld: The Addams Family, Get Shorty, Men in Black. (also cinematographer for Blood Simple, Throw Momma from the Train, Raising Arizona, When Harry Met Sally, Miller's Crossing)
- John Carpenter: Dark Star

## Rock Bottom Film Series (January 2002)

I hosted the Rock Bottom Film Series in my apartment during the week of my 31th birthday. The series lasted 5 days, starting on a Sunday night at 8pm. Each night, the show started an hour later, so that by Thursday night, we started at midnight and finished around 4am. Note that the morning after each night was a weeknight. I encouraged people to to drink booze, to eat unhealthy snacks, and to show up to work bright and early, on time, in the physical and mental state prepared by the previous night's show. What inspired this onslaught of hell? Entering my fourth decade, and driving home in rush

hour traffic.

The series has a theme, and furthermore, each movie connects with the others in some way. I had not yet seen *Pollock* or *Love and a .45* so their relevance was somewhat uncertain. The connections tended to be actions or themes, but sometimes the connection was more oblique. For example, Bud Cort appears in both *Pollock* and *Harold and Maude*. Also, Zoetrope Studios produced *Barfly* and *Apocalypse Now*.

The first movie for each night was the slower and the second more raucous. I thought this would allow people to stay awake more easily.

I sent a surly invitation, telling people to bring their own liquor -- and bring mine too, to expect rudeness and self-indulgence, etc. I intentionally omitted what day the series started. The *prima facie* purpose was to inform yet discourage. I like to challenge people, to make it difficult for them to show their loyalty, and it all fit into this emotional theme of bitterness. I figured that people would show up, or not, regardless of the manner in which I invited them, because there is a more fundamental connection between friends than politeness and fun. It turns out that I had a pretty good turn out. People attended each night, and many of them accepted the spirit of the series, went to work each day, etc.

These movies appeared in the Rock Bottom Film Series (again, listed with director) in the order and times shown:

| Night     | Start Time | First Movie                                          | Second Movie                                                  | Drink          |
|-----------|------------|------------------------------------------------------|---------------------------------------------------------------|----------------|
| Sunday    | 8pm        | <i>Barfly</i> (1987) -- Barbet Schroeder             | <i>Fear and Loathing in Las Vegas</i> (1998) -- Terry Gilliam | Gin            |
| Monday    | 9pm        | <i>Apocalypse Now</i> (1979) -- Francis Ford Coppola | <i>Fight Club</i> (1999) -- David Fincher                     | Whiskey        |
| Tuesday   | 10pm       | <i>Pollock</i> (2000) -- Ed Harris                   | <i>Heathers</i> (1989) -- Michael Lehmann                     | Wine / Port    |
| Wednesday | 11pm       | <i>Dead Man</i> (1995) -- Jim Jarmusch               | <i>Love and a .45</i> (1994) -- C.M. Talkington               | Tequila & Beer |
| Thursday  | Midnight   | <i>Leaving Las Vegas</i> (1995) -- Mike Figgis       | <i>Harold and Maude</i> (1971) -- Hal Ashby                   | Vodka          |

---

Michael J. Gourlay / [gourlay at colorado-research dot com](http://gourlay.at.colorado-research.com)



# Research

---

computational fluid dynamics  
and more

[home](#) [antarctica dome](#) [RESEARCH](#) [resume](#) [software](#)

---

## Research projects:

- 1999-present [Initially turbulent 3D wakes in stratified fluids](#)
- 1997-ongoing [Audio and speech synthesis](#)
- 1995-1999 [3D shear layers](#)
- 1989-1994 [Radar research](#)
- 1991-1993 [Network visualization](#)
- 1990-1993 [Chaos in Rydberg electron dynamics](#)
- 1989 [Supercomputer design and testing](#)

---

[Dr. Michael J. Gourlay](#) ([www.co-ra.com/~gourlay/research/](http://www.co-ra.com/~gourlay/research/)) / gourlay at colorado-research dot com



scrytch













Content under the  
scrytch Public License  
by Michael J. Gourlay

[home](#) [dome](#) [research](#) [resume](#) [scrytch](#) [software](#)

Text Images VRML

[Michael J. Gourlay](#) / gourlay at colorado-research dot com

# Index of /~gourlay/software

| <u>Name</u>                                                                                                                  | <u>Last modified</u> | <u>Size</u> | <u>Description</u> |
|------------------------------------------------------------------------------------------------------------------------------|----------------------|-------------|--------------------|
|  <a href="#">Parent Directory</a>           |                      | -           |                    |
|  <a href="#">Algorithms/</a>                | 28-May-2004 09:27    | -           |                    |
|  <a href="#">Computer-Theory/</a>           | 28-May-2004 09:27    | -           |                    |
|  <a href="#">Graphics/</a>                  | 28-May-2004 09:27    | -           |                    |
|  <a href="#">Java/</a>                      | 28-May-2004 09:27    | -           |                    |
|  <a href="#">JavaScript/</a>                | 28-May-2004 09:27    | -           |                    |
|  <a href="#">Lattice/</a>                   | 28-May-2004 09:27    | -           |                    |
|  <a href="#">VortexSystem/</a>              | 28-May-2004 09:27    | -           |                    |
|  <a href="#">anagram.c</a>                  | 15-Nov-1999 20:27    | 20K         |                    |
|  <a href="#">arcade/</a>                  | 28-May-2004 09:27    | -           |                    |
|  <a href="#">krb5-Linux-2.X-x86.tar.Z</a> | 29-Nov-1999 12:21    | 1.3M        |                    |
|  <a href="#">krb5-win32.exe</a>           | 29-Nov-1999 12:22    | 640K        |                    |

Apache/2.0.49 (Fedora) Server at www.colorado-research.com Port 80

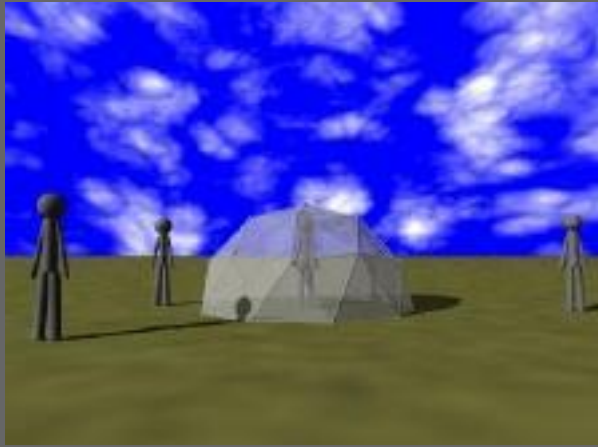

# Details for constructing a Small Geodesic Dome

## Plans for making a dome.

16 foot diameter steel conduit frame. 24-foot nylon parachute. 200 square feet of floor space.

by MiJa Gourlay

[home](#) [antarctica](#) [audio](#) [music](#) [dome](#) [movies](#) [research](#) [resume](#) [scrytch](#) [software](#)

[freq-4 dome designs](#) [covering patterns](#) [misting system](#) [VRML camp](#) [Hexayurt](#)

## Small dome details

### Materials

The materials for this dome include

- 35 of conduit poles (a.k.a. electrical metal tubing, a.k.a. EMT), 10 feet long, 3/4 inch diameter zinc-coated non-rigid steel)
- 35 bolts, 3 inch long, 3/8 inch diameter, hex head, steel, no thread gap
- 35 nuts, which fit the bolts (check before buying)
- 60 washers, which fit the bolts
- 1 nylon parachute, 23.5 feet diameter, white

Although smaller conduit has some popularity among dome builders, I do not recommend using 1/2 inch diameter conduit because it will not survive being climbed or hung on and this invariably happens. In fact, 3/4 inch diameter poles will not usually survive climbing or hanging either. If you

intend to have a lot of gymnastics on your dome, use 1 inch or 1-1/4 inch diameter EMT, or use rigid pipe. Also, 1/2 inch diameter conduit is not strong enough for the "entrance" modification described below. 1/2 inch diameter conduit is also 25% cheaper.

The above number of nuts and bolts exceeds the number required; this dome has only 26 vertices. Extra nuts and bolts are desirable because some of these small parts *will* be lost (often at the worst possible moment).

Note that bolts with a 3/8 inch diameter shaft have 9/16 inch hex heads. This is important when choosing a wrench. (Of course, you would figure out this detail on your own, but it is worth mentioning that when I write 3/8 inch diameter bolt, I am referring to the shaft diameter, not the size of the hex head.) When you obtain the bolts, the hardware store will list the bolts by the size of their shaft, not the size of their heads. (This whole paragraph is far too phallic.)

Bolts with a diameter of 5/16 inch could be used instead at the loss of some strength. Smaller bolts would be slightly cheaper, and would also work better for a dome made of 1/2 inch diameter conduit poles.

When buying bolts, note the extent of the threads. Some hex-head cap bolts have thread only along about 1 inch of the end of the bolt. Using extra long all-thread bolts allows you to have a long bolt so that you can fit all of the edges at the vertices easily even if they are bent out of shape (as will happen if the ends are not parallel) but still allow you to tighten down the vertex as far as it can go.

The bolts listed above significantly exceed the length required for simply fastening the poles. The extra length is a hazard if the bolts are not capped. The extra length can also be used to attach a covering, such as tarps strategically cut and grommetted to rest on the dome vertices.

I purchased the parachute from the [Boulder Army Store](#). The parachute was marked with a label, "May 1945 Eagle Parachute Corp.". It has 24 radial ribs with cotton twine running along the ribs, terminating at the bottom with about 2 feet of twine to attach to something (and the ends of the ribs are numbered for your convenience!). At the top of the parachute is a hole, about 1 foot in diameter, where all of the twine ribs cross. (This hole is always present in circular parachutes to let air pass through to keep the parachute from collapsing when it is deployed.) The cost was \$96 including sales tax. My understanding is that similarly sized parachutes are available for far less money (as little as \$30) although it is not clear whether there is a difference in quality (e.g. in the thickness of the material.)

The tools I used to construct the dome included

- a tape measure to measure lengths on poles;
- a felt marker to mark measured places;
- a hack saw to cut poles;
- a torpedo level to align the tube ends;
- a speed square, used as a protractor;
- a 5 1/4-inch vise to hold things and bend pole ends;
- a sledge hammer or power hammer to flatten some pole ends;
- a hand drill, a drill press, and a drill press vise to drill holes;

- two wrenches (one ratchet, one box end) to tighten bolts and nuts;
- 2" and 3" C-clamps to hold together poles at vertices,
- a 7.5-foot tall A-frame ladder to hold up the dome during assembly.

One drill press I used was not excellent, and I could have done without it, but it helped. If you do not have a drill press, just use a hand drill, and be very careful about where you drill the hole. Make sure to use an excellent drill bit for drilling through metal. Keep the bit sharp and well-oiled.

The ladder was used as a support (like a tall saw horse) for the dome during assembly, in lieu of an assistant. If you have at least 2 people working on assembling the dome, the ladder is not necessary.

## Size Calculations

There are at least two approaches to deciding the pole lengths for a small dome. One is to make the largest dome possible using each 10-foot EMT pole to make two dome poles, thereby maximizing the use of each 10-foot pole. Another approach is to fit the dome to the parachute covering as closely as possible. The subsections below describe each of these approaches.

### Maximizing dome size with optimized waste

Imagine that we want to make the largest 2-frequency dome we can out of 10-foot poles while minimizing waste. That is, we want to use each 10-foot conduit pole to make 2 dome poles. We want to find the dome pole lengths such that they add up to exactly 10 feet, and still

have the correct length ratio. Assume 3/4 inch of padding at each end and 1 inch between the vertex and the bend. After doing the math, you will find that the corresponding dome has a height of about 100.5 inches (about 8' 4.5"). This yields dome poles with nominal lengths of 62 inches and 55 inches. Accounting for bending and padding would yield total lengths of 63.5 inches 56.5 inches, which adds up to 10 feet.

| (lengths in inches) | Longer edges | Shorter edges |
|---------------------|--------------|---------------|
| <b>Nominal</b>      | 62           | 55            |
| <b>total</b>        | 63.5         | 56.5          |

There is a subtle issue with the above calculations: There are 35 longer poles and 30 shorter poles, so 5 of the longer poles will have no corresponding shorter poles. That means you will have to waste 5 of 56.5 inch long poles if you use the lengths given in the previous paragraph. If you make an entrance, then 5 more of the shorter poles will also not be used, for a total of 10 unused shorter poles.

To make an entrance for this dome, use two poles which have a length of 80 3/4" with holes drilled 3/4" in from each end. Attach these in the usual way for an entrance. This is discussed in more detail below.

### Fitting dome to parachute

An alternative to optimizing the dome size is fitting to some prescribed size, such as the size of a parachute to be used to cover the dome. Usually, this is not desirable because you will want

ventilation through the bottom, but in case you find yourself wanting to match the dome size exactly to a cover size, I present here a method to calculate the dome size.

In order to have the parachute barely tucked under the frame, I used the lax length of the parachute when deciding the dome size. My parachute has a lax diameter of 23 feet, 3 inches (279 inches). This corresponds to a dome with a diameter of  $(279 * 2 / \pi) = 177 \frac{19}{32}$  inches, or a radius of  $88 \frac{25}{32}$  inches. The nominal edge lengths would then be  $54 \frac{7}{8}$  inches and  $48 \frac{17}{32}$  inches.

Assuming a pre-vertex-hole bend of 2 inches at each end, the pole was lengthened by  $\frac{3}{16}$  inch to account for bending effects.

The distance between vertex holes is the nominal edge length plus the extra added to account for bending effects. For the longer edges, the distance between vertex holes was  $55 \frac{1}{16}$  inches. For the shorter edges, the distance between vertex holes was  $48 \frac{23}{32}$  inches.

| (lengths in inches) | Longer edges | Shorter edges |
|---------------------|--------------|---------------|
| <b>Nominal</b>      | 54.8868      | 48.5346       |
| <b>bending</b>      | +0.1872      | +0.1872       |
| <b>vertex holes</b> | 55.0740      | 48.7236       |
| <b>padding</b>      | +3.00        | +3.00         |
| <b>total</b>        | 58.0740      | 51.7236       |

For drill-hole padding, I added 1.5 inches to *each end* (3 inches, total) outside the vertex holes. Using 1.5 inches of padding seems perhaps a bit excessive, but the resulting flange is useful at the assembly stage for attaching C-clamps. If you can be more precise with your flattening and bending than I was, then you might be able to get away with having as little as  $\frac{3}{4}$  inch of padding. For the most part, though, having an extra flange does little or no harm and is potentially useful. Remember that if you shorten your padding, then you may also shorten the bending length and will have to recalculate the bending length modifier.

Tally the length modifiers (drill hole padding and bending effects): In total, I had to add  $3 \frac{3}{16}$  inches to the nominal lengths of the poles. This made the desired lengths of poles  $58 \frac{1}{16}$  inches and  $51 \frac{23}{32}$  inches. These are the cut lengths.

## Cutting

I cut the lengths from the conduit using a high-tension hack saw. Some people recommend using a chop saw.

## Flattening

I flattened the pole ends as discussed in ["Design and Implementation"](#) in the Flattening section. The length of the flat part should be marginally longer than twice the distance from the vertex hole to the pole end, in order to allow for the poles to overlap without their butts hitting other poles. For the 100.5-inch diameter dome, using the lengths described above, flatten each end at least 2 inches. The flat parts at each end should be parallel to each other. If the flattened pole ends are not sufficiently parallel, assembling the dome will be much more difficult.

## Drilling

Drill each vertex hole  $\frac{3}{4}$  inch from the end of the pole. Measured the distance carefully using the distance between vertex holes calculated above. I marked the positions of the vertex holes, and carefully drilled them.

For  $\frac{3}{4}$  inch diameter conduit poles, the circumference is 2.356 inches, so, when flattened, the width is 1.178 inches ( $1 \frac{3}{16}$  inches). A third of that is about  $\frac{3}{8}$  inch, which is the size I used for the vertex bolt diameter.

I thought it would be easier to assemble the dome if the vertex holes were slightly larger than the bolt shafts, so I drilled  $\frac{7}{16}$  inch diameter holes instead of  $\frac{3}{8}$  inch diameter holes. I thought the larger holes would give me some play which would account for errors in hole placement. Ends up, I probably did not need to drill over-sized holes. If I had to do it again, I would not drill over-sized holes. Oversized holes end up making washers even more crucial than otherwise because the nuts and bolt heads grind their way through the poles, causing a disaster.

## Bending

I marked a line across each flattened pole end 2 inches inside of the center of the vertex holes. This is the place where the bend would be.

Using the vise, I bent the end of each pole by 18 degrees, as discussed in [`Design and Implementation`](#) in the Bending section.

## Marking

You might find it useful later to have the poles marked to indicate their length. For example, you might want to paint the shorter poles white and leave the longer poles unpainted. This is not crucial, and I did not do such marking, but there are times when the dome is part-way completed, and the symmetries are obscured. For a dome of frequency higher than 2, color coding or some other marking scheme would be crucial.

## Pre-Assembly

It might be useful to assemble a collection of triangulated pentagons as the poles are fabricated, to make sure that the vertices are in the right place. Start at the center of each pentagon, connect the 5 short poles, then connect the longer perimeter poles. If an error has been made in the positioning of the vertex holes, then it will be more difficult to complete the pentagons.

The intermediate pentagons will have shared vertices so if you have enough nuts and bolts to make all of the intermediate pentagons, some of those nuts and bolts will be redundant. Nuts and bolts are cheap, so having extra is worth their cost and will come in handy when they are lost.

## Assembly order

We assembled the dome starting at the top vertex and added poles from the top, spiraling around, toward the bottom. As usual with assembling things, we kept the bolts only partially tight on the first pass so that the pieces had some freedom to settle into their natural positions.

The top triangulated pentagon (vertices 1 through 6) was relatively easy to assemble, since it only involved 10 pieces and they did not weigh each other down.

The next natural tier downward involved vertices 2 through 12 (7 through 12 being totally new, 2 through 6 already in place from the initial pentagon), which involved 20 new poles. It was possible to assemble this tier with only one person, but having another person hold up parts of the dome made assembly easier.

The final tier involved 25 new poles. The entire weight of the dome was working against us as we brought together each vertex. Having more than one person was helpful at this stage. (When working alone, I used a 7 1/2 foot tall ladder to hold up the dome at its vertex so that it was not touching the ground for the last tier of assembly.)

## Bolting together the vertices

For vertices with 4 poles (the bottom ring), I used 1 1/2 inch long bolts. For vertices with 5 or 6 poles I used 2 inch long or 2 1/2 inch long bolts. I avoided the 2 1/2 inch bolts because they leave a very long piece of unused bolt sticking out, which could snag on things or poke people. However, sometimes the longer bolt is just easier to deal with. Sometimes (maybe once) I used a 2 1/2 inch bolt just to get all of the pole ends together, then C-clamped them, removed the bolt, and replaced it with a shorter one. For a temporary structure, that sort of attention to detail is only marginally valuable, but if the dome will be set up in your back yard for a patio or put to some other semi-permanent use, then such effort might be worth while.

Using longer bolts will speed up and simplify assembly at the cost of having long pieces of metal sticking out at people. It's all fun and games until someone puts an eye out. Hardware stores sell plastic bolt caps that mitigate this problem. The problem is worst for vertices close to where humans can easily reach, and for this small dome design, those bolts are at the level of vertices above the ground level (i.e. vertices 7-16 in the schematic diagram).

I always used a washer at each end of the bolt. If 1/2 inch holes are drilled and bolts with 3/8 inch diameter shafts are used, the hex heads on those bolts will be 9/16 inch, which is only 1/16 inch larger than the 1/2 inch holes. This implies that the hex heads could slip through the holes, especially if the holes are a little larger than the bit (which is always the case). Also, while tightening the bolts and nuts, they will grind away the soft metal of the conduit, and enlarge the holes, making it yet more likely that the bolts will slip through. It is therefore **crucial** that washers are used at *each end* of the bolt, to prevent the bolt head and the nut from slipping through the vertex holes. Using washers will also make tightening the bolts and nuts easier.

My worst problem came from when the pole ends were not perfectly parallel -- then I had to get out the C-clamps or use longer bolts. It was during the assembly of this dome that it occurred to me how it was possible to create the world in just 6 days by a single being: Use a lot of C-clamps. (I am told that duct tape was also employed, which accounts for the necessity of the weirdness of quantum mechanics, but fortunately, this dome obeys classical physics to a good approximation, since it is nearly spherical.)

If the flattened ends are not parallel or not perfectly flat (which is inevitable if a sledge hammer is used to flatten them, which is why I recommend using a vise), you will either have to use inelegantly long bolts, or find a way to force the pole ends into place. I found that adding one pole at a time solved the problem, at the cost of taking much longer than necessary. Here is the



procedure I used:

- Place a bolt through as many vertex holes as possible, then tighten down the nut as far as possible.
- Use a couple of C-clamps to hold the pole ends together. If the top and bottom poles in the stack are diametrically opposed, then it will be easier to apply the C-clamps. Keep this in mind when assembling the vertex.
- Remove the nut from the bolt, add another pole, add the washer, tighten down the nut as far as possible, and remove the C-clamps.

Using this incremental process to assemble each vertex works fairly well and is not as slow as it might seem. In fact, using this process is often faster than assembling all poles on a vertex on the first try.

If you want to use the exact same configuration for future assemblies of the same dome (as might be useful if any vertex holes had to be elongated), mark each pole near each vertex with a number. It might also be useful to indicate the stacking order of the poles, but this should not be critical. (I did not do any such marking.)

## Entrance

The triangles are sort of short (around 4 feet tall) which requires ducking to get in or out of the dome. In order to make a entrance, I removed the radial edges of one of the lower triangulated pentagons (e.g., all edges touching one vertex 12). The dome will be less stable after removing those edges, but sufficiently stable to remain standing. The missing pentagon provides a entrance about 6 feet tall and about 4.5 feet wide at the base.

To strengthen the entrance, I added an edge from the middle of the top two edges of the pentagon to the bottom two vertices of the same pentagon. (e.g. if edges from vertex 12 are removed then add an edge from vertex 26 to mid-way along the edge between vertices 2 and 11, and add an edge from vertex 17 to mid-way along the edge between vertices 2 and 7.)

The bolt-to-bolt length of the new struts is 0.771681 times the radius of the dome. For a 100.3 inch tall dome, that yields a length of  $(0.771681 * 100.3 \text{ inches}) = 77.4 \text{ inches}$  plus the usual length modifiers, for a cut length of 78.9 inches. The height of this entrance would be about  $(0.850651 * 100.3 \text{ inches}) = 85.5 \text{ inches}$  off the ground.

If the entrance struts are to have a strength balance with the rest of the dome, then their diameter should be larger than those of the rest of the dome. E.g. the dome is made of 3/4" EMT so I made the entrance struts with 1" EMT.

When drilling a hole through the mid-way point, use a drill bit smaller than or equal to the bolt diameter. Use a 1/4" diameter bolt with washers. (A smaller bolt is preferable here because drilling a hole at the midway point will reduce the integrity of the pole precisely at its weakest point.)

After adding the struts, the strength of the dome was increased but some flexibility remains. If any vertices will be loaded heavily, the vertices adjacent to the missing pentagon are to be avoided.

# Geodesic Dome Design by MiJa Gourlay

<http://www.colorado-research.com/~gourlay/dome/>

---

[Dr. Michael J. Gourlay](#) / [gourlay at colorado-research dot com](#)

# Higher Frequency Designs for Icosahedral Geodesic Domes

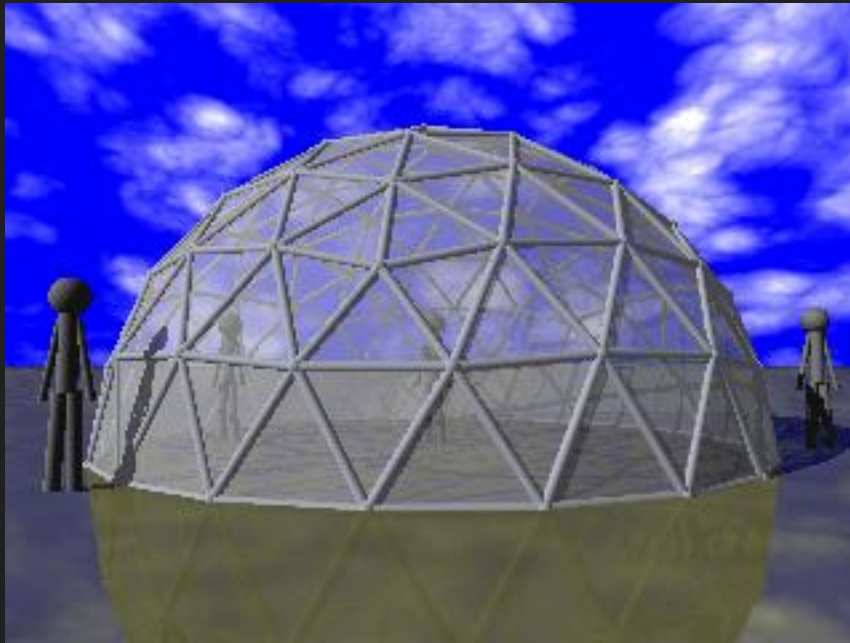

A frequency-2 large dome is difficult to transport.

These designs might solve that problem,

but they introduce other problems.

## Why consider higher frequency designs?

Many geodesic geometries could be used to form a dome of a given diameter. Lower frequency geodesics use fewer, longer poles and simpler geometry. Higher frequency geodesics use more, shorter poles and more complex geometry.

Higher frequency designs allow for shorter and thinner poles, which are easier to transport, cheaper to buy, and less unwieldy. Frequency-4 designs, however, use 2.7 to 3.8 times as many poles as the analogous freq-2 designs, but since the freq-4 poles are shorter, they can be smaller in diameter for the same rigidity. As frequency increases, dihedral angles between faces decrease, so vertices more easily invert, and

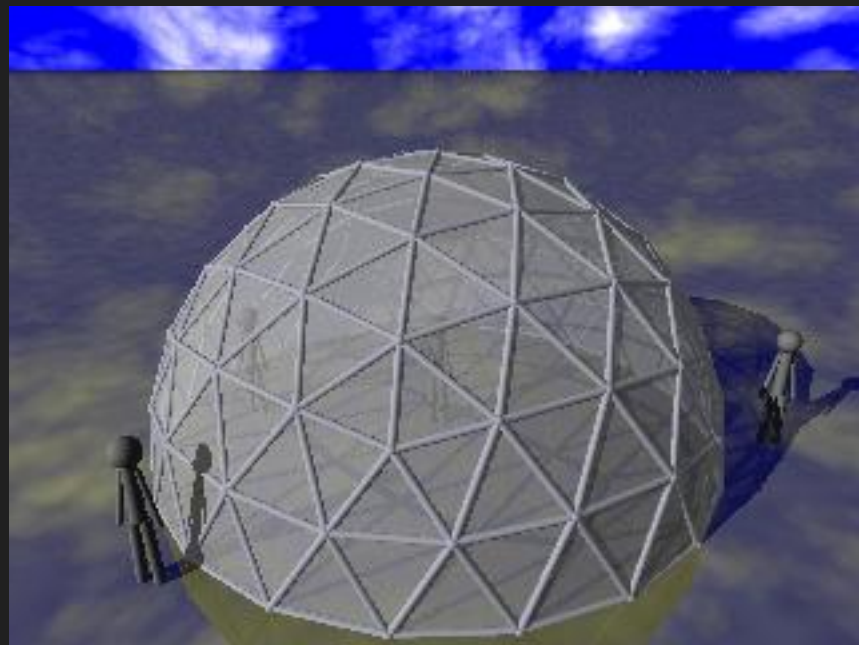

therefore the structural integrity diminishes.

Frequency-4 icosahedral domes are presented here for both class-1 and triacon varieties of geodesics, along with frequency-3 designs.

Each pole is called an **edge** and each place where the poles meet is called a **vertex**. To simplify assembly and reduce the chance of errors, the ends of each pole should be painted according to the color scheme in the schematic diagrams presented here.

For each design, I present a set of "optimized" dimensions. These are optimized in the sense of trying to minimize wasted pole material while maximizing dome size, under certain constraints. The optimized designs assume that the builder wants the largest dome which uses poles around 5 feet long, that these poles will be cut from 120-inch long metal conduit stock, that the drill holes centers are 3/4 inch from the ends of the poles, and that the pole ends are bent 2 inches in from the ends. The angle of the bend should be roughly 9 degrees from a straight line.

For ease of assembly, I recommend using 4-inch long all-thread bolts for all but the head-height vertices. The vertices at head-height should use shorter bolts, and those bolts should be capped with plastic bolt caps, to reduce the risk of impalement. I recommend using bolts with 3/8 inch diameter shafts. The bolts should not be the cheapest, lowest grade of metal because on the playa those materials will corrode and the heads will shear off during assembly or disassembly. Use high-grade or stainless steel bolts. Coat the bolts, nuts and washers in lubricant (such as WD-40) before assembly and after disassembly.

## Frequency-4 class-1 design

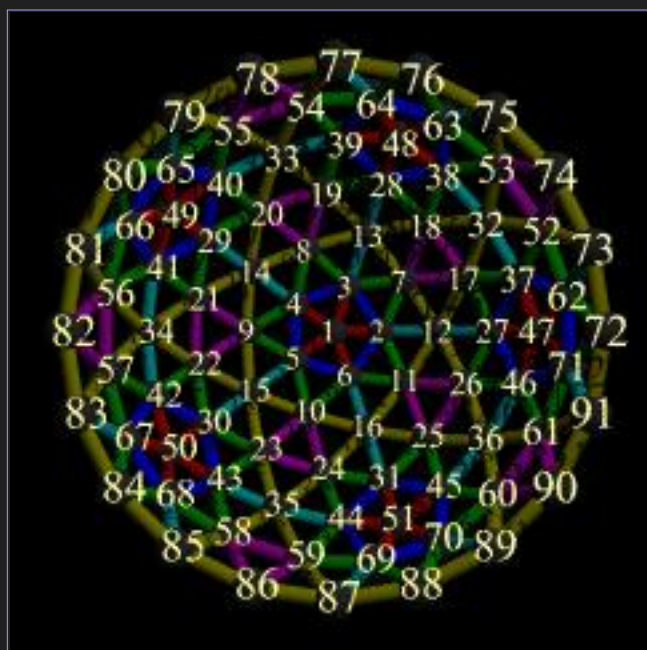

This is the bottom view of a frequency-4, class-1 icosahedral geodesic dome.

To perform class-1 division (also called "alternate" division), divide each edge of a polyhedron by N where N is called the frequency of the geodesic. Within each original polygon, connect those points with edges. For N greater than 2, those new edges will intersect each other to produce yet more points. Each triangle will then become  $N^2$  triangles. Finally, raise all of the new vertices to the circumscribing sphere.

As the diagram shows, this design has 6 pole lengths,

250 poles, 91 vertices. Euler's formula ( $V-E+F=2$  or  $F=2+E-V$ ) tells us that there are 161 faces. One of those is the bottom, so there are 160 triangular faces on the top.

| number | relative length |
|--------|-----------------|
| 30     | 0.253185        |
| 60     | 0.294531        |
| 30     | 0.295242        |
| 30     | 0.298588        |
| 70     | 0.312869        |
| 30     | 0.324920        |

# Optimized Dimensions

Pole lengths for a frequency-4 class-1 icosahedral geodesic dome with a height of about 16 feet, a diameter of about 32 feet, and which has a ground-floor area of about 810 square feet.

| number | pole length |
|--------|-------------|
| 30     | 50.270      |
| 60     | 58.234      |
| 30     | 58.370      |
| 30     | 59.015      |
| 70     | 61.766      |
| 30     | 64.087      |

To minimize materials waste, use a dome radius of 192.624 inches. This corresponds to a dome 16 feet, a diameter of about 32 feet, and which has a ground-floor area of about 810 square feet. This design requires 125 of 120-inch long poles. Note that the lengths 58.234 and 61.766 sum to exactly 120. Those are the length pair which establish the optimized dimensions for this design.

The table has ?? in the "number" field because I fucked up the original count and don't have time right now to fix the count.

This "optimized" design, as compared to the analogous optimized design for the frequency-2 class-1 icosahedral design, results in about the same size dome.

| number | length 1   | length 2   | sum        |
|--------|------------|------------|------------|
| ??     | (0.253185) | (0.324920) | (0.578105) |
| ??     | (0.253185) | (0.312869) | (0.566054) |
| ??     | (0.294531) | (0.312869) | (0.607400) |
| ??     | (0.294531) | (0.298588) | (0.593119) |
| ??     | (0.295242) | (0.298588) | (0.593830) |
| ??     | (0.298588) | (0.298588) | (0.597176) |

Assuming 3/4-inch diameter metal conduit would be used at a price of \$2.00 per 120-inch pole, the cost of tubing for this design is \$250. The cost of fasteners would probably be around \$50.

By comparison, a frequency-2 class-1 icosahedral dome with a nearly 32-foot diameter, using 1-inch diameter metal conduit, would cost \$240 for conduit plus about \$15 for fasteners. Such a freq-2 design would be less strong (by maybe 50%) than the analogous freq-4 dome.

## Frequency-4 triacon design

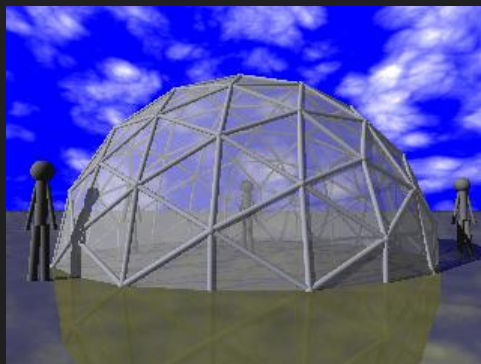

Although triacon division was the first used by Buckminster Fuller to generate geodesic geometries from Platonic polyhedra, this method is less often seen in hemisphere structure design. Notice that the bottom perimeter of this design does not touch the ground with a

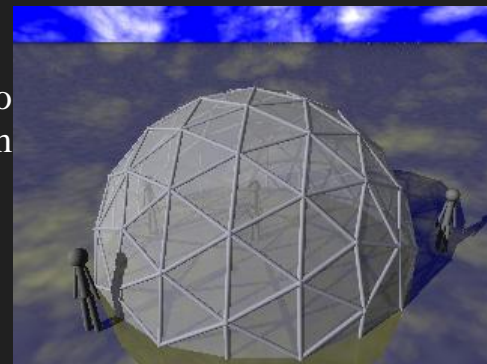

polygon as do the other designs. That is not a problem, just something to notice. The bottom vertices can be joined to complete the dome bottom. Also note that the cartoon renderings show vertical poles extending through the ground. Those should be ignored. They are shown because they exist in the complete triacon sphere but they are useless in the triacon dome. They could be used to halve the length of the poles around the bottom perimeter, but aside from keeping pole lengths down, there is not much point in doing that.

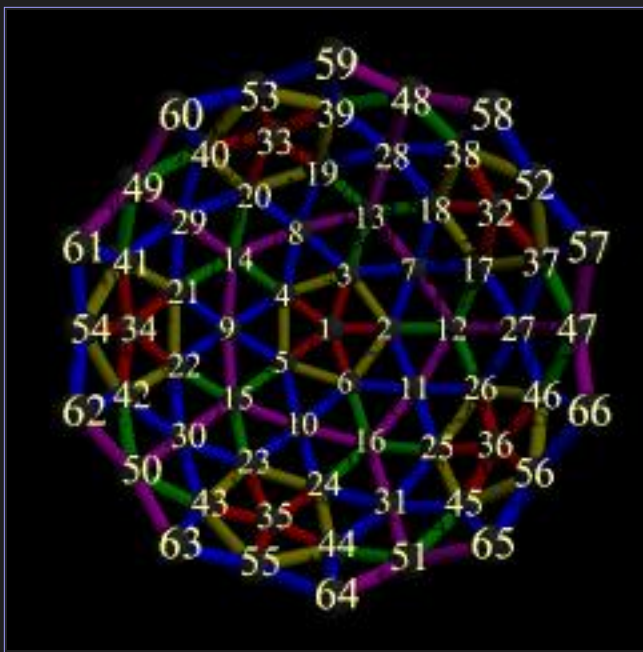

This image depicts the bottom view of a frequency-4 triacon icosahedral geodesic dome.

To perform triacon division, bisect each original angle of a polyhedron. This will create a set of intersections of bisectors. Raise those new points to the circumscribing sphere. Connect those new, raised intersections with edges. A final step to remove the original edges is typically performed.

This design has 5 pole lengths, 175 poles (plus 10 more poles, not shown, to complete the bottom perimeter), and 66 vertices. The relative length of the 10 bottom poles is 0.618034.

| number | relative length |
|--------|-----------------|
| 30     | 0.309107        |
| 25     | 0.340342        |
| 60     | 0.346688        |
| 30     | 0.359011        |
| 30     | 0.362843        |
| 10     | 0.618034        |

Euler's formula tell us there are 111 faces. One face is the bottom, so there are 110 triangular faces on top.

### Optimized Dimensions

Pole lengths for a frequency-4 triacon icosahedral geodesic dome with a height of about 14 feet, a diameter of about 28 feet, and which has a ground-floor area of about 620 square feet.

| number | pole length |
|--------|-------------|
| 30     | 53.659      |
| 25     | 58.929      |
| 60     | 60.000      |
| 30     | 62.080      |
| 30     | 62.726      |
| 10     | 105.787     |

To minimize materials waste, use a dome radius of 168.740 inches. This corresponds to a dome diameter of about 28 feet, and which has a ground-floor area of about 620 square feet. The table presents the resulting pole lengths. This design requires 93 of 120-inch long poles for the skeleton shown, plus 10 poles for the bottom perimeter. Notice that the 60.000 inch poles are cut two to a 120-inch stock pole. This determines the optimized dimensions of this design.

This "optimized" design, as compared to the analogous optimized design for the frequency-4 class-1 icosahedral design above, results in a 13% smaller dome, with 23% less floor area.

Assuming 3/4-inch diameter metal conduit would be used, at a price of \$2.00 per 120-inch pole, the cost of tubing for this design is \$185. The cost of fasteners would probably be around \$40.

| number | length 1   | length 2   | sum      |
|--------|------------|------------|----------|
| ??     | (0.309107) | (0.362843) | 0.671950 |
| ??     | (0.340342) | (0.359011) | 0.699353 |
| ??     | (0.340342) | (0.346688) | 0.687030 |
| ??     | (0.346688) | (0.346688) | 0.693376 |
| ??     | (0.618034) | (0.0)      | 0.618034 |

## Frequency-3 design

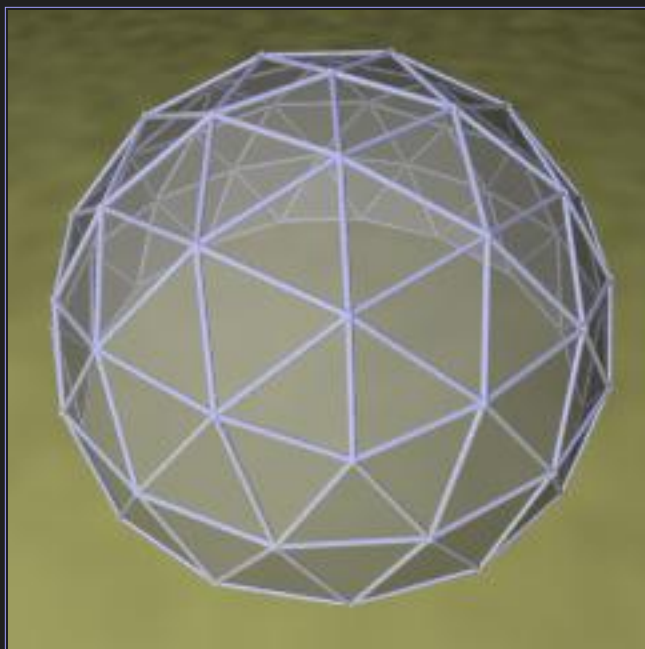

Pole lengths for  
a frequency-3  
icosahedral  
geodesic 4/9  
dome

| #  | length |
|----|--------|
| 30 | 0.3486 |
| 40 | 0.4035 |
| 50 | 0.4124 |

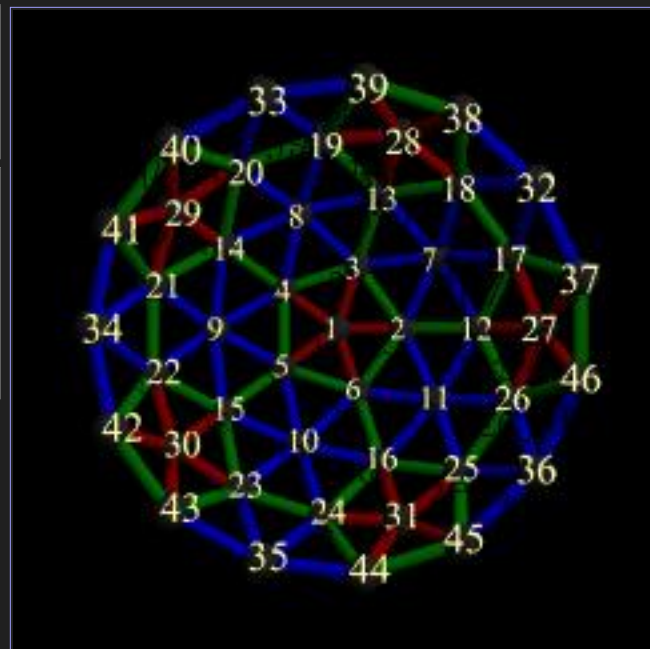

Click on an image to see a larger version. Move mouse over oblique view to see 4/9 truncation, or off oblique view to see 5/9 truncation.

The odd-frequency designs can not be made into a hemisphere. They are therefore either extended just past the hemisphere, or just short of it. The images above show 5/9 and 4/9 domes. The bottom view of a 5/9 dome would look unclear because some of the poles and vertices would overlap, so the smaller dome is shown for that view. The oblique view, however, shows the slightly larger 5/9 dome when the mouse is not over the image, and shows the slightly smaller 4/9 dome when the mouse is over the image.

Note that for the 5/9 dome, the bottom tier of triangles is nearly vertical. The peculiarity that odd-frequency domes have no true geodesic polygon, i.e. that they can not make an even hemisphere, ends up also avoiding one of the more annoying aspects of an even frequency dome, which is that even frequency domes have no vertical walls at the bottom.

Note that the vertices of the bottom layer are not exactly at the same level; They vary in height by 0.016 radii, or about 1.6 percent of the dome height. For a 12-foot tall dome, that variation would be about 2 inches (only about twice the size of a typical EMT pole diameter). Depending on the application, that could be considered too small to worry about. The structure could be warped slightly, small blocks could support the vertices which lie above the ground, or the poles on the bottom layer could be adjusted to exactly meet the horizontal ground plane. The main problem with making that length adjustment is that the poles on the bottom layer could no longer interchange with other, nearly identical poles elsewhere in the dome. Keeping track of the slightly different poles would entail difficulties. Note that the oblique view shows a 5/9 dome with an uneven bottom layer, but the height variation of those vertices is not obvious.

Odd-frequency geodesics have no triacon varieties.

[Michael J. Gourlay](http://www.colorado-research.com/~gourlay) / gourlay at colorado-research dot com

# Geodesic Dome Covering Patterns

[home](#) [antarctica dome research](#) [resume](#) [scrytch software](#)

[small steel dome details](#) [Pyrot coverings](#)

## Geodesic Dome Covering Patterns

These geodesic dome patterns are examples of how to cut material for making custom-fit dome coverings. There are several ways to approach this problem. In general, you probably want to minimize the number of seams as well as the amount of wasted material, while being constrained by the dimensions of available fabric.

The dimensions provided here are for a class-1 frequency-2 icosahedral geodesic dome with a floor diameter of about 201 inches.

The 6-inch seam allowance or "tab" areas (indicated as the region between solid cut lines and dashed edge lines) are wider than the standard tarp grommet seam width. The intention here was to create separate overlapping pieces with 2-inch wide margins for overlap and 4-inch wide margins for error in placement of the grommets. An alternative would be to join the pieces at appropriate edge lines, in which case smaller tabs could be used.

### Pentagon Triangle

This is a basic isosceles triangle pattern used to cover a single triangle within a "pentagon". Note that this pattern will not fit over any of the equilateral triangles within a "pentagon".

(Here "pentagon" refers to a collection of five identical acute-angled isosceles triangles joined along their short edges, such as at the top of an icosahedron or icosahedral geodesic dome. The actual shape is technically not a pentagon because it is three-dimensional, not two-dimensional. Still, the shape reminds one of a pentagon and the name "pentagon" is shorter than "hexahedron with five identical isosceles triangles and one regular pentagon" which is a more accurate description. To see an example of the "pentagon" referred to here, look at the [schematic diagram of a frequency-two class-one hemispherical icosahedral geodesic dome](#) and look at the shape created by vertices 1-6.)

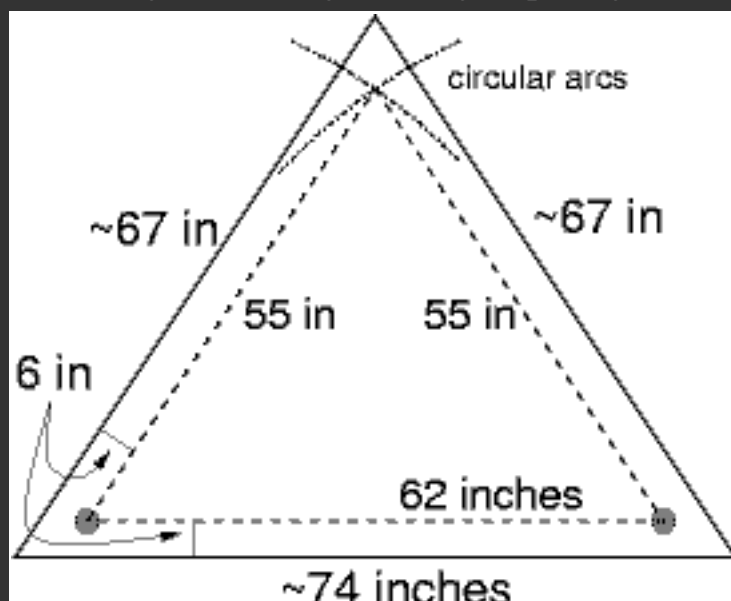



This "pentagon" triangle pattern is part of the basis for several other dome cover patterns.

To use this pattern to create the other patterns, measure onto large paper or fabric the inner triangle (drawn with dashed lines) and cut out that triangle. Alternatively, cut out the larger triangle and perforate your pattern along the dashed edge lines to allow for marking through the perforation. To construct a triangle, follow these steps:

- Using a long straight edge or a measuring tape, measure the bottom line segment. The length of the line segment should be equal to the length between bolts on the longer poles of the geodesic dome. For the example shown, the line length is 62 inches.
- Using the endpoints of the first line segment as the centers of imaginary circles, draw circular arcs with a radius equal to the length between bolts of the short poles of the geodesic dome. In this example, the radius is 55 inches. The place where those circular arcs intersect marks the final vertex of the triangle. Draw lines from that intersection to each of the endpoints of the first line segment.

(To draw a large circle, use a piece of string and a pen: Hold one end of the string to the center of the circle. Measure the string to the desired radius of the circle. At that point, tie a secure knot and place the tip of a pen into the knot. With the string taugth, draw the circle. Make sure the pen angle does not change while drawing.)

## Equalateral Triangle

This is a basic triangle pattern used to cover one equalateral triangle outside one of the "pentagons". Note that this pattern will not fit over any of the isosceles triangles which are inside a "pentagon".

As with the "pentagon" triangle, this equalateral pattern is part of the basis for several other dome cover patterns.

The patterns below consist of these basic triangles. Once you have basic triangle patterns, construct other patterns by appropriately placing the basic triangles on a large sheet of fabric and tracing the outline of the basic triangle.

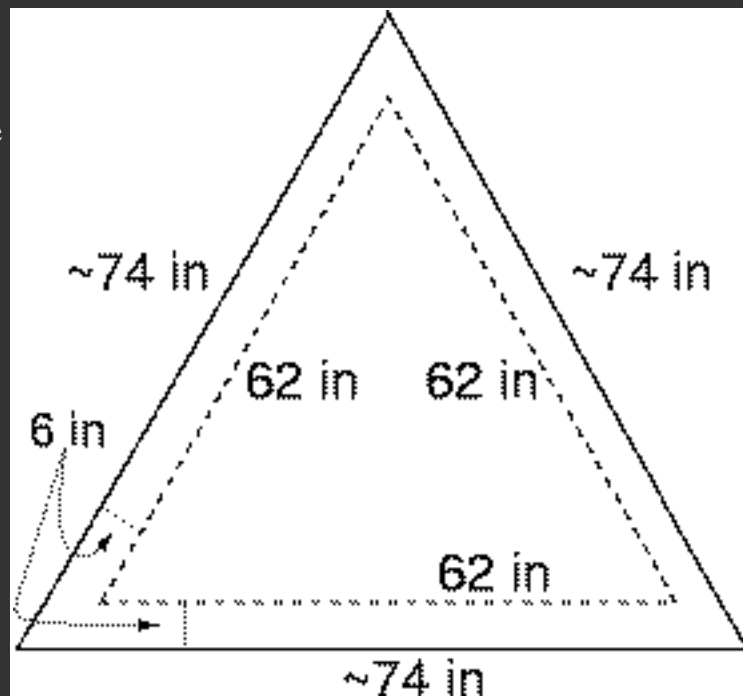

## Divided Original Triangle

This is a pattern used to cover an entire divided original triangle. A divided original triangle is one of the complete polygons based on the division of an original triangle of the original triangular polyhedron. In this case, that is one of the original triangles of the icosahedron. (Click image for larger version.)

Using five copies of this design one could cover the top two of three tiers of a class-1 frequency-2 icosahedral dome.

Note that this pattern is technically not a triangle -- it is an irregular hexagon made of four triangles: one equilateral (in the center) and three "pentagon" triangles (around the equilateral).

The "divided original triangle" complements the "geodesic strip" pattern. Using five of each of those patterns would cover an entire hemispherical frequency-two class-one icosahedral geodesic dome.

You can easily make an accurate template for this pattern by connecting dome poles in the layout of this pattern. This method reduces accumulated errors that using a ruler would introduce. This method also eliminates the confusion of what size edges to use for dome sizes other than that used in the calculations in this page.

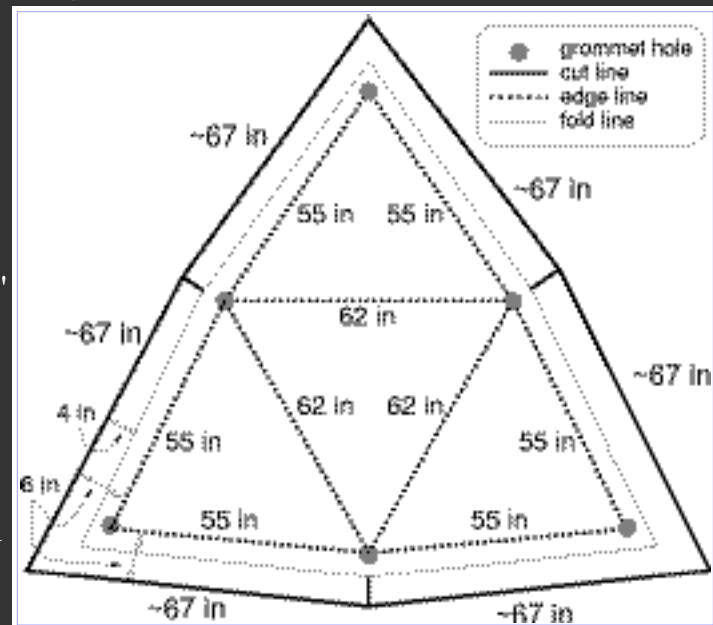

## Geodesic Strip

This is a basic geodesic strip pattern used to cover part of a line along a geodesic perimeter.

Note that this pattern consists of 4 of the basic triangles: one equilateral (on the left) and three "pentagon" triangles. (Click image for larger version.)

The "geodesic strip" complements the "divided original triangle" pattern. Using five of each of those patterns would cover an entire hemispherical frequency-two class-one icosahedral geodesic dome.

You can easily make an accurate template for this pattern by connecting dome poles in the layout of this pattern. This method reduces accumulated errors that using a ruler would introduce. This method also eliminates the confusion of what size edges to use for dome sizes other than that used in the calculations in this page.

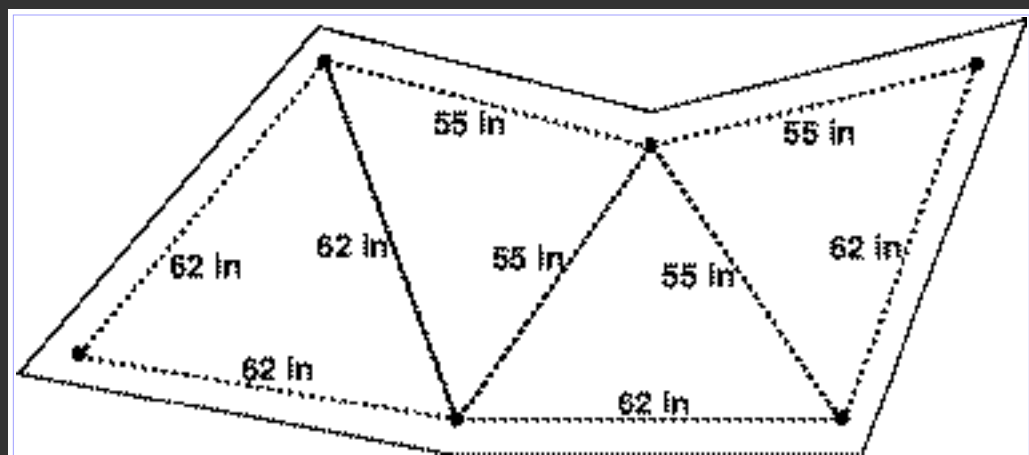

## Frequency 3 icosahedral symmetry triangle

This is a symmetry pattern used to cover one of the symmetry triangles of a frequency-3 geodesic.

Note that this pattern consists of nine of two basic triangles: three smaller (at the corners) and six larger (in the center).  
Freq-3 symmetry triangle  
 (Click image for larger version.)

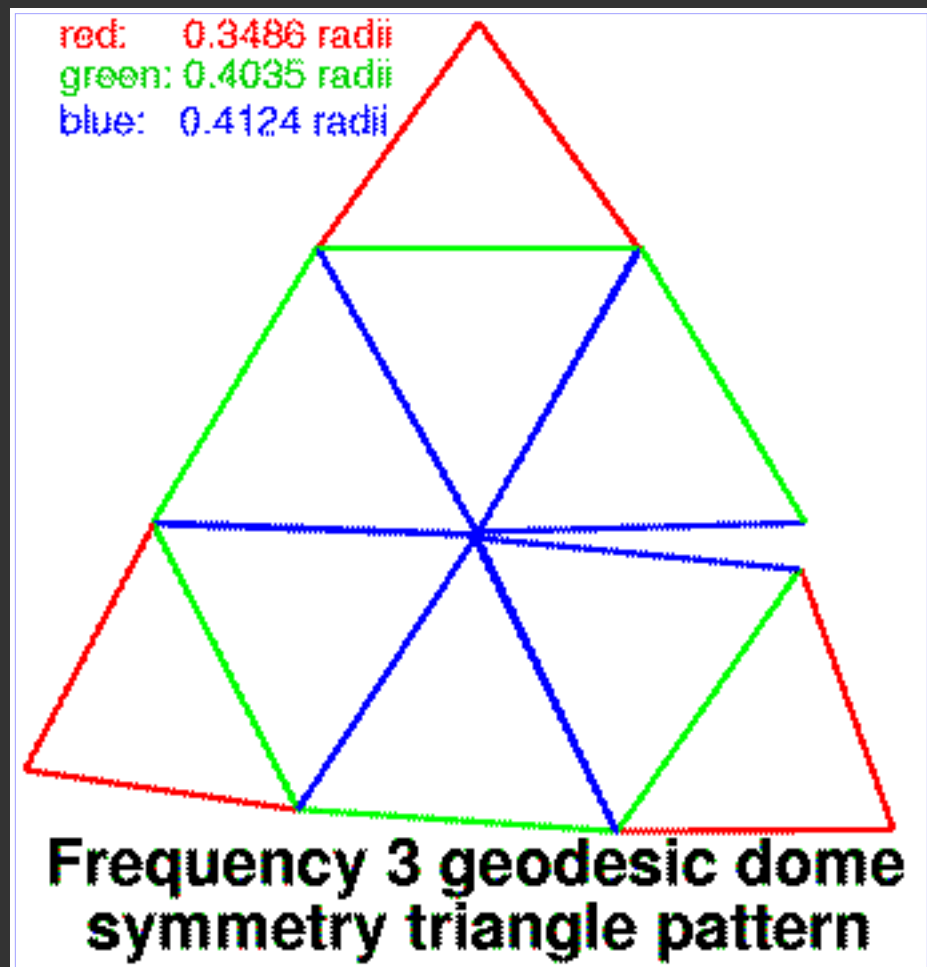

[Michael J. Gourlay](http://www.colorado-research.com/~gourlay/) / [gourlay at colorado-research dot com](mailto:gourlay@colorado-research.com)

# Outdoor Misting Systems

## Michael J. Gourlay

Outdoor misting systems cool down hot dry areas, such as shade structures at Burning Man. [Arizona Mist \(http://www.azmist.com/\)](http://www.azmist.com/) makes several "low pressure" mist systems, but you can also make your own.

I checked retail prices for these mist systems at a local hardware store. I found this information:

Arizona Mist systems and prices:

-----

System 2000: \$50

Kool Kit: \$50

Mini Mist: \$28

This store tends to be overpriced by anywhere from 20% to 100% over other nearby stores, but none of the other stores had the Arizona (or any other brand) mist system. (I've heard that Harbor Freight sells misting systems.) Also, these prices were checked in winter, when you would think they would be cheaper, but I think this particular store does not really have sales or seasonal pricing. I would guess that these same kits, if found in a place with reasonable pricing, would cost about 30% lower than this.

If you check out the specs on these systems, (have a look at the Arizona Mist web site, or check them out at a store) you will probably come to the conclusion that the System 2000 is the closest thing to what would be best for a large dome (800 square feet), and the Mini Mist or Mister Cool would be well suited for the small dome (200 square feet).

I decided not to buy these systems because they are too expensive and the more affordable one is a little inflexible. I instead built my own misting system out of stock parts from [RainDrip \(http://www.raindrip.com/\)](http://www.raindrip.com/) and DripMaster. RainDrip and DripMaster make similar items, and are mostly interchangeable.

These drip irrigation systems can be categorized by the diameter and type of tubing used. The smallest is 1/4", flexible, which supports the least amount of water flow, and can have about 15 misters on a single line. Another type is 1/2" flexible, which can have many more misters on a single line -- probably over 100. You can also increase the number of misters on a single line by increasing the pressure of the water feeding into the system, but for lo-tech Burning Man purposes, we will probably want to expect pretty low pressure (around 25 PSI). By comparison, the high pressure systems are around 1000 PSI and require special pumps, and a garden variety garden faucet probably put out from 20 to 70 PSI (just my guess).

The system I concocted uses

- spools of 1/4" flexible vinyl tubing (RainDrip), 50 feet, (\$4.46),
- a 3/4" hose thread swivel to 1/4" tubing adapter (RainDrip), (\$1.88),
- several 1/4" barbed "tee" fittings (RainDrip), (\$1.97 for 5), and
- several DripMaster mister heads with flow control knobs, (\$2.38 for 2).

With these parts, making the misting system was trivial: I sliced up the tubing to lengths appropriate for the placement of the misters I wanted, inserted tees between those lengths, and attached the misters at the remaining prong of each tee, using a very short piece of tubing (roughly 1" long) to connect the tee to the mister.

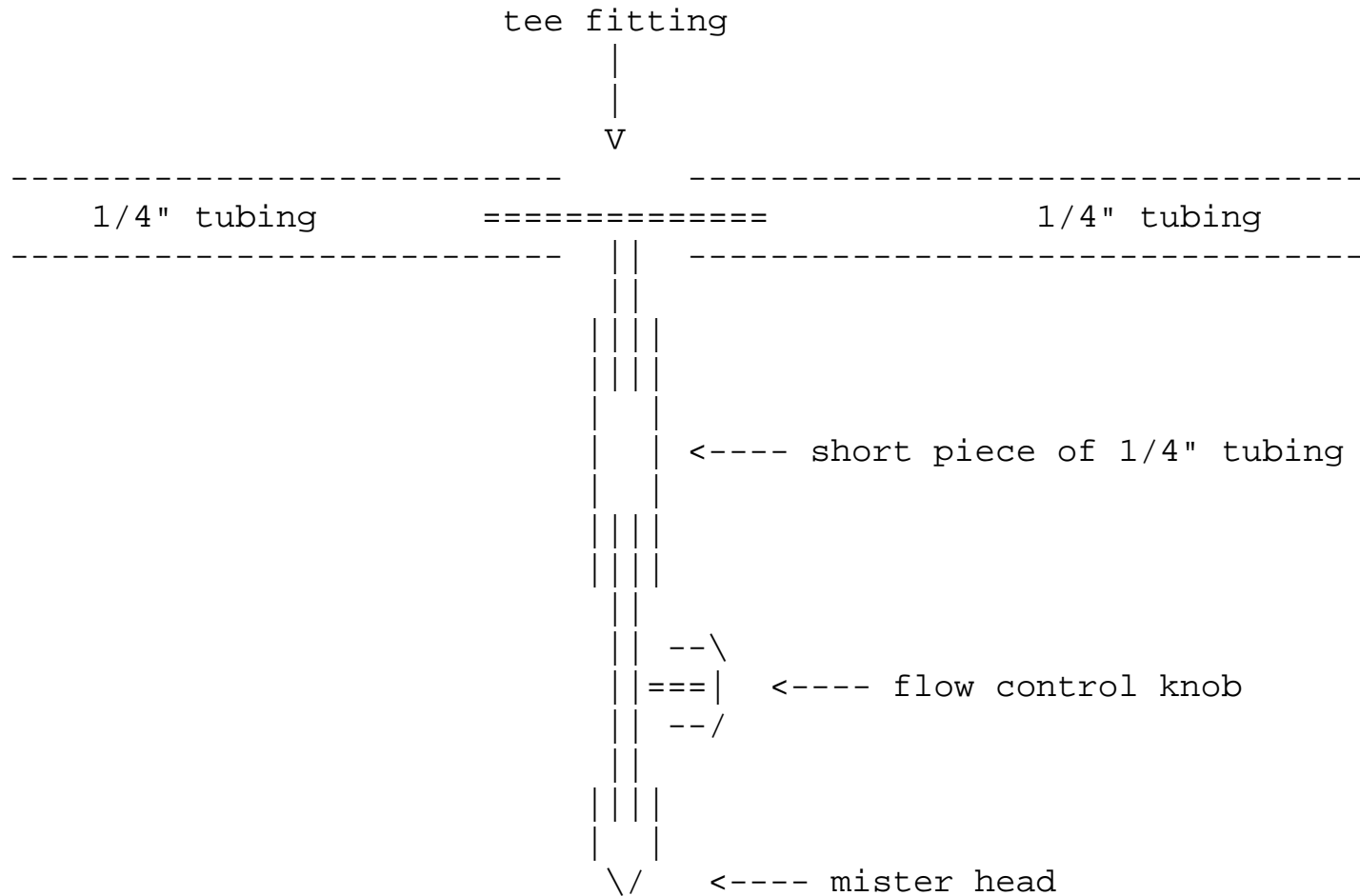

My 6-mister system cost around \$17. This system is comparable to the "Mini Mist" system by Arizona except that theirs does not give you the option of where to put the misters -- the tubing is pre-cut. On the other hand, the Arizona system is easier to deal with since it is mostly pre-assembled.

When I turned the system on inside the small dome, fine mist came from all directions. It got very wet and muddy in there. I turned off all but 1 mister (the one in the center), and found that it was sufficient, so the other 5 were redundant. There was so much water coming out of all of the misters that it was almost annoying. You could use the dome as a shower instead of a place to be cool. This is a feature, not a bug, since the misters I use have flow control valves, so it is fast and easy to convert from a nice cool mist to a soaking deluge.

A few notes:

- Little tiny clamps are available from DripMaster to make the barbed connectors less likely to come unplugged due to high pressure. This probably will not be necessary for Burning Man purposes but if you take your dome home and hook up the mist system to a sprinkler system then you might have high pressure in the tubing and your misters might pop out all over the place. The clamps are pretty cheap: 5 for \$2.16.

The clamps will also help keep your system assembled when you are tugging on the tubing to set it up or pack it away.

The barbs, once inside the tubing, are quite difficult to unplug, but I have been playing with this in very cold temperatures. When the temperature gets up to 115 F then the tubing is likely to be very soft, and the barbs might come out easily. I have no easy way to test this ahead of time so I am playing it safe and using plenty of high-pressure clamps.

- The flow control knobs on the misters seemed a bit more than I needed but there are no DripMaster misters without flow control knobs. There are "micro jets" from RainDrip which do not have flow control knobs, and they are much cheaper (10 for \$5.49) and less complicated, but they put out a thicker spray rather than a fine mist. Also, the RainDrip micro jets pop out more easily than do the DripMaster misters, so a high-pressure clamp would be required.
- The flow control valves unscrew easily and can therefore be lost easily. They are tiny and black. If one comes out then that mister will leak horribly (i.e. squirt a thin stream of water), the entire line will lose pressure and become useless. Clearly, this situation should be planned for since it is likely to happen and ruins the system. Redundant solutions are recommended:
  - Have extra misters on hand. They are cheap (2 for \$2.38 for DripMaster or 10 for \$5.49 for RainDrip).
  - Have plugs (stoppers) on hand. They are super cheap: 15 for \$1.68.
  - Have "barrel" connectors on hand to bypass tees with faulty misters. They are cheap (5 for \$1.78), and they have multiple uses, including making extensions with extra tubing.
  - Have some chewing gum or silicone to plug the hole where the flow control valve goes if you lose it.
- The flow control valves on the DripMaster misters are not perfectly reliable. In particular, in their "off" position, they do not fully stop the flow through the mister; the flow is simply reduced to a slow drip.

If all of the flow control valves on a line were closed, then the pressure in the line gets so high that water leaks in several places -- where ever there was a "seam" or connector. This was the case without high-pressure clamps in place.

- I believe the inner diameter of the so-called 1/4" tubing is 3/16" and the outer diameter is 1/4". This is important because both of those dimensions end up being crucial for the various fittings and barbs, so you would not, for example, be able to use tubing with 3/16" inner diameter and 3/8" outer diameter. ``Why would you want to do that?" you might ask. Well, the 1/4" vinyl tubing that RainDrip and DripMaster sells is opaque but I like seeing the water flow I used clear tubing. Ends up, clear tubing is thicker. I bought 3/16" i.d., 3/8" o.d. tubing which does fit the same RainDrip and DripMaster barbs but does not fit /inside/ the hose-to-tubing adapter so I ended up kludging something together at that adapter so that I could use my clear tubing. I do not recommend this kludge because it involves more parts, more connectors, and more money.
- Metal misters produce finer mist and consume less water, but cost more and glog more easily. If you use metal misters, use an inline water filter, such as are used in ice-makers.

The hose-to-tubing adapter leaked but was easy to repair. After a year of operation in temperatures ranging from desert hot to sub-freezing, the portion of 1/4" tube which slips inside the adapter hardened and failed to make a consistently proper seal. To repair the problem I removed the 1/4" tube from the adapter, cut off about 1 inch of the tube to remove the narrowed, hardened area, and

re-inserted the tubing. The process took under 1 minute. The resulting seal did not leak.

To supply the pressurized water, use a portable hand-pump sprayer. Solo sprayers have garden hose attachments on them, and they are available at Home Depot.

A wide variety of automatic, battery powered and self-powering water timers are available, in a wide price range.

---

[Michael J. Gourlay](#) /



# FleshLab camp layout

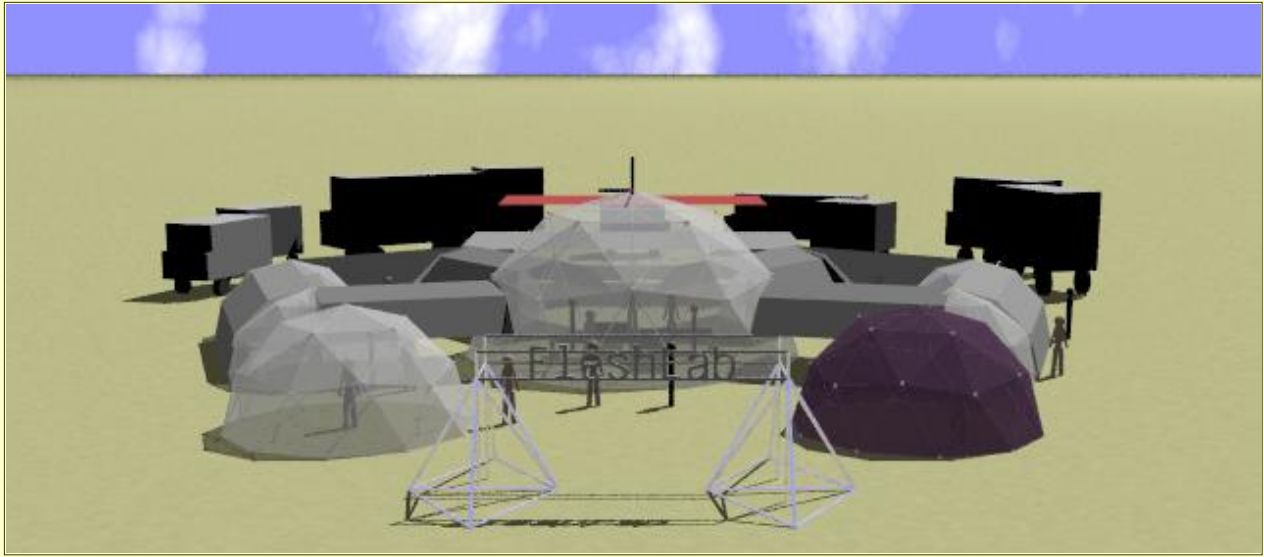

[domes](#) | 
 [FleshLab](#) | 
 [FleshLab miscellany](#) | 
 [VRML](#)

## Camp layout summary

The big dome is in the center, with smaller domes around 4/5 of the perimeter. The big dome has a diameter of 32 feet. Each small dome has a diameter of roughly 16 feet. The small domes are connected to the big dome by "hypar" structures. Some small domes are connected to each other also. The violet dome in front represents a suggested location for the "black light camp" public structure (which is not a dome but I have a limited number of models to represent structures). Their private structure should probably be nearby their public structure.

The big-to-small dome shades are made from tarps or other fabric, about 12 feet by 16 feet, held in place by ropes. The tarps connecting small domes are 12 feet by 20 feet. (In other words, the center of the small domes attached to the big dome are about 16 feet from the edge of the big dome, and the centers of adjacent small domes are about 20 feet apart.)

To support the tarps, ropes are stretched from the top of the lower tiers of each small dome to the top of the low triangles in the lower tier of the big dome. These ropes make up the "guide rails" to which smaller ropes connect from the tarp perimeters. The guide-rails should be tied with taught-line hitches to make the ropes tight enough to strum. Guide-rail ropes should be 5/16" (8mm) or larger braided nylon. The smaller ropes to attach the tarps to the guide rails can be 1/4" (6mm) diameter.

One side of the big dome is left without a small dome in front of it. This is the "main entrance", and will have a banner over it with a FleshLab logo. A gate will also be at the front of the camp.

The larger gray rectangle represents Scott Hansen's misted shade structure. The smaller brown rectangle represents the hammock structure. Their orientation could be rotated by 90 degrees and still occupy roughly the same space, so the final layout has some flexibility.

The vehicles will be placed around the outside perimeter at the rear of the camp. Tents can be placed in the interstices of the vehicles so that the tents will be sheltered from wind, sun, and visitors of FleshLab.

Harbor Freight tends to have sales on tarps. They actually have a lot more tarps than they advertise on the web so if you do not see what you are looking for, send me email telling me what size tarp you want, and what material (silver nylon; blue, green or brown polyethylene; or canvas) and I'll tell you what they have which is closest.

In these images, the main entrance is facing north, and the sun is toward the southwest, i.e. in the early afternoon, the hottest part of the day.



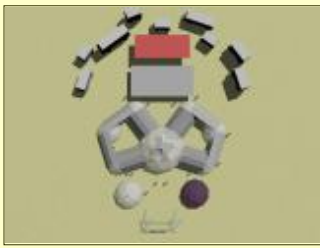

aerial view



close front view

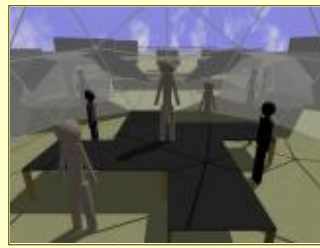

stage view

---

## Surveying the site

Have a tape measure that will go up to 50 feet. Also bring a protractor.

Decide which direction is the front. If the primary consideration is to maximize shade, this should be due north. The primary consideration will probably end up being something else, though. Advocated orientations include toward the man and toward the open playa.

Decide where the center of the big dome is. This should be somewhat forward (i.e. in the direction of the entrance) from the center of camp to allocate space for the small domes, vehicles and tents at the rear of camp.

Mark that spot. This is the center of the big dome.

Measure and mark 32 feet from the big dome center at angles 72, 144, -72, and -144 degrees from the front direction. These are the locations of the centers of the 4 small domes which will attach to the big dome. These should be public domes since they will be attached to the big dome, which is a public space. If people at those locations do not want their domes to be public then they can rotate the entrance to face the rear, and perhaps make a sign that says "private" or something. I would hope, though, that we had at least 4 public small domes.

Measure and mark 40 feet from the big dome center at angles 108, -108 and 180 degrees from the front direction. These are the locations of the centers of the small domes which will not attach to the big dome. These should be private domes (if there will be any private metal domes) since they will not be attached to the big dome. Since Marc's dome and the Seattle dome do not have entrances and are therefore more difficult to enter, I suggest that they be private domes.

The blacklight people should probably have their private dome be adjacent to their public space so please try to be courteous and leave them one of the small dome spaces near the front for that, if they want it.

Somewhere, probably behind the small domes at the rear, there will be Scott's 20'x40' shade structure with a misting system, and the hammock structure.

Cars should be around 60 to 70 feet (alternating) behind the back perimeter of the small domes, which should be around 50 to 60 feet back from the small dome centers.

The orientations of the small and big domes matter. The small domes attaching to the big dome should have their entrances facing the big dome. The domes at +/-108 and 180 should face the rear. The idea here is to make those domes "private" or at least less accessible to the public. The big dome orientation should have one of its tall lower triangles facing the front since this will be the entrance. That orientation will also be such that the other four tall lower triangles face the small domes which will attach to the big dome.

---

## Logistics: Setting up camp

Setting up the camp is more than likely going to happen piecemeal since various people will arrive at various times. At first, the camp site will be a disorganized mess of vehicles and partially unpacked gear. Some people will set up their shade structures, probably not in the place where they eventually need to be. Cars will probably initially be right in the middle of where shade structures need eventually to be. The final state of everything, however, should approach something far more intentional and aesthetically pleasing: something like what the images above depict.

The big dome, after the top tier is assembled, is effectively immobile. Furthermore, the orientation of the big dome will determine where the front and back of the camp are. That means that the big dome, in a logistics sense, has higher priority than the other structures. Please be accomodating and be prepared to move stuff out of the way of the big dome while it is being set up. Also be cognizant that other shade structures and vehicles will eventually be located in regards to the location and orientation of the big dome.

There are complications in setting up the big dome. Those issues involve attaching things to the top two tiers of the dome. Those things need to be done while the top tier is still reachable, i.e. before the third tier is assembled.

The small metal domes, tents, and cars can all be moved easily. That means that it is okay for people to assemble their shade structures without them having to be in the right place. As long as people realize that when they are setting up, then there will be no stress when it comes time to scoot big metal things 100 feet across the playa. It might seem that domes would want to be built near or at where they will eventually end up but it is likely that at least some of them will move quite a bit before being staked down.

Vehicles will be at the rear of camp and should be arranged such that they constitute a nearly continuous yet staggered barrier. This means that they should be bumper-to-bumper but as though adjacent cars are in separate lanes. The purpose is to minimize usage of space, to shelter tents from wind, and to separate tents from each other to provide some element of privacy and walking space. (This is in contrast to the innavigable distribution of tents last year.) I suspect that the vehicles will be in their final places only after the shade structures have been mostly set up and arranged. You might find yourself moving your vehicle multiple times. Please be prepared to do that on demand, as people need access to certain spaces. Be considerate and do not leave your vehicle without its keys or driver handy.

The layout design in the images is a loose plan. The main elements of the plan are that the big dome is the center of the camp; that other shade structures are nearby and attached to the big dome and to each other with shade-providing material; that there is a well defined, accessible, unblocked, uncluttered and easily visible main entrance; and that vehicles are in back, out of the way, and preferably providing shelter for tents or other private shade structures.

If you are bringing a small metal dome to be part of our camp then you should also bring materials for attaching to the big dome and/or to an adjacent small dome. This should include a (non-blue) heavy-duty (nylon or canvas, not polyethylene!) tarp or other opaque material covering and lots of (100 feet or more) very strong rope. Also bring several rebar hairpin-shaped (not J-shaped) stakes.

Dome-to-dome attachments must be held in place with something that can tolerate wind storms. I have in mind something which is easy to set up but if other people have better ideas then run with them.

We all know that covered domes have the vulnerability of catching wind if they have their covers on them and are not staked. It would therefore be prudent not to set up covers on the domes until they are at their final places and staked down. If you choose to set up your dome before it is in its final place, please avoid setting up its cover, because it will be dangerous until it is staked.

If anybody has special requests or needs, or in general if anybody who plans to be part of FleshLab has problems with this layout then it is important to bring them up well in advance of arriving on the site. Logistic planning is too difficult without a good line of communication and we will not have a good line of communication at the site.

## Space allocation versus gear

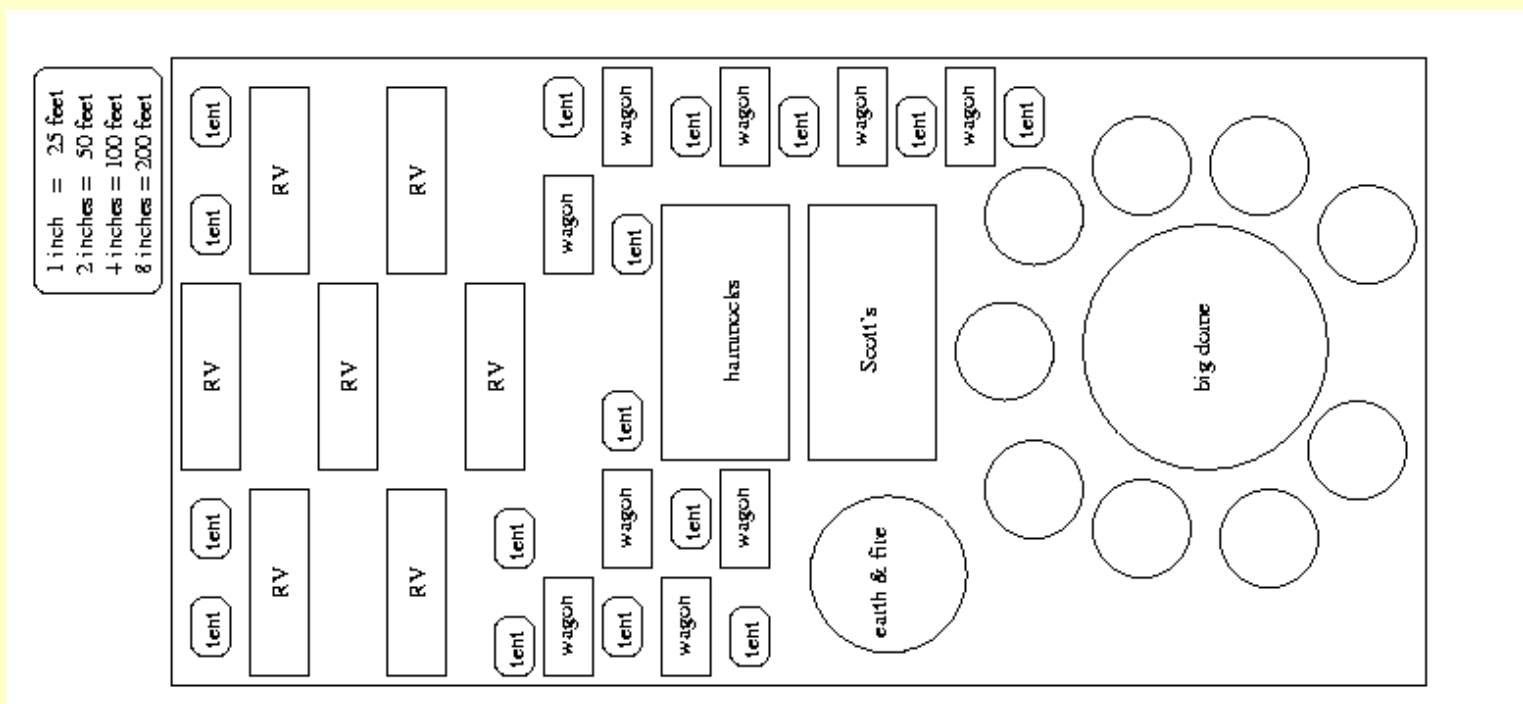

This is a *rough* indication of how much stuff and how much space we have. The actual layout of items is not significant in this image; that can be dealt with later. The main point to take from this image is that we pretty much do not have enough space

for our stuff. We therefore need to requisition more space when people first arrive on the playa.

In this image, "wagon" is a generic car. Some of the shade structures are not depicted as they really look. Do not take this too seriously; it's just a rough sketch. Use your imagination to fill in the missing elements.

The point, to restate, is to get an idea of /much/ stuff we have compared to how much /space/ we have. This image is /not/ a layout diagram. It is more like a Venn diagram than a map.

---

[Michael J. Gourlay / gourlay at colorado-research dot com](mailto:gourlay@colorado-research.com)

# Geodesic dome bibliography

Dome Builder's Handbook, No. 2, With a Directory of Manufacturers, by Andrew Ralph and William Yarnall.

AUTHOR           Aguilar, Rodolfo J.  
 TITLE           Automatic generation of the geometry of geodesic domes, by  
                   Rodolfo J. Aguilar.  
 PUBLISHER       Baton Rouge, Louisiana State University and Agricultural and  
                   Mechanical College, 1966.  
 DESCRIPT.       vii, 46 p. illus. 28 cm.  
 SUBJECT         Geodesic domes.  
 SERIES          Louisiana State University and Agricultural and Mechanical  
                   College. Engineering research bulletin no. 90.  
                   Bulletin (Louisiana State University (Baton Rouge, La.)). Division  
                   of Engineering Research) ; no. 90.  
 NOTE           Based on the author's thesis, North Carolina State University.  
 BIBLIOG.       Bibliographical footnotes.  
 OCLC #          953964.  
 CALL #          620.6 L93b no. 90.

AUTHOR           Mottel, Syeus.  
 TITLE           Charas, the improbable dome builders.  
 PUBLISHER       New York, Drake Publishers [1973]  
 DESCRIPT.       191 p. illus. 26 cm.  
 SUBJECT         Community centers -- New York (State) -- New York.  
                   Gangs -- New York (State) -- New York.  
                   Geodesic domes.  
 NOTE           @ Norlin [c.1]  
 CALL #          HN45.N4 M67.

TITLE           The Dome builder's handbook / edited by John Prenis.  
 PUBLISHER       Philadelphia, Pa. : Running Press, c1973.  
 DESCRIPT.       107 p. : ill. ; 27 cm.  
 SUBJECT         Domes -- Design and construction.  
                   Geodesic domes.  
 BIBLIOG.       Bibliography: p. 97-101.  
 NOTE           @ Arch [c.1]-2.

Engine c.3.  
 OTHER NAME Prenis, John.  
 ISBN 0914294350 (lib. bdg.) :  
 0914294032 (pbk.)  
 OCLC # 8111831.  
 CALL # TH2170 .P745.

AUTHOR Baer, Steve, 1938-  
 TITLE Dome cookbook / by Steve Baer.  
 PUBLISHER Corrales, N.M. : Lama Foundation, [1968]  
 DESCRIPT. 40 p. : ill. ; 36 cm.  
 SUBJECT Domes.  
 Polyhedra -- Models.  
 Geometrical models.  
 Convex surfaces.  
 Architectural models.  
 Structural frames.  
 Geodesic domes.  
 Architecture -- Composition, proportion, etc.

NOTE Cover title.  
 Original imprint covered by label, as above.

BIBLIOG. Includes bibliography.  
 NOTE @ Arch [c.1]-2.  
 CALL # NA2890 .B29.

TITLE Domebook one[-two, by Lloyd Kahn and others.  
 PUBLISHER Los Gatos, Calif., Pacific Domes, 1970-71]  
 DESCRIPT. 2 v. illus., plans. 37 cm.  
 SUBJECT Geodesic domes.  
 NOTE Cover title.  
 Vol. 2 published at Bolinas, Calif., and distributed by Random House, New York.

BIBLIOG. Bibliography: v. 1, p. 54; v. 2, p. 122.  
 NOTE @ Arch v.2 [c.1]-2.

OTHER NAME Kahn, Lloyd.  
 Pacific Domes (Organization)

OCLC # 159422.  
 CALL # TH2170 .D64.

AUTHOR Robbin, Tony.  
 TITLE Engineering a new architecture / Tony Robbins ; foreword by Stuart Wrede.  
 PUBLISHER New Haven : Yale University Press, c1996.  
 DESCRIPT. x, 138 p. : ill. (some col.) ; 28 cm.  
 SUBJECT Structural design.

Geodesic domes.  
 Shells (Engineering)  
 BIBLIOG. Includes bibliographical references (p. 127-133) and index.  
 ISBN 0300061161 (alk. paper)  
 OCLC # 33101960.  
 CALL # TA658.2 .R63 1996.

AUTHOR Kenner, Hugh.  
 TITLE Geodesic math and how to use it / by Hugh Kenner.  
 PUBLISHER Berkeley : University of California Press, c1976.  
 DESCRIPT. xi, 172 p. : ill. ; 23 cm.  
 SUBJECT Geodesic domes.  
 Geodesic domes -- Mathematical models.  
 NOTE mArch [c.1]-2.  
 ISBN 0520029240 :  
 OCLC # 2561084.  
 CALL # TA660.D6 K46.

AUTHOR Pugh, Anthony.  
 TITLE An introduction to tensegrity / by Anthony Pugh.  
 PUBLISHER Berkeley : University of California Press, c1976.  
 DESCRIPT. x, 121, [1] p. : ill. ; 23 cm.  
 SUBJECT Geodesic domes.  
 Polyhedra.  
 SERIES The Dome series.  
 Dome series.  
 BIBLIOG. Bibliography: p. [122]  
 NOTE @ Arch [c.1]  
 ISBN 0520029968. 0520030559.  
 OCLC # 2536970.  
 CALL # TA660.D6 P83 1976.

AUTHOR Pugh, Anthony.  
 TITLE Polyhedra : a visual approach / by Anthony Pugh.  
 PUBLISHER Berkeley : University of California Press, c1976.  
 DESCRIPT. x, 118 p. : ill. ; 23 cm.  
 SUBJECT Polyhedra.  
 Geodesic domes.  
 SERIES The Dome series.  
 Dome series.  
 BIBLIOG. Bibliography: p. 117-118.  
 ISBN 0520029267. 0520030567.  
 OCLC # 2463607.  
 CALL # QA491 .P83.

--

AUTHOR Duke, Edward M.  
 TITLE A study of the geodesic dome applied to housing : introduction  
 and annotated bibliography.  
 PUBLISHER Monticello, Ill. : Council of Planning Librarians, 1973.  
 DESCRIPT. 37 p. ; 28 cm.  
 SUBJECT Geodesic domes -- Bibliography.  
 Housing -- Bibliography.  
 SERIES Council of Planning Librarians exchange bibliography ; 379.  
 OTHER NAME Ritchie, L. David.  
 Wilkins, Michael H.  
 OCLC # 612142.  
 CALL # Z5942 .C6 no. 379.

--

AUTHOR Kenner, Hugh.  
 TITLE Geodesic math and how to use it / by Hugh Kenner.  
 PUBLISHER Berkeley : University of California Press, c1976.  
 DESCRIPT. xi, 172 p. : ill. ; 23 cm.  
 SUBJECT Geodesic domes.  
 Geodesic domes -- Mathematical models.  
 NOTE mArch [c.1]-2.  
 ISBN 0520029240 :  
 OCLC # 2561084.  
 CALL # TA660.D6 K46.

TITLE Dome.  
 PUBLISHER [Wheat Ridge, Colo. : Hoflin Pub., c1988-  
 DESCRIPT. v. : ill. ; 28 cm.  
 FREQUENCY Quarterly.  
 PUB HISTORY [Vol. 1, no. 1] (fall 1988)-  
 SUBJECT Geodesic domes -- Periodicals.  
 NOTE Title from cover.  
 UNIF TITLE Dome (Wheat Ridge, Colo.)  
 ABBREV TITL Dome (Wheat Ridge Colo.)  
 UNIQUE TITL Dome (Wheat Ridge, Colo.)  
 ISSN 1041-1607.  
 OCLC # 18666049.  
 CALL # TH2170 .D635.

TITLE Dome houses and energy conservation : an introductory  
bibliography / [compiled by the] staff of the Bibliographic  
Research Library.

PUBLISHER Monticello, Ill. : Vance Bibliographies, [1983]

DESCRIPT. 4 p. ; 28 cm.

SUBJECT Geodesic domes -- United States -- Bibliography.  
Architecture, Domestic -- United States -- Bibliography.  
Architecture and energy conservation -- United States --  
Bibliography.

SERIES Architecture series--bibliography, 0194-1356 ; A-1114.  
Architecture series--bibliography ; A-1114.

NOTE Cover title.  
"December 1983."

OTHER NAME Bibliographic Research Library (San Jose, Calif.)

CALL # Z5941 .A72 A-1114.

---

Geodesic Domes  
Borin Van Loon  
1994  
Tarquin Publications  
Stradbroke / Diss / Norfolk, England  
Five Castles Press / Ipswich

Bucky Works: Buckminster Fuller's Ideas for Today  
J. Baldwin  
John Wiley & Sons, New York  
1996

Synergetics  
R. Buckminster Fuller  
Collier Books  
MacMillan Publishing Company, New York  
1975

---



Inventions: The Patented Works of R. Buckminster Fuller  
St. Martin's Press  
1983

---

Dome Story  
Lucas Grillis Adams  
Armadillo Books  
1998

The Dome People  
Ruth Rea

Dome Scrap Book  
George P. Swanson

Dome Scrap Book  
Geodesic Services Staff

Domes and Homes  
Geodesic Services Staff

Geodesic Floor Plans  
prepared by Cathedralite

How to Design and Build Your Dome Home  
Gene Hopster

Passive Solar Dome Greenhouse Book

John Fontanetta

Timber geodesic domes

John Rich

---

[Michael J. Gourlay](#) / gourlay at co-ra dot com

# The Math of Hexayurts

## Triangles

### Angles

An angle is the space between two intersecting lines, i.e. two lines that diverge from a common point.

### Bisecting Angles

An angle is **bisected** when a third line passes in the middle between the two other lines that form an angle. A two bisecting angles are half the size of the original angle.

### Triangles

Triangles are three-sides shapes. (Shapes that are made of lines and that lie flat are called polygons. Triangles are therefore three-sided polygons.) Triangles also have three interior angles. The sum of the three interior angles of a triangle is always  $180^\circ$ .

Triangles are structurally stable because you can not change any of the angles without changing the lengths of the sides. This implies that as long as the sides of a triangle do not bend, extend or compress, the triangle will not fold up.

### Right triangles

Right triangles have a **right angle** as one of their interior angles. A **right angle** is an angle of  $90^\circ$ . The two sides of a right angle are said to be **perpendicular**. [Trigonometry](#) is based upon right triangles.

### Pythagorean theorem

As described in the [Trigonometry Tutorial](#), the Pythagorean theorem states that the sum of the squares of the lengths of the two legs of a right triangle equals the square of the length of the hypotenuse.

### Equilateral triangles

Equilateral triangles have all three angles equal (and that angle is  $60^\circ$ ), and all three sides have equal lengths.

Any polygon that has all sides with equal length is called a **regular polygon**. Equilateral triangles are therefore also called **regular** triangles because all three sides have the same length.

## 30-60-90 triangles

30-60-90 triangles have one angle with  $30^\circ$ , one angle with  $60^\circ$  and one angle with  $90^\circ$ . Since one of the angles is  $90^\circ$ , i.e. is a right angle, a 30-60-90 triangle is a right triangle. Also, one of the angles is  $60^\circ$ , which is the same as an equilateral triangle. The remaining angle of a 30-60-90 triangle is  $30^\circ$ , which is half of  $60^\circ$ , i.e. a  $30^\circ$  angle is the result of **bisecting** a  $60^\circ$  angle.

When one of the angles of an equilateral triangle is bisected, that bisecting line passes through the third side of that equilateral triangle at a right angle, and the result is 2 half-size triangles. Both of those half-size triangles are 30-60-90 triangles.

### Lengths of each side

The long side of a 30-60-90 triangle is the hypotenuse of that triangle, and it is one of the sides of the original equilateral triangle. Let us say that the hypotenuse of this triangle has a length of 1. The short side of a 30-60-90 triangle has a length of  $1/2$  because we divided the original side in half, and the side originally had a length of 1 (because all three sides of an equilateral triangle have the same size). The remaining side of a 30-60-90 triangle has a size of  $\sqrt{3}/2$ . We know this from the Pythagorean theorem. If we call the length of the remaining side  $x$ , then we can write this equation:

$$\text{hyp}^2 = \text{leg}^2 + x^2$$

and since we declared that  $\text{hyp}=1$ , and we know  $\text{leg}=\text{hyp}/2$ ,

$$1^2 = (1/2)^2 + x^2$$

i.e.

$$1 = 1/4 + x^2$$

Solve this equation for  $x$ :

$$x^2 = 1 - 1/4 = 3/4$$

$x = \sqrt{3/4} = \sqrt{3}/2$  is the length of the long leg in a 30-60-90 triangle.

## Hexagons

Hexagons are six-sided polygons. A **regular** hexagon has all six sides of equal length. The interior angle between each side of a regular hexagon has a value of  $120^\circ$ .

If you draw a line from the center of a hexagon to each vertex, each of those lines bisects the interior angles of the hexagon. (This process divides the hexagon into 6 triangles.) Those bisecting angles therefore have a value of  $60^\circ$ . Since two of each of those triangles have values of  $60^\circ$ , and since the sum of interior angles of any triangle is always  $180^\circ$ , we now know that the remaining angle also has a value of  $60^\circ$ . This implies, of course, that all 6 of the new triangles are equilateral.

## Circumscribing circle

Imagine a circle drawn around the perimeter of a regular hexagon. The 6 lines we drew out to the vertices of the hexagon all have the same length as each of the sides of the hexagon (because the triangles are equilateral). This implies that the radius of the circumscribing circle of a hexagon is equal to the length of the sides of that hexagon.

This coincidental property is very useful when drawing regular hexagons: First start by drawing a circle. Then take your compass and put the point anywhere on the circle perimeter. Now mark where the compass intersects the circle. (This will happen in two places.) Move the compass to each of those intersections and repeat finding where the compass intersects the circle. If you make no mistakes, the compass will intersect the circle in 6 places, and those places are the vertices of a regular hexagon.

## Inscribing circle

Now, instead of drawing a circle that intersects the vertices of a regular hexagon, imagine a circle that has its circumference tangential to the sides of the hexagon. The circle barely touches the hexagon at 6 places. Call those places the tangential points.

Notice that lines that radiate from the center of the circle to the tangential points bisect the angles of the equilateral triangles. That means that each of these new lines divides each equilateral triangle into 2 30-60-90 triangles.

The long legs of the 30-60-90 triangles are equal to the radius of the inscribing circle. We already know that the long legs of a 30-60-90 triangle have a length of  $\sqrt{3}/2$  and that is the radius of the inscribing circle.

## Tiling a Euclidean plane

Hexagons have the property that they **tile** a flat plane (i.e. a Euclidean plane). **Tiling** means that a shape can cover an area without leaving any gaps. Only special shapes can tile a plane. Squares and regular hexagons can tile a plane, but regular pentagons can not.

## Hexayurts

A Hexayurt is a polyhedron that has a regular hexagonal base, and 19 faces. You can think of a hexagon as having a "roof" region that has 6 faces, a "side" region that has 12 faces, and a bottom face.

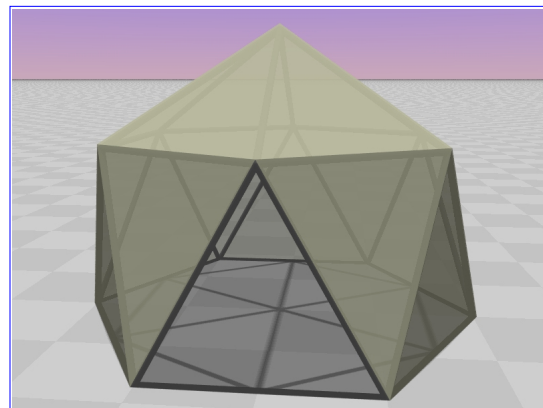

## Hexagon floor plan

The bottom of a hexayurt is a regular hexagon. This implies that the floor of a hexayurt can **tile** a plane, i.e. hexayurt floors can cover a plane without leaving gaps.

## Sides: Inscribing hexagon above the floor

Above the floor are twelve triangles that touch the six vertices of another horizontal hexagon. The vertices of that upper hexagon reside directly above the edges of the floor of a hexayurt. One implication of this is that the shadow of the vertices of the upper hexagon would hit the edges of the floor, if the light source were straight and far above the top center of the hexayurt.

The reason we want those upper hexagon vertices directly above the floor edges is that this makes those walls perfectly vertical, which means that if we place two hexayurts side-by-side, then the vertex above the touching sides would coincide. If the vertex was farther out or in than the floor then two side-by-side hexayurts would not be able to touch flush with each other.

We already know that the radius of a circle that inscribes a regular hexagon. This tells us two things:

1. The lengths of the edges around the perimeter of the upper hexagon and
2. the horizontal locations of the vertices of the upper hexagon.

We still do not know the length of the edges connecting the vertices of the floor hexagon to the vertices of the upper hexagon. We must first know the height of the upper hexagon, then combine this information with the Pythagorean theorem to calculate their length. In point of fact, we can set the height arbitrarily. The only constraint this implies is that the floor-to-upper-hexagon edges must be longer than half the length of the floor poles. To decide how long to make those edges, we need a criterion for selecting a length.

## Roof

The roof of a hexayurt is formed by connecting edges from the vertices of the upper hexagon to a point above the center of the floor. The lengths of those edges does not matter, as long as they are long enough to reach the center of the upper hexagon. This implies that those edges must be longer than the edges of the upper hexagon.

## Optimizing use of materials

Imagine that we plan to build a hexayurt out of poles, and that we can get poles only in certain lengths. For example, ten-foot poles are common. We want to cut the poles in such a way to minimize or eliminate any waste (i.e., any unused portions of poles).

This is what we know so far about the poles of a hexayurt:

- The six floor poles all have the same length as each other.
- The six poles around the perimeter of the upper hexagon all have the same length as each other, and that length is  $\sqrt{3}/2$  times the length of the poles around the perimeter of the

floor.

- The six poles from the upper hexagon vertices to the top-center must be longer than the upper hexagon poles, but by how much is not important for the geometry of this structure.
- There are 12 poles left, and they determine the height from the floor to the bottom of the roof. Those poles must all have the same size.

Some pole lengths are still undetermined. We have freedom to choose their lengths within the constraints stated so far.

- One choice of pole lengths: narrower base.

Notice that there are as many poles in the upper hexagon as there are poles connecting to the top center vertex. Also notice that the roof poles must be *longer* than the floor poles, and that the upper hexagon poles must be *shorter* than the floor poles. This implies that the length of the floor poles are somewhere in the middle.

Start with three ten-foot (i.e. 120 inch) poles and divide them exactly in half to make six five-foot (i.e. 60 inch) poles. We will use them as the floor perimeter poles. This dictates the lengths of the upper hexagon poles:  $5 \cdot \sqrt{3}/2 = 4.33$  feet, or 51.96 inches. Call it 52 inches. If we cut 52 inches from each 120-inch pole, that leaves 69 inches. Since 69 is larger than 60, We can use those for the roof, and waste no pole material.

This leaves twelve poles to connect the floor to the upper hexagon. To waste no pole material, they should be 120-inches divided by some integer, as long as the result exceeds 30 inches (i.e. exceeds half of the floor pole length). This leaves choices of 120, 60 and 40 inches. Anything shorter than 60 inches makes for a structure that is too short for most people, so the only reasonable choices are 60 inches or 120 inches. A structure that uses 120-inch tall poles for the floor-to-upper would be much taller than its width, which makes the structure top-heavy. That is bad if the structure is alone, but since one of the main reasons to prefer this design instead of another is that this design tiles, and if you tile a taller structure with a few others, the overall structure ceases to be top-heavy.

If we choose 60-inch poles to connect the floor to the roof, then the half of the sides are made of equilateral triangles, and the other half are made of isosceles triangles. This lets us use the special geometrical properties of an equilateral triangle to compute the height of the roof, but otherwise has no special significance.

- Another choice of pole lengths: wider base.

Instead of using the roof an upper hexagon as complementary lengths, we could instead choose to make the floor and upper hexagon lengths complementary. This requires solving a simple algebraic equation. Recall that the upper hexagon edges have a length of  $\sqrt{3}/2$  times the floor hexagon edges. We want their combined length to equal the length of an uncut pole. Calling the length of the floor poles  $h$ ,

$$h + h \cdot \sqrt{3}/2 = 120 \text{ inches}$$

$$h \cdot (1 + \sqrt{3}/2) = 120 \text{ inches}$$

So we get

$h = 120 / (1 + \sqrt{3}/2) = 64.3078$  inches for the length of the floor poles.

$120 - h = 55.6922$  inches for the length of the upper hexagon poles.

As in the previous derivation, we still have choices of 40, 60 or 120 inch length for the twelve floor-to-upper poles.

This design also leaves freedom to choose the lengths of the roof poles. A similar constraint applies: 120 divided by some integer, such that the result exceeds 55.6922 inches. This implies 60- or 120-inch long roof poles.

60-inch roof poles make for a more flat roof compared to the previous design. This could cause problems for snow accumulation, and also makes the structure less strong when hanging weight from the top vertex.

120 inch long roof poles would make for a rather pointy roof, which could look interesting. Again, top-heaviness is an issue when using 120-inch poles for the roof or the floor-to-upper poles, so choosing that longer length again implies requiring tiling more than one of these structures to keep them from tipping over.

The designs above yield six reasonable configurations of domes: The first has the choice of 60- or 120-inch floor-to-upper poles. The second has that same choice, plus a choice of 60- or 120-inch roof poles for a combined choice of 4 shapes.

Both of the designs above yield relatively close sizes of hexayurts, with a floor area of roughly 75 square feet. Assuming the use of 60-inch floor-to-upper poles, both have short "doorways" -- roughly 4 feet tall. Both have roofs tall enough to stand under at the center, but not near the walls.

## Height statistics

The average height of American males is 69 inches, with a standard deviation of 2.7 inches. For females, 64 +/- 2.5 inches.

## Acknowledgements

Vinay Gupta introduced me to the design of hexayurts. He has a tendency to introduce me to new ideas about how to design and construct rapidly deployable shelters. Visit my [dome](#) web pages for more information about such things and for another reference to Vinay.

---

Written and copyright (C) 2002 by [Michael J. Gourlay](#) / gourlay at co-ra dot com



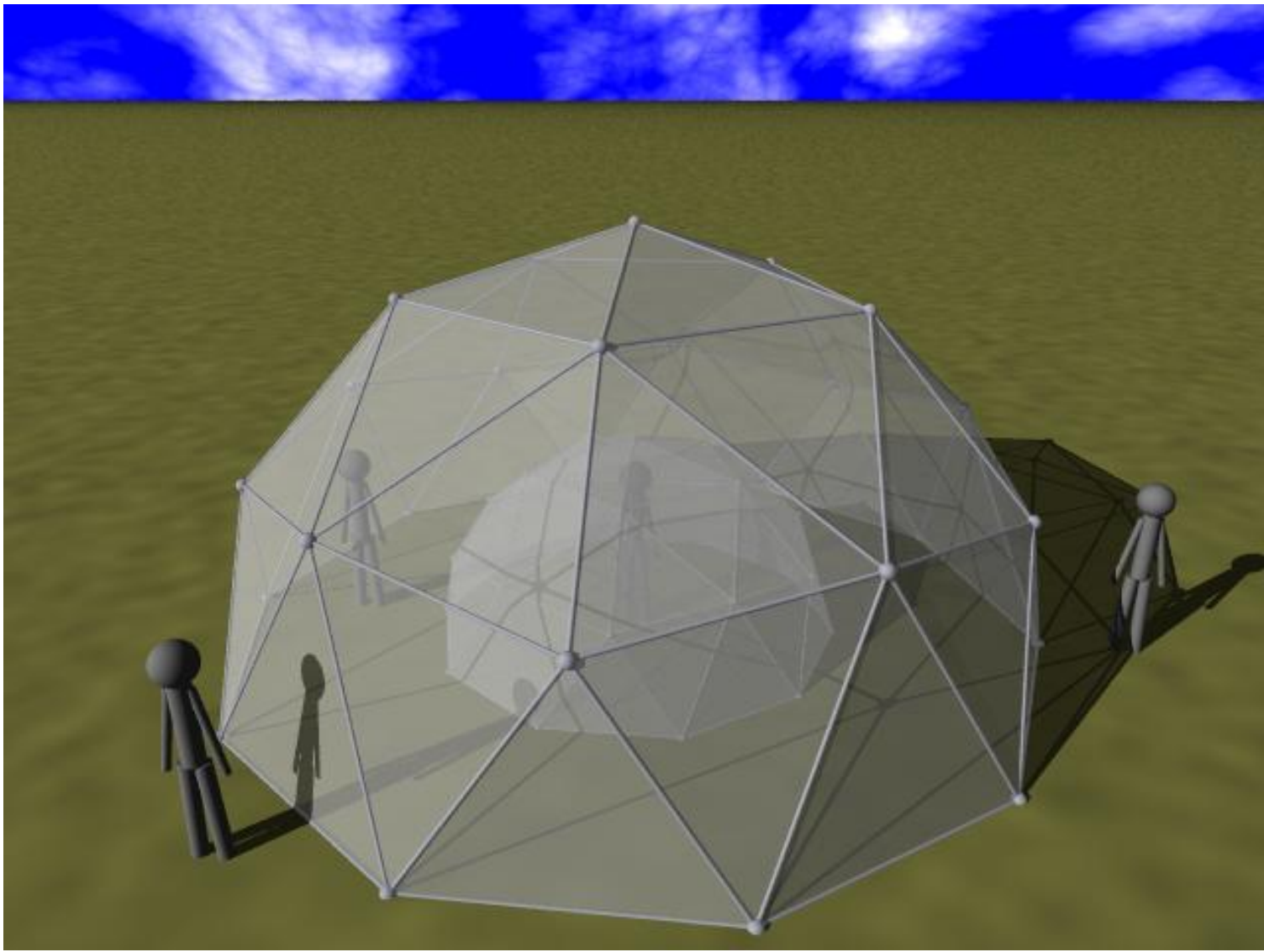

z is up.

Units are relative to the dome radius.

```
vertex 1 at ( 0          0          1          )
vertex 2 at ( 0.525731  0          0.850651  )
vertex 3 at ( 0.16246   0.5       0.850651  )
vertex 4 at ( -0.425325 0.309017 0.850651  )
vertex 5 at ( -0.425325 -0.309017 0.850651  )
vertex 6 at ( 0.16246   -0.5      0.850651  )
vertex 7 at ( 0.688191  0.5       0.525731  )
vertex 8 at ( -0.262866 0.809017 0.525731  )
vertex 9 at ( -0.850651  0          0.525731  )
vertex 10 at ( -0.262866 -0.809017 0.525731  )
vertex 11 at ( 0.688191 -0.5       0.525731  )
vertex 12 at ( 0.894427  0          0.447214  )
vertex 13 at ( 0.276393  0.850651  0.447214  )
vertex 14 at ( -0.723607 0.525731  0.447214  )
vertex 15 at ( -0.723607 -0.525731 0.447214  )
vertex 16 at ( 0.276393  -0.850651  0.447214  )
vertex 17 at ( 0.951057  0.309017  0          )
vertex 18 at ( 0.587785  0.809017  0          )
vertex 19 at ( 0          1          0          )
vertex 20 at ( -0.587785 0.809017  0          )
vertex 21 at ( -0.951057 0.309017  0          )
vertex 22 at ( -0.951057 -0.309017 0          )
vertex 23 at ( -0.587785 -0.809017 0          )
vertex 24 at ( 0          -1         0          )
vertex 25 at ( 0.587785 -0.809017 0          )
vertex 26 at ( 0.951057 -0.309017 0          )
```

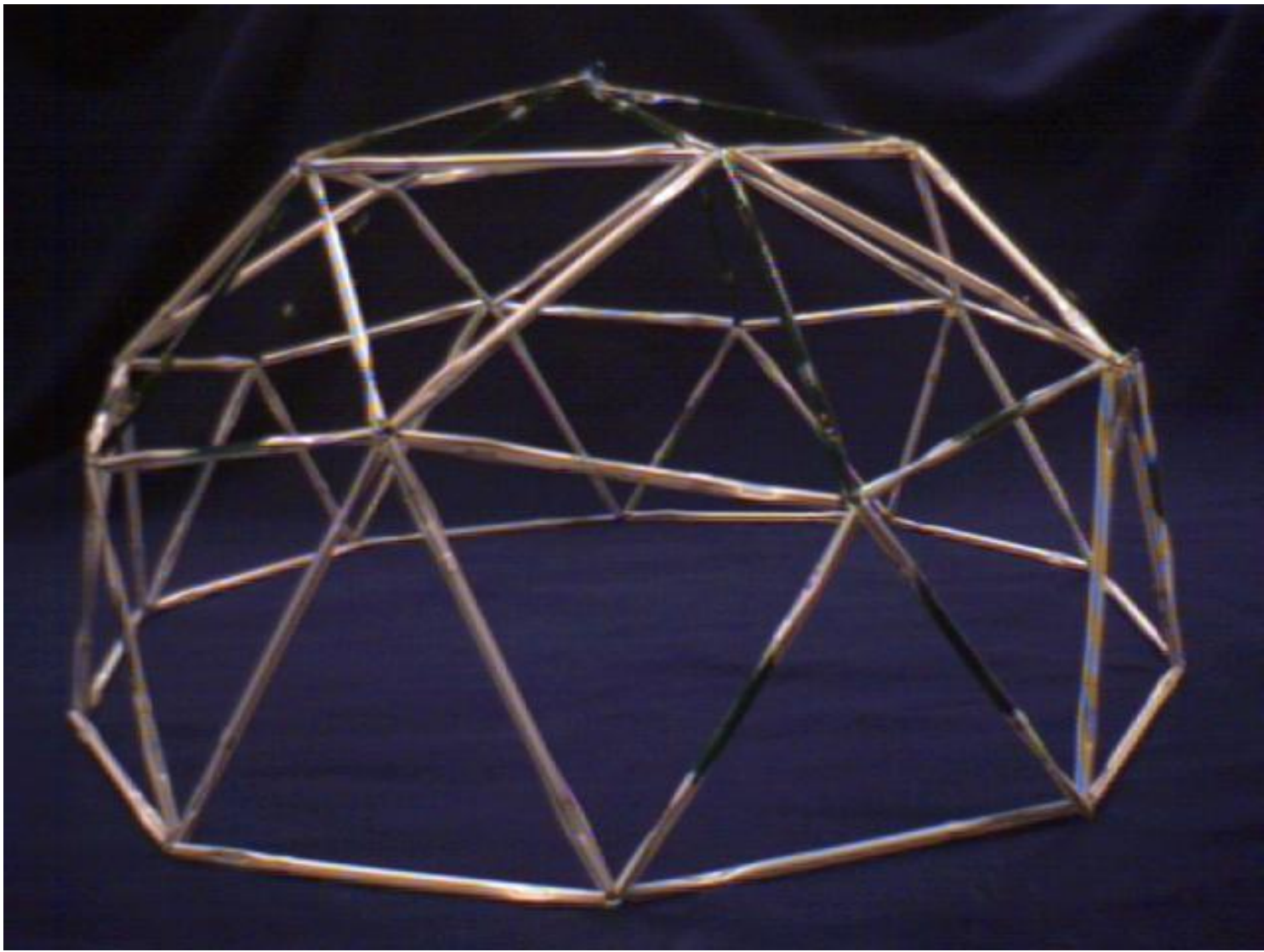



## **Site not found**

The URL you entered cannot be located at this site. The domain may no longer exist here, or you may have an invalid URL.

# Synergetics on the Web

Maintained by  
Kirby Uner  
4D Solutions

*The integration of geometry and philosophy in  
a single conceptual system providing a common language  
and accounting for both the physical and metaphysical.*  
Synergetics 251.50



[Welcome](#) | [Intro](#) | [Geodesic Domes](#) | [Fuller Projection](#) | [Links](#)

Search this site powered by [FreeFind](#)

# Nature's Structural Elements

Updated page: <http://hometown.aol.com/dometruss>

This WEB page with its links will strive to present nature's underlying structural elements along with their most prominent compounds and ensuing geodesic designs.

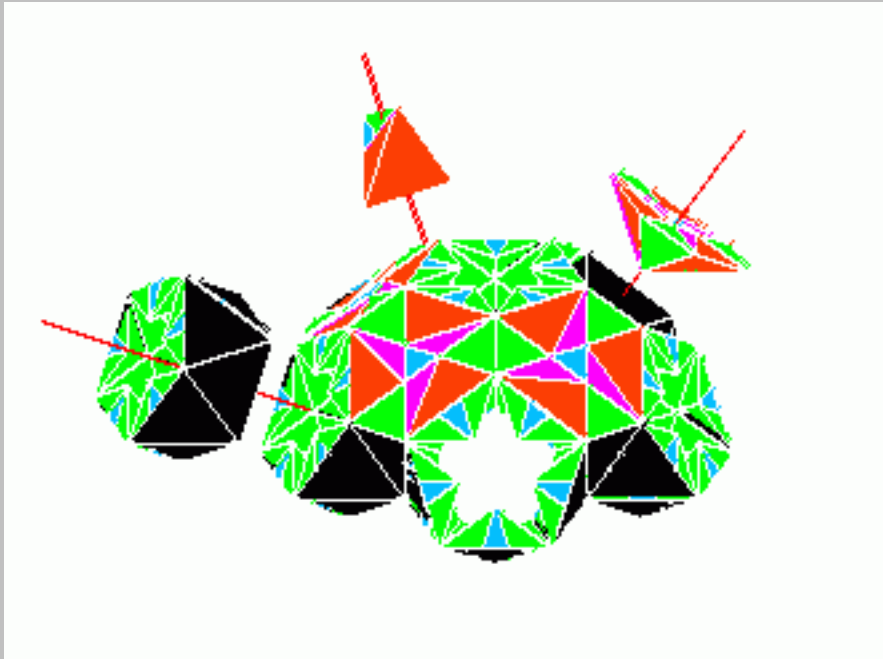

## Partial Hex-Pent Geodesic

The following drawings are of nature's structural elements, compounds, and some derived structures. To access the drawings for those elements, or compounds, simply click on that particular description. The elements are all 6 edged, 4 sided pyramids, with internodal lengths derived from the proportions and progressions of three elemental lengths; unity, square root of 2, and Tau ((square root (5) + 1)/2). Tau (T) is sometimes referred to as the mean proportion, the Golden Section, or sometimes as Phi. An example of Tau's strange properties is that:  $1 + 1/T = T$  and  $T(\text{squared}) = 1 + T$  etc. The above drawing is of a partial Hex-Pent Compound, which is a combination of simpler compounds based on a combinations of elements. It should be noted that this is different than a Fuller type geodesic in both form and derivation.

Elements and Compounds

- [Elements](#)
- [Compounds of Hex-Pent](#)
- [Hex-Pent Compound](#)
- [Dodacahedron & Tri-Pent Compound](#)
- [Icosahedron Compound](#)
- [Geometrical Derivation of Relative Internodal distance](#)
- [Paper Cut-out Models](#)
- [Molecular Modeling](#)
- [A Unified Theory](#)
- [3D Molecular Fractals](#)
- [Metaphysical aspects of Stuctural Elements](#)
- [Link to Sacred Geometry Page](#)

---

### **Text Work Books (shareware)**

- [Shareware \(3D Geometry workbooks\)](#)

---

### **Geodesic Applications**

- [32' Diameter Geodesic House Structure](#)
- [Photos of 32' Dome Fabrication \\*](#)

- [Photos of 32' Dome Construction\\*](#)
- [32' diameter dome - 2nd floor](#)
- [24' Diameter Geodesic House](#)
- [Greenhouse Attachment for 24' Dome](#)
- [Photos of 24' dome fabrication \(AOL site\)](#)
- [Photos of 24' dome assemblage \(AOL site\)](#)
- [Geodesic Greenhouse](#)
- [Conduit Domes](#)
- [14' Diameter 2x4 paneled Dome](#)

Note: All the above designs were drawn with care and field tested for any detail oversites, but no warrantees are given with regards to use.

---

### **Concrete Domes**

- [13' Diameter Ferro-Cement Storm Shelter](#)
- [Lightweight Concrete Gunitied Domes](#)

Plans for a simple ferro-cement cistern are in the works.

---

### **Interesting links**

- [Interesting links page](#)
- [Dome Links](#)



- [DomeHome Link](#)
  - [Fibonacci Links](#)
  - [Link to Pythagoras](#)
  - [Energy Link](#)
  - [Book Review Page](#)
- 

### Business Section

- [Ordering Plans](#)
  - [Order Form \(Geometry books\)](#)
  - [Dome kits link](#)
  - [Training and Business link](#)
  - [Send Comments to: roconroy@aol.com](#)
- 

## Xenocrates, On the life of Plato

**"Thus he then classified living creatures into genera and species, and divided them in every way until he came to their elements, which he called the five shapes and bodies-aether (dodecahedron), fire (tetrahedron), water (Icosahedron), earth (cube), and air (octahedron).**

Comments: Plato, who studied in Egypt, was not the first Greek to mention these elements. He was not commenting on solids, vapors and liquids, as sometimes thought, but on the structural building blocks of nature itself. A study of nature, from astronomy's Tau spiral shaped galaxies, to zoology's skeletons of radiolaria type plankton, will show that it evolves around the fibonacci series and it's ensuing solids. In my opinion these solids provide the framework for the structure of molecular bonding and could give that elusive key to unsolved mysteries.

## Book of Ecclesiastes

"there is nothing new under the sun"

## Book of Matthew

"there is nothing covered that will not be revealed, and hidden that will not be known"

---

Copyright 1997 Robert Conroy (this information can be copied for non commercial use only)

---

**Updated frequently, hit "reload" to insure up to date copies**

listed 1/16/96 last updated 12/4/03 rlc

---

Search words: Structural Elements, Geodesic Dome, Buckyball, Fullerene, C-60, Structural Dome, Geodesic Structure, Buckyball Structure, Fullerene Structure, Compound Structures, Home domes, Buckyball structural elements, Fullerene Structural Elements, home dome structures Fibonacci, Fibonacci Series, Golden Mean, Golden Ratio, Divine Proportion, Divine Section, Phi, Fullerene Molecule, earthquake structure, succah, lightweight concrete domes, concrete domes, free form concrete domes, pipe structures, low cost housing, Golden Section, molecular packing, tubular domes, earth contact home, solar home, solar heating, gunite, philosopher's stone..

[http://ourworld.compuserve.com/homepages/robert\\_conroy](http://ourworld.compuserve.com/homepages/robert_conroy)

## **This page presents conduit domes ranging from 4 1/2' radius thru 24' diameter.**

The following photo is an approximate 4 1/2' radius elipsoid made from two 1/4 geodesics with a spacer element. It is made from 3/4" electrical conduit and connected with 5/16" bolts.

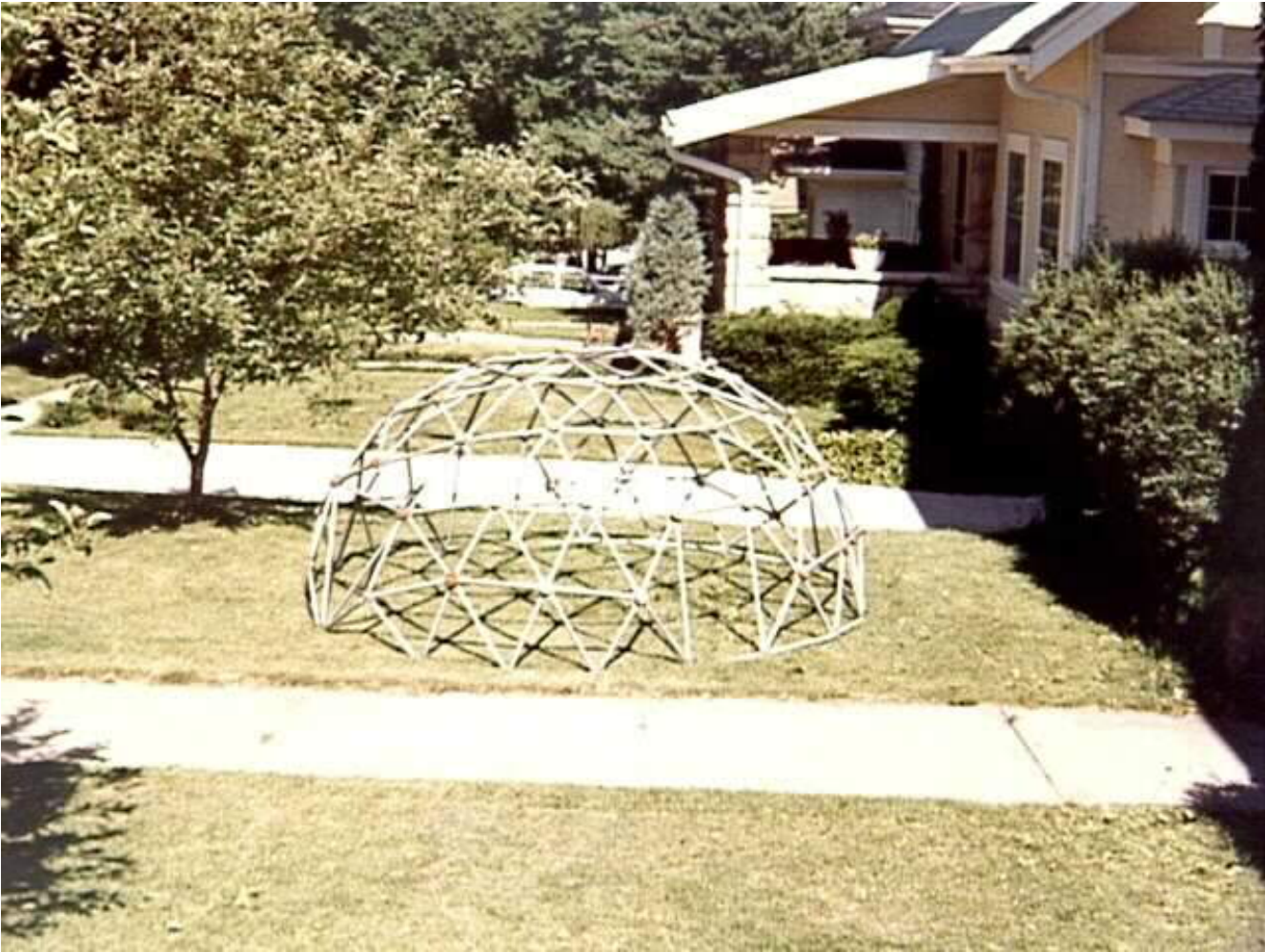

### **4' Radius Elipsoid**

---

The following photo is a 15' diameter solar collector/greenhouse. It is built from 3/4" electrical conduit connected by 5/16" bolts.



### **15' Diameter Greenhouse/Solar Collector**

---

The following photo is a 15' diameter greenhouse built with 3/4" electrical conduit. Its connections are made with 5/16" bolts. The covering is held in place with a wingnut over an extra washer.



## 15' Diameter Greenhouse

---

The following photo is 1/5 of a 24' compound geodesic. This non Fullerene geodesic can be configured in a 1/6, 1/5, 1/4, 1/2, 3/7, 4/7 type configuration. It is constructed from 3/4" electrical conduit using 5/16" bolt connections. It's high strength characteristics stem from the fact that the shorter tubing is in compression while the longer lengths are in tension under point loading conditions.



**12' Radius-1/5 Compound Geodesic**

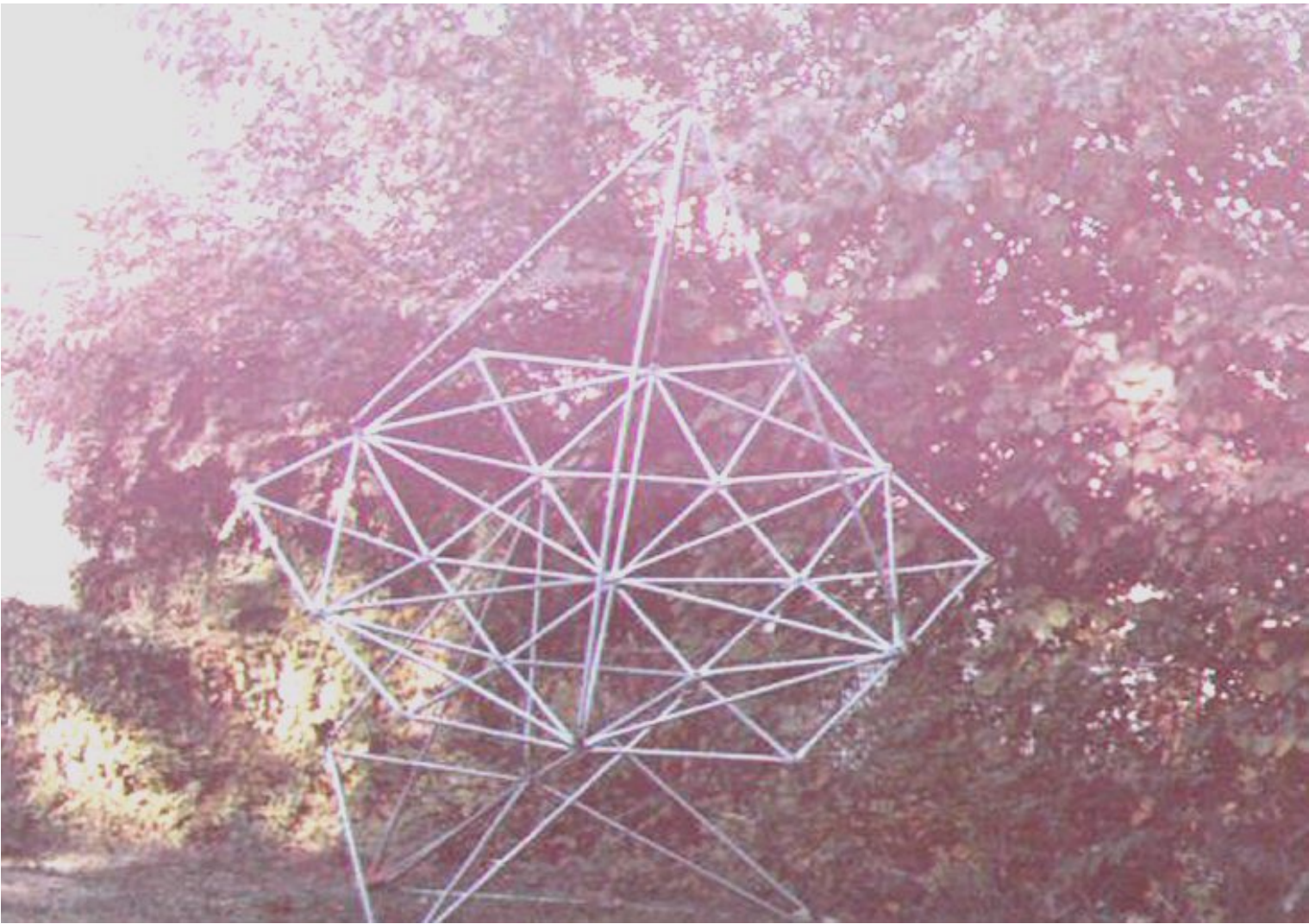

**Double Truss Solar Concentrator**

- [order conduit fabrication plans](#)
- [order form for books](#)
- [return to cover page](#)

The following gifs show the layout and cut-out pattern for a composite structure. The 32 foot diameter two story dome truss contains 225 ten foot long 2x4's. The total weight of the truss system being approximately 2250 lbs. The lightweight and compound nature of the structure makes it extremely earthquake resistant. Fabrication of the individual main struts requires a straightening cradle with a precise jig arrangement for drilling the connecting holes. Fabricating this structure is not for someone who cannot color between the lines. It should be also mentioned that all plumbers are to stay away from the struts. A 3 1/2" strut loses a bit of strength when drilled through for a 4" drain pipe. The same would go for electricians. All wire runs are to be done through a 1/2" hole using the same positioning as the bolt holes. Due to lack of space on this page, all the detail drawings could not be included. I hope to establish a ftp site where a complete zip folder can be downloaded. The following 2" x 4" truss has been analysed using the Kansas City, MO snow loading requirements of 20 psf and a wind load of 80 mph. For appreciable larger snow loads I recommend that insulated sheathing be applied to the exterior of the truss. Updated 3/16/99 by rlc.

Note: Truss is constructed of 2 X 4's set on edge.

Note: Connections are made with 3 number 12 galvanized nails. Two nails being normal to main strut and angled into brace support, the third being aligned with brace support.



48 Panel  
1/2 Geodesic

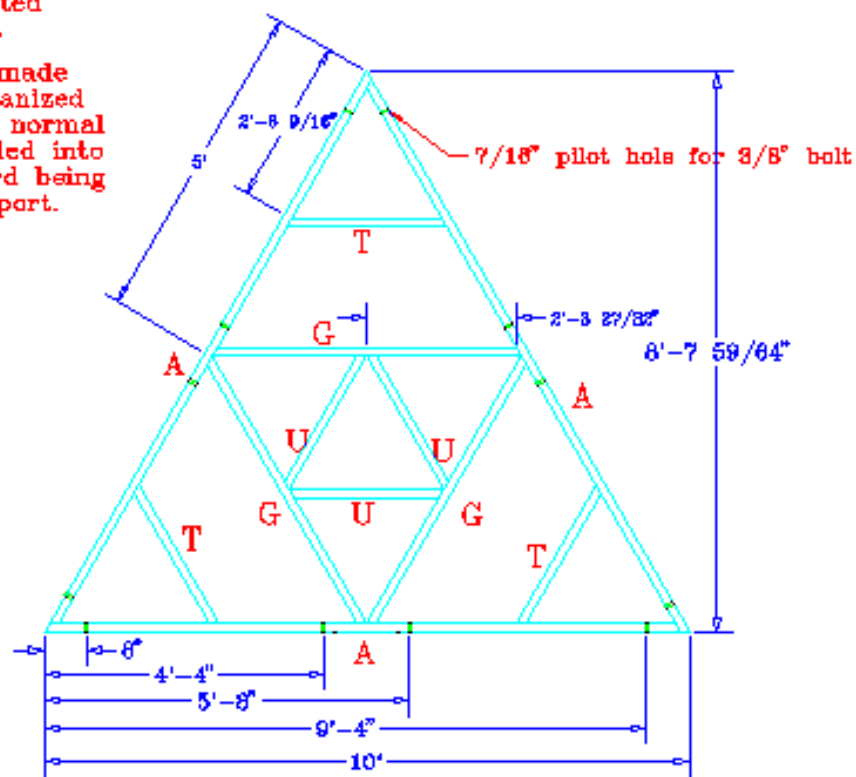

Connection Chart

Equal lateral Panel  
32' Tri-Pent Geodesic  
(10 Panels)

plan32ei.dwg.

drawn 3/28/96 rlc  
revised 2/16/98 rlc



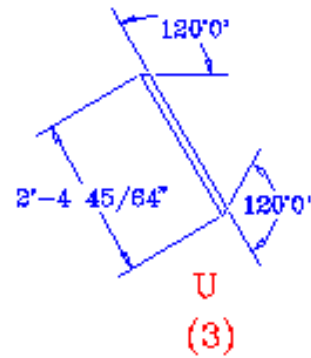
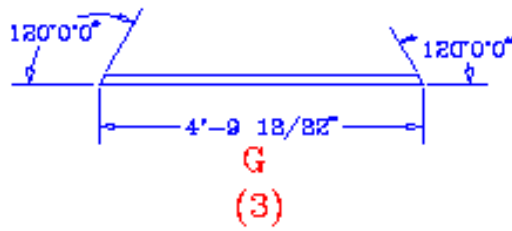
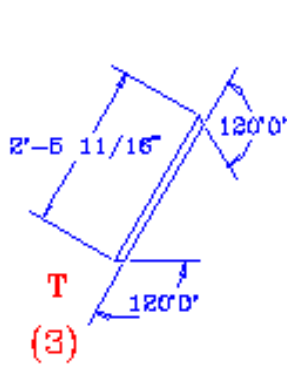

Note: Truss is constructed  
of 2 X 4's set on edge.

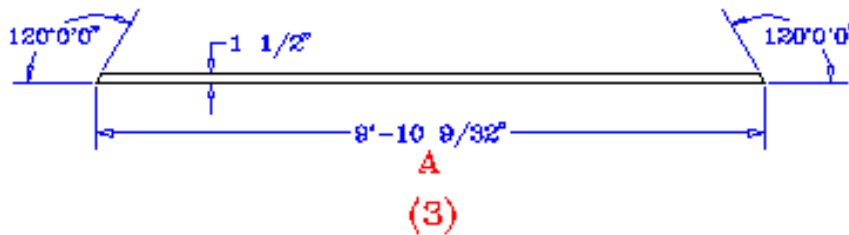

Modified Type B  
Equal lateral Section  
32' Tri-Pent Geodesic  
(10 Sections)  
MPG-F-1F.dwg.

revised 3/7/06 rlc

Note: Truss is constructed of 2 X 4's set on edge.

Connections are made with 3 number 12 nails for each connection along with a bottom plate connector at each of the three main connection points.

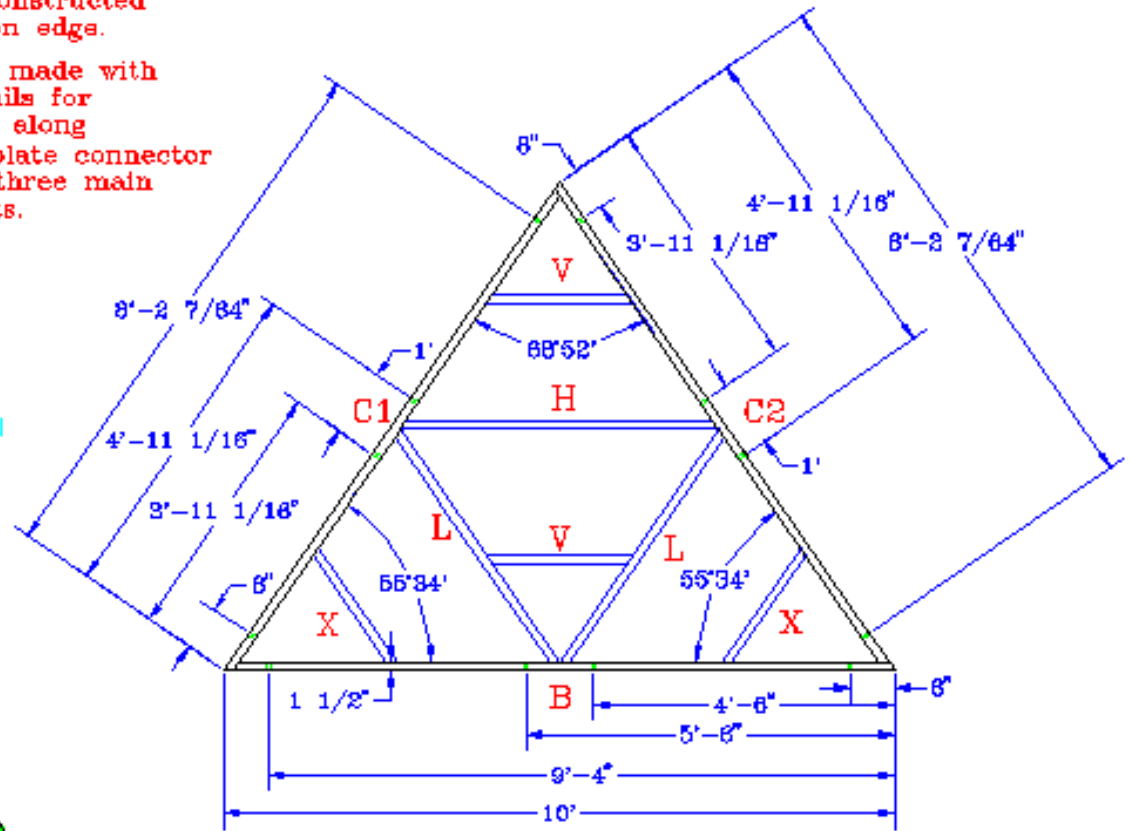

40 Triangles  
1/2 Geodesic

Modified Type B  
Pentagon Section  
32' Tri-Pent Geodesic  
(30 Sections)

MPG-F-1F.dwg.

revised 3/10/96  
rlc

Note: Truss is constructed of 2 X 4's set on edge.

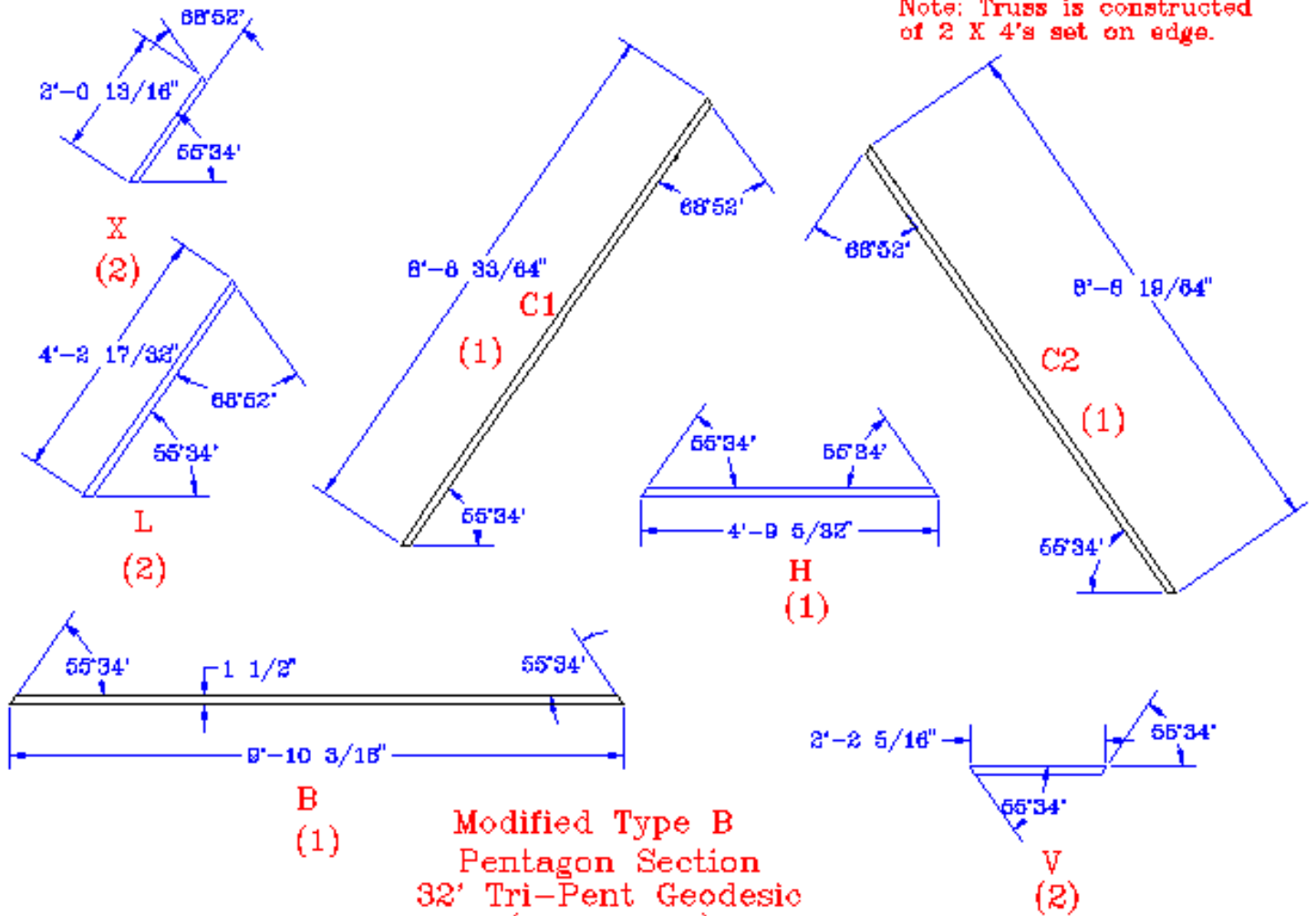

Modified Type B  
 Pentagon Section  
 32' Tri-Pent Geodesic  
 (30 Sections)  
 MPG-F-1F.dwg.

revised 3/10/96 rlc

Note: The scrap plywood is to be cut into 4" x 19" strips and used to splice the sheathing which is not positioned over a 2" x 4".

Note: Sheet rock is undercut 1/8" on all sides for both trusses.

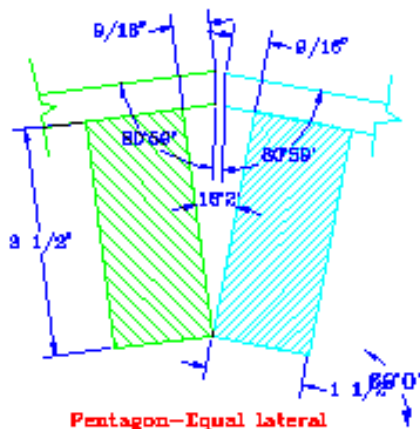

Pentagon-Equal lateral  
base connection

Plywood  
overhang detail

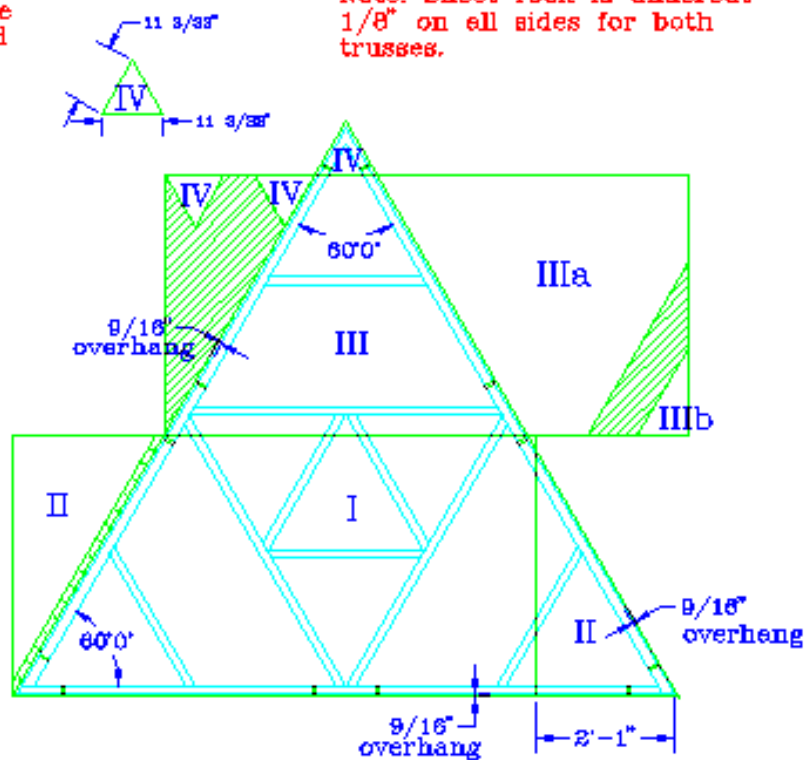

Cut-out Pattern for Plywood

32' Tri-Pent Geodesic  
Equal lateral Panel  
(10 Panels)

plan32ei.dwg  
plywd32.gif

drawn 4/24/96 ric  
revised 3/19/97 ric

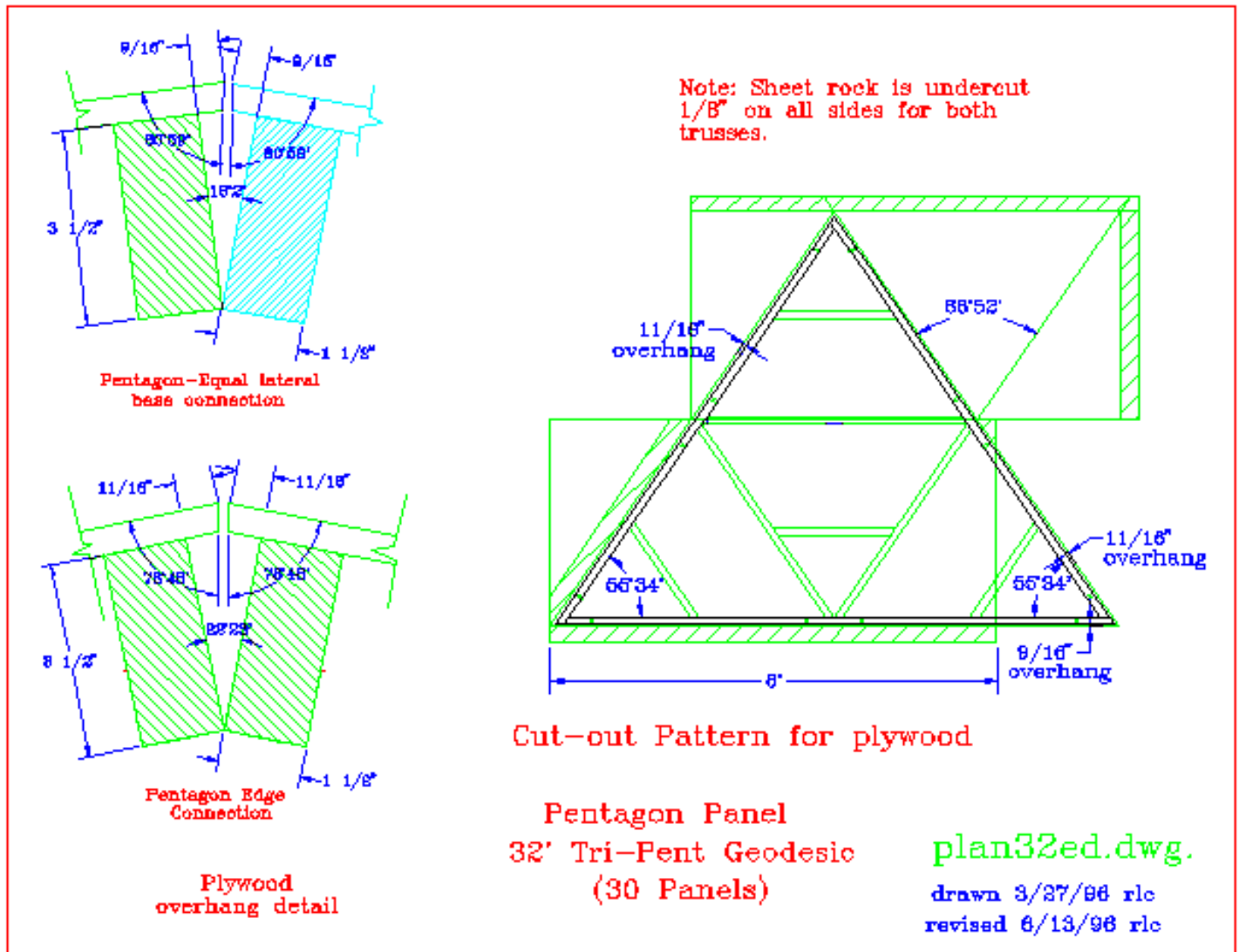

### Pattern and Layout for Composite Structure

The following gif is of the Composite Structure's connection system. Each truss section of the geodesic is connected with 4-4.5"x 3/8" bolts on each edge. The separating distance between the sections is filled in with a 4" long wedge at each bolt connection. The wedge is predrilled to allow for the bolt.

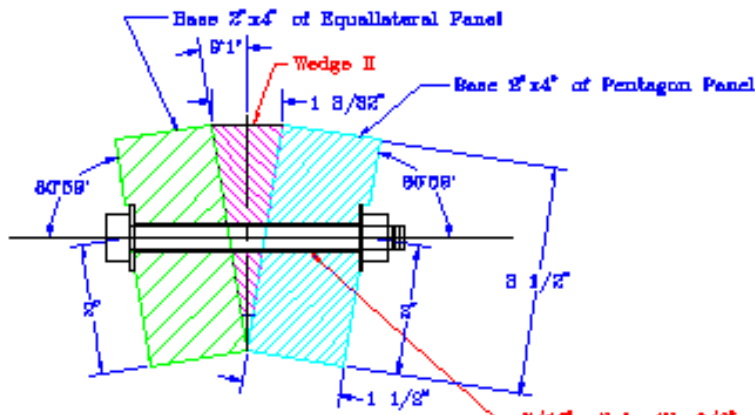

Equilateral Panel-Pentagon Panel Connection

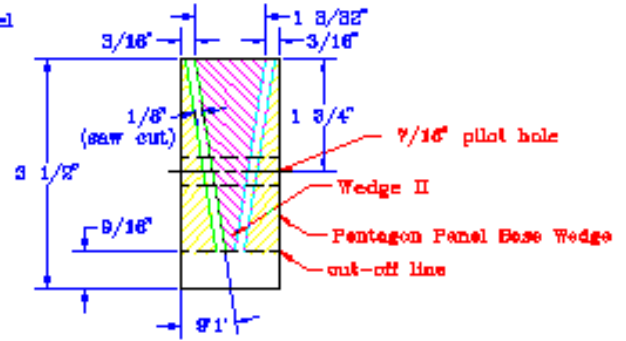

Wedge II

Note: Wedges are 4" long with predrilled 7/16" holes. 100 Wedge II are required. 120 Wedge I are required.

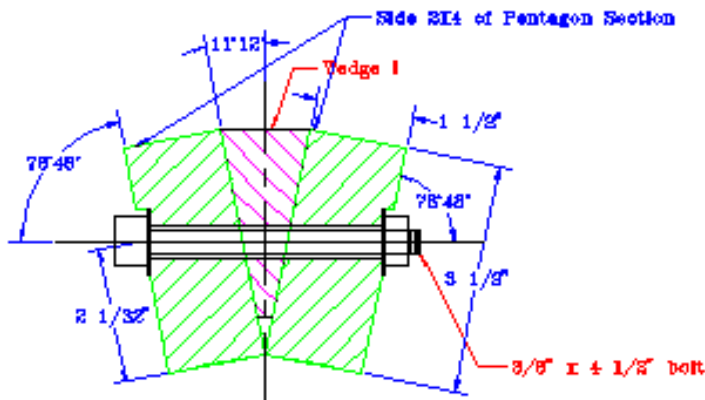

Pentagon Edge Connection

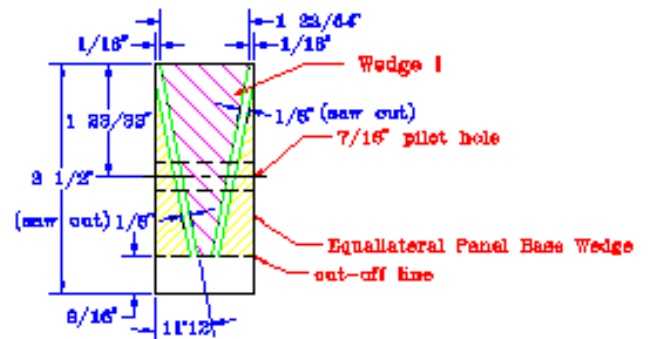

Wedge I

Tri-P-Gc.dwg  
conn2r4t1.gif  
drawn 8/6/98 rlc  
revised 10/1/97 rlc

## Type I Connectors

- [2nd floor joist plans](#)
- [To order dome kits](#)
- [Return to Cover Page](#)

[Up](#)

---

## markt's (geodesic) Dome picture page

---

My experimental dome framework, 60% scale of its intended size



My first metal dome, nearly 7m in diameter (also photos [here](#))



My first metal dome covered, at the Bristol juggling convention '98

---



My first metal dome covered, at the Wessex juggling convention '98



The metal dome at the engineering department of the Univ. of Cambridge (UK)





"Needle Tower" tensegrity sculpture by Kenneth Snelson (images at [www.frontiernet.net/~imaging/tenseg2.html](http://www.frontiernet.net/~imaging/tenseg2.html))

[Needle Tower  
from side]

[looking straight up Needle  
Tower from inside]

French dome



Larger French dome



Structure of above



geodome . jpg



Last updated by [markt@chaos.org.uk](mailto:markt@chaos.org.uk) Thur 11 Mar 1999

[Up](#)

---

# markt's (geodesic) Dome page

[click here for some pictures](#)

- My 7m dome page - [words only](#) or [pictures](#)
- [Buckminster Fuller](#) page,
- [A Fuller FAQ](#)
- [Applied Synergetics](#) [whatever that means] home page,
- [Domes](#)
- [more Domes](#)
- [A commercial tensegrity toy](#)
- [Lots of tensegrity piccies from Bill Collins](#)
- [Quasitiler](#) pseudosymmetry package
- [DOME magazine](#) where the tastes of the geometrically deviant are specially catered for (or something)
- [Michael Rader's dome page](#)
- [Walt Venable's dome page](#)
- [K-Dome kit page](#)

Nearly all dome/dome-kit manufacturers seem to be in the U.S., unfortunately, but the web pages can be an inspiration:

- [List of manufacturers](#)
- [Oregon Domes Inc.](#)
- [Timberline Geodesics Inc.](#)
- [Shelter Systems.](#)
- [Geometrica](#) seem to have the right idea about size!
- [KingDomes](#) (in Iceland!)
- [Lydick's Domes Unlimited](#)
- [Geodesics Unlimited](#) **NEW**
- [Monolithic Constructors Inc](#)
- [The Growing Dome](#) greenhouse - I think I saw this very model on the Isle of Skye, near Dunvegan!

**NEW** **NEW**

Recently [John Moon](#) contacted me mentioning dome construction workshops that he and Sean Hellman are running in the UK on 16th-18th April (Osho Leela, Dorset), 11th-13th June (Buckfastleigh, Devon), 23rd-25th July (Stoodleigh, Devon). Prices range from 85 to 99 pounds, including accommodation - I've no idea if there are concessionary prices, but see the contact details below to find out more. Disclaimer - these aren't my workshops!

Here is John's description of the workshops:

"You ask about the content of the dome tent workshops, with a view to highlighting them on your pages. What we intend to do is as follows:

- John will introduce the mathematical principles behind the generation of geodesic structures - platonic solids, archimedean solids, face breakdown, projection to the surface of the sphere, cutting structures horizontally and vertically, altering of shape, for example to elliptical.
- Sean will introduce the practical side of construction, materials, joints, coverings etc.
- Individuals will choose their own design and size of tent from amongst infinite possibilities, having been made aware of what's possible in John's introduction.
- John will generate the data for these choices - using mathematical and 3D CAD software. Individuals will build scale models of their chosen design using straws and connectors. Individuals will take these models home and all the information needed to build them.
- Sean will lead the building of one or two of the chosen domes, from scratch to completion of the frame, from coppiced hazel.

Hopefully 20 satisfied dome tent builders ready to grace the fields, camps and festivals of the world with multicoloured domes of every shape and size!"

The contact information I have is:

John Moon                    john\_moon@geodesics-unlimited.com  
Box Cottage,                    +1380 830019  
5 Tinhead Rd.,  
Edington,  
Westbury,  
WILTS. BA13 4PH

Last updated by [markt@chaos.org.uk](mailto:markt@chaos.org.uk) Wed 17 Feb 1999

# AMERICAN INGENUITY

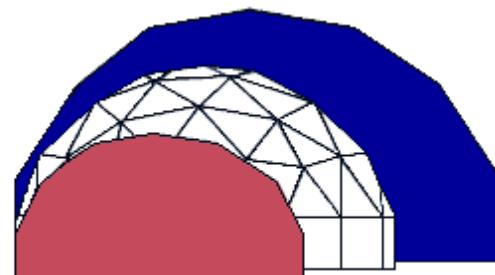

CREATING INTELLIGENT ALTERNATIVES



## **GEODESIC DOMES - AN ADVANCED HOUSING TECHNOLOGY**

Housing technology has changed very little since framing replaced the log cabin. Modifications have been made to improve efficiency and strength, but they have also increased cost. We applied some American ingenuity to the geodesic dome home, designed a unique component home building system utilizing advanced home construction technology, and developed a superior modular home plan.

## **DOME HOME CONSTRUCTION IS SIMPLER THAN CONVENTIONAL HOUSING**

An American Ingenuity dome is purchased as a shell kit. Purchasers without prior construction experience can build their own dome, or we can refer you to an independent subcontractor who can assemble the dome shell using local laborers. The simplified building process of our manufactured home consists of placing a row of panels, overlapping and interlocking the steel mesh from adjacent panels, and filling the seams with a specially formulated concrete.



## **CONCRETE DOMES HAVE EXCEPTIONAL STRENGTH**



The dome shape has an inherent strength that exceeds all other home designs, as proven by noted architect Buckminster Fuller. Our reinforced concrete dome home shells are virtually indestructible, able to withstand enormous wind and snow loads, and fully capable of supporting earth berming. As home manufacturers, we are absolutely confident in our domes, and we offer a structural guarantee that they will withstand natural disasters such as hurricanes, earthquakes, tornadoes, and falling trees.

## DOMES ARE EXTREMELY ENERGY EFFICIENT

Reduced surface area, uninterrupted insulation, lower air infiltration, and expanded polystyrene (EPS) insulation four times thicker than that used in refrigerators provide savings in heating and air conditioning cost that often exceed 50%. The model pictured at right received the [Florida Home Builders Association's](#)

Aurora Award for Residential Energy Efficiency and the Grand Award for The Most Energy Efficient Home in the Southeast, and it was featured on the cover of Popular Science magazine. All of our concrete dome models have received the EPA's Energy Star rating.



[F.H.B.A's](#)  
[Aurora Award](#)

## DOMES INTERIORS - MODERN AND SPACIOUS



High vaulted ceilings are a natural for domes. The strength of the dome is sufficient to suspend the second floor, completely eliminating the need for load bearing walls and allowing for large open floor areas. Floor plan designs become much more interesting and practical when you break away from square rooms. Single domes range from 500 to over 5,000 square feet. You can also link domes together, or add a garage or screen dome.

## OUR MODULAR FLOOR PLANS HAVE GREAT FLEXIBILITY

Your dome shell kit can contain standard entryways, high profile entryways, garage entryways, first floor or second floor window dormers, skylights, or a cupola. A patio or screen dome will add a new dimension to your home. A second floor entryway can also function as a balcony, which provides a romantic seating area or extra personal space. Our domes are well suited for mountain homes, retirement homes, beach houses, coastal homes, and vacation homes.



[Main](#)

[Dome Pictures](#) | [Floor Plans](#)

[Planning Kit / Video / Model Dome Kit](#)

[Mail](#) | [Dome Prices](#) | [Specifications](#) | [FAQ](#) | [Maps](#)

[Construction Cost Estimates](#)

[Dome Home Financing](#) | [Dome Construction](#) | [Links](#)

[The GEO POD - Utility Dome](#)

# AMERICAN INGENUITY, INC.

8777 Holiday Springs Road, Rockledge, Florida 32955-5805

PHONE: 321-639-8777 FAX: 321-639-8778

WEB: <http://www.aidomes.com> EMAIL: [info@aidomes.com](mailto:info@aidomes.com)

© Copyright 2002 [American Ingenuity Domes](#)

[Established in 1976](#)

[modular geodesic dome](#)

[HomeSalez.com](#)



About NewHouse

DecaDome™

LumaDome™

PlyDome™

PolyDome™

StuccoDome™

Home

# NewHouse Panelized Building Systems We go where you go.™

NewHouse R & D

E-Mail: [decadome@yahoo.com](mailto:decadome@yahoo.com)

Phone: (734) 417-3604 Fax: (734)769-5230

1318 Rosewood, Ann Arbor, MI 48104 USA

Copyright by NewHouse R&D 1997-99

# TIMBERLINE GEODESICS



Product Information



Scrapbook



Build A Dome



Plans



FAQ



Additional Information



Web Videos



On Line

For more than 30 years, we've been dedicated to designing Timberline Geodesic Dome packages that make it easy, practical and affordable for people to construct their own homes.

*New Plans*  
*Click Here*

To order our color catalog  
or video tape



To contact Timberline Geodesics call 1-800-DOME-HOME (1-800-366-3466) or write to us at 2015 Blake Street, Berkeley, CA 94704

[Home](#) | [Product Information](#) | [Scrapbook](#) | [Build A Dome](#) | [Plans](#) | [FAQ](#) | [Additional Information](#) | [Web Video](#) |

Web page design and maintenance by [Media Masters](#)

© Copyright 2004. Timberline Manufacturing Inc. All rights reserved.  
Timberline Geodesics and the Timberline Logo are Registered Trademarks of Timberline Manufacturing Inc.



# Welcome To DomeHomes.com



REVISED WEB SITE COMING SOON!



This domain name was registered through Thatcompany.com Reserve your domain name today! Thatcompany.com type to check the availability of your [domain name now!](#)

Please bookmark these links for future information on [support](#) questions

If you would like more information on hosting services go to [Th@tcompany.com!](#)

Powered by





**OREGON  
DOME, INC.**

**Request Info**

**Plans**

**Interiors**

**Events**

**Raisings**

**Links**

**For Sale**

**News**

**Download  
Brochure**



## It's time for an ***Oregon Dome***

- Flexible Spaces for Active Lifestyles
- Custom and Traditional Designs
- Complete, Affordable Building Systems

It's time for an Oregon Dome. [Our geodesic homes are unique](#), yet can please even those with the most traditional tastes. We integrate your site, budget, and desire for functional spaces, including ample storage. Energy and resource efficient, our panelized building system does "*more for less.*"

### **NEWSFLASH:**

**NAHB filming segment for DIY program on system built homes--panelized. Welcome Skye, Kevin, Tom and the Smiths (Gary, Andra, Tia, Jamie and Noelan) Barbara and ODI staff, thanks for doing what you do; keeping on schedule for the raising.**

Good year for manufacturing and design, troubles with computer mostly fixed. Please resend unanswered questions and let me know if material ordered hasn't arrived in timely manner.

**Our Move To Veneta Is Complete! New Company Brochure Shows Our New Facility, complete with a truck being loaded for a site in North Carolina!**

**OPEN HOUSE, Saturday, September 18, 10:30-2:30  
Jeans Road.**

**Spec Home Open House by appointment, E. Hunter Road**

We are available on other Weekends and evenings by appointment, really, I'll come in and out of family activities. Our regular office hours are Monday-Friday 9a.m. to 5p.m. The site is located in Veneta, OR, just West of Eugene, 25331 Jeans Road, West of the New Hope Church and East of the BiMart.

We are enjoying an increase in people calling to learn more about building domes. Many have yet to begin the search for land, first on the "to do" list. Since a 50x100 lot is enough land, whether to build a dome, if so, what size and do I have enough money isn't the first decision, land is first, then how much money is left for the building and does site allow lower level yes or no, for garage, yes or no then size. The people building today had plans drawn up to a year ago and have owned their land awhile.

Our \$15 catalog package or a call to our project advisor gives enough information to get to "how much does it cost to build". This site and our complimentary package (new ODI brochure now available) get you started on the idea of a dome.

Get land selected, (not necessarily purchased) call and describe the potential site, NSEW for view and driveway access and what you want in terms of rooms in a, 1-2-3-4,000 sq. ft. home. We'll "stand in" as your builder and help you with more than just "the kit costs". We will use cost of new home construction in your area, less land and saving generated by dome construction and what you truly want to do besides answer the builder's questions, to establish the budget.

It is generally more convenient and cost effective to purchase floor joists and framing material for the interior to kitchen cabinets and floor coverings locally. We are pleased to let you know what is included in our panelized product, usually from 10-50K, however the total project is from 40-500K, including the kit.

Before we take money to draw plans, we assist in determining a workable budget for the whole project based on a sketch and choices you make whether a builder does everything or you contribute. Plans that suit you and your site (custom) are reasonable (stock price) as often they are created from elements of other plans based on you and your land.

.

[Request Info](#) | [Plans](#) | [Interiors](#) | [Events](#) | [Raisings](#)  
[Links](#) | [For Sale](#) | [News](#) | [Download Brochure](#) | [Home](#)



**Oregon Dome, Inc.**  
25331 Jeans Rd.  
Veneta, OR 97487  
Phone: (800) 572-8943 • (541) 935-5444 • Fax: (541) 935-5812  
E-mail: [oregon@domes.com](mailto:oregon@domes.com)

## Popular Categories

[Travel](#)[Car Rental](#)[Hotels](#)[Airline](#)[Vacations](#)[Financial Planning](#)[Debt](#)[Credit Cards](#)[Loans](#)[Low Cost Insurance](#)[Business and Finance](#)[Affiliate Program](#)[Student Loans](#)[Stocks](#)[How to Make Money](#)[Health and Beauty](#)[Skin Care Products](#)[Exercise Equipment](#)[Hair Replacement](#)[Health Care](#)[Health Products](#)[Vitamins](#)[Weight Loss Drugs](#)[Joint Pain Relief](#)[Allergy Relief](#)[Sports Tickets](#)[Football Tickets](#)[Baseball Tickets](#)[Basketball Tickets](#)[Hockey Tickets](#)[Computers](#)[Internet ISPs](#)[Laptop Repairs](#)[LCD Projectors](#)[Computer Rental](#)[Professional Services](#)[Internet Casino](#)[Pet Supplies](#)[Dating](#)[Gourmet Food Gifts](#)[New Technology](#)[Plasma Screen TVs](#)[Home Audio](#)[DVD Rental](#)[PDAs](#)[Legal Help](#)[DUI Lawyers](#)[Accident Lawyers](#)[Probate Lawyers](#)[Bankruptcy Lawyers](#)[Online Store](#)[Flowers](#)[Gifts](#)[Automobiles](#)[Online Auctions](#)[Gifts](#)[Gift Baskets](#)[Wedding Gifts](#)[Gift Certificate](#)[Toys](#)

Haven't found what you're looking for? Try Searching here:

Search the Web:

[About Us](#) - [Inquire About this Domain](#)

Popular Searches: [GIFTS](#) | [FLOWERS](#) | [TRAVEL](#)

Search Categories:

|                                  |                                     |                                     |                                        |
|----------------------------------|-------------------------------------|-------------------------------------|----------------------------------------|
| <a href="#">Travel</a>           | <a href="#">Online Gambling</a>     | <a href="#">Insurance</a>           | <a href="#">Business</a>               |
| <a href="#">Air Travel</a>       | <a href="#">Online Casinos</a>      | <a href="#">Health Insurance</a>    | <a href="#">Merchant Accounts</a>      |
| <a href="#">Car Rentals</a>      | <a href="#">Sports Betting</a>      | <a href="#">Auto Insurance</a>      | <a href="#">Human Resources</a>        |
| <a href="#">Vacations</a>        | <a href="#">Online Poker</a>        | <a href="#">Medical Insurance</a>   | <a href="#">Business Opportunities</a> |
| <a href="#">Business Travel</a>  | <a href="#">Online Black Jack</a>   | <a href="#">Dental Plans</a>        | <a href="#">Fundraising</a>            |
| <a href="#">Travel Packages</a>  | <a href="#">Online Betting</a>      | <a href="#">Home Insurance</a>      | <a href="#">Call Centers</a>           |
| <a href="#">Hotels</a>           | <a href="#">Las Vegas Hotel</a>     | <a href="#">Life Insurance</a>      | <a href="#">Home Business</a>          |
| <a href="#">Travel Insurance</a> | <a href="#">Online Gambling</a>     | <a href="#">Business Insurance</a>  | <a href="#">Day Trading</a>            |
| <a href="#">Las Vegas Hotel</a>  | <a href="#">Sports Gambling</a>     | <a href="#">Renters Insurance</a>   | <a href="#">Small Business</a>         |
| <a href="#">Vacation Rentals</a> | <a href="#">Online Bingo</a>        | <a href="#">Term Life Insurance</a> | <a href="#">Brochures</a>              |
| <a href="#">Cruises</a>          | <a href="#">Online Slots</a>        | <a href="#">Fraud Protection</a>    | <a href="#">Franchises</a>             |
| <a href="#">Health</a>           | <a href="#">Internet</a>            | <a href="#">Autos</a>               | <a href="#">Computers</a>              |
| <a href="#">Phentermine</a>      | <a href="#">Web Hosting</a>         | <a href="#">Auto Insurance</a>      | <a href="#">Help Desk</a>              |
| <a href="#">Diabetes</a>         | <a href="#">Domain Registration</a> | <a href="#">Car Loans</a>           | <a href="#">Inkjet Cartridges</a>      |
| <a href="#">Viagra</a>           | <a href="#">Web Servers</a>         | <a href="#">Car Rentals</a>         | <a href="#">Computer Service</a>       |
| <a href="#">Lipitor</a>          | <a href="#">Pop Up</a>              | <a href="#">Used Car Loan</a>       | <a href="#">Computer Security</a>      |
| <a href="#">Health Insurance</a> | <a href="#">Shopping Carts</a>      | <a href="#">SUVs</a>                | <a href="#">Security Software</a>      |
| <a href="#">HGH</a>              | <a href="#">ISPs</a>                | <a href="#">Auto Warranty</a>       | <a href="#">Notebooks</a>              |
| <a href="#">Online Pharmacy</a>  | <a href="#">Web Page</a>            | <a href="#">RVs</a>                 | <a href="#">Web Servers</a>            |
| <a href="#">Flonase</a>          | <a href="#">Broadband</a>           | <a href="#">New Cars</a>            | <a href="#">Security Software</a>      |
| <a href="#">Diet</a>             | <a href="#">Internet Access</a>     | <a href="#">Trucks</a>              | <a href="#">Computer Training</a>      |
| <a href="#">Celebrex</a>         | <a href="#">DSL</a>                 | <a href="#">Used Cars</a>           | <a href="#">Linux</a>                  |

|                                    |                                   |                                    |                                     |
|------------------------------------|-----------------------------------|------------------------------------|-------------------------------------|
| <a href="#">Homes</a>              | <a href="#">Education</a>         | <a href="#">Finance</a>            | <a href="#">Legal Help</a>          |
| <a href="#">Home Equity Loans</a>  | <a href="#">Distance Learning</a> | <a href="#">Debt Consolidation</a> | <a href="#">Personal Injury</a>     |
| <a href="#">Refinance</a>          | <a href="#">Adult Education</a>   | <a href="#">Cash Advance</a>       | <a href="#">Wrongful Death</a>      |
| <a href="#">Mortgages</a>          | <a href="#">Online Degree</a>     | <a href="#">Refinance</a>          | <a href="#">Divorce</a>             |
| <a href="#">Renters Insurance</a>  | <a href="#">Business Schools</a>  | <a href="#">Loans</a>              | <a href="#">Tax</a>                 |
| <a href="#">Home Insurance</a>     | <a href="#">University</a>        | <a href="#">Debt Help</a>          | <a href="#">Patents</a>             |
| <a href="#">Air Purifiers</a>      | <a href="#">Term Papers</a>       | <a href="#">Credit Debt</a>        | <a href="#">Medical Malpractice</a> |
| <a href="#">Home Security</a>      | <a href="#">Online Training</a>   | <a href="#">Consolidation</a>      | <a href="#">Cerebral Palsy</a>      |
| <a href="#">Alarm Systems</a>      | <a href="#">Financial Aid</a>     | <a href="#">Credit Report</a>      | <a href="#">Wills</a>               |
| <a href="#">Moving</a>             | <a href="#">Computer Training</a> | <a href="#">Bankruptcy</a>         | <a href="#">Prepaid Legal</a>       |
| <a href="#">Real Estate Broker</a> | <a href="#">Online Education</a>  | <a href="#">Credit Card</a>        | <a href="#">Attorneys</a>           |

Copyright © 1999-2004 **Netster®**. All rights reserved.

[About Us](#) | [About This Domain](#) | [Questions](#) | [Copyright Info](#) | [Spam Policy](#) | [Privacy Policy](#)

PLEASE NOTE: You may have arrived at this site because you mistyped your desired Internet address or domain name, or the web site you are seeking may not be operational. Please make sure you typed the address or domain name correctly. You may use the "Back" button on your browser to return to your previous page, or you may use our search engine to find your intended destination.



# CONSTRUCTIONS LAB & KINGDOMES C/O [EINAR THORSTEINN](#)

## [Links To Other Pages](#)

---

### [About Constructions Lab and Einar Thorsteinn](#)

Here you will find information based on our own research about the following :

- GEODESIC DOMES
  - TENT STRUCTURES
  - ECOLOGY IN BUILDINGS
  - HEALTH & HOUSING
  - 3-D GEOMETRY
  - DIVERSE NEW SCIENCE FIELDS
  - **EXCERPTS FROM THE NEW BOOK:**[towards a NEW REALITY](#)
-



# Kingdome Calculator One

**NEW!**

Kingdome Calculator ONE computes all the numbers and values for your dome and gives you pictures of existing domes. Also good for timber quantity calculations. Kingdome Calculator ONE is a shareware and runs on Windows 3.1 or above.

[Download Now!](#)

---

## Geodesic Dome Material

The geodesic dome material which is all in english and you can order from is this:

Constructions Lab / Kingdomes Are Offering The Following.  
The prices include postage:

### Description:

---

[How To Draw Geodesic Domes](#) **NEW!**

[Order In Chaos: A New Video Interview with Einar Thorsteinn](#)

**NEW!**

For Do-It-Yourselfers: [The Starter](#)

[The D.M.I.Y.-Video](#)

Dome-It-Yourself: [Info Kit](#)

For Those Who Want To Understand What Domes Are All About: [Eight Models Of Domes](#)

For Those Interested In Taking Courses: [KCS Brochure](#)

[Natures Forms](#)

[The Development Pattern Of Geometric Structures](#)

[Articles On Domes By Einar Thorsteinn](#)

[The EDC Report](#)

[All Items A to H, A Special Offer](#)

[Kingdome Geodesic Building Manual](#)

[Kingdomes Calculator](#)

For Specialists Only: [Triangular Faces Geodesic Frequency](#)

**For Specialists Only: [Frequency Calculation Sheets](#)**

**For Specialists Only: [Courses](#)**

---

To order: Have your credit card ready, plus your name and address. Or send check or money-order.

Ask for what further information on domes is in the making by **Constructions Lab** or ask for information on other works of Einar Thorsteinn. Contact us on any other subject that is named in our introduction here and we will exchange information in the same field you have with you.

Or contact Einar Thorsteinn in E-Mail:

[kingdome@mmedia.is](mailto:kingdome@mmedia.is)

KCS p.o. box 980427  
Houston TX 77098

or

CL p.o. box 1464  
IS-121 Reykjavik  
Iceland

---

teljari

kingdome@mmedia.is



Search:

[The Monolithic Dome](#)

[Site Index](#)

[Homes](#)

[Schools](#)

[Sports](#)

[Churches](#)

[Commercial](#)

[Storages](#)

[Airforms & Tarps](#)

[Equipment Marketplace](#)

[Planning & Design](#)

[Construction & Training](#)

[President's Sphere](#)

[Editor's Circle](#)

[Dome News](#)

[Bulletin Board](#)

[Builder Listings](#)

[Workshops](#)

[Conference](#)



**Please Donate!**  
Jamie South Cooper  
Liver Transplant Fund

**OMEGAball!**  
the final ball,  
the greatest game

**Don't Miss Out!**  
Monolithic  
Calendar

QUICK LINKS

**BROCHURE**

**NEW!**

**ONLINE HOME EVALUATOR**

WHAT IS A MONOLITHIC DOME?

WHO WE ARE

FREE! PROJECT EVALUATION

FEASIBILITY STUDIES

NEW DOME NEWS EVERY WEEK!

**NEW!** MONOLITHIC DOME INFO PAK! DVD OR VHS

ENERGY STAR PARTNER

NEW BOOK! DOMES FOR TOMORROW ORDER NOW

WWW.DOMEBUILDERS.COM

NEW BOOK! DOME LIVING ORDER NOW

BUILDER BULLETIN BOARD

MONOLITHIC CONSTRUCTION MANAGEMENT

DOME BUILDERS MARKETPLACE

MONOLITHIC DOME BUILDERS ASSOCIATION

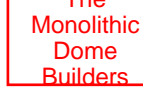
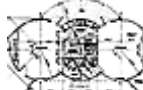
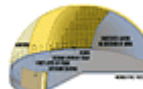

**NEW! Surviving Hurricanes and Tornadoes**

Back-to-back hurricanes in Florida catch the media's attention and shine a light on the benefits of the Monolithic Dome.

**MORE DOMES ADDED! 2004 Annual Monolithic Dome Tour**



"Charity Begins at Dome" is the theme for the 4th Annual Fall Dome Tour to be held on Saturday October 9, 2004. Homes across the United States and Canada will be opened for the public to view. Many churches, schools, and businesses will be open for touring on Friday, October 8, 2004.

- [List of domes currently signed up to participate.](#)
- [Sign up your dome!](#)

**NEW! Affordable Indoor High School Stadiums**



Your local High School or community college can now afford an indoor football stadium! A Monolithic Dome Indoor Stadium/Field house can be built for about the same amount of money as an outdoor football stadium.

**NEW! Dome of a Home on Travel Channel**

**NEW! Monolithic Domes -- The Future of Entertainment**



**Stardome Studios** -- The innovative plan for an entire movie studio built of Monolithic Domes has moved to the next level of design and production. Although the location of the studio has not been disclosed at this time, architects and designers are busily creating this one-of-a-kind studio concept.

**NEW! Monolithic Mosque in Iraq Still Stands**

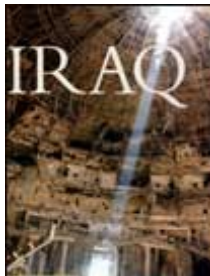

During 1991, a war was underway between Iraq and Iran. Jan Pregowski of Monolithic Constructors of Poland was asked to go to Iraq during this time of political unrest to construct 28 domes. Twenty-seven of the domes were grain storages, 117' in diameter and 58' tall. But one, a 40-foot diameter dome, was built as a mosque for Saddam Hussein.

The mosque was bombed during the present-day war in Iraq by a 5000 lb. bomb. Although the interior will need massive repair, the dome itself is structurally sound.

MORE QUICK LINKS

**NEW! Dome Home For Sale in New Mexico**

**Shopping For Insurance-- A few tips to finding affordable insurance for your Monolithic Dome**

**Spray-in-Place Concrete Fences Highlighted in *Extreme How-to Magazine***



The September 2004 issue of *Extreme How-to Magazine* features a 5 page article about Monolithic's Spray-in-Place Concrete Fences. *Extreme How-To* is available at home improvement stores like Home Depot or Lowes. Pick up a copy today!

These super-strong, beautiful and permanent fences were developed here, at the Monolithic Dome Institute's Headquarters in Italy, Texas. A concrete spray-in-place fence is an excellent financial investment. It will not rot or be destroyed by winds or inclement weather. It is a fence that will last years beyond any other type of fencing.

**Monolithic Dome Home For Rent in Ontario, Canada -- or perhaps even for sale**

**We Know Domes - Hire Monolithic Today**



*Monolithic Gets the Job Done.* If you need a Monolithic Dome with all of its benefits - contract with Monolithic to get the job done. We have the experience and expertise to help you meet your commercial or residential building needs, on-time and within budget.

**Compromise Or The Best Of Two Worlds? Atalaya del Vulcan**



Darryl Cunningham, a 49-year-old project manager for [Dome Technology, Inc.](#) of Idaho Falls, Idaho thinks that his dome construction experience has led him to believe two things. He says, "Right now, most people love the inside of a dome, and they love the benefits of a Monolithic Dome -- its strength and energy efficiency -- but most are still a little shy about living in what they perceive as an igloo-shape house.

**Generational Housing-- Creating a home for now and later**

Generational housing is built with features to accommodate young children, the disabled and the elderly. As the family size increases or its needs change, the dwelling can be reconfigured.

**Trade Secrets-- To share or not to share**

When you gain considerable amount of knowledge and experience, sometimes you have to be a little bit careful how you disseminate it.

**Spray-in-Place Fence Pricing**

**[Click Here!](#) to receive our email newsletters!**

**[Books & Videos](#)**

**[Residential Dreams: A list of resources](#)**

**[Why Build A Concrete Dome?-- by Dr. Arnold Wilson](#)**

**[From Toothpicks to Trailblazing-- The Birth of The Monolithic Dome](#)**

**[The True Cost of A Dome Home](#)**

**[We've Got Mail](#)**

**[How-To's](#)**

**[The Monolithic\(tm\) Construction Process](#)**

Step by step illustrations of the Monolithic Dome (insulated thin-shell concrete structure) construction process.

**[How to order an Airform](#)**



A concrete spray-in-place fence is an excellent financial investment. It will not rot or be destroyed by winds or inclement weather. It is a fence that will last years beyond any other type of fencing. If you are considering a spray-in-place concrete fence and would like Monolithic to get the job done, here is a price list and optional designs to consider.

### The EcoShell Inflator



The EcoShell I is inflated using an industrial line vacuum blower. The blower is an AMETEK, purchased through Grainger (part number 2M178). It weighs only 9.5 pounds, but is capable of pushing over 100 inches of water column. **Great care must be taken not to "over inflate" an Airform.** If a sealed Airform is pushed to 100 inches, it would either totally destroy the floor, rip up the Airform or do other serious damage.

### Passing the Bullet Test-- The strength and durability of Monolithic Domes



As they say on TV, "Don't try this at home." Don't shoot holes in your home with a 30-06 caliber rifle. In the photograph on the left Gary Clark is firing on one of our 32-foot Monolithic Dome storage buildings. He is firing from very close range, nearly perpendicular to the dome.

### Around the World in Seven Days-- David B. South Talks Domes in India



"I had to ask myself while I was traveling for nearly 30 hours; Do I not have enough to do in the United States to keep me busy? Why in the world am I traveling all away around the world to sell domes?" said David B. South.

### Alert the Media! BWG Agency Creatively Promotes Monolithic Domes

Think back to the last newspaper or magazine that you read. What do you remember about it? If you're like most people, it is a news article that stands out in your mind. In fact, if you're as busy as rest of us, you probably either skimmed or skipped right over the advertisements.

### Monolithic Domes Will Weather Price Increases Better Than Conventional Structures

Monolithic Domes take a much smaller amount of steel and concrete per square foot than most conventional structures.... So the impact of price increases will be lower with a Monolithic Dome.

### Brooksville Assembly of God -- Debt Free and Stress Free



It took two and a half years from groundbreaking to the first service, but Brooksville Assembly of God was able to successfully complete their Monolithic Dome church -- debt free. "And it wasn't only debt free," said Executive Pastor, Frank Prestigiacomo, "it was virtually stress free.

### From Geodesic to Monolithic Domes



While attending high school in Idaho back in the 1950's I attended a lecture given by Buckminster Fuller. He was promoting the geodesic dome. I was instantly fascinated with the concept of a building which, because of it's shape, would cover more area with less materials than any other structure.

## **Aggieland Fitness Dome-- The Dome as an Advertising Tool**



"The dome has done all the things I was hoping it would do. It differentiates us from other buildings and brings potential customers through the door," said Steve Lumpee, owner of Aggieland Fitness in College Station, Texas.

## **Thoughts on the Bidding Process for Construction of New Schools -- by David B. South**

The Federal government is now turning loose many of their projects on what is known as design/build... This is not a very popular system with schools yet, although we are seeing it done. It has enormous positive ramifications for the purchasing body (i.e. the school). If competitive pricing is one of the goals, design/build is probably the most competitive system of all.

## **Helping the Poorest of the Poor-- EcoShells in Haiti**



Recently, Nick Van Wingerden of Double Harvest and several co-workers returned from Haiti after spending time preparing for and constructing a 20-foot EcoShell as a demonstration home for the Haitians.

## **Cost Estimates for Simple and Professional Monolithic Dome Rinks and Arenas**



The Monolithic Dome can be built up to 1,000' diameter, making the sky the limit on arena use, size and seating capacity.

## **FEMA -- Design and Construction for Community Shelters and Its Application to Domes-- by Dr. Arnold Wilson**

After reviewing the FEMA requirements for a structure capable of providing a safe shelter for people in areas where hurricanes and tornados represent a real danger, the Monolithic Dome, because of its very nature, heads the list for economy and strength to resist the extreme loads.

## **Now Playing: The 21st Century Movie Theater**



"Theatres should look unique. They always have. That's tradition with theaters. Monolithic Domes are the perfect structure to provide a unique and interesting theater on the outside and the inside. People are attracted to the unusual."

## **Is that a church that just landed?**



Find out what the Pantheon of Rome and an increasing number of churches have in common.

## **Protect Your Investment -- Monolithic Dome Airplane Hangars**



The new Monolithic Hangar door is both strong and simple. It's a single piece, compound, curved door that rotates within the hangar. The door's patent application describes it as a *unitary, contoured, laterally moveable, access door*.

## **Who Needs the Monolithic® Integrator™ Portable Concrete Mixer? You do.**



The Monolithic Integrator Portable Concrete Mixer does the hard work for you. It is an attachment for a skid-steer or other front-end loader so it is totally mobile. It is self-loading, so sand and gravel do not need to be hand shoveled. It mixes extremely quickly and is easy to maintain.

177 Dome Park Place - Italy, TX 76651  
Tel (972)483-7423 - Fax (972)483-6662  
[mail@monolithic.com](mailto:mail@monolithic.com) | [Press Room](#)

# NATURAL SPACES DOMES



37955 Bridge Road, North Branch, MN 55056  
800-733-7107

[nsd@naturalspacesdomes.com](mailto:nsd@naturalspacesdomes.com)

In contrast to the mid-60's, when most geodesic dome homes were funky, patched-up symbols of the counterculture, today's average dome buyer is rather middle-American.

Natural Spaces is building a basic American housing unit that is a natural and intelligent alternative to expensive and inefficient housing. Our geodesic dome-homers speak lyrically of the feeling of spaciousness, of an almost mystical airiness induced by living under a skylit canopy.

A Natural Spaces Geodesic Dome Home can provide you with a totally new experience in living - a spacious, open, airy environment. Design flexibility allows you to have a total freedom of expression in creating marvelous interior dome spaces. Skylights let the moon and stars in and show clouds drifting by, lifting your spirits even on the dullest of days. Imagine a gently curved ceiling over twenty feet high.



You'll never again feel boxed in, just safe, comfortable, and snug. It's time our houses were built for the way we live. The OBSOLETE way may be the easy way to build today, but it won't give you your money's worth tomorrow.

View our environmentally friendly **FREE Literature!**  
54-page [All About Domes Catalog](#) and our 39-page [Price List](#) ONLINE!  
or to receive a free hard copy of these items



Order them here - [All About Domes & Price List](#)

**Join our email mailing list for info on upcoming events**

**Email Address:**

[Privacy Policy](#)

Scroll down to see our extensive web site on dome homes.

**The Natural Spaces Dome Building System is the only dome building system specifically adapted to the 5 different climatic regions of the United States. We are long time members and supporters of EEBA, The Energy and Environmental Building Association. Their innovative, well-researched building guides give us the information we need to adapt our dome system to the 5 major climatic regions: Cold, Warm-Dry, Warm-Moist, Hot Humid and Marine Coastal.**

**In our 30+ years of building dome structures, we have learned you shouldn't build the same structure in Minnesota as you would in Houston, Texas...**

**[Click here for the rest of this story.](#)**



Dreaming of castles in the clouds? Natural Spaces Domes can make your dome dreams come true. The "castle" on the left will be on our Fall Tour of Domes, October 2nd.

[Click here for more Tour info.](#)



[Click here to see more pictures of this "Castle" dome.](#)

Our geodesic domes are not simple shells of cold building materials. Our geodesic domes are artfully designed homes filled with the texture and warmth of spaces in which you can live and enjoy life. Our geodesic domes are natural spaces.





Because no building use, family life-style or site is exactly the same, we custom design a structure for you that attempts to meet individual human needs, while conserving energy to the fullest and complimenting the environment. "Integrated" structures combine numerous items of energy-conserving design. We feel the future demands that structures built today are able to cope with ever-changing world events by being as self sufficient as possible.

This site is best viewed with **Anastasia true type font** - [click here to download the 17kb file free](#)  
and insert it into your "windows" "fonts" folder

## Upcoming Events!

Stop by and see us in the Modern Living Building  
at the Minnesota State Fair  
August 26th - Sept 6th (Labor Day)

Next Dome Tour - Saturday, October 2nd, 2004  
[Click here for more info](#)  
[Click here to order tickets](#) - or call 800-733-7107

Quadruple dome complex going up near San Diego this summer

**A 20 year old Natural Spaces 40' diam low profile dome was lifted off its foundation intact and**

trucked down the road 30 miles to its new site - west of Des Moines, Iowa. Click here for [PICTURES](#)

**DOMES RAISINGS coming up near:**

Rob - Pittsburgh, PA. - Sept. 15th, 16th, 17th  
Shelly & Phil - Freeman, MO. - Sept. 25th & 26th  
Margie & Larry - San Antonio, TX. - Oct. 2nd & 3rd

**Contact us for more details on how to participate in these events.**

**[NEW ITEM!!! Construction DVD - recently re-edited](#)**

**[Click here](#) to find out about the dramatic increase in lumber prices.**



46' mid profile - Minn.

**[About Us](#)**

**A short bit on who, what, why, when, & where we are.**

**[Our System](#)**

**We think we have the most advanced, ultra-insulated, ventilated Dome Home building system available.**



46' mid profile - Maine



30' low profile/36' high profile - Colorado

**[Price List](#)**

**Click here to view our 39 page product price list.**

**["All About Domes" Catalog](#)**

**Click here to view our 54 page dome information catalog.**





Natural Spaces 36' high profile Office - Minnesota

## [The Dome Store<sup>tm</sup>](#)

**Environmentally friendly products for your dome.**

## [Earth Friendly Features at our Natural Spaces Domes Corporate Office Manufacturing Facility & Model Homes](#)



Natural Spaces 36' high profile Office - Minnesota



56' mid profile - Iowa

## [Dome Video/DVD](#)

**Tour 8 Dome Homes in our 49 minute video, AND NOW ON DVD!!!.**

## [Mpeg Video Clips](#)

**View 15 second movie clips of Natural Spaces Model Domes. (Currently under construction)**



## [Dome School](#)

**Learn how to build your own Dome Home.**

## [Dome Tour](#)

**The worlds largest tour of built Dome Homes.**





38' high profile - NC.

## Beach Dome

A 4-story, 3500 sq. ft., 6 bedroom gorgeous Dome Home for vacation rental on Topsail Island, North Carolina.

## Dome Raisings

A listing of upcoming domes being built which you can view or help raise the dome.



56' mid profile - Iowa



40' high profile - NY.

## Under Construction

A short list of some Natural Spaces Domes under construction.

## Domes For Sale

A sometimes current list of some domes for sale, some with pictures.



40' high profile - Minn.



40' high profile - WA

## Order Form

Order literature and services. Via our secure online order form.

## Dome Plans

We will add to this section as time goes on. These plans are of existing homes along with a section on free "standard" plans.





Natural Spaces 36' high profile  
Office - Minnesota

## FAQ

(Frequently asked questions and other thoughts dispelling myths about domes)

## Dome Sizes

This shows you a picture and a side view grid drawing for each of our 16 standard size domes, plus a few other custom sizes.

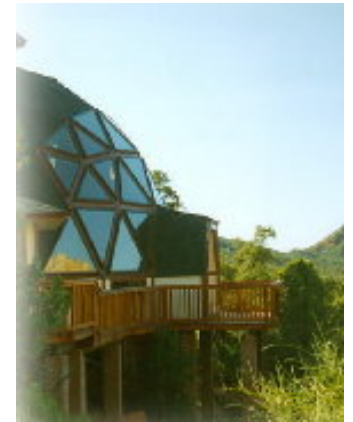

46' mid profile  
Sedona, AZ.



46' & 49' mid profile - MN

## Large domes & Special Projects

The Water Foundation represents one of our many special dome projects.

## Gazebos to Greenhouses to Garages

From 16' diam to 74' diam - domes can be used for anything.



19' 2 frequency - Minn.



45' Low profile - MN

## Links

Check out some links to other sites providing information on useful products for your dome.

## Dr. Dome™

For dome owners with sick domes or nagging, persistent dome problems, Dr. Dome has the answer.



33' high profile - Wis.





## "How much does a dome cost"

Click here to see square footage costs for our domes.

## Skylight Windows

For dome owners looking to replace their existing skylight windows, Natural Spaces Domes has the answer.



## Dome Comments

What dome owners say about living in a dome.



---

**Imitation may be the sincerest form of flattery -  
Except when you are buying the largest single purchase in your life -  
A decision affecting you and your family's future health and welfare.**

**Look closely at Natural Spaces complete dome system -  
You won't find our quality, thoughtfulness and thoroughness  
in the design and products of our imitators.**

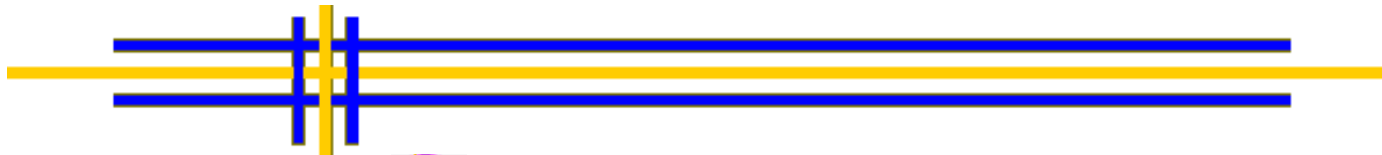

Toll Free: **1-800-733-7107**



e-mail us @ [nsd@naturalspacesdomes.com](mailto:nsd@naturalspacesdomes.com)

## **The electricity we use in our dome office, dome shops and model dome homes comes from the wind and cows**

We also produce our own heat from scrap wood  
and downed/dead trees harvested on our 50 acres.  
We're heating almost 10,000 sq. ft. of building and  
this is Minnesota! [Click here](#) for the rest of the story.



Natural Spaces Domes is a proud member of the  
Energy & Environmental Building Association



**Would you buy  
a dome home  
from this guy?  
With those curls,  
who wouldn't!!**

When it comes to experience, few can match Dennis Odin Johnson's personal involvement and commitment to domes since 1971. Dennis comes from generations of builders and craftsmen. His personal background is based on over 40 years of residential planning and building including over 30 years in domes.

**"Never separate the life you live from the words you speak"**

Paul Wellstone



Dennis Odin Johnson, owner of Natural Spaces Domes, with his son, Erik, and our Honda Insight Hybrid car.

We now have 60,000 miles on our Hybrid. 60,000 fun, problem-free and dirt cheap miles. A trip from North Branch, MN. to St. Louis, MO. (about 1400 miles) took 22 gallons for a cost of \$33 round trip. We averaged 63 MPG at freeway speeds averaging 75 MPH. The Insight never needs to be plugged in because it recharges itself! This is just another example of our life long commitment to alternative, energy efficient, earth-saving systems.

Gas prices going up? That's great news! Maybe more people will look at Hybrid vehicles and more sustainable modes of transportation.

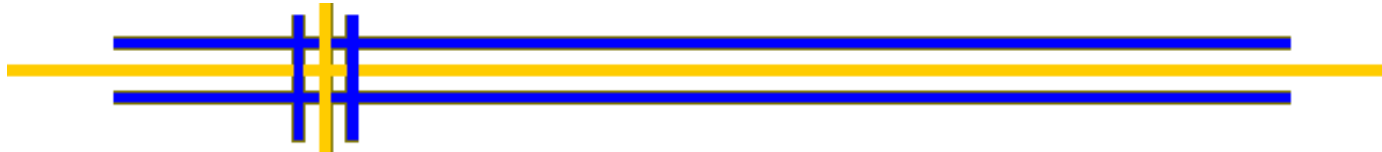

## Environmental Education

We need to educate our young people on the importance of caring for our earth. If you have children, grandchildren, nieces or nephews, sign them up for free to join this wonderful educational organization geared especially for children. Click on [Kids For Saving Earth](#)

**Janet Johnson, Co-Founder of Natural Spaces Domes,  
died from a brain tumor on August 21st, 1999.**



3/5/40 -- 8/21/99

**This site is dedicated to  
the memory of Janet Johnson;  
Senator, wife, mom, grandmother, aunt, and sister.  
Janet and her husband, Dennis, co-founded  
The Big Outdoors People Domes (TBOP) and  
Natural Spaces Domes.**

**[Go to the  
Memorial Web Site](#)**

---

**In memory of R. Buckminster "Bucky" Fuller  
July 12, 1895 - July 1, 1983**

**From his last in-depth interview 3-16-83  
Published as part of his obituary in "Rolling Stone":**

*Your ideas have not always been well received, and there  
have been some very difficult times in your personal life. In  
these times of adversity, what has kept you going?*

Really one thing - love. It's that terribly serious thing, love.  
Which you feel for your mother and your wife and the other  
people around you. I say that radiation is inherently  
disintegrative; it comes apart. Gravity is inherently integrative;  
it pulls together. And to me, there's a good possibility that love  
is what I'd call metaphysical gravity. It really holds everything  
together. In my sense of the most awful times of my life, there  
was still that love there. I knew a lot of people loved me.



**Bucky with his wife, Anne Hewlett**

---

**Senator Paul Wellstone and his wife, Sheila, were dear friends not only to myself but also friends to the American people. They spoke for the people who don't have voices in today's big business controlled government. Their deaths are not only an America tragedy, but also a tragedy for the well being of the world.**

**Paul and Sheila left behind thousands of like-minded friends. Their passion and dedication to their causes will not be forgotten. Their inspiration will become a stimulus for us, their friends. Better stewardship of this planet was part of the Wellstone's beliefs. This belief is the foundation of our company.**

**Paul and Sheila, we will "stand up and keep fighting."**

**-Dennis Odin Johnson**

**Check out "Wellstone Action" and become part of the Wellstone's' Legacy  
[www.wellstone.org](http://www.wellstone.org)**



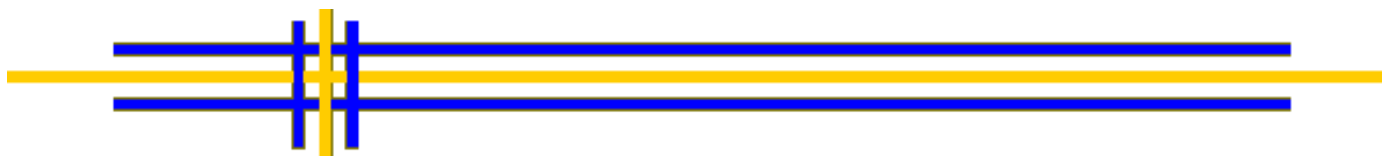

*For more information about Natural Spaces Domes...*

**Natural Spaces Domes**  
37955 Bridge Road  
North Branch, MN. 55056, USA  
(45 minutes north of the Minneapolis/St. Paul metro areas)  
[Click here for Mapquest map](#)

**Our office hours are: 8:30am - 4:30pm Monday-Friday**  
**Weekends: appointment only**



**Toll Free: 1-800-733-7107**

**Phone: 651-674-4292**

**Fax: 651-674-5005**

**-Or-**



**e-mail us @**

**[nsd@naturalspacesdomes.com](mailto:nsd@naturalspacesdomes.com)**

**©2004 Natural Spaces Domes Inc.**

***All Pictures, plans, data and information contained in these web pages are copyrighted by Natural Spaces Domes, Inc. 1978-2004. Absolutely no use or copying by any means is permitted without the express written permission from Natural Spaces Domes, Inc. After permission, any copying by any means must include a copyright notice citing Natural Spaces Domes, Inc., as the original copyright holder.***

Broken links or errors? Let us know - [nsdomes@yahoo.com](mailto:nsdomes@yahoo.com)



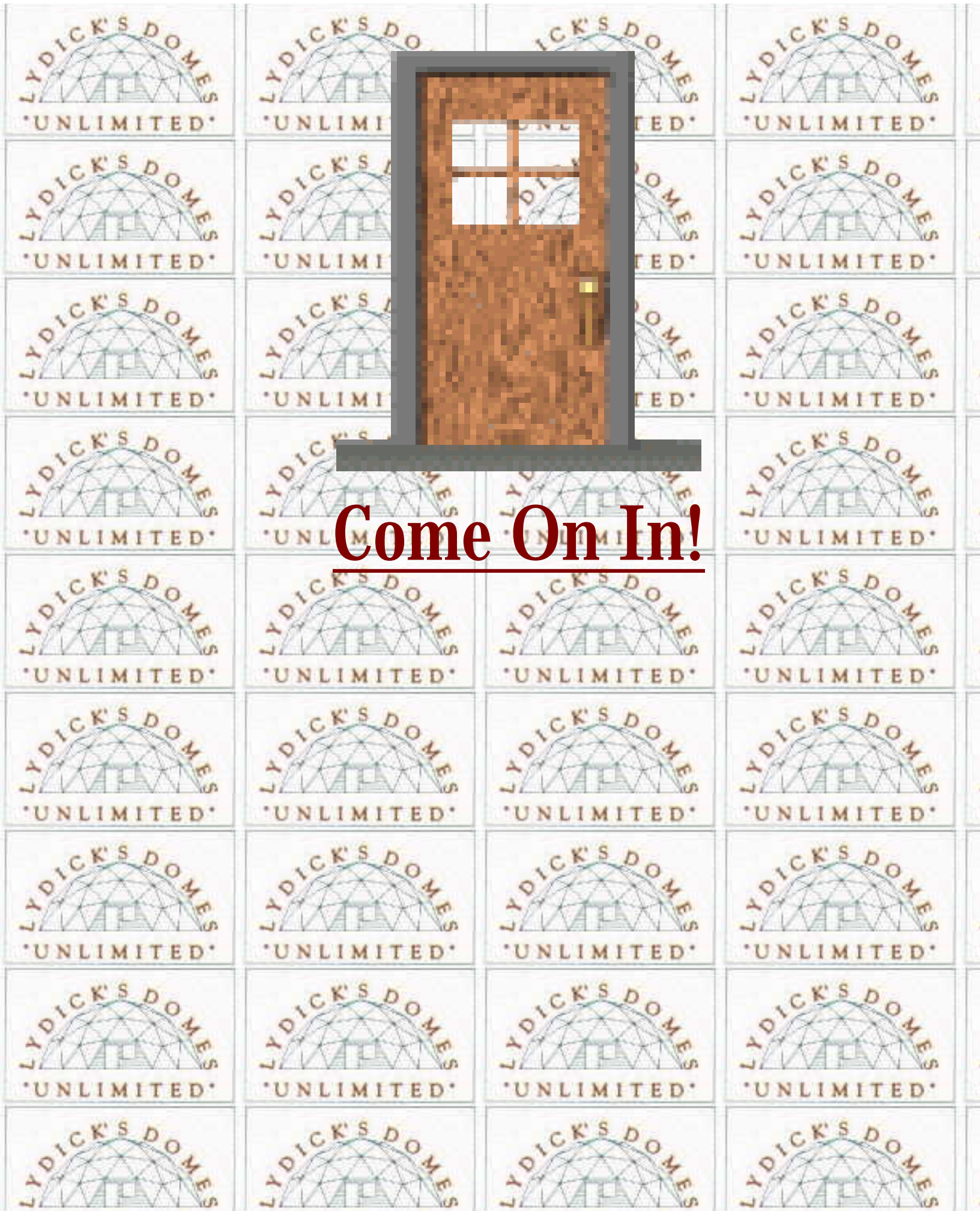

Come On In!



United States

[Home](#) | [Products & services](#) | [Support & downloads](#) | [My account](#)

[Select a country](#)

[Intellectual Property and Licensing](#)

[Patents](#)

[Technology](#)

[Trademarks and](#)

[Copyrights](#)

[Standards](#)

[Contact Us](#)

# Intellectual Property and Licensing

IBM is committed to leadership in Intellectual Property

We are committed to position IBM as the premier creator of intellectual property value.

---

## IBM leads the pack in patents

In 2003, IBM received 3,415 U.S. patents from the USPTO. This is the eleventh consecutive year that IBM has received more U.S. patents than any other company in the world. In addition to delivering these innovations through its products and services, IBM maintains an active patent and technology licensing program.

The IBM Corporation's Intellectual Property and Licensing team is responsible for licensing IBM's [patents](#), as well as other forms of intellectual property, such as [technology](#), know-how and [trademarks](#). These pages provide an introduction to IBM's licensing practices as well as a portfolio of patents and technologies currently available for licensing. If you believe your business could be enhanced by access to IBM's technologies, please [contact us](#).

[About IBM](#) | [Privacy](#) | [Terms of use](#) | [Contact](#)





# Welcome to Steve Miller's Formactive Website



Click the door to [Enter](#)

**005027**

# Newspaper Dome

Paper's just wood, right?



Once i decided that i might like to build a geodesic dome, i wanted to get a taste for how it would all go together, without spending money or much time. I ran across a page suggesting [making the struts out of newspaper](#), but i promptly ignored that page and got started rolling up newspapers. (It turns out that i missed the useful tip of rolling the papers on a broom handle which would have saved me a bit of CTS. Oh well.)

I made a frequency-two since i figured that would be the type of dome i'd build with EMT later. This requires 35 long pieces and 30 short pieces. (Check [Tara's Desert Domes](#) for the length ratio.) Well, it turns out that the short-to-long ratio for this dome is almost exactly the same as the ratio of the height to width of an unfolded sheet of the [San Jose Mercury News](#). This is great --- no cutting, no folding, just make sure to roll 35 sheets one way and 30 the other.

(The next week the Merc changed their paper format so the ratio is no longer right. It was suggested that i write an angry letter to the editor about this. Maybe i'll just change my subscription to a paper with a better height-to-width ratio.)

As each sheet was rolled, i put one staple in each end to keep them from unrolling. After all 65 struts were ready, i used a drill to put a small hole near each end. Then i used standard office-supply brads to connect the struts.

The long pieces were a bit wobbly because rolling the pieces that way made the center crease a weak spot. However it was still impressive for something made of newspaper.

It would have been nice to keep it around for Rael to play in, but i failed to follow sound advice to take it off the lawn overnight. The next morning the dew had sogified the thing and it collapsed. I

just took out the staples and brads and threw it in the recycling bin. Talk about environmentally-friendly structures!

This was a lot of fun and convinced me to go for it and make an EMT dome. And Rael now knew more about geodesic domes than most adults.



[Back to the main page.](#)

# Home Dome



## Purpose

This geodesic dome is intended to be a comfortable temporary structure for about 2 to 4 people to sleep and lounge in. Though i'm building it for Burning Man, it could be useful for some other multi-day car camping expedition. (For example, Burning Man next year.) I stayed in it for a week at Burning Man 2001 and it was comfortable and nice to have all that space.

It's also fun to set up in the backyard for parties and so on.

## Frame

The frame is a frequency-two alternate geodesic dome. The struts are made from 3/4 inch "EMT" metal conduit, and the lengths of the struts (and therefore the size of the dome) were chosen to minimize waste (and the number of cuts) given that EMT comes in 10-foot lengths. This leads to the not-too-uncommon 8.2ish-foot radius size. This means 35 pieces (plus extras) of conduit, which are about \$2.30 each from Home Depot.

One of the biggest advantages of geodesic domes is the redundancy: lots of identical pieces. When you manufacture the struts, you'll be doing the same thing over and over and over, so it's definitely worth your time to make decent jigs to "automate" all the measuring and alignment. Check the [links](#) page for some nice photos of jigs. Mine were too ugly to photograph but did the job.

The other way to take advantage of the redundancy is by making some spares of everything. My gut says 5% to 10% is probably about right. Just in case some struts get bent (or you made them a bit too short or long) or bolts get lost, you'll be glad you've got a couple of extras on hand.

To cut the conduit, i bought a small pipe cutter for \$8. This was worthwhile, except that i noticed that as i cut more, the cuts started to spiral. What was happening was that the screw-pin holding the round cutter-blade was coming loose. However i didn't figure that out until after it fell out into the grass never to be seen again. Now i have to buy a whole new pipe cutter, at least that one was cheap. Next time i'll remember to check that pin frequently. In summary, the cutting was relatively easy, and the pipe cutter made nice clean cuts. I should also mention that i used a measuring jig (just marker lines on the workbench) to speed things considerably.

To squash the ends flat, first i [read up on what everyone else was doing](#). Based on their experience i decided to spend a few bucks on a tool, in this case a 6-ton benchtop hydraulic shop press which i got from [Harbor Freight](#) (search for "shop press") for \$70. (I couldn't find any other sources for this, if anyone knows of any please tell

me.) This thing is actually a car jack in a special steel frame, so when you pump the jack a piston pushes down. You put a pair of iron plates (included) under where the piston goes (the bottom plate rests on the frame) and your victim goes between the plates and gets pinched between them. Each edge of the plates is a different shape (small round, large round, V-shape, or flat) but you want to use the large round edge. My "jig" for getting the squashed length right was just a piece of white electrical tape on the inside of the bottom plate at the right distance from the edge (1.5 inches). Of course, i followed the 45-degree seam recommendation and used a jig with a slot to make both squashed ends squashed in the same plane. I'm glad i got the shop press, but it's still a lot of back-straining work to squash that many ends. I was glad to finish that part of the job and get back to surfing the web for a while.

The next step was drilling the ends. Again, i plunked down some bucks for a tool, mostly because i don't have a drill press and it could be genuinely useful for plenty of other stuff (like building bigger geodesic domes). I bought a \$99 Ryobi from Home Depot, mostly because i like intimidating other Americans with my dead-on pronuciation of the word "Ryobi". Also i bought a couple of titanium drill bits that are of the size just barely larger than 3/8 inch (the bolt size), we want a tight fit here. For the first ends, i drilled 3/4 inch from the conduit end, and for the other ends i used a jig with an upside-down bolt to hold the first hole in place as suggested by many. I checked [here](#) (because i am too lazy to calulate cosines myself) to see how much extra length to allow between holes --- for this case it was only about 1/8 inch. I included it in my measurements, but doubt that this is worth worrying about, really. While drilling, after a while i got smart and taped a sheet of clear plastic around the drill to cover as many degrees surrounding the drilling area as possible, and tucked the sheet under the drill press --- this really made cleaning up those metal slivers easier since the flyaways were fewer. It seemed like no matter how i adjusted the RPMs on the drill press, i never could get the bit to really bite into the metal well. I think i need to learn more about drilling metal.

The final manufacturing step is bending the ends to the right angle. Follow the advice of those that tell you not to sweat the precise angle --- the ends will bend to the exact angle they need to at assembly time. But do bend them to about the right angle because this helps make assembly easier. Use a "stop block" jig to make it easy to bend to about the right angle. For this dome that means just try to bend them all to about 17 degrees. I used a woodworkers' vise to do the job.

I liked the idea from [here](#) to use carriage bolts instead of hex-head, which makes the outside surface smoother and less likely to snag or rip the covering. I got 3/8 inch by 2 inch zinc carriage bolts. Even though some recommend 2.5 inch to make assembly easier, i found that 2 inch was perfectly adequate and is of course safer since less bolt sticks out inside. Also i ain't no bolt expert but i almost bought galvanized hardware until i realized that it's something like 3 times as expensive as zinc, and this seems like the easiest part to replace if it really does ever corrode. One twist with these carriage bolts is that they have a square profile (bigger than the 3/8 shank of the bolt) just inside the head, so they can bite into wood i guess. Since that would mash up the soft conduit metal pretty badly, i put two zinc 1/2 inch flat cut washers on the head end to stand off the head just enough so that the square part doesn't bite into the conduit. (Washers are cheap by the box.) On the inside of the junction, one 3/8 inch fender washer (fits the bolt exactly) protects the conduit on that side, and a plain hex nut holds it all together. I noticed some slippage between the bolt head and the first 1/2 inch standoff washer while tightening, so i think i will add a lock washer there. One more detail is that you'll need a deep socket to tighten that nut from the indide, with the bolt end protruding into the socket.

Assembly of the frame is pretty straightforward. Help from one other person is very useful at a couple of points in the process. For this dome, something a couple of feet tall to stand on (but not a ladder) is needed to reach the top. The best suggestions are finish one layer at a time, and leave the socket wrench aside until all the pieces are in place, then tighten eveything, highest bolts first.

Yeah, yeah, it's strong, you can climb on the vertices, blah blah blah. You've already seen this on all the dome sites. But have you seen one person hanging on another person hanging on the dome? (See above.)

## Entrance modification

See [this page](#) to find out how this is done. Here is the calculation of the specific strut lengths for this radius dome.

Dome radius is 8.372 feet. Declination (from top) of apex is 40 degrees, i.e.  $8.372 \times \cos(40) = 6.413' = 6' 4'' 15/16$ .

| Strut           | Strut ratio<br>(ratio of hole-to-hole-length<br>to dome radius) | hole-to-hole<br>length | Pipe cut length<br>(hole-to-hole-length plus<br>2 times 3/4" excess) |
|-----------------|-----------------------------------------------------------------|------------------------|----------------------------------------------------------------------|
| Top (qty. 2)    | 0.38722                                                         | 3.242' = 3' 2" 14/16   | 3.367' = 3' 4" 6/16                                                  |
| Middle (qty. 2) | 0.62014                                                         | 5.192' = 5' 2" 5/16    | 5.317' = 5' 3" 13/16                                                 |
| Bottom (qty. 2) | 0.88167                                                         | 7.381' = 7' 4" 9/16    | 7.506' = 7' 6" 1/16                                                  |

Note middle and bottom pieces from stronger conduit as explained on the other page.

## Covering and floor

I don't have time to do anything as elaborate as [this](#), maybe in the future. I thought i would just try to use a single silver tarp with clips like [this](#). (I think being rainproof is essential for a living structure in the desert and wouldn't want to use a parachute.)

In the end what i actually did was to buy some silver/black tarps from [Thor Tarp](#). (Thor calls them "[DuraShield 6500](#)".) I got one 20-foot by 30-foot tarp, which was positioned over the dome so that the entrance in the front and a ventilation opening in the back were not covered. Then to close the vent opening i had a 6-foot by 8-foot tarp, and to close the entrance there were two 8-foot by 10-foot tarps that could overlap a bit at the centerline. All three small tarps were tucked under the big tarp (which overlapped them a bit) to keep any rain out. All the tarps were bungeed to the frame liberally (i used 10 or more bungees) and the long ends of the big tarp, which were on the ground anyway, were weighted down very well from the inside. This photo gives you some idea - you can see the front and back openings all opened up for the daytime heat.



For the floor i had a piece of carpet which will cover a good bit of the area. Underneath that i put a piece of plastic covering the whole circle, just to keep things clean. In retrospect, the plastic probably didn't make any difference for carpet that got dumped anyway. (My concern originally was that the playa dust would work its way up through the carpet, but that didn't happen in other domes that i was in.)

## Anchoring

Most suggest using U-shaped or J-shaped rebar hammered over the base struts (maybe every other one) for anchoring the dome frame in harsh playa conditions where winds can be amazingly strong. Not only do you have to bend the rebar, but rebar is notoriously difficult to get in and out (U/J-shaped doubly so), and the idea of using a sledgehammer so close to the somewhat fragile conduit struts frankly scares me somewhat. After some thought and reading about screw anchors, i thought that a good solution would be to place a screw anchor at the location of every 3rd (4th?) base vertex, rotating its eyelet opening toward the dome surface, then use an extra-long bolt (and maybe extra washers) to make that eyelet part of the vertex. (Note that since the eyelet is facing the right direction every 180 degrees of rotation, it will be at most one-half helix frequency too high, which amounts to probably an inch or so for a typical screw anchor.) That's right, the dome is bolted directly to the playa. No rebar, no rope... This seems like a great idea in theory but read on. (More information on screw anchors is [here](#).)

Well, after hauling screw anchors out to the desert, i was pretty glad to have access to rebar as a backup, because the screw anchors just didn't work. Specifically the problem was that the anchors would not hold; they would pull out with little force even when carefully screwed down 2 or 3 feet. The year i tried this (2001) the playa floor was

unusually crumbly due to irregular climate that year (lack of rain had kept the playa from getting its annual packing-down after the fluffing-up from the frost), but i'm convinced that this wouldn't have worked well under normal circumstances on the playa. From now on i'll plan on using straight rebar with rope.

On the other hand if you are planning to install a dome someplace where the ground will hold screw anchors well (i.e. not "Lake" Lahontan) you could still try this idea.



[Back to the main page.](#)



# Recharge Dome



## Purpose

This dome is intended to be a large shade structure for lots of people to lounge in. With a 32-foot diameter circle floor (with full headroom everywhere), even with furniture strewn about it is pretty comfortable for more than 25 people.

This page avoids repeating information on [this page](#). You should really read that page first.

## Frame - Struts

As with the smaller dome we use 3/4" EMT cut to lengths averaging about 5 feet. The goals with the struts are:

- Keep the average strut lengths at 5 feet. We will get two struts (plus sometimes some small amount of waste) from each 10-foot piece.
- For each end of each strut, we need to add the following length past the intended hole location to find the pipe cut location: 3/4" for the extra squashed metal, plus extra length to overcome the loss due to bending. However we find that for this frequency dome, the bend angles are 7 to 9 degrees, and two (for each end) times 3/4" times  $(1 - \cos(8 \text{ degrees}))$  is an insignificant 1/68 inch, so we'll ignore that. Therefore for each strut we'll add 1.5" to the hole-to-hole length to get the pipe cut length.
- We want to end up maximizing the number of 10-foot pieces which are only cut one time, i.e. not cut a second time to remove a waste piece. This minimizes both the number of cuts and the waste, and therefore maximizes the size of the dome.

To solve this puzzle first go to the frequency-four table on [this page](#) to get the strut quantities and hole-to-hole-length ratios. It's a really good idea to make spares, maybe 4 spares each of the C's and D's (there are more of them), and 2 spares of each of the others. However, because the entrance modification i'm planning to do replaces 2 C's, 2 D's, and 2 E's, i'm going to only make 2 spares of the C's and D's. (I don't want to eliminate all the spares of E's in case the entrance

modification is not used some point in the future.) So now i am going to just have 2 spares of each length.

Whew, still with me? Here's the fun part. Next we notice that if the B's and C's are around 5 feet long, their strut ratios are so close to each other that the length difference is nearly a measly 1/8 inch. If you take advantage of this lucky fact, you can just plan to let that extra 3/4" outside the hole on each end of the strut be 3/4" plus 1/16" on each end - this will work fine, in fact the variations in that end bit will be more than 1/16" anyway. This means you will cut the B's and C's the same length, and only differentiate between them later. Now from playing with different permutations of sums of pairs of strut ratios, you can get the following cutting plan which i believe is optimal:

| Struts to cut from each 10-foot conduit | Quantity of 10-foot conduits | Comment                           |
|-----------------------------------------|------------------------------|-----------------------------------|
| C + D                                   | 62                           | cut C's as if they were B's       |
| B + D                                   | 10                           | actually the same as previous cut |
| B + B + waste                           | 11                           |                                   |
| A + E + waste                           | 32                           |                                   |
| F + F + waste                           | 16                           |                                   |

Things to notice:

- There are 131 total 10-foot lengths needed
- 72 pieces are cut once and have no waste. 59 pieces require 2 cuts and have some waste.
- To do the first 3 lines of this table, just cut 83 pieces off at the B length. Then pull 11 pieces back out of the D pile and cut those at the B length.

And one final important detail: what are the lengths? And hey, what the heck is the size of this dome, anyway? Since  $B + D =$  a whole 10-foot piece, you use the strut ratios for those two pieces to solve:  $X * (0.29524 + 0.31287) + 0.125 + 0.125 = 10$ . (The 0.125 values are the total excess --- 2 times 3/4" --- for each strut.) This gives you  $X = 16.0333$  feet as the dome radius, which you can then multiply by each strut ratio (or enter into the [Dome Calculator](#)) to get the hole-to-hole lengths. Then remember to add the excess back in to get the pipe-cut lengths.

| Strut letter | Color code on <a href="#">assembly diagram</a> | Quantity (including 2 spares) | Strut ratio (ratio of hole-to-hole-length to dome radius) | Hole-to-Hole length  | Pipe cut length (hole-to-hole-length plus 2 times 3/4" excess) |
|--------------|------------------------------------------------|-------------------------------|-----------------------------------------------------------|----------------------|----------------------------------------------------------------|
| A            | yellow                                         | 32                            | 0.25318                                                   | 4.059' = 4' 0" 11/16 | 4.184' = 4' 2" 3/16                                            |
| B            | red                                            | 32                            | 0.29524                                                   | 4.734' = 4' 8" 13/16 | 4.859' = 4' 10" 5/16                                           |
| C            | blue                                           | 62                            | 0.29453                                                   | 4.722' = 4' 8" 11/16 | 4.847' = 4' 10" 3/16                                           |

|   |        |    |         |                        |                       |
|---|--------|----|---------|------------------------|-----------------------|
| D | green  | 72 | 0.31287 | 5.016' = 5' 0"<br>3/16 | 5.141' = 5' 1" 11/16  |
| E | purple | 32 | 0.32492 | 5.210' = 5' 2"<br>8/16 | 5.335' = 5' 4" 0/16   |
| F | orange | 32 | 0.29859 | 4.787' = 4' 9"<br>7/16 | 4.912' = 4' 10" 15/16 |

Two useful doublechecks are that the pipe-cut lengths of B and D add to 10 feet, and that as promised B and C differ by only 1/8 inch.

One practical tip i figured out after many difficult cuts: open up the pipe cutter and put a drop of oil on each of the three pins that the three rotating thingies (2 rollers and a blade) rotate on. It really makes cutting about 5 times easier.

## Frame - Entrance Modification

See [this page](#) for the full details of how to do this. Here are the calculations for the strut lengths for this radius dome.

Dome radius is 16.033 feet. Declination (from top) of apex is 66 degrees, i.e. 16.033 times  $\cos(66)$  = 6.521' = 6' 6" 4/16.

| Strut    | Strut ratio<br>(ratio of hole-to-hole-length<br>to dome radius) | Hole-to-Hole<br>length | Pipe cut length<br>(hole-to-hole-length plus<br>2 times 3/4" excess) |
|----------|-----------------------------------------------------------------|------------------------|----------------------------------------------------------------------|
| Top C    | 0.1914                                                          | 3.069' = 3' 0" 13/16   | 3.194' = 3' 2" 5/16                                                  |
| Top D    | 0.2012                                                          | 3.226' = 3' 2" 11/16   | 3.351' = 3' 4" 3/16                                                  |
| Middle C | 0.3301                                                          | 5.292' = 5' 3" 8/16    | 5.417' = 5' 5" 0/16                                                  |
| Middle E | 0.3458                                                          | 5.544' = 5' 6" 8/16    | 5.669' = 5' 8" 0/16                                                  |
| Bottom D | 0.4381                                                          | 7.024' = 7' 0" 5/16    | 7.149' = 7' 1" 13/16                                                 |
| Bottom E | 0.4463                                                          | 7.156' = 7' 1" 14/16   | 7.281' = 7' 3" 6/16                                                  |

Note the middle and bottom pieces are made from stronger conduit as described on the other page.

## Frame - Assembly

See [this assembly diagram](#). The entrance modification will be for one of the large bottom hexagons. (Notice that there are only two types of bottom hexagons: larger ones and smaller ones that are even more asymmetric. Half of the bottom hexagons are twins of others mirrored in the opposite direction.)

## Frame - Assembly Bottom-Up (Attempt)

On August 11, 2001 some of us gathered in Precita Park in SF to see how far we could get assembling the dome. At some points there were as many as 7 people working on it, but the average work was probably more like 4 people for 3 hours. The bottom 76% of the pieces were put together, though it's worth noting that when building from the bottom up it gets **much** harder to put the higher pieces on. Anyway, this gave some idea how much work would be involved to do the whole thing, plus we learned to avoid one major mistake: make sure you're looking at the right color on the assembly diagram (orange/yellow and blue/purple are confusable).

Here are some photos of the extent of the assembly. Click to enlarge.



This attempt convinced me that bottom-up was not the way to go. Read on...

## Frame - Assembly Top-Down

Just after the bottom-up attempt, my brother gave a book about Bucky Fuller, in which i found the following bit of wisdom (referring to construction of another dome-type structure): "Units were built from the top down by pulling the assembly up a temporary mast as parts were added at the bottom. The mast-hoist method kept most workers on the ground, speeding the work and reducing the risk of injuries. Bucky would use this top-down building tactic repeatedly in the future." Specifically, with this dome, this technique would allow never having to take a nut off of a bolt to add more struts, which had consumed much time and energy with the bottom-up attempt. Each vertex could be assembled once, and only revisited to do a final tightening on the nut.

This made perfect sense to me, but how would i make a temporary mast for this dome? After hours of online research, i found a solution. There is a materials lift, the [Genie SLC-18](#), which is perfect for the task, and readily available for rental at many equipment rental shops. (An older model, the SL-18, is essentially the same.) It lifts up to 650 pounds to a height of 18 feet. (I weighed the dome struts and calculated that with hardware the weight should be under 600 pounds.)

To get started, you set up the lift in the center of where the dome should be. You construct the top pentagon, with all the extra struts hanging down from it (in other words, a total of 25 struts) around the mast of the lift, so that the mast is going up through one of the triangles of that top pentagon. Then, with one continuous piece of rope (rated to well over one-tenth of the total dome weight; i used 400-pound "truck" rope) you rig the five outer vertices of the top pentagon to the lift, hanging under the fork. The top vertex should be centered very well on the lift in the left-right direction, and as close as possible to the mast in the in-out direction while leaving a little room for the dome to sway (say, 3 inches clearance). The top vertex should be as high as possible, since it will eventually be 16 feet high but the fork only goes up to 18 feet high (well, not even quite that high) --- and keep in mind that your rope will stretch more after more load is placed on it. Using one continuous piece of rope allows you to easily adjust the assembled struts to be as close to level as possible, and also allows the load to be perfectly distributed between the five vertices, which is highly desirable. Do take the time to make sure the height, centering, and leveling are as good as you can get them before going on since its difficult or impossible to fix this later. The photos below (taken after more than just the initial 25 struts were assembled) show how the rigging should look. It's worth mentioning that Genie makes a boom attachment which would be better than the standard fork attachment, but it seems most rental places don't have it. If you use the fork just make sure your rigging is tied to the back part of the fork --- not the sides, from which it could slip off.



[Click to enlarge.](#)

Next you start building one layer at a time. For each layer, you should first lay out all the struts needed to complete a new vertex at each new vertex location. Then, alternating working on each side in order to keep the dome as balanced as possible, hold together all the struts at a new vertex in about the right place, and add the nut and bolt to hold it all together. At this point the nut should be secure, but loose enough so that the down-hanging struts can rotate a little bit into place for the next layer. After all the new vertices are put together, the nuts of the vertices just above that (the previous layer you did) should now be tightened fully since all struts at that vertex are now held in exactly the right positions. Then, you use the lift to raise the dome up enough to do the next layer. This photo shows the dome partially assembled. The bottom vertices' nuts are loose, but all the nuts higher than that are fully tightened.



[Click to enlarge.](#)

One pitfall we ran into the first time we did this was that one of the vertices above the layer being worked on went concave (popped in) while the dome was partially assembled. To fix that, one person lashed a rope around the troublesome vertex, and pulled it out (while everyone else tugged the dome in the other direction) and held it out while the layer below was assembled. After that layer was assembled, the structure was stable at the previously-concave vertex.

Another slight problem was that the rigging was tied slightly too low --- maybe 4 inches too low for the maximum lift height. When we got to the bottom layer, one person had to lift up a little on one spot on the dome while others placed the very bottom struts in their vertices. This was not too bad, but it would have been better to have tied it up to the right height in the first place.

After the last nut is tightened (hooray), get out your 16-foot stepladder (uh, you have one, right?), untie the rigging rope, and carefully detach the fork so that you can shimmy it through a top triangle and bring it down the ladder. (See photo below.) Then lower the lift and take it out through the entrance. All done.



[Click to enlarge.](#)

It's worth it to use the lift at disassembly time too. You do the assembly procedure backwards ---

crank up the lift mast all the way, shimmy the fork through a top triangle and attach it to the mast, tie up the rigging rope as before, and then start unbolting verteces one layer at a time, lowering the lift after each layer. You can take off each layer very quickly (we even had two wrenches going). Compare this to disassembling bottom down, for which you would have to keep moving the ladder (or scaffolding) around, and struts would be dropping from high up.

## Covering

I must confess that when it came time to put the covering on all i did was watch, but here's the basic description. A 50-foot cargo parachute was used. First it was pulled over the frame using rope, the tall ladder, and long poles to occasionally poke the chute in spots where it got stuck on the outside of vertices. (The smooth carriage bolts kept snags to a minimum.) After it was centered on the frame (with a convenient vent hole top center), excess was folded over on itself on one side because the chute was slightly too large.

It was attached to the frame at one out of every (maybe) 8 vertices, where the attached vertices were evenly spaced over the surface. The attachment method required a large washer (or other round object) and two zip-ties (AKA cable ties) --- a handful of fabric was bunched up near the vertex, a washer was tossed into the bunch from the exterior, a zip-tie was used to trap the washer inside, then the washer (now trapped inside the fabric) was zip-tied to the frame's vertex. This is not a great picture but might give you some idea.



[Click to enlarge.](#)

At the bottom, the chute was rolled up inside to leave the bottom row of traingles uncovered. This is critical for ventilation in the desert heat. Before it was rolled up the temperature started rising fast inside.



## Anchoring

As described [here](#), stright rebar and rope was used.

## Floor and Amenities

With carpeting on the floor and several couches inside, all i can say is that this was the best place to be in the middle of the day in the sizzling desert heat. At night, with a floor lamp lighting the interior, it was cozy. The only thing that would have made it better would be a water-mister (or air-conditioning!) to keep the heat down.

## Costs

Here are some notes about costs for the materials. Fortunately i had already bought the shop press and the drill press. And we already had the chute from previous year's structures.

| Item and quantity                                  | Cost (incl. tax and/or shipping) |
|----------------------------------------------------|----------------------------------|
| 3/4 inch EMT conduit 10-foot lengths, quantity 132 | \$322.18                         |
| 1 inch EMT conduit 10-foot lengths, quantity 2     | \$8.10                           |
| 1-1/4 inch EMT conduit 10-foot lengths, quantity 2 | \$10.74                          |
| Pipe cutter                                        | \$9.69                           |
| Screw anchors, quantity 10                         | \$42.12                          |
| Hardware (bolts, washers, nuts)                    | ???                              |
| Titanium drill bit                                 | \$15                             |
| Spray paint for color-coding pieces                | \$22.83                          |
| Strapping tape for bundling pieces                 | \$9.05                           |
| Grand total                                        | \$439.71 + ???                   |



[Back to the main page.](#)

# Screw Anchors



You can read about [why i didn't end up using screw anchors on the playa](#) here. But since i went to the trouble of writing up this page on screw anchors i thought i'd keep it. These things seem to go by many names, such as "screw-in ground anchors", "sand anchors", and others.

Though i'd never heard about this type of screw anchor before i started doing research for building these domes, they seem like a great idea, if they are suitable for your ground conditions. They are recommended for use on the playa by [Bob Stahl \(search this page for "ground anchors"\)](#) who knows what he's talking about. (Though note that [once i got out there they didn't work for me.](#) ) He specifically mentions 40-inch anchors with a 3.5 to 4 inch helix, but there are smaller sized anchors out there far cheaper, and for a dome it's probably better to use a larger smaller anchors instead of fewer longer anchors, however of course each anchor needs to be big enough to actually hold securely in the playa. For that reason i'm avoiding the 15-inch ones (pictured top left). I will be using the 25-inch ones which are available for about \$3.50 each, since that way i can afford to get plenty of them. 30-inch would be good if i could find them at about the same price. One spec i found claims 2500 pounds of holding force for the 30-inch heavy duty ones, not too shabby.

From a bit of poking around online, it looks like the only manufacturer of these things is [A. B. Chance Co.](#), but don't bother going to their website if you're looking for a place to buy their product. The only places i can find selling the anchors online (except for too-small ones for holding up soccer goalposts) are:

- I used to have 15 hardly used ones for sale cheap. However they have gone on to a much more interesting life, with a couple of adventures. See the update below.
- [Major Surplus & Survival](#): they currently have only 25-inch ones with a 1-inch shaft, pictured at the upper right of this page. Their site doesn't specify the helix diameter but if the

photo is accurate and the shaft really is 1-inch, it looks like the helix is about 4 inches or more, great for playa use. The price is 3 for \$10. Try [this link](#) to go directly to the item or search their online store for the word "anchor".

- [ourhouse.com](#) has a surprising selection of these for a silly online store --- search for "anchor". Currently they have a 40-inch (pictured below - 1 1/2" eye, 5/8" shaft, 4" helix) for \$10.61, a 30-inch heavy duty (1" eye, 1/2" shaft, 4" helix) for \$6.79, a 30-inch (1" eye, 7/16" shaft, 3" helix) for \$5.49, and a 15-inch (pictured above left - i wouldn't use this, it's only rated to 200 pounds - 1" eye, 7/16" shaft, 3" helix) for \$4.49. However i fear this dot com will be a dot bomb soon (one of their VCs is [Redpoint](#), that's a sure kiss of death : ) ), or will pull this item as it can't possibly be a big seller for them. Update: ourhouse.com is dot gone.

If you know of a store that sells these, online or a local supply store, i'd love to hear about it to add to this list.

One tip i read somewhere said to start the anchors by digging a small hole in the surface first. I imagine that this helps the helix to bite into the ground well to start. I'll definitely be trying that.

The other tip (this one is more of a requirement) is to insert a bar or pipe through the eyelet to get turning leverage.

Update May 2004: the screw anchors have gone on to far better things than my little dome project. Here are the two subsequent owners of the screw anchors, after i gave them away (i prefer to think of it more like sponsorship :)



[Back to the main page.](#)



# Modifying Dome Geometry for a Larger Entrance Triangle

## The general idea

The EMT domes shown in these pages have strut lengths around 5 feet. This means that the entrance or entrances to these domes will end up being whatever triangle(s) at the bottom is/are biggest. That means a triangle that's more or less a 5-foot-sided equilateral triangle. It is tiresome and uncomfortable for people to stoop to fit through this, plus it is impossible to move large objects (like furniture) through this opening.

It is nicer to have a larger opening, but at the same time it should be stronger than every other part of the dome, otherwise it will be the weak spot where the dome will collapse and fail, meanwhile all the strength of the other 99% of the pieces won't contribute to the strength of the dome. In particular, I have seen suggestions for modifying a hexagon (or pentagon) at the base by removing all the radial pieces in the center, or replacing them with some unstable geometry like a quadrilateral --- of course the dome will fail when those modifications fail.

My proposal is to modify the strut lengths (but not the geometry) of the minimal number of struts by the minimal amounts in order to enlarge one base triangle to a comfortable size. Specifically, you select a hexagon at the base with the highest central point (that is, the point where the 6 radial struts inside the hexagon come together) and "move" that central point upward by a couple of feet while keeping that point on the radius of the imaginary sphere that touches all the dome's vertices. This point should be moved just high enough to provide a big-enough entrance triangle but no higher, to avoid modifying the structure any more than necessary. (Note: I say select the hexagon at the base, but it might be possible for certain frequencies that there is a pentagon at the base with a higher central point than any of the hexagons. If that's the case, you would use that pentagon. On this page I refer to the hexagon because that's the right answer for the domes I've looked at.) Because of symmetry there will actually be several hexagons which could serve this purpose, you can of course pick any one of them.

I refer to the process of "moving" that vertex as "perturbing" in the rest of this page. To visualize this better, skip down to the pictures below.

Note that when this vertex is perturbed upward, the top 2 radial struts touching this vertex shrink in length, the middle 2 lengthen slightly, and the bottom 2 lengthen a lot. Lengthening the struts will weaken this part of the dome, unless you use stronger conduit. Since the rest of my domes are 3/4" EMT, I will be using 1" for the middle struts and 1 and 1/4" for the bottom ones. It's better to err on the side of overdoing this and make those four lengthening struts stronger than they need to be to completely avoid this being the weak spot in the dome.

Now the tricky question is what the new lengths of these 6 struts are. The rest of this page answers that question.

## Software Tools

To find the exact modified strut lengths, I modified [Richard J. Bono's DOME software](#) as described at the bottom of this page to give the answers. Since this software optionally outputs in a format ready for rendering by [POV-Ray](#) I took advantage of that to visualize the modification and verify I was doing the right thing.

Note that the apex of the enlarged triangle is at the height found by multiplying the dome radius by the cosine of the angle theta of that perturbed point. Specifically, theta is the angular declination from the top of the dome, and is the same standard theta as in the usual polar coordinate system. In the tables below I refer to the cosine of theta as the entrance apex factor, so that you can easily multiply it by the dome radius to get some idea whether the opening is big enough.

When DOME creates output for POV-Ray, it does so with two files: a top-level file named myfile.pov (whatever name you told it to use) which actually just contains globals about the colors and view, then includes a second file which is always named DOME.INC which contains the actual geometry. I didn't like the default view globals in the myfile.pov file so I [made my own](#) which was used to render the pictures below.

## Frequency-2 modification

For the frequency-2 dome we see that all the hexagons at the base are identical and also right-left symmetric. As the point to perturb, i picked (radius, theta, phi) = (1, 58.2825, 36). Due to the left-right symmetry you shouldn't perturb the phi of this point; only theta was modified.

Example command lines for the modified DOME software are:

- To output the original dome geometry:

```
dome -f2 -s -z-0.001 -v mydome.pov
```

- To perturb to theta = 40 degrees:

```
dome -f2 -s -z-0.001 -qft58.2825 -qfp36 -qtt40 -qtp36 mydome.pov
```

(Note that the -qfr and -qtr radius values aren't specified here since they default to 1.)

I only tried theta = 40 and 45 degrees because for my 8.372-foot radius dome, \ theta = 40 provided an entrance apex of 8.372 times 0.766, or 6.41 feet which seems adequate. That is, i chose the theta = 40 line of the table below. Here are the strut ratios found for that value of theta = 40 and 45 (and the original unmodified for comparison).

| theta in degrees   | entrance apex factor =<br>cosine(theta) | Top 2 struts' strut<br>ratio | Middle 2 struts'<br>strut ratio | Bottom 2 struts'<br>strut ratio |
|--------------------|-----------------------------------------|------------------------------|---------------------------------|---------------------------------|
| 58.2825 (original) | 0.5257                                  | 0.6180                       | 0.5465                          | 0.6180                          |
| 45                 | 0.7071                                  | 0.4422                       | 0.5867                          | 0.8093                          |
| 40                 | 0.7660                                  | 0.3872                       | 0.6201                          | 0.8817                          |

Here are POV-Ray renderings of the original and modified geometry. Click for larger pictures.

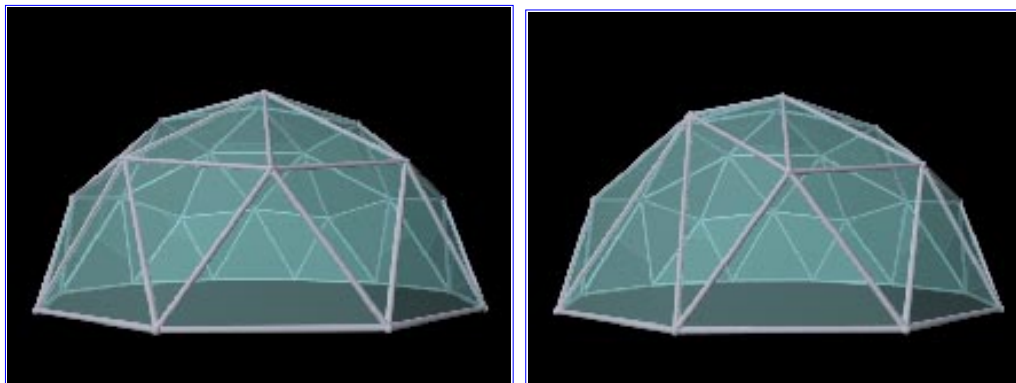

## Frequency-4 dome

At the base of the frequency-4 dome, there are 4 kinds of triangles: 2 kinds that are slightly shorter, and 2 kinds that are slightly taller. The taller ones are left-right mirror images of each other but are not left-right symmetric. (The same is true of the shorter ones but we don't care about them.) As the point to perturb, i picked (radius, theta, phi) = (1, 73.9549, 26.2677). Due to the slightness of the left-right asymmetry, i didn't bother perturbing phi but you could perturb it slightly if you knew what you were doing. I did of course perturb theta though.

I refer here to the modified struts partly using the letter code for the strut each replaces, for clarity. It's also a good idea to mark these struts the same way as the ones they replace (consistent color coding, for example) to eliminate confusion at assembly time.

Example command lines for the modified DOME software are:

- To output the original dome geometry:

```
dome -f4 -s -z-0.001 -v mydome.pov
```

- To perturb to theta = 66 degrees:

```
dome -f4 -s -z-0.001 -qft73.9549 -qfp26.2677 -qtt66 -qtp26.2677 mydome.pov
```

(Note that the -qfr and -qtr radius values aren't specified here since they default to 1.)

I only tried theta = 66 degrees because for my 16.033-foot radius dome that provided an entrance apex of 16.033 times 0.4067, or 6.52 feet which seems adequate. Here are the strut ratios found for that value of theta (and the original unmodified for comparison).

| theta in degrees      | entrance apex factor<br>= cosine(theta) | Top C strut<br>ratio | Top D<br>strut ratio | Middle C<br>strut ratio | Middle E<br>strut ratio | Bottom D<br>strut ratio | Bottom E<br>strut ratio |
|-----------------------|-----------------------------------------|----------------------|----------------------|-------------------------|-------------------------|-------------------------|-------------------------|
| 73.9549<br>(original) | 0.2764                                  | 0.2945               | 0.3129               | 0.2945                  | 0.3249                  | 0.3129                  | 0.3249                  |
| 66                    | 0.4067                                  | 0.1914               | 0.2012               | 0.3301                  | 0.3458                  | 0.4381                  | 0.4463                  |

Here are POV-Ray renderings of the original and modified geometry. Click for larger pictures.

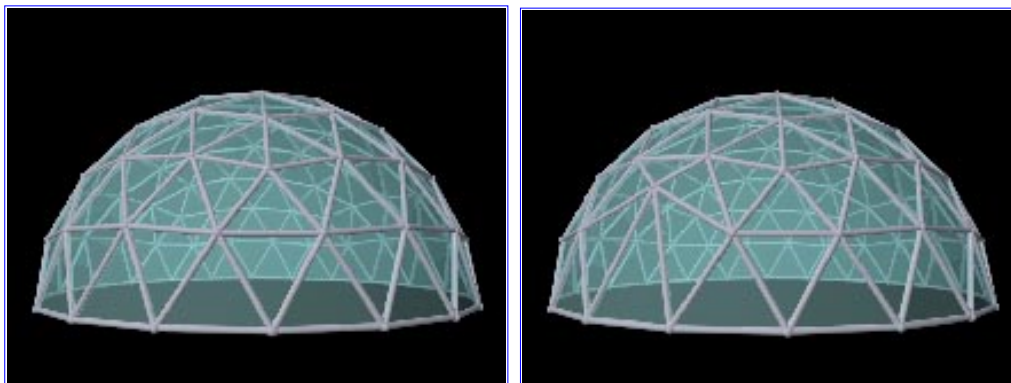

## Using the software tools to do this yourself

First you'll need to [download my modified version of the DOME software](#). You might want to [download the original version of DOME v4.6 from here](#) or from the source ([Richard J. Bono's DOME software](#)) if possible. That way you can diff the source code to see the simple modifications i did.

Note that the code i added only really works for POV output in sphere (-s) mode, which is probably how you want to use it anyway. Here are the changes i made:

- Caused the POV output (the DOME.INC file, specifically) to contain safe lines (POV-script comments) informing you of the spherical coordinates of vertices ("point"), and lengths of struts ("strutlength"). Note that these lines get printed after the real POV-script they correspond to. Also, it's very important to note that the DOME program sometimes repeats points, struts, or triangles in its output, and depends on POV-Ray to deal with it safely.
- Added the -z flag to allow discarding stuff below a certain threshold of z-value. This lets you produce the data for a dome instead of a full sphere. For an even-frequency hemispherical dome you would choose a z-threshold just barely below 0. For other configurations you should examine the coordinates of a full sphere or experiment.
- Added the -qft etcetera flags to allow perturbing one point. Read the usage text for the full details.

If you want to modify and rebuild the code on windows, you can use [cygwin](#) with the included makefile. In fact the build in the zip file i made depends on some of the cygwin DLLs so you'll need it anyway unless you want to rebuild the source some other way.

[Back to the main page.](#)

# Links

Of everything i know about this topic at this point, 99% is a redigestion of what i've found elsewhere online. Here are the essential sources you'll want to read through.

|                                                           |                                                                                                                                                                                                                                                                                                                                                                                                                                                                                                                                            |
|-----------------------------------------------------------|--------------------------------------------------------------------------------------------------------------------------------------------------------------------------------------------------------------------------------------------------------------------------------------------------------------------------------------------------------------------------------------------------------------------------------------------------------------------------------------------------------------------------------------------|
| <a href="#">Tara's Desert Domes</a>                       | <p>Go here first. The best site for information on building EMT domes. Includes all the geometric information (strut ratios, number of pieces, assembly geometry) for frequency 1 through 6 alternate domes, both as tables/charts, and also in the form of slick javascript calculators. "<a href="#">Conduit Dome Tips</a>" page is the essential step-by-step walkthrough of how to do it. I suspect that this site is responsible for the existence of most of the EMT domes in the free world.</p>                                    |
| <a href="#">Howard's Home Dome</a>                        | <p>An excellent walkthrough of a dome construction with some good ideas not found in <a href="http://www.desertdomes.com/">http://www.desertdomes.com/</a>, including using carriage bolts to avoid an outside surface that snags/cuts the covering, and a nice shelf added to the interior of the structure. Good shots of the shop setup and jigs. As his next project this guy is spearheading the construction of a <a href="#">giant nose-shaped structure also made of EMT triangles</a> --- i'm looking forward to seeing that.</p> |
| <a href="#">Michael J. Gourlay's Geodesic Dome Design</a> | <p>Yes, this guy is a geek. Good discussion of how much extra length to add to account for the bending at the end (answer: probably not enough to worry about in practicality, but it's good to know that) and an idea for an entrance modification. He also has a useful <a href="#">step-by-step walkthrough</a> of how he made his dome.</p>                                                                                                                                                                                            |
| <a href="#">Tamara Munzer's Dome for Burning Man</a>      | <p>Very good step-by-step for this large dome which has a somewhat detailed design for the covering, plus an interesting "rain hat" top vent. Good ideas if you have more time and want to make your dome nicer. Lots of excellent photos. For once, someone from Stanford doing something useful. ;)</p>                                                                                                                                                                                                                                  |
| <a href="#">Jeff Deifik's Geodesic Dome Construction</a>  | <p>This guy mostly followed the Desert Domes instructions, but he's got nice photos of his shop jigs. Nice simple covering with a single tarp. If you're intimidated by the idea of making a dome, this guy makes it look easy.</p>                                                                                                                                                                                                                                                                                                        |
| <a href="#">Spacelounge EMT dome plans</a>                | <p>Quick and dirty EMT dome plans from <a href="#">SpaceLounge</a>. Maybe not much in here that's not in <a href="http://www.desertdomes.com/">http://www.desertdomes.com/</a>.</p>                                                                                                                                                                                                                                                                                                                                                        |
| <a href="#">Bob Stahl's Temporary Desert Structures</a>   | <p>Bob Stahl is something of a guru when it comes to construction techniques for the playa. Be sure to read the section "Stakes and anchors" which mentions screw anchors.</p>                                                                                                                                                                                                                                                                                                                                                             |
| <a href="#">Robert Conroy's conduit domes</a>             | <p>Photos of some more EMT domes with little explanation.</p>                                                                                                                                                                                                                                                                                                                                                                                                                                                                              |
| <a href="#">YES Mag's newspaper dome plans</a>            | <p>More newspaper dome foolishness. Be careful, this website is done by Canadians, so be sure to convert the ratios from metric, eh?</p>                                                                                                                                                                                                                                                                                                                                                                                                   |



[Burning Man](#)

Why are all of these people building geodesic domes, anyway?

[Back to the main page.](#)

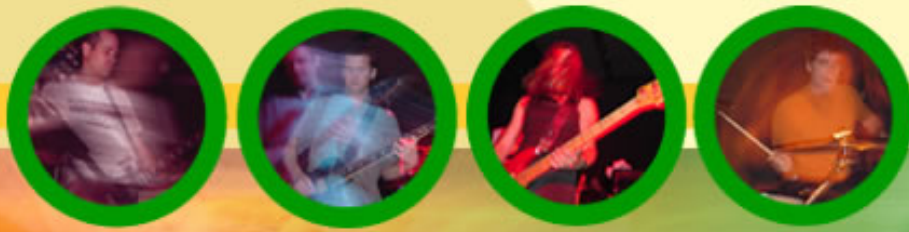

# superchunk.com

[news](#) [tours](#) [discography](#) [galleries](#) [sounds](#) [press](#) [links](#) [message board](#) [contact](#)



 © 2004 superchunk  
design by spacious mind





Find by Keyword:

Find Item Number:

[Free Catalog](#)

[Free Retail Flyer](#)

[Search](#)

[Order from  
Printed Catalog](#)

[About Us](#)

[Retail Stores](#)

[Customer Service](#)

[Inside Track  
Club Members](#)

[Security](#)

[Employment](#)

[Open an Account](#)

[Sale Items](#)

[Recall Safety  
Information](#)



**Live Help!**  
 Mon-Fri  
 9 am - 4 pm  
 Pacific Standard Time

To place an order  
 Call Toll-Free  
 24 Hours a Day!  
 7 Days a Week!  
 800-423-2567  
 Customer Service  
 800-444-3353  
 International  
 (Not Toll Free)  
 805-388-3000

**America's Favorite Tool Store**

**HUGE SAVINGS!**

**Specials**

CEN-TECH  
 6" DIGITAL CALIPER



Item No. 47257-5VGA  
**\$15.99**

RYOBI  
 15" GAS TRIMMER



Item No. 55008-1VGA  
**\$49.99**

CHICAGO ELECTRIC  
 120 AMP, 115 VOLT FLUX AND MIG  
 WELDER



Item No. 6098-2VGA  
**\$174.99**

CENTRAL PNEUMATIC  
 4-1/2 HP 21 GALLON CAST IRON  
 VERTICAL COMPRESSOR



Item No. 47065-2VGA  
**\$169.99**

U.S. GENERAL  
 3000 LB. CAPACITY  
 LIGHTWEIGHT ALUMINUM  
 RACING JACK



Item No. 91039-2VGA  
**\$79.99**

CENTRAL PNEUMATIC  
 8 TO 10 GAUGE 28 DEGREE ANGLE  
 FRAMING NAILER



Item No. 46240-7VGA  
**\$99.99**

CHICAGO ELECTRIC  
 880 LBS. ELECTRIC HOIST



Item No. 44006-7VGA  
**\$74.99**

CENTRAL PNEUMATIC  
 HEAVY DUTY RETRACTABLE  
 AIR/WATER HOSE REEL WITH  
 HOSE



Item No. 46104-8VGA  
**\$39.99**

CHICAGO ELECTRIC  
 2000 LB. CAPACITY WINCH



Item No. 90282-1VGA  
**\$49.99**

CHICAGO ELECTRIC  
 BREAKER HAMMER WITH  
 PORTABLE CASE



CHICAGO ELECTRIC  
 ELECTRIC CHAIN SAW  
 SHARPENER



1/2" EARTHQUAKE IMPACT  
 WRENCH



**FREE**

Receive:  
 Discounts,  
 Coupons,  
 Specials.

[CLICK HERE](#)

**What's**

**HOT**

[CLICK HERE](#)

**OneStop  
 Gardens.com**



Quality Gardening  
 Merchandise.

**Woodworking  
 Plans  
 Kits  
 Crafts**

Lowest Prices  
 Guaranteed.

[atkitscraftsplans.com](#)



Item No. 46935-5VGA

**\$359.99**

Item No. 40208-4VGA

**\$64.99**

Item No. 02623-5VGA

**\$69.99**

# U.S. GENERAL

**500 LB. CAPACITY 12V WINCH POWERED HITCH LIFT**

*To place an order  
Call Toll-Free  
24 Hours a Day!  
7 Days a Week!  
800-423-2567*  
Customer Service  
800-444-3353  
International  
(Not Toll Free)  
805-388-3000



*To place an order  
Call Toll-Free  
24 Hours a Day!  
7 Days a Week!  
800-423-2567*  
Customer Service  
800-444-3353  
International  
(Not Toll Free)  
805-388-3000

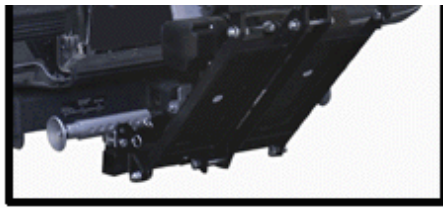

Item No. 47591-5VGA

\$399.99

**\$199.99**

**U.S. GENERAL**

13 DRAWER INDUSTRIAL QUALITY ROLLER CABINET



Item No. 90320-3VGA

\$499.99

**\$459.99**

**U.S. GENERAL**

7 DRAWER END CABINET FOR ROLLER TOOL CHEST



Item No. 90321-0VGA

**\$199.99**

---

**CENTRAL PNEUMATIC**  
**11 GAUGE ROOFING NAILER**



Item No. 41209-9VGA

\$199.99

**\$99.99**

---

**CHICAGO welding**  
**ELECTRIC systems**  
**AUTO-DARKENING WELDING HELMET**



Item No. 46092-7VGA

\$99.99

**\$49.99**

**CENTRAL MACHINERY**

**3-1/2 CUBIC FOOT CEMENT MIXER**



Item No. 31979-1VGA  
\$249.99

**\$189.99**

**CHICAGO**  
**Electric Power Tools**

**2.5 HP, 10" INDUSTRIAL TILE/BRICK SAW**



Item No. 46225-2VGA  
\$299.99

**\$199.99**

**ACT NOW TO CASH IN ON SAVINGS!**

We have reduced the prices on a whole line of tools just when you need them most!  
Check here for incredible deals on some of our best tools! HURRY-Some quantities are limited.



**ORDER NOW! OUR SITE IS SAFE AND SECURE!**



**America's Favorite Tool Store™**

[Home](#) | [Review Order](#) | [Free Catalog](#) | [Search](#) | [Links](#) | [Retail](#)

[Customer Service](#)

© copyright 2003 Harbor Freight Tools, All Rights Reserved.

# Geodesic Dome Covering Assembly

[Intro](#) | [Schematic](#) | [Real Life Pictures](#) | [Tarp Holders](#) | [Metal Grommets](#) | [Tiedowns](#) | [Rain Hat](#) | [Assembly](#) | [Design Choices](#)  
[Dome Home](#) | [Struts](#)

---

## Intro

The dome covering is made of several heavy-duty tarps, custom cut and grommetted. We wanted something that would withstand rain, wind, and heat. The tarps are shingled so that rain can't run through into the living space. The side pieces can be rolled up and tied back for airflow on hot days. There's also a hole on the very top for airflow, and it's covered by a raised plastic hat so that rain can't get in. The shingled ends are all lashed down to the bottom struts so that it's under tension, which minimizes flapping in the wind. We get internal tension from plastic snap-on grommets, which are used to anchor the tarps to the vertices.

---

## Schematic

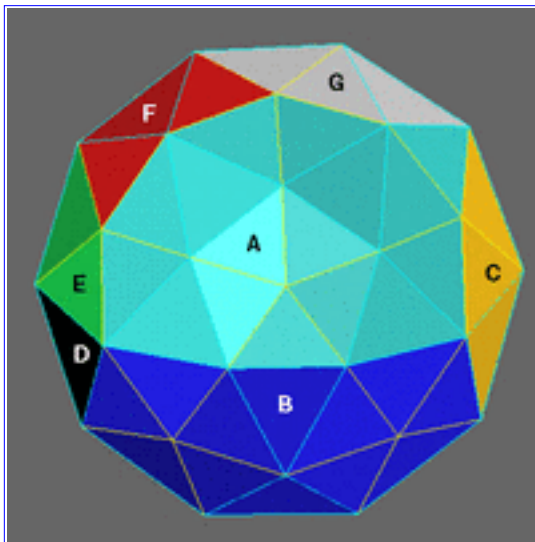

This picture shows the basic plan, shown in a wormseye view without any shingling overhangs. The biggest piece (A/cyan) covers the top, plus one triangle on the bottom layer. The medium sized B/blue piece covers one whole side of the dome. The other small pieces cover the bottom ring of triangles. Conceptually, it's four parallelogram pieces of three triangles each, plus a door triangle (D/black). But the geometry of the A tarp lets it cover one of those bottom triangles, so one of the bottom pieces (E/green) only covers a two-triangle strip. Two of the parallelograms are (G/white, C/yellow) short-side up, one (F/red) is long-side up.

Here's more pictures, showing a walk around the structure from the sides, and then a birdeye view:

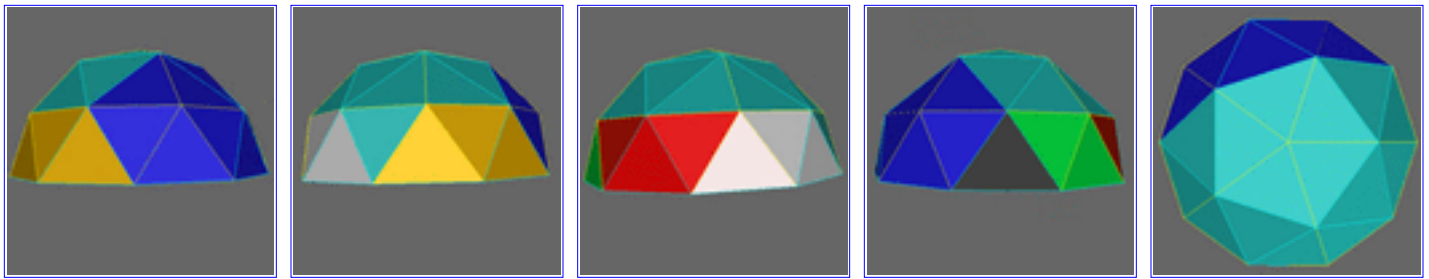

## Real Pictures

These pictures show the real coverings, overhangs and all.

- Top Piece (A/cyan)

Note that the overhangs are at least a foot everywhere, and they're all more or less horizontal. The hole at the top allows airflow, critical in the playa heat. (The plastic rain hat isn't up yet in these pictures.)





- Side Piece (B/blue)

The big side piece covers 12 triangles, and the bottom is lashed down permanently. (As opposed to the smaller bottom-row pieces, which are often rolled up for ventilation.)



- Bottom-Row Pieces

This is one of the top-short trapezoids (G/white):



Here's side piece C/yellow, the one closest to B/blue, before and after taking down the top tarp. In both pictures it's partially taken down itself.



- Whole Thing

Finally, here's a few shots of the whole thing before covering with tarps,



and after. You can make a simple door triangle, which can either be tied back out of the way or tied shut when you're asleep or gone.



---

## Tarp Holders

We used tarp holders to secure the tarp to the vertices, since they don't create holes in the tarp that would let in rain like [metal grommets](#). They're blue plastic thingies that you can buy in outdoor stores. We loop a cabletie through the hole in the tab to lash it to a vertex.



The problem with these tarpholders is that they will pop out when they're under too much load. [Grip Clips](#) instead, which I might try next year.

This schematic diagram shows the location of the tarpholders. The key idea is to create tension to minimize tarp flapping, both because the sound is annoying and because uncontrolled flapping gets worse and worse as the wind tears the covering apart. On the big top tarp, the first set of holders goes right below the top pentagon. We also use holders along the bottom row instead of just lashing with metal grommets so that we can have the rain-proof overhang. The only nonobvious thing about the side tarp is the holder in the middle of the center bottom triangle, which is there to secure a fold necessary to fit the rectangular tarp to the spherical curvature of the dome.

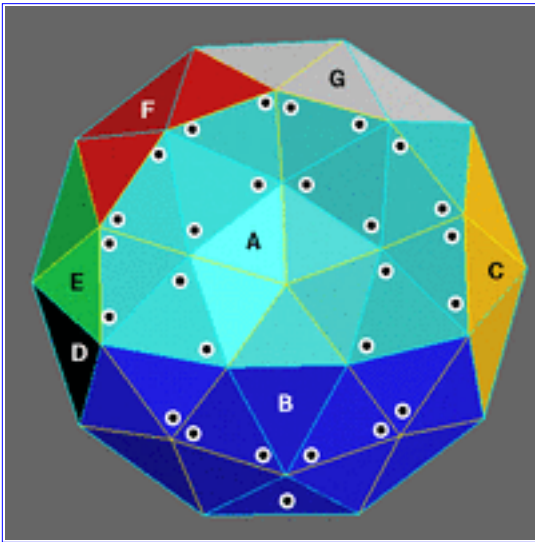

## Metal Grommets

- You can insert metal grommets anywhere that you need them if you have a grommet kit. We used size 4, which have a 1/2 inch hole.
- First you use the hole-puncher to make a hole in the right place. Make sure that you have the tarp folded over for more strength if you're doing this along an edge.
- Then put the base with the bottom grommet part underneath:
- Now take the top thing with the top grommet part, insert the tip into the hole, and then pound for a while. With a sledgehammer you need only a few blows. A normal hammer

might take a few dozen. Make sure to pound against a hard surface or else all your force gets absorbed uselessly.

- The idea is to put grommets at the right places along folds and corners so that tie-down is easy. The first time you get the tarp up on the structure, mark the places where you will put grommets, then take it back down and do so. You can use the grommets as a way to shape the tarp for the curvature of the dome by introducing permanent grommetted-together folds.



## Tiedowns

You need to tie down the overhanging parts of the tarps: keeping them as taut as possible will minimize the flapping in the wind. This is a good idea both because uncontrolled flapping can tear your structure apart, and because flapping is loud and irritating. (You can only minimize, not eliminate, the flapping - in windstorms, the noise can be scarily loud despite your best efforts!) The tiedowns also ensure that the overhang acts as a shingle to keep the rain from running through

where the bottom strips of tarps begin.

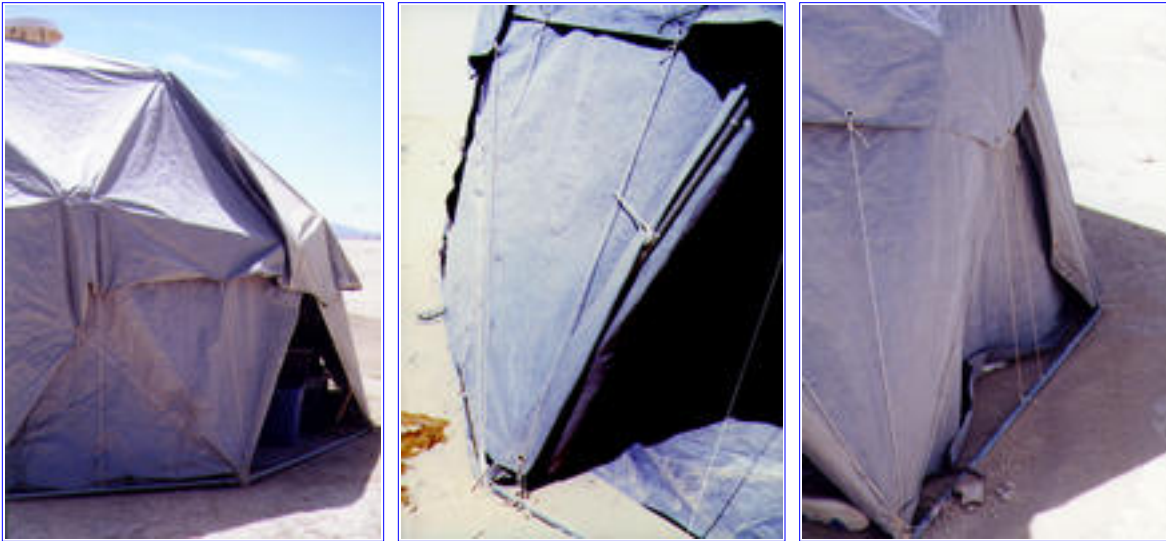

You should tie down the tarp overhangs at many points, roughly every few feet, using strategically placed grommets. I used 75-pound-test nylon parachute cord, which worked fine. You tie a grommet on top to some spot on the bottom ring of horizontal struts. The best tie-down point is a vertex, since that can give you both horizontal and vertical tension. In some places, when you only need vertical tension, you can just tie it directly to a strut.

You should loop the cord under the strut so that you can get leverage by pulling up tight against it. Tie them as tight as you can, but keep in mind that you'll probably want to go around and tighten them all up every few days or so and during major windstorms, so don't make knots that will be too difficult to take out. I just used triple half-hitches.

Keep in mind that you'll want to keep some triangles completely clear of tie-down cords so that you can easily get in and out. We had an official door triangle, but also used two or three others as main access passages when some of the bottom triangles were tucked out of the way for airflow and visibility.

The long parachute cords are tiedowns for the big overhead tarps, since there's a long distance between them and the bottom ring of struts, and they're intended to always stay tied down. The bottom strip of tarps is different: you want to have the option to move some of them up out of the way for airflow. The tops of those strips are secured to the chest-level struts with cable ties, just like the big overhead tarps. We used two-sided velcro instead of cord for most of the strip bottoms and sides, so that we can quickly fold an entire triangle out of the way. (The bottom strips are also not under nearly as much wind load as the big overhead tarps, since they're smaller, lighter, and more sheltered.) In the picture below, you can't see the velcro strips in this picture shot from the inside, but you can see how a triangle is folded out of the way.



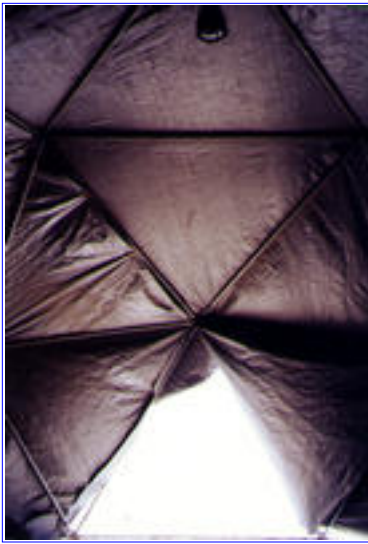

---

## Rain Hat

It's important for air circulation to have a hole in the tarp at the top of the dome. We made a little "hat" so that air could flow through but rain would not fall through. The hat is an upside-down plastic tub intended to go under a large plant pot. We drilled three holes in it for little mini-struts for attaching it to three of the five main struts that meet at the top point. Those attachments are made with the same nuts/bolts/washer setup that are at the real vertices.



The hat worked fine in 1999, but in the major rainstorms of 2000 there was a minor leak because the washer setup was not waterproof. Next year we'll try using O-rings at that spot. (The other main strut vertices don't have to be waterproof, since they're covered by tarps. These are the only ones exposed directly to rain.)

---

## Assembly

I don't have as many details here as for the [strut assembly](#), but here's a few:

1. Wrap the top five vertices to keep the sharp struts from abrading the tarps at these points where it's going to be under tension. The first year we didn't do this, and halfway through the week we patched the worn-through tarp with duct tape and stuffed towel scraps on the vertices. This year I'm going to try wrapping the struts with chamois tape - the stuff that you

can buy at sporting goods stores to wrap around the handle of a tennis racket.



2. You want to put up the big piece first. If you already have the long tie-down strings in the grommets, your life will be much easier, since you can use them to gradually pull the tarp up over the structure. Although it's almost impossible to put up this big tarp alone without the strings, it's quite possible with them. Pull each clump of two or three strings up as far as feasible and temporarily tie them off. By the time you do this with all of them, you can cycle back to the first clump and hitch it up further. It took me a couple of (leisurely) hours to get the whole thing in the right spot. With several people that will go much faster, less than a half-hour. If at all possible avoid putting this tarp up in high winds.



3. It's much easier to get the tie-down cord under the bottom ring of struts if you do it before hammering down the anchors.
4. We used one big 20x20 square tarp as a ground tarp that we just folded underneath itself to make it into a roughly 18-foot circle. The way to keep the inside dry during rains is to make sure that the ground tarp is smaller than the covered area, with a foot or two of space between the tarp and the outer ring of the struts so that the tarp always stays completely dry. Otherwise, if the ground tarp comes all the way up to the outer covering, or worse yet extends outside of it, rain that ends up on the outside fringe of the ground tarp will inevitably make its way to the middle.

The first year we were pretty dogmatic about taking shoes off on the way into the dome, which was a pain to do. The second year we were more lax (except when it was muddy), and just swept the ground tarp clean more often.

A note on disassembly: just fold up the ground tarp and then shake it out back in civilization, where random little bits of food-gunk will biodegrade. Don't shake it out on the playa! (Also, don't forget to shake it out before going back the next year - we forgot about

this and had to painstakingly clean it up with brooms when we got back to the playa in 2000, which was a drag.)

5. You can't put the rain hat up until after the big tarp (A/cyan) is up, and we needed two people to do it (at least with the size ladder we had). You first attach the top of the mini-struts to the hat, and tighten them up. You can pre-load the bolt assembly on the bottom of the mini-struts, but don't tighten anything.

Our ladder was just tall enough that one person could fit their arm through the air hole, but not their head. The second person needed to stand on the outside and throw the hat into the hand of the first person like a frisbee, being careful to keep the struts facing up. (You want the smooth plastic side of the hat to be touching the tarp, not the sharp strut ends which could tear it.)

The ladder person needs to catch the hat blind, which is doable with enough tries and yelling. Then the ladder person can turn the hat upside-down and position it so that the bottom of the mini-struts line up with the holes in the three main struts. For each mini-strut, undo the bottom washer and nut, thread the bolt through, re-fasten the bottom washer and nut, and tighten it up.

---

## Design Choices

- Each Triangle

If we didn't care about rainproofing, by far the easiest thing to do would be to have 40 triangular tarp pieces, one for each triangle. That would be simple to make, since there are only two kinds of triangles: 10 equilaterals with long (cyan) sides, 30 isocoles (with two long, one short sides). This design would work fine for shade, but rain would drip in at all the seams. Shingling doesn't work: just having some overhang between the faces isn't enough, gravity works against us on all the non-horizontal seams.

- Parachute

We vaguely thought about using a parachute since the curvature would be close to what we needed. But we didn't think they were rainproof, we couldn't find one at any nearby surplus store, and some of the ones we saw on the web were really expensive.

- Single Giant Tarp

Another possibility would be to cover the whole dome with one huge tarp, say 40'x40'. Problems: that much tarp is really heavy (70 lbs) and hard to deal with, especially in high winds. It's hard to find tarps that big, our local stores only had up to 20'x20' or 18'x24', and they're very expensive. We still would have had to do some amount of cutting and grommeting to deal with the curvature. It would have been harder to deal with rolling up the tarp covering the lowest ring of triangles for airflow, since there would be a lot of overlap because of the curvature of the dome.

- Tarp Type

We tried out the blue normal tarps, but found that they just weren't strong enough. The silver

heavy-duty ones are definitely necessary for this kind of structure. Even with these we had some problems with the sharp edges of the struts wearing away the tarp at the vertices where they're under tension last year. This year we're padding with chamois tape (the kind that you wind on the handles of tennis rackets) to try to avoid that problem, in addition to reinforcing key points with duct tape.

---

[Tamara Munzner](#) Last modified: Mon Mar 26 23:07:33 PST 2001



**THOR TARP**  
Division of ODIN INTERNATIONAL, INC.

Tarps for Home & Recreation

Tarps for Business & Industry

Tarp Specifications

View Cart

The banner features a central illustration of Thor, the Norse god of thunder, holding his hammer Mjolnir. To the right, there are two circular graphics: one showing a white tarp covering a structure, and another showing a white pickup truck with a red trailer. Below these are two yellow buttons with black text: 'Tarp Specifications' and 'View Cart'.

---

[Tarps for Home & Recreation](#) | [Tarps for Business & Industry](#) | [Testimonials](#)  
[Norse Mythology](#) | [Warranty Information](#) | [Link Exchange](#)

---



---

**THOR TARP Division of ODIN International, Inc.**  
PO Box 811, Oconomowoc, WI 53066-0811  
TOLL FREE: 888-ODIN-INC (634-6462) | TEL: 262-569-7171 | FAX: 262-569-1511



[info@thortarp.com](mailto:info@thortarp.com)

---

Copyright © 1996-2001 ODIN INTERNATIONAL, INC. All rights reserved.  
Certain names, logos, designs, titles, words or phrases on this page may constitute trademarks, servicemarks, or tradenames of ODIN INTERNATIONAL, INC. or other entities which may be registered in certain jurisdictions.  
This site is a [TallGuy](#) Production



# THOR TARP

## Pre-Finished Stock Tarps for Immediate Shipment.

All tarps below include rope-reinforced hem with grommets on 36" centers. Fill in quantity desired and follow instructions at the bottom of this form.

|           | <b>DuraShield 4500</b><br>Color: Blue<br>Weight: 3.1 oz. / sq. yd.<br>Weave: 8 x 8 / sq. in. | <b>DuraShield 5500</b><br>Color: Green<br>Weight: 4.5 oz. / sq. yd.<br>Weave: 10 x 10 / sq. in. | <b>DuraShield 6500</b><br>Color: Black/Silver<br>Weight: 6.0 oz. / sq. yd.<br>Weave: 14 x 14 / sq. in. | <b>DuraShield 7500</b><br>Color: Black/Silver<br>Weight: 8.0 oz. / sq. yd.<br>Weave: 14 x 14 / sq. in.<br>Grommets: 9/16" ID |
|-----------|----------------------------------------------------------------------------------------------|-------------------------------------------------------------------------------------------------|--------------------------------------------------------------------------------------------------------|------------------------------------------------------------------------------------------------------------------------------|
| 6' x 8'   |                                                                                              | \$3.41<br><a href="#">Add to Cart</a>                                                           | \$4.82<br><a href="#">Add to Cart</a>                                                                  |                                                                                                                              |
| 8' x 10'  |                                                                                              | \$5.52<br><a href="#">Add to Cart</a>                                                           | \$8.04<br><a href="#">Add to Cart</a>                                                                  |                                                                                                                              |
| 9' x 12'  |                                                                                              | \$7.44<br><a href="#">Add to Cart</a>                                                           |                                                                                                        |                                                                                                                              |
| 10' x 12' |                                                                                              |                                                                                                 | \$12.05<br><a href="#">Add to Cart</a>                                                                 |                                                                                                                              |
| 10' x 18' |                                                                                              | \$12.42<br><a href="#">Add to Cart</a>                                                          |                                                                                                        |                                                                                                                              |
| 10' x 20' |                                                                                              | \$13.79<br><a href="#">Add to Cart</a>                                                          | \$20.51<br><a href="#">Add to Cart</a>                                                                 |                                                                                                                              |
| 12' x 12' |                                                                                              |                                                                                                 | \$14.46<br><a href="#">Add to Cart</a>                                                                 |                                                                                                                              |
| 12' x 14' |                                                                                              | \$11.58<br><a href="#">Add to Cart</a>                                                          |                                                                                                        |                                                                                                                              |
| 12' x 16' |                                                                                              |                                                                                                 | \$19.28<br><a href="#">Add to Cart</a>                                                                 |                                                                                                                              |
| 12' x 20' |                                                                                              |                                                                                                 | \$24.11<br><a href="#">Add to Cart</a>                                                                 |                                                                                                                              |
| 12' x 22' |                                                                                              | \$18.20<br><a href="#">Add to Cart</a>                                                          |                                                                                                        |                                                                                                                              |
| 12' x 25' |                                                                                              |                                                                                                 | \$30.12<br><a href="#">Add to Cart</a>                                                                 |                                                                                                                              |
| 12' x 30' |                                                                                              |                                                                                                 | \$36.14<br><a href="#">Add to Cart</a>                                                                 |                                                                                                                              |
| 14' x 18' |                                                                                              | \$17.39<br><a href="#">Add to Cart</a>                                                          |                                                                                                        |                                                                                                                              |
| 14' x 20' |                                                                                              |                                                                                                 | \$28.70<br><a href="#">Add to Cart</a>                                                                 |                                                                                                                              |

|           |                                         |                                         |                                         |                                         |
|-----------|-----------------------------------------|-----------------------------------------|-----------------------------------------|-----------------------------------------|
| 15' x 25' |                                         |                                         |                                         |                                         |
| 15' x 30' |                                         | \$31.04<br><a href="#">Add to Cart</a>  | \$46.13<br><a href="#">Add to Cart</a>  |                                         |
| 15' x 40' |                                         |                                         | \$61.50<br><a href="#">Add to Cart</a>  |                                         |
| 16' x 20' |                                         | \$22.07<br><a href="#">Add to Cart</a>  | \$32.12<br><a href="#">Add to Cart</a>  | \$54.87<br><a href="#">Add to Cart</a>  |
| 18' x 24' |                                         | \$29.81<br><a href="#">Add to Cart</a>  |                                         |                                         |
| 18' x 36' |                                         |                                         |                                         |                                         |
| 18' x 48' |                                         | \$59.58<br><a href="#">Add to Cart</a>  |                                         |                                         |
| 20' x 20' |                                         | \$27.59<br><a href="#">Add to Cart</a>  | \$40.16<br><a href="#">Add to Cart</a>  |                                         |
| 20' x 25' |                                         |                                         |                                         |                                         |
| 20' x 30' |                                         | \$41.37<br><a href="#">Add to Cart</a>  | \$60.24<br><a href="#">Add to Cart</a>  | \$102.87<br><a href="#">Add to Cart</a> |
| 20' x 35' |                                         |                                         |                                         |                                         |
| 20' x 40' |                                         | \$55.17<br><a href="#">Add to Cart</a>  | \$80.31<br><a href="#">Add to Cart</a>  |                                         |
| 20' x 60' |                                         | \$82.76<br><a href="#">Add to Cart</a>  |                                         |                                         |
| 21' x 37' |                                         |                                         | \$79.64<br><a href="#">Add to Cart</a>  |                                         |
| 22' x 50' | \$54.06<br><a href="#">Add to Cart</a>  |                                         |                                         |                                         |
| 25' x 33' |                                         |                                         | \$84.56<br><a href="#">Add to Cart</a>  | \$141.45<br><a href="#">Add to Cart</a> |
| 25' x 40' | \$49.14<br><a href="#">Add to Cart</a>  |                                         |                                         |                                         |
| 25' x 45' | \$56.61<br><a href="#">Add to Cart</a>  |                                         | \$115.31<br><a href="#">Add to Cart</a> |                                         |
| 28' x 48' |                                         |                                         | \$137.73<br><a href="#">Add to Cart</a> | \$230.43<br><a href="#">Add to Cart</a> |
| 30' x 40' | \$58.98<br><a href="#">Add to Cart</a>  | \$82.76<br><a href="#">Add to Cart</a>  | \$120.47<br><a href="#">Add to Cart</a> | \$205.74<br><a href="#">Add to Cart</a> |
| 30' x 50' | \$73.73<br><a href="#">Add to Cart</a>  | \$103.44<br><a href="#">Add to Cart</a> | \$150.59<br><a href="#">Add to Cart</a> |                                         |
| 30' x 60' | \$88.46<br><a href="#">Add to Cart</a>  | \$124.13<br><a href="#">Add to Cart</a> | \$180.71<br><a href="#">Add to Cart</a> |                                         |
| 40' x 40' | \$78.63<br><a href="#">Add to Cart</a>  |                                         | \$160.64<br><a href="#">Add to Cart</a> |                                         |
| 40' x 60' | \$117.95<br><a href="#">Add to Cart</a> | \$165.50<br><a href="#">Add to Cart</a> | \$240.95<br><a href="#">Add to Cart</a> | \$411.48<br><a href="#">Add to Cart</a> |
| 50' x 50' | \$122.87<br><a href="#">Add to Cart</a> |                                         |                                         |                                         |

|             |                                         |                                         |                                          |  |
|-------------|-----------------------------------------|-----------------------------------------|------------------------------------------|--|
| 50' x 100'  | \$245.73<br><a href="#">Add to Cart</a> | \$344.79<br><a href="#">Add to Cart</a> | \$501.98<br><a href="#">Add to Cart</a>  |  |
| 60' x 60'   | \$176.93<br><a href="#">Add to Cart</a> | \$248.25<br><a href="#">Add to Cart</a> | \$361.41<br><a href="#">Add to Cart</a>  |  |
| 100' x 100' | \$491.46<br><a href="#">Add to Cart</a> |                                         | \$1003.96<br><a href="#">Add to Cart</a> |  |



**PRICE &  
INFO**



**HOME**



**THOR TARP**  
**Division of ODIN International, Inc.**  
 PO Box 811  
 Oconomowoc, WI 53066-0811  
**TOLL FREE: 888-ODIN-INC**  
**TEL: 262-569-7171**  
**FAX: 262-569-1511**



[info@thortarp.com](mailto:info@thortarp.com)































# CHANCE®

**Insist on the Original...**

**World Leader in earth anchoring for 94+ years**

**INSTANT FOUNDATION® Systems and Soil-Retaining/Commercial Construction and Repairs**

**PROFESSIONALS ENTER HERE**



[ENTER](#)

**PROFESSIONALS ENTER HERE**



[ENTER](#)

**HOMEOWNERS ENTER HERE**



[ENTER](#)

**About Chance®**

More than 94 years of A.B. Chance engineering experience and construction expertise with helical anchors have derived special techniques, tools, designs and sizes with unique advantages. Chance® helical anchors extend bearing plates into stable strata under expansive surface soils without significant disturbance.

A.B. Chance engineering expertise, with 1,400,000 sq. ft. of manufacturing facilities, leads the world in anchor development and quality. A.B. Chance also markets to electric and telephone utilities and the pipeline industry. For your assurance of high quality, the A.B. Chance manufacturing system has earned registration by ISO certification. When you specify Chance®, you have selected the highest caliber products from the leader of the industry. A.B. Chance, a Division of Hubbell Power Systems, Inc. [Learn more->](#)

**Standard construction practices to build on...**

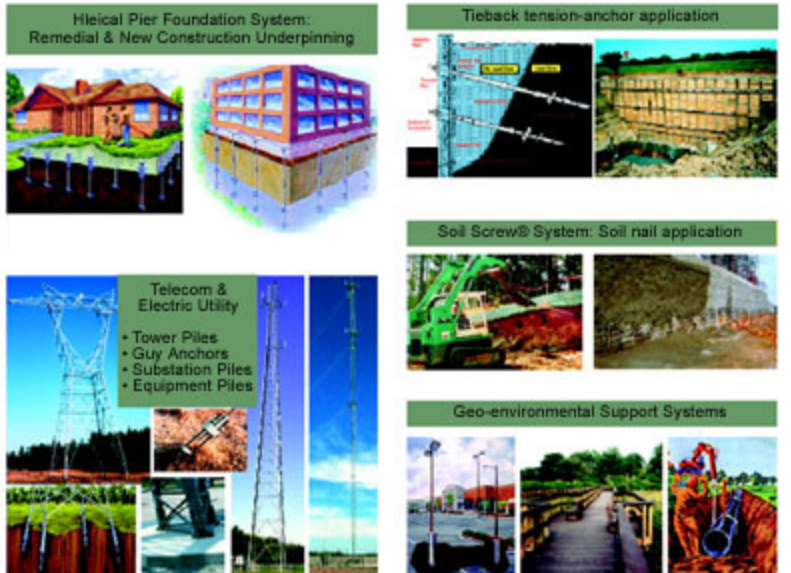

**NEW! Now in the A.B. Chance SPOTLIGHT**

Walder Foundation Products  
 A.B. Chance Distributor  
 Technical Foundations  
 A.B. Chance Contractor

**New Case Histories**

- [Richmond International Airport](#), (# 01-0401)
- [U.S.Navy Building Remodel](#), (# 01-0402)

[Enter here](#) for electric utility T&D and related products: Pole line hardware, connectors, apparatus, switches, hot line tools, etc.



Hubbell® Power Systems, Inc., comprises Anderson®, Chance®, Fargo®, Ohio Brass®.



**Power Load-Handling Tools**  
 Powered hoists and accessories for loading and handling applications.

- Gasoline-Powered Capstans (DC&AC)
- Electric-Powered Capstans
- Hydraulic-Powered Capstans

[Click here for Catalog info](#)

[Click here to locate your local distributor to order](#)



**DEALERSHIPS AVAILABLE in selective areas**



**See Free Demo!**



All contents Copyright © 2001 Hubbell Power Systems, Inc. All rights reserved.  
Because Hubbell has a policy of continuous product improvement, we reserve the right to change design and specifications without notice.



**Weekly Specials Up To 90% OFF**

[Home](#) [SuperSavers](#) [Products](#) [Free Info/Tips](#) [Shop Now](#) [Order Catalog](#)

**Wholesale  
Direct  
Pricing**

[Home](#)  
[SuperSavers](#)  
[Products](#)  
[Free Info/Tips](#)  
[Shop Now](#)  
[Order Catalog](#)  
[Search](#)  
[Feedback](#)  
[Store Location](#)  
[Major's Policies](#)  
[Links](#)



**WELCOME TO  
AMERICA'S PREMIERE OUTFITTER  
OF RECREATIONAL & SURVIVAL GEAR**



**SAVE 25%**

Military Surplus and Disaster Preparedness super on-line warehouse. Major Surplus & Survival supplies a wide variety of outdoor products for recreational, survival, and disaster preparedness needs. Our [retail store](#) and 60,000 sq. ft. warehouse are jam packed with disaster preparedness items as well as recreational camping and other outdoor products. We carry massive amounts of [military surplus](#) items good for the jungle to the Arctic. Come visit our Web site to learn how to prepare yourself for unforeseen calamities.

#### Major Specials

[SuperSavers](#)  
(updated 8/27/04)

[New Items](#)  
(updated 8/27/04)

[MREs](#)

[Gift Ideas](#)

[Survival Books](#)

[Law Enforcement](#)

## Military Surplus and Disaster Preparedness:

On-line Catalog has over 1800 different items: not counting all of the various sizes, colors, or fabric choices. Ideal for camping and survival. Military surplus mostly U.S.A. but unique items from all over the world: Russian, Swiss, French, Dutch, German. Disaster [preparedness tips](#) and supplies, water barrels, food and water storage, mylar bags, emergency kits, earthquake kits, food storage supplies, dehydrated food, freeze dried food, MREs, lamps, stoves, clothing. Checkout our [product categories](#) or go [shopping now](#).

## Camping:

If your looking for [camping items](#), you'll find the widest selection and the lowest prices at Major Surplus. When gearing up for the great outdoors, don't miss our military surplus blankets, tents, sleeping bags, food, cookware and clothing. Government quality at realistic prices. We also carry a full line of brand name camp gear. From Lodge™ cast iron cookware to Coleman™ lamps, stoves and chests. Hi-Tec™ footwear to Swiss Army brand knives and watches. Katadyn™ water purification systems to Silva™ compasses. Canteens, cots, toilets, showers and cookers.....even freeze dried camp food for trail or emergency. Whatever you need.



## Backpacks:

For hunting, fishing, camping , hiking or heading for school, try our immense [line of packs and rucksacks](#). Everything from complete military load carrying systems, Alice packs and G.I. Rucks, to simple day hikers.... we've got you covered. Save big with our military packs from around the world that offer high quality and a tremendous value in an already seasoned backpack. We offer a huge assortment of frame packs, both external and internal as well as soft packs, bladder packs and day packs.

## Sleeping Bags:

Take advantage of us on our [super sleeping bag deals](#). We have a wide selection of military surplus sleeping bags from around the world that have been field tested in all climates and all countries. Surplus sleeping bags are still your best buy.... We have them from Down-filled to Extreme Cold at prices that will astound you. To equal these quality bags in the civilian market would break the bank. If surplus savings don't interest you, take a peek at our civilian line of bags from Polyfill, Qualofill to Down...we have them all.

## Coleman Products:

is the brand of choice for backpackers, family trekkers and outdoor enthusiasts and Major Surplus carries a multitude of Coleman products to help you enjoy the great outdoors. We have dual-fuel appliances as well as kerosene and gasoline powered lanterns and stoves. If you need jugs or coolers...we've got 'em. If you need extra mantles, glass globes, hoses or valves...we've got 'em.

## Dickies Workwear:



Dickies..America's choice for quality **workwear** since 1922, from the city to the country you'll find Dickies on the job, generations have relied on the Dickies name for comfort and dependability, in fact Dickies is so comfortable it has established itself in the casual wear market with enormous popularity, Dickies, made to last in the USA....

[Top of Page](#)

[\[Home\]](#)[\[Shop Now\]](#)[\[Products\]](#)[\[Super Savers\]](#)[\[Order Catalog\]](#)[\[Major Links\]](#)  
[\[ Store Location\]](#)[\[Search\]](#)[\[Major Policies\]](#)[\[Survival Tips\]](#)[\[Feedback\]](#)

## Telephone

(800)441-8855 or (310)324-8855

## FAX

310-324-6909

## Postal address

435 W. Alondra, Gardena, CA, 90248

## Electronic mail

General Information: [info@MajorSurplusNSurvival.com](mailto:info@MajorSurplusNSurvival.com)

Sales: [sales@MajorSurplusNSurvival.com](mailto:sales@MajorSurplusNSurvival.com)

Customer Support: [support@MajorSurplusNSurvival.com](mailto:support@MajorSurplusNSurvival.com)

Webmaster: [webmaster@MajorSurplusNSurvival.com](mailto:webmaster@MajorSurplusNSurvival.com)

Best experienced with



Version 4 or above  
Click here to start.

Send mail to [webmaster@MajorSurplusNSurvival.com](mailto:webmaster@MajorSurplusNSurvival.com) with questions or comments about this web site.

Copyright © 1997, 1998, 1999, 2000, 2001, 2002

Last modified: August 29, 2004



[Store Front](#)

[Home](#)

[Our Policy](#)

**This is now our old shopping cart program. We have an all new look and shopping experience with our new shopping cart. To go to our new site [Click Here](#).**

**Furthermore, this shopping cart, were you are now, does not now, and will not be, updated with current or future catalogs and items.**

---

[Search Store](#)

[Checkout](#)

[MREs](#)

[Browse Stor...](#)



amazon.com.



VIEW CART

WISH LIST

YOUR ACCOUNT

HELP

WELCOME

YOUR STORE

BOOKS

APPAREL &amp; ACCESSORIES

ELECTRONICS

TOYS &amp; GAMES

MUSIC

GOURMET FOOD

TOOLS &amp; HARDWARE

SEE MORE STORES

[browse brands & products](#)
[top sellers](#)
[power tools](#)
[accessories](#)
[free catalog](#)
[gift ideas & wedding registry](#)
[today's deals](#)
[outlet, used & reconditioned](#)

## SEARCH

## A9 WEB SEARCH

Powered by A9.com

## BROWSE

[Add favorites](#)

Power Tools  
[Accessories](#)  
[Cordless Tools](#)  
[Drills](#)  
[Generators](#)  
[Planers](#)  
[Routers](#)  
[Sanders](#)  
[Saws](#)

▶ [All Power Tools](#)

Hand Tools  
[Clamps](#)  
[Hammers](#)  
[Multitools](#)  
[Tool Sets](#)  
[Wrenches](#)

▶ [All Hand Tools](#)

Lawn & Garden Tools  
[Blowers & Vacs](#)  
[Hand Tools](#)  
[Lawn Mowers](#)  
[Snow Blowers](#)  
[String Trimmers](#)

▶ [All Lawn & Garden Tools](#)

Job Site Equipment  
[Heaters & Fans](#)  
[Ladders & Scaffolding](#)  
[Power Supplies](#)  
[Radios](#)  
[Work Wear](#)

▶ [All Job Site Equipment](#)

More Tools & Hardware  
[Agricultural & Excavating](#)

## Greetings from OurHouse.com



OurHouse.com

As you may have heard, OurHouse.com has sold some of its assets, including our Web address, to Amazon.com. We've appreciated your support over the years, and we'd like to recommend [Amazon.com](#)

as the online retailer where you can continue to find great values on a tremendous selection of tools and hardware, kitchen and housewares products and outdoor living essentials. Thanks for everything, and happy online shopping!

▶ [Go shopping at Amazon.com](#)

## Tools &amp; Hardware

[Top Sellers in Tools and Hardware](#)

## Updated Hourly

1. [Dewalt DC9096-2 18-Volt XRP Battery Combo Pack](#)
2. [Toro 51460 7" 12-Volt Cordless Trimmer](#)
3. [Dremel 3956-02 Variable Speed MultiPro Super Kit With 77-Piece Accessory Kit](#)

▶ [Complete List](#)

[Top Sellers in Kitchen and Housewares](#)

1. [Eureka 4870DT Upright Vacuum Home-Cleaning System](#)
2. [Calphalon Commercial Nonstick 3-Quart Saute Pan with Lid](#)
3. [Calphalon Commercial Nonstick 8- and 10-Inch Omelet Pans, Limited Edition Set](#)

▶ [See more Top Sellers](#)

[Tools](#)

[Automotive](#)

[Plumbing Fixtures &](#)

[Faucets](#)

[Pressure Washers](#)

[Safety & Security](#)

[Vacuums & Dust](#)

[Collectors](#)

▶ [All Tools & Hardware](#)

Brands

[Bosch](#)

[Delta](#)

[DeWalt](#)

[Milwaukee](#)

[Porter-Cable](#)

▶ [All Brands](#)

Specialty Stores

[CarsDirect.com](#)

[Gift Ideas](#)

[Info Center](#)

[Router Workshop](#)

[Today's Deals](#)

[Woodworking Shop](#)

▶ [All Specialty Stores](#)

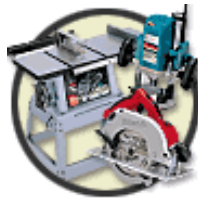

Find everything from [saws](#) and [drills](#) to [landscaping equipment](#) in

Amazon.com's [Tools & Hardware](#) store. We have all the best tools from top brands such as [DeWalt](#), [Bosch](#), and [Porter-Cable](#) at great prices, every day. Plus, you'll find buying guides and do-it-yourself projects to help you make all your home improvements.

- [Cordless Tools](#)
- [Woodworking Shop](#)
- [Information Warehouse](#)
- [Visit Tools & Hardware](#)

**Kitchen & Housewares**



Amazon.com's [Kitchen & Housewares](#) store offers the right selection of products to people

who are passionate about cooking, entertaining, and maintaining their homes. You'll discover quality kitchenware from such brands as [All-Clad](#), [Calphalon](#), [KitchenAid](#), [Cuisinart](#), [Henckels](#), and [Wüsthof](#). In addition to great products, you'll find recipes, buying guides, articles, and more.

- [Small Appliances](#)
- [Cookware](#)
- [Visit Kitchen & Housewares](#)

**Outdoor Living**



Visit Amazon.com's [Outdoor Living](#) store and peruse our assortment of the best for

outdoor enthusiasts, whether you fancy yourself king of the grill or simply delight in lounging the day

**Top Sellers in Outdoor Living**

1. [Weber 41455 20 Pound Tank Adapter Hose for Use with Weber Q and Go-Anywhere Gas Grill](#)
2. [Weber 2820 Smokey Mountain Cooker Smoker](#)
3. [Weber 22 1/2-Inch One-Touch Gold Charcoal Grill, Black](#)

▶ [See all Top Sellers](#)

away in a chaise. You'll find fine furniture collections, charcoal and propane grills, outdoor décor, and other essentials for green thumbs and beyond, in addition to buying guides, recipes, articles, and more!

- [The Weber Grill Store](#)
- [Patio & Garden Furniture](#)
- [Gifts Ideas](#)
- [Visit Outdoor Living](#)

**Selling at Amazon Marketplace**

Sell a little or a lot on Amazon.com. Become a [Marketplace seller](#) today.

**Info Center**

Visit our [Info Center](#) for buying guides, tool reviews, and more.

**Build Your Own Online OurHouse.com Store**

Sell OurHouse.com and more from your Web site. Join [Amazon.com Associates](#) today!

**Where's My Stuff?**

- Track your [recent orders](#).
- View or change your orders in [Your Account](#).

**Shipping & Returns**

- See our [shipping rates & policies](#).
- [Return](#) an item (here's our [Returns Policy](#)).

**Need Help?**

- Forgot your password? [Click here](#).
- [Redeem](#) or [buy](#) a gift certificate.
- [Visit our Help department](#).

**Search**

**for**

**Turn your past ourhouse.com purchases into \$\$\$  
[Learn more](#) about selling at Amazon.com today!**

[Top of Page](#)

[Amazon.com Home](#) | [Directory of All Stores](#)

Our International Sites: [Canada](#) | [United Kingdom](#) | [Germany](#) | [Japan](#) | [France](#)  
[Contact Us](#) | [Help](#) | [Shopping Cart](#) | [Your Account](#) | [Sell Items](#) | [1-Click Settings](#)  
[Investor Relations](#) | [Press Releases](#) | [Join Our Staff](#)

[Conditions of Use](#) | [Privacy Notice](#) © 1996-2004, Amazon.com, Inc. or its affiliates



[□ About Redpoint](#) [□ Team](#) [□ Portfolio](#) [□ News](#) [□ Contact Us](#) [□ For Entrepreneurs](#)

---

***Partners in  
Innovation***

---

August 12, 2004 Idetic, Inc. Raises \$15 Million in Series B Financing to Drive International Expansion of MobiTV [More](#)

July 27, 2004 LifeSize Communications Raises \$20M in Series B funding [More](#)

July 23, 2004 Danger, Inc. Announces \$37 Million Financing Round [More](#)

June 29, 2004 BigBand Networks Completes ADC IP Cable Business Unit Acquisition and Raises \$25 Million of Venture Capital Financing [More](#)

June 21, 2004 OuterBay Powers Sybase Dynamic Archive [More](#)

© 2002 Redpoint Ventures. All Rights Reserved.

# 2002 Burning Man Balloon Project

Floating World (8/11/02 - 8/27/02)

Last year, my friend Brian Johnson came with us to his first and my third [Burning Man](#). While it was an enjoyable experience, it felt kinda wrong not having a big project to do. We had some cool costumes and gadgets, but we felt like spectators instead of participants, and decided to return if & only if we could fix that. As usual, I had zillions of ideas afterwards, and this summer we settled on the one which seemed like the most fun with the least effort: lifting ourselves into the air with giant helium balloons. While I'd never paid much attention the Burning Man's previous themes, 2002 was going to be "The Floating World", which fit perfectly.

Now, we are by no means the first people to think of this. Many people have seen the french film [Le Ballon Rouge \(The Red Balloon\)](#). [Lawn Chair Larry](#) is a (true) urban legend, and experienced balloonist [John Ninomiya](#) has performed many "cluster balloon" flights. In fact, another team even tried to do the same thing at Burning Man this year, although they met with much less success than we did. But it sure sounded like fun.

We spent about two weeks busily preparing. Our background is in rock climbing, not ballooning, and our rig reflected that. We used climbing ropes, carabiners, and knots, and decided that the ascender would be on belay for smooth raising and lowering. Most parts of the system were redundant, except for the balloons (of which there were to be 30, so a failure was OK) and the climbing harness (which, when properly fastened, will essentially never fail). We were hoping to achieve an elevation of 100 feet, so safety was an important concern. We even contacted the Burning Man management to get permission, and they gave us a set of extremely reasonable rules to follow, such as only operating in low-wind conditions and monitoring the airport frequency.

I'll skip over the details of finding balloons that big, helium suppliers, and so forth, as logistical details are not very interesting. We'll get to the pretty pictures real soon, I promise. An important question was how we were going to attach balloons to the rig. I had originally envisioned some sort of net, but because of the size of our balloons it would have to have been huge. We also considered using rope to make simple "cages". However, when we received the balloons, the necks seemed quite strong, and able to resist a great deal of pull. Also, all the pictures on John Ninomiya's page show him suspended directly from the necks. Thus we decided to use this simple method, which proved problematic. Our main worry, besides general safety issues, was that the harsh desert environment would render the balloons ephemeral. The combination of sun, abrasive dust, and wind turned out to be even worse than we had feared.

**[More Pix, Less Talk!](#)**

**[New: Movie Montage by Alice](#)**



## Furthering marine research

through the peer efforts of scientists and engineers

### MBARI News

3 September 2004

DNA analysis shows how some deep-sea microbes limit global warming

Using a new type of DNA analysis, researchers at MBARI and the Joint Genome Institute have shown how some microbes in deep-sea sediments could consume methane, an important contributor to global warming.

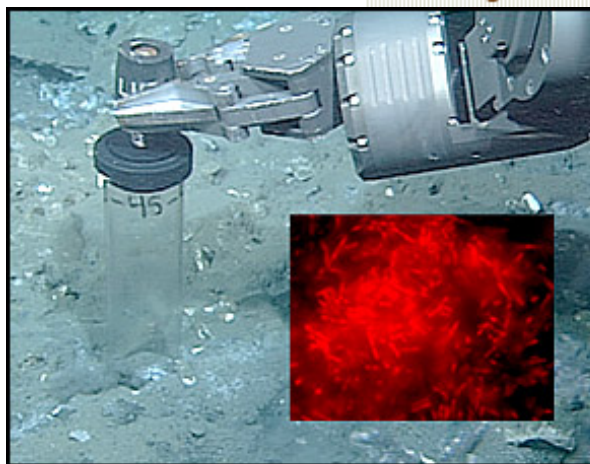

[Get the full story...](#)

MBARI's remotely operated vehicle *Tiburon* collects a push core of deep-sea mud from the Eel River Basin, offshore of Northern California. The inset shows methane-consuming microbes from the sediment core.



Ocean Observing System Instrument Network Infrastructure [Workshop](#) set for September.

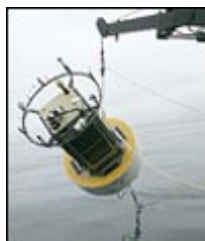

[\\$2.4 million grant](#) supports collaborative oceanographic project. [More on CIMT project.](#)



A seismic sensor package is deployed on the seafloor during the current Northwest Expedition. [Read the daily cruise logs.](#)

- [Press room](#)
- [Archive of previous home page stories](#)

- [2004 research projects](#)
- [Employment](#)

[Visit the Monterey Bay Aquarium website](#)

MBARI  
7700 Sandholdt Road  
Moss Landing, CA 95039-9644 USA  
Tel: (831) 775-1700 Fax: (831) 775-1620



© 2004 MBARI • [Terms of Use](#)

```
//POV-Ray script --- generated by DOME 4.60
#include"colors.inc"
#include"shapes.inc"
#include"textures.inc"
#include"dome.inc"
#declare Cam_factor = 2.0
#declare Camera_X = 1 * Cam_factor
#declare Camera_Y = 0.04 * Cam_factor
#declare Camera_Z = 0.1 * Cam_factor
camera { location <Camera_X, Camera_Y, Camera_Z>
    sky <0,0,1>
    look_at <0, 0, 0.5> }

object { light_source { <Camera_X + 1, Camera_Y + 1 , Camera_Z + 1> color White } }

#declare EdgeTexture=
texture{
    pigment{Silver}
    finish{
        specular 1
        roughness .00002
        ambient .3
        diffuse .5
        crand .0005
        reflection .15
    }
}

#declare PointTexture=
texture{
    pigment{Silver}
    finish{
        specular 1
        roughness .00001
        ambient .3
        diffuse .5
        crand .0005
        reflection .15
    }
}

#declare FaceTexture=
texture{
    pigment{Turquoise filter .5}
    finish{
        specular 1
        roughness .00005
        ambient .3
        diffuse .7
        crand .005
        reflection .15
    }
}

//object { sphere { <0, 0, 0>,50000 }
//    hollow
//    texture {
//        Black
//        scale <80000, 50000, 30000>
//        finish { crand .05 ambient .7 }
//    }
//}
declare Dome=
union{
```

<http://dome.zillabit.com/myglobals.pov>

```
object {DomeEdges no_shadow texture{EdgeTexture}}
object {DomePoints no_shadow texture{PointTexture}}
object {DomeFaces no_shadow texture{FaceTexture}}
}
object{Dome rotate <0, 0, 0> }

//End Pov Script
```

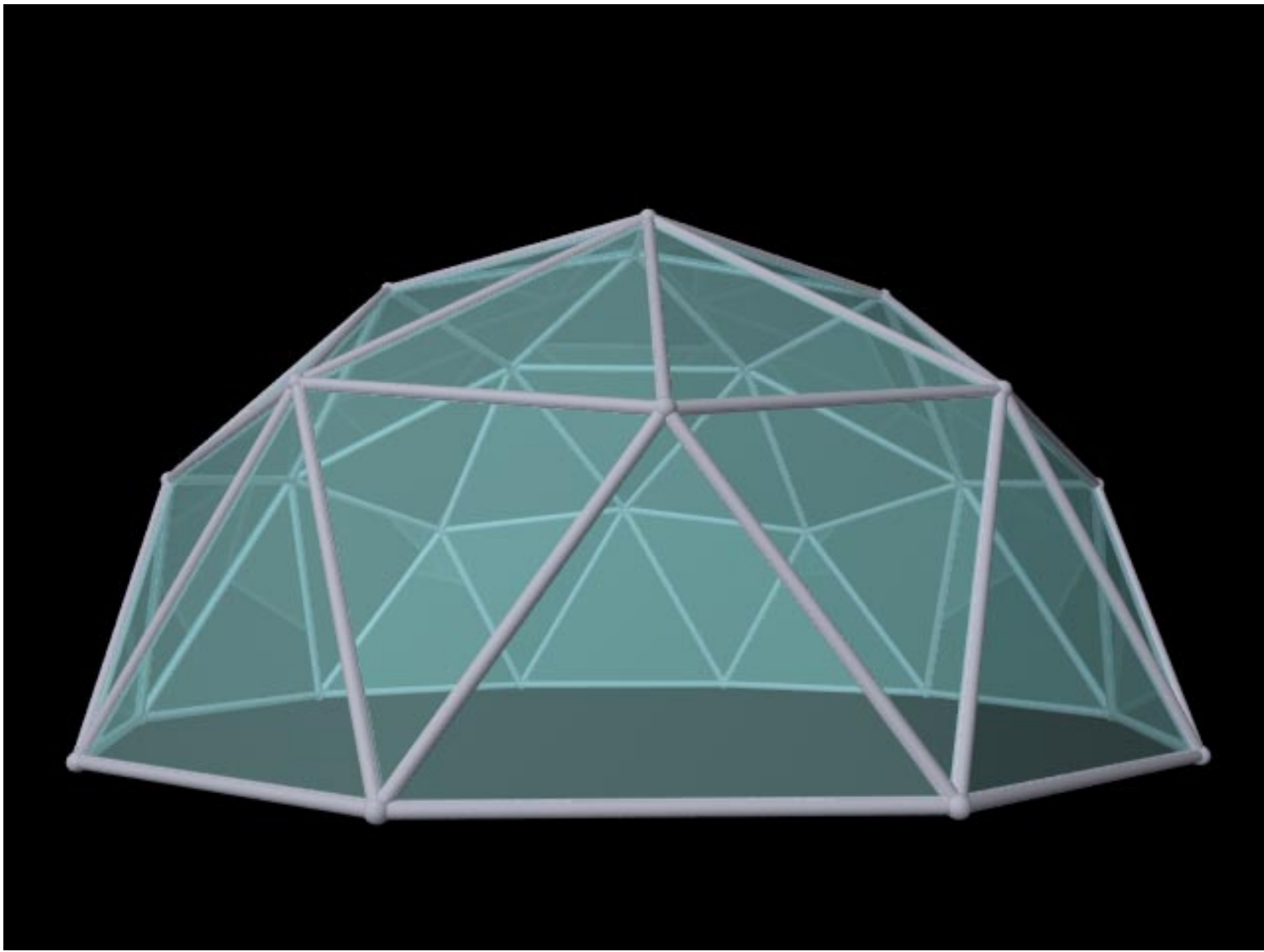

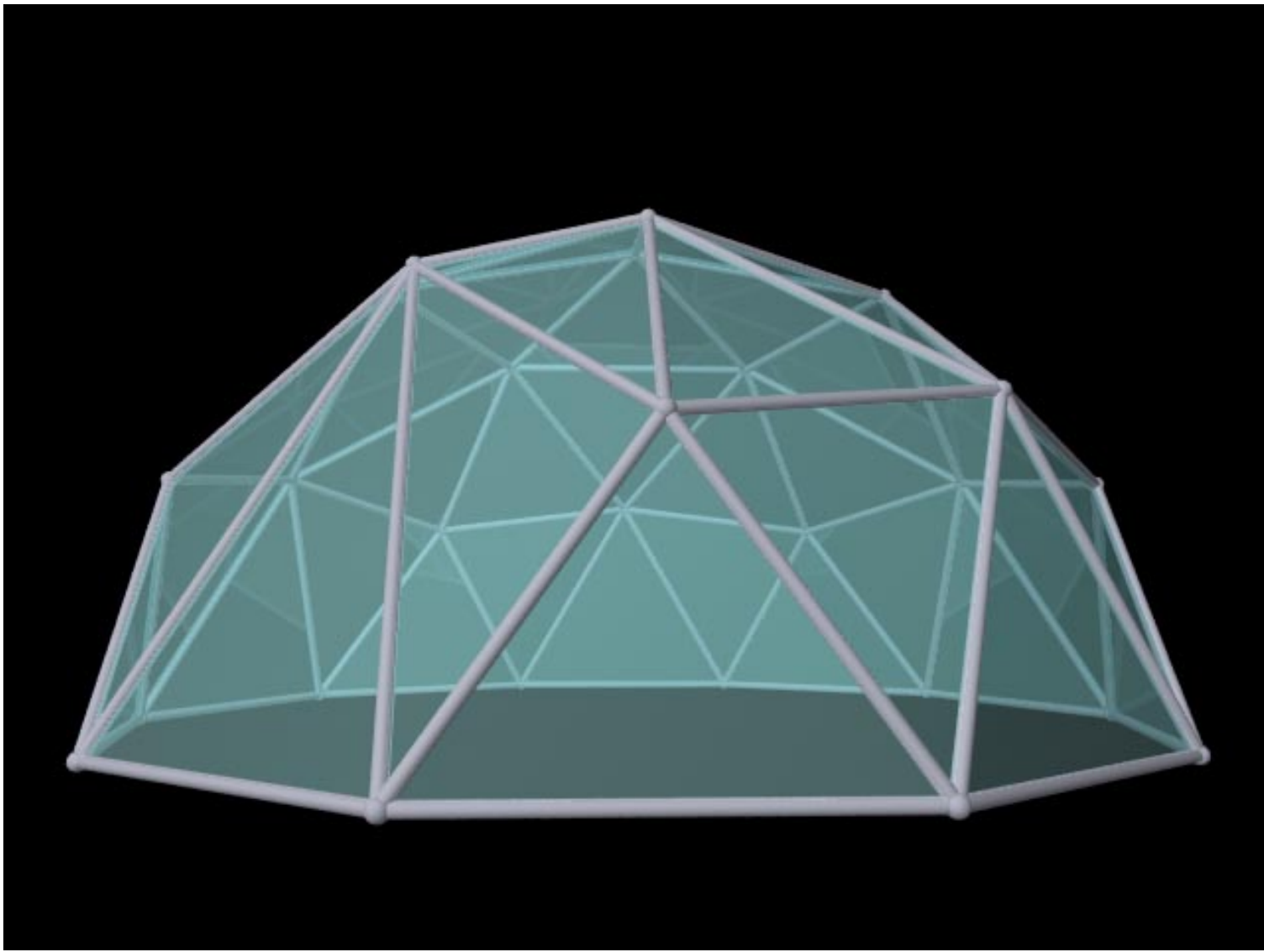

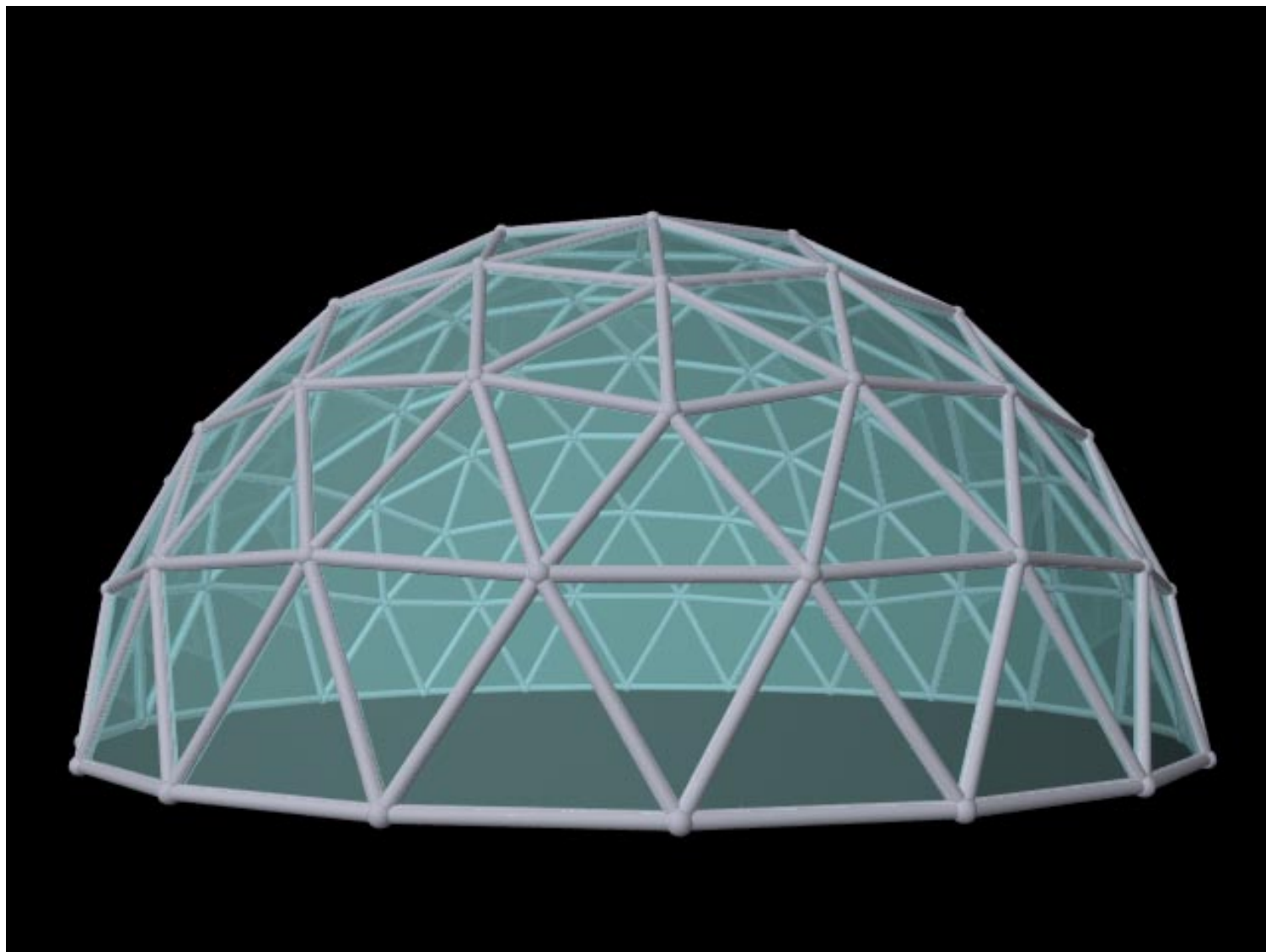

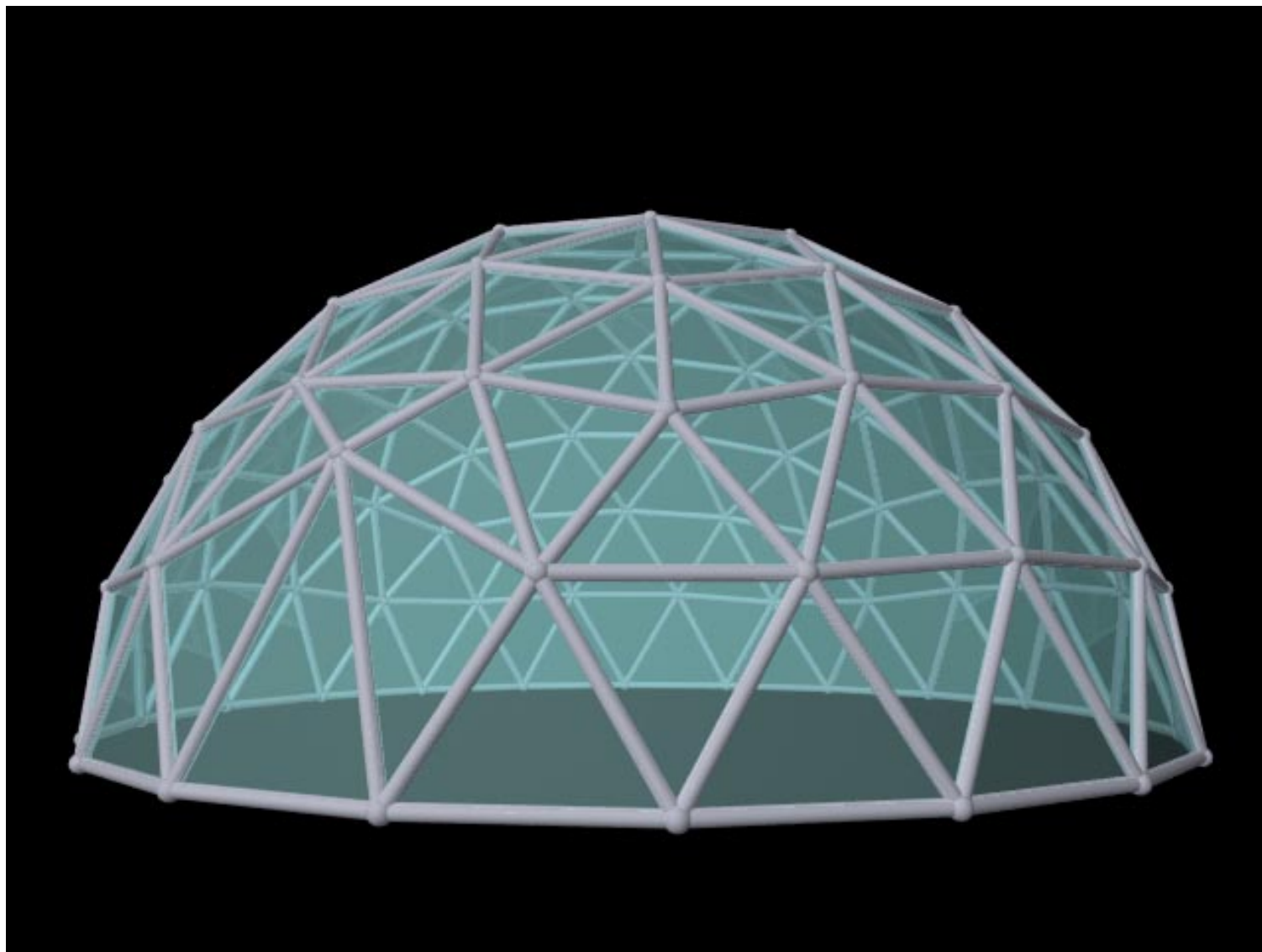



GNU + Cygnus  
+ Windows =

cygwin™

[Cygwin Home](#)

[Cygwin/X Home](#)

[Red Hat Cygwin  
Product](#)

[Community](#)

- [Reporting Problems](#)
- [Mailing Lists](#)
- [Unofficial Newsgroups](#)
- [Gold Stars](#)
- [Mirror Sites](#)

[Documentation](#)

- [FAQ](#)
- [User's Guide](#)
- [API Reference](#)
- [Acronyms](#)

[Contributing](#)

- [Snapshots](#)
- [Source in CVS](#)
- [Cygwin Packages](#)

[Software](#)

- [Setup Package Search](#)

● [Related Sites](#)

● [Licensing Terms](#)

[sources.redhat.com](#)

[Help, contact, web page, other info...](#) [Historical cygwin info...](#)

 [Install or update now!](#) [get help](#) [find](#)

[1.5.11-1](#)





[Red Hat support contracts](#)

[above link](#)

[\*\*New Cygwin DLL 1.5.11-1 release\*\*](#)

[Christopher Faylor \(Project Leader\)](#)

[\*\*New Cygwin DLL 1.5.10-1 release\*\*](#)

[Christopher Faylor \(Project Leader\)](#)

[\*\*New Cygwin DLL 1.5.9-1 release\*\*](#)

[Christopher Faylor \(Project Leader\)](#)

[\*\*New Cygwin DLL 1.5.8-1 release\*\*](#)

[Christopher Faylor \(Project Leader\)](#)

[\*\*New Cygwin DLL 1.5.7-1 release\*\*](#)

[Christopher Faylor](#)

[\*\*New Cygwin DLL 1.5.6-1 release\*\*](#)

[Christopher Faylor](#)

[\*\*New Cygwin DLL 1.5.5-1 release\*\*](#)

[Christopher Faylor](#)

[\*\*New Cygwin DLL 1.5.4-1 release\*\*](#)

[Christopher Faylor](#)

[\*\*New Cygwin DLL 1.5.3-1 release\*\*](#)

[Christopher Faylor](#)

[\*\*New Cygwin DLL 1.5.2-1 test release\*\*](#)

[Christopher Faylor](#)

[more news](#)

[post new news](#)

[\*\*Mortens Cygwin X-Launcher\*\*](#)

[Martin Halle](#)

[\*\*smartmontools\*\*](#)

[Bruce Allen and others](#)

[\*\*Starshiptraders Graphical Console \(Client\)\*\*](#)

[David Johnson](#)

[\*\*Entropy P2P network\*\*](#)

[Juergen Buchmueller](#)

[\*\*VREng \(Virtual Reality Engine\)\*\*](#)

[Philippe Dax](#)

[\*\*TeXmacs\*\*](#)

[Joris van der Hoeven](#)

[\*\*GrWinTk-0.99.9\*\*](#)

[Tsuguhiro TAMARIBUCHI](#)

[\*\*Hybrid 7rc1 IRCD\*\*](#)

[Zeke Gomez](#)

[\*\*Recode - character set conversion\*\*](#)

[Francois Pinard](#)

[\*\*Singular - A Computer Algebra System for Polynomial Computations\*\*](#)

[Viktor Levandovskyy \(Singular Team\)](#)

[more software](#)  
[announce new software](#)

[Red Hat Cygwin](#)

[Product](#)

[FAQ](#)

[User's Guide](#)

[mailing list archives](#)

[appropriate mailing list](#)

[the cygwin mailing list](#)

*DO NOT SEND EMAIL TO THIS ADDRESS [aaaspam@sources.redhat.com](mailto:aaaspam@sources.redhat.com) IT IS HERE ONLY TO COLLECT SPAM. IF YOU SEND EMAIL TO THIS ADDRESS YOU WILL BE AUTOMATICALLY BLOCKED.*

# A Rainproof Geodesic Dome for Burning Man



## [Struts](#) | [Covering](#)

These two pages contain a blow-by-blow description of how to build a rainproof geodesic dome using 3/4-inch electrical conduit and heavy-duty tarps. We brought a 20-foot diameter dome as our living space to Burning Man in 1999 and 2000.

Most of the work of designing and building in 1999 was done by Eric Hoffman. I helped some, and built these pages partially to figure out how to put it up by myself in 2000.

There are a lot of other useful dome-building pages on the web. [Tara's Desert Domes](#) is a great place to start, and also has many links to other resources. One difference between our page and many of these others is the emphasis on being rainproof. [Howard's Home Dome](#) is the advice page of another Camp Sunscreeener. Finally, [Bob Stahl's Temporary Desert Structures](#) is also required reading.

---

[Tamara Munzner](#) Last modified: Mon Jul 29 19:37:59 PDT 2002



[Home](#) [Dome Composition](#) [Cardboard Triangles](#) [Wood Triangles](#) [Rebar & Gaskets](#)

[Painting, Vents, Tape & Velcro](#) [Flooring](#) [Assembly](#) [Site Map](#) [Contact](#) [Links](#)

# Dome Composition

Each dome consists of 45 triangles:

- 30 cardboard isosceles triangles with tabs (ABB triangles)
- 5 wooden equilateral triangles with cardboard coverings with vent flaps (AAA vents)
- 5 wooden equilateral triangles that function as doorways (AAA doorways)
- 5 cardboard equilateral triangles that function as the removable doors (AAA doors)

The 30 ABB triangles form six pentagons. They are connected to one another along the length of their tabs using nuts and bolts. Five pentagons form the majority of the walls while the sixth forms the roof. The 10 AAA wooden triangles are placed evenly between the wall pentagons on two levels. The five on the bottom form the doorways; the five above them form the vent system and the platform on which the roof pentagon rests. The AAA triangles are connected to the ABB triangle tabs using nuts and bolts.

The dome is held in place with fifteen pieces of rebar bent into horseshoe shapes. These are hammered into the ground through pre-drilled pieces of wood (gaskets) placed on the bottom tabs of the wall pentagons.

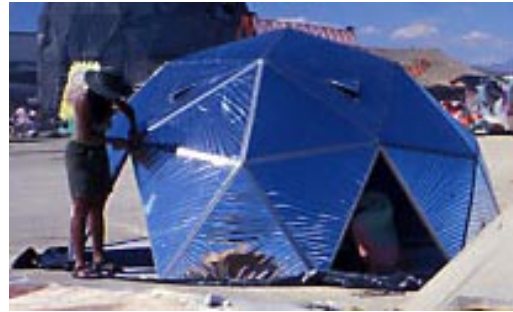

The exterior is made impermeable using water-based enamel paint over primer. All the joints forming the pentagons and all those that link the upper wooden triangles to the pentagons are duct taped. The flaps forming the upper vent system and the edges of the bottom tabs of the wall pentagons are also duct taped.

The flooring is made of carpet cut into a decagon (a polygon with ten angles and ten sides) and underlaid with plastic sheeting.





[Home](#) [Dome Composition](#) [Cardboard Triangles](#) [Wood Triangles](#) [Rebar & Gaskets](#)

[Painting, Vents, Tape & Velcro](#) [Flooring](#) [Assembly](#) [Site Map](#) [Contact](#) [Links](#)

# Cardboard Triangles

1. [Tools](#)
2. [Cardboard](#)
3. [Dimensions](#)
4. [Templates](#)
5. [Drawing ABB Triangles](#)
6. [Cutting ABB Triangles](#)
7. [Bending ABB Tabs](#)
8. [Making Bolt Holes](#)
9. [Making AAA Cardboard Triangles](#)

---

## 1. Tools for Cardboard Triangles

[Top of Page](#)

- 4'x 4' or 4'x 8' wooden cutting board
- utility knife
- new utility knife blades
- pencils
- 4' straight edge
- large set square (only for making initial templates)
- electric drill
- 9/32" drill bit
- electrical extension cord
- piece of wood for kneeling on
- knee pads (optional but recommended)
- wide masking tape



- bending board (see below)

## Bending Board Materials and Construction

### Materials

- 2 pieces of 1" x 4" x 5' wood
- 2 bolts, 1/4", 3" long (make sure they have adequate threading)
- 2 wing nuts, 1/4"
- 4 washers, 1/4"

### Construction

- (1) Place the boards on top of one another and align all the edges.
- (2) Mark a spot four inches in from each end, and 1 3/4" in from the sides.
- (3) Holding both boards tightly together drill a hole through both marks using a 9/32" drill bit.
- (4) Link the boards together using the wing nuts, bolts and washers. The side with the wing nuts is the top of the bending board.

### Bending Board

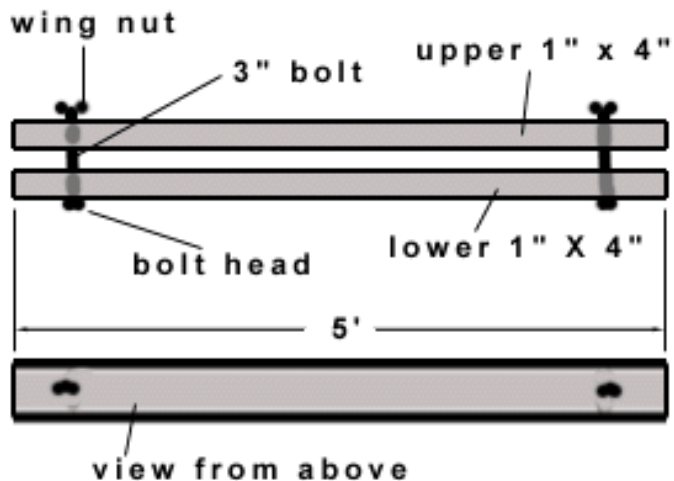

---

## 2. Cardboard

[Top of Page](#)



### (1). Type and Condition

We recommend using double ply cardboard for strength. Check the cardboard for holes, tears and especially bends, as each of these can present its own particular brand of problems.

single-ply cardboard edge



double-ply cardboard edge



### (2). Where to Find the Cardboard

The best place to find cardboard that is both big enough and thick enough seems to be at campershell stores.

## 3. Dimensions

[Top of Page](#)

One dome consists of 30 ABB cardboard isosceles triangles with two inch wide tabs on all three sides and 10 AAA cardboard equilateral triangles.

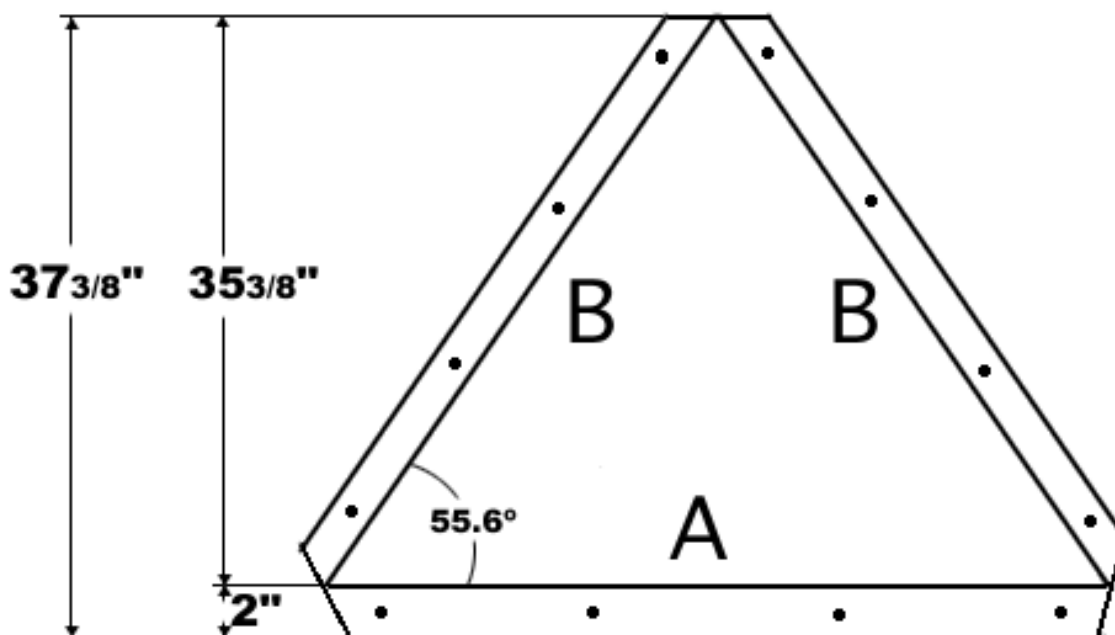

#### (1). ABB Triangles

Length of A side = 48 inches

Length of B side =  $42 \frac{3}{4}$  inches

Width of tabs = 2 inches

#### (2). AAA Triangles

Length of A side = 48 inches

No tabs

'A' tab bolt hole dimensions (not drawn to scale)

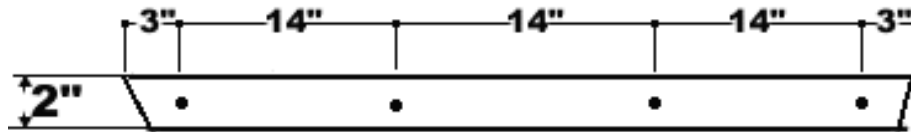

'B' tab bolt hole dimensions (not drawn to scale)

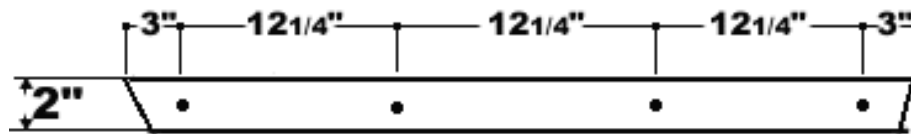

---

## 4. Templates

[Top of Page](#)

Take special care when making the templates. Go to the 'Cutting ABB Triangles' segment of this web page for tips on cutting cardboard.

### ABB Template

Do not bend the tabs of the ABB template. Use the measurements in the two tab diagrams above to measure and mark the bolt holes in the A-side and B-side tabs of the ABB triangles. Drill the holes using a 9/32" drill bit.

### AAA Template

The sides of the AAA template should be

measured  $1/8$ " short, i.e., each side should measure  $47 \frac{7}{8}$ ". This will take care of any extra distance that may be added to the overall length of each AAA triangle due to the width of the pencil lead.

When the templates have been cut, edge them with tape. This will prevent them from fraying, make outlining easier and stop you from getting vicious paper cuts.

---

## 5. Drawing ABB Triangles

[Top of Page](#)

(1) Set up the wooden cutting board on a level surface with lots of space around it.



(2) Check the cardboard for imperfections then lay it on the cutting surface.

(3) Put the template on top of the cardboard.



(4) Move the template around to determine the best positioning. To help make the most of the available space use previously cut ABB or AAA triangles along with the template to help figure out the most economical way of placing the triangles so as to preserve as much of the cardboard as possible.

(5) Holding the template in place, draw a thick pencil line around it.

- numbers 6 through 9 pertain to ABB triangles only -



(6) Make a special point of marking the three points of the triangle. This will help you line up the edges for the creasing of the tabs later on.

(7) We have discovered that it is worthwhile to use the existing crease (if applicable) in the cardboard. Lay the template over the crease so that it corresponds to the tab on the template.

(8) Once the line has been drawn around the outside of the ABB template, hold the template firmly in place and stick a sharp pencil through the bolt holes, puncturing the cardboard in all twelve spots (you will enlarge the holes with a drill later on in the process).

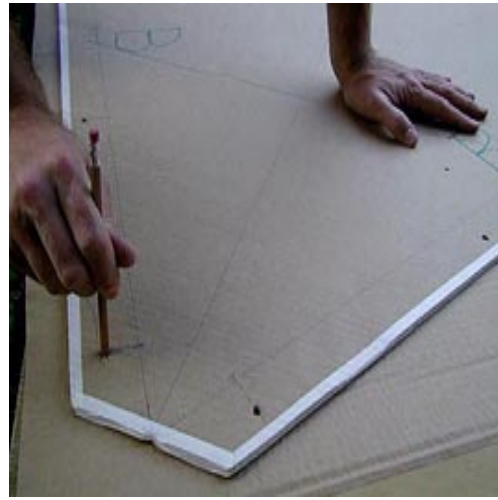

(9) When you remove the template, you need to re-draw the triangle point lines, this time marking the inside surface of the new triangle.

---

## 6. Cutting ABB Triangles

[Top of Page](#)

(1) When cutting the cardboard it's a good idea to wear a pair of kneepads.

(2) If you need to kneel on the cardboard put a wide piece of wood under your knees to keep from indenting the cardboard.

(3) Line up the straight edge with the pencil line, with a very sharp blade try to make the cut so that it only needs to be done once. The best method seems to be sticking the point of the blade through the cardboard, applying pressure and then making the cut.

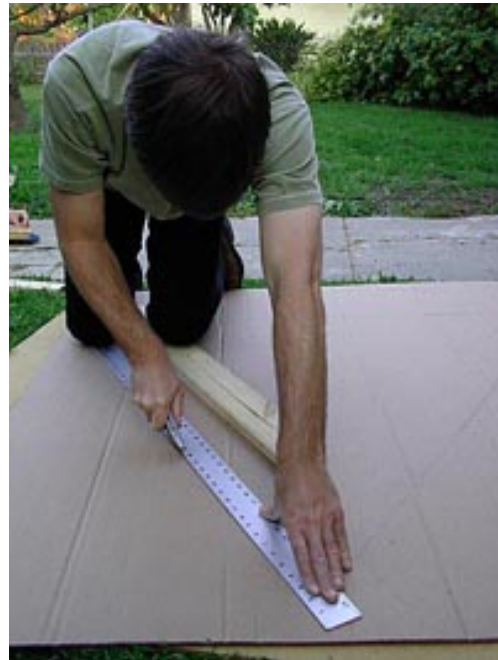

(4) If you have the outlines of two or three templates on one piece of cardboard try to make it so that the first cut slices the cardboard in two, thus making it more manageable.

(5) The actual angle of the ABB tab corners is not too important (see diagram above if in doubt), however they must be cut off to allow for easy dome assembly.

## 7. Bending ABB Tabs

[Top of Page](#)

(1) Set up the bending board on a hard, flat, level surface and untighten the nuts.

(2) Decide which side of the triangle will be the interior and which the exterior based upon the condition of the cardboard. The interior gets any tears or holes. (3) With the interior side facing upwards, fit the triangle between the two boards of the bender.

(4) Line up the corner marks of the triangle along the front edge of the bender.

(5) Tighten the nuts.



(6) Kneel on the bending board, spreading your legs apart as far as possible

(7) Then lean over and essentially give a wide, loose and flat handed hug to the triangle. Be careful when initially putting your hands under the triangle; I've scraped my hands on many occasions.



(8) Apply pressure and slowly jog the cardboard upwards until it's perpendicular to the ground.



(9) Loosen the wing-nuts, remove the triangle from the bender, then slowly and deliberately fold the new crease by hand. This will make it more pliable and the dome easier to assemble.

(10) Repeat stages 3 through 9 along the other two edges of the triangle.



---

## 8. Making Bolt Holes

[Top of Page](#)

(1) Simply stand the ABB triangle up and drill through each of the marked bolt holes using a 9/32" drill bit.



---

## 8. Making AAA Cardboard Triangles

[Top of Page](#)

Make 10 (12 if want an extra vent and an extra door) AAA cardboard triangles using the AAA template.

Make sure the sides, once cut, are not longer than 48 inches.







# Wood Triangles

1. [Tools](#)
2. [Wood](#)
3. [Dimensions](#)
4. [Cutting](#)
5. [Drilling Holes](#)
6. [Triangle Assembly](#)
7. [Adding Cardboard](#)

---

## 1. Tools

[Top of Page](#)

### (1) Tools for Cutting Wood

- chop saw
- safety glasses
- ear plugs
- two clamps
- pencil
- tape measure
- 2 or 3 pieces of 2" x 4"



## (2) Tools for Drilling Wood

- electric drill
- 9/32" drill bit
- pencil
- tape measure



## (3) Tools for Connecting AAA Pieces

- caulking gun
- one tube of exterior floor glue
- two drills (cordless preferably)
- loads of 1 5/8" wide thread drywall screws
- a drill bit slightly thinner than the screws
- staple gun
- 14mm staples



---

## 2. Wood

[Top of Page](#)

(1) Each triangle is made from three 1" x 2" x 4' pieces of cheap lumber.

(2) Seventeen pieces of 1" x 2" x 8' are needed to make all ten wooden triangles for the dome plus one spare.

(3) Because the wood is cheap it is generally bad quality. Check every piece of lumber for:

- warps along both the length and width,
- knots that span half or more than half of the width
- chunks missing along the length
- splits along the length or width
- excessive wetness
- excessive dryness
- mould

---

## 3. Dimensions

[Top of Page](#)

Each of the ten AAA wooden triangles is made of three pieces of 1" x 2" wood cut to (roughly) 48" in length.

The bolt hole distances are equal to those on the A side of the ABB triangles (see diagram on the '[Cardboard Triangles](#)' page), however because the end of each piece of wood is cut at least twice it is common for each piece of wood to be slightly shorter than 48 inches. As a result please carefully read the section on drilling the holes, below, as doing it correctly will save a lot of hassle later on during assembly.

## 4. Cutting

[Top of Page](#)

(1) Cut all the pieces of 1" x 2" x 8' into 4 foot pieces using the zero degree angle on the chopsaw.

(2) Cut a piece of 2" x 4" at a 30 degree angle using the chopsaw. (the blade will be pointing back toward your left)

(3) Return the angle of the chopsaw to its zero degrees point.

(4) Clamp the cut piece of 2" x 4" to the body of the chop saw, as shown in the picture opposite.

(5) Make sure that the high point of the wood block's angle is very slightly to the left of very center of the chopsaw's cutting area.



(6) Following the 30 degree angle of the clamped block and at a distance of roughly three and a half feet from the block, place a couple of pieces of 2" x 4". These pieces work as supports for the 1" x 2" x 4's while making the first two series cuts (see indication of placement in picture opposite).

(7) Guide a piece of 1" x 2" into the cutting area. Make sure that it's tip is at the same point as the high point of the wood block in the cutting area, that the 2" side is flush against the cut edge of the 2" x 4" and the 1" side is pointing skyward, and finally that the other end of the 1" x 2" is resting on the wood blocks in step 6.

(8) Hold the 1" x 2" firmly in place and make a cut.

(9) Flip the piece of 1" x 2" and repeat steps 7 and 8. Your piece of 1" x 2" should now look like the one in the diagram below.

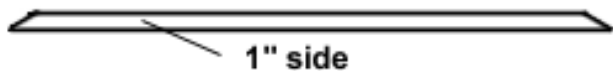

(10) Repeat steps 7 through 9 until all the wood is cut.

(11) Remove the 2" x 4" block from the chopsaw, swivel the base around to 30 degrees and lock into place.

(12) Clamp the 2" x 4" block on to the right side of the chopsaw with the 90 degree angle point almost centered in the cutting area. Try to make it so that the right side of the blade is just shy of rubbing the wood block.



(13) Guide one of the previously cut pieces into the cutting area. Make sure its tip abuts the 90 degree angle of the block and that the cut on the 2" side faces upwards, as shown in the picture opposite.

(14) Hold the 1" x 2" firmly in place and make a cut.

(15) Repeat steps 13 and 14 till all the pieces of 1" x 2" have a second cut on the one side.



(16) Finally, guide a piece of 1" x 2" into the cutting area to make the final cut. Make sure its tip abuts the 90 degree angle of the block and that the cut on the 2" side faces downwards, as shown in the picture opposite.

(17) Hold the 1" x 2" firmly in place and make a cut.

(18) Repeat steps 16 and 17 till all the pieces of 1" x 2" have a second cut on the other side. Your piece of 1" x 2" should now look like the one in the diagrams below.

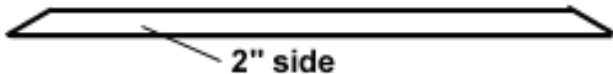
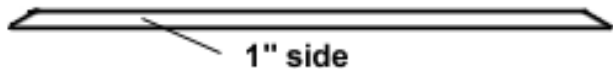

---

## 5. Drilling Holes

[Top of Page](#)

(1) The distances between the bolt holes on the wooden pieces are equal to those of the A side of the cardboard ABB triangles (see diagram below). Because the wood cuts tend to shorten the overall length of the wooden pieces it is generally necessary to slightly fudge the actual measurements.

**Wooden 'A' bolt hole dimensions (not drawn to scale).**

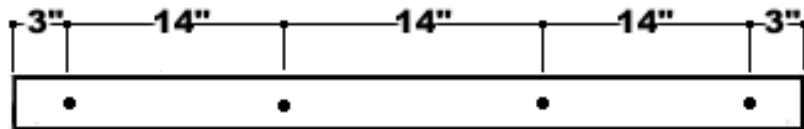

(2) Make a template for the bolt holes by cutting a piece of cardboard 48 inches long and as wide as the so-called 2 inch side of the 1" x 2".

(3) Mark the bolt holes on the template by using the measurements from the diagram above. Punch through the markings using a pointed tool such as an awl.

(4) Place the template on the 2" side of a wood piece. Make sure that the template covers what will become the outside of the wooden triangle. (All angles are on the inside).

(5) If the length of the template is longer than the wood piece adjust the template so that an equal amount of it is protruding over either end of the wood.

(6) Holding the template in place mark the bolt holes on the wood piece.

(7) Drill the holes using a 9/32" drill bit. Try to be as accurate as possible and to drill as straight as possible.







---

## 6. Triangle Assembly

[Top of Page](#)

(1) Assembling the wooden triangles requires two people.

(2) Select two pieces of cut and drilled wood and smear some wood glue on both faces, then stick them together. Make sure the angles are the mirror images of each other.



(3) While one person holds the two pieces steadily together the other drills a hole through both pieces with a drill bit slightly smaller than the width of a drywall screw. Try to drill slightly off center. Pre-drilling will prevent the wood from splitting.



(4) Screw the two pieces together through the hole using a 1 5/8" drywall screw. If the point of the screw sticks out after screwing it in, remove it and redrill in a different location.

(5) Repeat the process on the other side of the angle so the corner is held together with two drywall screws and a glob of glue.

(6) Grab a third piece of wood and repeat the process until all three angles of the triangle are securely held in place with glue and two screws.



---

## 7. Adding Cardboard

[Top of Page](#)

(1) Cardboard is attached to five of the AAA triangles.

(2) Select five (or six if you want a spare) AAA cardboard triangles and five AAA wooden frames.

(3) Lay the wooden triangle on a level surface with the uncut outer corners pointing upward.

(4) Lay a bead of wood glue along the entire upper surface and lay a piece of AAA

Cardboard Domes - Wooden Triangles: How to Construct the Wooden Equilateral Triangles for a Cardboard Geodesic Dome  
cardboard atop it.



(5) Staple the cardboard into place using 14mm staples. A good rule of thumb is to staple the corners first to stop the cardboard from moving around then add a staple every 6 inches or so along the length of each side.







[Home](#) [Dome Composition](#) [Cardboard Triangles](#) [Wood Triangles](#) [Rebar & Gaskets](#)

[Painting, Vents, Tape & Velcro](#) [Flooring](#) [Assembly](#) [Site Map](#) [Contact](#) [Links](#)

# Rebar & Gaskets

1. [Rebar Bending Tools](#)
2. [Constructing Rebar Bender](#)
3. [Bending Rebar](#)
4. [Gasket Tools](#)
5. [Making Gaskets](#)

---

## 1. Rebar Bending Tools

[Top of Page](#)

- 2 pieces of beam
- 4 spikes
- 4 foot piece of plumbing pipe
- sledge hammer
- 2 foot lengths of rebar (15 + 3 spare)
- tape measure



## 2. Rebar Bender Construction

[Top of Page](#)

The four spikes need to be pounded into one piece of the beam in a particular pattern (see pic opposite). This pattern will facilitate the bending process.

Hammer the spikes into the beam using a sledgehammer (safety glasses recommended) in the pattern shown. The spikes themselves will hold the two pieces of beam together. Be sure to leave at least two and a half inches of each spike sticking out. Also make sure that the two pieces of beam are flush on what will be the bottom edge.



**bending space, approximately 2"**

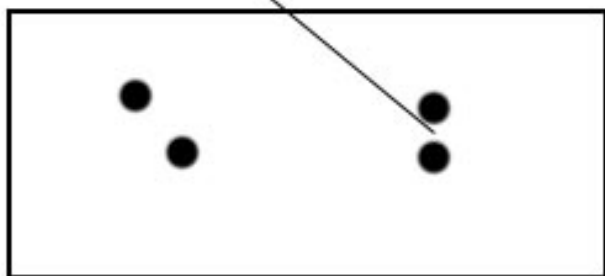

● = spike

---

## 3. Rebar Bending

[Top of Page](#)

(1) Slot a two foot piece of rebar between the spikes on the bender as shown in the picture opposite.



(2) Holding the bar in place measure 12" from one end of it to its center. Make sure the center is between the two parallel spikes, as shown in the picture opposite



(3) Now, holding the rebar firmly in its central position stick the plumbing pipe on to the rebar until it reaches the 12" mark.



(4) Keeping pressure on both the rebar with one hand and the pipe with the other, pull the pipe toward you. Once both feel solidly in position with one another, grab the pipe with both hands and bend the rebar over until it makes a horseshoe shape.



(5) Pull the pipe off the rebar, disentangle the horseshoe shaped rebar from the bender and grab another two foot piece of rebar and repeat ad nauseum.



---

## 4. Gasket Tools & Materials

[Top of Page](#)



- 6 pieces of 1"x 2" x 44"
- drill
- 15/32" drill bit
- extension cord
- saw
- tape measure
- pencil
- wood for drilling atop



## 5. Making Gaskets

[Top of Page](#)

- (1) Cut the 1"x 2" to lengths of 44". The sixth piece is a spare.
- (2) Using a horseshoe of recently bent rebar mark off three sets of two holes along the length of each piece of 1"x 2". The distances between the sets are not too important as long as one is in the center and the other two sets far in enough from the edge as to make swinging a sledgehammer during assembly not too difficult. The distance between the two holes of each set must mirror the distance between two average tines of bent rebar. See diagram below:

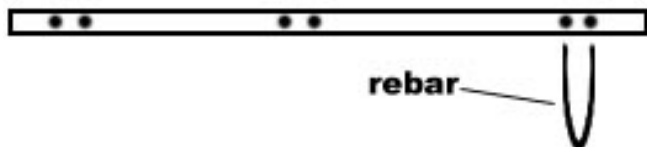

- (3) Drill the holes with 15/32" bit.





# Painting, Vents, Tape & Velcro

1. [Painting Tools and Equipment](#)
2. [Paintings Methods](#)
3. [Making Vents in Upper AAA Triangles](#)
4. [Duct Taping Upper AAA Vents](#)
5. [Duct Taping Doorway AAA Triangles](#)
6. [Velcroing Doorways](#)

**Please note:** There are two methods for painting the domes; spraying or manual. Sprayers may be rented but can be difficult to use and require a large amount of drop cloths. Manual painting requires less expertise but may take longer.

---

## 1. Painting Tools and Equipment

[Top of Page](#)

### Spraying

- airless sprayer
- buckets
- paint strainer
- airless sprayer throat seal
- 1 gallon paint thinner
- quick drying water based primer
- black universal paint tint
- stir sticks
- electrical extension cord (optional if sprayer runs on gas)
- paint brush
- church key (for opening paint cans)
- huge pile of drop cloths



## By Hand

- paint brush
- buckets
- drop cloth
- mini-roller
- 4"roller screen
- mini-roller cover
- quick drying water based primer
- black universal paint tint
- stir sticks
- church key (for opening paint cans)



---

## 2. Painting Methods

[Top of Page](#)

- [Types and Amount of Paint](#)
- [Spraying](#)
- [Painting by Hand](#)
- [Storing the Triangles While They Cure](#)
- [Touch-up Paint](#)

### • Types and Amount of Paint

[Top of Page](#) or [Painting Methods](#)

Whether spraying or rolling use the same type of paint. The outside needs to be waterproof.

#### Primer

I recommend first priming both the inside and the outside of the triangles. The primer should be water-based and quick-drying. I generally prefer not to give product names but in this case I'll make an exception and tell you that the primer of choice is Zinsser 123. It is highly tintable, water based and most important of all dries to touch in roughly 45 minutes and can be recoated in 1

hour.

Tinting your primer adequately may allow you to use only one coat of paint. Use black universal tint to obtain the same tone value as your paint color.

### **Paint**

The outside of the dome must be water-proof. For this reason, I recommend using a water-based enamel paint with the highest sheen you are willing to live with. Semi-gloss enamel will provide minimal yet adequate protection. Alternatively it is also possible to cover the exterior with another type of material; in 2003 we covered one of the domes with mylar.

The type of paint used inside the dome is unimportant. Once the priming has been done you can paint it however you wish with whatever type of paint you prefer.

### **Amount of Paint**

It should take approximately one and a half gallons of primer to suitably prime both the inside and outside, one gallon to finish the inside and another to finish the outside.

### **Tips**

- Mis-tinted paint can be bought very cheaply at paint stores.
- Check out the local toxic waste collection site. They often have primers and paints you can get for almost nothing

### **• Spraying**

[Top of Page](#) or [Painting Methods](#)

(1) Try to find a place out of the wind and with as little foliage overhead as possible.

(2) Lay out the drop cloths over as wide an area as possible while making sure they overlap one another.

(3) Cover up anything and everything in the surrounding area that you'd prefer not to get paint on.

(4) Place the AAA and ABB cardboard triangles in rows across the drop cloths with the interior side facing upwards. Check the AAA triangles as you place them to make sure that any defects are on the interior.

(5) Lay out the wooden triangles and the wooden gaskets.

(6) Set up the sprayer with the tinted primer and test the spray on a scrap piece of cardboard. A "5-17" tip should be adequate for the job (5 refers to half the width of the spray, in this case five inches and 17 refers to the hundredth of an inch size of the spray tip aperture, in this case seventeen hundredths).

(7) It is advisable to have a second person on hand when spraying. This person holds the excess spray hose, making sure it doesn't swipe any just-painted surfaces.

(8) Once all the interior sides have been primed and have dried for the time specified on the can, flip them over and repeat the process on the exterior sides. (Don't forget to change the tonal color of the primer if applicable).

(9) Wait an hour, flip all the pieces, paint the interior color.

(10) Wait the amount of time specified by the instructions on the side of the can, flip all the pieces, paint the exterior color. Remember that the wooden gaskets only need to be painted with the interior paint and only on one side.

### **Tips**

- Clean out the sprayer with water between colors.
- Leave the gun, with tip attached, in a bucket of water while waiting for sides to dry.
- Don't spray if it's excessively windy or rain is threatening.
- Don't get in the way of a loaded gun. You can seriously injure yourself.
- Don't forget to back off the pressure between relevant steps.

## • **Painting by Hand**

[Top of Page](#) or [Painting Methods](#)

(1) Try to find a place out of the wind and with as little foliage overhead as possible.

(2) Lay out a drop cloth for working on.

(3) Decide which sides of the AAA and ABB cardboard triangles will constitute the interior of the dome (those with more defects) and which will be the exterior. Stack them with the interior sides facing upward next to the drop cloth.

(4) Make a set-up using tinted primer, a two and a half gallon bucket, a four inch screen, a mini-roller handle and mini-roller with a thick nap. Have a brush on hand to pick up drips.

(5) Roll the interior side of each triangle, then place it somewhere to dry with the primed surface facing upwards.

(6) Continue until all the interior sides have been primed, then prime the wooden AAA triangles and the tops and sides of the wooden gaskets.

(8) Once all the interiors sides have been primed and have dried, flip them over and repeat the process on the exterior sides. (Don't forget to change the tonal color of the primer if applicable).

(9) Wait an hour, flip all the pieces and paint the interior color.

(10) Wait an the amount of time required by the instructions on the side of the can, flip all the pieces and paint the exterior color. Remember that the wooden gaskets only need be painted with the interior paint and only on one side.

## • Storing the Triangles While They Cure

[Top of Page](#) or [Painting Methods](#)

(1) Water-based paints can take anywhere from one to two weeks to cure. For this reason it is a not good idea to stack the triangles immediately after painting, as they may stick together.

(2) Place the pieces sideways against a wall, so that only one edge is touching the wall and the body is pointing away from it at an angle. Place the next triangle at the same angle right by it and so on and so forth until all of the triangles are lined up (see picture opposite).

(3) If you leave them outside, put a plastic drop cloth below them and then cover them with more plastic sheeting to keep the weather out.

(4) After a week or two it should be okay to stack them, one atop the other. Stacks of ten or so are recommended to prevent sticking. Check them periodically to make sure they are not sticking and separate them if need be.



## • Touch-up Paint

[Top of Page](#) or [Painting Methods](#)

(1) It is extremely important to keep touch-up paint.

(2) To save space, buy an empty quart can with a lid for each color you'll be using, plus an extra one for primer.

(3) After decanting the excess paint into the quart cans make sure the lids are securely closed (you'd be surprised how often this doesn't happen). The best method is to put the lid in place, cover it with a cloth then hammer the lid into place. Double check the rim afterwards to be absolutely certain it is closed properly.



### 3. Making Vents in Upper AAA Triangles [Top of Page](#)

(1) Each upper AAA triangle has a vent for air circulation. The vents are simply triangular flaps cut into the cardboard and then edged with duct tape to help keep out bad weather. In the diagram opposite notice that the triangle and the flap are pointing downward (the dotted line represents the fold of the flap). The flap points downwards in case of rain.

**Please note:** the triangles in the following pictures were covered with mylar as opposed to paint.

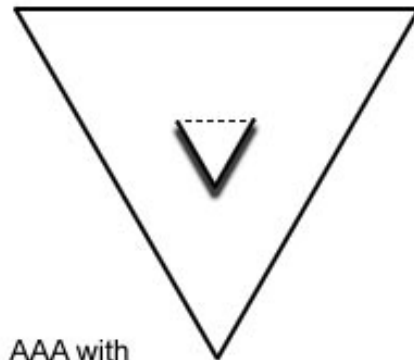

AAA with downward pointing vent

(2) Make a template for outlining the flaps with a spare AAA cardboard triangle. Find the center of the AAA triangle. Around it measure an equilateral triangle with 12 inch sides. Make sure the sides of the smaller triangle mirror the edges of the larger triangle, as in the diagram. Cut out the small triangle.

(3) Place the template over the cardboard of a wooden sided upper AAA triangle and outline a small triangle on to it.



(4) Using a straight edge and a sharp knife make two cuts.



(5) Place the straight edge along the length of the uncut side and slowly and deliberately pull up the inner triangle until a satisfactory flap has been created.



(6) The flaps should look like the ones in the picture opposite. Although the flaps will seem to want to sag under their own weight once the dome has been assembled, they do in fact hold themselves adequately in place.

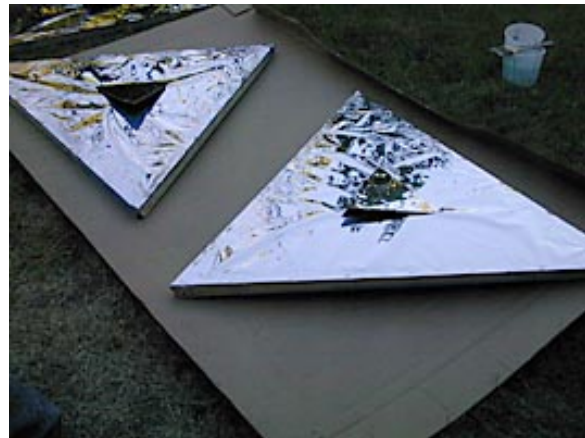

---

## 4. Duct Taping Upper AAA Vents [Top of Page](#)

(1) All the edges that create the vents must be duct taped

(2) We have found that the easiest and most aesthetic results can be obtained by folding a pre-cut length of duct tape along the length of an edge then lightly cutting it to shape afterwards with razor blade or utility knife.



## 5. Duct Taping Doorway AAA Triangles [Top of Page](#)

(1) All the edges of the AAA cardboard doorways need to be duct taped to keep the weather out.

(2) Simply duct tape the edges and cut off the excess with a pair of scissors.

(3) For the trully paranoid an extra taping should also be applied. In this case the second application of tape is taped closer toward the edge on both sides of the cardboard. The resulting excess along the entire length of each side is then stuck together creating a lip. This lip helps keep out wind and water. Like the first taping it is clipped at the corners.



---

## 6. Velcroing Doorways [Top of Page](#)

(1) Using velcro on the doorways allows them to be easily attached or removed.

(2) Each dome requires 13 1/2 feet of velcro. This includes velcro for one extra doorway.

(3) Try to find sticky back velcro that is either 3/4" or 1" wide with a release film that extends beyond the width of the velcro itself, for easy removal. When handling the velcro try not to touch the glue with your hands.

(4) Cut the velcro into lengths 1 and 2 inches. Use the 1 inch lengths to cover the corners.

(5) Attach the velcro at equal distances (see diagram apposite) to the insides of the AAA cardboard triangles and the lower AAA wooden frames. Make sure there is one piece in each corner. The velcro on the insides of the AAA cardboard triangles will attach to the duct tape edging by default.

(6) Be consistent when attaching the velcro. If one wooden frame gets the hook side, all the wooden frames should get the hook side.

velcro spacing (not to scale)

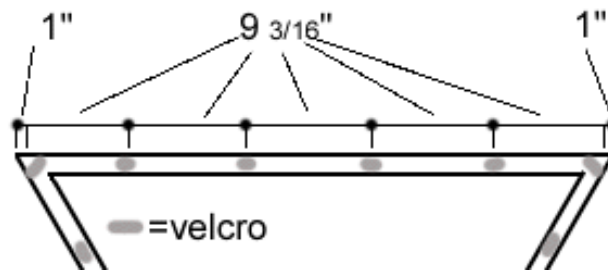



[Home](#) [Dome Composition](#) [Cardboard Triangles](#) [Wood Triangles](#) [Rebar & Gaskets](#)

[Painting, Vents, Tape & Velcro](#) [Flooring](#) [Assembly](#) [Site Map](#) [Contact](#) [Links](#)

# Flooring

1. [Flooring Tools](#)
2. [Selecting Carpet](#)
3. [Measuring and Cutting Carpet](#)
4. [Taping Carpet](#)
5. [Making a Plastic Ground Cloth](#)

---

## 1. Flooring Tools

[Top of Page](#)

- tape measure
- 1" x 2" x 8' piece of wood
- drill
- drill bit
- one 1 5/8" drywall screw
- marker pen
- utility knife with a new blade
- 4 foot (or longer) straight edge
- duct tape



---

## 2. Selecting Carpet

[Top of Page](#)

- (1) Used carpet can often be found in dumpsters, carpeting stores or at building sites where renovation is being done.
  - (2) When hunting for carpet bring a utility knife, a tape measure and a roll of duct tape.
  - (3) The optimum diameter is 12' 7 1/8". We have not had much luck finding anything suitable in this size and instead have resorted to using two or three pieces of same-color, same-nap carpet to create a single carpet for a dome.
  - (4) Check any prospective carpet for stains, cuts, holes and tears.
- 

### 3. Measuring and Cutting Carpet

[Top of Page](#)

(1) Lay out the carpet on a flat surface with the nap side facing downward. If you are making it from several pieces, abut the pieces together to form a surface big enough to incorporate a circle 12' 7 1/8" in diameter, as in the picture opposite. The circle will eventually be cut into a ten-sided polygon shape, known as a decagon, with a radius of 6' 3 9/16". Note that at this stage the separate pieces do not need to be taped together.



(2) Draw a circle on the carpet with a compass.

(3) To make the compass use a 1" x 2" x 8' piece of wood (we have tried using a pen with string attached but found it too inaccurate).

(4) Measure 1" in from one end of the 1" x 2" and screw a 1 5/8" drywall screw through the center of the wood. This will act as the central rotating point of the compass.

(5) Next measure 75 9/16" from the screw and mark it.

(6) Drill a hole in the center of the mark big enough to allow a marker tip to protrude through to the other side. Your compass should now look like the one in the diagram opposite.

(7) Screw the central rotating point through the central point on the carpet and draw out a circle.

**Carpet Compass (not to scale)**

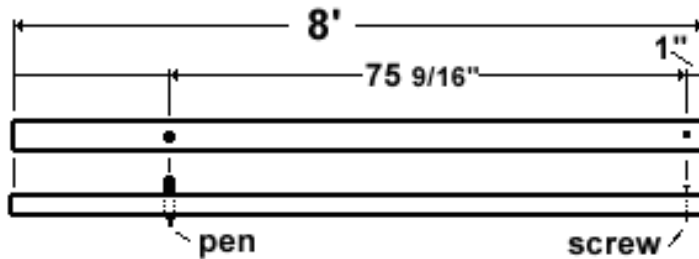

(8) Use the circle as a reference to draw the decagon. Mark a starting point on the circle line. From that point, measure a line  $46 \frac{11}{16}$ " across the inside of the circle. Mark the precise point where that line touches the circle line. You now have two points that demarcate the first decagon side. Repeat the process from the second point until you have all ten marks (see diagram opposite).

Note: Once you have successfully marked all ten points, you may wish to draw the lines from point to point to visually form the decagon.

(9) If your last measurement went past the original mark, measure how many inches you went past, divide that by ten and reduce the measurement on the straight edge by that amount and remark all the points. Conversely, if you were short, measure the distance of the short-coming, divide by ten and add that number to the measurement on the straight edge. If you are off by more than 3", you may have to remeasure the radius of the circle or double check the measurement on the straight edge.

(10) To cut the carpet, align the straight edge from one point to another, hold it firmly in place and make the cut.

(11) Make the cuts all the way around the circle until you have a decagon.

### Marking for Decagon (not drawn to scale)

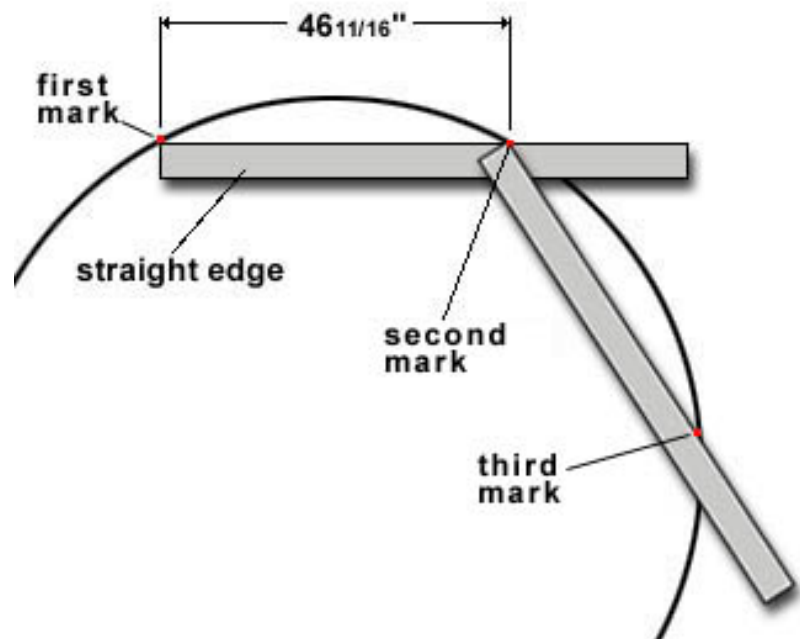



## 4. Taping Carpet

[Top of Page](#)

(1) If the carpet is whole and in one piece, duct tape around the outer edge to keep the carpet from fraying

(2) If the carpet is made from two or three pieces, duct tape the outer edge of each individual piece. Spread the pieces out in order, nap side down, abut them against each other, then duct tape them together along their seams. Taping each seam with three overlapping pieces of tape is recommended.

(3) If you wish to make the seams stronger apply foot long pieces of duct tape perpendicular to the seam with a piece of tape every eight inches or so.

---

## 5. Making a Plastic Ground Cloth

[Top of Page](#)

(1) To help keep moisture out in the event of rain storm use thick plastic sheeting as a ground cloth under the carpet.

(2) The plastic should be 4 mil thick. A roll of it can generally be bought at any paint or hardware store. Try to find plastic that is over 14 feet in width. If you are unable to find the right size plastic duct tape two pieces together.

(3) Unroll the plastic on a flat surface. Cut a square 14' x 14'. Cutting the plastic to the shape of the dome takes place after the dome has been assembled.





[Home](#) [Dome Composition](#) [Cardboard Triangles](#) [Wood Triangles](#) [Rebar & Gaskets](#)

[Painting, Vents, Tape & Velcro](#) [Flooring](#) [Assembly](#) [Site Map](#) [Contact](#) [Links](#)

# Assembly

1. [Assembly Time and Weather Conditions](#)
2. [Nuts, Bolts and Washers](#)
3. [Tools](#)
4. [Preparing Flooring and Work Area](#)
5. [Making the Six ABB Pentagons](#)
6. [Duct Taping the Six ABB Pentagons](#)
7. [Adding AAA Doorway Triangles](#)
8. [Adding AAA Vent Triangles](#)
9. [Adding Top Pentagon](#)
10. [Moving Dome to Final Position](#)
11. [Connecting Dome to Ground](#)
12. [Final Taping on Dome](#)
13. [Cutting the Plastic Ground Cloth](#)
14. [Doorways, Rain and Wind](#)
15. [Final Touches](#)

---

## 1. Assembly Time and Weather Conditions

[Top of Page](#)

**Assembly Time:** With three people and 2 cordless drills on hand, it took us between three and four hours to put up one dome.

**Weather Conditions:** Don't assemble the dome if wind and/or rain are forecast.

## 2. Nuts, Bolts and Washers

[Top of Page](#)

(1) The amount and sizes of nuts, bolts and washers for one dome are as follow:

- 120 X 1" long 1/4" bolts
- 100 X 1 1/2" long 1/4" bolts
- 220 X 1/4" nuts
- 440 X 1/4" washers



---

## 3. Tools

[Top of Page](#)

- 2 X fully charged cordless drills
- 2 X 7/16" magnetic nut setter bits
- 4 X 7/16" wrenches
- 1 X adjustable wrench (optional)
- awl
- tray or box for nuts and bolts
- tarp
- several props about the length of a broom to help keep up the dome during construction
- duct tape
- sledge hammer
- gloves
- utility knife



- paint brush
- bucket

---

## 4. Preparing Flooring and Work Area

[Top of Page](#)

(1) The dome's carpet and plastic ground cloth serve as one work surface, a tarp serves as a second one.

(2) Decide on a place for the finished dome. Unroll the plastic ground cloth there and then carefully unroll the carpet on top of it. If the carpet was made in several sections be careful not to pull it apart when positioning it. The exact positioning of both the carpet and the dome takes place later on.

(3) Unfold and secure the tarp to create the second work surface.

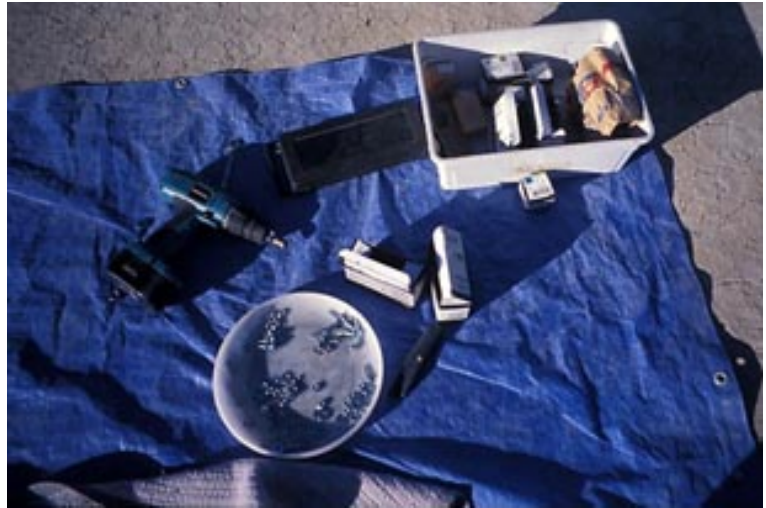

---

## 5. Making the Six ABB Pentagons

[Top of Page](#)

(1) Stack the ABB triangles next to the work area.

(2) Take two triangles. Figure out which edges are the 'B's. Align the 'B' tabs against each other (see diagram opposite), then bolt them together through the bolt holes using a 1" bolt, a nut and a washer on either side of the tabs (see diagram below). To tighten, hold the nut in place with a wrench and, using the lowest setting on the cordless drill, fasten the nut and the bolt securely together using the magnetic nut setter bit. Don't forget the washers! Stop fastening the bolt into the nut when the washers start making an indentation in the cardboard. Do not break the surface of the cardboard as this will weaken the entire structure.

**ABB + ABB**

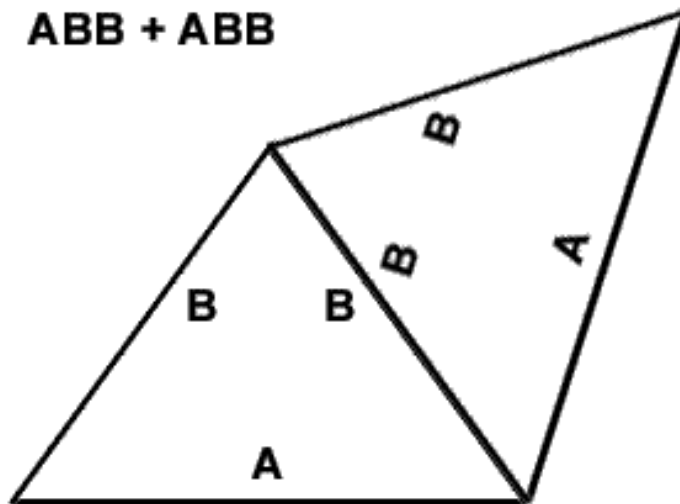

### Connecting the 'B' Tabs

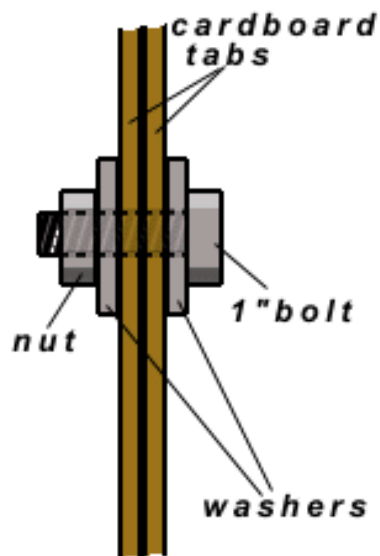

(3) If some of the bolt holes don't align properly, select one of the holes and punch through the opposing tab with an awl to create a new hole. Bolt the tabs together through the new hole.

(4) Add another ABB triangle to the two just connected. Once again connect a 'B' tab to a 'B' tab. At this point of the operation the easiest way to make the bolt connections is to stand the triangles up in a three sided pyramid shape with all the 'A' sides sitting on the work surface (see picture opposite).



(5) Add the fourth triangle in the same way as the third; except that now the pyramid is four-sided.



(6) To add the fifth and final triangle, lay the four connected triangles flat on the ground with the interior facing upward. Connect a 'B' tab to a 'B' tab. It may be necessary to kneel on one of the triangles in order to attach the nut, bolt and washers through the holes closest to the center of the pentagon. If this is the case lay a board or something like it on the cardboard to help spread out the weight and not create dents.

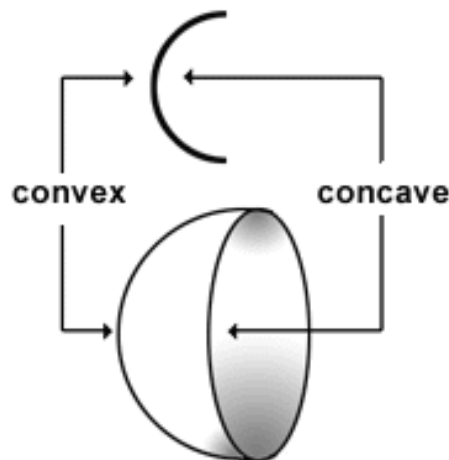

(7) Before connecting the final two tabs the pentagon must be made into its final shape; the exterior must be made convex and the interior concave. When doing this make sure all parts of the tabs are on

the interior, especially the ends that make up the hub of the pentagon.

(8) First bolt the tabs together through the holes closest to the 'A' edge, then through the holes closest to the hub. Finally, bolt the middle holes. If part of the operation involves kneeling on one of the triangles, use a board to spread the weight as in step six.

(9) Repeat these steps till you complete all 6 pentagons.

---

## 6. Duct Taping the Six ABB Pentagons

[Top of Page](#)

(1) To capitalize on work space, stack the finished pentagons one on top of the other.

(2) When duct taping the pentagons everything must be as clean as possible. Wash the dust off your hands. Lay the duct tape on a clean surface, such as a plate, and have a moist rag and a bucket of water on hand for cleaning the pentagons.

(3) Five of the pentagons have one 'A' side that will rest on the ground. The chosen 'A' tab of each pentagon must be cleaned and then duct taped along that edge to prevent rain water from entering. The sixth pentagon will become the roof and should not be edged with duct tape.





## Taping Order of Pentagon

(4) Before applying tape to the exteriors of the pentagons first clean the areas along the 'B' tab joints with a moist rag.

(5) Taking note of the bottom edge of the pentagon, start applying lengths of duct tape over the joints in the following order: first tape the two joints immediately above the bottom, at five o'clock and seven o'clock. Then tape the joints at ten o'clock and two o'clock. Finally apply a length of tape to the upper most joint (see picture opposite). Each of the lengths of duct tape should meet on the central hub. The last piece should overlay the four other pieces. Once again this is to prevent weather from getting in.

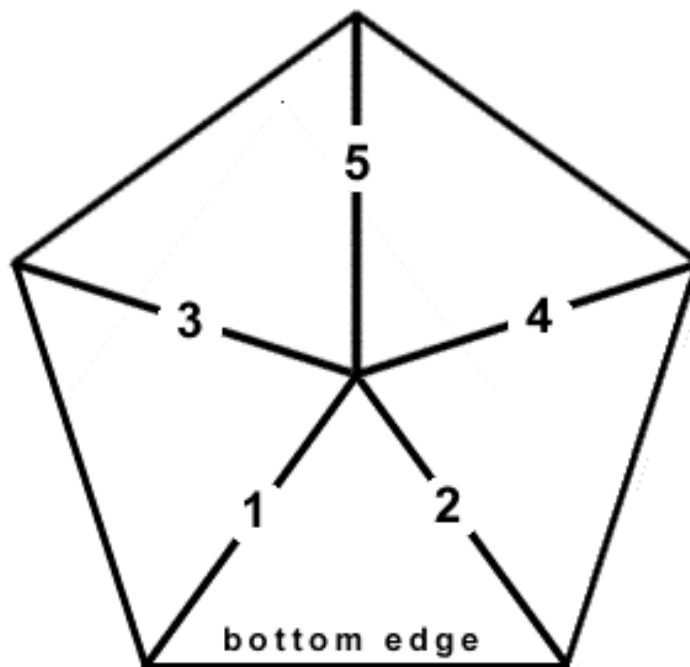

(6) Using a dry rag, buff all the duct tape to ensure good adhesion.

---

## 7. Adding AAA Doorway Triangles

[Top of Page](#)

(1) Attach a AAA doorway triangle to the right side (in relation to the bottom of each pentagon and looking from the inside out). Do this to each of the five wall pentagons using 1 1/2" bolts. (see diagram opposite). The heads of the bolts should be on the inside of the wooden triangle and the nuts on the cardboard side of the 'A' tab of the abutting ABB triangle (see diagram below). If some of the holes don't line up poke a new one from the wood side through to the cardboard side and use that instead.

**Note:** Make sure the velcro side of the AAA doorway triangles is facing outward.

### Pentagon Connected to an AAA Triangle

(this is not drawn to scale and the angles, especially those of the AAA, are not accurately shown)

### Connecting AAA to ABB

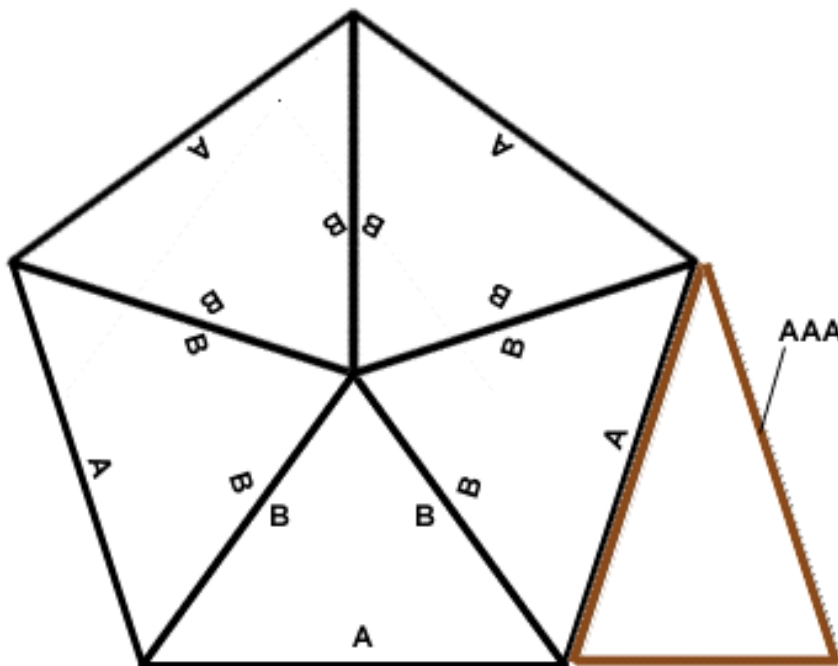
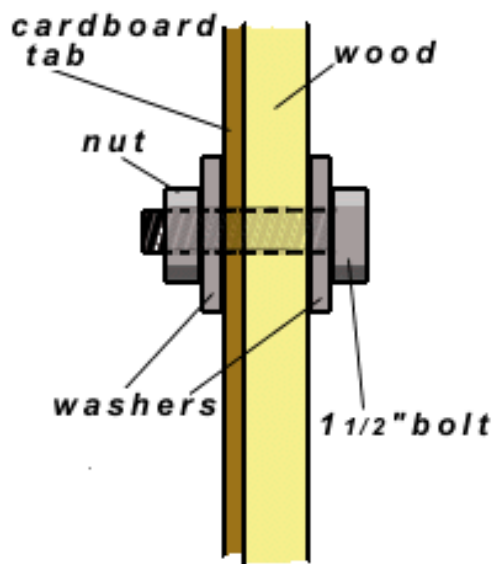

(2) Once all the pentagons have a AAA doorway triangle attached, select two of the pentagon/AAA units and link them together as shown in the diagram opposite.

(3) Select another pair of the pentagon/AAA units and link them together as shown in the diagram. You should now have three units: two pentagon/AAA-pentagon/AAA units and one pentagon/AAA unit.

### Two Pentagons Joined to Two AAA Triangles

(not to scale)

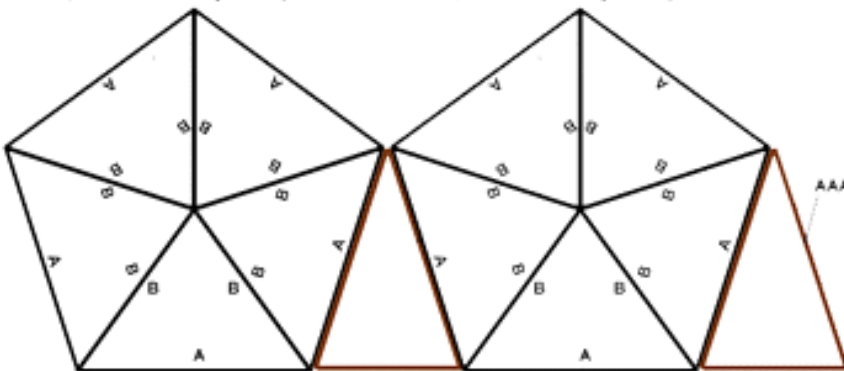

(4) Clear everything from the dome carpet as this will now be the work area.

(5) Place the container holding the nuts, bolts and washers in the center of the carpet along with all the tools required for screwing on the nuts. Add anything that could reasonably be used to help prop up the walls of the dome as it's being build, i.e. a broom or beach umbrella.



(6) The next part of the operation requires two and preferably three or more people.

(7) Move one of the pentagon/AAA-pentagon/AAA units over to the carpet and lay it down.

(8) Move the second pentagon/AAA-pentagon/AAA unit over to the carpet and lay it down.

(9) Stand up the first pentagon/AAA-pentagon/AAA unit and, while one person holds it in place, stand up the second pentagon/AAA-pentagon/AAA unit and move it into place with the AAA triangle of one unit abutting the pentagon of the other unit.

(10) Bolt the AAA triangle to the pentagon. There is a good chance the structure will hold itself up at this point but it is better to have a person or persons supporting the dome from the inside as in the pictures opposite.

(11) Bring the final pentagon/AAA unit over to the carpet and bolt it into place. The bottom of the dome is, at this point, complete, but the structure is still very unstable. Make sure the bottom edges are flat on the ground. This will require some tweaking and patience.

(12) Have at least two people continue to support the inside of the dome.



## 8. Adding AAA Vent Triangles

[Top of Page](#)

(1) When adding the 5 AAA with vents it is a good idea to have a fourth person on hand or a couple of suitable props.

(2) Slot a AAA vent into place between the "v" created by the upper parts of two pentagons. Make sure the vent flap is facing downwards. Connect the AAA vent to the pentagons with 1 1/2" bolts. It doesn't matter in this case whether the bolt head is against the wood or the cardboard. Don't forget the washers! If some holes are mis-aligned poke a new hole with an awl starting from the wood side and use the new hole for the bolt.

(3) Use the props and/or an extra pair of hands as necessary to keep the structure from sagging excessively.

(4) Continue until all five AAA with vents are in place. Once the final vent



is in place the dome will feel sturdier.

**Tip:** during AAA vent connection we have often only connected each vent with two bolts per side to speed up the process. As soon as the final pentagon creates the roof the dome suddenly feels very sturdy. After attaching the roof go back and add the extra bolts to the vents and tighten the others as necessary.

---

## 9. Adding Top Pentagon

[Top of Page](#)

(1) Place the roof pentagon on top of the dome.

(2) Make sure the tabs are on the inside all the way around before adding any bolts.

(3) Connect each of the five roof tabs to the adjacent AAAs with only one nut and bolt per tab (don't forget the washers!). The other nuts and bolts will be added later. This is the quickest method to make the structure sturdy.

(4) The dome is now strong enough for everyone to stop supporting it and help with adding the remaining nuts and bolts.

(5) Once all the nuts and bolts seem to be connected double check everything for missing ones and for those which haven't been sufficiently tightened.

## 10. Moving Dome to Final Position

[Top of Page](#)

- (1) To move the dome to its final spot requires three people at minimum
- (2) Decide on which way the dome is going to be swiveled. Have each person take up a spot on the inside of the dome, spread their arms out as far as possible, take the weight of the dome via the tabs and then as a group rotate the dome into place.
- (3) Make sure the bottom edges don't fold in. Align the decagon shape of the dome with the carpet.

---

## 11. Connecting Dome to Ground

[Top of Page](#)

- (1) Place a wooden gasket on top of the bottom tab of each pentagon (these are the tabs with duct tape on their edges). The gasket should be centered along the length of the tab so that either end is approximately 2" from the corner points of the ABB triangle.
- (2) Insert the rebar horseshoes through the holes in the gaskets. With a sledgehammer pound the rebar directly through the tab and into the ground. Be sure to angle the rebar slightly to allow enough room to swing the sledgehammer without hitting the walls of the dome.

**Tip: Wear gloves!**



## 12. Final Taping on Dome

[Top of Page](#)

(1) The joints where the pentagons meet the AAA vent triangles need to be taped.

(2) As when taping the pentagons, the joints first need to be cleaned with a moist rag, the duct tape should sit on a clean surface between applications and your hands should be clean.

(3) Rub down each taped joint with a dry rag to aid in adhesion.

(4) Do not tape the AAA doorway/pentagon joints

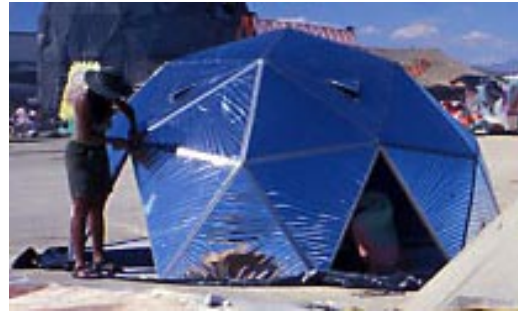

---

## 13. Cutting the Plastic Ground Cloth

[Top of Page](#)

(1) Use a utility knife to cut off the excess plastic visible on the outside of the dome. Try to cut it so that the edge of the plastic is slightly indented in relation to the wall above it.

---

## 14. Doorways, Rain and Wind

[Top of Page](#)

(1) The doorways can be attached and taken off at any time. To attach them simply slot them into place and apply pressure to the areas where the pieces of velcro are. When not in use, try to store them out of the wind.

(2) In the event of rain close the vents as much as possible, attach the doors and then, if desired, stick a small piece of tape over the apex of the doorway to help divert the initial flow of water.

---

## 15. Final Touches

[Top of Page](#)

(1) Use the interior touch-up paint to coat any edges that didn't get sufficient paint during the original process (generally the edges of the tabs). The duct tape around the inside of the vents should first be primed and then painted. Doing all this will make the inside of the dome visually stronger and more coherent.

(2) If any exterior paint was damaged during assembly, prime and repaint those areas as soon as possible.







[Home](#) [Dome Composition](#) [Cardboard Triangles](#) [Wood Triangles](#) [Rebar & Gaskets](#)

[Painting, Vents, Tape & Velcro](#) [Flooring](#) [Assembly](#) [Site Map](#) [Contact](#) [Links](#)

# Site Map

| <a href="#">Home</a> | <a href="#">Dome Composition</a> | <a href="#">Cardboard Triangles</a>                                                                                                                                                                                                                                                                                                                                                              | <a href="#">Wood Triangles</a>                                                                                                                                                                                                                                                                          | <a href="#">Rebar &amp; Gaskets</a>                                                                                                                                                                                                                           |
|----------------------|----------------------------------|--------------------------------------------------------------------------------------------------------------------------------------------------------------------------------------------------------------------------------------------------------------------------------------------------------------------------------------------------------------------------------------------------|---------------------------------------------------------------------------------------------------------------------------------------------------------------------------------------------------------------------------------------------------------------------------------------------------------|---------------------------------------------------------------------------------------------------------------------------------------------------------------------------------------------------------------------------------------------------------------|
|                      |                                  | <ol style="list-style-type: none"> <li><a href="#">Tools</a></li> <li><a href="#">Cardboard</a></li> <li><a href="#">Dimensions</a></li> <li><a href="#">Templates</a></li> <li><a href="#">Drawing</a></li> <li><a href="#">Cutting</a></li> <li><a href="#">Bending ABB Tabs</a></li> <li><a href="#">Making Bolt Holes</a></li> <li><a href="#">Making AAA Cardboard Triangles</a></li> </ol> | <ol style="list-style-type: none"> <li><a href="#">Tools</a></li> <li><a href="#">Wood</a></li> <li><a href="#">Dimensions</a></li> <li><a href="#">Cutting</a></li> <li><a href="#">Drilling Holes</a></li> <li><a href="#">Triangle Assembly</a></li> <li><a href="#">Adding Cardboard</a></li> </ol> | <ol style="list-style-type: none"> <li><a href="#">Rebar Bending Tools</a></li> <li><a href="#">Constructing Rebar Bender</a></li> <li><a href="#">Bending Rebar</a></li> <li><a href="#">Gasket Tools</a></li> <li><a href="#">Making Gaskets</a></li> </ol> |

| <a href="#">Painting, Vents, Tape &amp; Velcro</a>                                                                                                                                                                            | <a href="#">Flooring</a>                                                                                                                                                                                                                                  | <a href="#">Assembly</a>                                                                                                                                                                                                  | <a href="#">Contact</a> | <a href="#">Links</a> |
|-------------------------------------------------------------------------------------------------------------------------------------------------------------------------------------------------------------------------------|-----------------------------------------------------------------------------------------------------------------------------------------------------------------------------------------------------------------------------------------------------------|---------------------------------------------------------------------------------------------------------------------------------------------------------------------------------------------------------------------------|-------------------------|-----------------------|
| <ol style="list-style-type: none"> <li><a href="#">Painting Tools and Equipment</a></li> <li><a href="#">Paintings Methods</a> <ul style="list-style-type: none"> <li><a href="#">Types and Amount</a></li> </ul> </li> </ol> | <ol style="list-style-type: none"> <li><a href="#">Flooring Tools</a></li> <li><a href="#">Selecting Carpet</a></li> <li><a href="#">Measuring and Cutting Carpet</a></li> <li><a href="#">Taping Carpet</a></li> <li><a href="#">Making a</a></li> </ol> | <ol style="list-style-type: none"> <li><a href="#">Assembly Time and Weather Conditions</a></li> <li><a href="#">Nuts, Bolts and Washers</a></li> <li><a href="#">Tools</a></li> <li><a href="#">Preparing</a></li> </ol> |                         |                       |

|                                                                                                                                                                                                                                                                                                                                                                                                                                                                                                                                            |                                             |                                                                                                                                                                                                                                                                                                                                                                                                                                                                                                                                                                                                                                                                                                    |  |  |
|--------------------------------------------------------------------------------------------------------------------------------------------------------------------------------------------------------------------------------------------------------------------------------------------------------------------------------------------------------------------------------------------------------------------------------------------------------------------------------------------------------------------------------------------|---------------------------------------------|----------------------------------------------------------------------------------------------------------------------------------------------------------------------------------------------------------------------------------------------------------------------------------------------------------------------------------------------------------------------------------------------------------------------------------------------------------------------------------------------------------------------------------------------------------------------------------------------------------------------------------------------------------------------------------------------------|--|--|
| <ul style="list-style-type: none"><li>○ <a href="#">of Paint</a></li><li>○ <a href="#">Spraying</a></li><li>○ <a href="#">Painting by Hand</a></li><li>○ <a href="#">Storing the Triangles While They Cure</a></li><li>○ <a href="#">Touch-up Paint</a></li></ul> <ol style="list-style-type: none"><li>3. <a href="#">Making Vents in Upper AAA Triangles</a></li><li>4. <a href="#">Duct Taping Upper AAA Vents</a></li><li>5. <a href="#">Duct Taping Doorway AAA Triangles</a></li><li>6. <a href="#">Velcroing Doorways</a></li></ol> | <p><a href="#">Plastic Ground Cloth</a></p> | <p><a href="#">Flooring and Work Area</a></p> <ol style="list-style-type: none"><li>5. <a href="#">Making the Six ABB Pentagons</a></li><li>6. <a href="#">Duct Taping the Six ABB Pentagons</a></li><li>7. <a href="#">Adding AAA Doorway Triangles</a></li><li>8. <a href="#">Adding AAA Vent Triangles</a></li><li>9. <a href="#">Adding Top Pentagon</a></li><li>10. <a href="#">Moving Dome to Final Position</a></li><li>11. <a href="#">Connecting Dome to Ground</a></li><li>12. <a href="#">Final Taping on Dome</a></li><li>13. <a href="#">Cutting the Plastic Ground Cloth</a></li><li>14. <a href="#">Doorways, Rain and Wind</a></li><li>15. <a href="#">Final Touches</a></li></ol> |  |  |
|--------------------------------------------------------------------------------------------------------------------------------------------------------------------------------------------------------------------------------------------------------------------------------------------------------------------------------------------------------------------------------------------------------------------------------------------------------------------------------------------------------------------------------------------|---------------------------------------------|----------------------------------------------------------------------------------------------------------------------------------------------------------------------------------------------------------------------------------------------------------------------------------------------------------------------------------------------------------------------------------------------------------------------------------------------------------------------------------------------------------------------------------------------------------------------------------------------------------------------------------------------------------------------------------------------------|--|--|





[Home](#) [Dome Composition](#) [Cardboard Triangles](#) [Wood Triangles](#) [Rebar & Gaskets](#)

[Painting, Vents, Tape & Velcro](#) [Flooring](#) [Assembly](#) [Site Map](#) [Contact](#) [Links](#)

# Contact

If you have any questions or comments please contact me at:

[jon@monkeyc.org](mailto:jon@monkeyc.org)

If you prefer snail-mail, please send it to:

**Jonathan Smith**

**920 E. Haley**

**Santa Barbara, CA 93103**



[Home](#) [Dome Composition](#) [Cardboard Triangles](#) [Wood Triangles](#) [Rebar & Gaskets](#)

[Painting, Vents, Tape & Velcro](#) [Flooring](#) [Assembly](#) [Site Map](#) [Contact](#) [Links](#)

## Links

## Related Web Sites

[Burning Man](#): Homepage for the Burning Man Project.

[Geometry](#): A shade structure design by veteran ranger Steve Lerner.

[Desert Domes](#): Useful information for all types of domes.

## Other Web Sites Created by Jonathan Smith

[Monkey C](#): Alternative gamelan music. Check out the Play-along where you can play virtual gamelan instruments online.

[William Charnley's Amazing Art](#): Check out the animated art gallery. Way cool!

[Leonardo's Babes](#): A gallery of female portraits by Leonardo Da Vinci.

[Paige Wilson's Stunning Art](#): Landscapes and still lifes done with flair and attention.

[A Journey Across Tuva](#): An animated shockwave slideshow and short film presentation of a journey across the fabled land of Tuva I made in 2002 with my friend and photographer, David Gala. (Worth seeing. Check out "The Asbestos Mine").

## Search Engines

[Google](#)

[Yahoo](#)



# Geometry

## Ideas for Efficient Desert Architecture

"If you build it, you can come."



Above: the Van Brink-Lerner (WBL) reduced icosahedron dome at BurningMan 1997.

### Contents

Last Updated

Los Angelinos [build a geometry dome on the beach!](#)

Geometry images at the [Orange County Museum of Art](#)

[Marjeta Potrc](#) features Geometry designs in her Extreme Conditions and Noble Designs exhibit.

[Geometry Q&A](#) at the Consuming Places Exhibit, NYC.

[Geometry featured in the Guggenheim Museum, NYC](#)

### Illuminate your structure:

[CoolNeon.com](#) has electroluminescent wire, drivers, kits, and fully assembled EL Wire toys

### Photo Galleries

[View the PhotoGallery of Geometry Domes Here](#)

### Blueprints for structures

**Next** →



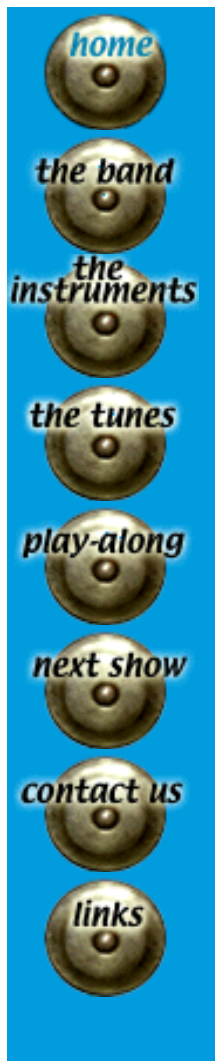

# Monkey C

alternative gamelan



The brazen thunder of **Monkey C** heralds the obliteration of gamelan as we know it--- and its rebirth. Sweeping away the sycophantic suck-up of traditionalism, the saccharine suffocation of "new age", and the stultifying stasis of academe, **Monkey C** creates a world far richer, far deeper--far *stranger*--than any before. Its clarion clangor summons you!

[home](#) [the band](#) [the instruments](#) [the tunes](#) [play-along](#) [next show](#) [contact us](#) [links](#)

[About Bill](#)

[Art Gallery](#)

[News & Reviews](#)

[Animated Art Gallery](#)

[E-mail](#)

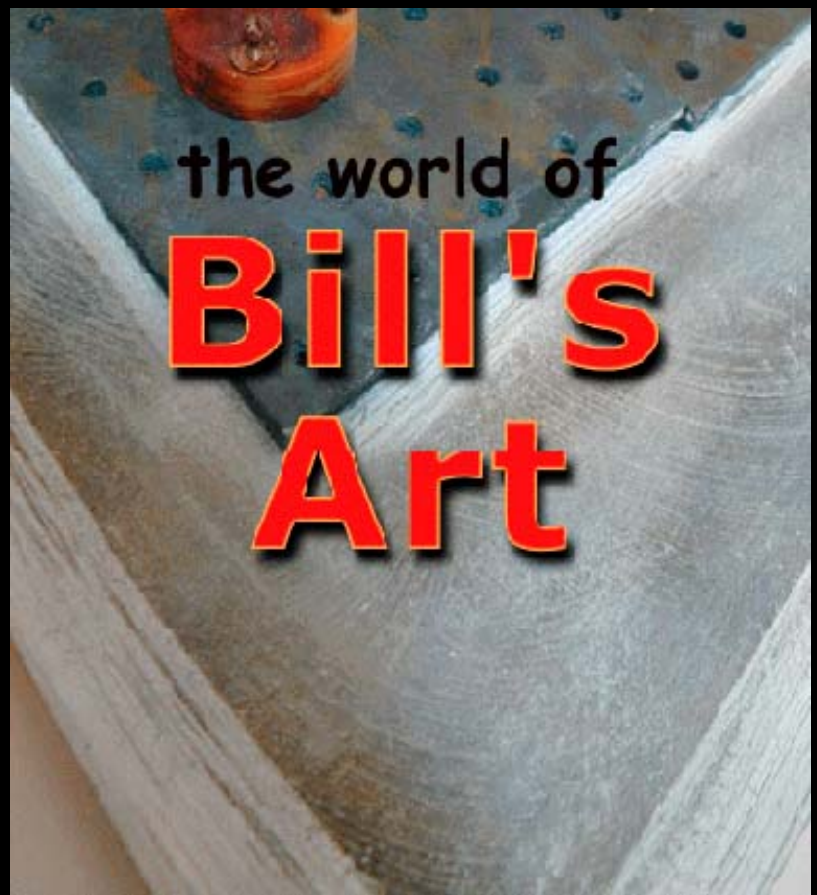

William Charnley's pieces of assemblage are both playful and surreal. He has a unique talent for discovering new ways to view found art and then enhances and embellishes that vision with a mixture of well developed patinas that give each piece a special unity and grace.

©Jonathan Smith 2000

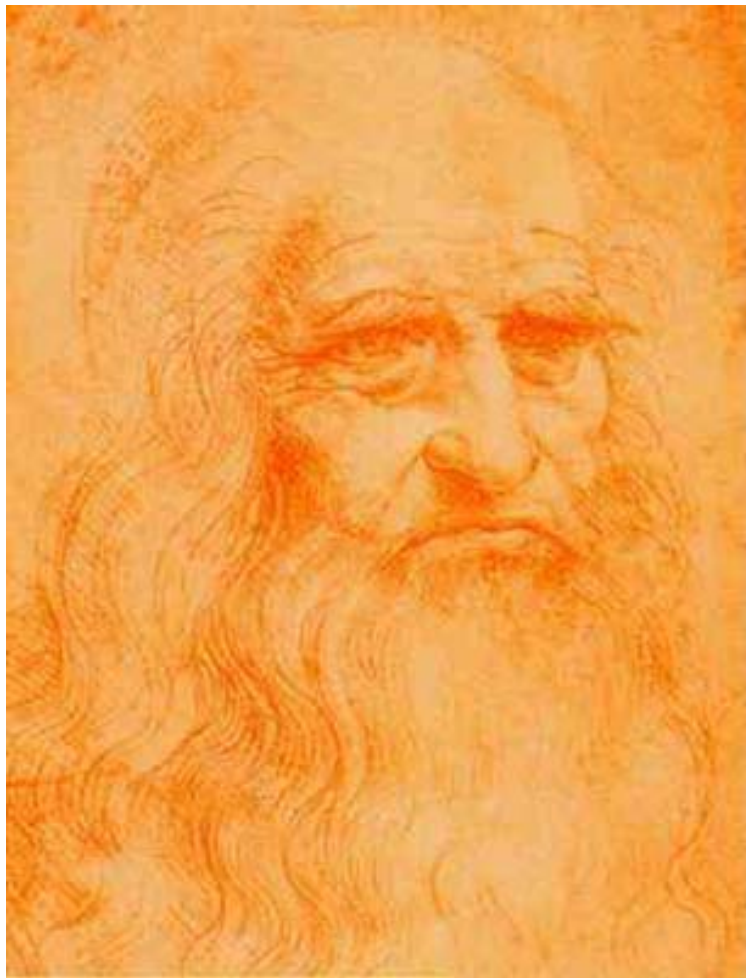

A selection of  
**Female  
Portraits**  
by  
**Leonardo  
da Vinci**

a selection of female portraits by leonardo da vinci

[Home](#) [Biography](#) [Art Gallery](#) [News & Reviews](#) [Contact](#) [Monkey C](#)

# P a i g e W i l s o n



“Painting is about seeing beyond the surface into the depths and the details. It is about complete immersion into the elements of space, form and light and color. Hence, the most prosaic object reveals more intricacy and profundity than ever supposed. My goal is to have you, the viewer, emotionally respond to a simple eucalyptus branch or a china cup. ”

Paige Patterson Wilson

[Home](#)   [Resume](#)   [News](#)   [Landscapes](#)   [Still Lifes](#)  
[Contact](#)



# The Republic of Tuva

In October,2002, I traveled through the Republic of Tuva with my friend David Gala. During our adventures we took a great many pictures and short digital films. I have put these together to create a series of presentations that I hope give some idea of the Republic of Tuva.

[Kyzyl](#): The Capital City.....2,471KB

[A Journey across Tuva](#): An Idea of the Landscape.....1,508KB

[Yurts](#): An Impromptu Visit to a Working Yurt.....2,427KB

[Ak-Dovurak](#): A Dying Mining Town.....1,249KB

[The Asbestos Mine](#): The Asbestos Mine in Ak-Dovurak.....2,780KB

If you have any questions or comments please feel free to [contact](#) us.



**Web** [Images](#) [Groups](#) [News](#) [Froogle](#) [more »](#)

[Advanced Search](#)  
[Preferences](#)  
[Language Tools](#)

[Advertising Programs](#) - [Business Solutions](#) - [About Google](#)

©2004 Google - Searching 4,285,199,774 web pages



[Yahoo! Shopping](#) - [MP3 Players](#), [Digital Cameras](#), [Laptops](#), [Cell Phones](#), [DVD Players](#), [More...](#)

Search for: [Advanced](#)  
[Preferences](#)

- New!** Exclusive Movie Clip: [Bernie Mac in 'Mr. 3000'](#)
- Shop** [Auctions](#), [Autos](#), [Classifieds](#), [Real Estate](#), [Shopping](#), [Travel](#)
- Find** [HotJobs](#), [Maps](#), [People Search](#), [Personals](#), [Yellow Pages](#)
- Connect** [Chat](#), [GeoCities](#), [Greetings](#), [Groups](#), [Mail](#), [Messenger](#), [Mobile](#)
- Organize** [Addresses](#), [Briefcase](#), [Calendar](#), [My Yahoo!](#), [PayDirect](#), [Photos](#)
- Fun** [Games](#), [Horoscopes](#), [Kids](#), [Movies](#), [Music](#), [Radio](#), [TV](#)
- Info** [Finance](#), [Health](#), [News](#), [Sports](#), [Weather](#) [More Yahoo!...](#)

[Sign Out](#)

Personal Assistant

Welcome, mikelob2003 [Acct. Info](#)

Start using [Yahoo! Mail](#) with SpamGuard now!



I'm  seeking

ZIP:

### Yahoo! Games - Downloads



**Featured New Game**  
[Jewel Quest](#)  
Explore over 180 challenging puzzles and secret twists.

More Downloadable Games  
 · [Mahjong Garden](#) · [Scrabble](#)  
 · [Slingo](#) · [More](#)

### In The News

- [Frances knocks out power, floods Florida](#)
- [Russians begin burying victims of attack](#)
- [Former Saddam deputy arrested in Iraq](#)
- [Senator: Commander told of military drain](#)
- [Hurricanes bring environmental renewal](#)
- [U.K. still waiting for wave of Chinese tourists](#)
- [Grizzly bear attacks cyclist in Wyoming](#)
- [U.S. Open](#) · [MLB](#) · [NFL](#) · [NCAAF](#) · [Golf](#)

[News](#) - [Elections](#) - [Sports](#) - [Stocks](#) - [Weather](#)

|                                                                                                                                                                                                                                                 |                                                                                                                                                                                                                                               |
|-------------------------------------------------------------------------------------------------------------------------------------------------------------------------------------------------------------------------------------------------|-----------------------------------------------------------------------------------------------------------------------------------------------------------------------------------------------------------------------------------------------|
| <p><b>Yahoo! Business Services</b></p> <ul style="list-style-type: none"> <li>• <a href="#">Web Hosting</a></li> <li>• <a href="#">Domain Names</a></li> <li>• <a href="#">Sell Online</a></li> <li>• <a href="#">Search Listing</a></li> </ul> | <p><b>Yahoo! Premium Services</b></p> <ul style="list-style-type: none"> <li>• <a href="#">SBC Yahoo! DSL</a></li> <li>• <a href="#">Fantasy Football</a></li> <li>• <a href="#">Personals</a></li> <li>• <a href="#">PC Games</a></li> </ul> |
|-------------------------------------------------------------------------------------------------------------------------------------------------------------------------------------------------------------------------------------------------|-----------------------------------------------------------------------------------------------------------------------------------------------------------------------------------------------------------------------------------------------|

Web Site Directory - Sites organized by subject [Suggest your site](#)

- |                                                                                                                                                                                                                                                                                                                                                                                                                                                                                                                                                                                                                                                                                                                                                                                                                                                                                                                                                                                                             |                                                                                                                                                                                                                                                                                                                                                                                                                                                                                                                                                                                                                                                                                                                                                                                                                                                                                                                                         |
|-------------------------------------------------------------------------------------------------------------------------------------------------------------------------------------------------------------------------------------------------------------------------------------------------------------------------------------------------------------------------------------------------------------------------------------------------------------------------------------------------------------------------------------------------------------------------------------------------------------------------------------------------------------------------------------------------------------------------------------------------------------------------------------------------------------------------------------------------------------------------------------------------------------------------------------------------------------------------------------------------------------|-----------------------------------------------------------------------------------------------------------------------------------------------------------------------------------------------------------------------------------------------------------------------------------------------------------------------------------------------------------------------------------------------------------------------------------------------------------------------------------------------------------------------------------------------------------------------------------------------------------------------------------------------------------------------------------------------------------------------------------------------------------------------------------------------------------------------------------------------------------------------------------------------------------------------------------------|
| <p><b><a href="#">Business &amp; Economy</a></b><br/><a href="#">B2B</a>, <a href="#">Finance</a>, <a href="#">Shopping</a>, <a href="#">Jobs...</a></p> <p><b><a href="#">Computers &amp; Internet</a></b><br/><a href="#">Internet</a>, <a href="#">WWW</a>, <a href="#">Software</a>, <a href="#">Games...</a></p> <p><b><a href="#">News &amp; Media</a></b><br/><a href="#">Newspapers</a>, <a href="#">TV</a>, <a href="#">Radio...</a></p> <p><b><a href="#">Entertainment</a></b><br/><a href="#">Movies</a>, <a href="#">Humor</a>, <a href="#">Music...</a></p> <p><b><a href="#">Recreation &amp; Sports</a></b><br/><a href="#">Sports</a>, <a href="#">Travel</a>, <a href="#">Autos</a>, <a href="#">Outdoors...</a></p> <p><b><a href="#">Health</a></b><br/><a href="#">Diseases</a>, <a href="#">Drugs</a>, <a href="#">Fitness...</a></p> <p><b><a href="#">Government</a></b><br/><a href="#">Elections</a>, <a href="#">Military</a>, <a href="#">Law</a>, <a href="#">Taxes...</a></p> | <p><b><a href="#">Regional</a></b><br/><a href="#">Countries</a>, <a href="#">Regions</a>, <a href="#">US States...</a></p> <p><b><a href="#">Society &amp; Culture</a></b><br/><a href="#">People</a>, <a href="#">Environment</a>, <a href="#">Religion...</a></p> <p><b><a href="#">Education</a></b><br/><a href="#">College and University</a>, <a href="#">K-12...</a></p> <p><b><a href="#">Arts &amp; Humanities</a></b><br/><a href="#">Photography</a>, <a href="#">History</a>, <a href="#">Literature...</a></p> <p><b><a href="#">Science</a></b><br/><a href="#">Animals</a>, <a href="#">Astronomy</a>, <a href="#">Engineering...</a></p> <p><b><a href="#">Social Science</a></b><br/><a href="#">Languages</a>, <a href="#">Archaeology</a>, <a href="#">Psychology...</a></p> <p><b><a href="#">Reference</a></b><br/><a href="#">Phone Numbers</a>, <a href="#">Dictionaries</a>, <a href="#">Quotations...</a></p> |
|-------------------------------------------------------------------------------------------------------------------------------------------------------------------------------------------------------------------------------------------------------------------------------------------------------------------------------------------------------------------------------------------------------------------------------------------------------------------------------------------------------------------------------------------------------------------------------------------------------------------------------------------------------------------------------------------------------------------------------------------------------------------------------------------------------------------------------------------------------------------------------------------------------------------------------------------------------------------------------------------------------------|-----------------------------------------------------------------------------------------------------------------------------------------------------------------------------------------------------------------------------------------------------------------------------------------------------------------------------------------------------------------------------------------------------------------------------------------------------------------------------------------------------------------------------------------------------------------------------------------------------------------------------------------------------------------------------------------------------------------------------------------------------------------------------------------------------------------------------------------------------------------------------------------------------------------------------------------|

### Marketplace

- [Online degree programs](#)



Accredited colleges and universities [Associate](#), [Bachelor's](#), [Master's](#), [Postgrad and more](#).

- [Rugged Gore-tex parka from The North Face](#) - Get ready for outdoor adventure.
- [\\$20 rebate](#) - Panasonic talking caller ID phones. Now you can hear who's calling
- [Find the loan that works for you](#) - Even if you have less than perfect credit.

### Entertainment

[Buzz Index](#) - [Yahoo! Picks](#) - [New Additions](#) - [Full Coverage](#)



• [Yahoo! Movies](#) - [In Theaters This Weekend](#)



[Vanity Fair](#), [Wicker Park](#), [The Cookout](#), [Paparazzi](#), [Hero](#), [Anacondas](#), [Without a Paddle](#), [Princess Diaries 2](#), [more...](#)

• [LAUNCH: Top Videos](#)



Watch the most popular videos: [Ciara](#), [Hilary Duff](#), [Avril Lavigne](#), [Maroon 5](#), [Nelly](#), [more...](#)

[Entertainment](#) - [Games](#) - [Movies](#) - [Music](#) - [TV](#)

### Local Yahoo!s

| Europe                                                                                                                                                                                                               | Asia Pacific                                                                                                                                                                              |                                                                                                                                                                                                                               | Americas                                                                                                                                                                          |
|----------------------------------------------------------------------------------------------------------------------------------------------------------------------------------------------------------------------|-------------------------------------------------------------------------------------------------------------------------------------------------------------------------------------------|-------------------------------------------------------------------------------------------------------------------------------------------------------------------------------------------------------------------------------|-----------------------------------------------------------------------------------------------------------------------------------------------------------------------------------|
| <ul style="list-style-type: none"> <li>• <a href="#">Catalan</a></li> <li>• <a href="#">Denmark</a></li> <li>• <a href="#">France</a></li> <li>• <a href="#">Germany</a></li> <li>• <a href="#">Italy</a></li> </ul> | <ul style="list-style-type: none"> <li>• <a href="#">Norway</a></li> <li>• <a href="#">Spain</a></li> <li>• <a href="#">Sweden</a></li> <li>• <a href="#">UK &amp; Ireland</a></li> </ul> | <ul style="list-style-type: none"> <li>• <a href="#">Asia</a></li> <li>• <a href="#">Australia &amp; NZ</a></li> <li>• <a href="#">China</a></li> <li>• <a href="#">Hong Kong</a></li> <li>• <a href="#">India</a></li> </ul> | <ul style="list-style-type: none"> <li>• <a href="#">Japan</a></li> <li>• <a href="#">Korea</a></li> <li>• <a href="#">Singapore</a></li> <li>• <a href="#">Taiwan</a></li> </ul> |
|                                                                                                                                                                                                                      |                                                                                                                                                                                           | <ul style="list-style-type: none"> <li>• <a href="#">Argentina</a></li> <li>• <a href="#">Brazil</a></li> <li>• <a href="#">Canada</a></li> </ul>                                                                             | <ul style="list-style-type: none"> <li>• <a href="#">Mexico</a></li> <li>• <a href="#">U.S. in Chinese</a></li> <li>• <a href="#">U.S. in Spanish</a></li> </ul>                  |

**U.S. Cities:** [Atlanta](#) - [Boston](#) - [Chicago](#) - [Houston](#) - [LA](#) - [NYC](#) - [SF Bay](#) - [Seattle](#) - [more...](#)

### More Yahoo!

| Guides                                                                                                                                                                                                                                                        | Small Business                                                                                                                                                                                                                                                   | Personal Finance                                                                                                                                                                                                                                                |
|---------------------------------------------------------------------------------------------------------------------------------------------------------------------------------------------------------------------------------------------------------------|------------------------------------------------------------------------------------------------------------------------------------------------------------------------------------------------------------------------------------------------------------------|-----------------------------------------------------------------------------------------------------------------------------------------------------------------------------------------------------------------------------------------------------------------|
| <ul style="list-style-type: none"> <li>• <a href="#">Education</a></li> <li>• <a href="#">Health</a></li> <li>• <a href="#">Lottery</a></li> <li>• <a href="#">Members</a></li> <li>• <a href="#">Pets</a></li> <li>• <a href="#">Yahooligans!</a></li> </ul> | <ul style="list-style-type: none"> <li>• <a href="#">Get a Domain Name</a></li> <li>• <a href="#">Promote Your Business</a></li> <li>• <a href="#">Small Biz Center</a></li> <li>• <a href="#">Sell Online</a></li> <li>• <a href="#">Web Hosting</a></li> </ul> | <ul style="list-style-type: none"> <li>• <a href="#">Banking</a></li> <li>• <a href="#">Bill Pay</a></li> <li>• <a href="#">Money Manager</a></li> <li>• <a href="#">Insurance</a></li> <li>• <a href="#">Loans</a></li> <li>• <a href="#">Taxes</a></li> </ul> |

### [Even More Yahoo!...](#)

**Access Yahoo! via:** [PDAs](#) - [Web-enabled Phones](#) - [Voice \(1-800-My-Yahoo\)](#) - [DSL](#) - [Dial-up](#)

- [Advanced](#)
- [Preferences](#)

[How to Suggest a Site](#) - [Company Info](#) - [Copyright Policy](#) - [Terms of Service](#) - [Jobs](#) - [Advertise with Us](#)

Copyright © 2004 Yahoo! Inc. All rights reserved.  
[Privacy Policy](#)



# A Hopeful Manifesto

Most manifestos are rambling nonsense. This one is no exception.

Part one is a meander through different modes of transformation of human history.

Part two is a sharper and clearer look at basic mistakes which the common approaches to fixing the world have made, and a rough stab at a new synthesis which combines poverty and ecology into a single field.

## Part One: Revolution, Education and Engineering

I believe that there are three separate kinds of flowering in human cultures, one of which is destroyed nearly as soon as it appears, and two of which last for millenia. Unfortunately, we are still addicted to the worst solution, and we waste our talents on it universally.

### 1. Revolution

The first flowering is the revolution. Whether it is Socialist Revolution or the Psychedelic Revolution of the 1960s, or Buckminster Fuller's Design Science Revolution does not matter: the Revolution is an eternal and eternally useless state of affairs.

Because it relies on a "phase transition" in society - a shift from one mode of interaction to another - a revolution requires a constant input of energy to survive. Usually this energy is provided by individuals with vision, social circumstances which act as fuel (and are quickly consumed leaving only ashes) or economic discontinuities which are soon balanced out by the market or by fiat.

When energy is no longer injected into the revolutionary system, it collapses. At best it leaves a broken version of what went before it. At worst, it leaves Stalin. The steam condenses into water, and the water cools into ice. It is as if Woodstock never happened only 30 years after the Hippies would have sworn that the Eternal Summer was only months away.

### 2. Education

The second flowering of human cultures is education. Education is in a very real sense permanent change in the state of the world as knowledge is incredibly difficult to destroy once set down in writing or another eidetic medium. As an example, the geometry of the greeks is omnipresent, and is likely to last as long as the human race: barring cultural discontinuities on a scale we cannot easily find in history, this knowledge will now endure to the ends of our species if not beyond. It has, in effect, grafted itself onto our DNA.

Pythagoras has patched our firmware.

In this sense, I want to suggest that education is, in effect, genetic engineering.

"Memetics" - the idea that memes self-replicate and use our minds and collective institutions as hosts - distinctly underplays the degree of choice and agency we have in forming symbiotic relationships with the conceptual animals we choose to husband.

Democracy is a "meme" in some sense, but not in the shallow pop culture sense. As an "organism", democracy exists in a symbiotic relationship with human culture, more akin to the dog or the horse than to a passing orchid-like fad. Ideas which have been cultivated and refined over thousands of years are additions to our potential as a species. Democracy is like our relationship with the corn or wheat species: a symbiosis which has sustained life.

I want to contrast this again with revolutions: a revolution takes the existing "atoms" and pumps them with energy, producing a new state: the "solid" of Tzarist Russia becomes the "gas" of the Socialist Revolutions but the energy passes, and what is left is a system just as rigid as what went before, but five hundred times more brutal and evil. Education is **chemistry** - new content is added to the system, reactions take place, and by-and-large the changes cannot be undone. Even if a particular democracy fails, the idea will resurface again and again, long after any particular revolution passes.

History is cumulative, but institutions can be washed away essentially without leaving anything other than the fact of their existence behind. There is no hope for long term change through the building of new institutions, because of the inherently revolutionary nature of institution building in most cases.

However, over time, knowledge from these revolutionary forays is integrated into increasingly sustainable patterns of practice, which brings us to the next topic.

### 3. Engineering

Engineering is to the hand as singing is to the voice. Although knowledge, (Education in the #2 sense of the word) is an essential companion to engineering, and is often how the fruits of engineering are transmitted, engineering itself is not a knowing. In a real sense, engineering is the participation of human beings in the process of the creation, making that-which-is-not into that-which-is. Engineering is where we play god in the most tangible and concrete sense. Engineering is creating what we need where it did not exist before, filling in the gaps in God's Work with the works of man. Where God did not provide abundant food, man farmed.

Engineering is how we have made this world habitable. It is farming. It is making clean drinking water. It is **fire** and perhaps even language itself.

AC power transmission is not an idea. Although the know-how to create an AC electrical system is most certainly passed on through education, the artifacts and the maintenance of those artifacts in the world is Engineering. Bright white light at night and a computer to work on are not just ideas: they are collective creations of enormous numbers of skilled humans laboring together to make light where otherwise there would be darkness.

Engineering is the creation and maintenance of artificial structures in the anarchy of creation. And engineering works.

#### **4. Education and Engineering are sufficient**

Buckminster Fuller argued that politics was, in essence, figuring out how to divide limited food (and other resource) supplies - figuring out who would get the scarcity. He proposed that the end to politics, and therefore the end to war, was simply to end scarcity: to create artifacts and practices which would abolish scarcity by transcendentally effective use of the natural world to create plenty everywhere. I think that Fuller was, in essence, right, but too vague on the details to meaningfully change the world. He left us with some first class education, but far too few artifacts.

Revolution has no place at the table.

But education, to widen the scope of what is possible, and engineering, to widen the scope of what is actual, are a pair of pillars from which the roof of a good, whole, just and equitable world could be hung.

### **Part Two: Fix Hell, Not Heaven**

#### **5. Only Two Horsemen Remain**

I believe that there are only two real problems left in the world at the moment: poverty and ecology. Liberal democracy has beaten all comers, in both objective and subjective terms, and while the USA certainly presents some interesting problems, it is unlikely that the current regime can last more than another five or ten years before giving way to a Jimmy Carter or an FDR. The people will not be permanently coerced.

Similarly, although the potential exists for brutal wars and mass murder, and indeed the recent slaughter in the Congo is an excellent example of how hell on earth can erupt at any time, there is no foreseeable war with casualties in the same order of magnitude as the annual death toll from poverty. This was not true of the first or second world war which claimed lives in the scores of millions, but the retreat of Global Thermonuclear War as a living threat, and the relative stability of the current superpowers realigns the relative priority of world problems.

In the 1980s, peace was the only sane priority, as war would simply end us all.

Now, at the start of the 21st century, the real toll of human suffering is not caused by war. It is simply caused by the lack of material goods and food. Our constraint is that the natural world groans under the load that we place upon it by sheer numbers and by careless, unholy and wasteful living.

And this is the balance for the new century: not between war and peace, or between dictatorship and liberty, but between poverty and environmental destruction. The world simply cannot sustain another 5 billion people clawing their way through the industrial revolution which left scars on England which may simply never heal. Yet we cannot expect the poor to simply sit there and starve because their resource extraction needs are unsustainable: each generation would rather live than die, and

there is no tomorrow which matters to a person more than not starving today. Human hunger makes time contract to only the next mouthful of food and, on any given day, around twenty or thirty thousand people simply do not make it to that next mouthful.

But if we expand our "human needs provisioning system" - the "economy" - to a size where all people are provided for at current second-world standards of living, global warming, environmental toxicity, fertile land destruction and the like are going to reduce the world's life-carrying capacity to half or a third of what it is today within one or two hundred years.

So this is the challenge: reduce total environmental impact to a sustainable level, while increasing the amount of "wealth" - human welfare - produced by something like a factor of five or ten.

This is the kind of miracle which only engineering has ever produced in human history. Politics is unable to produce change on that scale: this is going to require a shift on the scale of the invention of farming, or the industrial revolution, just in a different direction.

## **6. Thrift**

To put this on a practical level: I have a new set of shelves, which cost \$15 from K-Mart. These shelves will hold about three hundred pounds, yet weigh less than five pounds total. The thickest piece of metal in the entire structure (not counting the bolts) is probably 1/32 of an inch. It holds weight, but bends to the firm touch. These shelves are a fucking miracle: cheap, efficient, environmentally responsible wonders produced by a penny pinching chinese engineer.

If we're going to make it the world is going to need a lot more of that kind of frugal intelligence. We have basically all of the natural resources we've ever going to have, and some of them are fading fast.

Now we've got to figure out how to make them go far enough.

## **7. Five Principles**

Acting on the failure of revolution and the sheer size of the human problems we are now faced with can, and should, cause a little shock. Once the comforting veneer is stripped away, there are some stark realities to face. We have to step back past the band-aid solutions for one problem or another and face the bigger issues first.

If the problems of poverty and of human environmental impact are cast as a single problem - resource intensive human cultures running into their limits - then I believe that solutions which step outside of the conventional categories of "development" or "environmentalism" become possible.

We have to look at the human ecology of need and fulfillment to find our answers, and then translate what we find into completely concrete engineering. If the solution is not products, and systems which produce products, we have missed the "human needs" part of the equation. If those products and systems are not lean beyond our current comprehension, we've missed the "resource constraints" part of the equation.

## **We have to do it all at once, because no part alone can possibly work.**

These are my first shot at principles for breaking out of the poverty/ecology deadlock and seeing past the apparent contradictions.

1. Poverty and ecology are a single field.

By and large, ecology has started in the west, and this is the very worst place for it. Although we are responsible for a disproportionately large amount of the damage to the world, we are also clearly winners in the current status quo, and as such unwilling to contemplate any change which could jeopardize our position.

By starting with the losers in the current game we can provide immediate aid to those who suffer, while working directly on the problem of finding a new way for humans to live in the world. We have to start where the system has **failed** if we hope to replace it incrementally before global failure occurs.

2. Mass starvation is not sustainable.

800,000,000 people are sick from not getting enough to eat. Engineering, science or business which is grounded in reality has to work for these people. Any system which does not include the poor is as far from sustainability as one can imagine.

3. The developing world needs a safe growth pathway.

In blunt terms, if China, India and Mexico follow America, by the time they are half way to our standard of living, we are all dead. Or, at least, the earth will be several degrees warmer and polluted beyond belief. In addition to helping to feed the poor, we have to figure out how not to have our imitators break the branch on which we so perilously sit.

4. War and Peace are Irrelevant.

None of the current prospective wars are going to destabilize the world more than environmental collapse, nor will they cause more suffering than poverty, nuclear confrontation between America and China excepted. The routine dog-vs-dog border conflicts are, at this point, flesh wounds. The peace movement made a lot of sense as the primary expression of our collective will to live right up until the collapse of the Soviet Union, but it is now outmoded. The total casualties of the **first** Iraq war were equivalent to one month's hunger deaths, max., and the second Gulf War less than a single day's poverty deaths. War is statistical noise on the grinding howl of poverty. Agriculture and the industrial revolution did not rely on peace as a precondition. It is time to get real: war is here to stay, but we can work around it as innovators have had to for millennia.

5. We have more natural resources now than we ever will again.

We're basically done. Fished out, farmed to capacity in many nations, running out of pretty much every kind of available environmental slack. Plans which rest on further environmental extraction are basically doomed, some sooner than others. Any design which rests on "more" is dead as of now.

Most of our economic projections assume that these constraints are not going to

be the major drivers of economic performance in the next century. They are.

I don't know where to go from here. I'm imagining starting over at the beginning, trying to understand the most basic elements of a sustainable lifestyle in the most extreme poverty. To go back and re-examine the basic poverty of, say, the rural village in a poor nation and see if it is possible to engineer that context into something which provides radically more human welfare for each unit of natural resources used, ideally winding up with a sustainable **base** from which to build out.

Anyway, this was intended to be a rant or a manifesto, not a plan. Sue me.

# Mind is Moving

**8/31/2004**

## left

I ve left them all behind now  
sad, alone  
my family dispelled  
move one  
new birth, new death, perhaps  
they ll see me again  
a ghostly echo of their old father  
in their own enlightenment

I know this world needs me  
so much worse if I don t come  
but sometimes I curse the day  
I picked up the phone  
and heard your voices  
say please, begging for relief

the other worlds are quite real  
your artists, poets live there  
scientists, half the time  
in the lab in the heavens  
seeing math

surrender this horrible myth  
that heaven and hell are the only places  
when you die the universe opens!  
and you chose, oh yes, you chose  
go around, and get it right,  
or leave, or try a new way  
a new world  
a fresh start, the eternal America,  
oh yes, Liberty and Freedom reign there  
India, land of my heart,  
a thousand thousand thousand worlds  
each with bullock carts and cow dung fires  
I will sleep better this night  
knowing that one day I go back

Until then, come and ask me if you feel compelled  
I ll take a visitor now and then

And perhaps write a little if I choose.

I had a once a wife and child, left far away  
in the celestial ashram lost in the clouds above the sunset  
and they will go on without me  
into this fine universe  
a river of tears won't bring them back to me  
but perhaps you will

Filed under:

- [General](#)

Vinay @ 10:39 pm

[Comments \(0\)](#)

## 8/30/2004

### swords in the darkness

we re going in again  
night falls  
and the searchlights pierce the sky

hell s gate opened  
and bitter teeth fell  
into the earth of men

history guides, but does not inform  
even the old only know their own story  
and not what really happened

stalking, hot, red, firey, ballistic  
we hunt in tribes  
follow dark paths into new light

hunt the horrors in their holes  
and bring the world back  
return, return, return

Filed under:

- [General](#)

Vinay @ 11:56 pm

[Comments \(0\)](#)



# 8/27/2004

## [the natural rightness of things](#)

I m tired of the illusions of my life  
tired of the story, most of  
the blinders of individuality  
of self

Viraj! Kali Ma! Annhilate this me  
who suffers, who owns, who thinks  
and leave the bliss, hollow, empty,  
cosmic

You already did. Can t destroy  
what does not exist, or wake a man  
who is only pretending to be  
asleep

I m ready, I m so ready!  
Pull all this bullshit back  
and show me who I am!

Filed under:

- [General](#)

Vinay @ 1:43 pm

[Comments \(0\)](#)

# 8/23/2004

## [I am here](#)

and I always was  
this light within  
is not new  
nor it is old  
it has not changed  
not brighter, not faded

but it is here

and I am ready  
to see and be seen  
to know and be known  
to travel and to abide

to live and to love

there is no hell  
and no heaven  
other than your own self and nature

Filed under:

- [General](#)

Vinay @ 1:36 pm

[Comments \(0\)](#)

## 8/21/2004

### [what is the body?](#)

the body is a vehicle for telling stories  
it keeps score  
keeps the plot  
is set and  
manifests props  
illness, old age and death, for instance

a new story  
a new body

Filed under:

- [General](#)

Vinay @ 1:29 pm

[Comments \(0\)](#)

## 8/20/2004

### <http://www.nearlyfreespeech.net/services/hosting.shtml>

[Nearly Free Speech](#) - charge for web hosting based on amount of traffic and disk space used, with no monthly fees.

Filed under:

- [General](#)

Vinay @ 7:26 pm

[Comments \(0\)](#)

# 8/17/2004

## What is Steve Jobs had stayed in India?

In the early 70s, a stoned hippie called Steve Jobs arrived in Benares looking for nirvana. But when he asked a sadhu about the Big N, the savant dragged him to the top of a hillock, shaved his head and let him go. This weird experience convinced Jobs not to ask us why that the N way lay in making the computer as ubiquitous and user-friendly as a bicycle. He set up Apple Computer.

Lots more good stuff there.

Filed under:

- [General](#)

Vinay @ 2:26 pm

[Comments \(1\)](#)

# 8/16/2004

## I ve never seen times like this

I really haven't. reality - at least my little corner of it - is flowing like a liquid, melted and recast. I ve never seen anything like it.

I guess life just goes through these changes sometimes, but this, here, now, is a set of doozies.

Filed under:

- [General](#)

Vinay @ 12:30 pm

[Comments \(0\)](#)

# 8/13/2004

## Polyphonic Spres

I went to see [The Polyphonic Spree](#) tonight. Possibly the most life affirming concert I ve ever seen. They re a little hard to describe& 25-ish people on stage, including a nine-person chorus, several percussionists, a brass section, and a charismatic leader. All in brightly colored robes.

The songs are, well, basically uplifting pop music. But the production is pure musical: think Jesus Christ Superstar meets, well, The Stone Roses or something. [Listen here](#).

Unbelievably cool. There s one section where they just sing, over and over again you gotta be

good, you gotta be strong, you gotta be two thousand places at once to the audience like it s a command, and another where they do the same thing with LOVE, just over and over and over.

Filed under:

- [General](#)

Vinay @ 9:13 pm

[Comments \(0\)](#)

## eating satan

I m choking on your shadow  
but swallowing down  
this knowledge  
pried from all  
the deepest inner hells

With no evil, there s only eden  
only adam and eve  
in their bliss-garden  
ever ever ever

I m done with the world  
had it up to here with the struggles  
I don t care for another victory  
don t care for another triumph  
don t care to fight and win, or lose, or draw

Put it away, mom!  
I m done with hide and seek!  
I can see all these dancers are you  
and I also  
and all this evil and pain  
that s your face  
your smile

kali s the eyeshadow  
on the goddess I know  
and I m out  
and I m never coming back

Filed under:

- [General](#)

Vinay @ 2:34 pm

[Comments \(0\)](#)

# 8/12/2004

## [The Rule Of Domestic Bliss](#)

A man can take care of one entity.

A woman can take care of three entities.

People do not count towards, or contribute towards, their own care except in special cases (witness the "bachelor pad").

Everything living in a house needs taking care of, be it man, woman, dog, cat or other animal. Sufficiently small animals (i.e. rabbits) can be counted in groups.

If the number of entities requiring care exceeds the number of caregivers, disharmony results in rapid resource depletion.

If the number of entities requiring care is less than the amount of available care, somebody will buy a cat.

Filed under:

- [General](#)

Vinay @ 9:36 am

[Comments \(0\)](#)

## [I had no idea&](#)

[85 Watt compact fluorescent bulbs](#) exist - equivalent to 350 watts of incandescent light. And they're fairly inexpensive.

Now, if only

1> they looked nicer

2> they were dimmable

Filed under:

- [General](#)

Vinay @ 8:17 am

[Comments \(1\)](#)

# 8/11/2004

## [a long time ago](#)

Me and my mates used to listen to [The Stone Roses](#) (mp3s and a great picture) and their songs about the Shekhina and the Tree and what-have-you.

Those were good times. I hear they might be reforming, which would make me a happy man, as long as they don't suck.

---

Waxing nostalgic, I do miss my old friend from those days, Mark Nuttall. Mark really was an amazing fellow, whom the sands of time seem to have swallowed. He used to work for IBM in Australia, did some work on object migration, gps, and was a great student of yoga, among other things. We had some great times hanging out. Mark, if you're reading this (the magic of Google, say) get in touch man: there's a [contact link here](#).

Filed under:

- [General](#)

Vinay @ 12:41 pm

[Comments \(0\)](#)

## [two notes](#)

I'm not the only one to have noticed that [Just In Time manufacturing increases our vulnerability to terrorism and other outages](#).

And

Both sides hacked away, hard, at honest vote counting in the 2000 election. That can't go on any too long before the people, disenfranchised, take matters into their own hands in a big way.

Filed under:

- [General](#)

Vinay @ 12:25 am

[Comments \(1\)](#)

## **8/9/2004**

### [bliss mystica](#)

razor's edge again  
spread out across planes  
thin, but unbroken

so close  
to the shift

when the blade turns

and the broad steel road  
cuts no more

Filed under:

- [General](#)

Vinay @ 10:36 am

[Comments \(0\)](#)

## 8/7/2004

### the naked world

layers peeled  
stripped away  
husked

the exterior substrate of life  
can be removed  
leaving the soul  
shivering, sensitive, aware

it looks a lot like dying  
having all comforts  
cut away

i don t know where this goes  
i don t even know why

Filed under:

- [General](#)

Vinay @ 9:48 pm

[Comments \(1\)](#)

### abyss

i stand in the ashes of my own pyre  
i wish it was all gone, burned clean  
but I m caught in the web of life  
in a hundred compound places  
and only hell will set me free

I ve seen this before in my teacher  
bruised, alone, benighted, mad  
sweating crystal bullets

under your gun

a wiser man would never have started

Filed under:

- [General](#)

Vinay @ 6:11 pm

[Comments \(0\)](#)

## 8/6/2004

### [synopsis](#)

three years  
to get back to earth  
as a man

painstaking, destructive,  
winding path

hope and fear died  
only plain certainty remains  
holding my post  
wheel between my sure hands  
sails now open wide

Filed under:

- [General](#)

Vinay @ 1:12 am

[Comments \(0\)](#)

## 8/5/2004

### [it s over for now](#)

whatever the heck I was ploughing through for the last few days seems to have cleared. I m exhausted, but somewhat haler than I had been. It s just been coming in waves.

Filed under:

- [General](#)

Vinay @ 6:07 pm

[Comments \(0\)](#)



# 8/4/2004

## [dharma bomb](#)

they carry terrible weapons  
sly, sneaky ruse  
poison coated razor blades

these naughty children  
we remove their toys  
and give them happiness

Filed under:

- [General](#)

Vinay @ 10:57 pm

### [Comments \(0\)](#)

- Projects

- [Firefighters, Flag, and the Homepage](#)
- [mpass.py - making secure, retrievable passwords](#)
- [My Sustainability Paper for the Danish EPA](#)
- [My Sustainable Economy Model](#)
- [Open Publishing - A Blog, Wiki & File Repository that anybody can use.](#)
- [The Hexayurt Refugee Shelter Design](#)

- Read

- [Boing Boing](#)
- [Cool Tools](#)
- [MetaFilter](#)
- [Open Publishing - A Place Where Anybody Can Write](#)
- [The Daily Grind](#)
- [WorldChanging: Another World Is Here](#)

- Tools

- [Bloglines - simple online aggregator](#)
- [Dreamhost](#) the nice people who host all this
- [MediaWiki - the Wikipedia software](#)
- [WordPress - this blog software](#)

- Categories:

- [General](#)

- [Projects](#)
- [Essays](#)
- [I Never Said I Was Rumi](#)
- [Technology](#)
- [Best Of](#)

● Search:

● Archives:

- [August 2004](#)
- [July 2004](#)
- [June 2004](#)
- [May 2004](#)
- [April 2004](#)
- [March 2004](#)
- [February 2004](#)
- [January 2004](#)
- [December 2003](#)
- [November 2003](#)
- [October 2003](#)
- [September 2003](#)

● September 2004

**S M T W T F S**

[« Aug](#)

1 2 3 4  
5 6 7 8 9 10 11  
12 13 14 15 16 17 18  
19 20 21 22 23 24 25  
26 27 28 29 30

● Other:

- [Login](#)
- [Register](#)

● Meta:

- [RSS 2.0](#)

- [Comments RSS 2.0](#)
- [Valid XHTML](#)
- [WP](#)

Powered by [WordPress](#)

1122

# Hexayurt Diagrams

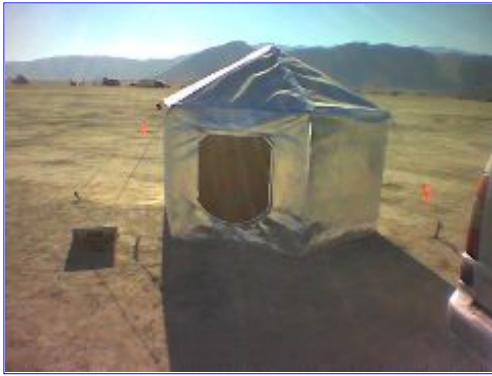

Image(76)

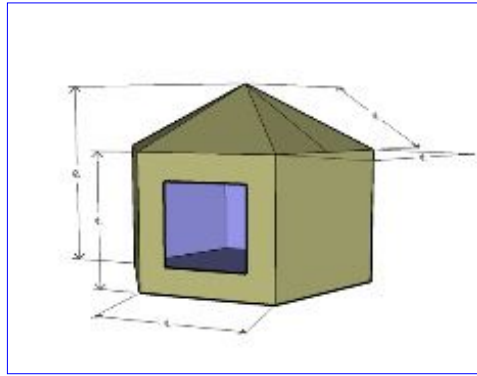

Hexayurt\_2

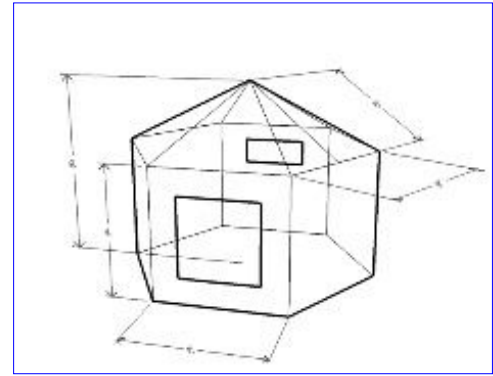

Hexayurt\_wireframe

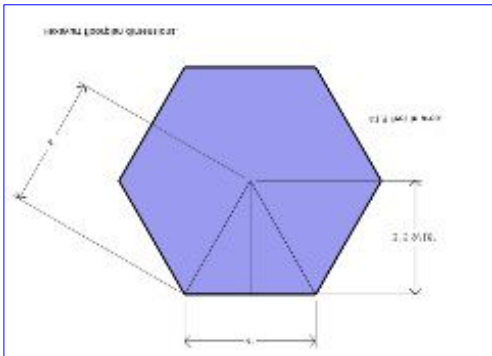

Hexayurt\_base

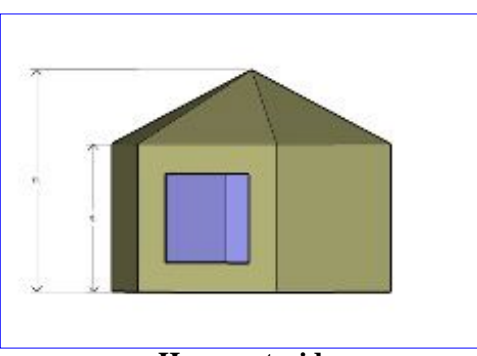

Hexayurt\_side

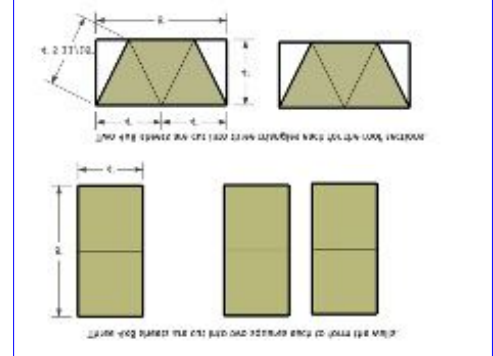

hexayurt\_cutting

# Hexayurt Image Gallery



**Image(98)**



**Image(102)**

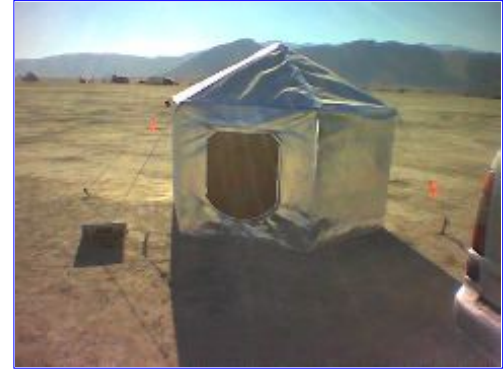

**Image(76)**



**Image(79)**



**Image(100)**



**Image(80)**



**Image(96)**



**Image(92)**



**Image(90)#1**



**Image(88)**



**Image(89)**



**Image(110)**



**Image(103)**



**Image(130)**



**Image(106)**



**Image(112)**



**Image(120)**



**Image(114)**



**Image(118)**



**Image(126)**



**Image(128)**



**Image(132)**



**Image(133)**



**Image(141)**



**Image(147)**



**Image(149)**



**Image(152)**



**Image(157)**



**Image(166)**



**Image(168)**



[Click Here to Register for Siyathemba](#)

[About AFH](#)

[Projects](#)

[Store | Links](#)

[Get Involved](#)



**Project Information**

- [Information and Criteria](#)
- [Submission Guidelines](#)
- [Registration Form](#)
- [About the Jury](#)
- [Site Information and Maps](#)
- [Site Photos](#)
- [Aerial Photograph of Site](#)
- [Local Materials and Labor Costs](#)
- [Local Photos](#)
- [Posters](#)
- [Animation of the basic rules of football](#)

Submissions Due : October 15, 2004

This summer we are challenging designers to create the perfect 'pitch' in Somkhele in [Kwa-Zulu Natal](#), South Africa, an area with one of the highest HIV/AIDS rates in the world. This facility, run by medical professionals from the Africa Center for Health and Population Studies, will serve as a gathering place for youth between the ages of 9 and 14, and will serve as the home for the first-ever girls football league in the area. The pitch will also act as a place to disseminate information on HIV/AIDS prevention and treatment and eventually as a service point for mobile health care.

Three placed finalists and twelve honorable mentions will be selected a [jury](#) of international designers, medical professionals, pro-soccer players and community members. The final decision for the winning design will be chosen by the newly formed Somkhele Girls Football team. The winning design will be announced at the National Building Museum on World AIDS Day, (December 1, 2004) and will be built in Somkhele in 2005. This pitch will be built from entry fees and a donation from the Red Rubber Ball Foundation and a number of individual donors.

If you would like to donate or become a sponsor please contact us [directly](#) or see below for more ways to get involved.

**Siyathemba Media Support**



**Become an AFH member**

Email

Full Name

Company/School

**Other News**

[Wired Interview](#)

[Fortune](#) Magazine names AFH founder as one of the Aspen Seven ([PDF](#))

AFH will be featured on [The Current](#) on CBC Radio One this weekend talking about 'designing like you give a damn' and the ongoing crisis in Sudan.

**Other Projects**



[Sudan: Dying for Change](#)



[Design Charrette for Social Justice](#)  
September 17 - 19, 2004



[Mobile Health Clinic for Africa](#)  
"a remarkable project with great possibility"  
President William J. Clinton

Over the past year many as 50,000 to 100,000 civilians have been killed in the Darfur in western Sudan and close to a million people have been driven from their homes. In the past month refugee camps on the Sudanese border have doubled in numbers.

A team of 15 of us are working in partnership with relief groups in the field on the assessment and strategic planning of existing [refugee and IDP camps](#).

Miami University's Center for Community Engagement in Over-the-Rhine and Architecture for Humanity (AFH) invite you to join designers from around the country come to Cincinnati this September and link design advocacy with social movements addressing homelessness, poverty, and civil rights. This initiative runs in parallel with the 40th anniversary of the [Freedom Summer](#).

[Click here to register and for more info.](#)

In May 2002, architects, designers and medical professionals were challenged to respond to the mounting HIV/AIDS crisis in Sub-Saharan Africa. Design teams were asked to develop schemes for mobile medical unit to provide basic healthcare as well as HIV/AIDS testing, prevention, treatment and education to underserved populations in the region. Over 531 teams answered the call and we are currently developing the winning designs into working prototypes.



[Rebuilding Bam](#)  
Spring/Summer 2004



[Transitional Housing for Kosovo](#)  
1999 - 2000



[Consulting and partnerships with NGOs](#)



## Architecture for Humanity : Design like you give a damn

Drawing on our past efforts to design [transitional housing structures](#) for displaced populations, Architecture for Humanity collaborated with field based NGO, [Relief International](#), to help provide long term housing for thousands of residents left homeless by the tragic earthquake which left over 41,000 dead.

Funds were raised via an [online auction](#) of snowboarding gear from 2004 'Boarder of the year, David Benedek during the XGames. [More info...](#)

Architecture is supposed to provide shelter. In early 1999, nowhere was the need for shelter more critical than in the war-torn region of [Kosovo](#). Hundreds of thousands were without a place to live. Their homes in ruins and the infrastructure of the region collapsed, the returning population needed immediate and highly-dispersed temporary housing.

Five of the ten selected finalists have been built into full-scale prototypes.

Over the last five years our members have donated their time and expertise to NGOs both nationally and internationally. These have included [landmine clearance programs in Kosovo](#), tackling issues of homelessness and low income housing in inner-city America (through our Meetup Groups), urban planning for refugee camps in and around Afghanistan and rebuilding after mudslides on South America.

If you have a project that you are looking for help on, do not hesitate to contact us.

### Contribute to AFH



There are many ways to get involved with AFH. You can [donate](#) towards one of our programs, join a [local meetup chapters](#) or contribute your time by being an [AFH advocate](#). Finally when you sign up to become a member you will receive a monthly newsletter with information and opportunities for designers.

Please note: We are currently [in need of live/work space](#) and a part time bookkeeper.

Architecture for Humanity is a volunteer 501(c)(3) nonprofit organization founded in 1999 to promote architectural and design solutions to global, social and humanitarian crises. Through competitions, workshops, educational forums, partnerships with aid organizations and other activities, Architecture for Humanity creates opportunities for architects and designers from around the world to help communities in need. We believe that where resources and expertise are scarce, innovative, sustainable and collaborative design can make a difference.

"Architecture for Humanity represents the finest of the new breed of architectural leadership, employing architectural skills and directing them for the larger good." -- [Architectural Record](#)

"Where the ideals of Archigram are regarded as a vanguard vision of a mythical future, Architecture for Humanity is a present-day proposal with an immediate social impact" -- [Surface Magazine](#)

### Lectures

MSU, Bozeman, Montana  
ASU, Tempe, Arizona  
Miami University, Oxford, Ohio  
Colorado College, Colorado Springs, CO  
NBM, Washington DC  
The Wolfsonian, FIU, Miami, Florida

### Exhibitions

[larger map](#)



Solos : [Futureshack](#)  
May 14 - October 10, 2004  
[Cooper-Hewitt National Design Museum](#)

### Upcoming Exhibitions

The Voting Booth - Parsons, NYC, US  
[Under A Tenner](#) - Design Museum, UK

### [Store](#)

# Large Hexayurt Diagram

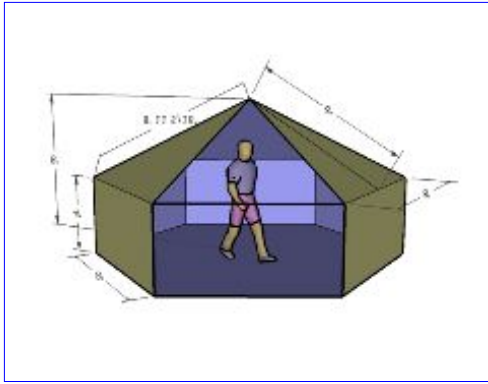

hexayurt\_large

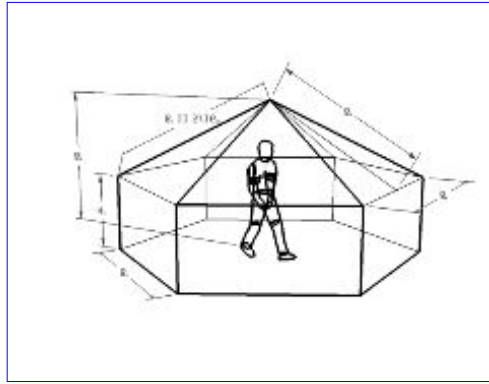

hexayurt\_large\_wireframe

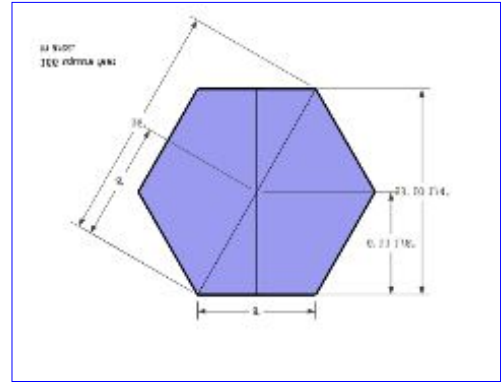

hexayurt\_large\_base

# Mind is Moving

6/20/2004

## Architecture For Humanity Link!

Apparently Cameron s linking [to the hexayurt](#). I d love to get people s feedback, so I m opening a blog entry for people to leave their thoughts, ideas for improvements and general feedback. Please let me know what you think of the design, and what it might be good for!

Filed under:

- [General](#)

Vinay @ 11:33 am

## 1 Comment [»](#)

The URI to TrackBack this entry is: <http://mindismoving.org/blog/wp-trackback.php/744>

1. I was wondering what you thought the best fasteners were for a plywood hexayurt, especially for the apex.

Comment by luke 8/15/2004 @ [4:06 pm](#)

[RSS feed for comments on this post.](#)

## Leave a comment

Line and paragraph breaks automatic, e-mail address never displayed, HTML allowed: <a href="" title="" rel=""> <abbr title=""> <acronym title=""> <b> <blockquote cite=""> <code> <em> <i> <strike> <strong>

Name

E-mail

URI

Your Comment

- Projects

- [Firefighters, Flag, and the Homepage](#)
- [mpass.py - making secure, retrievable passwords](#)
- [My Sustainability Paper for the Danish EPA](#)
- [My Sustainable Economy Model](#)
- [Open Publishing - A Blog, Wiki & File Repository that anybody can use.](#)
- [The Hexayurt Refugee Shelter Design](#)

- Read

- [Boing Boing](#)
- [Cool Tools](#)
- [MetaFilter](#)
- [Open Publishing - A Place Where Anybody Can Write](#)
- [The Daily Grind](#)
- [WorldChanging: Another World Is Here](#)

- Tools

- [Bloglines - simple online aggregator](#)
- [Dreamhost](#) the nice people who host all this
- [MediaWiki - the Wikipedia software](#)
- [WordPress - this blog software](#)

- Categories:

- [General](#)
- [Projects](#)
- [Essays](#)
- [I Never Said I Was Rumi](#)
- [Technology](#)
- [Best Of](#)

- Search:

- Archives:

- [August 2004](#)
- [July 2004](#)

- [June 2004](#)
- [May 2004](#)
- [April 2004](#)
- [March 2004](#)
- [February 2004](#)
- [January 2004](#)
- [December 2003](#)
- [November 2003](#)
- [October 2003](#)
- [September 2003](#)



September 2004

**S M T W T F S**

[« Aug](#)

|    |    |    |    |    |    |    |
|----|----|----|----|----|----|----|
|    | 1  | 2  | 3  | 4  |    |    |
| 5  | 6  | 7  | 8  | 9  | 10 | 11 |
| 12 | 13 | 14 | 15 | 16 | 17 | 18 |
| 19 | 20 | 21 | 22 | 23 | 24 | 25 |
| 26 | 27 | 28 | 29 | 30 |    |    |

● Other:

- [Login](#)
- [Register](#)

● Meta:

- [RSS 2.0](#)
- [Comments RSS 2.0](#)
- [Valid XHTML](#)
- [WP](#)

Powered by [WordPress](#)

1122



**PACTIV**  
Advanced Packaging Solutions

North American  
Products

European  
Products

Contact Us



Company Profile

Investor Relations

News Room

[Read](#) Pactiv's 2nd Quarter Earnings Release

[Listen](#) to replay of our 2nd Quarter Earnings Release conference call on July 23rd

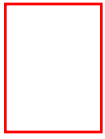

# Under Construction

The site you were trying to reach does not currently have a default page. It may be in the process of being upgraded.

---

Please try this site again later. If you still experience the problem, try contacting the Web site administrator.



Your **Single Source** for **Reflective Insulation Products**

Go Search

Residential  
Commercial  
Industrial  
Agricultural  
Packaging

Products  
Applications  
FAQ

Test Data  
Brochures

Free Samples  
Quote Request

Architects



For over two decades **INNOVATIVE ENERGY** has been a leader in delivering reflective insulation materials to the growing market of energy conservation industries. We offer the most complete line of reflective products in the industry – from products for the [building industry](#) to materials for automotive, [agricultural](#) and [industrial applications](#) and [bags](#) and [boxes](#) designed especially for shipping temperature sensitive materials.

We have complete technical expertise and can advise you on any reflective insulation application. Because of our long association with these types of products, we have encountered just about every use imaginable and can save you much time and effort by freely sharing this knowledge.

© Innovative Energy,  
Inc.  
10653 W. 181st Ave.  
Lowell, IN 46356  
phone 219.696.3639  
Toll Free 800.776.3645  
fax 800.551.3645

[Privacy Policy](#) | [Site Map](#)





**i.e.** INNOVATIVE ENERGY, INC.

Your **Single Source** for **Reflective Insulation Products**



#### Go Search

Residential  
Commercial  
Industrial  
Agricultural  
Packaging

Products  
Applications  
FAQ

Test Data  
Brochures

Free Samples  
Quote Request

Architects

## R+HEATSHIELD®

### R+HEATSHIELD WHITE®

White woven polyethylene film with 99% pure aluminum foil on one side, use R+HEATSHIELD WHITE as an economical radiant barrier insulation in attic spaces or as a reflective support for blown in mass insulation. Standard roll size: 4' x 125'.

[Brochure](#)   [Test Data](#)



### R+HEATSHIELD II®

Woven polyethylene film sandwiched between 1 layer of 99% pure aluminum foil and 1 layer of reflective metalized polyester film. Use R+HEATSHIELD II in hot, humid climates as a vapor and radiant barrier. Stops heat intrusion or loss in buildings and, because of its tear strength and puncture resistance, can span up to eight feet unsupported. Standard roll size: 4' x 250'.

[Brochure](#)   [Test Data](#)

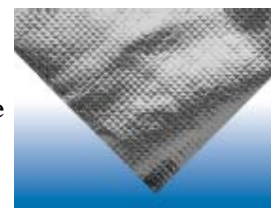

### R+HEATSHIELD III®

Our most popular radiant barrier insulation product -- made of woven polyethylene film sandwiched between 2 layers of 99% pure aluminum foil. R+HEATSHIELD III stops heat intrusion or loss in buildings is available in both perforated and solid. Use the perforated structure when placing directly on top of mass insulation in attic spaces or as a building wrap. Use solid structure in all other applications as a vapor and radiant barrier. Standard roll size: 4' x 125' & 4' x 250'.

[Brochure](#)   [Test Data](#)

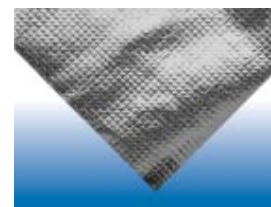

[Reflective Insulation](#) | [Radiant Barrier Insulation](#) | [Foam Board Insulation](#) | [Duct Insulation](#) | [RV Duct Insulation](#) | [Insulated Boxes and Bags](#) | [Foam Floor Underlayment](#) | [Accessories](#)

[Privacy Policy](#) | [Site Map](#)

© Innovative Energy, Inc. 10653 W. 181st Ave. Lowell, IN 46356 phone 800.776.3645 fax 800.551.3645



[©3M 1995-2004](#) [Legal Information](#) [Privacy Policy](#) [Careers](#) | [A-Z Product Index](#) | [Investor Relations](#) | [Corporate News](#)

Select your area of the world to view 3M products and services.

# 3D Design

"SketchUp is the first 3D program I've used that lets me draw the way I think. I'm very, very impressed."  
-- Saveen Reddy, Microsoft



[SketchUp Try & Buy My Account Gallery News & Events Support Training User Forum Company Home International](#)

Award winning SketchUp presents a completely new way to design in 3D on the computer. Developed for the conceptual stages of design, this powerful, easy-to-learn software allows for quick and easy 3D form creation, modification and communication. Sophisticated enough for complex projects yet accessible for beginners, SketchUp allows everyone from Architects to hobbyists to design in 3D. And it plays well with others! SketchUp exchanges data with all standard CAD, 3D modeling, image editing, and illustration applications.

Available for **Mac OS X** and **Windows** – SketchUp is priced at **\$475** as an electronic download.

[Download](#) a free, fully-functional demo copy of SketchUp and start designing in 3D today!

Training is now available for purchase [online](#)

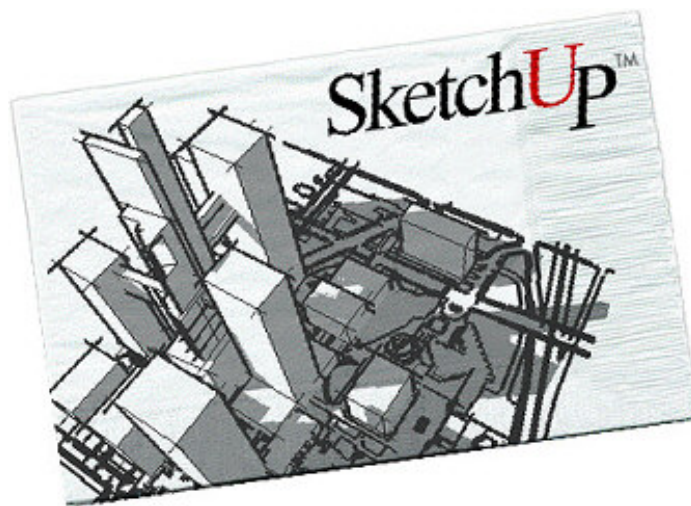

## RECENT NEWS

- [Siggraph: Preview of SketchUp 4 Film & Stage](#)
- [The SketchUp® ESRI plug-in for ArcGIS 9 Preview Release is now available!](#)
- [SketchUp 4.0 Wins Best In Show](#)



- [See SketchUp in Action](#)



- [SketchUp 4.0 is Released!! Upgrade for \\$95!](#)



**Share your designs with others**  
@Last Software's new Viewer allows others to view designs you create in SketchUp™!

**Download Viewer Now!**

Copyright ©2002-2004 @Last Software, Inc. All rights reserved.

[Privacy Policy](#)



# Making Bigger Waves

Three young Canadians know how to make a splash in the engineering world build their own underwater robot for the [2003 ROV \( Remotely Operated Vehicle\) Design Competition](#) at MIT in Boston, June 19 to 21.

The young teens, Virginia Davis and sisters, Sarah and Beckie-Anne Thain, are members of the OSG, or [Oceanography Study Group](#). Their goal is to walk away with the top prize at the second annual ROV Design Competition for high school and college students. Teams from across the U.S. and Canada participate. In fact, this is the OSG s second competition the budding engineers came third in last year s competition at the Kennedy Space Center in Florida. (See "Making Waves", *YES Mag*, Sep/Oct 2002, which you can download, for free, [here](#).)

But can they pull it off again? And can they inch their way up to the top spot? Follow along as the OSG designs, constructs, and tests their new ROV.



Virginia Davis, Sarah Thain, and Beckie-Anne Thain

[Previous](#)
[ROV Home](#)
[Next](#)

|                                   |                                |
|-----------------------------------|--------------------------------|
| <a href="#">Introduction</a>      | <a href="#">April 22, 2003</a> |
| <a href="#">November 25, 2002</a> | <a href="#">April 28, 2003</a> |
| <a href="#">November 28, 2002</a> | <a href="#">May 2, 2003</a>    |
| <a href="#">December 5, 2002</a>  | <a href="#">May 12, 2003</a>   |
| <a href="#">December 19, 2002</a> | <a href="#">May 19, 2003</a>   |
| <a href="#">January 23, 2002</a>  | <a href="#">May 26, 2003</a>   |
| <a href="#">January 30, 2003</a>  | <a href="#">June 3, 2003</a>   |
| <a href="#">February 13, 2003</a> | <a href="#">June 10, 2003</a>  |
| <a href="#">February 28, 2003</a> | <a href="#">June 19, 2003</a>  |
| <a href="#">March 7, 2003</a>     | <a href="#">June 20, 2003</a>  |
| <a href="#">March 14, 2003</a>    | <a href="#">June 21, 2003</a>  |
| <a href="#">March 20, 2003</a>    |                                |

## HOT OR NOT

What do kids think of the latest science books, kits, and software? Our courageous team of reviewers are here to tell you.

[Astronomy](#)[Biology](#)[Chemistry](#)[Earth  
Science](#)[Ecology](#)[General  
Science](#)[Insects](#)[Math](#)[Prehistoric](#)[Technology](#)

[Home](#) | [HTML Home](#) | [Ask Jude](#) | [Projects](#) | [Reviews](#) | [ROVs](#) | [Beyond YES Mag](#)  
[Subscriber Services](#) | [Contact Us](#) | [About Us](#) | [Privacy Policy](#)

Copyright © 2003 Peter Piper  
Publishing Inc.  
Last updated April 14, 2003.

## KIDS, TRY THIS AT HOME

As everyone knows, science is more fun if you get to do something! So explore the archive, print out your favourites, and try them at home.



### YES Mag Flyer

One of the best paper airplane designs! Also, design your own.

### Talk By Lightning Telegraph

Build a telegraph so you can transmit secret messages.

### Soda Bottle Cyclone

See what a tornado's vortex looks like.

### Venus Flytrap

Create your own Audrey.

### Cynthia's Cyclone

Build your own "helicopter".

### Dracula's Dinner

Investigate how red blood cells are able to move through tiny capillaries.

### Paper Chromatography

Separate pen ink into its component colours.

### Makin' Yogurt

Make your own yogurt with this overnight project.

### Super Looper

A flying device with circular wings.

### Crystal Gardens

Crystals aren't alive, but they can grow. Try growing some.

### Robot-like-Hand

Make a hand using cardboard, elastics, and string which simulates a robotic hand.

### Balloon Rockets

Find out how Newton's third law helps take us to the Moon and beyond.

### Geodesic Club House

A newspaper dome that you can fit inside.

### Salt & Vinegar Crystals

Grow some crystals using materials almost everyone has at home.

### BEAM Solarspeeder Kit

See what it would be like to build a real robot from a kit.

### Design a Strong Arm

How strong can you make your cantilever?

### The Leaning Tower of Pasta

Make a giant tower using only spaghetti and marshmallows.

### Easy Epsom Salts Crystals

These crystals have a different shape than the Salt & Vinegar ones.

### Volcano in a Bottle

Use simple household materials to simulate lava flow.

### Put Some Spin on It

This eggs-selent and easy experiment demonstrates Newton's first law.

### Bridge Over Cardboard Water

See how much weight you can get your toothpick bridge to hold.

### Build a Web Page

Learn HyperText Markup Language (HTML) and make your own web page.

### Poppin' Rockets

Use simple household materials to launch a rocket (a film canister) sky high.

### Lightning in a Pan

Make miniature lightning bolts.

### Crazy Chemical Pie

Cook up a storm with this chemical pie!

### Goodie-Goodie Gumdrops Dome

Try making your own low-tech dome out of gumdrops.

### Stereo-Eo-Eo-Eo

You can build a stereoscope from a cardboard box and some pieces of mirror.

### Fantastic Fudge

Check out our Fantastic Fail-Free Fudge.

### Marshmallow Madness

Marshmallows used to be made from the marshmallow plant's root and can be traced way back to no, not China Egypt!

### Make Your Own Mummy

Create and decorate your very own mummy. It takes a bit of time but it's worth it.

### Whip up a Wind Gauge

Create your own anemometer to clock the speed of the wind.

### Home-Made Fire Extinguisher

Break the fire triangle with this "cool" experiment.

## ASK JUDE

Got a science question you've always wanted answered? Then we've got the person for you: our editor Jude is an expert at tracking down answers. A new question will be posted every Friday and all the old questions are available in our archive. Send her your questions now: [askjude@yesmag.ca](mailto:askjude@yesmag.ca).



Why are golf balls dimpled?

What's with the jumping beans?

Is the Red Sea really red?

Why are Rice Krispies so noisy?

How do traffic lights work?

Why do people burp?

Are animals allergic to us?

Why is my nose so stuffy?

Can you spot the sleeping shark?

How fast can you fly?

Are tomatoes fruits or veggies?

What has the largest eyes?

Do compasses work on the Moon?

How can you weaken a magnet?

What has the longest tongue?

Which way does the wind go?

Why don't birds fall in their sleep?

What is your smallest muscle?

Why do onions make you cry?

What colour is polar bear fur?

Is an electric eel really electric?

Is it funny hitting your funny bone?

Why do popsicles stick to tongues?

Why does our hair go grey?

Can fish climb trees?

Why does a cold glass "sweat"?

Why does ear wax smell?

What hits the Moon surface first?

Are twins fingerprints identical?

How many spiders have you eaten?

What is modified corn starch?

How do chameleons change colors?

Why do thistles have spikes?

Do microwaves heat or dry?

How many flaps per second?

What are Saturn's rings made of?

How do cranes get on top of buildings?

Does heat affect growth of crystals?

Why do you yawn when exercising?

Are there any orange trees?

How do binoculars work?

Is there gravity in outer space?

Who invented central A/C?

Are all smelts female?

Does modified corn starch contain yeast?

What is a rhino horn made of?

Where do carrot seeds come from?

Why are there 2 rainbows at once?

How is a star made?

How fast can water freeze?

Do cats and dogs have belly buttons?

Can opera singers shatter glass?

How does light move?

What makes a firefly shine?

Why don't clouds fall out of the sky?

Do animals dream?

What is the largest seed in the world?

Where does the tide go?

Why do bees dance?

Why are we wrinkled after a long bath?

How dangerous is lightning?

Can a potato power a clock?

Why is the sea salty?

Fruits and veggies: Any difference?

How does it rain and snow?

Why do we have puberty?

Does the Moon rotate?

What are fillings (for teeth) made of?

Why don't lizards sunburn?

Why is ice slippery?

Why do our knuckles crack?

Why don't you fall out of a roller coaster?

Do chickens burp?

What is friction?

Can roadrunners fly?

What is the driest place on Earth?

Can the path of light be bent?

How do i disinfect a bird's nest?



[Home](#) | [HTML Home](#) | [Ask Jude](#) | [Projects](#) | [Reviews](#) | [ROVs](#) | [Beyond YES Mag](#)  
[Subscriber Services](#) | [Contact Us](#) | [About Us](#) | [Privacy Policy](#)

Copyright © 2004 Peter Piper  
Publishing Inc.  
Last updated June 25, 2004.

This page requires the Flash 6 plug-in. If this page is not displaying properly please click [here](#).

# Geodesic Clubhouse



Geodesic domes are made of interlocking geometric shapes--often triangles. Because loads are spread over many triangles, these domes are especially strong. Often made of aluminum bars and plexiglass, they're also light compared to ordinary domes.

Geodesic domes were popularized by an American inventor named Buckminster Fuller (1895-1983). Look for the distinctive Bucky-ball shape in museums, greenhouses, alternative housing, and science centres. Vancouver's Science World is a 47-metre tall geodesic dome made of 766 triangles.

## Dome Talk

This project is quickly proving to be our most popular! We often get comments about how much fun families have had building and playing in their own geodesic dome. We think this is wonderful and encourage anyone doing this project to take photos and write us about your dome experience. You can send them to us via email at [web@yesmag.ca](mailto:web@yesmag.ca).

Here are the stories we have received so far...

[Moville Cub Scouts Pack 259](#)

[Fam van Dinther](#)

[Académie de la Capitale](#)

[Daisy Girl Scout Troop #316](#)

[Karen Pierce](#)

[Michael Kiesel](#)

[G. Ray Bodley High School](#)

[Fairland Elementary School Grade 5 Class](#)

[8th Brockville Scout Troop](#)

[St. Edwards School Grade 7 Class](#)

[John Bastianelli's Cardboard Dome](#)

[Kris Fontes' Grade 7 Art Class](#)

[Riverview Elementary School](#)

[AJCC Day Camp](#)

[The Montgomery Family](#)

[Cub Pack 411, Ethridge, Tennessee](#)

[The Terry Family](#)

[College Park Elementary Grade 2 Class \(Fall 2000\)](#)

[College Park Elementary Grade 2 Class \(Fall 1998\)](#)

[Onoway High School Grade 7 Class](#)

[Mr. Lisowyk's Grade 6 Class](#)

[Young Scientist's Club in Winnipeg](#)

[Leigh, Sue, Nick, Andrew, Greg, and Matthew from Halifax](#)

## Materials

- " newspaper
- " doweling or broom handle
- " tape
- " marker pen
- " stapler (and staples)
- " measuring tape

Like a real engineer, you will probably need to rely on teamwork to get this project finished. Why? Because the dome tends to flop over unless it's supported, and stapling is a bit tricky unless you get help holding all the newspaper tubes together.

Using a piece of doweling makes stronger tubes that are harder to staple. Using a broom handle makes slightly weaker tubes that are easier to staple.

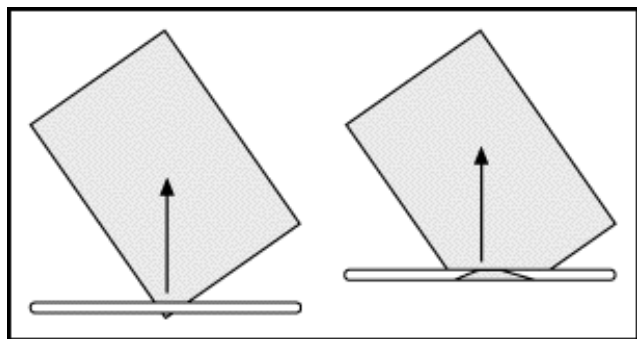

1. Open up a sheet of newspaper. Roll the newspaper around the doweling diagonally from one corner to the other.
2. Cut a piece of tape and stick it to something (preferably not your head) for a minute. Hold the newspaper tube in one hand and gently pull out the dowel with your other hand. If you rolled the newspaper really tightly, you may need to wiggle and twist the dowel a bit. Use the piece of tape to keep the newspaper tube together.
3. Cut the tube to length. [Note: The ends of the tube are not very stiff. To make a stronger tube, make the tube the correct length by cutting some off both ends.] You need a total of 35 newspaper tubes measuring 71 cm and 30 tubes measuring 66 cm. So get busy rolling, measuring, and cutting. Keep the two lengths separated.
4. Use the marker pen to put a mark on the longer newspaper tubes. Now you'll be able to tell the two lengths apart easily. From now on, we will call the marked tubes As, the unmarked tubes Bs.

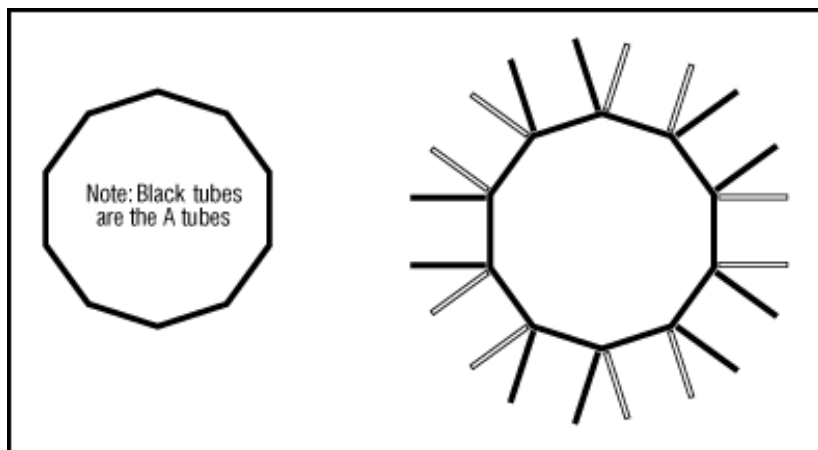

5. Arrange 10 As in a circle.
6. Overlap the ends of two tubes by 2 cm and staple together. Repeat this to form the base of the dome.
7. Lay alternating pairs of As and Bs radiating out from the central circle.

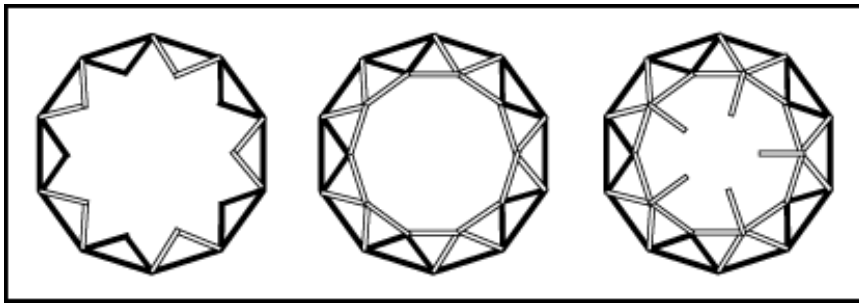

8. Pick up two of the As and form a triangle with them and one of the As from the circle. Staple the joints firmly.
9. Do the same thing with the rest of the tube pairs. You should end up with a circle of triangles poking into the air. Tall triangles should alternate with short triangles.
10. Connect the triangles by stapling a row of Bs across the top.
11. Every point where four Bs come together, staple on another B pointing straight up.

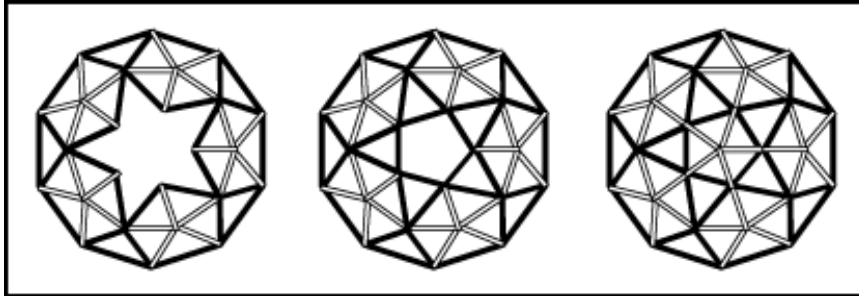

12. Brace the Bs by using two As, one attached to each adjacent joint.
13. Connect the tubes by stapling a row of As across the top.
14. Finish the dome by adding the last five Bs. These tubes come from the five joints and meet in the middle.

[Home](#) | [HTML Home](#) | [Ask Jude](#) | [Projects](#) | [Reviews](#) | [ROVs](#) | [Beyond YES Mag](#)  
[Subscriber Services](#) | [Contact Us](#) | [About Us](#) | [Privacy Policy](#)

Copyright © 2004 Peter Piper  
Publishing Inc.  
Last updated April 2, 2004.

# Geodesic Clubhouse



Dear *YES Mag*,

It was great fun. Our Webelos I made the dome. We had 4 boys and we learned a great deal about team work and material strength. We are thinking about doing another one with tighter paper sticks.

Attached is a picture of the Webelos I group enjoying their snack under their new dome.

Joyce Kizzier  
Cubmaster/Webelos Den Leader  
Moville Cub Scouts Pack 259

[Home](#) | [HTML Home](#) | [Ask Jude](#) | [Projects](#) | [Reviews](#) | [ROVs](#) | [Beyond YES Mag](#)  
[Subscriber Services](#) | [Contact Us](#) | [About Us](#) | [Privacy Policy](#)

Copyright © 2004 Peter Piper  
Publishing Inc.  
Last updated April 2, 2004.

## Geodesic Clubhouse



Dear *YES Mag*,

As a variation on your Geodesic Dome we thought it would be nice to continue and build the full sphere. We were curious if it would be possible to build the sphere and check it's strength.

We made some small changes to the general instructions. First we opted to use a half size news paper so that the dome would actually fit in our lounge. shorter tubes also means stronger tubes. To get the correct diameter tubes we used a simple pencil for the first few windings after which we removed the pencil and continued rolling. On other web-sites we found a simple calculation that would allow us to make any size tubes. Simply multiply the length of the long tube by 0.89 to get the length of the short one. Instead of staples we used split-pens because they allow for a more accurate construction.

Even though the length of the tubes could vary a little, the distance between the holes for the split-pens was measured precisely. Note that the length calculation above applies to the distance between the holes and not the tube length.

We found the project a lot of fun to do and gazed in awe at the finished sphere for quite some time while pointing out the Hexagons, Pentagons and Great circles. Congratulations on such a great way to play with geometry. Please find attached this picture of the completed sphere to your web-site. Once posted I will tell the principal of my son's school to check it out as I am sure they will want to repeat the project.

Construction of the Sphere is quite difficult and will require some planning, proper plan reading (Your illustrations are great) and most of all, team work even more so that with the Dome. Total cost of the project: \$1 for the split pens (Which were retrieved afterwards anyway).

Kind regards

Fam van Dinther  
Auckland, New Zealand

# Geodesic Clubhouse



Dear *YES Mag*,

Our grade 3 / 4 class built one as part of a unit on structures. Can you include us in the list of pictures for that project on your web site ? Attached is our picture.

We are Académie de la Capitale in Ottawa, Ontario

[www.acadecap.org](http://www.acadecap.org)

[Home](#) | [HTML Home](#) | [Ask Jude](#) | [Projects](#) | [Reviews](#) | [ROVs](#) | [Beyond YES Mag](#)  
[Subscriber Services](#) | [Contact Us](#) | [About Us](#) | [Privacy Policy](#)

Copyright © 2003 Peter Piper  
Publishing Inc.  
Last updated December 18, 2003.



# Geodesic Clubhouse



Dear *YES Mag*,

Attached please find a photo of our geodesic dome. Sorry about the strings. The photo did not come out the first time so we had to re-construct it at a later time. I hope you like it as much as we did. It was a fantastic project even for kids ages 5-6.

Marcie Roche

Troop Leader

Daisy Girl Scout Troop #316

South Londonderry, Vermont

[Home](#) | [HTML Home](#) | [Ask Jude](#) | [Projects](#) | [Reviews](#) | [ROVs](#) | [Beyond YES Mag](#)  
[Subscriber Services](#) | [Contact Us](#) | [About Us](#) | [Privacy Policy](#)

Copyright © 2003 Peter Piper  
Publishing Inc.  
Last updated May 29, 2003.

# Geodesic Clubhouse



Dear *YES Mag*,

Wow! What a fun way to spend a Sunday afternoon. My kids and I just finished building this dome. I'm attaching a picture. I am an enrichment teacher at a local elementary school and planned to do this with my students. It was fun to practice with my own kids at home first.

Thanks! I love your site...great activities!!

Karen

[Home](#) | [HTML Home](#) | [Ask Jude](#) | [Projects](#) | [Reviews](#) | [ROVs](#) | [Beyond YES Mag](#)  
[Subscriber Services](#) | [Contact Us](#) | [About Us](#) | [Privacy Policy](#)

Copyright © 2003 Peter Piper  
Publishing Inc.  
Last updated April 14, 2003.

# Geodesic Clubhouse



Dear *YES Mag*,

While looking for geodesic homes, I found your website and decided to start with a really small geodesic home first.

Find enclosed a pictured of our daughter Alexandra (5) who enjoys sitting under her mini dome (we used ordinary letter format paper instead of newspaper).

I also made a little web page to show the building process.

<http://mkiesel.tripod.com/geo-dom/>

Thanks for the great project!

Best regards

Michael Kiesel

Munich, Germany

[Home](#) | [HTML Home](#) | [Ask Jude](#) | [Projects](#) | [Reviews](#) | [ROVs](#) | [Beyond YES Mag](#)  
[Subscriber Services](#) | [Contact Us](#) | [About Us](#) | [Privacy Policy](#)

Copyright © 2003 Peter Piper  
Publishing Inc.  
Last updated April 14, 2003.

## Geodesic Clubhouse



Dear *YES Mag*,

Thanks for the information on making the newspaper dome. We put our own spin on your project. Instead of using tape or staples, punched holes and used paper fasteners to hole the papers together. It achieved a much cleaner dome. It also demonstrated that the proper angles are automatically formed. We rolled the papers on a 5/8" dowel and punched holes 1"

from each end. For temporary fasteners we used pipe cleaners until we had all of the tubes in place, then we use the paper fasteners. My students focused on the six pentagons because they could visualize the pattern as the dome was being constructed. I've attached some pictures. Nice project. Thanks for your help!

RV Hill  
G. Ray Bodley High School

[Home](#) | [HTML Home](#) | [Ask Jude](#) | [Projects](#) | [Reviews](#) | [ROVs](#) | [Beyond YES Mag](#)  
[Subscriber Services](#) | [Contact Us](#) | [About Us](#) | [Privacy Policy](#)

Copyright © 2003 Peter Piper  
Publishing Inc.  
Last updated April 14, 2003.

# Geodesic Clubhouse



Dear *YES Mag*,

My fifth grade class has been studying structures in science. We visited the National Building Museum in Washington, D.C. where we made a geodesic dome with plastic pipes and clothesline. We enjoyed that so much that when we found the plans for the geodesic playhouse we had to try it out! The class worked in six teams to roll the tubes. Then, we all worked together to assemble it. We were so proud of our dome that the principal let us display it in the front hallway. I will definitely do this project again next year!

Sincerely,

Dawn Hester

Fairland Elementary School

Silver Spring, MD

PS Unfortunately, many students were out sick the day we took this picture.

[Home](#) | [HTML Home](#) | [Ask Jude](#) | [Projects](#) | [Reviews](#) | [ROVs](#) | [Beyond YES Mag](#)  
[Subscriber Services](#) | [Contact Us](#) | [About Us](#) | [Privacy Policy](#)

Copyright © 2003 Peter Piper  
Publishing Inc.  
Last updated April 14, 2003.

# Geodesic Clubhouse



Dear *YES Mag*,

I am a junior leader with the 8th Brockville scout troop based in Brockville, Ontario. I myself have subscribed to your magazine and found the Geodesic dome instructions on your web page. I built one at home before taking the directions to my scout troop. Last week we built 4 domes. I have enclosed some pictures of each one. It was a lot of fun and we might do it again next year. You can also find the pictures on our [website](#)!

Nevin McFarlane  
8th Brockville Scout Troop

[Home](#) | [HTML Home](#) | [Ask Jude](#) | [Projects](#) | [Reviews](#) | [ROVs](#) | [Beyond YES Mag](#)  
[Subscriber Services](#) | [Contact Us](#) | [About Us](#) | [Privacy Policy](#)

Copyright © 2003 Peter Piper  
Publishing Inc.  
Last updated April 14, 2003.

# Geodesic Clubhouse



Dear *YES Mag*,

My seventh grade class at St. Edwards School in Herminie, PA is very small, only one boy and five girls. As an introduction to the Geometry chapter in Pre-Algebra we decided to build the Geodesic Club House as a group project. We read through the letters on your website, gathered some worthwhile tips, and printed out the directions. Working in groups of three, it took us four class periods of rolling, cutting, and taping to get it completely assembled. The project kept everyone interested and involved. All six students easily fit inside and enjoy having geometry lessons there with line segments, angles, triangles, and pentagons close at hand. Our dome is the envy of the other students and the pride of seventh grade. Thank-you for your terrific idea.

Miss Faith Rich

[Home](#) | [HTML Home](#) | [Ask Jude](#) | [Projects](#) | [Reviews](#) | [ROVs](#) | [Beyond YES Mag](#)  
[Subscriber Services](#) | [Contact Us](#) | [About Us](#) | [Privacy Policy](#)

Copyright © 2003 Peter Piper  
Publishing Inc.  
Last updated April 14, 2003.



# Geodesic Clubhouse

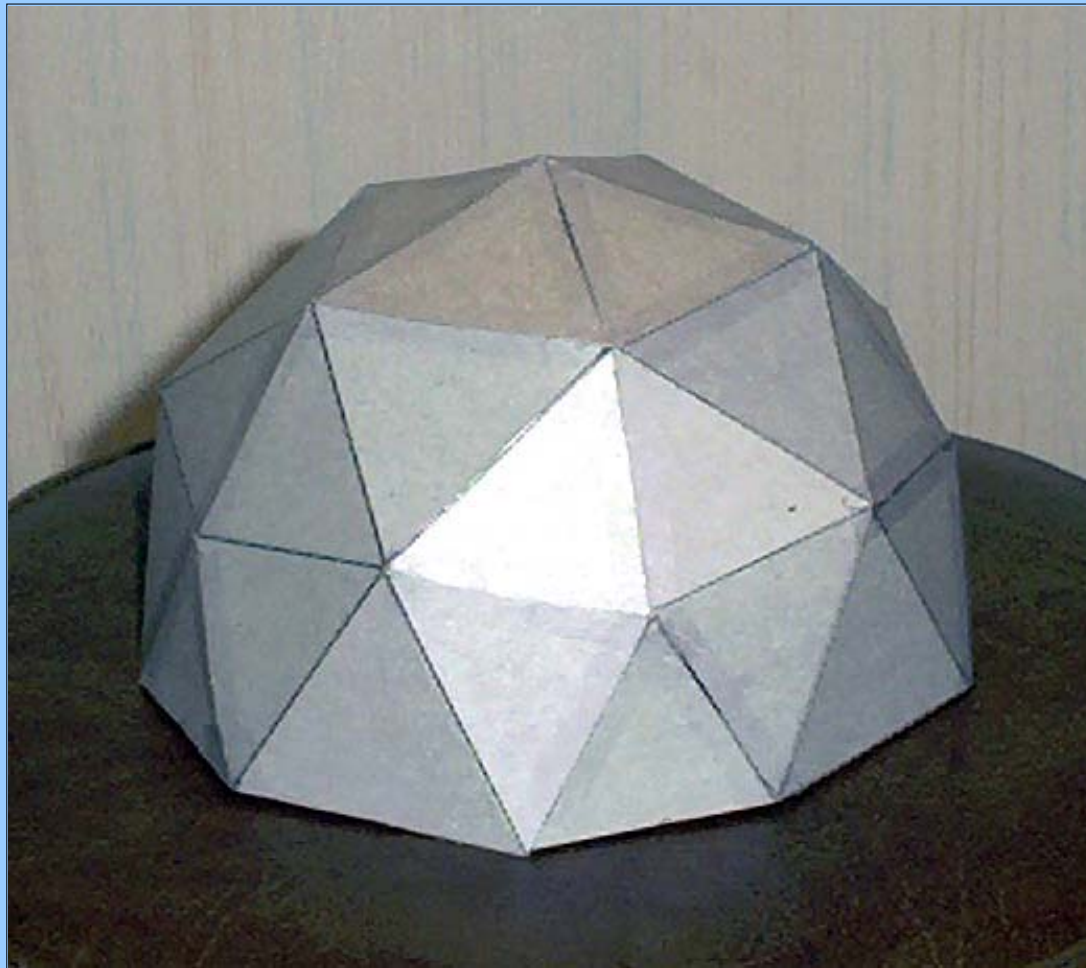

Dear *YES Mag*,

I'm an 84 year retired builder and I built a full sized geodesic dome quite a few years ago. I tried making a model of your dome using toothpicks and scaling down the dimensions but it turned out to be a real mess using a glue gun. So I made one from cardboard and it turned out pretty good. Enclosed find the picture.

Respectfully,  
John Bastianelli

[Home](#) | [HTML Home](#) | [Ask Jude](#) | [Projects](#) | [Reviews](#) | [ROVs](#) | [Beyond YES Mag](#)  
[Subscriber Services](#) | [Contact Us](#) | [About Us](#) | [Privacy Policy](#)

Copyright © 2003 Peter Piper  
Publishing Inc.  
Last updated April 14, 2003.

# Geodesic Clubhouse



Dear *YES Mag*,

I teach seventh grade art and have been teaching the geodesic dome for about three years. Because of the logistics of storing the large domes, I have my students create head pieces/hats from the dome. We use the same procedure, just smaller. The newspaper logs are made from only two small squares and cut to about five and a half inches each. The students then use their imaginations and anything they can gather to embellish their creations. This is a very popular project!

Kris Fontes

[Home](#) | [HTML Home](#) | [Ask Jude](#) | [Projects](#) | [Reviews](#) | [ROVs](#) | [Beyond YES Mag](#)  
[Subscriber Services](#) | [Contact Us](#) | [About Us](#) | [Privacy Policy](#)

Copyright © 2003 Peter Piper  
Publishing Inc.  
Last updated April 14, 2003.

# Geodesic Clubhouse



Dear *YES Mag*,

My first grade class, at Riverview Elementary in Big Rapids, Michigan, made a 2v dome from your lesson plan, for our annual science share. We loved this project!

Thanks,  
Scott Rose

[Home](#) | [HTML Home](#) | [Ask Jude](#) | [Projects](#) | [Reviews](#) | [ROVs](#) | [Beyond YES Mag](#)  
[Subscriber Services](#) | [Contact Us](#) | [About Us](#) | [Privacy Policy](#)

Copyright © 2003 Peter Piper  
Publishing Inc.  
Last updated April 14, 2003.

# Geodesic Clubhouse

Dear *YES Mag*,

At the Augusta Jewish Community Center Day Camp, Augusta, Georgia, USA, a bunch of the 9-10 year olds set out to build the Geodesic Club House. Here are their words:

**Jessie Smith (Councilor):** A few of our kids were getting restless during group time so I took them to the art room to find something to do. The art teacher/co-director, Mrs. Hoops, suggested the geo dome from your website. The kids jumped at the idea almost immediately. As soon as we got the directions the kids sat down and assigned jobs per instructions. They formed an assembly line and worked hard at their own particular job and as a team. Even though the geo dome fell a few times, the kids were determined to get it together. They even fortified the joints with masking tape to give extra support. I'm truly proud of them.

**Emily S.:** When we first started, we made an assembly line. An assembly line, is a line of people who each have a certain job to do to help put something together. So of course, we each had a certain job to do. It was fun!!

**Ben M.:** We needed six people to do the fort. The counselor Jessie helped us with the fort. One was the tap man. It took us two days to build the fort. It was very fun. The next day Ms. Christy told us to come and write this.

**Morgan W.:** We were bored out of our skulls in the game room. Our councilor suggested to build the geo dome. We worked hard doing this. When we were done we took pipe cleaners and streamers and decorated the fort. We hung a piece of paper and wrote our group name on it. I hung most of the streamers. Danielle, Ben, Emily, and Jackie hung most of the pipe cleaners. Kristen was the first to get in the fort when it was finished.

**Kristen H.:** Well we were getting bored, so we all went to the art room to see what we could make. We all looked for something to do. We found a cool thing that is called club house made out of newspaper.

**Danielle P.:** Other kids from our camp tried to build it but they didn't follow directions and messed up. The next day those kids didn't even come back and try it again.

**Jackie Leigh F.:** It took a few times to get the fort to stand up because the newspaper was weak, but our councilor came up with the idea of putting tape on the joints. It was hard but we stuck together. When we made mistakes we went back to fix them. Everybody had a certain job of holding each pole. Everybody was amazed when we finished, even us.

Thanks for a great project,  
The kids of the AJCC Day Camp

# Geodesic Clubhouse



Dear *YES Mag*,

We had a lot of fun making our geodesic dome! We did it in two parts, one night rolling, measuring, and cutting (black smudgy hands). Days later we invited friends to help construct.

L - R: Michael (10) Miranda (10) Corey (10) and Hannah (2)

They thought the dome would be even cooler if it had a sheet over it, or if we flipped it over and did the same thing to make a big ball. We opted for the sheet which made the dome last only a few minutes longer (especially with a 2 year old around).

Great Idea, Thanks!

The Montgomerys

[Home](#) | [HTML Home](#) | [Ask Jude](#) | [Projects](#) | [Reviews](#) | [ROVs](#) | [Beyond YES Mag](#)  
[Subscriber Services](#) | [Contact Us](#) | [About Us](#) | [Privacy Policy](#)

Copyright © 2003 Peter Piper  
Publishing Inc.  
Last updated April 14, 2003.

# Geodesic Clubhouse



Dear *YES Mag*,

I am the Cubmaster for Pack 411, Ethridge, Tennessee. Here's a photo of our completed dome.

We took on this project to complete a requirement of engineering for our Webelos Scouts. With the help of the entire pack, we built this 2 frequency Dome.

12 kids ranging from age 6 to 11 took only 1.5 hours to complete! It was great fun, and teaches teamwork, measuring skills, cutting skills, following directions and plans, the list of good things goes on and on.

Our kids had a great time building and even better one when we finished (after photos) it lasted 30 sec! Tearing it down was as much fun as building it.

Thanks for your web site and the great idea!

Micky Ezell

[Home](#) | [HTML Home](#) | [Ask Jude](#) | [Projects](#) | [Reviews](#) | [ROVs](#) | [Beyond YES Mag](#)  
[Subscriber Services](#) | [Contact Us](#) | [About Us](#) | [Privacy Policy](#)

Copyright © 2003 Peter Piper  
Publishing Inc.  
Last updated April 14, 2003.

# Geodesic Clubhouse

Dear *YES Mag*,

My family spent a snowy winter afternoon creating this dome. My four children range from 2 years to 10 years of age. We found something for everyone to do. My 2 year old picked up all the scraps and threw them away. The 5 year old pulled off pieces of tape for the tubes. The 7 and 10 year olds measured and counted the A and B tubes. Everyone helped in the construction. They have spent many hours playing in it. Thank you so much for your web page it made a boring afternoon fun.

Sincerely,  
Mary Terry

[Home](#) | [HTML Home](#) | [Ask Jude](#) | [Projects](#) | [Reviews](#) | [ROVs](#) | [Beyond YES Mag](#)  
[Subscriber Services](#) | [Contact Us](#) | [About Us](#) | [Privacy Policy](#)

Copyright © 2003 Peter Piper  
Publishing Inc.  
Last updated April 14, 2003.

# Geodesic Clubhouse



Dear *YES Mag*,

This is David Weir from College Park Elementary School again. Two years later and another class and I have made the Geodesic Dome. I have attached the photo and hope you will post it next to the previous one for a sense of history.

Thanks, the kids loved doing it,

David Weir

Grade 2 Teacher

College Park Elementary School

Port Moody, B.C.

Please drop by our web site: <http://www.geocities.com/Athens/Parthenon/5567/>.

[Home](#) | [HTML Home](#) | [Ask Jude](#) | [Projects](#) | [Reviews](#) | [ROVs](#) | [Beyond YES Mag](#)  
[Subscriber Services](#) | [Contact Us](#) | [About Us](#) | [Privacy Policy](#)

Copyright © 2003 Peter Piper  
Publishing Inc.  
Last updated April 14, 2003.



# Geodesic Clubhouse

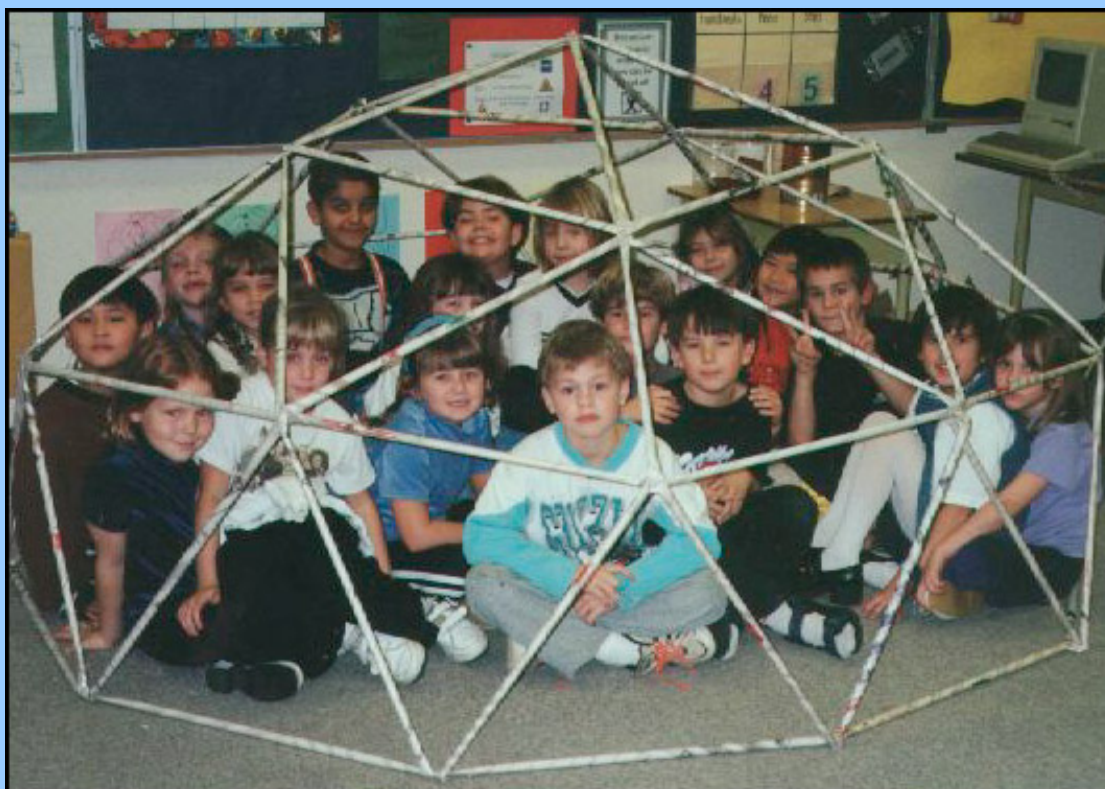

Dear *YES Mag*,

I just thought I would drop you a line to let you know that we constructed the geodesic dome from your lesson plan. The kids loved it and I got a ton of positive comments from staff and parents as well. Thanks for providing the resource. I have attached a picture of my grade two class inside the dome.

Thanks again,

David Weir

Grade 2 Teacher

College Park Elementary School

Port Moody, B.C.

Please drop by our web site: <http://www.geocities.com/Athens/Parthenon/5567/>.

[Home](#) | [HTML Home](#) | [Ask Jude](#) | [Projects](#) | [Reviews](#) | [ROVs](#) | [Beyond YES Mag](#)  
[Subscriber Services](#) | [Contact Us](#) | [About Us](#) | [Privacy Policy](#)

Copyright © 2003 Peter Piper  
Publishing Inc.  
Last updated April 14, 2003.

# Geodesic Clubhouse

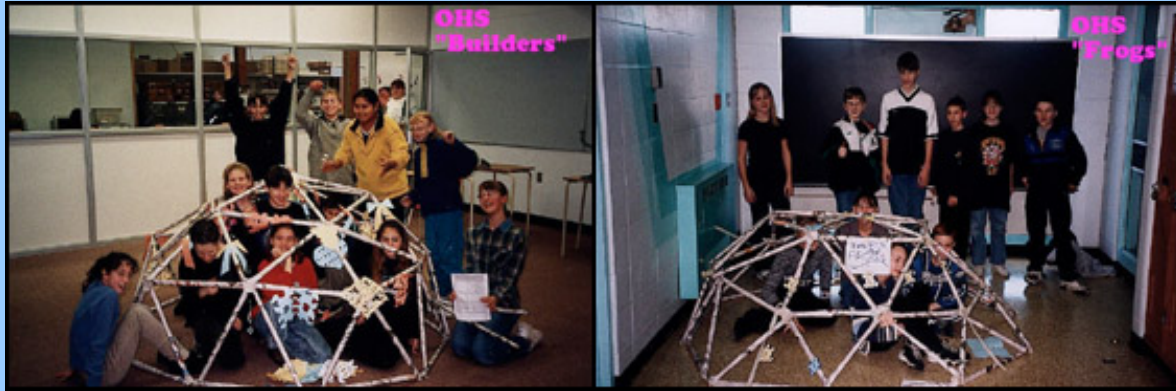

Dear *YES Mag*,

Great project! We are a grade 7 science class from Onoway High School in Onoway, Alberta, Canada. We split into two groups and had a competition to see who could build the best dome. You can see the results above.

Sincerely,

Ken Peck

Onoway High School

[Home](#) | [HTML Home](#) | [Ask Jude](#) | [Projects](#) | [Reviews](#) | [ROVs](#) | [Beyond YES Mag](#)  
[Subscriber Services](#) | [Contact Us](#) | [About Us](#) | [Privacy Policy](#)

Copyright © 2003 Peter Piper  
Publishing Inc.

Last updated April 14, 2003.

# Geodesic Clubhouse



Dear *YES Mag*,

During National Science and Technology Week '96, my class of 30 students partook in a fun and challenging task. Using the idea from the *YES* magazine, we were doing a Design/Tech. unit. I thought that my group of kids would have a blast. They sure did. I separated the class into two groups. On the first day of the task, they acted as teams of "building material factory workers" - rolling up the newspaper rods. A strong leader, acted as a foreman. On the second day, the whole two groups of students proceeded to act as construction crews, also with a foreman. Two complete geodesic domes were constructed in the school's library. The whole process was photographed and videotaped.

What a swell project idea. Thanks!!!

Sincerely,  
Mr. Andre Lisowyk  
Jean Vanier School  
London, Ontario

[Home](#) | [HTML Home](#) | [Ask Jude](#) | [Projects](#) | [Reviews](#) | [ROVs](#) | [Beyond YES Mag](#)  
[Subscriber Services](#) | [Contact Us](#) | [About Us](#) | [Privacy Policy](#)

Copyright © 2003 Peter Piper  
Publishing Inc.  
Last updated April 14, 2003.

# Geodesic Clubhouse

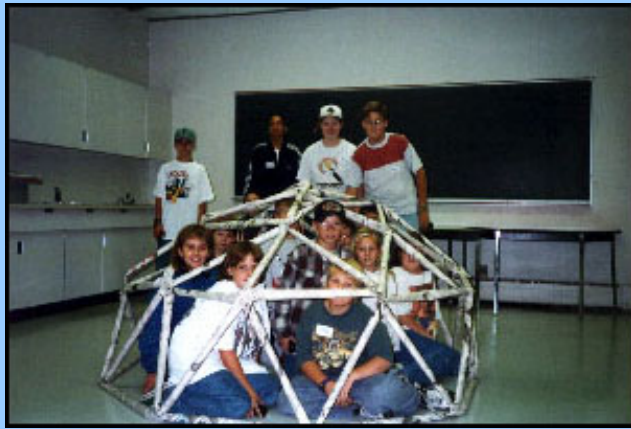

Dear *YES Mag*,

The Museum of Man and Nature in Winnipeg hosts a Young Scientist's Club for young members, and this picture shows the kids constructing Geodesic Club Houses at our October '96 meeting. We meet on the first Saturday of every month and the activities each month center around a different science topic. In October we were discussing stable structures, and the kids loved it! The clubhouses were great for encouraging team work also.

Heather Marks  
Education Developer

[Home](#) | [HTML Home](#) | [Ask Jude](#) | [Projects](#) | [Reviews](#) | [ROVs](#) | [Beyond YES Mag](#)  
[Subscriber Services](#) | [Contact Us](#) | [About Us](#) | [Privacy Policy](#)

Copyright © 2003 Peter Piper  
Publishing Inc.  
Last updated April 14, 2003.

# Geodesic Clubhouse



Matthew, Greg, Leigh, Sue, and Andrew inside their geodesic spaceship. Photo by Sandra Conrad.

Dear *YES Mag*,

You could probably have an ongoing column called something like "Dome Talk", maybe even a [www.yes dome site](http://www.yesmag.bc.ca/dome). I say this because some friends and I have just built the geodesic dome featured in the last issue. Here are a few related findings, comments, and experiences you may find to be funny and hopefully of interest to some of your readers, especially those who are thinking of building the dome.

## Let's have a Dome Party!

Being both a young adult of the 60s and a Buckminster Fuller fan, the geodesic dome feature really caught my interest. The instructions were so well laid out that I, a religion and psych graduate, had no trouble understanding them. After pondering the various combinations and permutations (Psych 101 Stats buzzwords) of team make-ups, I decided that instead of Matthew (6), Daddy (a civil engineer), and me hoarding all of the pleasure that would surely be the outcome of such a project, we should really make an event of it and invite a neighboring family to join us.

The Russells have three boys: Nick (12), Andrew (9), and Greg (6), plus two fun-loving, energetic, and adventurous parents, Dan and Sue. They agreed to come to our house for a BBQ and dome party. Everyone was excited.

## The original plan

Before dinner, on a sunny deck, we would start rolling the tubes. Having started the project, the adults would converse over salad and marinated flank steak. The kids, having wolfed down their hot dogs so they could get back at the dome project, would roll more tubes. After dinner, we all would have a great time assembling the dome and photographing our progress. Both families brought every newspaper in sight to the party, plus whatever staplers and tape we could lay our hands on. I bought three (3/8") rollers--the more rollers, the better. We agreed that the dome would stay at our house, and that we would use the skills and lessons learned to build one for the Russell's a week or so later.

## Reality strikes

The guests arrived, and everything was set out on the deck. The sun was shining, and all began according to plan. As I was completing dinner preparations, Sue agreed to be the project coordinator. When I surveyed the idyllic scene from the kitchen window, Carl (my husband) was busy at the BBQ, Dan was talking to Carl--and rolling the odd tube. His hands were not as nimble for the task as Sue's. And the boys were having a great time chasing each other around on the lawn. They didn't have the necessary "rolling" skills, and became somewhat bored waiting to attach the tape to each completed tube. Sue, bless her, was rolling tubes like a woman possessed.

We had a lovely dinner and by the time we finished, it was too late to remain outside. As it was also approaching the

children's bed times, we decided to call it a night--although a very pleasant one.

## Plan B

Having gained in wisdom, Sue and I decided to get together at her house a few days later. Note, we lost the husbands and Nick had plans with friends. The team of 8 was thus reduced to five. Matthew and I dutifully traipsed down the street with the 35 tubes and various staplers, etc., plus a dowel just in case we had to re-do one or more tubes.

We eagerly set up to start working again and, ah, yes...we had been so excited at the dome party that stopped reading "a total of 35 size tubes". our faces fell, but quickly regained their determined smiles as braced ourselves roll another 30 for b. now only one dowel between us, and really were getting anxious stop learning lessons get going, sue cut measured while i rolled bs--we took turns knocking on doors more newspapers. soon gained an interested, yea fascinated, neighbour (sandra) who asked be called over see finished product! what encouragement! later, sandra happily obliged us by taking few group photos.

While still in the early stages, specifically as we were busy affixing the second row of tubes, we noticed that the room was vacant except for us. For a moment, we were tempted to just have our tea and call it a night. We looked over our shoulders at each other. By this time guilt at having roped Sue into this project was about to get the best of me. Then Sue said, "We are going to finish it." Happily we did. The kids joined in at key points throughout the evening, and the enjoyment increased at a steady pace. Everyone had, and is still having, a great time.

## Lessons learned

1. Dome building needs the full attention of two or more adults, if only to roll fast enough to maintain the interest of the children in the initial stages; and then to continually think of new and creative ways the younger children can help.
2. If food is to be served, make it popcorn, chips, something easily munched while working. Don't serve hot dogs. If you want red, yellow, and green tubes, paint is a much better alternative.
3. Start early, no later than 4:00 PM, earlier if you want everyone to have an hour or two to play in it. The instructions look, and are, easy, but the process takes about four hours. At least that was for the first one, we haven't done the second yet. Yes, we are still dome enthusiasts.
4. If you are using more than two pieces of paper per tube, the stapler becomes ineffective, unless one has a heavy duty plier stapler. We really do recommend four or five sheets of paper per tube and chuck the stapler. The multi layers provide a structure that can weather the exuberance of kids who love to play in it. Ours has survived four days of heavy playing, plus a party of 12 active boys. Also we found that the staples, if not closed tightly, can create opportunities for pulled thread on clothing or punctured skin. Yuck.
5. Putting the tubes together with tape instead of staples was highly effective, fun to do, and means the smaller children can participate by holding the pieces while they are being taped. We used mostly scotch tape, but the best was thin masking tape--the very best would have been black hockey stick tape, but we didn't happen to have any on hand. You wind the tape around all of the joints, following the sequence as given for stapling. Tubes attach easily to each joint as the layers are added.
6. Dowel guidelines: the result of standing in front of the Canadian Tire dowel display for 15 minutes with a broom handle in one hand as brand X and a choice of at least 10 dowel sizes in the bin. No, the student on duty that evening didn't have any idea as to what to suggest. Recommendation: less than 1/4" would be too small and anything over 1/2", although smaller than a broom handle, would be too large. We were happy with 3/8", but I would also try 5/16".
7. Collect only full-size newspapers. Tabloid and insert sizes are too small. Take an issue of your daily newspaper and count the double pages. Determine how many pages you would like per tube, multiply by 65, add 15 pages just in case, and you will have an idea of how many papers to collect.
8. If you look around at any time during the construction phase--especially during the rolling part--and find that the kids have gone and only the adults are toiling away, do not despair. Unless you have recently been named Scout Leader of the year, that will happen. Keep going and the kids will return. Even the older ones tend to come and go. Call them over when you have a task for them. They will love it. The joy on their faces when it is finished is worth it. Their perception is that they were with you all the way and only took "a few little rests".

## Lesson of them all--modify the instructions at your peril

When we finally had all of the necessary tubes, we found that although my friend Sue has a fairly large living room, the dome would not fit! Alas, intrepid, though not very scientifically oriented, yours truly noted that the base was formed of 10 tubes and the next ring of tubes were in pairs of twos. "Aha!" said I, "to modify the size, one just removes or adds tubes in twos."

All went well until the last part. Then we noticed with dismay that the effect of reducing the number of tubes at the base was that instead of a five sided ring at the tip, which would have neatly housed five tubes to make that last, wonderfully familiar geodesic pattern, alas, our top ring had four tubes. Not to be defeated, we barged ahead and put in four "ribs" not reducing them in size which has resulted in a delightful geodesic space station. Another bonus is that the children can stand up in it. Of course, we Moms knew that all the time.

Can anyone out there figure out a nice little rule of thumb for a series of A and B tube lengths which would allow

non-scientific dome builders to scale their dome up or down to match their theme park or more likely their living/family room?

### Dome games

When asked, three days later, if the boys are still playing with it, the immediate response from Nick was an enthusiastic "yes". What every parent wants--a rugged toy that lasts. One game that is particularly popular is "push the balloons through the holes". One or more children get inside the dome. One or more are outside, depending on if it is played on the "monkey in the middle" or two team concept. The one(s) outside try to push as many balloons as possible through the holes. The person(S) inside tries to push them out just as fast. Apparently, it is not easy to push them in either direction, hence the element of skill.

When the person(s) outside get all of the balloons inside, the game is over. The fine points of the "rules" have not been worked out yet, but the game seems to have promise, The proof is the boys' exclamation that "we play it for hours!" Sue says the laughter was amazing to hear. Listening Moms and Dads?

Thank you *YES Mag*.

Sincerely,  
Leigh, Sue, Nick, Andrew, Greg, and Matthew

[Home](#) | [HTML Home](#) | [Ask Jude](#) | [Projects](#) | [Reviews](#) | [ROVs](#) | [Beyond YES Mag](#)  
[Subscriber Services](#) | [Contact Us](#) | [About Us](#) | [Privacy Policy](#)

Copyright © 2003 Peter Piper  
Publishing Inc.  
Last updated April 14, 2003.

## YES MAG NEWS

Click [here](#) to get the latest *YES Mag* news.

## ASK JUDE

Got a science question you've always wanted answered? Then we've got the person for you: our editor Jude is an expert at tracking down answers. A new question will be posted every Friday and all the old questions are available in our archive. Send her your questions now: [askjude@yesmag.ca](mailto:askjude@yesmag.ca).

This week's question:  
How do I disinfect/delouse an old bird's nest before bringing it into the house?

Click [here](#) for this week's answer.

## FUN FACTS

Click [here](#) to check out some of our latest fun facts.

## IN THIS ISSUE





## Beyond *YES Mag*

Okay, you love *YES Mag* but you've been bitten by the science bug and you need more. Where to go? Here are our top three picks for satisfying your science cravings.

[Actua](#)

[CAGIS](#)

[Science Centres in Canada](#)

[Home](#) | [HTML Home](#) | [Ask Jude](#) | [Projects](#) | [Reviews](#) | [ROVs](#) | [Beyond YES Mag](#)  
[Subscriber Services](#) | [Contact Us](#) | [About Us](#) | [Privacy Policy](#)

Copyright © 2003 Peter Piper  
Publishing Inc.  
Last updated April 14, 2003.

## SUBSCRIBER SERVICES

Order a subscription, change your address, send us a compliment, or tell us what we can do to serve you better.



## ORDER A SUBSCRIPTION

[Purchase or renew a subscription...](#)

[Download sample pages...](#)

[Learn more about YES Mag...](#)

[What our readers have said...](#)

[Purchase back issues...](#)

## MANAGE YOUR SUBSCRIPTION

[Change your address...](#)

[Report a missing or damaged issue...](#)

[Find out when your subscription ends...](#)

[General inquiries or comments...](#)



[Home](#)

[Ask Jude](#)

[Projects](#)

[Reviews](#)

[ROVs](#)

## Contact Us

*YES Mag* (ISSN 1203-8016) is published bimonthly by Peter Piper Publishing Inc.

**Publisher:** David Garrison

**Editor:** Shannon Hunt

**Managing Editor:** Jude Isabella

**Designer:** Terry Dee

Change of address or other subscription questions can be handled in our subscriber services area.

**Writers Guidelines:** Inquiries can be sent to Jude Isabella at [editor@yesmag.ca](mailto:editor@yesmag.ca).

**Advertising:** Inquiries can be sent to David Garrison at [daveg@yesmag.ca](mailto:daveg@yesmag.ca).

*YES Mag*  
3968 Long Gun Pl  
Victoria, BC  
V8N 3A9  
Canada

Tel: (250) 477-5543  
[info@yesmag.ca](mailto:info@yesmag.ca)

[Home](#) | [HTML Home](#) | [Ask Jude](#) | [Projects](#) | [Reviews](#) | [ROVs](#) | [Beyond YES Mag](#)  
[Subscriber Services](#) | [Contact Us](#) | [About Us](#) | [Privacy Policy](#)

Copyright © 2003 Peter Piper  
Publishing Inc.  
Last updated April 14, 2003.

## About *YES Mag*

Looking for a way to further develop your child's interest in science? Look no further! *YES Mag: Canada's Science Magazine For Kids* is designed to make science, technology, engineering, and mathematics exciting and fun for kids ages 8 to 14. Each 32 page, full-colour issue is packed with:

- " An indepth look at a scientific topic (for example, Earthquakes or Robots)
- " Do-at-home projects
- " Science news
- " Brain Bumpers
- " Scientists
- " Environmental updates
- " New technology

And, of course, *YES Mag* makes a great resource for schoolwork.

## Award Winner

*YES Mag* has won the "Eve Savory Award For Science Communication" from the Science Council of British Columbia and the "Michael Smith Award for Science Promotion" from the Natural Sciences and Engineering Research Council of Canada. *YES Mag* was a finalist for "British Columbia Magazine of the Year" in 1999 and 2003 and has been a finalist for several Distinguished Achievement Awards, including Periodical of the Year, from The Association of Educational Publishers. *YES Mag* has also been chosen for the "Our Choice" list by the Canadian Children's Book Centre for six years running.

### Quick Links

" [YES Mag Store](#)

" [Pricing](#)

" [About YES Mag](#)

" [Sample Pages](#)

" [What Our Readers Say](#)

" [About Back Issues](#)

" [About ISS Book](#)

" [About Feats Book](#)

" [About the t-shirt](#)

" [Printable Order Forms](#)

[Home](#) | [HTML Home](#) | [Ask Jude](#) | [Projects](#) | [Reviews](#) | [ROVs](#) | [Beyond YES Mag](#)  
[Subscriber Services](#) | [Contact Us](#) | [About Us](#) | [Privacy Policy](#)

Copyright © 2004 Peter Piper Publishing Inc.  
Last updated August 26, 2004.

## Privacy Policy

*YES Mag* respects your right to control the information given to us and how we use it.

### Information Collected

If you are ordering a *YES Mag* subscription, obviously we need a certain amount of information in order to provide the subscription to you and to communicate with you about it (in case, for example, there is a problem with the order). We use that information only for internal purposes. We do not sell or rent subscription lists. We do not give personal information about our readers or subscribers to third parties.

### Email Contact

We do, on occasion, receive terrific unsigned email letters. If we wish to use it on the letters page of our magazine, an editor will contact the writer and ask for name and town. Again, it is used only for the magazine, in this case, the letters page, or, as an anonymous quote for promotional purposes.

Readers also email us to express an interest in reviewing books or science kits for *YES Mag*. If that's the case, we send information about doing a review. We publish reviews in each issue of *YES Mag*, and we post them on our web site. If this is okay with the reader (and his/her parents), we send a review book or science kit when it's his/her turn on the reviewer list. Usually reviewers are already subscribers and their addresses are available through our subscription database.

*YES Mag* readers also tend to ask a lot of science questions of our editors. We try to answer questions without doing someone's homework and often steer them to appropriate external web sites. The web sites recommended are reviewed by an editor prior to being suggested.

### Cookies

We only use cookies during the subscription ordering process and then only to keep track of your order. No information is stored permanently.

### Security

We have put in place appropriate physical, electronic, and managerial procedures to safeguard and help prevent unauthorized access, maintain data security, and correctly use the information we collect in the subscription ordering process.

### Parents/Guardians

Computers and the Internet are here to stay and kids will be navigating the two with the skill and ease of born cybernauts. We believe it is important for you to understand the perils of the on-line world and to help educate your kids. We have found two good web sites which will help you with this, so check them out and then talk with your kids before they start surfing on their own.

Media Awareness Network

<http://www.media-awareness.ca/>

Cyber Savvy

<http://www.cybersavvy.org/cybersavvy/index.html>

### Contact Us

If you have any questions, comments, or concerns regarding our privacy policy and/or practices, please contact us at the following email address, mailing address, or telephone number:

[info@yesmag.ca](mailto:info@yesmag.ca)

**YES Mag**

3968 Long Gun Pl  
Victoria, BC

[Home](#) | [HTML Home](#) | [Ask Jude](#) | [Projects](#) | [Reviews](#) | [ROVs](#) | [Beyond YES Mag](#)  
[Subscriber Services](#) | [Contact Us](#) | [About Us](#) | [Privacy Policy](#)

Copyright © 2003 Peter Piper  
Publishing Inc.  
Last updated January 5, 2004.

## Our Online Subscriber Services Site has Moved!

Please update your bookmarks to:

[http://www.yesmag.ca/store/Sub\\_Services.html](http://www.yesmag.ca/store/Sub_Services.html)

You will be automatically redirected to the site's new location in ten seconds. Click [here](#) to visit the new site immediately.

[Home](#) | [HTML Home](#) | [Ask Jude](#) | [Projects](#) | [Reviews](#) | [ROVs](#) | [Beyond YES Mag](#)  
[Subscriber Services](#) | [Contact Us](#) | [About Us](#) | [Privacy Policy](#)

Copyright © 2004 Peter Piper  
Publishing Inc.  
Last updated August 26, 2004.

## About *YES Mag*

Looking for a way to further develop your child's interest in science? Look no further! *YES Mag: Canada's Science Magazine For Kids* is designed to make science, technology, engineering, and mathematics exciting and fun for kids ages 8 to 14. Each 32 page, full-colour issue is packed with:

- " An indepth look at a scientific topic (for example, Earthquakes or Robots)
- " Do-at-home projects
- " Science news
- " Brain Bumpers
- " Scientists
- " Environmental updates
- " New technology

And, of course, *YES Mag* makes a great resource for schoolwork.

## Award Winner

*YES Mag* has won the "Eve Savory Award For Science Communication" from the Science Council of British Columbia and the "Michael Smith Award for Science Promotion" from the Natural Sciences and Engineering Research Council of Canada. *YES Mag* was a finalist for "British Columbia Magazine of the Year" in 1999 and 2003 and has been a finalist for several Distinguished Achievement Awards, including Periodical of the Year, from The Association of Educational Publishers. *YES Mag* has also been chosen for the "Our Choice" list by the Canadian Children's Book Centre for six years running.

### Quick Links

" [YES Mag Store](#)

" [Pricing](#)

" [About YES Mag](#)

" [Sample Pages](#)

" [What Our Readers Say](#)

" [About Back Issues](#)

" [About ISS Book](#)

" [About Feats Book](#)

" [About the t-shirt](#)

" [Printable Order Forms](#)

[Home](#) | [HTML Home](#) | [Ask Jude](#) | [Projects](#) | [Reviews](#) | [ROVs](#) | [Beyond YES Mag](#)  
[Subscriber Services](#) | [Contact Us](#) | [About Us](#) | [Privacy Policy](#)

Copyright © 2004 Peter Piper Publishing Inc.  
Last updated August 26, 2004.





## Price list for Conduit Fabrication Plans

---

13' hemisphere fabrication plans- \$13 plus \$3 postage and handling

15' hemisphere fabrication plans \$15 plus \$3 postage and handling

24' compound truss plans \$24 plus \$3 postage and handling (hemisphere)

---

send check to:

Robert Conroy

312 East 79th Street

Kansas City, Missouri 64114

Make sure and note which plans are being requested when sending in check.

- [Return to Home Page](#)

# Order Form

| Description                                                                                                                    | No. of books | X | Cost/book     | = | _____ |
|--------------------------------------------------------------------------------------------------------------------------------|--------------|---|---------------|---|-------|
| "Geometric Elements with their simple and complex compounds"<br>(Used in concert with WEB based text for 3D geometry modeling) |              |   |               |   |       |
| Level 1 Workbook<br>(1st thru 4th grade)                                                                                       | _____        | X | \$12/book     | = | _____ |
| Level 2 Workbook<br>(5th thru 8th grade)                                                                                       | _____        | X | \$14/book     | = | _____ |
| Level 3 Workbook<br>(8th grade and above)                                                                                      | _____        | X | \$16/book     | = | _____ |
| U.S. postage and handling                                                                                                      | _____        | X | (\$3.00/book) | = | _____ |
| Total                                                                                                                          |              |   |               | = | _____ |

Send completed order form and check to:

Robert Conroy  
312 East 79th St.  
K.C. MO 64114

**Your name, address, and E-mail address:**

**Comments:**

A schedule of training classes can be found by clicking on the training class link.

- [E-mail](#)
- [training classes](#)
- [Return to cover page](#)

## 32' Dome 2nd Floor Joist Page

---



### 32' Dome 2nd Floor Joist being installed

Note: The first floor partition walls need to be placed so as to create no more than a 13.5' span for the 2x8 fir 2nd floor joist.

---



**32' Dome Joist Hangers**

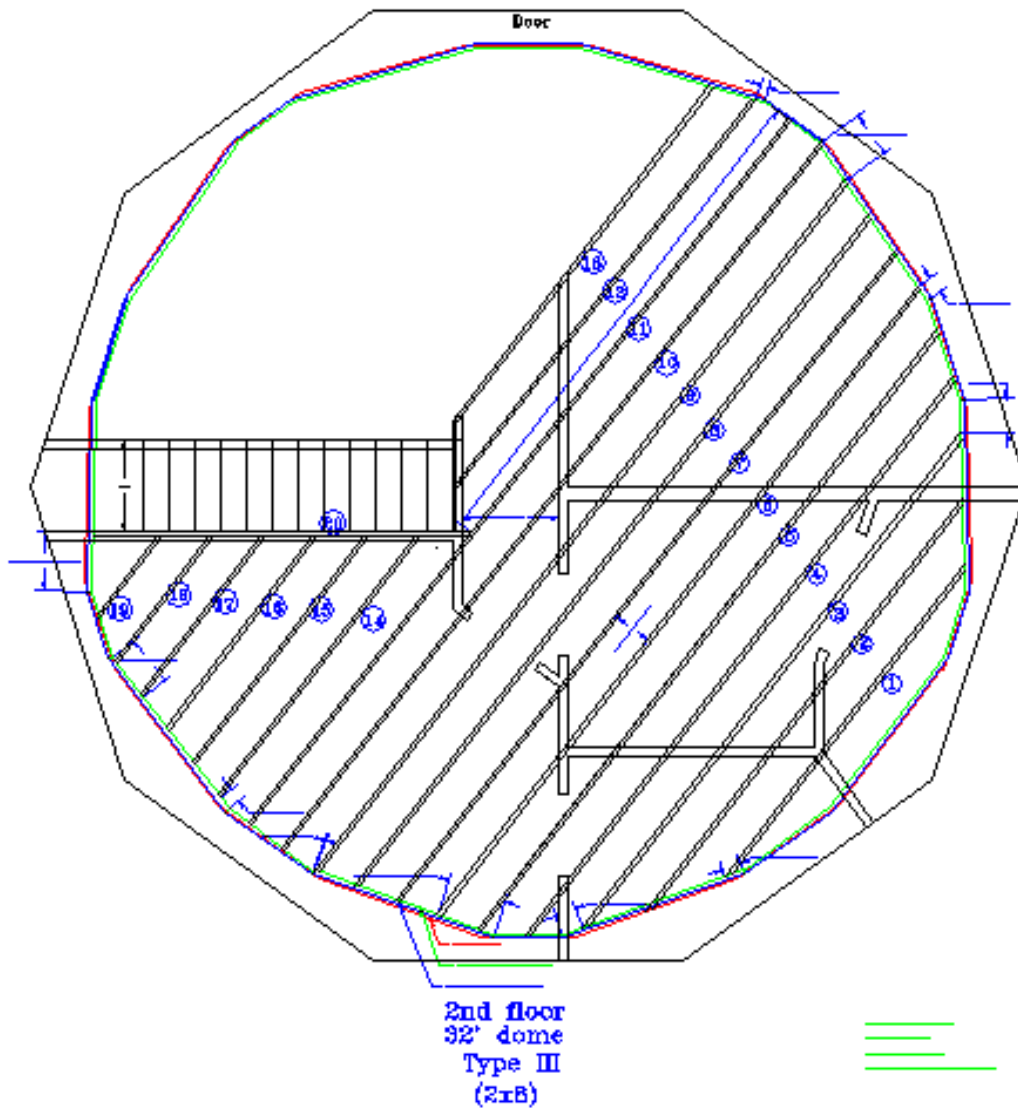

### 32' Dome Joist Plan Layout

---

### 32' Diameter Dome Accessories

#### 2nd Floor support and joist cutting charts \$80.00

Send money plus \$3.00 postage and handling to: Robert Conroy, 312 East 79th Street, Kansas City, Missouri 64114 (please include return name and address and your specific order)

- [Return to cover page](#)

## **Dome Kits (not available at this time)**

### **32' Dome kit (\$4000)**

The basic 32' dome kit consist of precut and predrilled truss boards along with complete set of wedge connectors. (2x4 construction) F.O.B. Kansas City MO. Includes assembly brochure, material list, along with plywood cut-out patterns and jigs. Also includes plans for kneewall and awnings.

### **24' Dome kit (\$3500)**

The basic 24' dome kit consist of precut and predrilled truss boards along with a complete set of wedge connectors. (2x4 construction) F.O.B. Kansas City, MO. Includes assembly brochure, material list, along with plywood cut-out patterns and jigs. Also includes plans for a kneewall and awnings.

---

## **Manufacturers**

Mountain Truss Corporation  
312 East 79th Street  
Kansas City, MO 64114  
816-333-5294

- [Return to index page](#)

[Main](#)

**AOL.**  
**Find a Job**

|           |   |
|-----------|---|
| Salaried  | ▲ |
| Hourly    | ■ |
| Temporary | ▼ |

# Dome Truss

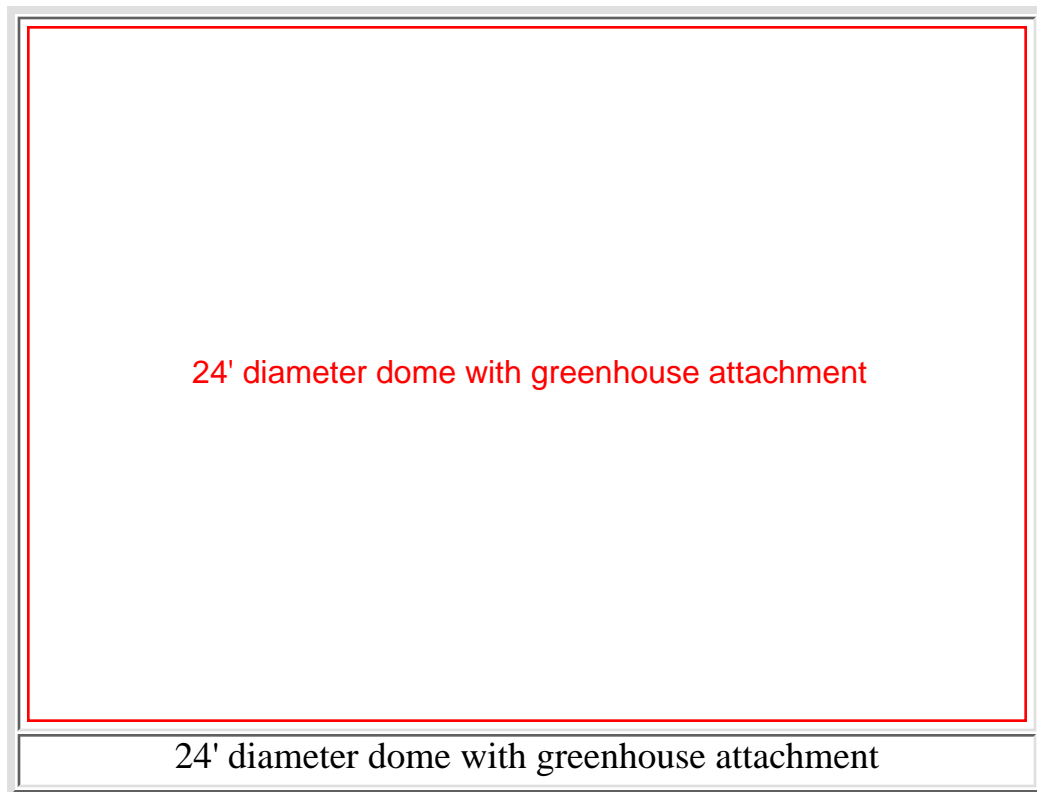

copyright 2000 Robert Conroy

## Dome Attributes:

- Low Cost
- High Strength
- Light Weight
- Hurricane Resistant
- Earthquake Resistant
- Energy Efficient

The material cost for the above fully sheathed, weathertight, 24' diameter basic dome structure, with kneewall was approximately \$3000. This does not include greenhouse nor interior finish. Elastomeric paint was used for the roofing. For a solution I have experienced to be maintenance free but more expensive, I would suggest "Peel & Seal" roofing (1-800-882-ROOF).



## Links

- [Nature's Structural Elements](#)
- [Greenhouse Attachment \(animated gif\) \(97 kips\)](#)
- [24' Diameter Dome fabrication photos](#)
- [24' Diameter Dome Erection photos](#)
- [Updated Fabrication Procedure](#)
- [24' Dome Paper Model \(zip file of gif format\)](#)
- [1:30 scale 38' Diameter Card Stock Model](#)
- [38' Diameter 2/5 Dome](#)
- [14' diameter panelized dome](#)
- [Pros & Cons of Dome Construction](#)
- [Dome Plans](#)
- [Video of Dome Fabrication](#)
- [Dome Kits](#)
- [More Info on 24' diameter dome](#)

## **Fabrication plans for greenhouse attachment (122KB)(shareware)**

- [Entryway-Solar Collector-Greenhouse](#)

Note: This type of structure is not for the average American. It requires patients, perserverance, and good sense to build such a structure.

## **E-mail**

- [RoConroy@aol.com](mailto:RoConroy@aol.com)

Note: All the designs referred to on this sight were drawn with care & field tested for any detail oversights, but no

warrantees are given with regards to use.

**Plato wrote: "The simplest solid (structural element) would be a pyramid that consists of four triangular surfaces"**

The 12 structural elements of nature are composed of structurally stable, 6 edged, 4 sided pyramids. The internodal lengths all being of proportions and progressions based on the three lengths; unity, Tau ( $(\sqrt{5} + 1)/2$ ), and square root of 2. These elements in turn can be combined to produce larger element shaped compounds with the progressive sizes being of the fibonacci series. These elements can then be used to form the Platonic Solids in progressive sizes in line with the fibonacci series.

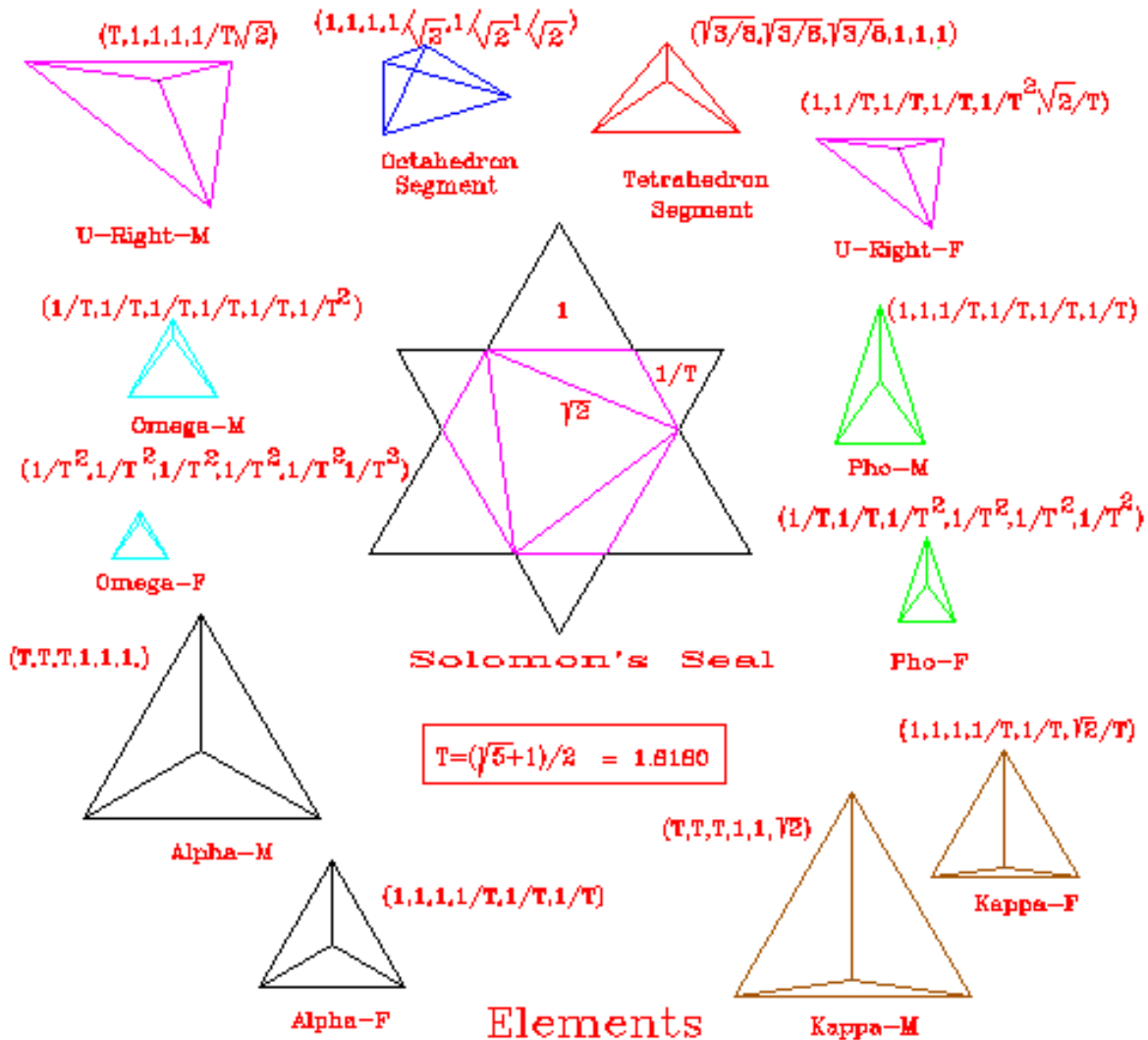

**Elements of Structures**

The following gif shows an alternative octahedron conversion element versus the one shown above.

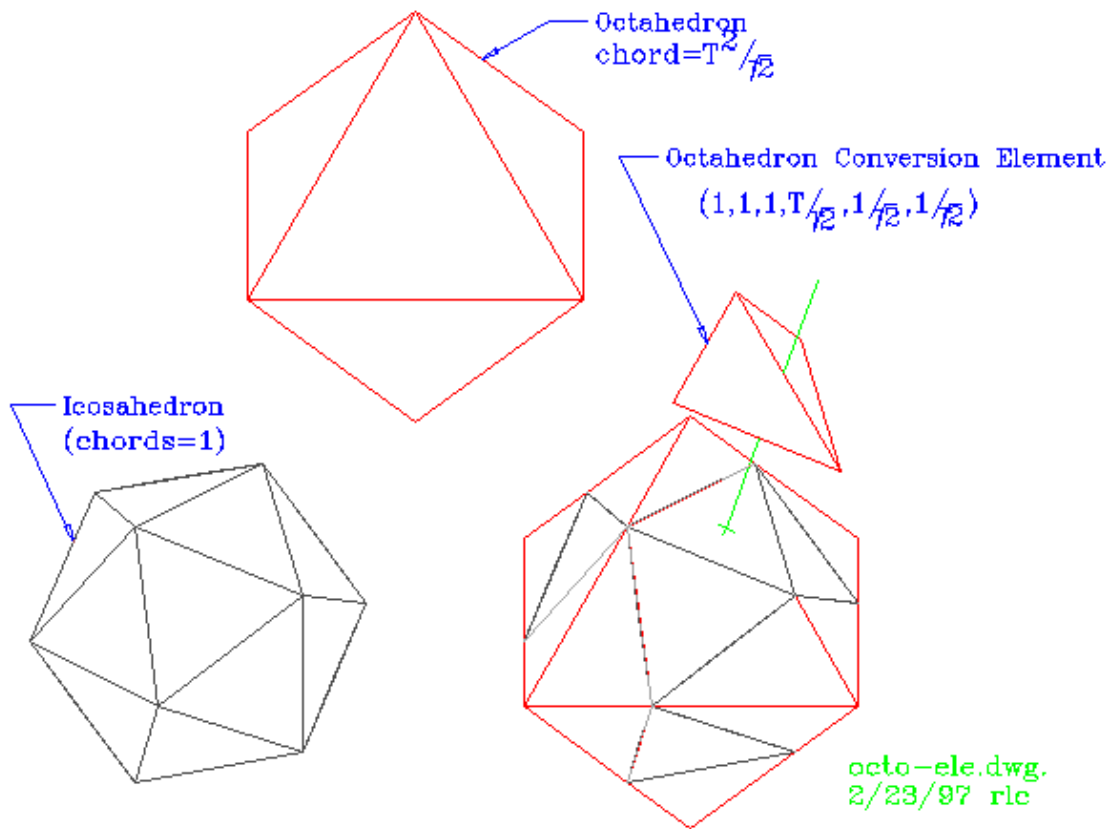

Alternate Octahedron Element

**Octagon Conversion Element**

---

One finds the occurrence of Tau in nature, such as in the reproduction progression of rabbits, the family tree of bees, sea shell shapes, branching plants, flower petal and seed-heads, and the leaf arrangement around stems. It is also found in the psychic of man as shown by its use in the Parthenon, the United Nations building and the artwork of Leonardo, Durer, and Mondrian.

- [Tau Link \(Phi\)\(Golden Section\)](#)
- [Nature and Fibonacci Link](#)
- [Geodesic Virus Links](#)
- [Great Pyramid Link](#)
- [Compounds of Hex-Pent](#)
- [Return to Cover Page](#)

The full Hex-Pent structure would consist of 12 truncated icosahedrons, 20 Hexagon Compounds along with 40 wedge compounds and 1 full major dodecahedron platform.

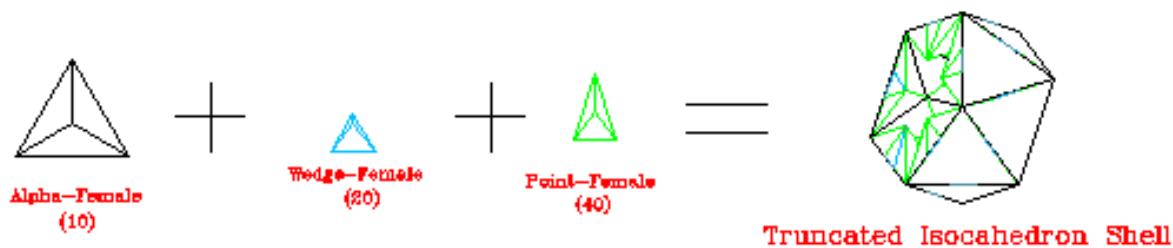
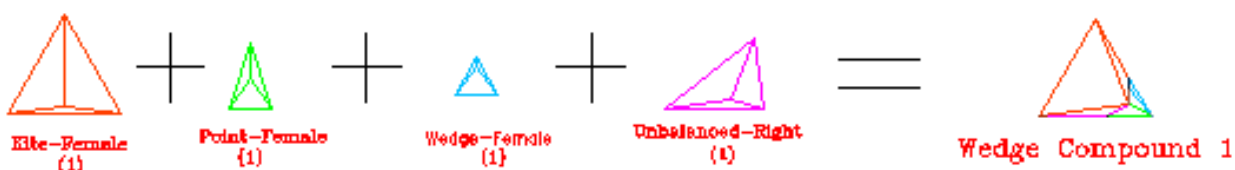
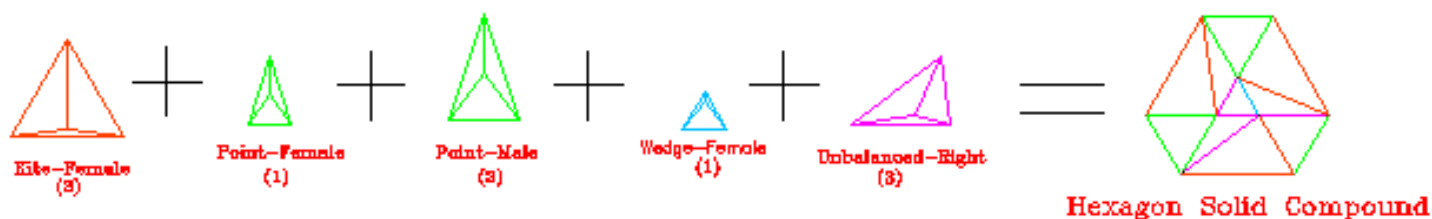

### Compounds of Hex-Pent Geodesic

### Compounds of Hex-Pent and their Elements

- [Hex-Pent](#)
- [return to cover page](#)

A full Hex-Pent Geodesic of this type is comprised of 1 major dodacahedron, 12 truncated icosahedron shells, 20 Hexagon Compounds, and 40 wedge compounds

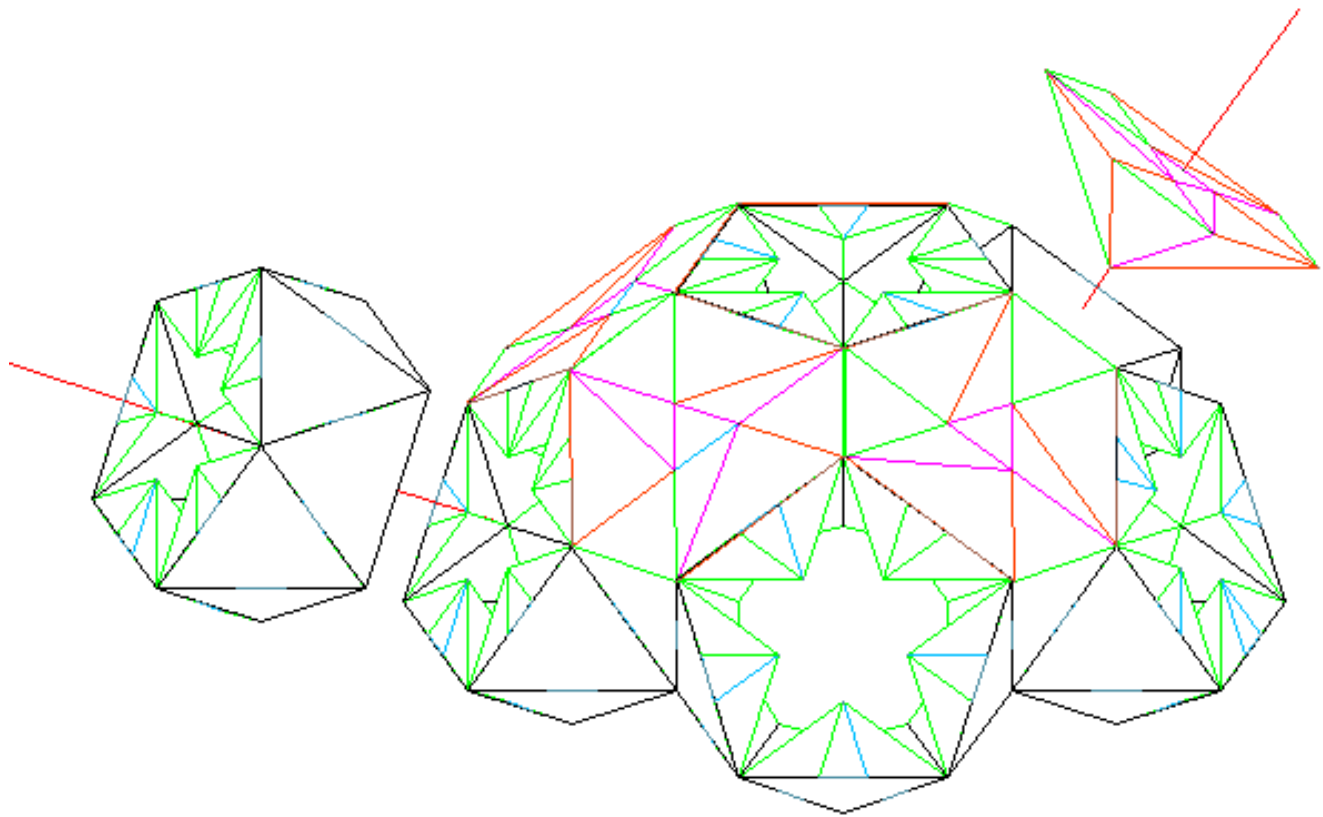

### Partial Hex-Pent Geodesic

- [Dodacahedron and Tri-Pent Compound](#)
- [Return to Cover Page](#)

View of the space lattice structure of two dodacahedrons shown from two different perspectives. The first perspective showing all the elements in the outer shell of the compound and the second perspective showing only the surface elements seen from the viewers perspective. The unseen inner platform for the dodacahedron is an icosahedron.

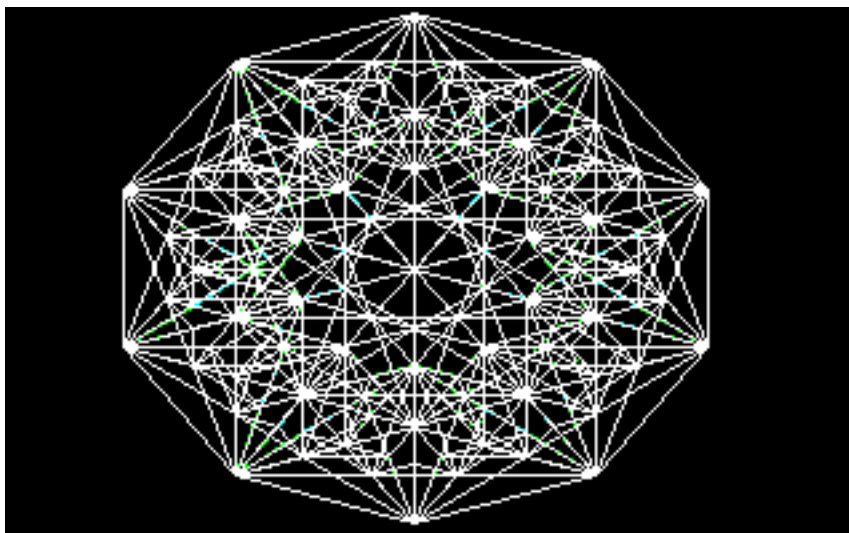

**Dodecahedron Compound shown with view normal to face**

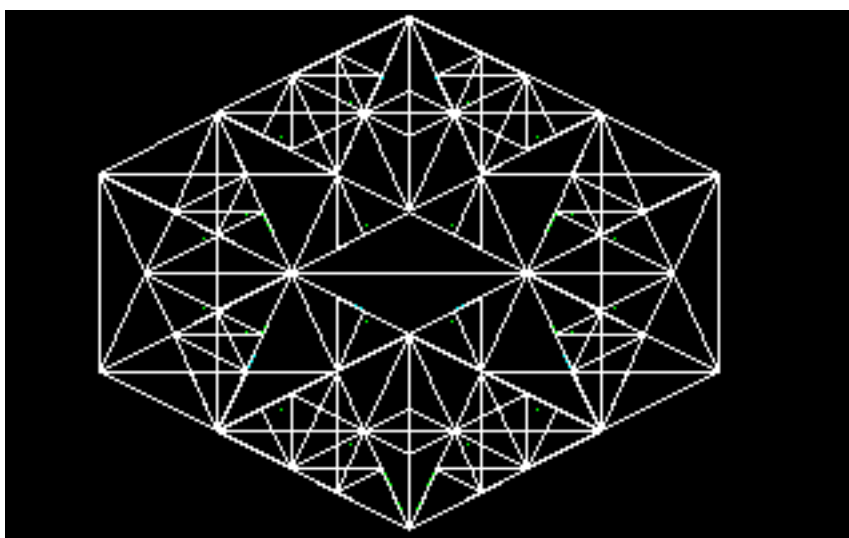

**Dodecahedron Compound at a 31.71747442 degree perspective (face connectors shown only)**

**(Appears as a 1/T cube)**

The following is gif of the Tri-Pent Compound. This is the base compound from which the Isocahedron and Dodecahedron are derived from. They in turn form the foundation of the Hex-Pent Compound. The radius of the Tri-Pent Compound is Tau (T) if the internodal distance of the pentagon face is unity.

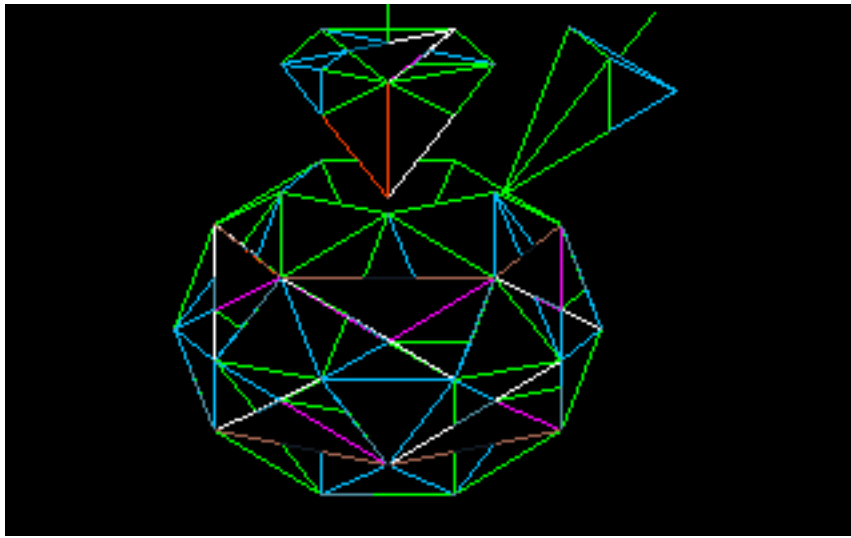

**Tri-Pent Compound**

- [Icosahedron Compound](#)
- [Return to Cover Page](#)



Perspective view of an open latticed Icosahedron such that its' outline is an equallateral hexagon and its over all features are that of the perspective view of a cube. The internal view shows the outline of the Star of David. The internal spacing of the structure other than the dodecahedron platform consist of Alpha, Wedge, Unbalanced, Point, and Kappa elements.

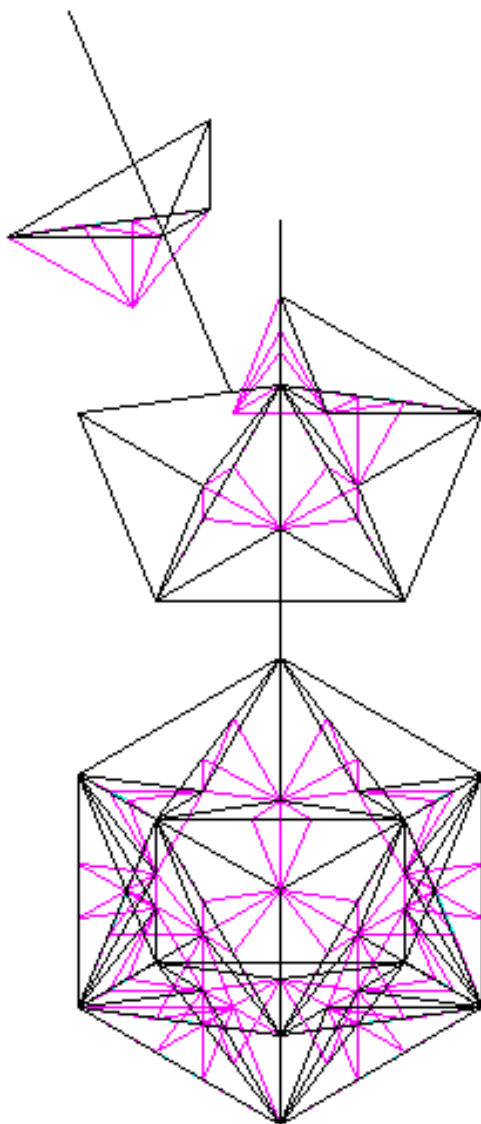

## Icosahedron Compound

---

The following graphic is of a icosahedron build from its' elements.

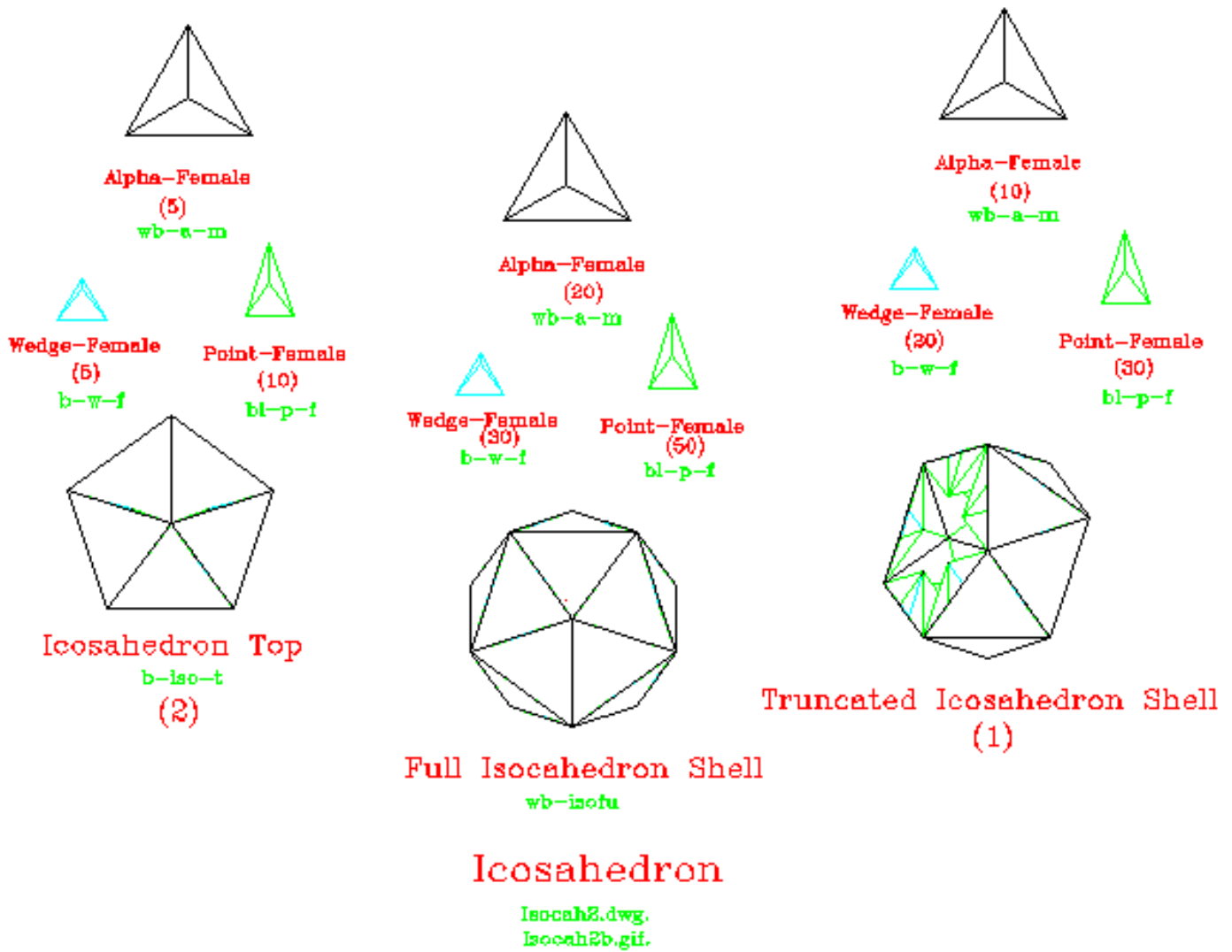

- [Link for possible micron scan of truncated icosahedron](#)

The following graphic is of a icosahedron built from a icosidodecahedron in which I defined as a tri-pent male compound and a compound which I call icosahedron top.

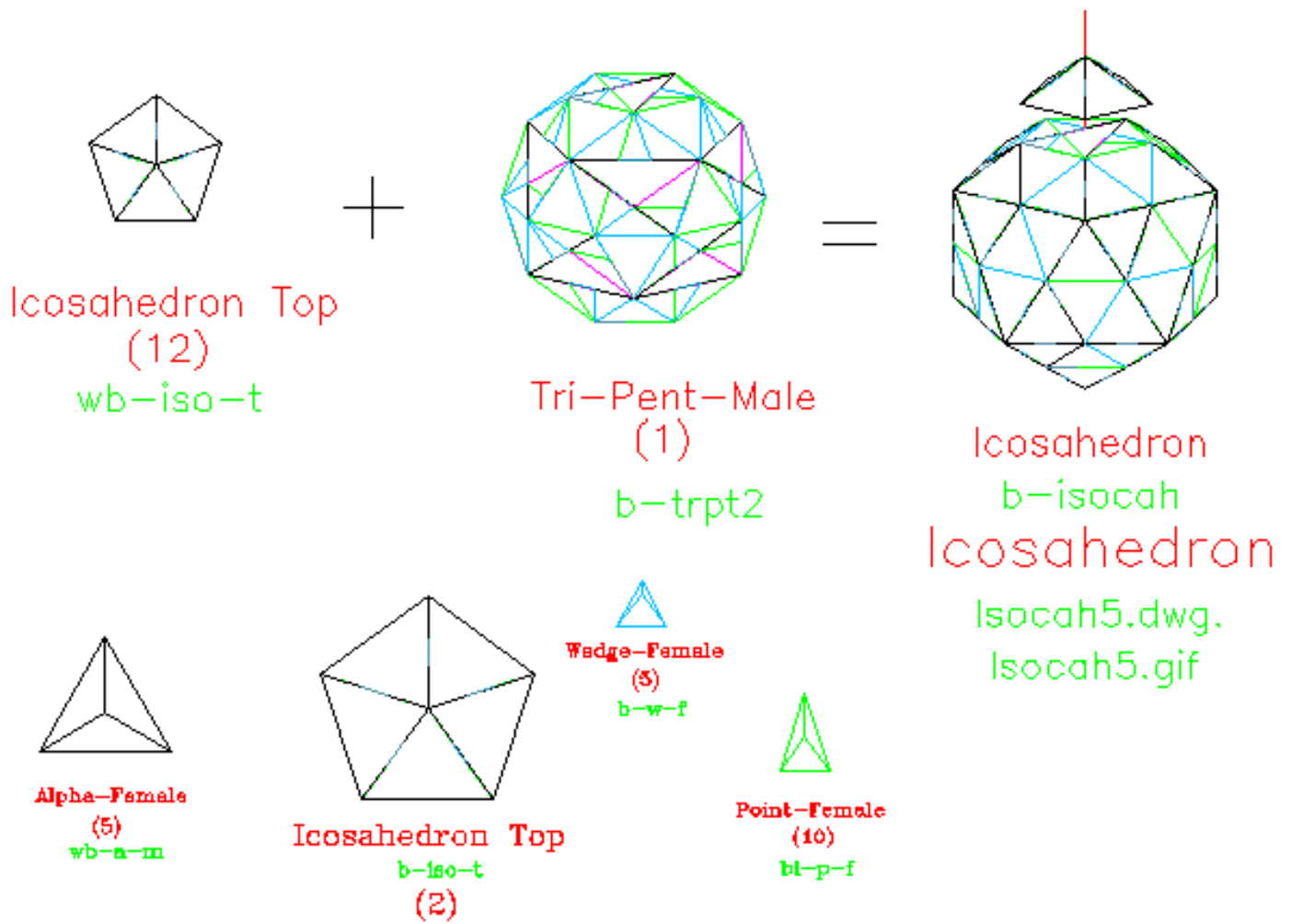

**Icosahedron built from Icosidodecahedron**

- [Geometrical Derivations of Relative Internodal Lengths](#)
- [Return to cover page](#)

This pictorial shows the Geometrical determination of the relative spacing between nodes of the elements. It also shows the geometrical derivation of the radius of a Hex-Pent if its' pentagon edge distances were unity. This page was updated 5/13/97.

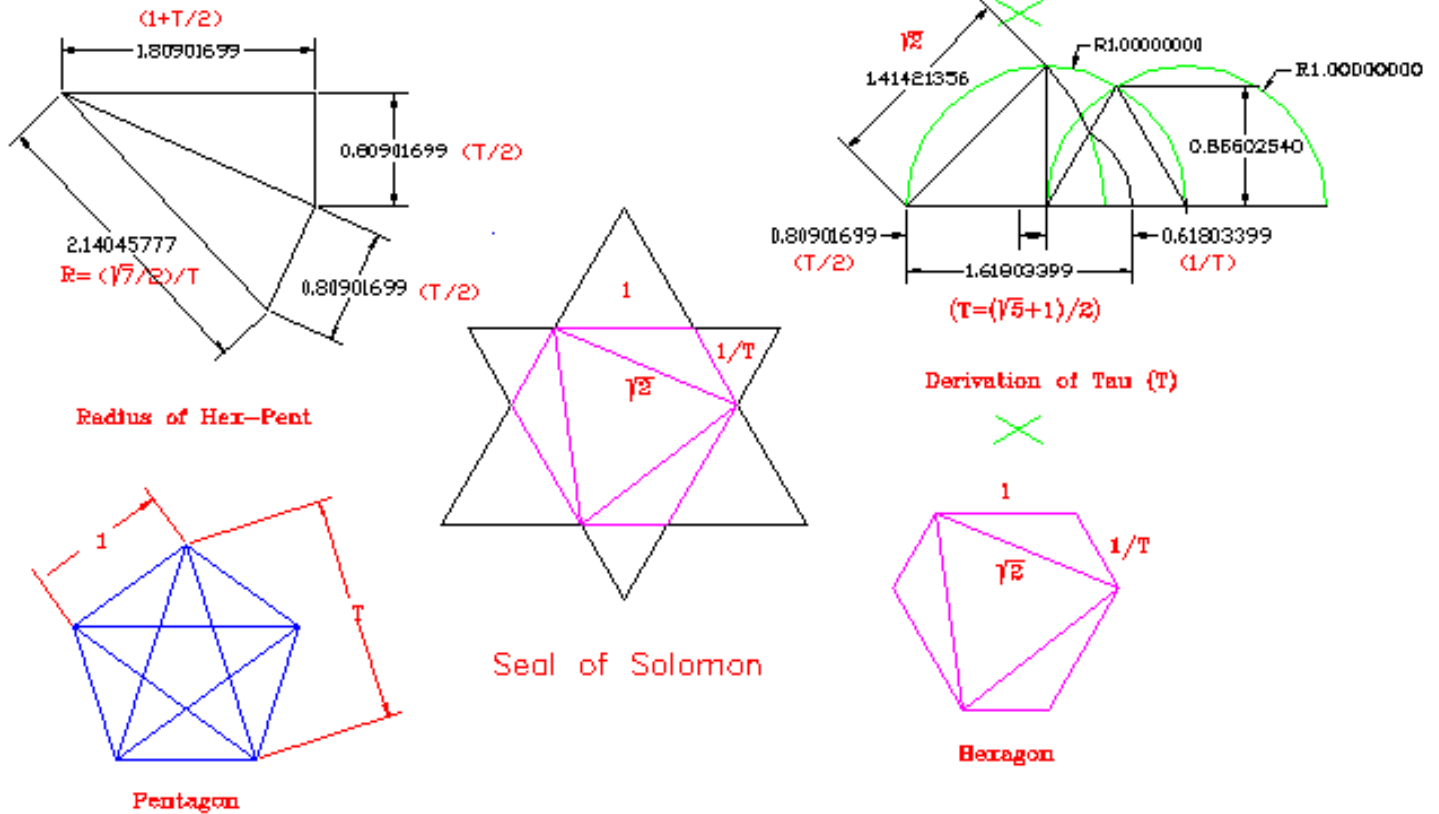

## Geometric Derivation of Hex-Pent Lengths and Radius

### Geometrical Derivation of Relative Internodal Lengths

The following gif shows the geometric derivation of the Tri-Pent-Rect Geodesic from the Hex-Pent Geodesic. It also shows the derivation of the Tri-Hex-Pent structure from the Hex-Pent Geodesic. The Tri-Pent-Rect Geodesic can be used as a universal connecting node for the construction of the differing elements and their compounds.

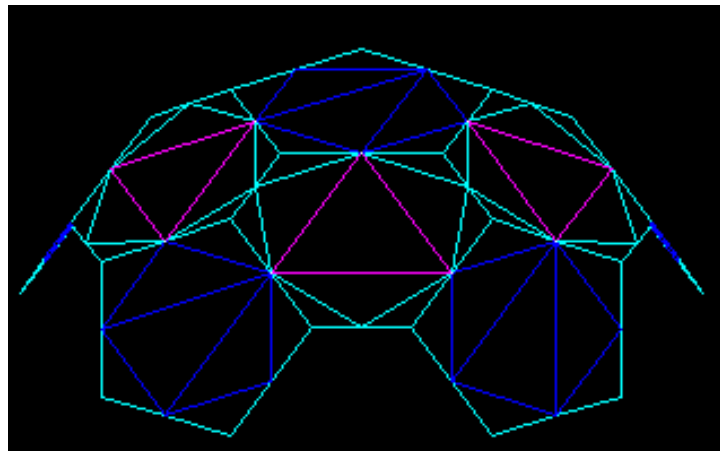

## Derivation of Tri-Pent-Rect Geodesic from Hex-Pent Geodesic

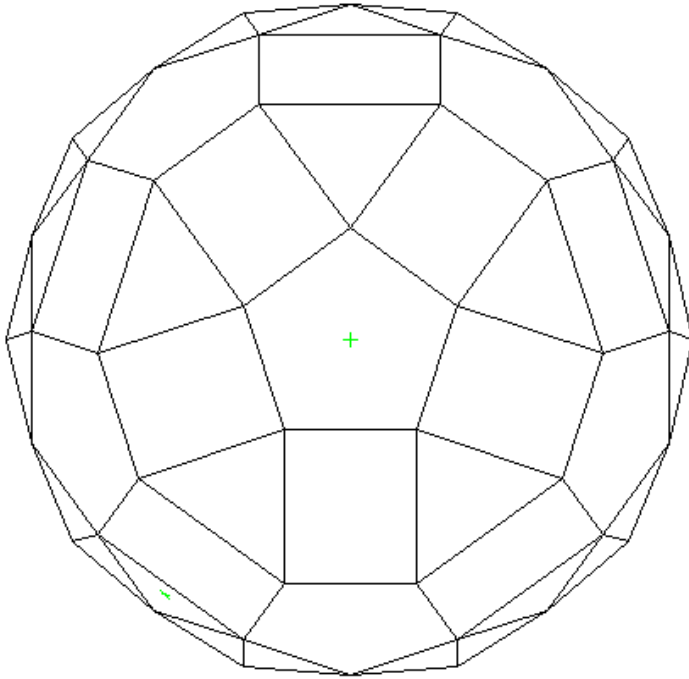

### Tri-Pent-Rect

---

The following gif shows a relative of the Tri-Pent-Rect Geodesic arrived at by means of geometric reduction. This geodesic will be referred to as Reduction I. Further reductions can be used for larger structures.

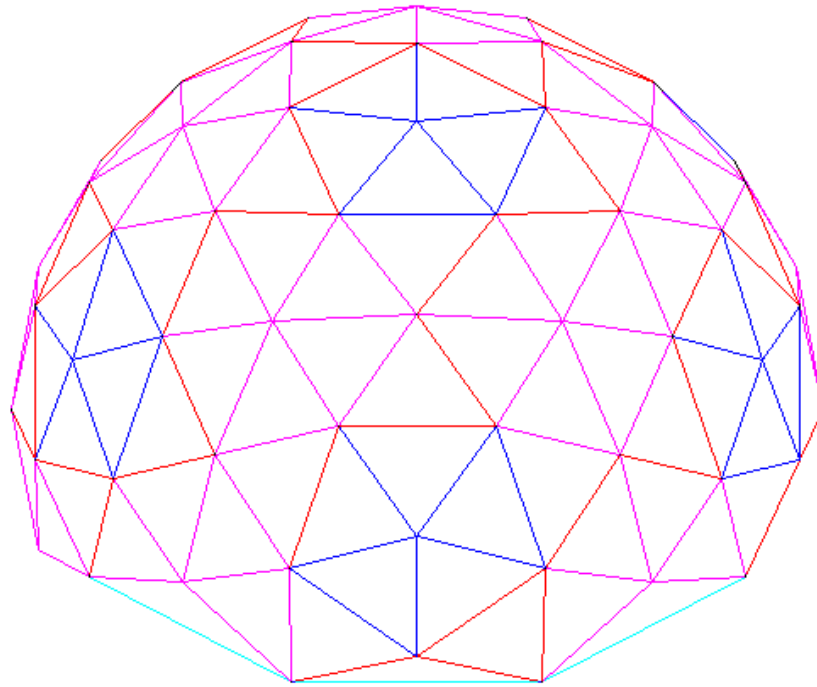

1/2 Reduction I Geodesic

**Reduction I Geodesic**

If one were to compare this type of structure with the present Buckminster Fuller type of Geodesic, it would be like comparing an Isocahedron based system to a discipline which is a composite of both the isocahedron and dodacahedron, but which leans more toward the dodacahedron in overall attributes. It's underlying structural compound being the Tri-Pent Geodesic. The principal advantage of this system, other than greater versatility from having more possible configurations, is that it is a derived system which can be converted into a compound geodesic with ease, offering greater strength to the system. A compound system would concentrate compression forces on the comparatively stronger short members and tension on the relatively weaker long members. Other geodesic and structural domes can be derived from this type of discipline.

---

The following gif shows a full Reduction I Geodesic and six different possible arrays of components. This configuration is well suited for use in designing an intermediate sized structural dome. Its' drawback is that there are 6 different shaped panels involved in constructing a partial dome. Four different shaped panels required for a full dome.

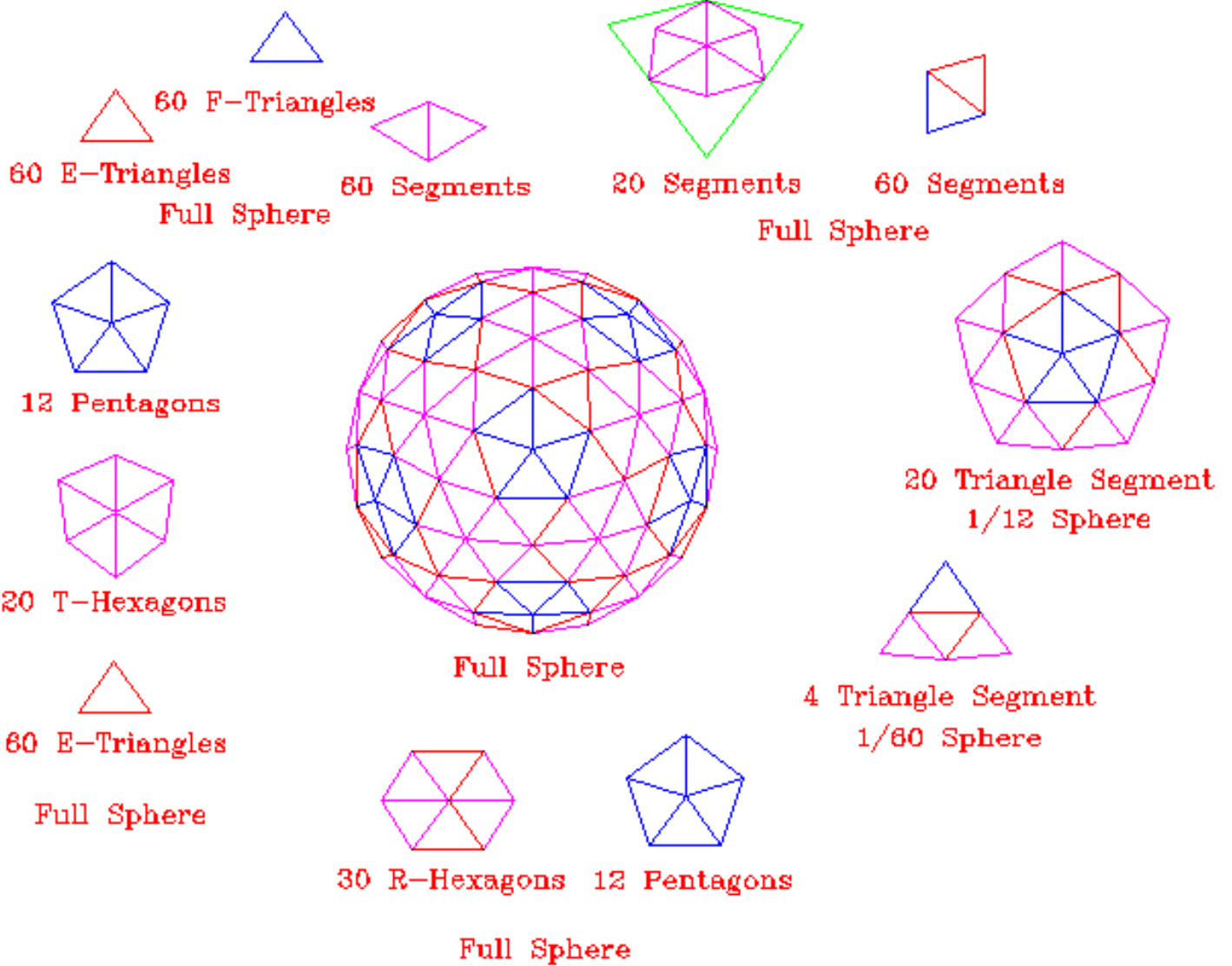

**Full Reduction I Geodesic with Components**

---

The following graphic is of an 80 panel 2/5 50' diameter reduction I dome.

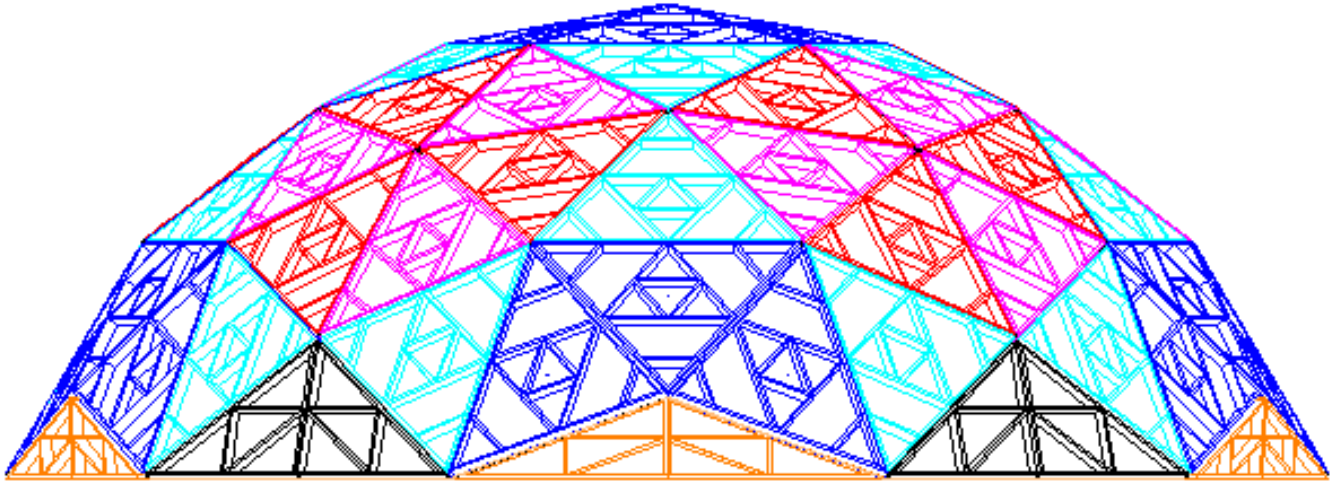

## 2/5 50' Diameter Reduction I Dome

- [Geodesic House Structure](#)
- [Return to Cover Page](#)



The following photo shows some of the cut-out patterns made into models. The following cut-out CAD drawings do not encompass all of the the models shown. Page last updated 6/30/97.





- [Return to cover page](#)

The following drawing represents the golden section close packing of molecules. It is presented as 12 sphericals each having 6 individual orbits per sphere. The structure of each sphere is along the lines of a icosidodecahedron encased in the space structure of a truncated icosahedron. Based on the arc segment chord lengths of the icosidodecahedron being unity, the outer 12 encased icosidodecahedrons sphericals have a radius of Tau ((square root of 5) + 1)/2) and the inner icosidodecahedron encased in a space frame dodecahedron has a radius of Tau (squared). The outer orbits touch but do not overlap at any place. The inner icosidodecahedron spherical is not evident in this diagram but its surface is penetrated by the outer spheres in the form of 12 pentagon shaped dimples of a chord length of Tau. The individual 6 orbits of the inner and outer spheres are not in conflict. This is a work in progress. Feel free to add comments. updated 2/25/97 rlc. Reworked on 2/19/98 rlc.

[http://ourworld.compuserve.com/homepages/robert\\_conroy](http://ourworld.compuserve.com/homepages/robert_conroy)

1/10/97 rlc  
hexpent2.dwg  
molecu-d.gif

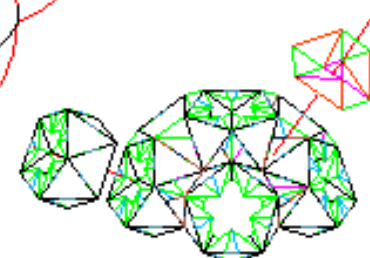
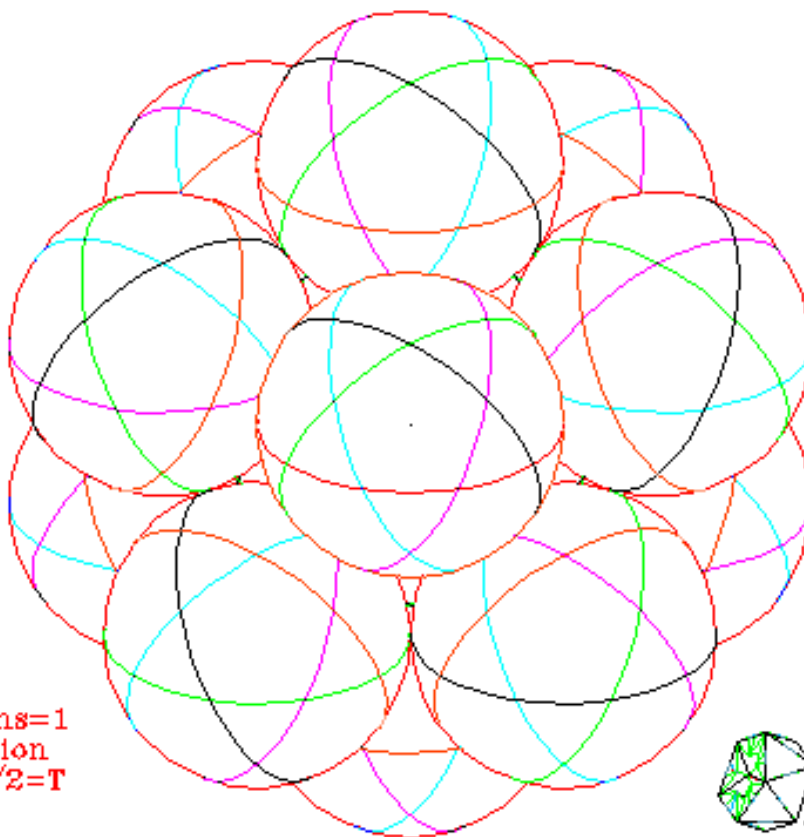

Mean Proportion Geodesic

**Notes**

1. Arc chord lengths=1
2. T=mean proportion
3. Radius<sub>1</sub> =  $(\sqrt{5}+1)/2=T$
4. Radius<sub>2</sub> =  $T^2$
5. Radius<sub>1</sub> is the radius of spheres shown
6. Radius<sub>2</sub> is the radius of the inner base sphere

**Molecular Close Packing**

(based on mean proportion geodesic architecture)

The following graphic is of a double unit icosahedron inscribed into an octahedron.

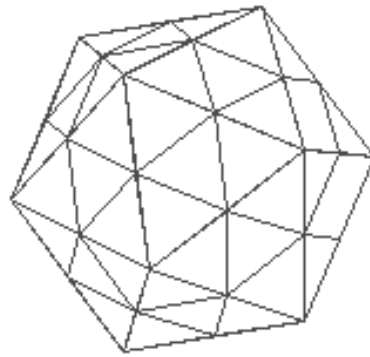

molecu-b.dwg.  
ico-octo.gif  
2/5/97 rlc

Double Unit Icosahedron

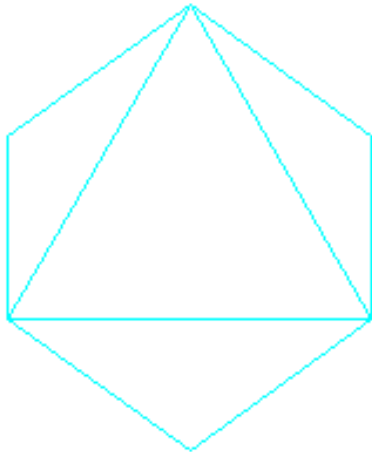

Octahedron

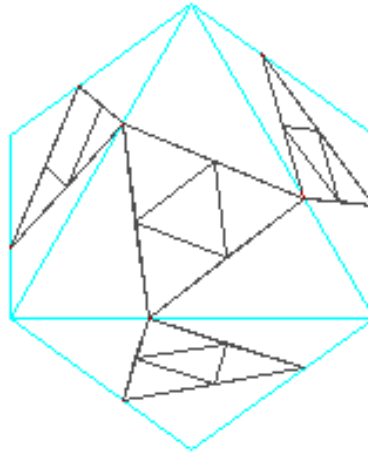

Double unit Icosahedron inscribed into an Octagon

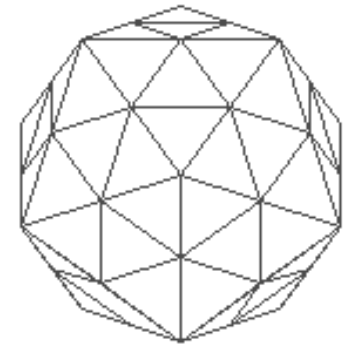

Top view  
Double Unit Icosahedron

## An Icosahedron inscribed into an Octahedron

---

The following graphic is of a double unit icosahedron inscribed into a tetrahedron. This double unit Icosahedron would be 1/2 the the size of the one inscribed into a octahedron with an equivalent chord length. Actually 4 more 1/4 sized double unit icosahedrons could be inscribed into this same tetrahedron, but for simplicity, they are left out in this graphic.

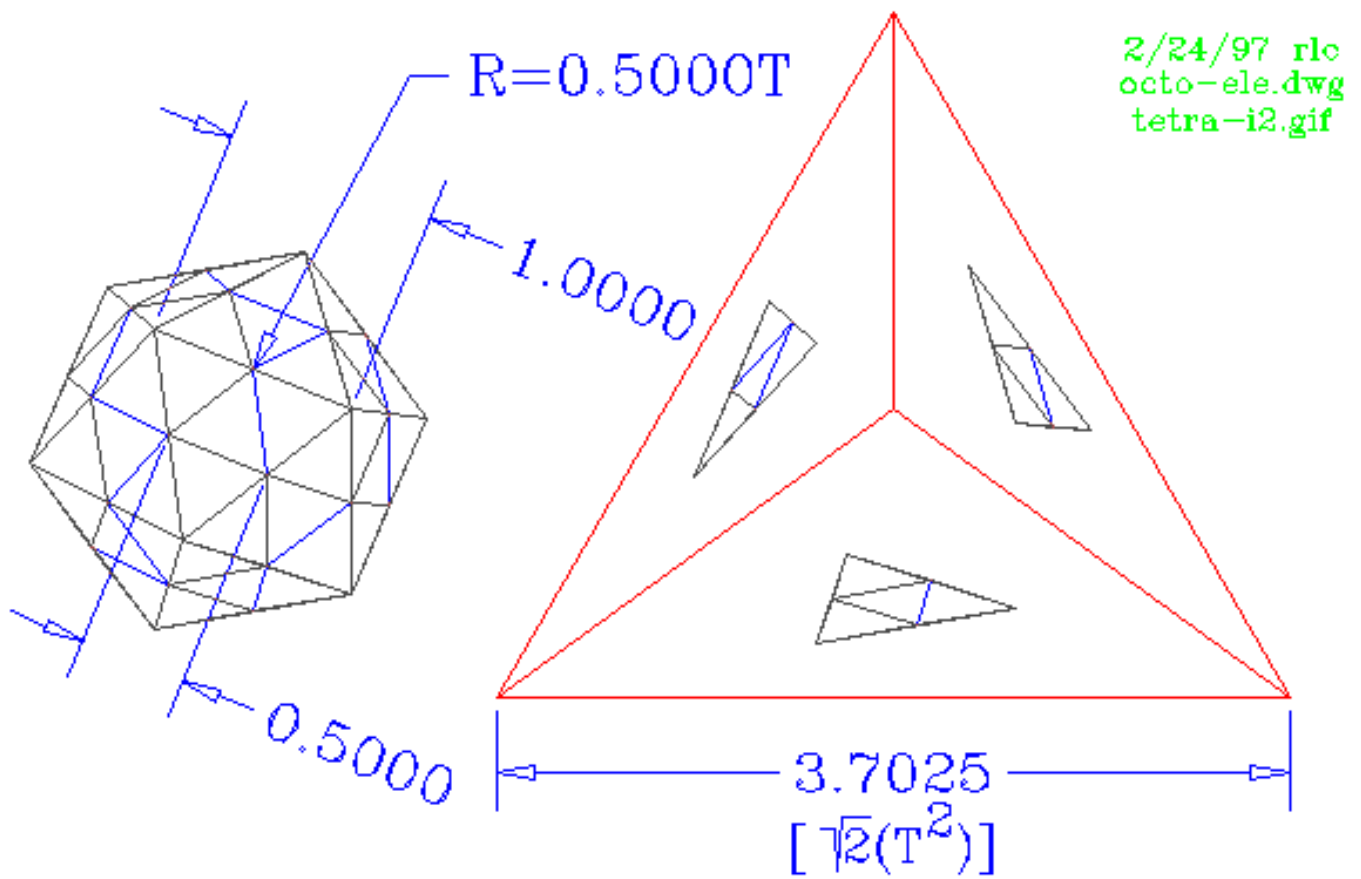

Double Unit Icosahedron inscribed in a Tetrahedron

**Double Unit Icosahedron inscribed into Tetrahedron**

By combining icosidodecahedrons inscribed in octahedrons to those of icosidodecahedrons inscribed into tetrahedrons would give you an octet type of packing arrangement. This can be considered a double enclosed 3 dimensional fractal because not only can the octet be built into larger octahedrons and tetrahedrons, but the base icosidodecahedron can be reduced to smaller icosahedrons and dodecahedrons back to an original smaller icosidodecahedron.

Model.gif  
 Octo-ele.dwg.  
 2/25/97 rlc

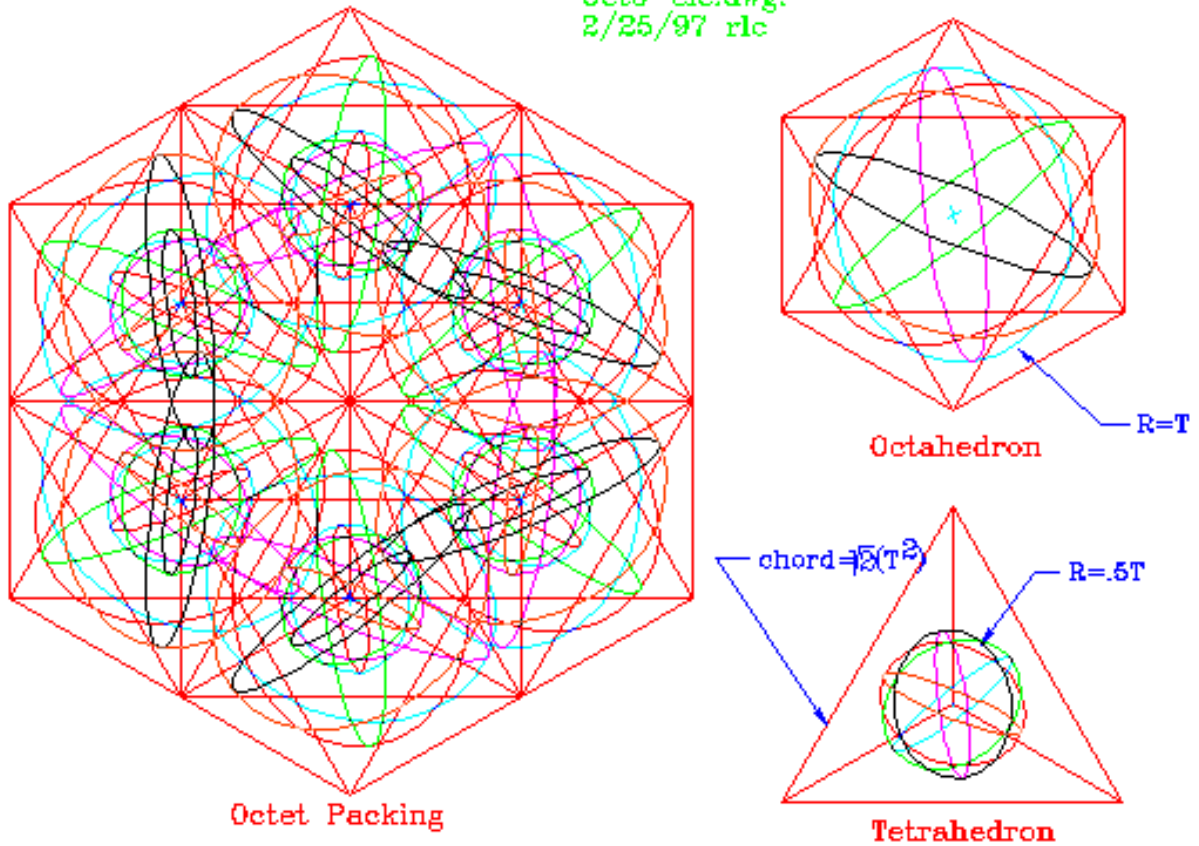

## Molecular Modeling using Platonic and Archimedian Solids

The following graphic is of a golden section packing arrangement inscribed into an octahedron. This particular graphic is shown from the face view of the octahedron. From this angle you have a hexagonal view. From a side angle you would get a 10 sided view. The interior sphere has a radius of  $T^2$  while the outer 12 spheres have a radius of  $T$ .

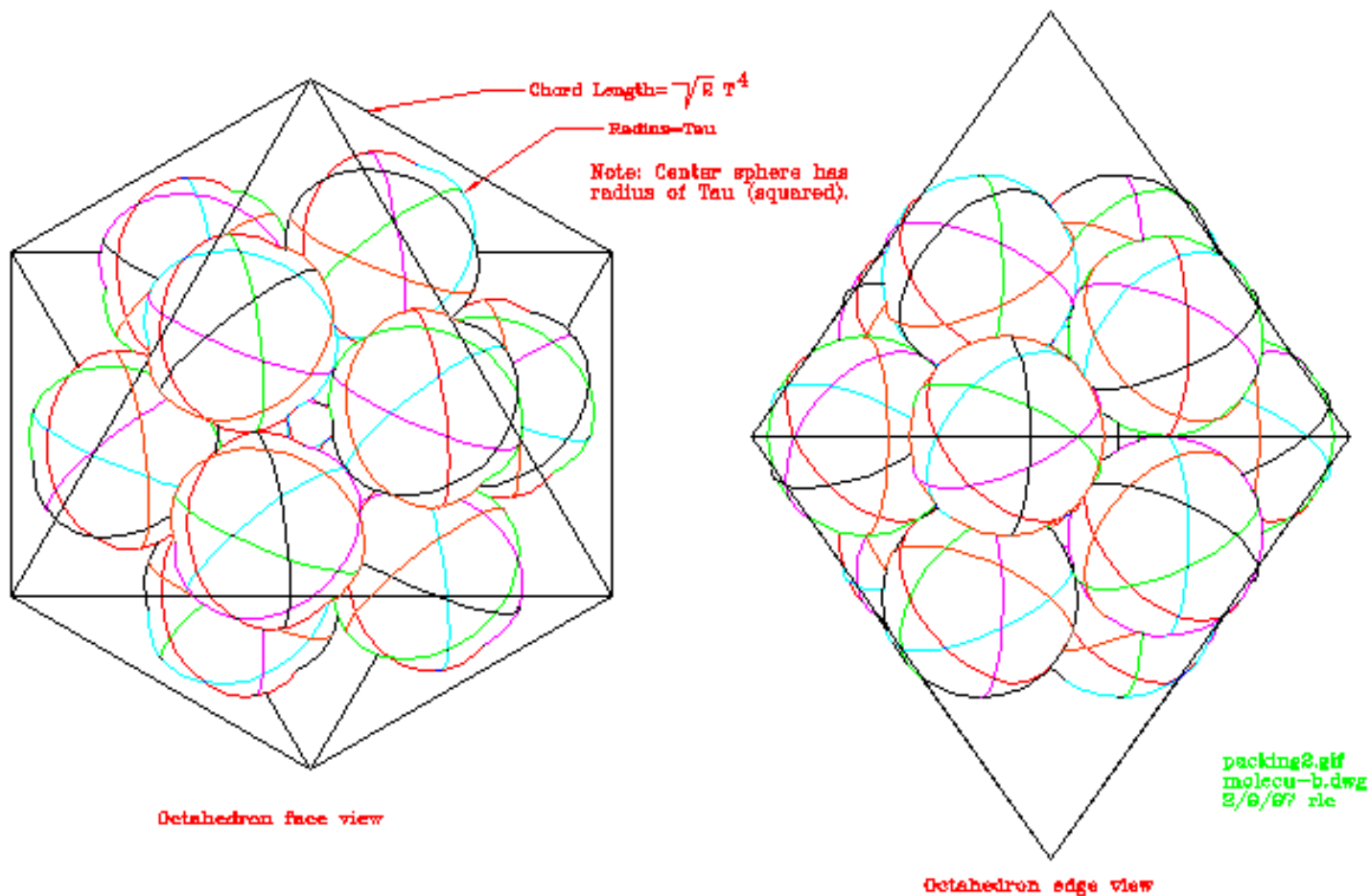

### Golden Section Close Packing inscribed in an Octahedron

---

## Molecular Modeling

- [virus link \(x-ray crystallography\)](#)
- [Platonic Elements](#)
- [3D Platonic Fractals](#)
- [Unified Theory](#)
- [Click to make comments](#)
- [return to cover page](#)

# Unified Theory

Einstein spent approximately 30 years seeking a unified theory, yet before his death, he confided in a friend, Solovine, that "there is not a single concept of which I am certain it will stand the test of time". Over 30 years later, we still have no unified theory, and yet only now are some people beginning to question the foundations of that theory, supposedly laid by Einstein. It is my theory that to come to a unified theory you have to unify the physical, the mental, and the spiritual. I believe that as long as our society is in spiritual darkness it will remain in a scientific limbo, with no unifying insight. I believe that the Tanakh was inspired by the Creator, and in it, I believe, is hidden, in plain view, the structure of the Universe. My hypothesis is that the architecture of Nature is hidden in plain sight. Man was supposedly made in the Creator's image and the living sanctuary of that Creator was supposedly Israel or later, the "church" supposedly built on the apostles. You might ask yourself what is the architecture of Israel. Is it not the 3 patriarchs and the 12 tribes of Israel? You might ask yourself what is the architecture of the non living tabernacle also. Today's scientific community's standard model for the elemental particles, based heavily on symmetry assumptions, consist of 6 pairs of Quarks and Leptons. This would parallel the 12 or 6 pairs of apostles sent out to teach the gospel of the "kingdom" by Y'shua, or the 12 tribes of Israel descended from the 3 patriarchs. The problem is that the inner sanctuary of the non living tabernacle has a symmetry of 10 and not 12 and that there are 13 tribes of Israel when taking into account the splitting of the tribe of Joseph, and there are 13 apostles when adding the self proclaimed apostle Paul. Using the symmetries of geometry, I can show that 5 male-female pairs are required to produce a regenerative progressive series of self reproducing structural identities, which would correspond to the 10 faithful apostle architecture. The other 3 apostles being the unfaithful Peter, the suicidal Judas, and the self proclaimed apostle Paul. The 12 geometrical structural elements, plus the alternate 13th, represent the 13 tribes or apostles. The tetrahedron element, being the most elegant and a system to itself when married to the non paired octahedron element, would be in my opinion, a representation of the "morning star", or the fallen angel, Lucifer, the "deceiver" and the ruler of the world and its' present paradigm. The tetrahedron's parallel, among the apostles, would be the foremost apostle of our day, Paul. The octahedron element would parallel Peter. These two elements when combined in proper proportions form a cube, the modern architecture of today's man made world and the shape of the structure hiding the inner sanctum of the holy of holies. Peter and Paul would be the two staffs of Zechariah 11:7. These two would be the shepherds of the flock "doomed" for slaughter". Following the blue print supplied in the Tanakh, along with what is being discovered today, my hypothesis is that as with the original 12 sons, the 12 basic elements will combine into 72 basic compounds. These 12 basic elements will also have 12 anti-elements, mirrored by Jacobs brother Essa and his 12 sons. The 72 basic compounds will have anti-compounds which makes the sum 144. Just as in the desert, the 144 total will be assembled in groups of tens, and of hundreds making a total of 144,000, These will each have corresponding energy signatures. These signatures correspond to the over 100,000 known spectographic markers. I believe that these same type of elemental structures form the blue print of Nature in the form of linked DNA. The four basic markers of DNA would be built around the icosahedron, the dodecahedron, the icosidodecahedron, and the mean proportional geodesic. These would correspond to the 4 angels who sat at the 4 corners of the globe in the "Book of Revelations" or even in the characteristic of the Mayan globe with its' 4 guardians. Remember that the Mayans are credited with the most accurate calendar based on a 13 month year. The "Mean



Proportional Geodesic" would correspond to the angel with the double edged sword who prevents access to the garden of Eden, or in other words, it would correspond to the philosopher stone. This stone supposedly being the key to transmutation and the transmutation being the key to the energy of the universe and a life without toil.

- [Metaphysical Aspects of Structural Elements](#)
- [Structural Elements](#)
- [Molecular Modeling](#)
- [3D Platonic Fractals](#)
- [return to cover page](#)

The following graphic is of a 3-D Fractal based on the Mean Proportional Geodesic. These forms, although they have the recursive self similarity of conventional fractals, do not appear on first observation to have any chaos factor. Any randomness of pattern seems to be based on the energy level at creation. The molecular architecture of living matter seems to follow such a radial propagation as shown. The molecular architecture of non living matter seems to follow the architecture of the closer packed planar octet type of arrangement. The Mean proportional Geodesic consist of 12 molecules surrounding a mother molecule of a proportional larger size of Tau. The mother molecule is not included in this graphic. This graphic was first posted on 6/5/97 by rlc.

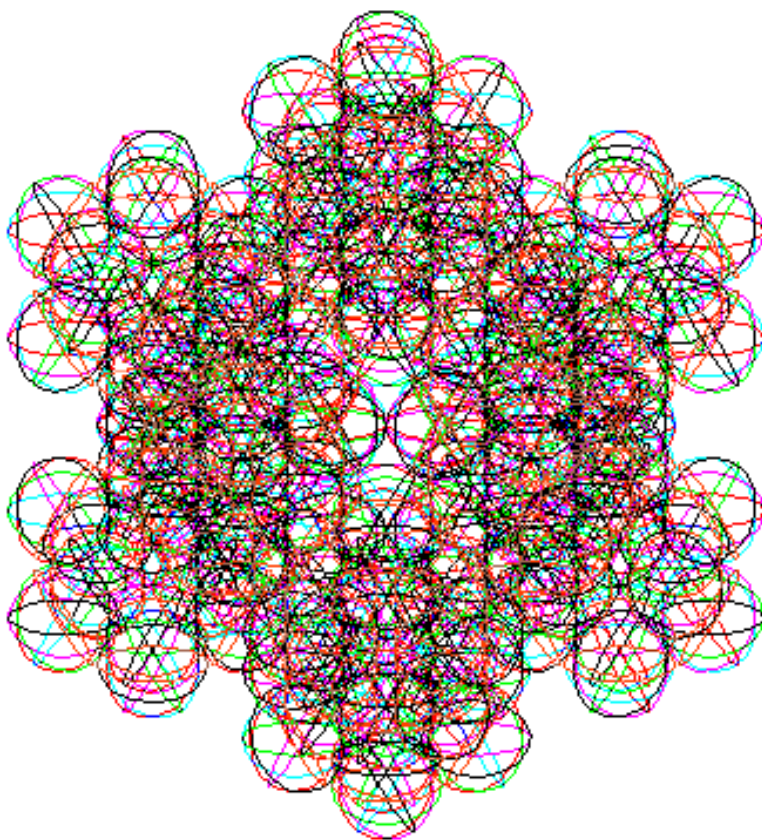

Note: Size proportion is Tau(squared), while the architecture is the mean proportional geodesic.

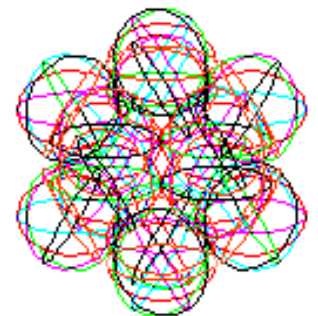

3DFractl.gif  
Molecu-D.dwg.  
5/28/97 rlc

## Mean Proportional 3-D Fractal

- [Mean Proportional Geodesic](#)

---

The following graphic is of a 3D Fractal octet truss arrangement with a golden section packing inset which has a  $u(n+1)=u(n) + 1$  unidirectional size progression if the outer chord of the octahedron is considered as 1. The inset "golden section" packing can be again fractalized in a 1: Tau(squared) progression as shown in the preceding graphic. The graphic can be expanded to become a fractal image of a tetrahedron but was not done so in this case. All 12 basic Platonic elements along with the 5 Platonic solids can be presented as 3D fractals by using a combination of the elements.

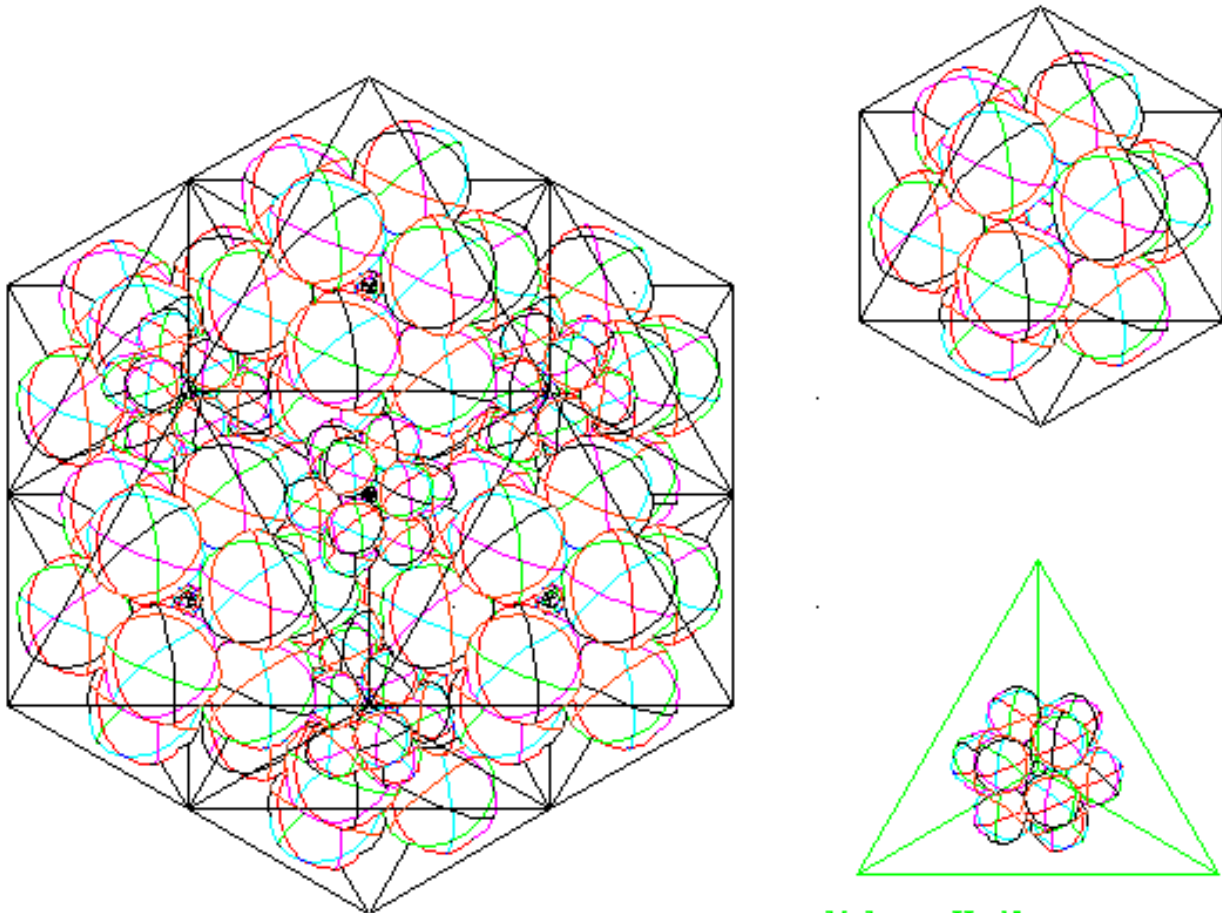

Molecu-H.gif  
 Molecu-H.dwg  
 5/29/97 rlc

### Octet Fractal with Golden Section Progression Inset

---

Hypothesis I: My hypothesis is that the fundamental elements of Plato; earth, water, air & fire refer to the internal geometrical structure of what we now refer to as quarks and leptons. Not that Plato understood his teachings which he obtained from the Egyptians, but the Egyptians priest themselves probably didn't understand what had been passed down to them. I feel that by understanding the underlying structure of matter which is mirrored in a macromolecular way, one can do such things as disassociate water molecules with a minimum of energy expended by simply knowing the internodal distances and determining the harmonic frequencies required to break the bonds. This in the future could be a cheap source of energy.

---

Hypothesis II: I propose that the molecule C-60 is not based on the architecture of the Bucky Ball as is now the commonly thought, but that it is based on the mean proportional geodesic. The difference between the two, being that the Bucky Ball is an Icosahedron truncated at the 1/3 distances from the vertices, while the mean proportion is a truncated at the 1/Tau(squared) mark.

- [Molecular Modeling using the 13 Platonic Elements](#)
- [Individual Platonic Elements](#)

- [Unified Theory based on Platonic Elements](#)
- [Return to Cover Page](#)

## Metaphysical Aspects of Structural Elements

The blueprint for all of Nature can be found in the first 5 books of the bible. A clarification of that description can be found in the life and teachings of Y'shua. The most profound description being the tabernacle in the desert. Although the 12 tribes of Israel were to be a priestly people among whom YHWH would dwell, the sanctuary only has 10 curtains. The same parallel exists among what is known as the the 12 apostles. The church of today, taught by some as being the tabernacle of YHWH, is based on the teachings and authority of basically only two of these apostles, Peter and Paul. The problem being that the actual sanctuary has only a 10 fold symetry and not a 12 fold one. The same applies to the elemental structure of Nature. The foremost two worldly elements along with their corresponding two apostles are the great pretenders. They have a purpose but it is the unseen elements which are the basis of structure and truth. The tetrahedron and the octahedron along with their corresponding apostles are simply a facade. All atoms are spherical in nature. You will not find a atom nor molecule with the shape of a tetrahedron nor of an octahedron. The atoms may combine in an octet latice type arrangement, but it is only a facade that you see. The basic structure has nothing to do with either the octahedron nor the tetrahedron. Revelation says that the beast with the two horns like a lamb will deceive the whole world. Constantine the establisher of the Holy Roman Catholic is that beast and his two horns are Peter and Paul in the form of the Catholic and Protestant church. Peter being believed to the the rock the church is built on by the Catholics and Paul being the foundation of the teachings of the Protestant church. In the upcoming millenium, there will be no reliance on Peter or Paul, nor on their parallel elements, the octahedron and tetrahedron. It should be noted that the combination of the tetrahedron and 4 octahedron elements is a cube, the basic structure of this present world. For biblical reference as to who Peter and Paul actually were, go to Zechariah 11:7. Orisis was the primary Egyptian god with links to the pyramid, is now honored under the Greek name of Apollo in the symbol and name of the US space program. That symbol being a 2 dimensional view of a tetrahedron originally surrounded by the constellation Orion. Of course the powers to be changed the background constellation when they felt they had shown too much of their hand, but the original seal of the NASA had the Orion constellation background. The gods worshipped of old are still the same ones worshipped today and are none other than "heavenly watchers" of the Scriptures. The leader of them, the "Great Pretender" or Deceiver, is according to Revelations, to be cast back upon the earth to persecute the "Holy People". Of course Revelation goes on to say that the Deceiver will be crushed and chained away for 1000 years.

- [Unified Theory](#)
- [3D Platonic Fractals](#)
- [Platonic Elements](#)
- [Molecular Modeling](#)
- [The How of the Apostacy \(FTP site\)\(wps\)](#)

- [Kingdom of Heaven \(FTP site\)\(wps\)](#)
- 

**"Text of the Day"**

"Fear YHWH, and give Him glory, because the hour of his judgment has come; and worship Him who made the heaven and the earth and the sea and springs of waters." (Rev 14:7)

---

created 5/97 updated 5/16/97

- [return to cover page](#)

## Solid Geometry Shareware Workbook Page

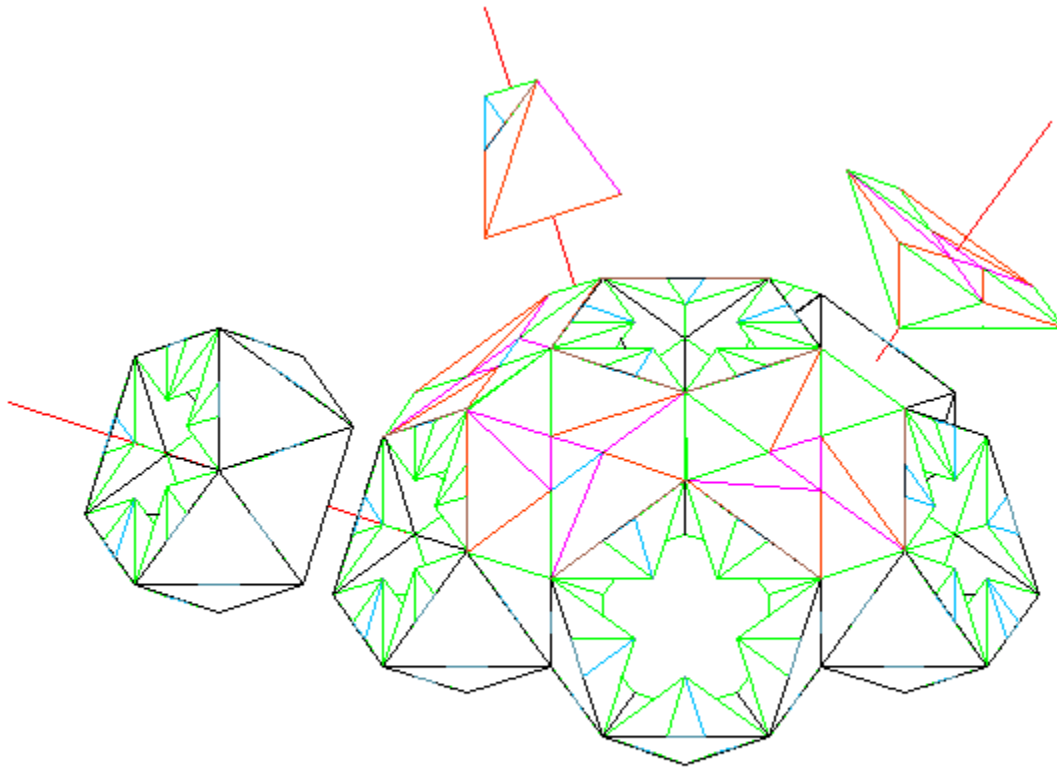

Partial Hex–Pent Geodesic

---

### ShareWare

## "Geometric Elements with Complex and Simple Compounds"

Teachers and students can download the shareware 3D geometry workbooks. It is shareware in the sense that if the person downloading is 100% satisfied with the workbook, and has come away with a better feel for 3D geometry, then they are asked to remit a fee to the following address: Robert Conroy, 312 East 79th Street, K.C. MO 64114. The suggested fee for each level of workbook, for classroom use, is \$8 for Level 1, \$10 for Level 2, and \$12 for Level 3. The teacher has authorization to print and make as many copies of original, hopefully to 70# paper or card stock, for the use of students in that class. In the case of independent students, the suggested shareware fee would be \$1 for Level 1, \$2 for Level 2, and \$3 for level 3.

- [Go to Level 1 ShareWare Workbook \(for 3rd grade and above\)](#)
- [Go to Level 2 ShareWare Workbook \(for 6th grade and above\)](#)

- [Go to Level 3 ShareWare Workbook \(suggested for 8th grade and above\)](#)

To access the shareware workbooks from an ftp site, click on the following appropriate description. You will probably find it easier to print from the gif files located within the zip files at the following ftp sites.

- [ftp site for Level 1 shareware Workbook](#)
  - [ftp site for Level 2 shareware Workbook](#)
  - [ftp site for Level 3 shareware Workbook](#)
- 

- [Robert\\_Conroy@compuserve.com](mailto:Robert_Conroy@compuserve.com)
- [Return to Home page](#)



The following drawing is of a 32' dome set on a 36" high post and beam kneewall. The awning structure can be used not only in giving window and door protection, but to gap space when adding dome structures together. Two linked structures can provide space for a 2400 square foot 6 bedroom - 4 bath home. revised 7/21/98

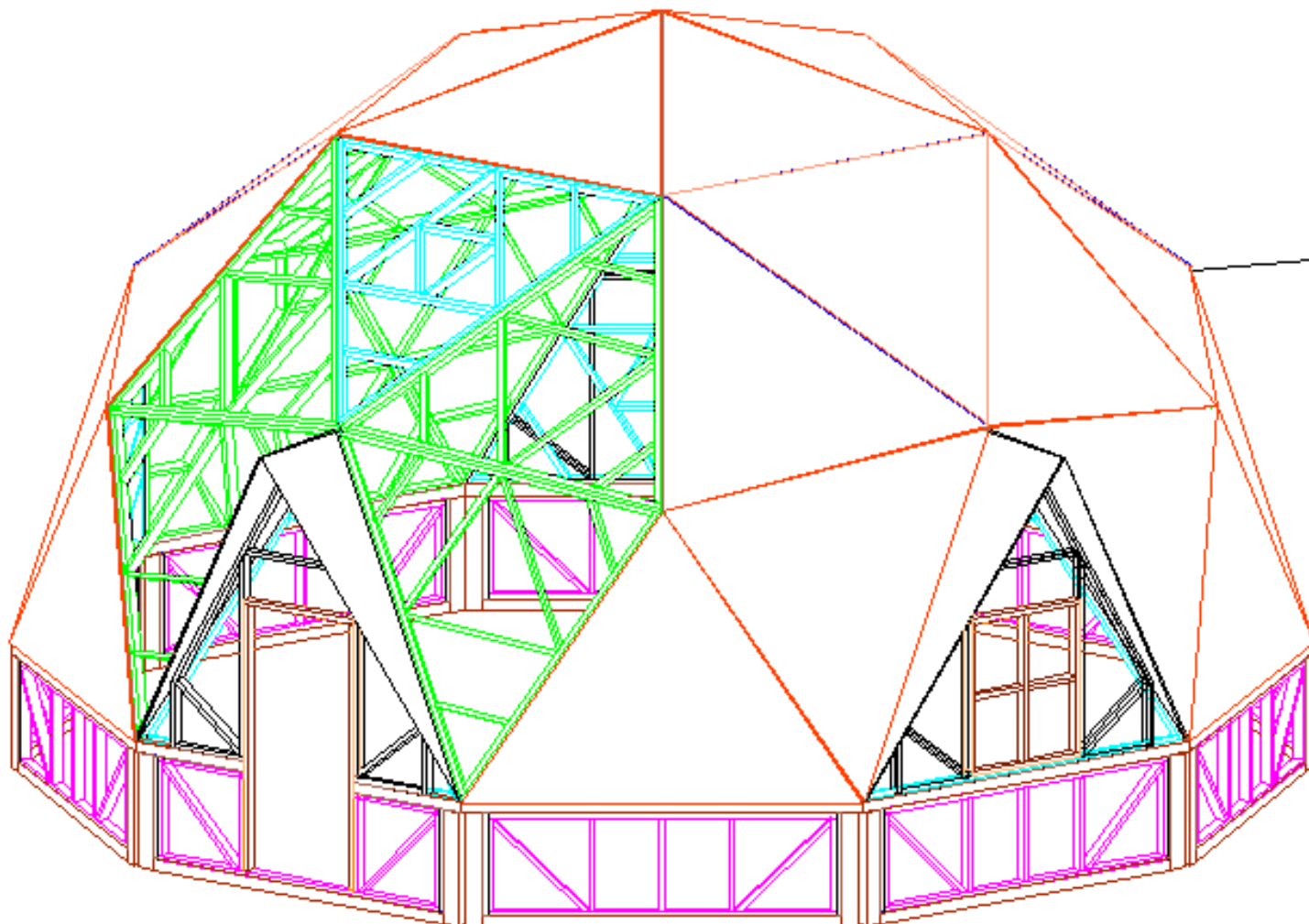

---

- [Paper Model](#)

---

The following photo is of a 40 panel 1/2 composite geodesic set on a 3' kneewall. The structure is derived from the structural elements of nature. It's connectors are the epitamy of simplicity. The truss system, consisting of only two types of primary panels, is lightweight, weighing in at about 2200 pounds. The panels averaging about 54 pounds each, without sheathing. The Truss portion of the dome takes about 24 man-hours to erect.



The following photo is of a 32' geodesic with a Peel & Seal roofing being applied. The number of the Peel & Seal manufacturer, mfm, is 1-800-882-ROOF. This particular truss is set on a 3' kneewall. updated 4/6/97





### **32' Earth-Contact Dome**

This weathertight structure, including earth work, cost approximately \$6000 in materials and bobcat labor. This cost does not include 2nd floor framing or concrete slab. The only interior work reflected in this cost is the cost of the gravel subfloor. I recommend a reflective roof covering to prevent the roof from absorbing energy from the sun and then re-radiating it to the interior of the dome.

---

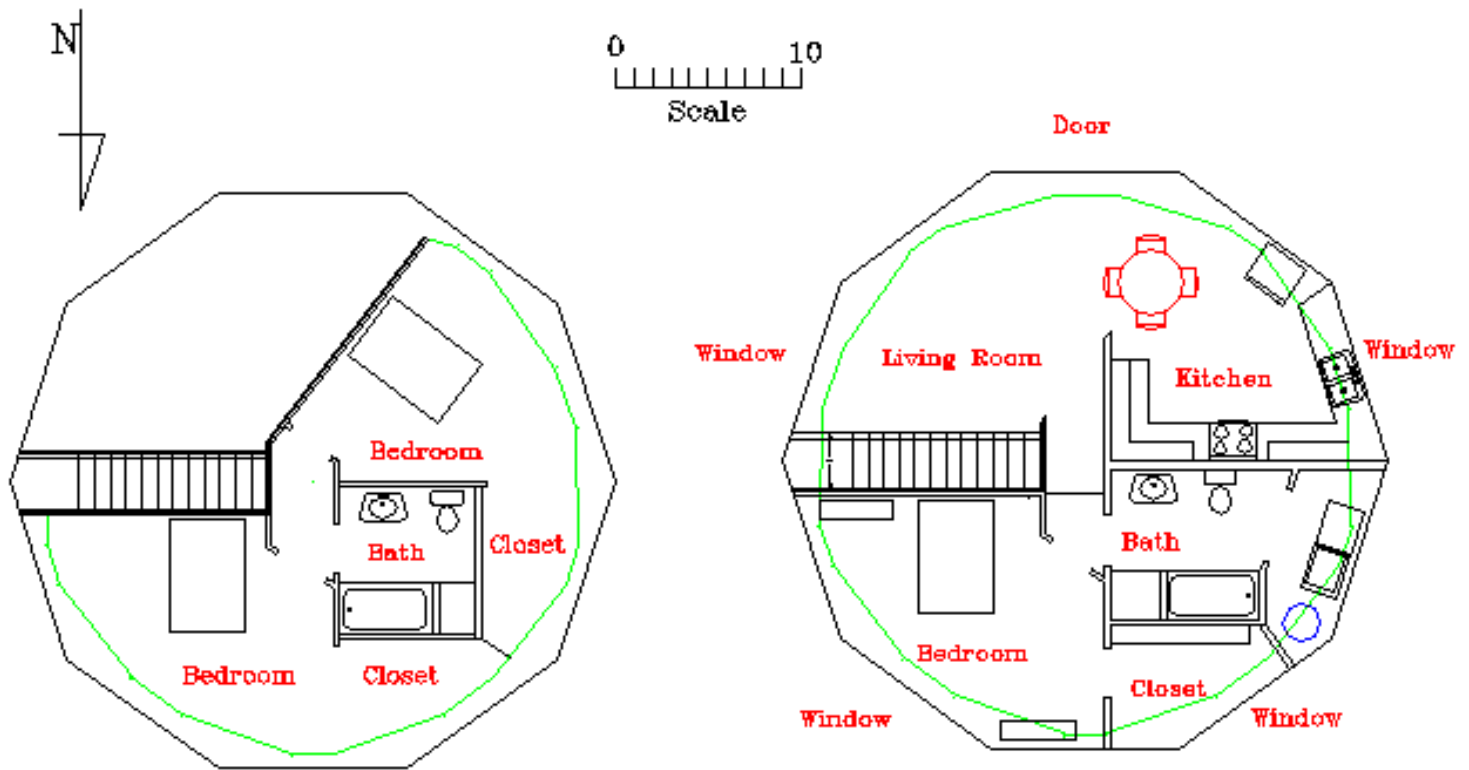

**Second Floor**  
Total 2nd floor area=430 Sq Ft.

**First Floor**  
Area=768 Sq Ft

32' Dome  
Type III

layout32.dwg.  
32door6p.dwg  
32door6p.gif  
7/10/98 rlc

For Full Set of Printed 32' Fabrication Plans:  
(includes truss, sheathing, kneewall, and awnings)  
Send \$64.00 plus \$3 postage and handling to:  
Mountain Truss Corporation  
312 East 79th Street  
Kansas City, Missouri 64114

- [32' -2nd floor joist plans](#)

\$80 for fabrication plans for 2nd floor supports and joist plus \$3 postage and handling

- [Fabrication Training Classes](#)
- [Return to Cover Page](#)

The follow photo is of a cutting jig, comprised of two power miter saws bolted two 2 x 4 runners which track along a 2 x 4 rail. Full fabrication of basic truss takes about 24 man-hours for trained worker.



## Cutting Jig

- [Link to Larry Keegan's miter saw layout](#)

---

The following photo shows the connecting members being drilled via the use of a drilling jig.



## Drill Jig

---

The following photo shows the scrap lumber being run through a tilted table saw blade to produce the connecting wedge pieces.



## Cutting of Wedge Connectors

---

The following JPG shows the panels being nailed up using a jig panel as a pattern.





## Nail up of Panels

---

The following photo shows the sheathing being cut with use of a pattern.



## Use of Pattern in Cutting the Sheathing

- [Illustration of Dome Construction](#)
- [return to cover page](#)

This page is in construction and will be updated whenever photos can be developed and digitized and then updated to WEB page. The last update was on 12/29/96. Because of the nature of some browsers the reader will need to refresh the screen after new updates or the browser will simply show what was here before the last update.

---

The following photo is of the panels being delivered and the base being laid out. The inside chord distance of the base support is 10' and the inside radius of the base chord is 16' 2-5/32". The layout needs to be precisely done both with respect to the radius of the base support and it's being level.



## Panel Delivery and Base Layout

---

The following photo is of the double 4 x 6 post being set into their flared pier holes and then marked and cut at elevation of base support beam.



## Post Being Set and Cut

---

The following photo shows the base support beam being anchored in place.



## Base Support Beam Being Bolted Down

Pier encased, brace supported double post were used in the design to overcome the general case of loss of strength due to placing domes on a kneewall. Except in the case of localized deformation of the earth itself, this type of kneewall should result in no loss in overall strength of this structure during the post designed lifetime of 50 years.

---

The following photo shows the first base panels being braced and tacked to baseboard. The upper panels of the first level are then temporarily tied and then bolted to the base panels making sure the proper wedge element is inserted.



## Base Level Panels

---

The following photo shows the second level being assembled. The base of the 2nd level panel is temporarily tied off to the upper first level while the upper part is being held by a temporary brace support. Once the panel is properly positioned, it is then loosely bolted along the base. The rest of the 2nd level is then done in the approximate same manner, paralleling that which was done on the first level. The third level is done approximately the same way.



## The 2nd level positioning of panels

The following photo is also of the 2nd level but at a different point in erection.



- [return to cover page](#)



The following graphic is of a 24' diameter structure that I have just finished building. My cost for roofing (elastomeric waterproofing coating), lumber, bolts, screws, nails, windows (double pane insulated with wooden sash), and doors (insulated metal) was approximately \$2937.39 with an extra \$149.31 spent for pattern and jig lumber. Of this amount, approximately \$1400 was for the lumber, hardware, and sheathing for the basic dome without awnings, roofing, and kneewall. 10/20/97. The time required for the basic fabrication is about 72 man hours. This would be for a trained worker using simple jigs in a proper environment. This equates to 9 working days or 12 weeks of part time work of 2 hours every other day. updated 11/23/97

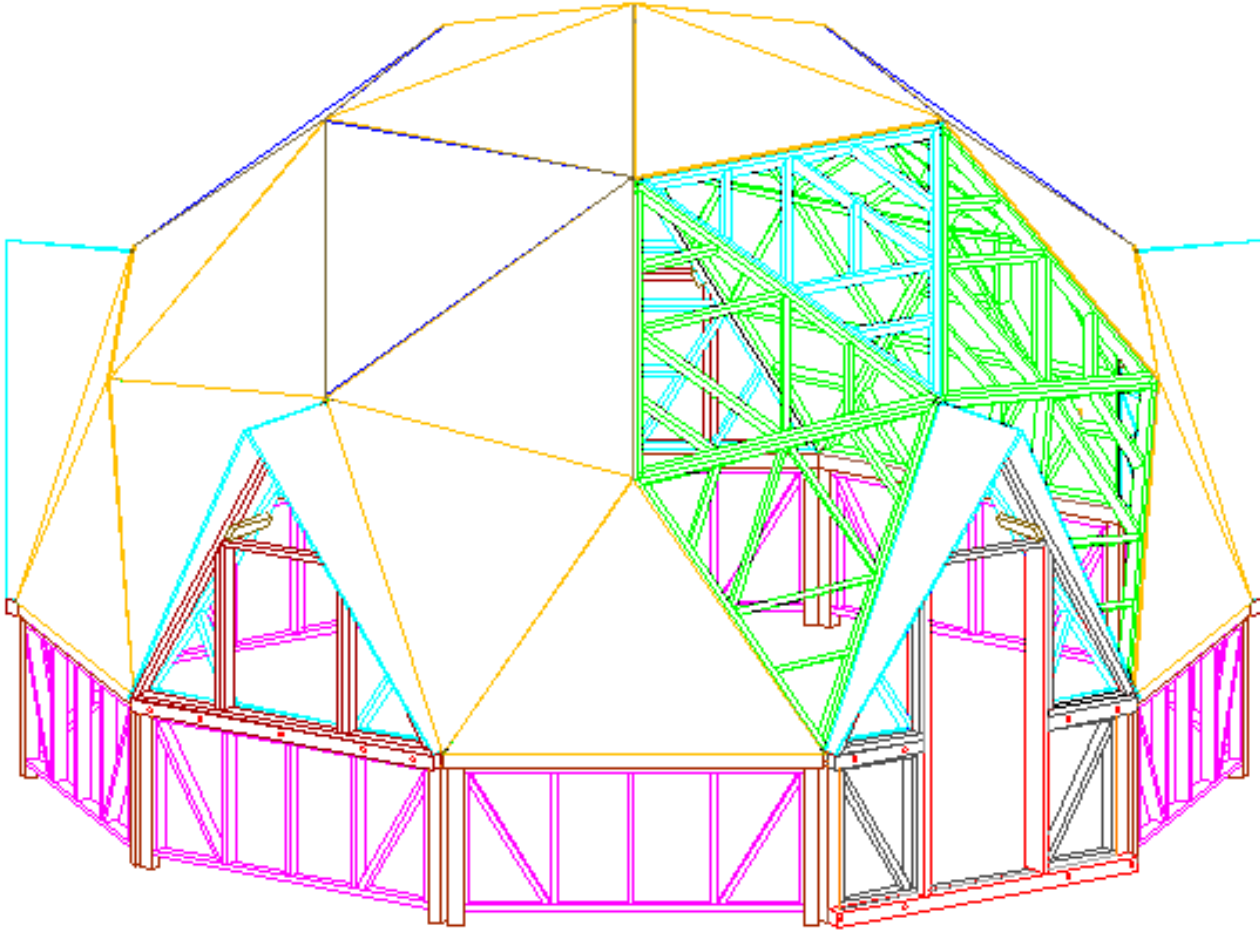

## 24' Diameter Dome

copyright 1997 RobertConroy

## 24' Diameter Geodesic Structure

---

The following is a photo of the 24' dome. The kneewall at the time of the photo had not been primed and coated. The roof turbine shown at the top of the dome is tied in with the wedge channel between the panels in order to ventilate the roof structure whenever the inside surface is finished.



**Photo of 24' Dome**

I highly recommend using a reflective material for the roofing to prevent the roof from acting as an energy absorber and re-radiating the collected heat to the interior of the dome. Unless the insulation used has a radiant barrier, such as an aluminum backing, standard insulation has little effect on radiant energy.

---

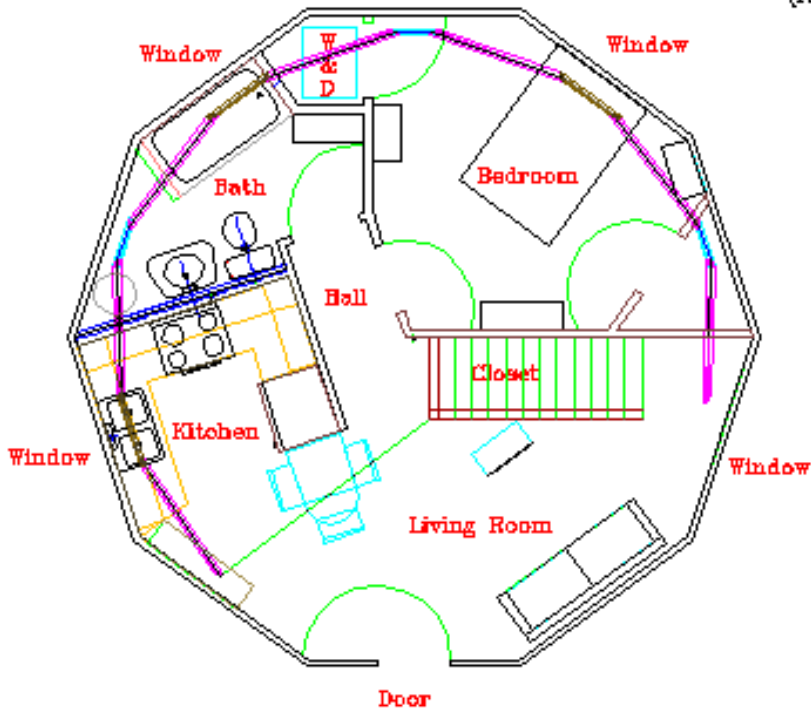
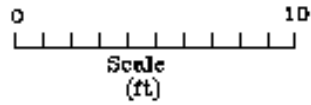

1st Floor Plan

(430 s.f.)

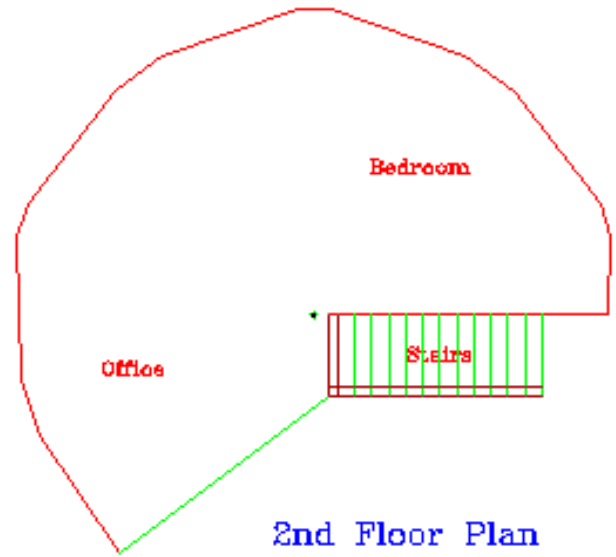

2nd Floor Plan

(240 s.f.)

24' Diameter Mountain Truss Dome  
Type 1C

24plan2.dwg,  
24plan2c.gif  
11/23/97 rlc  
revised 8/9/99 rlc

### Plan View for 24' Diameter Geodesic

For larger plan areas, simply add domes together. The window and door awning panels are the same dimensions and can be changed from one to the other. The awning is designed in such a way to join two same size domes together.

The following photo shows how the second floor joist rest on a simple 2x10 joist hanger which has a 2x4 ledger. The joist are also supported by the 1st floor dividing walls.



## Joist Hangers

---

- [Photos of Fabrication Process \(AOL\)](#)
- [Photos of Assembly Process \(AOL\)](#)
- [Insulating and Sheetrock Procedures](#)
- [24' Fabrication Plans \(shareware\)](#)
- [24' Energy Calculations](#)
- [Business Opportunity](#)
- [To order dome kits](#)

- [Return to cover page](#)

## Greenhouse, Air Lock, Solar Collector for 24' Dome

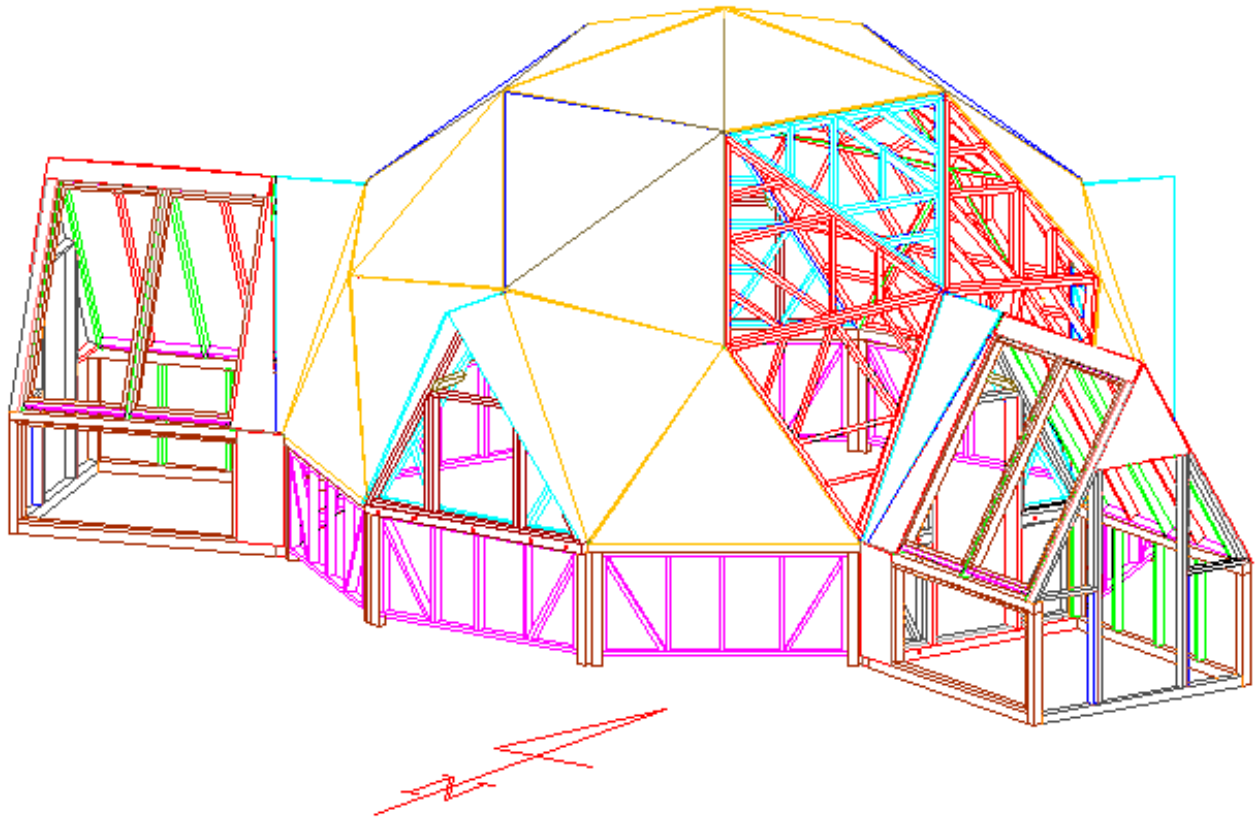

### 24' Dome with Attachments

The entryway, greenhouse, solar collector structure can also be used as a sauna, solar hot water tank building, or even as an attached combination wood stove-rock heat storage building. To see an animation of the construction, click on following link.

---



### **Greenhouse-Entry-Solar Collector**

Movable aluminized board insulation is used to prevent summer over heating and to capture and retain more heat in the winter. Black water barrels can be used under back side work table to help moderate temperatures.

---

### **For Printed Greenhouse Plans**

Send \$25 plus \$5 postage and handling to:  
Mountain Truss Corporation  
312 East 79th Street  
Kansas City, Missouri  
64114

---

- [GIF Animation of Greenhouse Construction \(97 kips\)](#)
- [Photos of greenhouse construction](#)
- [Greenhouse Fabrication Plans \(Shareware\)](#)
- [24' Dome House](#)
- [Return to Homepage](#)

[Main](#) >> [Business Park](#) >> [Other Building & Construction](#)

I am a  seeking   
Love@AOL Get started today >>

## Fabricate 24' Diameter Dome

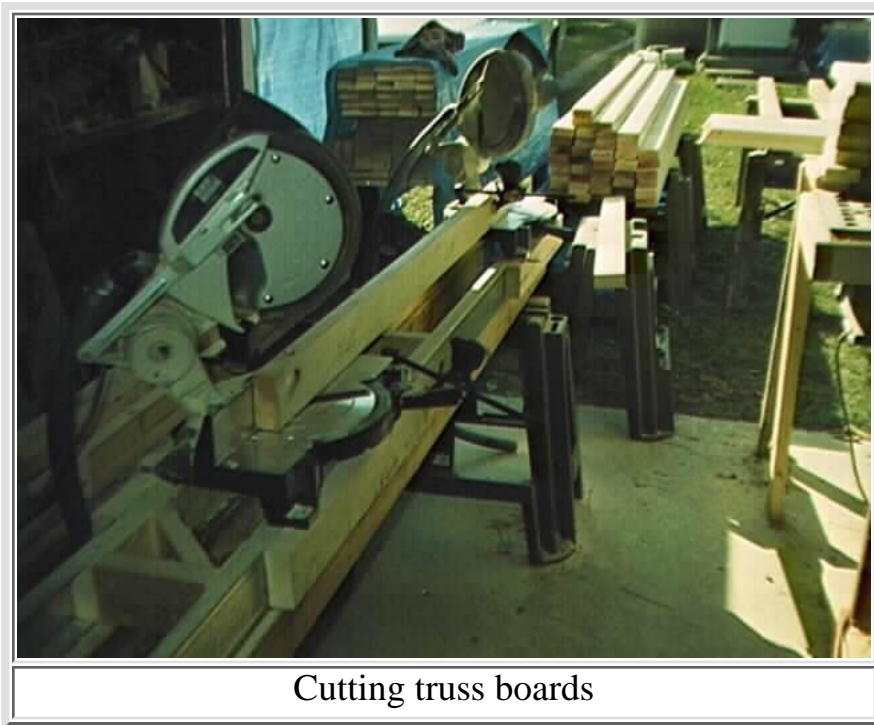

The boards are accurately cut using two power miter saws bolted to runners clamped to a rail constructed from 2 parallel 2x4s.

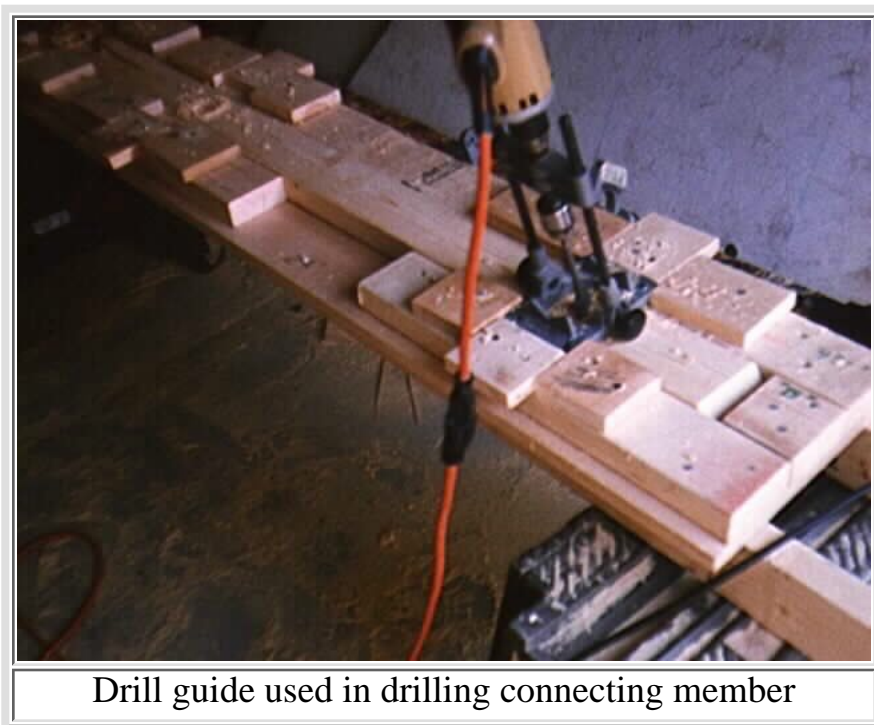

A drill jig combined with a TECH Craft drill guide is used to accurately drill the connecting members.





A pattern panel is used to create panels

Two different precisely constructed pattern panels with side cleats are used in constructing the subsequent panels. Ten equal lateral panels and thirty pentagon panels.



Boards being drilled to make wedge connectors

The scrap lumber from cutting panel boards is cut in multiples of 4" lengths. These short pieces are then drilled for 7/16" bolt holes on 4" centers, starting 2" from the end.



Ripping the predrilled Wedge connector boards

The short predrilled wedge boards are run through cutting guides attached to a table saw. The saw blade is tilted to the appropriate angle, and the boards are run through twice, switching sides on each pass.



Cut predrilled wedge board in 4 inch increments

The predilled wedge boards are cut in 4" increments.



A Pattern is used to cut the plywood sheathing

A pattern in combination with a power saw is used to cut the plywood sheathing. Holes in the pattern are used to mark the sheathing for fastener placement.



Cleats are used to position sheathing to panels

Temporary placement cleats are used on the sides of the panels when accurately positioning the sheathing. If elastomeric is going to be used as a roofing, then any holes or protrusions need to be filled and sanded before priming and painting.



Attach wedge connectors

The wedge connectors must be attached prior to assembly when presheathing the panels. It is also advisable to do the same when using unsheathed panels. The wedges should only be attached to either the right or left hand side of each panel, and can be attached using 18 x 1-1/4" wire nails.

## Links

- [Return to home page](#)

I am a  seeking   
Love@AOL Get started today >>

## Assemble 24' Diameter Dome



Using the cedar concrete pad form boards and a center stake, layout the pier holes using rebars as markers.

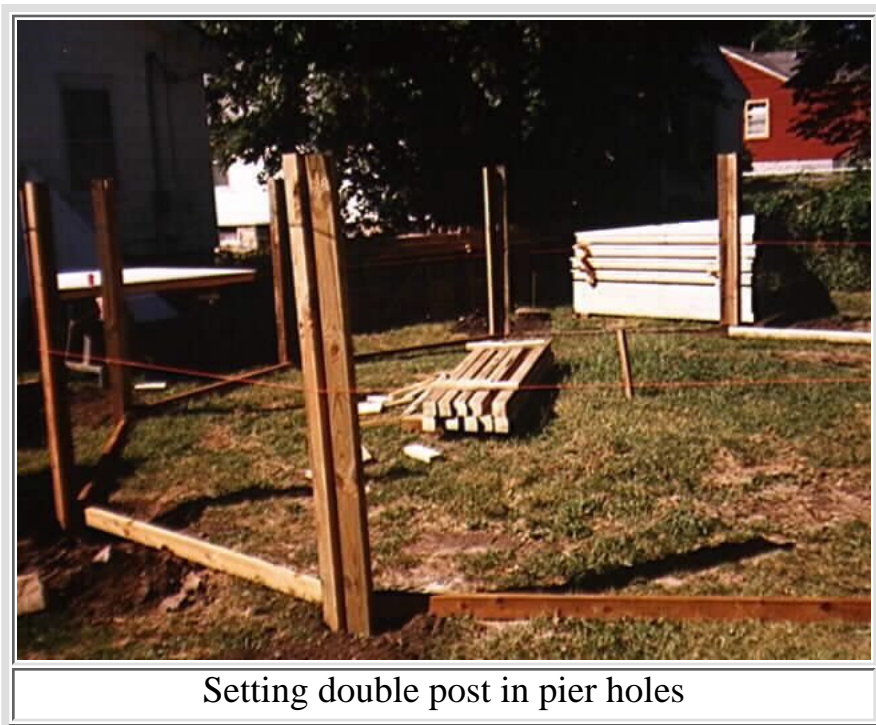

Dig pier holes and set double corner post.



First level panels braced at 10 degree slant

The 1st level base panels are temporarily tacked into place and braced at an approximately 10 degree inward tilt. After all the panels have been bolted together, the base panel is then bolted to base support beam.



Temporary scaffold used for 2nd level panels

A temporary scaffold is used to stage the upper level panels into place.



Exterior view of partial 24' dome

This is an exterior view of a the partial complete 24' dome.



The awning support structure

The awning support structure is supported by an auxiliary base beam which is bolted to the main support beam.

## Links

- [Return to home page](#)

The following photo is of a 16' diameter, 3/4 double unit isocahedron greenhouse.



**16' Diameter Double Unit Isocahedron Greenhouse**

- [Greenhouse paper model](#)

---

The following photo is of a 1/4 domed greenhouse structure. It limits the amount of material required, while at the same time limiting the amount of surface area available for heat loss. The panels used are the same as for the 3/4 dome that is shown above.





### **Five panel greenhouse structure**

updated 1/18/99 rlc

- [Order page](#)
- [Return to Cover Page](#)

The same procedure being shown for this 13' diameter ferro-cement cellar can be used with the 24' diameter conduit truss to produce a larger ferro-cement structure. updated 7 Dec 98 rlc reupdated 3/25/99 rlc

### Storm Shelter, Fallout Shelter, Root Cellar

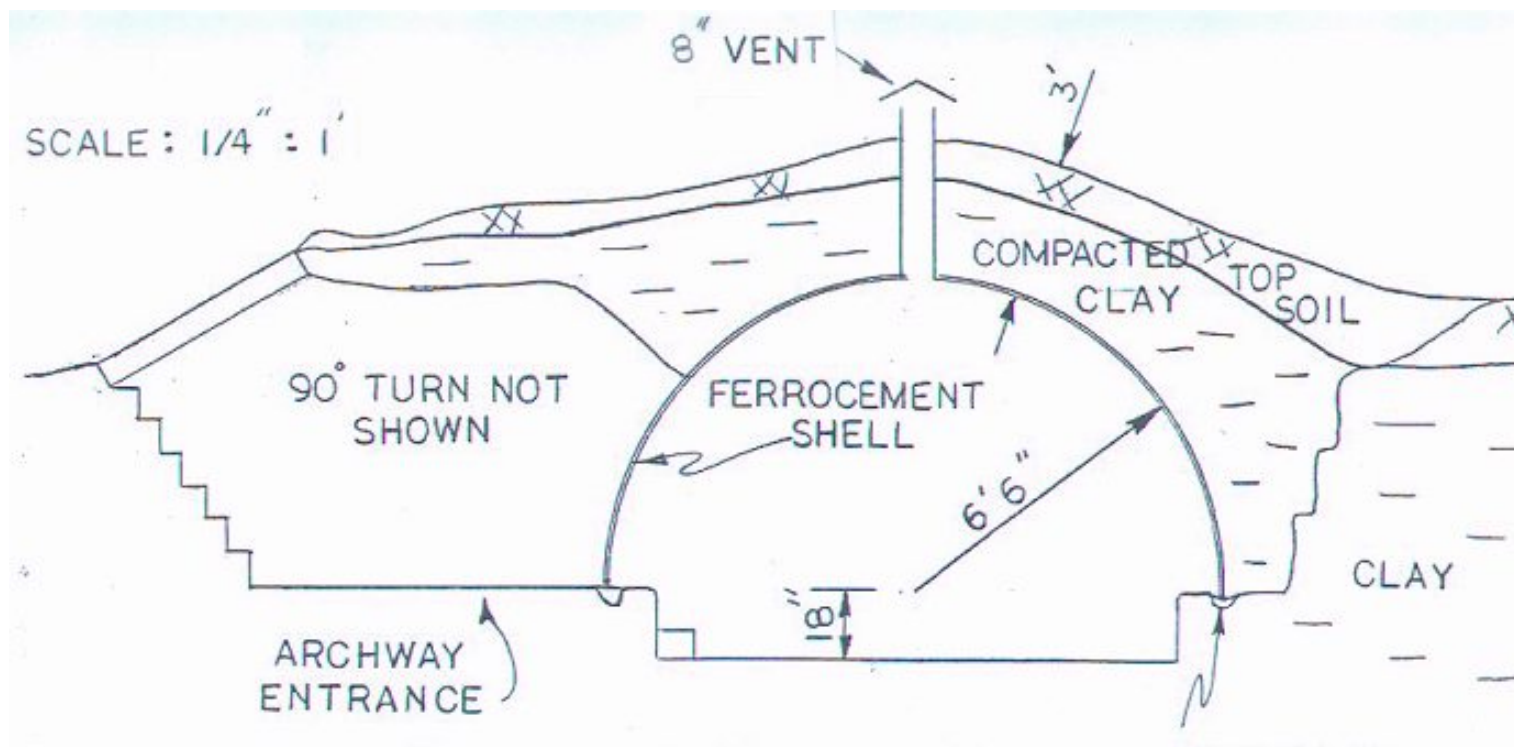

This design is based on a conduit geodesic truss acting as a form upon which a multi-layered chicken wire covering is wired. This wire mesh then being plastered with a sand-cement mix. The dome shell will rest on a soft footing allowing the dome to settle which in turns allows the compacted clay overburden to act as an earth arch. To provide extra radiation and overblast protection, the arched entry must have a 90\* turn and you must install a blast valve to keep your ear drums from rupturing during a nuclear blast.



### **13' Conduit Truss with Mesh**

This emergency exit hatch is located at the rear of the dome. It is to be used in case the structure is used as a fallout shelter. The extra entryway lets the inhabitants set up a direct air flow through the shelter to prevent claustrophobic conditions.

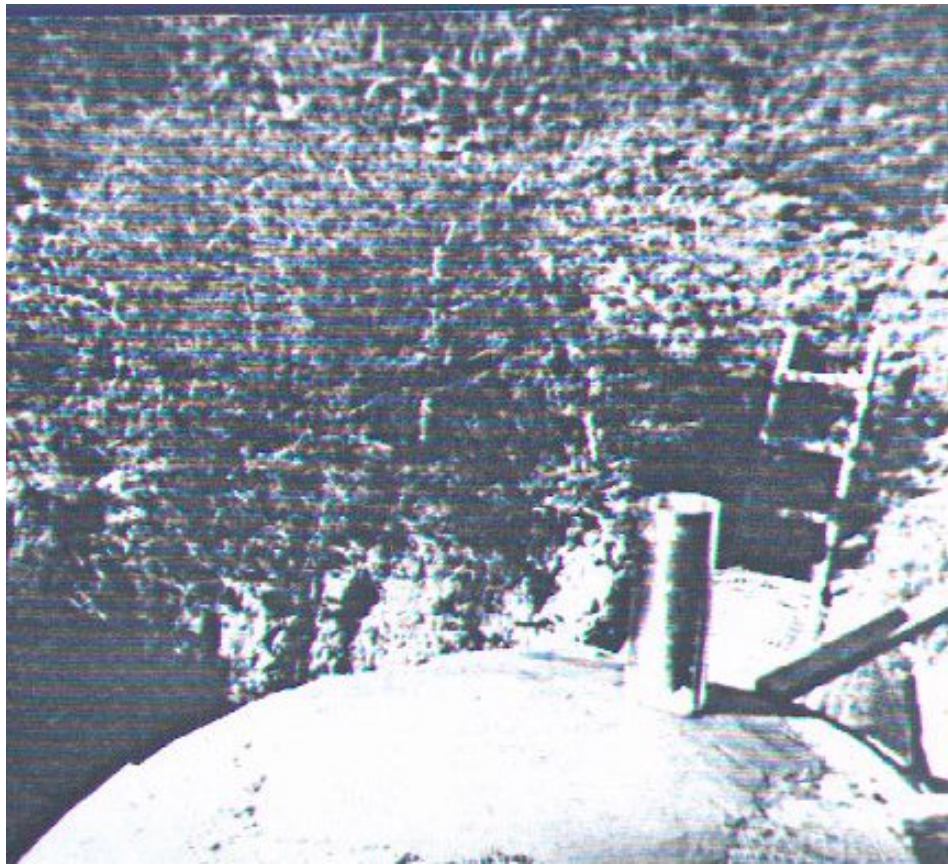

**Sand-Cement Mix being applied to Mesh**

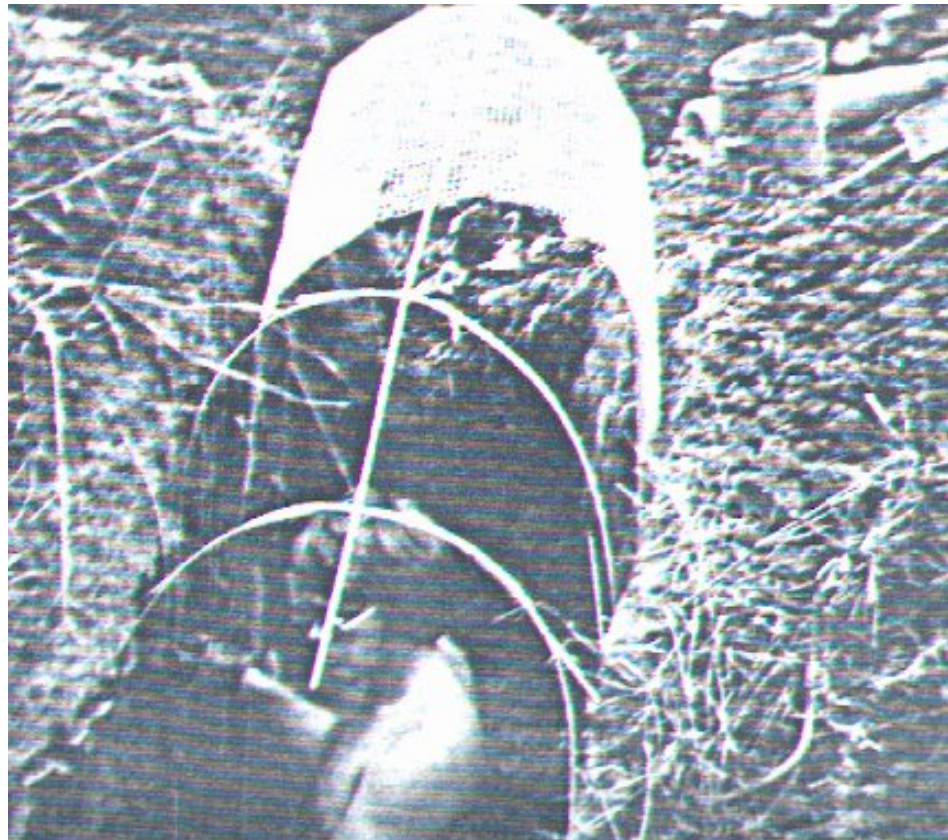

**Forming of curved entry**

The entryway should be curved so that the structure can have a secondary purpose of being a fallout shelter. By curving the entranceway, you can keep a designed 3' of earth between the inhabitants and the radiating fallout.

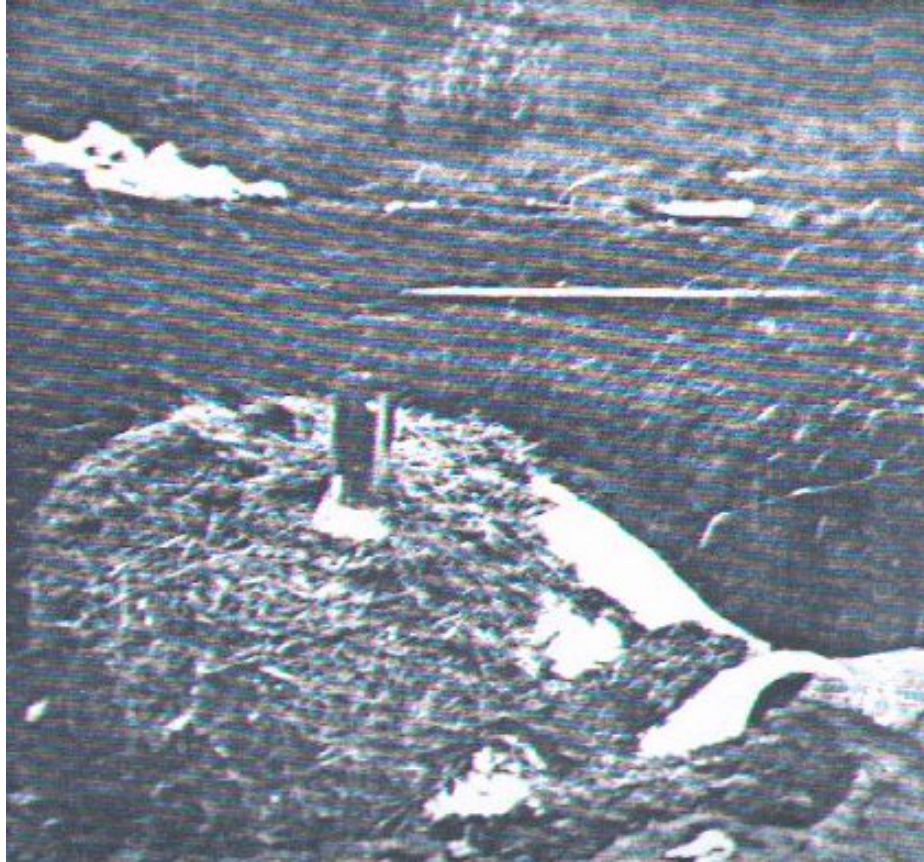

### **Backfill of Dome Structure**

The dome is covered with straw to help the structure achieve it's ultimate load capacity, which is achieved due to the effect of earth arching.

Note: If I were building another shelter, I would simply use a rebar form achored in a narrow reinforced footing. It would require a temporary support, but it incorporates the form into the structure which increases its' strength. Also, it simplifies the construction and allows easier access to plastering the inside of the shell.

- [Conduit Geodesics](#)
- [Return to Cover Page](#)

The following photo is of a 1260 square foot earth contact, light weight concrete guniting free form open faced dome. My entire owner built complete cost was approximately \$26,000. The design requires some familiarity with concrete work and therefore may not be suitable for all owner builders. (updated 7 Dec 98)



**30' Diameter Lightweight Earthcontact Concrete Dome**



### **Rebar forming and temporary supports**

Note: To prevent any nonuniform settlement of the dome, the beam footing was heavily reinforced and kept to a 10" width. The standard codes call for wider footings, but then again, at least 80% of houses built under standard codes, have foundation cracks. With a concrete roof, it is not advisable to follow a tradition that could lead to cracking and subsequent roof leaks. With a narrow footing, there will be greater soil pressures, leading to a possible increased settlement, but settlement is not a problem, uneven settlement is.

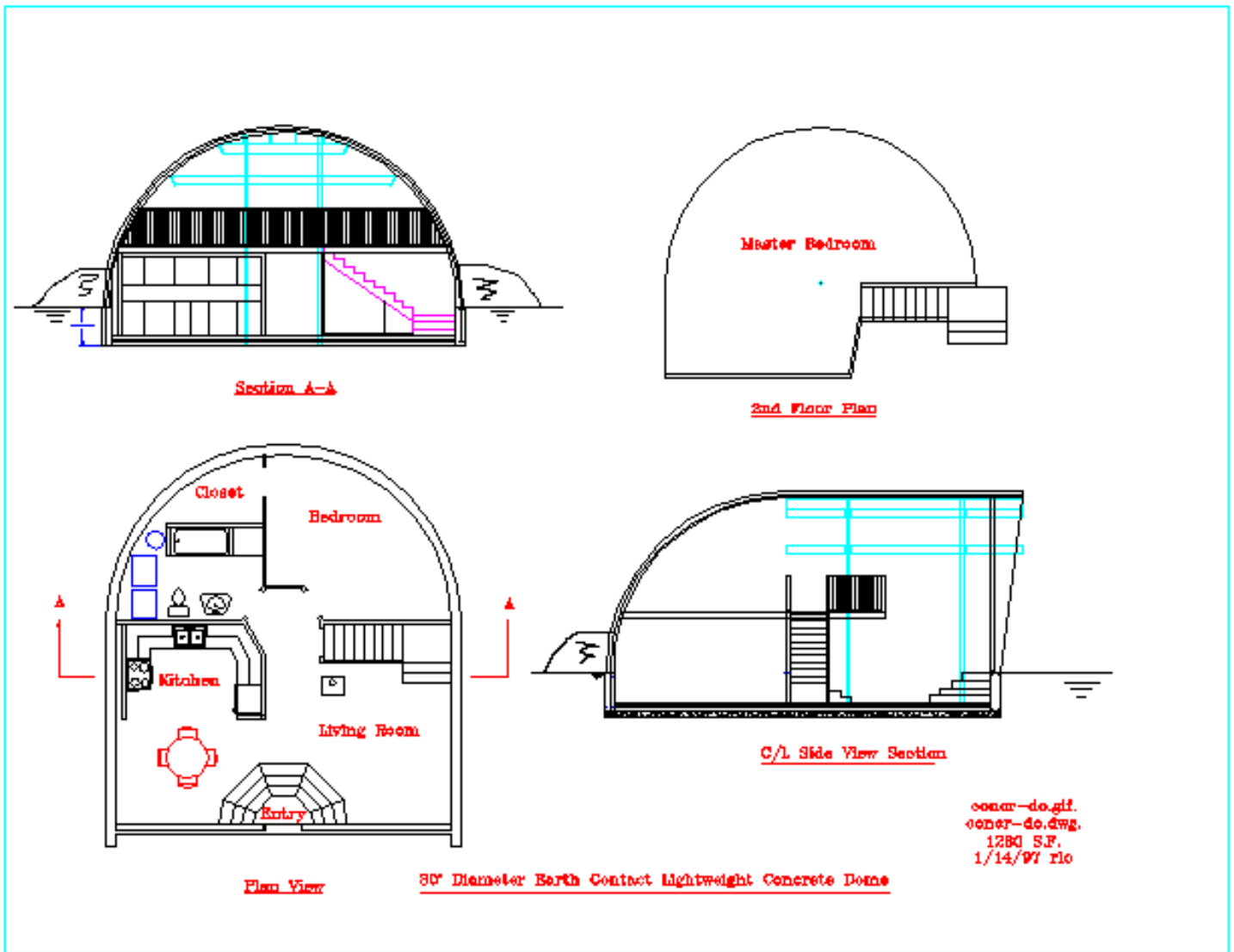

### 30' concrete dome plan

- [E-mail address: Robert\\_Conroy.compuserve.com](mailto:Robert_Conroy.compuserve.com)
- [Return to cover page](#)



# Interesting Links

(first posted 3/22/98) (revised 5/31/99)

---

## Construction

- [Building Standards ICBO](#)
  - [Solar Map \\*\\*\\*\\*](#)
  - [Information on Farm Resources](#)
  - [\\$10 composting toilet](#)
- 

## Y2K

- [Y2K Information \\*\\*\\*\\*](#)
  - [Non Hybrid Seed Source](#)
- 

## Geometry

- [DNA](#)
  - [Virus](#)
  - [Fibonacci Numbers](#)
  - [Uniform Polyhedra](#)
  - [Chaos](#)
- 

## Science

- [Tesla](#)
  - [Alexander Bell](#)
  - [New & Alternate Theories of Physics](#)
  - [Fabulous Facts](#)
  - [Science Hobbyist](#)
  - [Sympathetic Vibratory Physics](#)
  - [The Institute for New Energy](#)
  - [Matter and Energy Visualization \(helix coil\)](#)
  - [Hydrosonic Power Generator](#)
- 

## **E-magazines**

- [WorldNet News \\*\\*\\*\\*](#)
  - [Wired Magazine](#)
  - [Y2K News](#)
- 

- [E-mail Author: Robert\\_Conroy@compuserve.com](mailto:Robert_Conroy@compuserve.com)
- [Return to home page](#)

# Fibonacci Numbers and Nature





This page has been split into TWO PARTS.

This, the **first**, looks at the Fibonacci numbers and why they appear in various "family trees" and patterns of spirals of leaves and seeds.

The second page then examines why the golden section is used by nature in some detail, including animations of growing plants.

## Contents of this Page

The  icon means there is a Things to do investigation at the end of the section.

- [Rabbits, Cows and Bees Family Trees](#)
  - [Fibonacci's Rabbits..](#)
  - [Dudeney's Cows](#)
  - [Honeybees and Family Trees](#) 
- [Fibonacci Numbers and the Golden Number](#) 
- [Fibonacci Rectangles and Shell Spirals](#)
- [Fibonacci numbers, the Golden Section and plants](#)
  - [Petals on flowers](#)
  - [Seed heads](#)
  - [Pine cones](#) 
  - [Leaf arrangements](#)
    - [Leaves per turn](#)
    - [Leaf arrangements of some common plants](#)
  - [Vegetables and Fruit](#) 
- [Fibonacci Fingers?](#)
- [A quote from Coxeter on Phyllotaxis](#)
- [Navigating through this site](#)
- [References and Links](#)

0, 1, 1, 2, 3, 5, 8, 13, 21, 34, 55, 89, 144, 233, 377, 610, 987 ..[More..](#) 

## Rabbits, Cows and Bees Family Trees

Let's look first at the Rabbit Puzzle that Fibonacci wrote about and then at two adaptations of it to make it more realistic. This introduces you to the Fibonacci Number series and the simple definition of the whole never-ending series.

### Fibonacci's Rabbits

The original problem that Fibonacci investigated (in the year 1202) was about how fast rabbits could breed in ideal circumstances.



Suppose a newly-born pair of rabbits, one male, one female, are put in a field. Rabbits are able to mate at the age of one month so that at the end of its second month a female can produce another pair of rabbits. Suppose that our rabbits **never die** and that the female **always** produces one new pair (one male, one



female) **every month** from the second month on. The puzzle that Fibonacci posed was...

How many pairs will there be in one year?

1. At the end of the first month, they mate, but there is still one only 1 pair.
2. At the end of the second month the female produces a new pair, so now there are 2 pairs of rabbits in the field.
3. At the end of the third month, the original female produces a second pair, making 3 pairs in all in the field.
4. At the end of the fourth month, the original female has produced yet another new pair, the female born two months ago produces her first pair also, making 5 pairs.

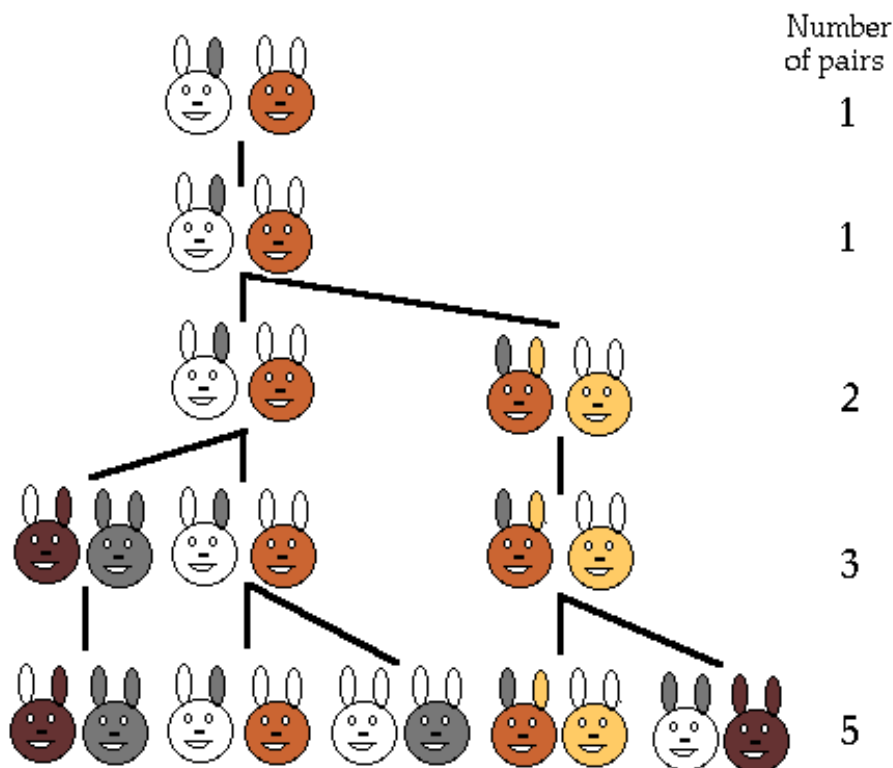

The number of pairs of rabbits in the field at the start of each month is 1, 1, 2, 3, 5, 8, 13, 21, 34, ...

Can you see how the series is formed and how it continues? If not, look at [the answer!](#)

The [first 300 Fibonacci numbers](#) are here and some questions for you to answer.

Now can you see **why** this is the answer to our Rabbits problem? If not, [here's why.](#)

Another view of the Rabbit's Family Tree:

### Family Tree of Rabbits

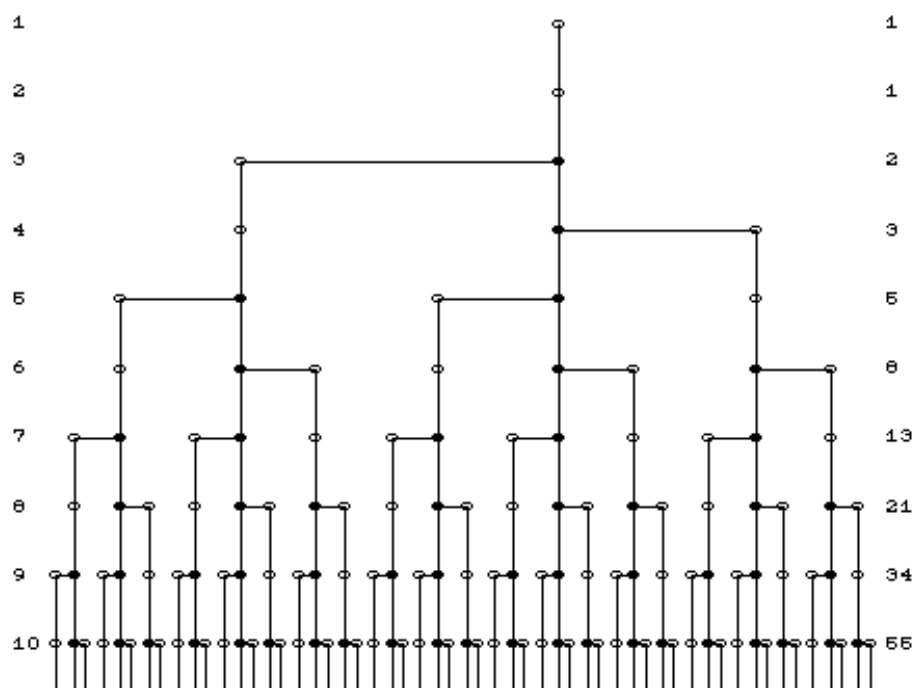

0, 1, 1, 2, 3, 5, 8, 13, 21, 34, 55, 89, 144, 233, 377, 610, 987 ..[More..](#) 

## The Rabbits problem is not very realistic, is it?

It seems to imply that brother and sisters mate, which, genetically, leads to problems. We can get round this by saying that the female of each pair mates with any male and produces another pair.

Another problem which again is not true to life, is that each birth is of exactly two rabbits, one male and one female.

## Dudeney's Cows

The English puzzlist, Henry E Dudeney (1857 - 1930, pronounced *Dude-knee*) wrote several excellent books of puzzles (see after this section). In one of them he adapts Fibonacci's Rabbits to cows, making the problem more realistic in the way we observed above. He gets round the problems by noticing that really, it is only the females that are interesting - er - I mean the *number of females!*

He changes months into years and rabbits into bulls (male) and cows (females) in problem 175 in his book **536 puzzles and Curious Problems** (1967, Souvenir press):

If a cow produces its first she-calf at age two years and after that produces another single she-calf every year, how many she-calves are there after 12 years, assuming none die?

This is a better simplification of the problem and quite realistic now.

But Fibonacci does what mathematicians often do at first, simplify the problem and see what happens - and the series bearing his name does have *lots* of other interesting and practical applications as we see later. So let's look at another real-life situation that is exactly modelled by Fibonacci's series - honeybees.



### Puzzle books by Henry E Dudeney

 [Amusements in Mathematics](#), Dover Press, 1958, 250 pages.

Still in print thanks to Dover in a very sturdy paperback format at an incredibly inexpensive price. This is a wonderful collection that I find I often dip into. There are arithmetic puzzles, geometric puzzles, chessboard puzzles, an excellent chapter on all kinds of mazes and solving them, magic squares, river crossing puzzles, and more, all with full solutions and often extra notes! Highly recommended!

 [536 Puzzles and Curious Problems](#) is now out of print, but you may be able to pick up a second hand version by clicking on

this link. It is another collection like *Amusements in Mathematics* (above) but containing different puzzles arranged in sections: Arithmetical and Algebraic puzzles, Geometrical puzzles, Combinatorial and Topological puzzles, Game puzzles, Domino puzzles, match puzzles and "unclassified" puzzles. Full solutions and index. A real treasure.

 [The Canterbury Puzzles](#), Dover 2002, 256 pages. More puzzles (not in the previous books) the first section with some characters from Chaucer's *Canterbury Tales* and other sections on the Monks of Riddellewell, the squire's Christmas party, the Professors puzzles and so on and all with full solutions of course!

## Honeybees and Family trees

There are over 30,000 species of bees and in most of them the bees live solitary lives. The one most of us know best is the honeybee and it, unusually, lives in a colony called a hive and they have an unusual Family Tree. In fact, there are many unusual features of honeybees and in this section we will show how the Fibonacci numbers count a honeybee's ancestors (in this section a "bee" will mean a "honeybee").

First, some unusual facts about honeybees such as: not all of them have two parents!



In a colony of honeybees there is one special female called the **queen**.



There are many **worker** bees who are female too but unlike the queen bee, they produce no eggs.



There are some **drone** bees who are male and do no work.

Males are produced by the queen's unfertilized eggs, so male bees only have a mother but no father!



All the females are produced when the queen has mated with a male and so have two parents. Females usually end up as worker bees but some are fed with a special substance called **royal jelly** which makes them grow into queens ready to go off to start a new colony when the bees form a **swarm** and leave their home (a **hive**) in search of a place to build a new nest.

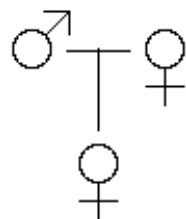

Queens have 2 parents



Males have 1 parent

So female bees have 2 parents, a male and a female whereas male bees have just one parent, a female.

Here we follow the convention of Family Trees that *parents appear above their children*, so the latest generations are at the bottom and the higher up we go, the older people are. Such trees show all the *ancestors* (predecessors, forebears, antecedents) of the person at the bottom of the diagram. We would get quite a different tree if we listed all the *descendants* (progeny, offspring) of a person as we did in the rabbit problem, where we showed all the descendants of the original pair.

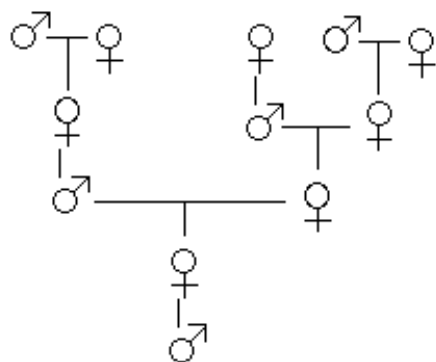

Let's look at the family tree of a male drone bee.

1. He had **1** parent, a female.
2. He has **2** grand-parents, since his mother had two parents, a male and a female.
3. He has **3** great-grand-parents: his grand-mother had two parents but his grand-father had only one.
4. How many great-great-grand parents did he have?

Again we see the [Fibonacci numbers](#) :

|                  | Number of parents: | grand-parents: | great-grand-parents: | great, great grand parents: | gt, gt, gt grand parents: |
|------------------|--------------------|----------------|----------------------|-----------------------------|---------------------------|
| of a MALE bee:   | 1                  | 2              | 3                    | 5                           | 8                         |
| of a FEMALE bee: | 2                  | 3              | 5                    | 8                           | 13                        |

 **The Fibonacci Sequence as it appears in Nature** by S.L.Basin in *Fibonacci Quarterly*, vol 1 (1963), pages 53 - 57.

0, 1, 1, 2, 3, 5, 8, 13, 21, 34, 55, 89, 144, 233, 377, 610, 987 ..[More..](#)



## Things to do

1. Make a diagram of your own family tree. Ask your parents and grandparents and older relatives as each will be able to tell you about particular parts of your family tree that other's didn't know. It can be quite fun trying to see how far back you can go. If you have them put old photographs of relatives on a big chart of your Tree (or use photocopies of the photographs if your relatives want to keep the originals). If you like, include the year and place of birth and death and also the dates of any marriages.
2. A brother or sister is the name for someone who has the same two parents as yourself. What is a *half-brother* and *half-sister*?  
Describe a *cousin* but use simpler words such as *brother*, *sister*, *parent*, *child*?  
Do the same for *nephew* and *niece*. What is a *second cousin*? What do we mean by a *brother-in-law*, *sister-in-law*, *mother-in-law*, *etc*? *Grand-* and *great-* refer to relatives *or your parents*. Thus a *grand-father* is a father of a parent of yours and *great-aunt* or *grand-aunt* is the name given to an aunt of your parent's.

Make a diagram of Family Tree Names so that "Me" is at the bottom and "Mum" and "Dad" are above you. Mark in "brother", "sister", "uncle", "nephew" and as many other names of (kinds of) relatives that you know. It doesn't matter if you have no brothers or sisters or nephews as the diagram is meant to show the relationships and their names.  
[If you have a friend who speaks a foreign language, ask them what words they use for these relationships.]

3. What is the name for *the wife of a parent's brother*?  
Do you use a different name for the sister of your parent's?  
In law these two are sometimes distinguished because one is a *blood relative* of yours and the other is not, just a relative through marriage.  
Which do you think is the *blood relative* and which the relation because of marriage?
4. How many parents does everyone have?  
So how many grand-parents will you have to make spaces for in your Family tree?  
Each of them also had two parents so how many great-grand-parents of yours will there be in your Tree?  
..and how many great-great-grandparents?  
What is the pattern in this series of numbers?  
If you go back one generation to your parents, and two to your grand-parents, how many entries will there be 5 generations ago in your Tree? and how many 10 generations ago?

The Family Tree of humans involves a different sequence to the Fibonacci Numbers. What is this sequence called?

5. 😊 Looking at your answers to the previous question, your friend Dee Duckshun says to you:
  - You have 2 parents.
  - They each have two parents, so that's 4 grand-parents you've got.
  - They also had two parents each making 8 great-grand-parents in total ...
  - ... and 16 great-great-grand-parents ...
  - ... and so on.
  - So the farther back you go in your Family Tree the more people there are.
  - It is the same for the Family Tree of *everyone* alive in the world today.
  - It shows that the farther back in time we go, the more people there must have been.
  - So it is a logical deduction that the population of the world *must* be getting smaller and smaller as time goes on!

Is there an error in Dee's argument? If so, what is it? Ask your maths teacher or a parent if you are not sure of the answer!

0, 1, 1, 2, 3, 5, 8, 13, 21, 34, 55, 89, 144, 233, 377, 610, 987 ..[More..](#)



# Fibonacci numbers and the Golden Number

If we take the ratio of two successive numbers in Fibonacci's series, (1, 1, 2, 3, 5, 8, 13, ..) and we divide each by the number before it, we will find the following series of numbers:

$$1/1 = 1, \quad 2/1 = 2, \quad 3/2 = 1.5, \quad 5/3 = 1.666\dots, \quad 8/5 = 1.6, \quad 13/8 = 1.625, \quad 21/13 = 1.61538\dots$$

It is easier to see what is happening if we plot the ratios on a graph:

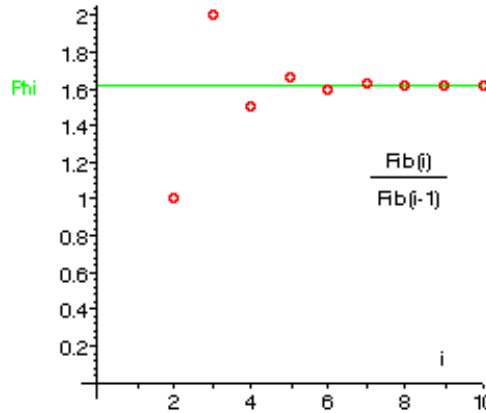

The ratio seems to be settling down to a particular value, which we call **the golden ratio** or **the golden number**. It has a value of approximately **1.618034**, although we shall find an even more accurate value on [a later page \[this link opens a new window\]](#).

## Things to do

- What happens if we take the ratios the other way round i.e. we divide each number by the one *following* it: 1/1, 1/2, 2/3, 3/5, 5/8, 8/13, ..?  
Use your calculator and perhaps plot a graph of these ratios and see if anything similar is happening compared with the graph above.  
You'll have spotted a fundamental property of this ratio when you find the limiting value of the new series!

0, 1, 1, 2, 3, 5, 8, 13, 21, 34, 55, 89, 144, 233, 377, 610, 987 ..[More..](#)

The **golden ratio** 1.618034 is also called the **golden section** or the **golden mean** or just the **golden number**. It is often represented by a greek letter **Phi**  $\Phi$ . The closely related value which we write as **phi** with a small "p" is just the decimal part of Phi, namely 0.618034.

## Fibonacci Rectangles and Shell Spirals

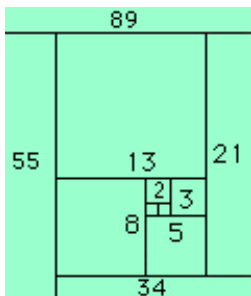

We can make another picture showing the Fibonacci numbers 1,1,2,3,5,8,13,21,.. if we start with two small squares of size 1 next to each other. On top of both of these draw a square of size 2 (=1+1).

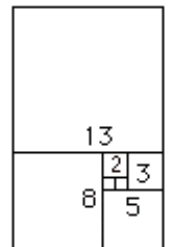

We can now draw a new square - touching both a unit square and the latest square of side 2 - so having sides 3 units long; and then another touching both the 2-square and the 3-square (which has sides of 5 units). We can continue adding squares around the picture, **each new square having a side which is as long as the sum of the latest two square's sides**. This set of rectangles whose sides are two successive Fibonacci numbers in length and which are composed of squares with sides which are Fibonacci numbers, we will call the **Fibonacci Rectangles**.

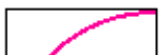

Here is a spiral drawn in the squares, a quarter of a circle in each square. The spiral is not a *true* mathematical



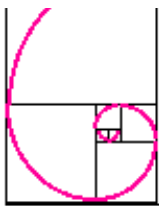

spiral (since it is made up of fragments which are parts of circles and does not go on getting smaller and smaller) but it is a good approximation to a kind of spiral that does appear often in nature. Such spirals are seen in the shape of shells of snails and sea shells and, as we see later, in the arrangement of seeds on flowering plants too. The spiral-in-the-squares makes a line from the centre of the spiral increase by a factor of the golden number in each square. So points on the spiral are 1.618 times as far from the centre after a quarter-turn. In a whole turn the points on a radius out from the center are  $1.618^4 = 6.854$  times further out than when the curve last crossed the same radial line.

Here is a cross-section of a Nautilus sea shell. It shows the spiral curve of the shell and the internal chambers that the animal using it adds on as it grows. The chambers provide boyancy in the water. Click on the picture to enlarge it in a new window. Draw a line from the center out in any direction and find two places where the shell crosses it so that the shell spiral has gone round just once between them. The outer crossing point will be 1.618 times as far from the centre showing that the shell has grown by a factor of the golden ratio in one turn.

Nautilus  
[Buy This Art Print At AllPosters.com](http://AllPosters.com)



Here are some more images for you to measure. They are all of poster available from AllPosters.com if you wanted one for your study wall or classroom or to go with a science project. Click on the pictures to enlarge them in a new window.



Sliced Nautilus Shell  
[Buy This Art Print At AllPosters.com](http://AllPosters.com)



Nautilus Shell  
[Buy This Art Print At AllPosters.com](http://AllPosters.com)



Nautilus  
[Buy This Art Print At AllPosters.com](http://AllPosters.com)

The curve of this shell is called [Equiangular](#) or [Logarithmic spirals](#) and are common in nature, though the 'growth factor' may not always be the golden ratio.

## Reference

 [The Curves of Life](#) Theodore A Cook, Dover books, 1979, ISBN 0 486 23701 X.  
A Dover reprint of a classic 1914 book.

0, 1, 1, 2, 3, 5, 8, 13, 21, 34, 55, 89, 144, 233, 377, 610, 987 ..[More..](#) 

# Fibonacci Numbers, the Golden Section and Plants

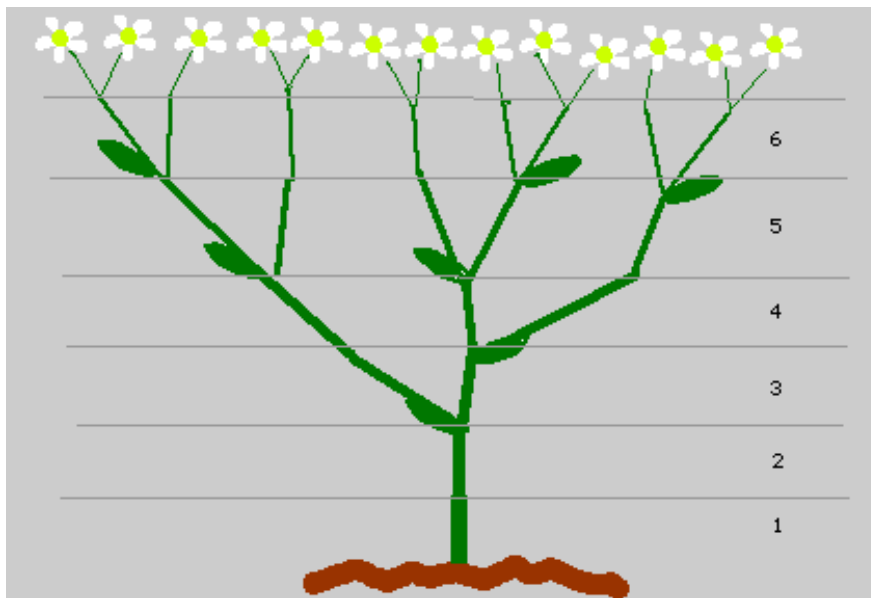

One plant in particular shows the Fibonacci numbers in the number of "growing points" that it has. Suppose that when a plant puts out a new shoot, that shoot has to grow two months before it is strong enough to support branching. If it branches every month after that at the growing point, we get the picture shown here.

A plant that grows very much like this is the "sneezewort": *Achillea ptarmica*.

0, 1, 1, 2, 3, 5, 8, 13, 21, 34, 55, 89, 144, 233, 377, 610, 987 ..[More..](#)



## Petals on flowers

On many plants, the number of petals is a Fibonacci number:

buttercups have 5 petals; lilies and iris have 3 petals; some delphiniums have 8; corn marigolds have 13 petals; some asters have 21 whereas daisies can be found with 34, 55 or even 89 petals.

The links here are to various flower and plant catalogues:

- the Dutch [Flowerweb](#)'s searchable index called [Flowerbase](#).
- The US Department of Agriculture's [Plants Database](#) containing over 1000 images, plant information and searchable database.

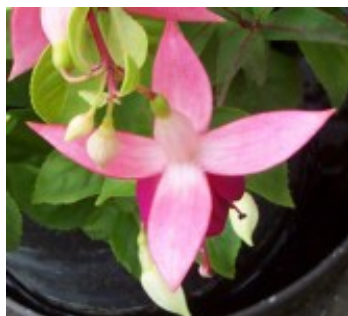

Fuchsia



Pinks



Lily



Daisies  
[available as a poster at AllPosters.com](#)

### 3 petals: lily, iris

Often lilies have 6 petals formed from two sets of 3 as shown above:

**4 petals** Very few plants show 4 petals (or sepals) but some, such as the fuchsia above, do. 4 is *not* a Fibonacci number! We return to this point near the bottom of this page.

**5 petals:** buttercup, wild rose, larkspur, columbine (aquilegia), pinks (shown above)

The humble buttercup has been bred into a multi-petalled form.

**8 petals:** delphiniums

**13 petals:** ragwort, corn marigold, cineraria, some daisies

**21 petals:** aster, black-eyed susan, chicory

**34 petals:** plantain, pyrethrum

**55, 89 petals:** michaelmas daisies, the asteraceae family.

Some species are very precise about the number of petals they have - eg buttercups, but others have petals that are very near those above, with the average being a Fibonacci number.

Here is a passion flower (*passiflora incarnata*) from the back and front:



Back view:  
the 3 sepals that protected the bud are outermost, then 5 outer green petals followed by an inner layer of 5 more paler green petals



Front view:  
the two sets of 5 green petals are outermost, with an array of purple-and-white stamens (how many?); in the centre are 5 greenish stamens (T-shaped) and uppermost in the centre are 3 deep brown carpels and style branches)

0, 1, 1, 2, 3, 5, 8, 13, 21, 34, 55, 89, 144, 233, 377, 610, 987 ..[More..](#)



## Seed heads



This poppy seed head has 13 ridges on top.

Fibonacci numbers can also be seen in the arrangement of seeds on flower heads. The picture here is Tim Stone's beautiful photograph of a Coneflower, used here by kind permission of Tim. The part of the flower in the picture is about 2 cm across.

It is a member of the daisy family with the scientific name [Echinacea purpurea](#) and native to the Illinois prairie where he lives.

You can have a look at some more of Tim's wonderful [photographs on the web](#).



You can see that the orange "petals" seem to form spirals curving both to the left and to the right. At the edge of the picture, if you count those spiralling to the right as you go outwards, there are 55 spirals. A little further towards the centre and you can count 34 spirals. How many spirals go the other way at these places? You will see that the pair of numbers (counting spirals in curving left and curving right) are neighbours in the Fibonacci series. Click on the picture on the right to see it in more detail in a separate window.



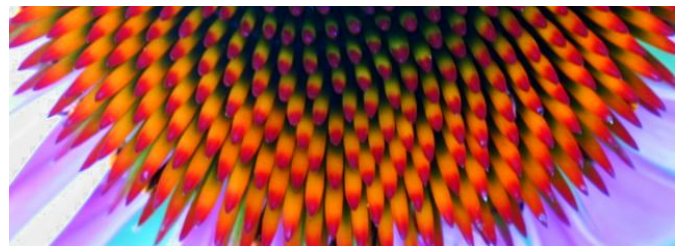

Here are some more wonderful pictures from All Posters (which you can buy for your classroom or wall at home). Click on each to enlarge it in a new window.



Sunflower  
[Buy This Art Print At AllPosters.com](#)

Sunflower  
[Buy This Poster At AllPosters.com](#)

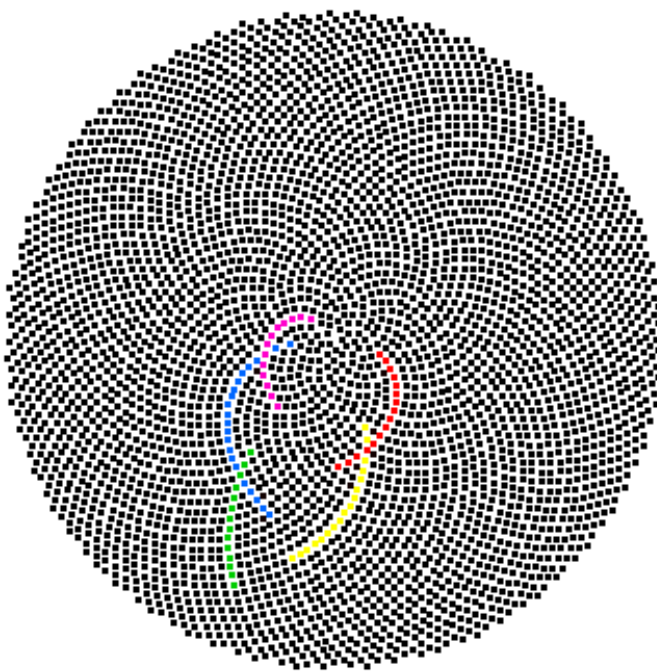

The same happens in many seed and flower heads in nature. The reason seems to be that this arrangement forms an **optimal packing** of the seeds so that, no matter how large the seed head, they are uniformly packed at any stage, all the seeds being the same size, no crowding in the centre and not too sparse at the edges.

The spirals are patterns that the eye sees, "curvier" spirals appearing near the centre, flatter spirals (and more of them) appearing the farther out we go.

*So the number of spirals we see, in either direction, is different for larger flower heads than for small. On a large flower head, we see more spirals further out than we do near the centre. The numbers of spirals in each direction are (almost always) neighbouring Fibonacci numbers!* Click on these links for some more diagrams of [500](#), [1000](#) and [5000](#) seeds.

Click on the image on the right for a Quicktime animation of 120 seeds appearing from a single central growing point. Each new seed is just phi (0.618) of a turn from the last one (or, equivalently, there are Phi (1.618) seeds per turn). The animation shows that, no matter how big the seed head gets, the seeds are always equally spaced. At all stages the Fibonacci Spirals can be seen.

The same pattern shown by these dots (seeds) is followed if the dots then develop into leaves or branches or petals. Each dot only moves out directly from the central stem in a straight line.

This process models what happens in nature when the "growing tip" produces seeds in a spiral fashion. The only active area is the growing tip - the seeds only get bigger once they have appeared.

[This animation was produced by Maple. If there are N seeds in one frame, then the newest seed appears nearest the central dot, at 0.618 of a turn from the angle at which the last appeared. A seed which is i frames "old" still keeps its original angle from the exact centre but will have moved out to a distance which is the square-root of i.]

Note that you will not *always* find the Fibonacci numbers in the number of petals or spirals on seed heads etc., although they often come close to the Fibonacci numbers.

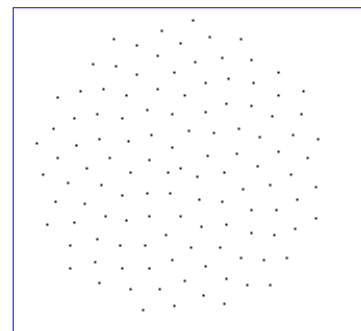

0, 1, 1, 2, 3, 5, 8, 13, 21, 34, 55, 89, 144, 233, 377, 610, 987 ..[More..](#)

## Pine cones



Pine cones show the Fibonacci Spirals clearly. Here is a picture of an ordinary pinecone seen from its base where the stalk connects it to the tree.

Can you see the two sets of spirals?  
How many are there in each set?

Use these buttons to check your answer (the lines are drawn connecting the centres of each segment of the pinecone):

Here is another pine cone. It is not only smaller, but has a different spiral arrangement.  
Use the buttons to help count the number of spirals in each direction] on this pinecone.

- Show only the pinecone
- Show the segment edges
- Show the outline only
- Show one set of spiral
- Show the other set of spirals



### Things to do

1. Collect some pine cones for yourself and count the spirals in both directions.  
*A tip:* Soak the cones in water so that they close up to make counting the spirals easier. Are all the cones identical in that the steep spiral (the one with most spiral arms) goes in the same direction?
2. What about a **pineapple**? Can you spot the same spiral pattern? How many spirals are there in each direction?

## Links and References

 Ohio State University Professor [Susan Goldstine](#)

has a page with really good [pinecone pictures](#) showing the actual order of the open "petals" of the cone numbered down the cone.

 **Fibonacci Statistics in Conifers** A Brousseau , *The Fibonacci Quarterly* vol 7 (1969) pages 525 - 532

You will occasionally find pine cones that do not have a Fibonacci number of spirals in one or both directions. Sometimes this is due to deformities produced by disease or pests but sometimes the cones look normal too. This article reports on a study of this question and others in a large collection of Californian pine cones of different kinds. The author also found that there were as many with the steep spiral (the one with more arms) going to the left as to the right.



**Pineapples and Fibonacci Numbers** P B Onderdonk *The Fibonacci Quarterly* vol 8 (1970), pages 507, 508.

0, 1, 1, 2, 3, 5, 8, 13, 21, 34, 55, 89, 144, 233, 377, 610, 987 ..[More..](#) 

## Leaf arrangements

Also, many plants show the Fibonacci numbers in the arrangements of the leaves around their stems. If we look down on a plant, the leaves are often arranged so that leaves above do not hide leaves below. This means that each gets a good share of the sunlight and catches the most rain to channel down to the roots as it runs down the leaf to the stem.

Here's [a computer-generated image](#), based on an African violet type of plant, whereas [this](#) has lots of leaves.

### Leaves per turn

The Fibonacci numbers occur when counting both the number of times we go around the stem, going from leaf to leaf, as well as counting the leaves we meet until we encounter a leaf directly above the starting one.

If we count in the other direction, we get a different number of turns for the same number of leaves.

The number of turns in each direction and the number of leaves met are **three consecutive Fibonacci numbers!**

For example, in the top plant in the picture above, we have **3** clockwise rotations before we meet a leaf directly above the first, passing **5** leaves on the way. If we go anti-clockwise, we need only **2** turns. Notice that 2, 3 and 5 are consecutive Fibonacci numbers.

For the lower plant in the picture, we have **5** clockwise rotations passing **8** leaves, or just **3** rotations in the anti-clockwise direction. This time 3, 5 and 8 are consecutive numbers in the Fibonacci sequence.

We can write this as, for the top plant, **3/5 clockwise rotations per leaf** ( or 2/5 for the anticlockwise direction). For the second plant it is **5/8 of a turn per leaf** (or 3/8).



The sunflower here when viewed from the top shows the same pattern. It is the same plant whose side view is above. Starting at the leaf marked "X", we find the next lower leaf turning clockwise. Numbering the leaves produces the patterns shown.



You will see that the third leaf and fifth leaves are next nearest below our starting leaf but the next nearest below it is the 8th then the 13th. How many turns did it take to reach each leaf?

| Leaf number | turns clockwise |
|-------------|-----------------|
| 3           | 1               |
| 5           | 2               |
| 8           | 3               |

The pattern continues with Fibonacci numbers in each column!

## Leaf arrangements of some common plants

One estimate is that 90 percent of all plants exhibit this pattern of leaves involving the Fibonacci numbers.

Some common trees with their Fibonacci leaf arrangement numbers are:

- 1/2 elm, linden, lime, grasses
- 1/3 beech, hazel, grasses, blackberry
- 2/5 oak, cherry, apple, holly, plum, common groundsel
- 3/8 poplar, rose, pear, willow
- 5/13 pussy willow, almond

where  $t/n$  means each leaf is  $t/n$  of a turn after the last leaf or that there is there are  $t$  turns for  $n$  leaves.

Cactus's spines often show the same spirals as we have already seen on pine cones, petals and leaf arrangements, but they are much more clearly visible. Charles Dills has noted that the Fibonacci numbers occur in Bromeliads and his [Home page](#) has links to lots of pictures.

0, 1, 1, 2, 3, 5, 8, 13, 21, 34, 55, 89, 144, 233, 377, 610, 987 ..[More..](#) 

## Vegetables and Fruit

Here is a picture of an ordinary cauliflower. Note how it is almost a pentagon in outline. Looking carefully, you can see a centre point, where the florets are smallest. Look again, and you will see the florets are organized in spirals around this centre in both directions.

How many spirals are there in each direction?

These buttons will show the spirals more clearly for you to count (lines are drawn between the florets):





Here are some investigations to discover the Fibonacci numbers for yourself in vegetables and fruit.

### Things to do

1. Take a look at a **cauliflower** next time you're preparing one:

. First look at it:

- Count the number of florets in the spirals on your cauliflower. The number in one direction and in the other will be Fibonacci numbers, as we've seen here. Do you get the same numbers as in the picture?
- Take a closer look at a **single floret** (break one off near the base of your cauliflower). It is a mini cauliflower with its own little florets all arranged in spirals around a centre. If you can, count the spirals in both directions. How many are there?

b. Then, when cutting off the florets, try this:

- start at the bottom and take off the largest floret, cutting it off parallel to the main "stem".
- Find the next on up the stem. It'll be about 0.618 of a turn round (in one direction). Cut it off in the same way.
- Repeat, as far as you like and..
- Now look at the stem. Where the florets are rather like a pinecone or pineapple. The florets were arranged in spirals up the stem. Counting them again shows the Fibonacci numbers.

2. Try the same thing for **broccoli**.

3. **Chinese leaves** and **lettuce** are similar but there is no proper stem for the leaves. Instead, carefully take off the leaves, from the outermost first, noticing that they overlap and there is usually only one that is the outermost each time. You should be able to find some Fibonacci number connections.



4. Look for the Fibonacci numbers in fruit.

- . What about a **banana**? Count how many "flat" surfaces it is made from - is it 3 or perhaps 5? When you've peeled it, cut it in half (as if breaking it in half, not lengthwise) and look again. Surprise! There's a Fibonacci number.
- b. What about an **apple**? Instead of cutting it from the stalk to the opposite end (where the flower was), ie from "North pole" to "South pole", try cutting it along the "Equator". Surprise! there's your Fibonacci number!
- c. Try a Sharon fruit.
- d. Where else can you find the Fibonacci numbers in fruit and vegetables? Why not email me with your results and the best ones will be put on the Web here (or linked to your own web page).



0, 1, 1, 2, 3, 5, 8, 13, 21, 34, 55, 89, 144, 233, 377, 610, 987 ..[More..](#)



## Fibonacci Fingers?

Look at your own hand:

You have ...

- 2 hands each of which has ...
- 5 fingers, each of which has ...
- 3 parts separated by ...
- 2 knuckles

Is this just a coincidence or not?????

However, if you measure the lengths of the bones in your finger (best seen by slightly bending the finger) does it look as if the ratio of the longest bone in a finger to the middle bone is Phi?

What about the ratio of the middle bone to the shortest bone (at the end of the finger) - Phi again?

Can you find any ratios in the lengths of the fingers that looks like Phi? ---or does it look as if it could be any other similar ratio also?

Why not measure your friends' hands and gather some statistics?

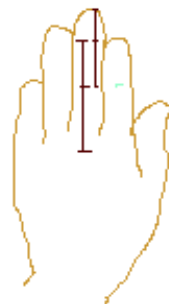

0, 1, 1, 2, 3, 5, 8, 13, 21, 34, 55, 89, 144, 233, 377, 610, 987 ..[More..](#)



## A quote from Coxeter on Phyllotaxis

Finally, note that, although the Fibonacci numbers and golden section seem to appear in many situations in nature, they are not the only such numbers. H S M Coxeter, in his **Introduction to Geometry** (1961, Wiley, page 172) - see the references at the foot of this page - has the following important quote:

*it should be frankly admitted that in some plants the numbers do not belong to the sequence of f's [Fibonacci numbers] but to the sequence of g's [Lucas numbers] or even to the still more anomalous sequences*

*3,1,4,5,9,... or 5,2,7,9,16,...*

*Thus we must face the fact that phyllotaxis is really not a universal law but only a fascinatingly prevalent tendency.*

He cites A H Church's **The relation of phyllotaxis to mechanical laws**, Williams and Norgate, London, 1904, plates XXV and IX as examples of the Lucas and the latter two sequences and plates V, VII, XIII and VI as examples of the Fibonacci numbers on sunflowers.

## Navigating through this Fibonacci and Phi site

The [Lucas numbers](#) are formed in the same way as the Fibonacci numbers - by adding the latest two to get the next, but instead of starting at 0 and 1 [Fibonacci numbers] the Lucas number series starts with 2 and 1. The other two sequences Coxeter mentions above have other pairs of starting values but then proceed with the exactly the same rule as the Fibonacci numbers. These series are the [General Fibonacci series](#).

An interesting fact is that for *all* series that are formed from adding the latest two numbers to get the next starting from *any* two values (bigger than zero), the ratio of successive terms will *always* tend to Phi!

So Phi (1.618...) and her sister phi (0.618...) are constants common to all varieties of Fibonacci series and they have lots of [interesting properties](#) of their own too. The links above will take you to further pages on this site for you to explore. You can also just follow the links below in the **Where To next?** section at the bottom on each page and this will go through the pages in order. Or you can browse through the pages that take your interest from the complete collection and brief descriptions on [the home page](#). There are pages on [Who was Fibonacci?](#), the golden section (phi) in [the arts: architecture, music, pictures etc](#) as well as two pages of [puzzles](#).

0, 1, 1, 2, 3, 5, 8, 13, 21, 34, 55, 89, 144, 233, 377, 610, 987 ..[More..](#)

## References and Links

### Key

 means the reference is to a book (and any link will take you to more information about the book and an on-line site from which you can purchase it);

 means the reference is to an article in a magazine or a paper in a scientific periodical.

 indicates a link to another web site.

Excellent books which cover similar material to that which you have found on this page are produced by Trudi Garland and Mark Wahl:

 [Mathematical Mystery Tour](#) by Mark Wahl, 1989, is full of many mathematical investigations, illustrations, diagrams, tricks, facts, notes as well as guides for teachers using the material. It is a great resource for your own investigations.

Books by Trudi Garland:

 [Fascinating Fibonacci](#) by Trudi Hammel Garland.

This is a really excellent book - suitable for all, and especially good for teachers seeking more material to use in class.

Trudy is a teacher in California and has some [more information on her book](#). (You can even [Buy it online now!](#))

She also has published [several posters](#), including one on [the golden section](#) suitable for a classroom or your study room wall.

You should also look at her other Fibonacci book too:

 [Fibonacci Fun: Fascinating Activities with Intriguing Numbers](#) Trudi Hammel Garland - a book for teachers.

 **Sex ratio and sex allocation in sweat bees (Hymenoptera: Halictidae)** D Yanega, in *Journal of Kansas Entomology Society*, volume 69 Supplement, 1966, pages 98-115.

Because of the imbalance in the family tree of honeybees, the ratio of male honeybees to females is not 1-to-1. This was noticed by Doug Yanega of the Entomology Research Museum at the University of California. In the article above, he correctly deduced that the number of females to males in the honeybee community will be around the golden-ratio  $\Phi = 1.618033\dots$

 **On the Trail of the California Pine**, Brother Alfred Brousseau, *Fibonacci Quarterly*, vol 6, 1968, pages 69 - 76; on the authors summer expedition to collect examples of all the pines in California and count the number of spirals in both directions, all of which were neighbouring Fibonacci numbers.

 **Why Fibonacci Sequence for Palm Leaf Spirals?** in *The Fibonacci Quarterly* vol 9 (1971), pages 227 - 244.

 **Fibonacci System in Aroids** in *The Fibonacci Quarterly* vol 9 (1971), pages 253 - 263. The Aroids are a family of plants that include the Dieffenbachias, Monsteras and Philodendrons.

## WWW links on Phyllotaxis, the Fibonacci Numbers and Nature

 [Phyllotaxis - An interactive site for the mathematical study of plant pattern formation](#) by Pau Atela or Chris Golé of the Mathematics Dept at Smith College, Massachusetts.

is an excellent site, beautifully designed with lots of pictures and buttons to push for an interactive learning experience! A **must-see** site!

 [Alan Turing](#)

one of the Fathers of modern computing (who lived here in Guildford during his early school years) was interested in many aspects of computers and Artificial Intelligence (AI) well before the electronic stored-program computer was developed enough to materialize some of his ideas. One of his interests (see his [Collected Works](#)) was [Morphogenesis](#), the study of the growing shapes of animals and plants.

 The book [Alan Turing: The Enigma](#) by Andrew Hodges is an enjoyable and readable account of his life and work on computing as well as his contributions to solving the German war-time code which used a machine called "Enigma". Unfortunately this book is now out of print, but click on the book-title link and Amazon.com will see if they can find a copy for you with no obligation.

✦ [The most irrational number](#)

One of the American Maths Society (AMS) web site's **What's New in Mathematics** regular monthly columns. This one is on the Golden Section and Fibonacci Spirals in plants.

✦ [Phyllotaxis](#)

An interactive site for the mathematical study of plant pattern formation for university biology students at Smith College. Has a useful gallery of pictures showing the Fibonacci spirals in various plants.

 [the Fibonacci Home Page](#)

There are no earlier topics - this is the first.

This is the first page on this Topic.

Where to now?

The next page on this topic is ...

 [The golden section in nature](#)

The next Topic is...

 [The Puzzling World of Fibonacci Numbers](#)



## Book Review Page

(updated 6/4/99)

---

Title: "Critical Mass"

Author: Steve Martini

A fictional story which combines an amoral White House which is for sale, and a former Soviet Union which can no longer safe guard its nuclear arsenal.

---

Title: "MoonWar"

Author: Ben BovaComments:

A science fiction novel which combines the situation of a moon colony which exist by means of the utilization of nanotechnology along with a runaway UN bid for a New World Order centered on UN leadership.

An interesting insight into the aspirations of some for the use of nanotechnology, along with the obvious present day pattern with regards to the UN's over reach of force.\*\*

---

Title: "The Eleventh Plaque"

Author: John Marr

Comments: A fiction portraying the 21st centuries new drug resistant diseases, along with elements of bioterrorism. Gives a very good insight into the new problems everyone faces because of past over use of drugs.\*\*

---

Title: "Dust"

Author: Charles Pellegrino

Comments: A scientific based self fullfilling fictional prophecy of how the earth reacts to varying stimuli and the ensuing consequences of those reactions on the life forms there on. A very good read.\*\*\*\*

---

Title: "Warrior"

Author: Peter Hatthaway Capstick

Comments: A historical narrative about the life of Colonel Richard Meinertzhagen, an English soldier and figure in the shaping of Africa and the Middle East. \*\*\*

---

Title: "The Eagles Brood"

Author: Jack Whyte

Comments: A historical novel of the British Isles during the period of Roman withdrawal in which the main characters revolve around Merlin and his family. \*\*\*\*

---

Title: "The Dead Sea Scrolls Uncovered"

Author: Robert Eisenman and Michael Wise

Comments: Not only an excellent translation of the documents but a book which gives plenty of background into why the documents were

withheld for 35 years along with a good historical perspective into not only who the authors of the scrolls were but a good perspective into the content. \*\*\*

---

Title: "Square Foot Gardening"

Author: Mel Bartholomew

A gardening book which shows how to get more produce from less space and less work. Required reading for people who want the most output from the least input.

- [Return to Cover Page](#)

I am a  seeking   
Love@AOL Get started today >>

## Plans & Instructional Videos

### Fabrication Plans



The fabrication book for the original [24' Diameter Dome](#) cost \$48. For the updated fabrication version, the price is \$100 (video included). The fabrication booklet for [24' 2nd floor](#) is \$80. The cost for the stress computation is \$25.

Postage & handling is \$5.00

Package deal consisting of updated 24' diameter fabrication book, 24' 2nd floor fabrication book, stress computations, & CD videos, plus postage is \$200. Regular price is \$250.



The cost of the fabrication book for the [32' diameter dome](#) is \$120.

The cost of the fabrication booklet for the [2nd floor](#) is \$80. The cost for the stress computations is \$30. Postage and handling is \$5.00

Package deal for 32' diameter dome fabrication booklet, plus 2nd floor fabrication book, plus stress computations, together with instructional videos and postage is \$225. Regular price is \$275.



The cost of the fabrication book for this 14' dome is \$40 plus \$5.00 postage and handling. This size dome was designed to be built from the scrap material left over in the construction of the larger sized domes.



The fabrication book for the [2/5 38' diameter dome](#) is \$350.00. It is half price to non profit organizations. Postage and handling is \$10.00.

Includes cutting charts for basic dome, knee walls, and awnings along with stress calculations. Also included are step by step photos of fabrication and erection.

## Instructional CD Video

CD videos, in mpg format, are also available for the revised fabrication of panels, the erection of 24' and 32' dome, and the installation of the alternate flared pier system, for \$20.00/each plus \$5.00 postage and handling.

For plans or video, please indicate which plans are sought and then send check or money order to:

**Mountain Truss Corporation**

**312 East 79th Street**

**Kansas City, Missouri 64114**

posted 3/15/00 rlc  
copyright 2000 Robert Conroy  
revised 9/10/03



[Return to home page](#)

page created with [Easy Designer](#)

## Dome Kits



**14' Diameter Dome**

Kit for 14' diameter dome includes connecting wedges, drilled and cut dome boards, cut and drilled kneewall boards, along with patterns for cutting sheathing. The kit cost \$1490 FOB Kansas City, Missouri. Display kit on sale for \$990.00.



**24' Diameter Dome**

Kit for 24' diameter dome includes, fabrication booklet, connecting wedges, drilled and cut dome boards, cut and drilled kneewall boards, along with patterns for cutting sheathing. The kit cost \$3300.00 FOB Kasas City, Missouri. The kit cost without type II panel kneewall is \$2900. Display kit on sale for \$1900.00



**32' Diameter Dome**

Kit for 32' diameter dome includes, fabrication booklet, connecting wedges, drilled and cut dome boards, cut and drilled kneewall boards, along with patterns for cutting sheathing. The kit cost \$4500.00 FOB Kasas City, Missouri. The kit cost without type II panel kneewall is \$4000. Display kit on sale for \$3000.00



**38' Diameter 2/5 Dome**

Kit for 38' diameter 2/5 dome includes, fabrication booklet, connecting wedges, drilled and cut dome boards, along with patterns for cutting sheathing. The kit cost \$7000.00\* FOB Kasas City, Missouri. \*Comes without knee wall or awnings, plans only for both.

e-mail: [roconroy@aol.com](mailto:roconroy@aol.com)

return to [home page](#)

copyright 2002 Conroy  
4/7/02 rlc  
revised 10/9/02





page created with [Easy Designer](#)

|                                |                                |
|--------------------------------|--------------------------------|
| I am a                         | seeking                        |
| <input type="text" value="M"/> | <input type="text" value="W"/> |
| Love@AOL                       |                                |
| Get started today >>           |                                |

## Business Opportunity & Training

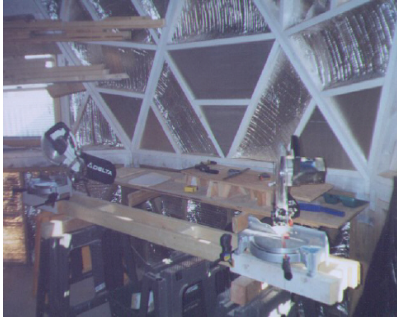

### Dome Manufacturing Franchise

Help set up fabrication plant & hold fabrication class for basic dome \$2000

Assemblage Class for basic dome \$2000

Pier & Kneewall Class \$1000

2nd floor fabrication & installation class \$2000

(plus cost which includes transportation and lodging)

Any special training is \$400/day

Franchise fee is 10% of Gross Sale Price

Pricing of Dome kits for a well set up simple plant with well trained fabricators is set up to return \$60/hour gross income

Good opportunity for self motivated home based business plus a means to provide family with well constructed home



One day training class for 14' diameter dome at Missouri location. \$160 per learning pair, generally a husband and wife team. Reservation required. Includes set of 14' fabrication plans.

copyright 2002 Conroy  
posted 4/7/02 rlc  
revised 10/11/02

e-mail: [roconroy@aol.com](mailto:roconroy@aol.com)



page created with [Easy Designer](#)

## Training Class schedule

(Demonstration of techniques in fabricating a "24' Mountain Truss")

---



### 24' Training Center

---

#### Cost

The cost for the 1 day demonstration training class will be \$150. A license agreement will have to be signed to receive plans and attend the classes. Class size will be limited, therefore please make early reservations. If these training times are inconvenient please let me know by e-mail. If you wish for longer-hands-on classes please leave comments. Students will be asked to provide their own eye, ear and dust protectors. (these classes have been temporarily put on hold)

---

#### Schedule

Training is currently only available through the "Business Opportunity" WEB page. This may change in the future. For further inquiries e-mail me at : [Robert\\_Conroy@compuserve.com](mailto:Robert_Conroy@compuserve.com)

- [Robert\\_Conroy@compuserve.com](mailto:Robert_Conroy@compuserve.com)
- [Order form for plans](#)
- [license agreement](#)
- [Business Opportunity](#)
- [Return to 24' Dome page](#)
- [Return to cover page](#)

**www.klatu.com/philix**  
**is now**  
**[www.klatu.com/lix](http://www.klatu.com/lix)**









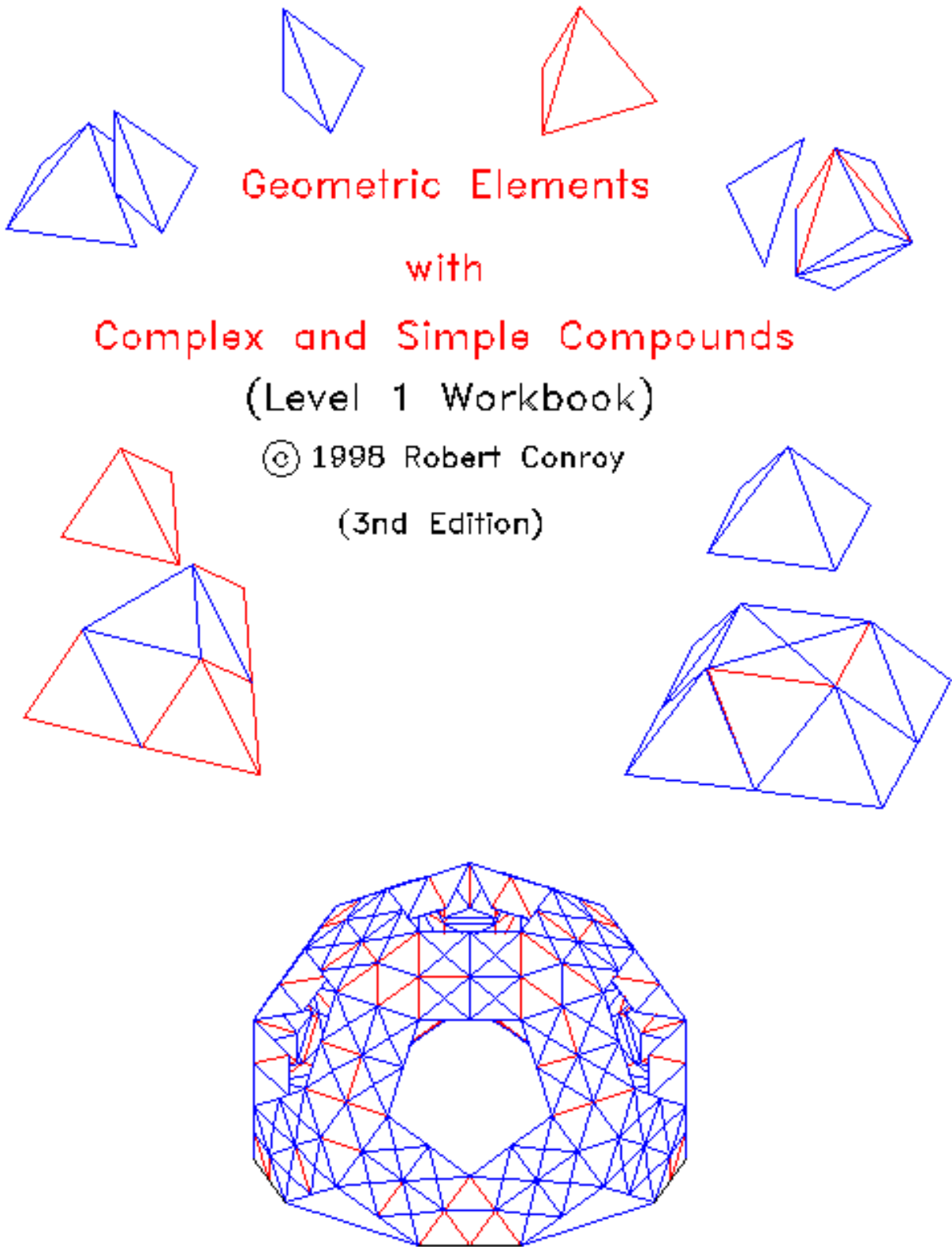

# Geometric Elements

with

## Complex and Simple Compounds

(Level 1 Workbook)

© 1998 Robert Conroy

(3rd Edition)

# Introduction

1. Why are salt grains in the shape of a cube?
2. Why is the common cold virus in the shape of a icosahedron?
3. Why do diamonds break along certain planes?
4. Why does a snowflake crystallize in hexagonal shapes?
5. Why does a star fish have five arms?

The purpose of this book is to familiarize the student with the geometric elements in order for him or her to be able to later answer these questions, and also to give glory to YHWH who created this wonder.

## Instructions

Tools needed for construction of elements and compounds:

1. scotch tape
2. straight edge
3. good scissors

Steps in construction of elements:

1. Carefully cut out shapes from cut-out pages with a good scissors.
2. Carefully fold cut-out shapes with the help of a straight edge along connecting lines.
3. Scotch tape figures together into forms represented by diagrams.

### Individual Project

Combine the tetrahedron element with 4 octahedron elements to form a cube. Construct the other Platonic solids which are contained within this workbook.

### Class Room Projects

a. Combine tetrahedron elements and half octahedron compounds into double tetrahedrons and double octahedrons as shown on the cover of this workbook.

b. If the class is large enough, try combining the double tetrahedrons and double octahedrons, into the Tri-Pent-Rect Geodesic shown on the cover of this workbook. Geodesic Connector elements are required in order to facilitate the combining of the double oct-tet compounds into a geodesic.

## Printing and Shareware Instructions

1) Teacher should make copies of the workbook on heavy paper or cardstock. In some cases, colored paper might be appropriate. Printer set to "fit aspects".

2) This is a shareware workbook. If teachers or individual students, in individual settings, find the workbook 100% satisfactory, then they are asked to remit a fee. The over all fee for a classroom is \$8.00/class. For independent students, the fee is \$1.00. The classroom fee covers as many copies as necessary for that particular class.

Remit fee to:

Robert Conroy  
312 East 79th Street  
Kansas City, MO 64114

3) The text portion of the workbook is an **interactive WEB page**:  
[http://go.ourworld.nu/robert\\_conroy/](http://go.ourworld.nu/robert_conroy/)

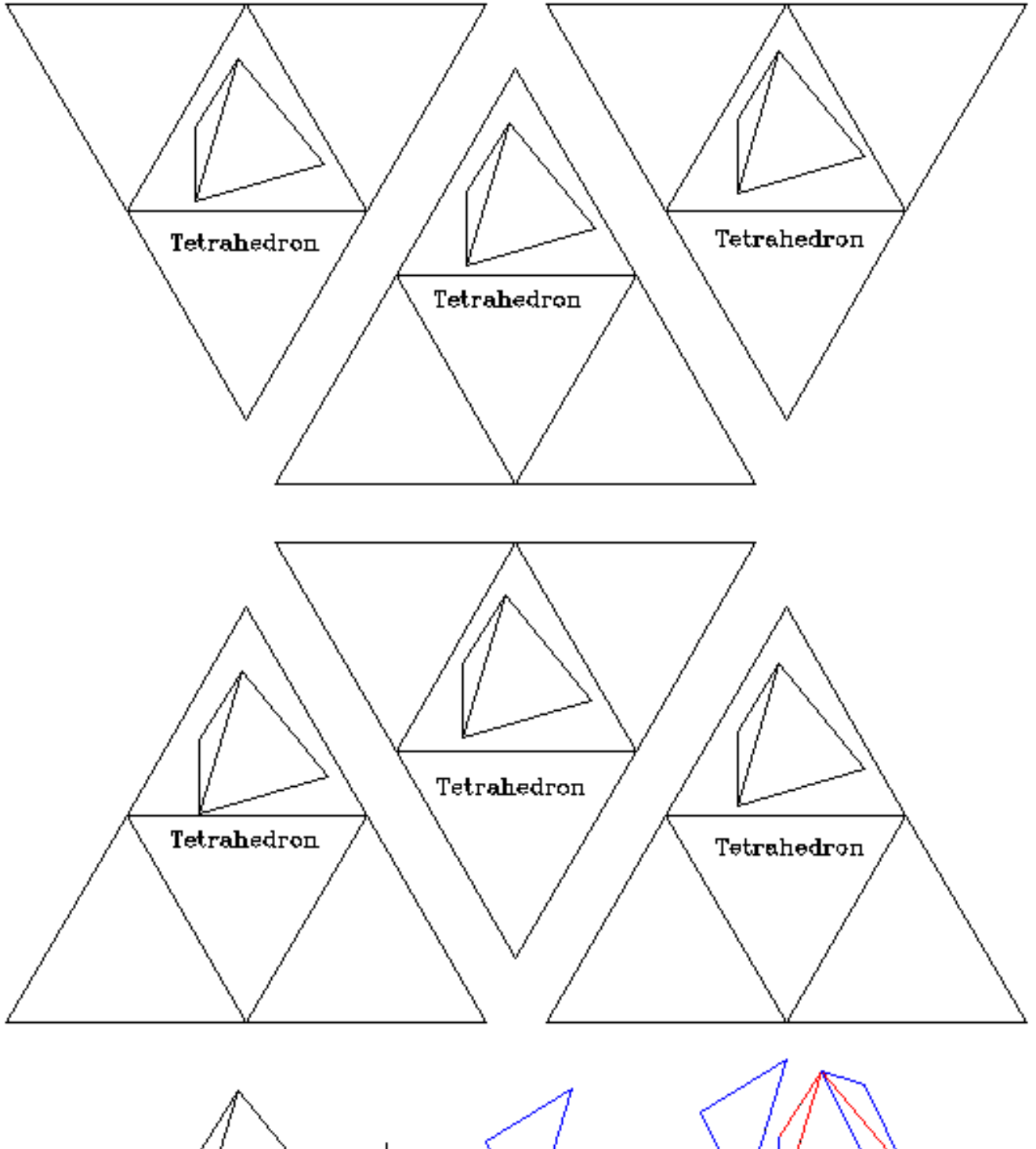

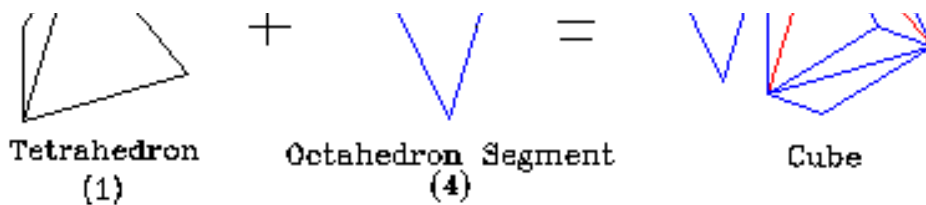

# Tetrahedron

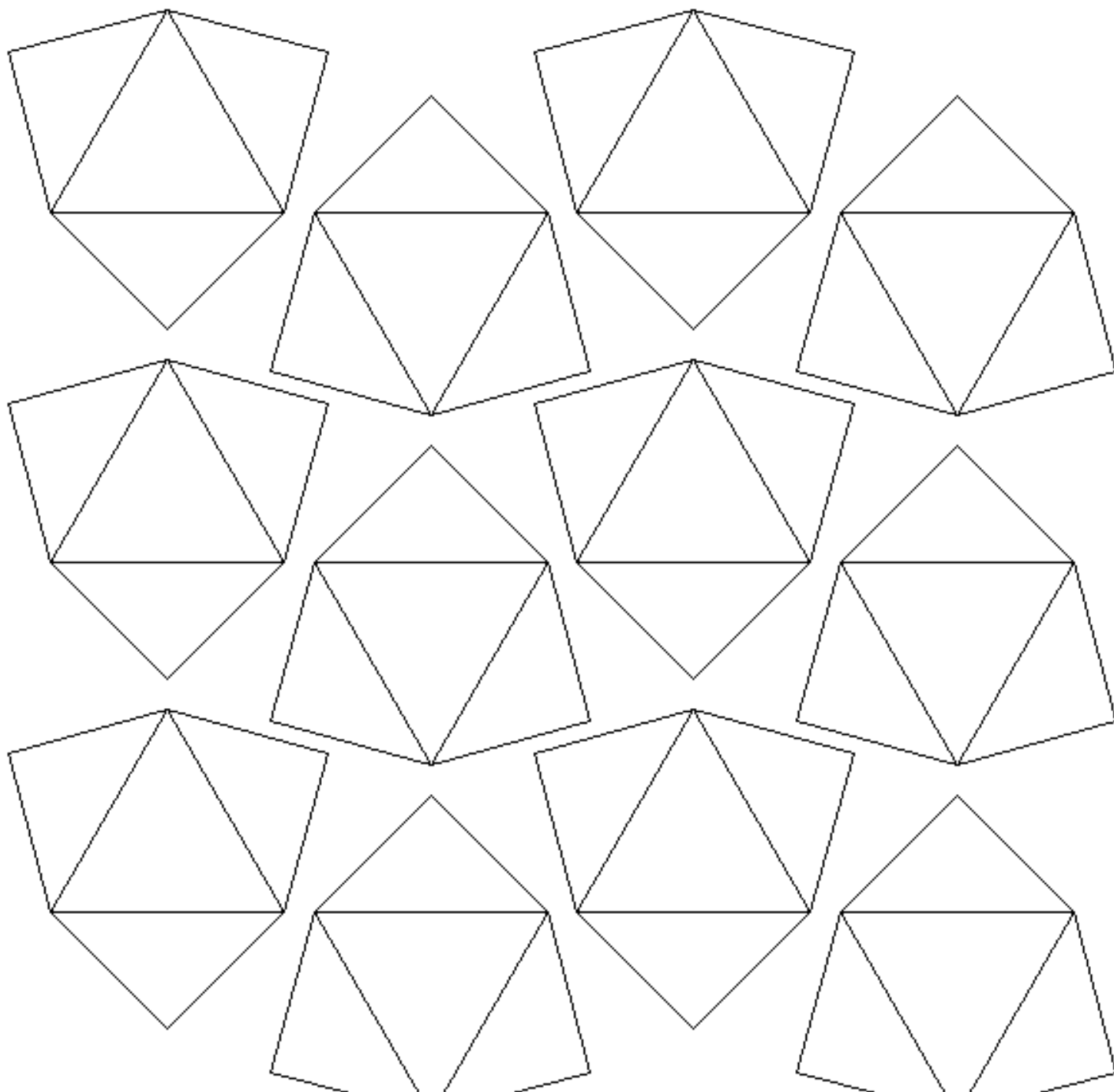



Half  
Octahedron

# Elements of an Octahedron

Octa-Elc.dwg. (1.6)

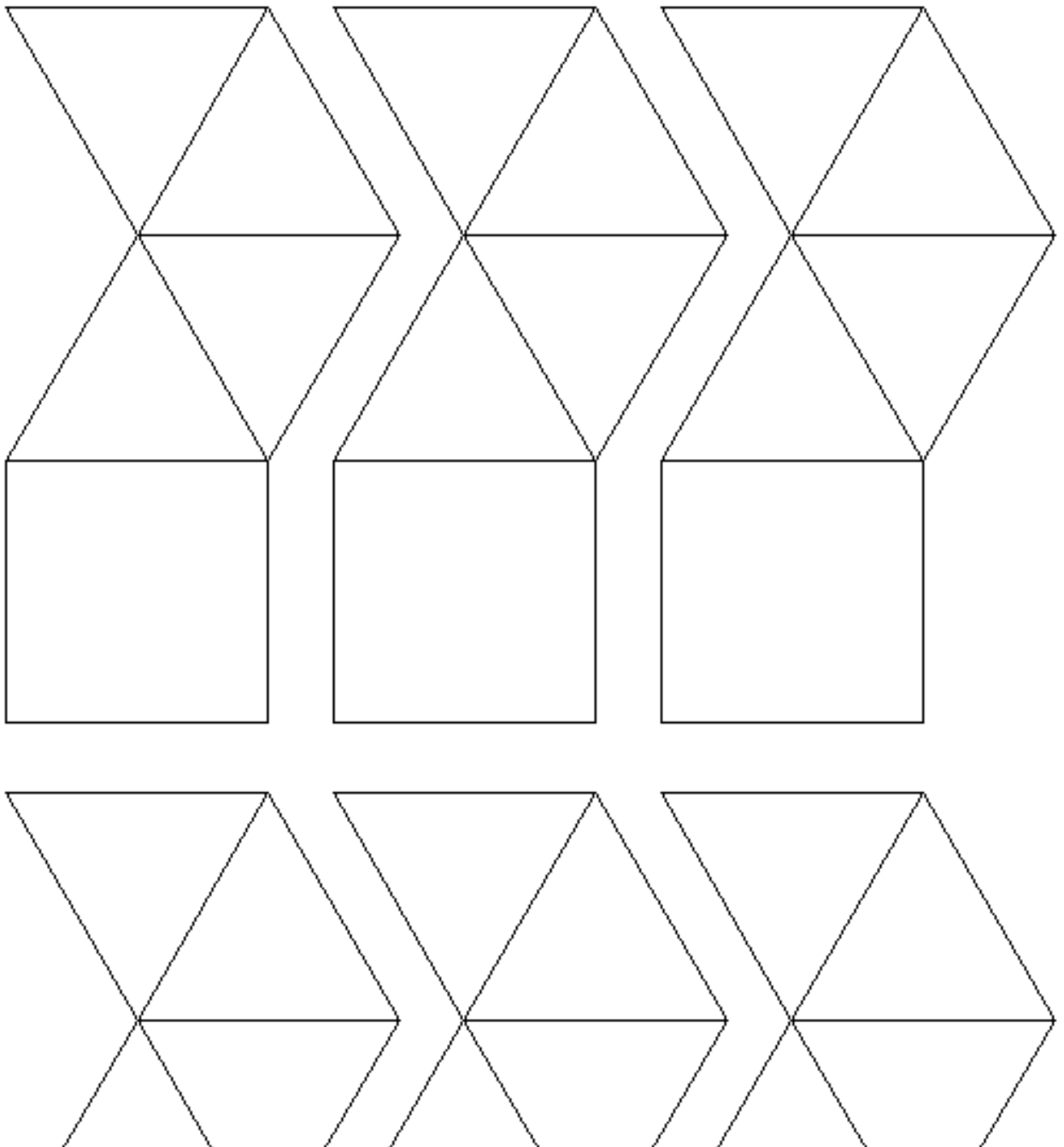

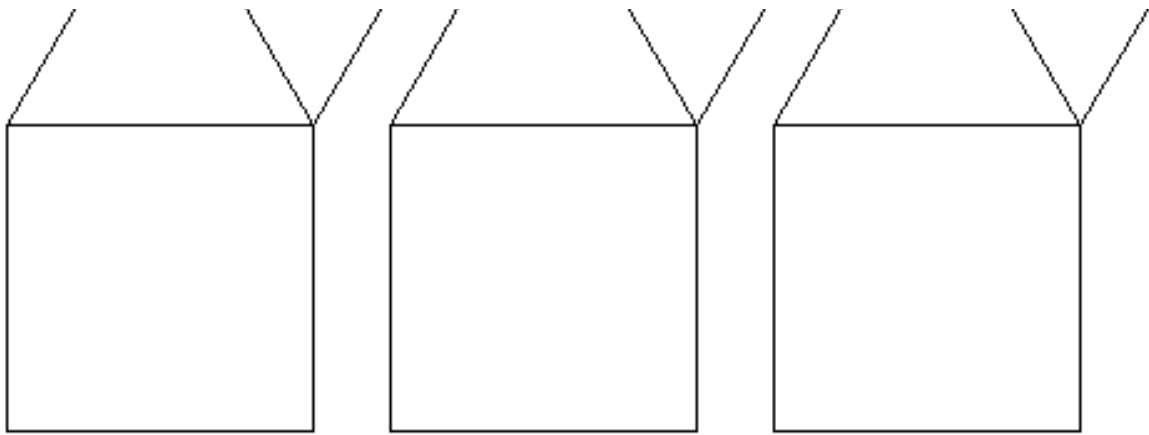

# Half Octahedron

Oct-Cut.dwg.(1.6)

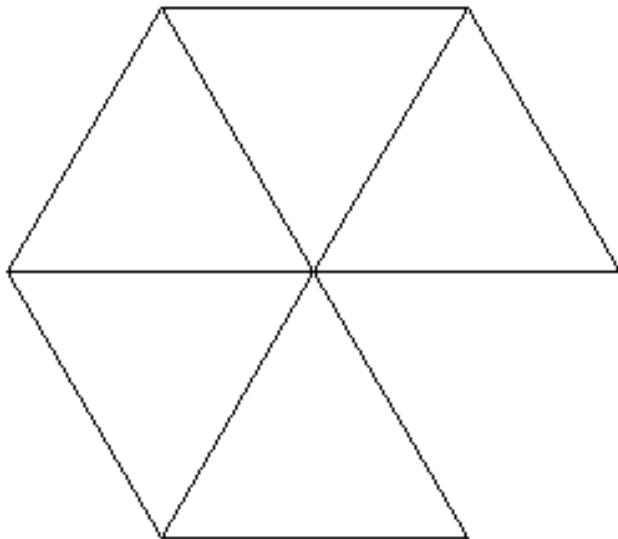

Isocahedron Top

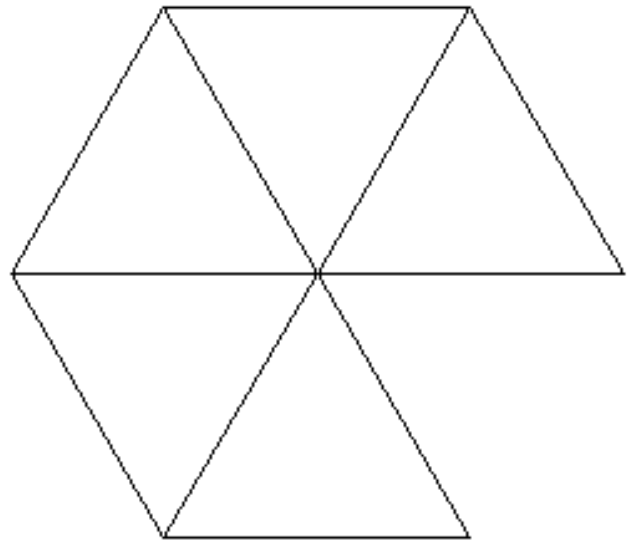

Isocahedron Top

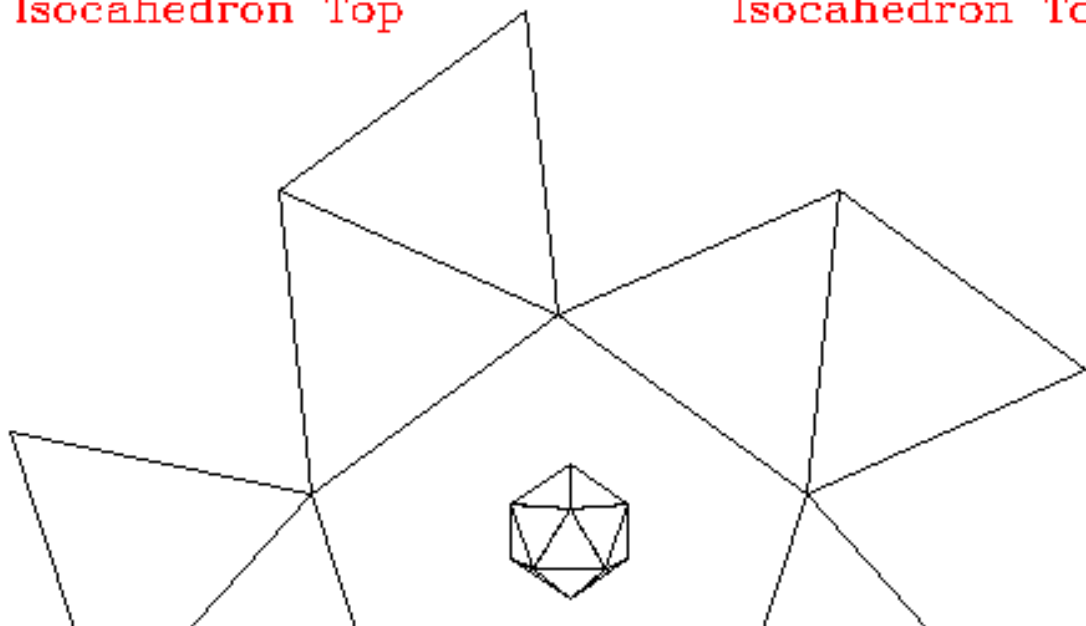



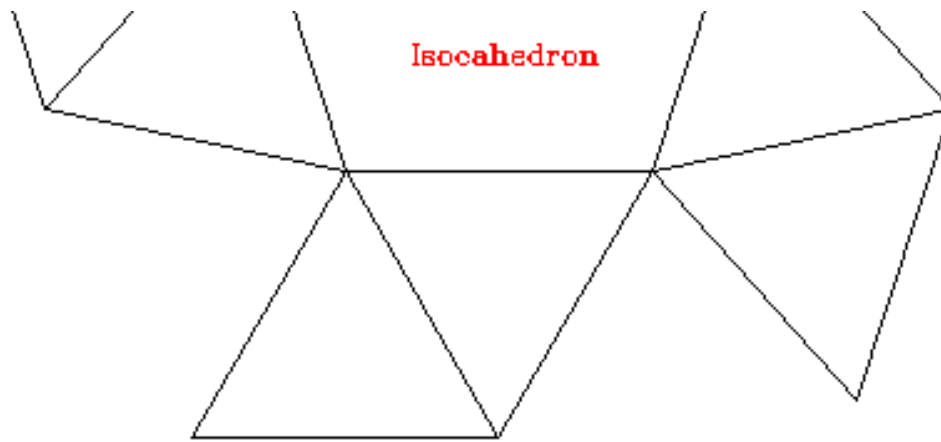

Isocahedron

Truncated Isocahedron

Isocahedron

Isocah6.dwg.(1.6)

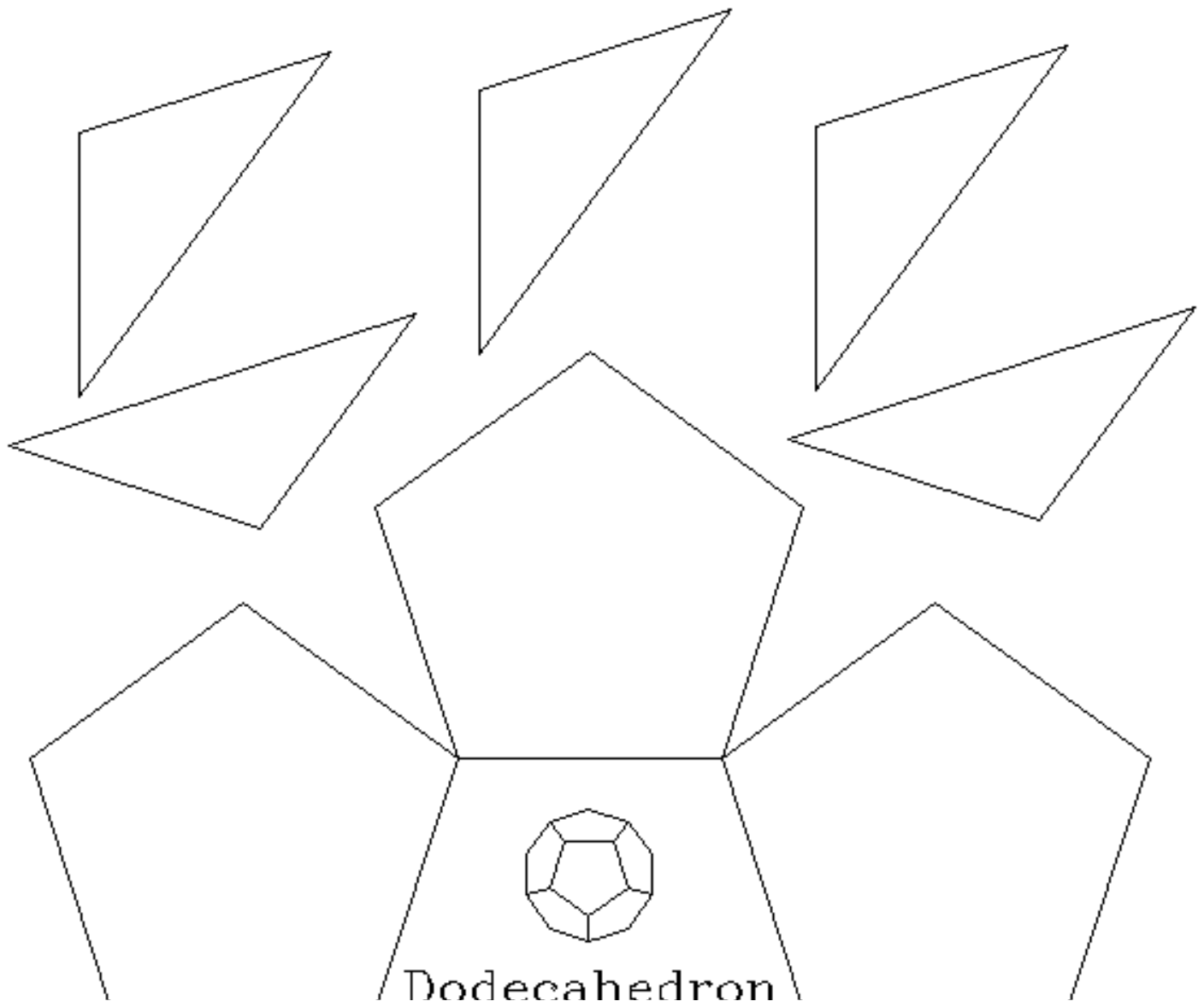

Dodecahedron

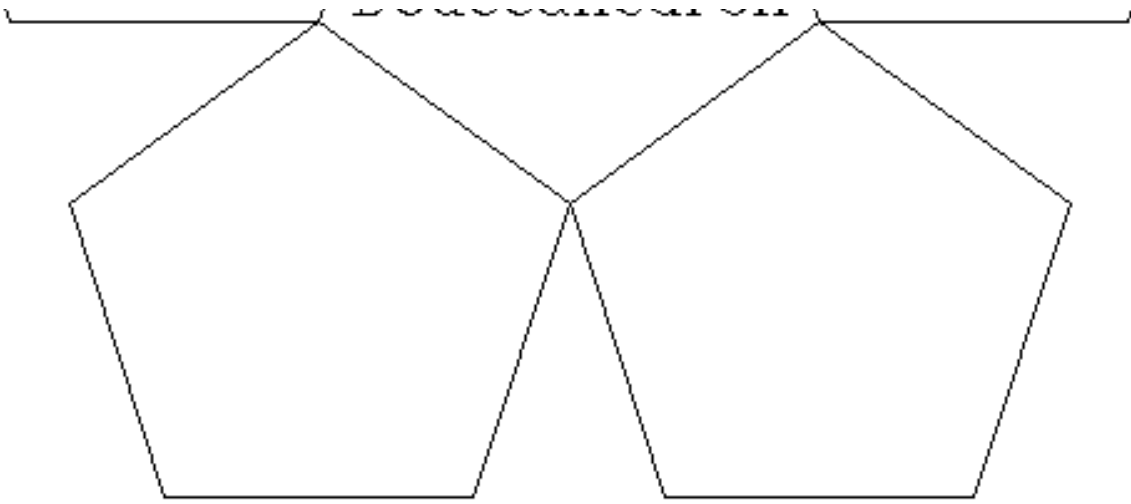

Half

Dodecahedron  
Dodacah3.dwg.(1.6)

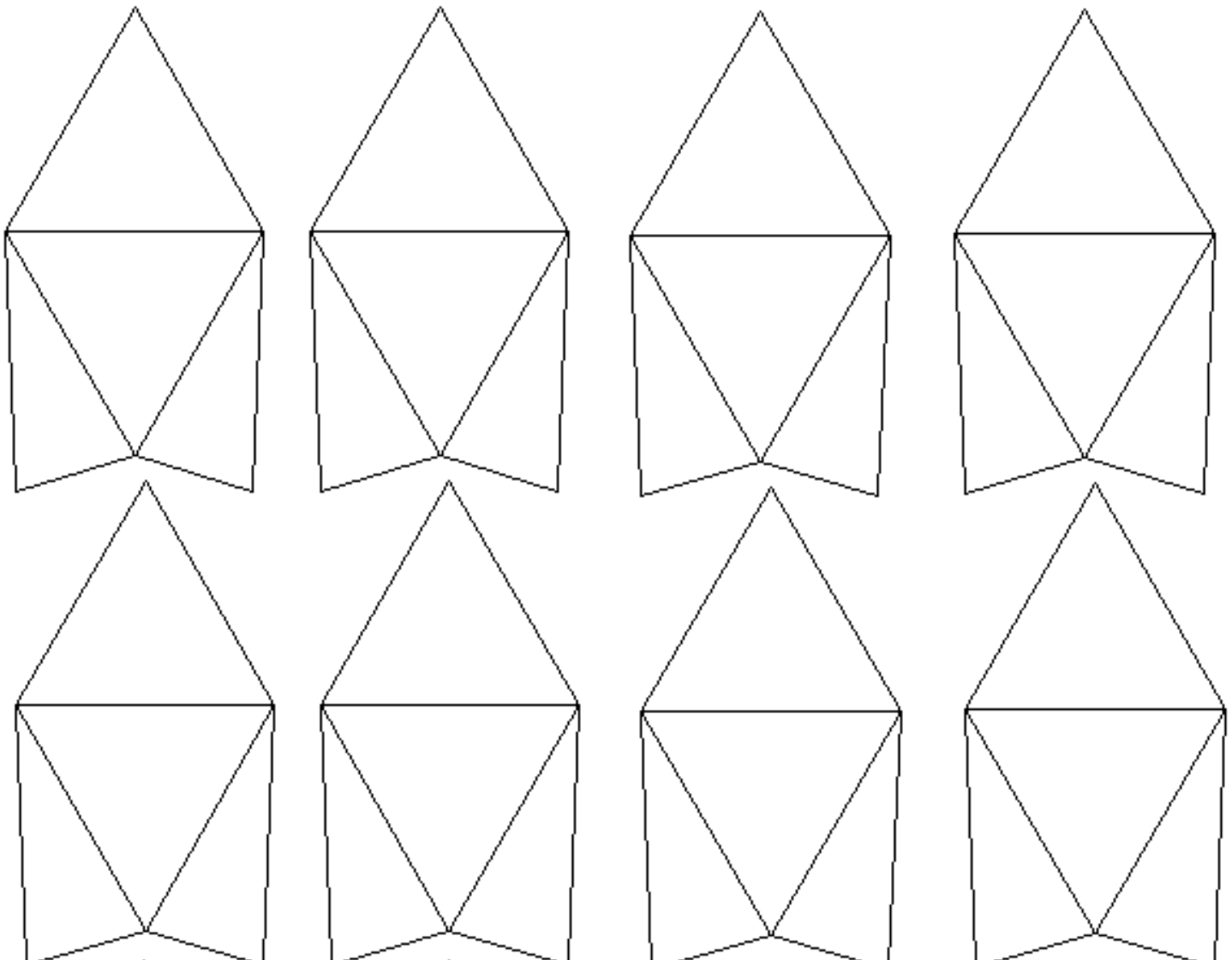

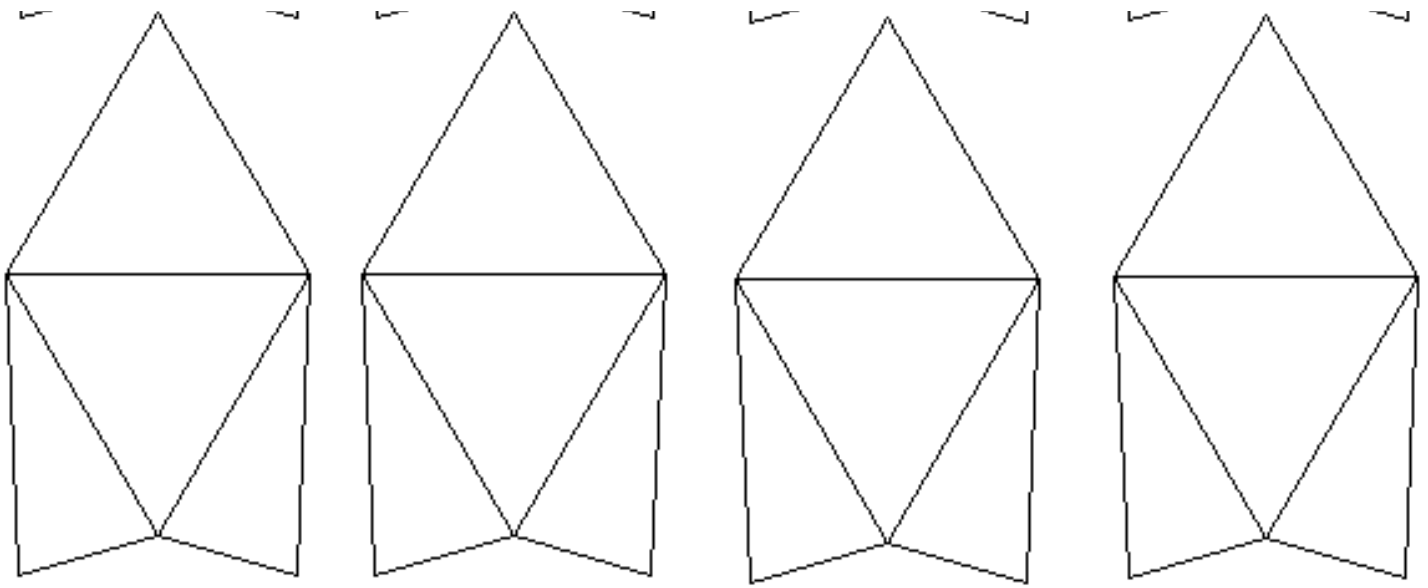

Geodesic Connector  
Tri-P-Rt.dwg.(1.6)

- [Return to Shareware page](#)

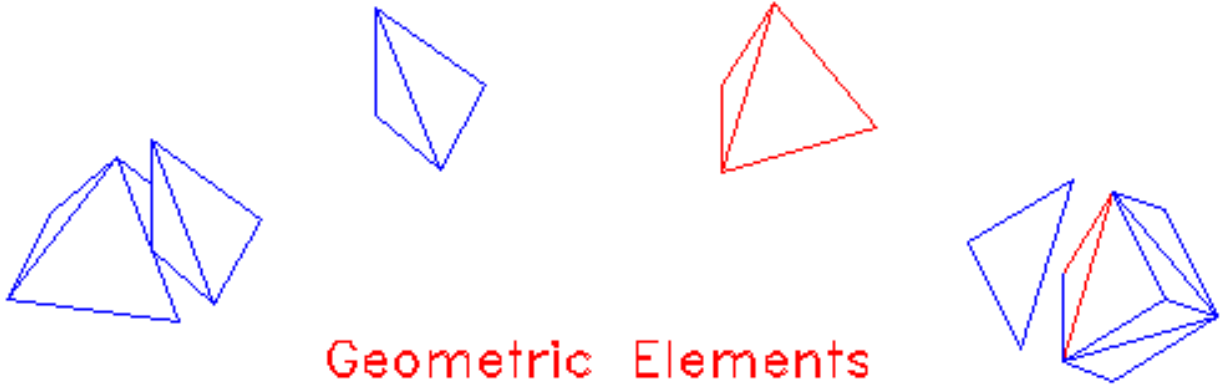

# Geometric Elements

with

# Complex and Simple Compounds

(Level 2 Workbook)

(3rd Edition)

© 1998 Robert Conroy

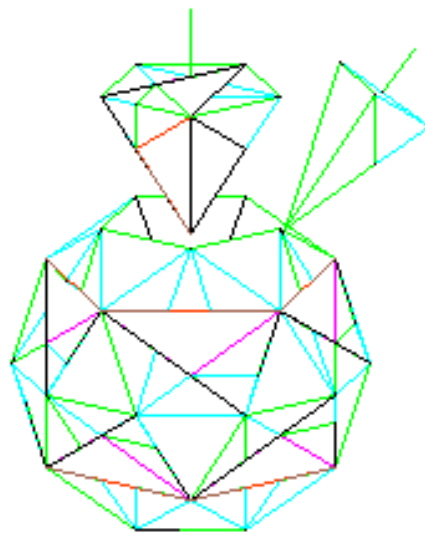

# Introduction

This workbook is meant as a teaching tool in order for the student to be able to view **three dimensions in a clearer light**. Hopefully students will be able, with the help of the tools in this workbook, to create new **structural compounds as yet undiscovered** by science today. By making these new discoveries the students will be able to feel the adventure and excitement in treading ground that has been undisturbed for **millenium**. All the student adventurer needs is a few simple tools, plus hard work and perserverence.

I have included a few quotes from some famous philosophers to show that the ground the students are treading is not new but merely unvisited in a long time.

Empedocles wrote:

"Everything is composed of water, air fire, earth combined by love into harmony" "Hate dissolves everything into 4 separate groups."

John in 1 John 5 wrote: "For there are three that bear witness, the Spirit and the water and the blood; and the three are in agreement"

(The Spirit being fire, or yellow, while the blood being representative of the color red, whereas water being representative of the color blue. These are three primary colors from which all colors can be derived. Color is nothing more than frequency, and matter is no more than energy divided by the square root of light velocity, and energy is no more than frequency.)

(Just as all colors can be derived from three primary colors or frequencies, so can the elements of structure be derived from three basic length defined frequencies.

Plato wrote:

"The simplest solid would be a pyramid that consists of four triangular surfaces," "Triangles represent the basic constituents of all things: The four Platonic figures are:

- Fire—Tetrahedron
- Air—Octahedron
- Earth—Cube
- Universe—Dodecahedron

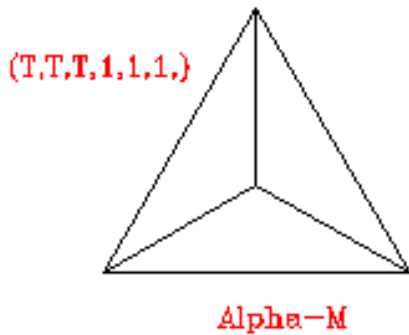
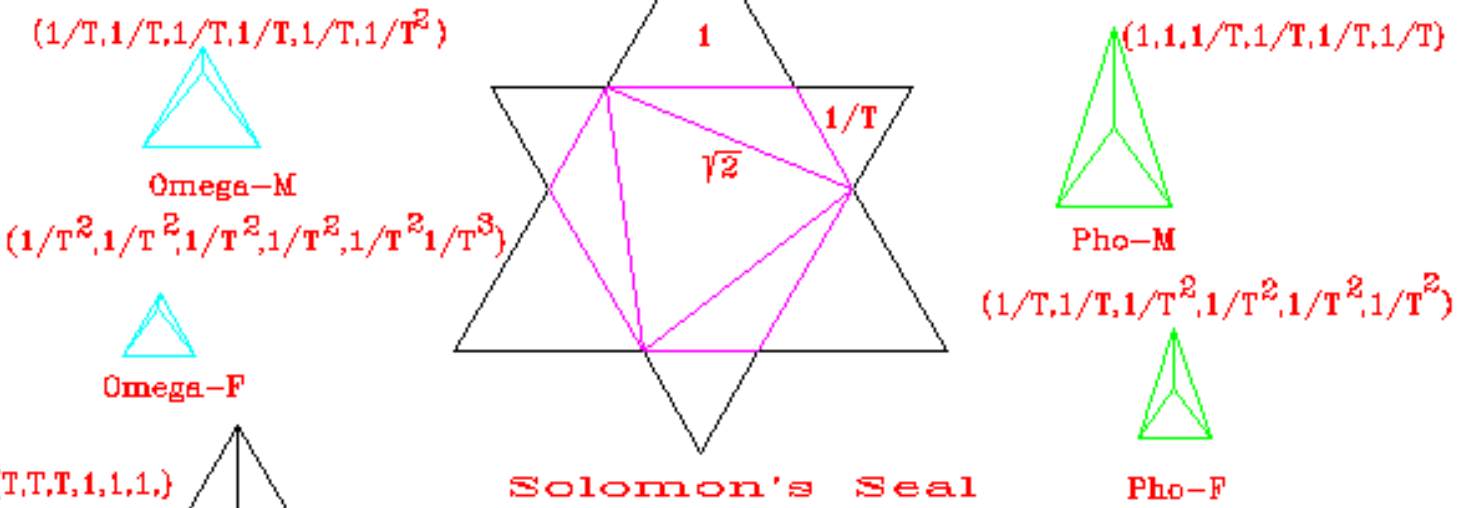
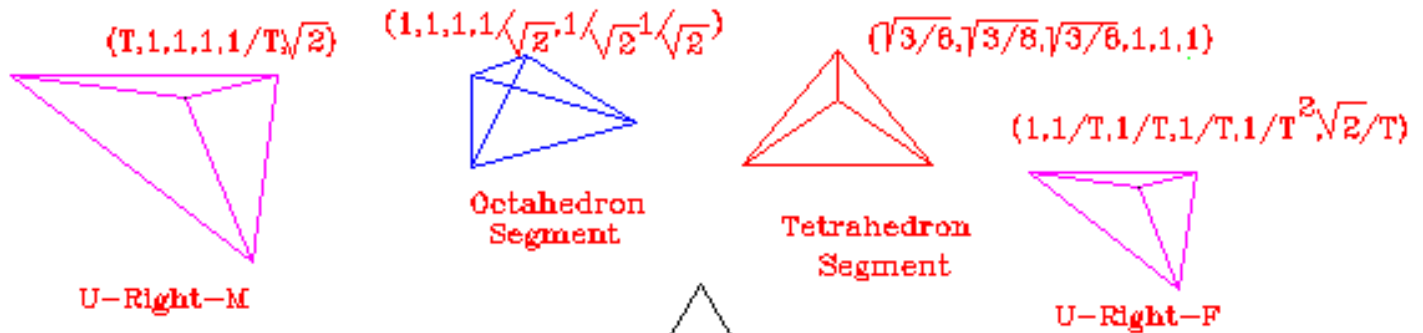
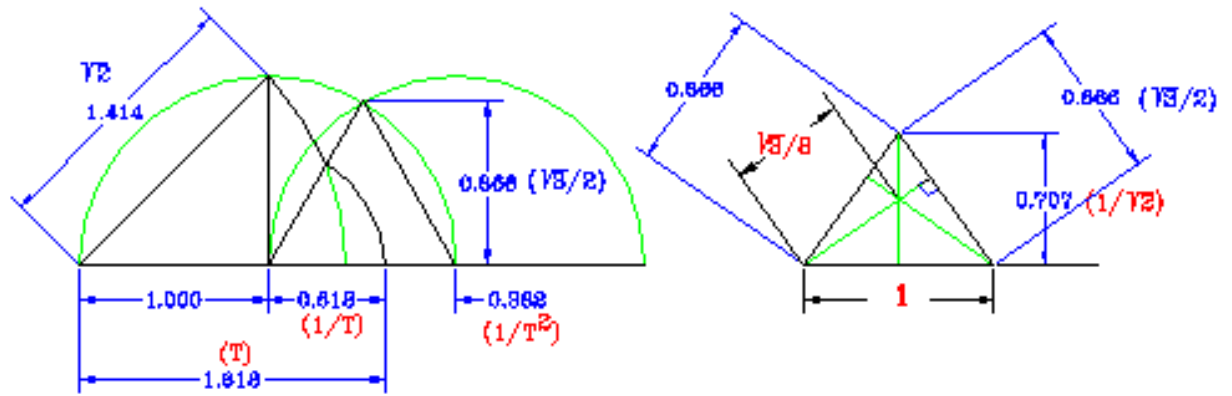

$$T = (\sqrt{5} + 1) / 2 = 1.6180$$

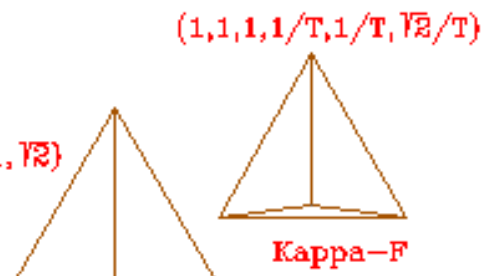

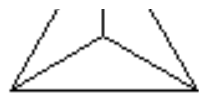

Alpha-F

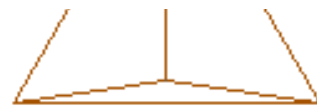

Kappa-M

# Elements Element4.dwg.

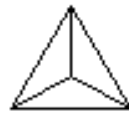

Alpha Element  
Female  
(1)



Male  
Point Element  
(2)



Point Element  
Female  
(2)



Wedge Element  
Male  
(1)

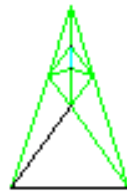

Point Compound II



Wedge Element  
Female  
(1)



Kappa-Element Female  
(1)



Point Element  
Female  
(1)



U Right Element  
(1)



Wedge Compound I



Wedge Element  
Female  
(1)

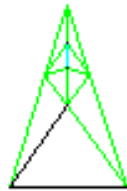

Point Compound II

+

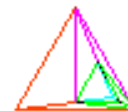

Wedge Compound I

=



# Tri II Compound

## Tri II Compound

Scale T:1

Pnt-Wdg.dwg

bk2-icdc.gif

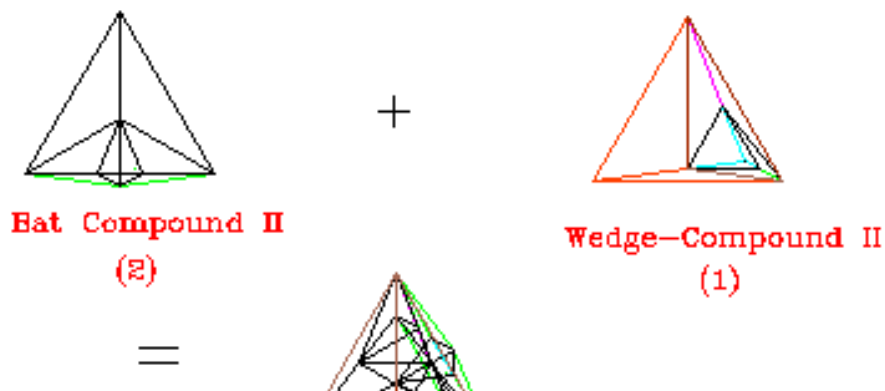
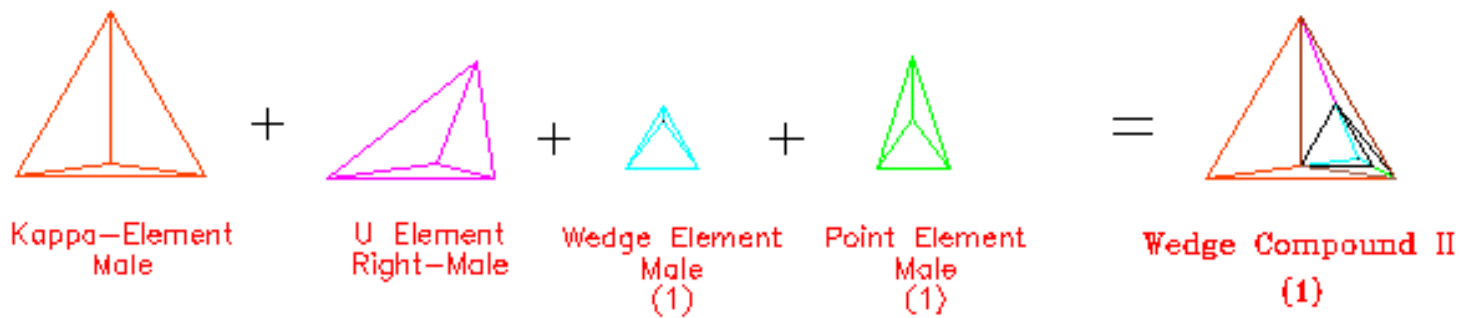
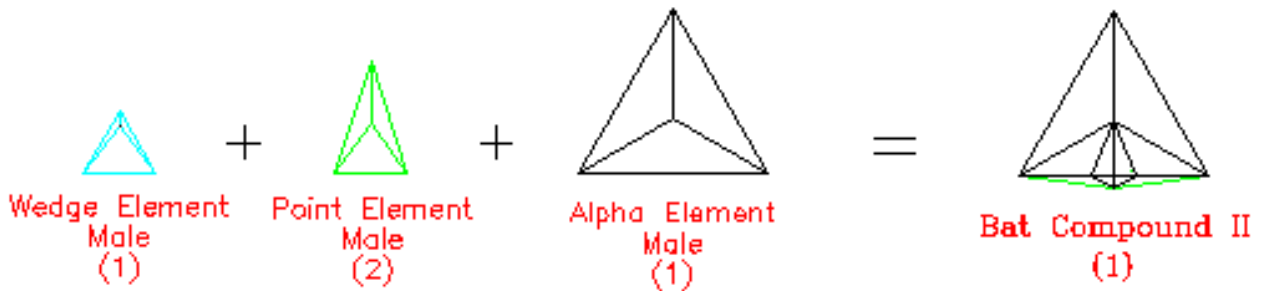





# Pent II Compound (1)

## Pent II Compound

Scale T:1

Tri-Pent.dwg

bk2-icdp.gif

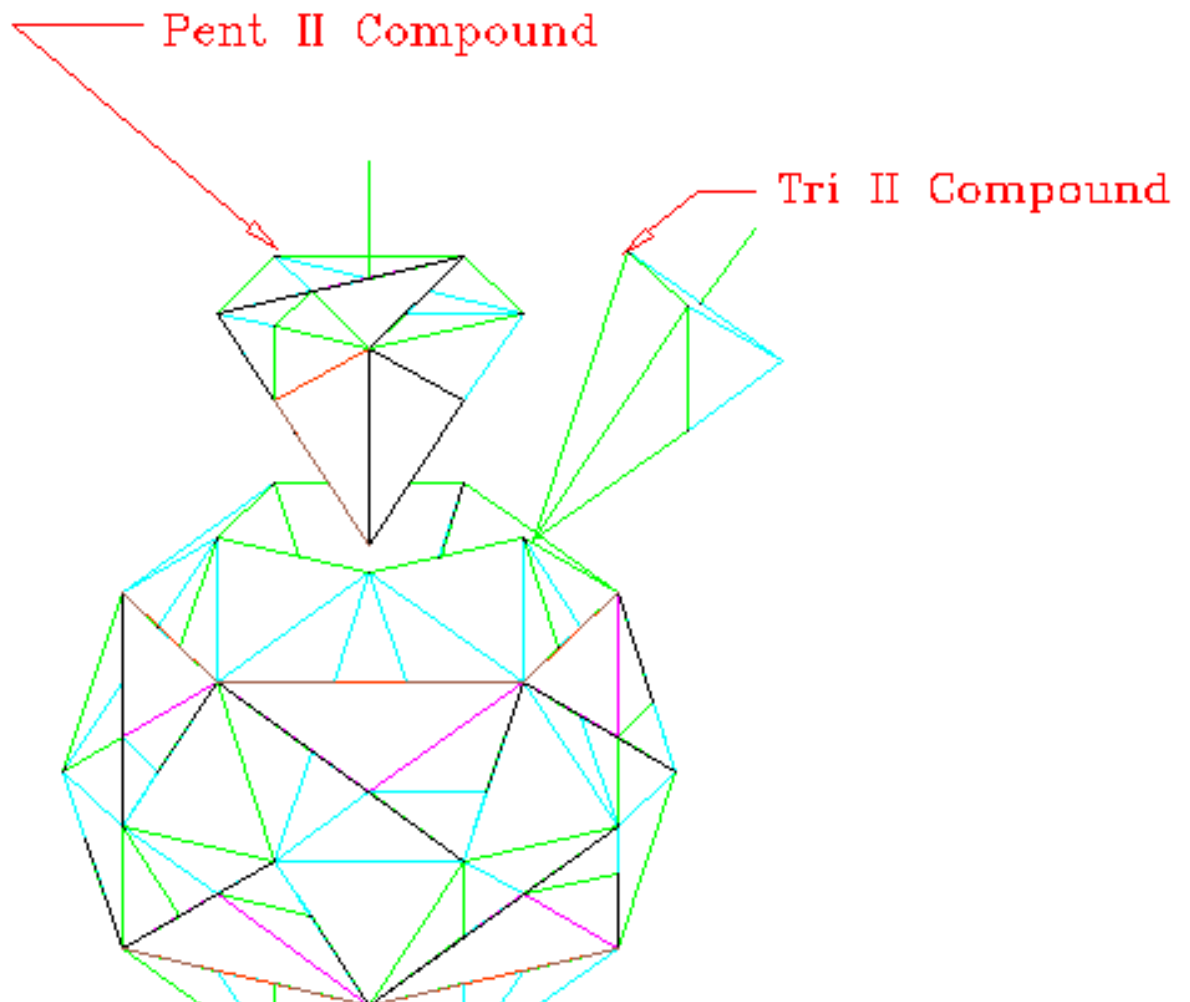

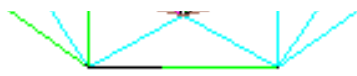

# Tri-Pent Geodesic (Icosidodecahedron)

Scale 1:1

Tripent5.dwg

bk2-icd.gif

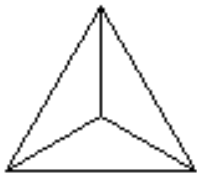

Alpha-Female  
(20)  
bl-a-f

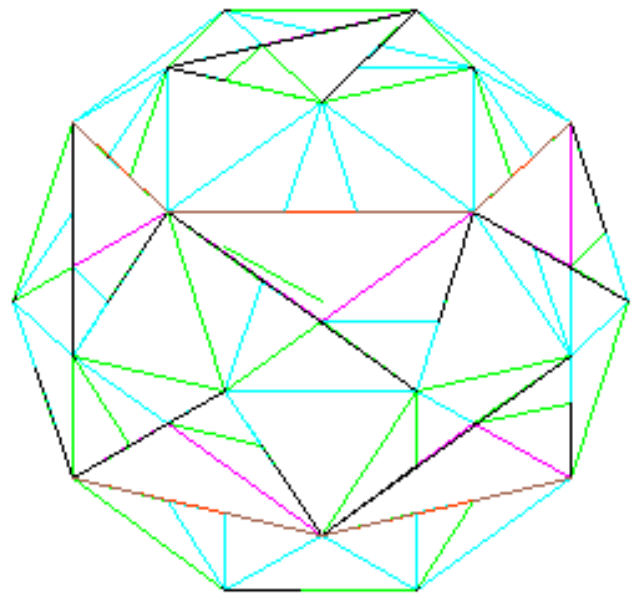

Tri-Pent Geodesic  
(icosidodecahedron)

bl-trpt3  
wb-trpt3

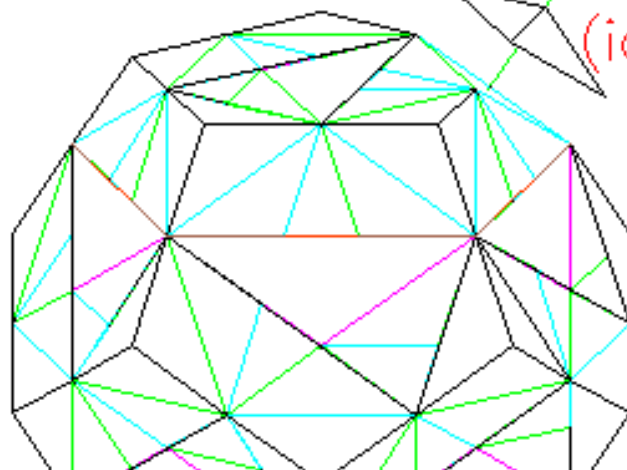

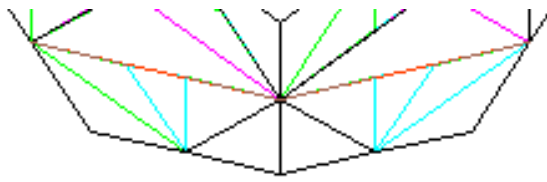

Dodecahedron

b-dodec2

Dodecahedron

Scale 1:1

Dodecah2.dwg

bk2-dod.gif

- [2nd half of Level 2 Workbook](#)

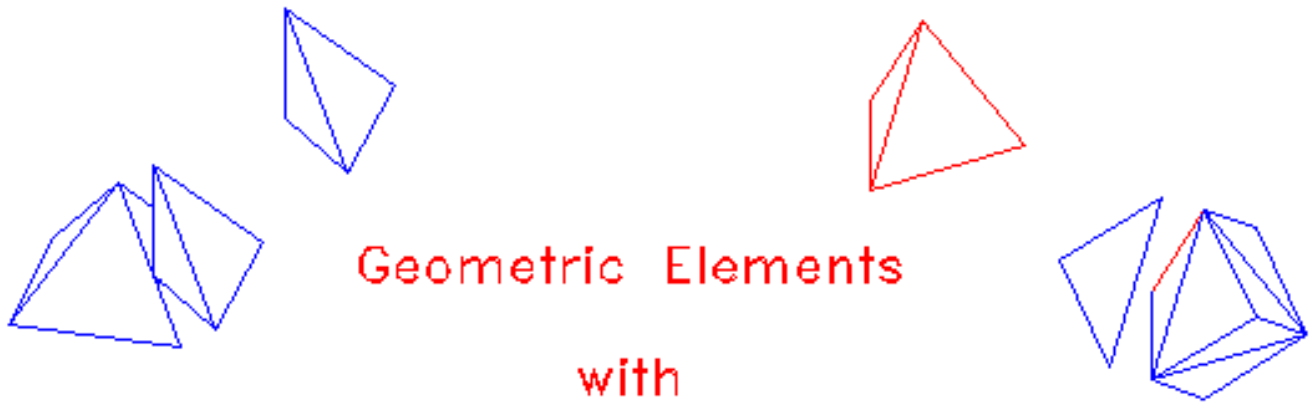

**Geometric Elements**  
**with**  
**Complex and Simple Compounds**

(Level 3 Workbook)  
(3rd Edition)

© 1998 Robert Conroy

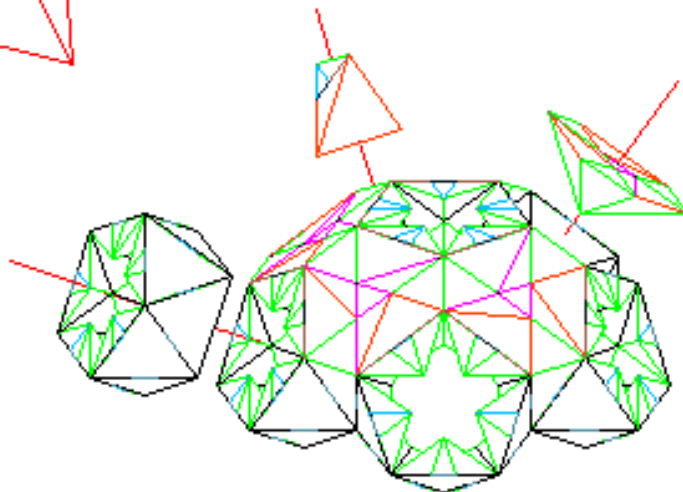
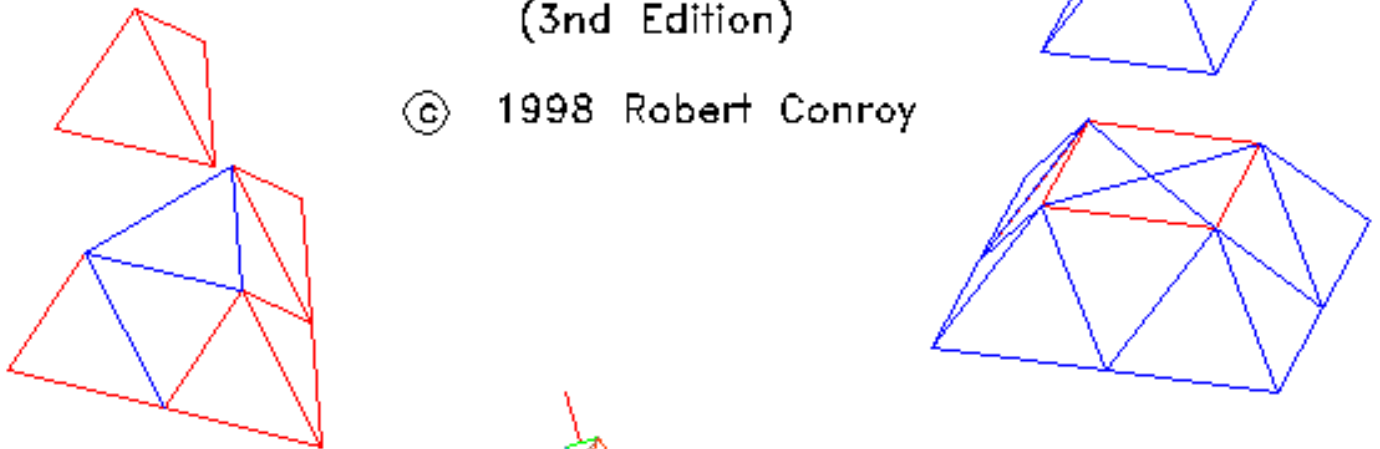

## Introduction

This workbook is for students who may have the desire to continue into the advanced sciences. In my opinion, this geometric avenue of examination has not been properly commented on since the time of Plato. Using this approach, hopefully students should be able to discover elements which have been hidden for millenium.

The application of this methodology is not only usefull in engineering, but also in the medical, phisics, and chemistry fields. As its application to structures is the easiest to pursue, that is the avenue this writer will continue to develop in these first set of books.

Of the 12 elements presented in this treatise, of which there are only 7 basic shapes, only 2 of these elements and their cominations are normally used intodays architecture. What this does is keep the cost of structures high and the strength low when compared to other higher strength options.

Hopefully with young, bright students, better grounded in structural fundamentals, the future will not only be, but even look different.

All possible combinations of elements have not been presented. If the students, pursuing this adventure, find a unique combination of elements, they may submit them with a recommended descriptive name to the author for possible inclusion in a future edition. e-mail: Robert\_Conroy@compuserve.com

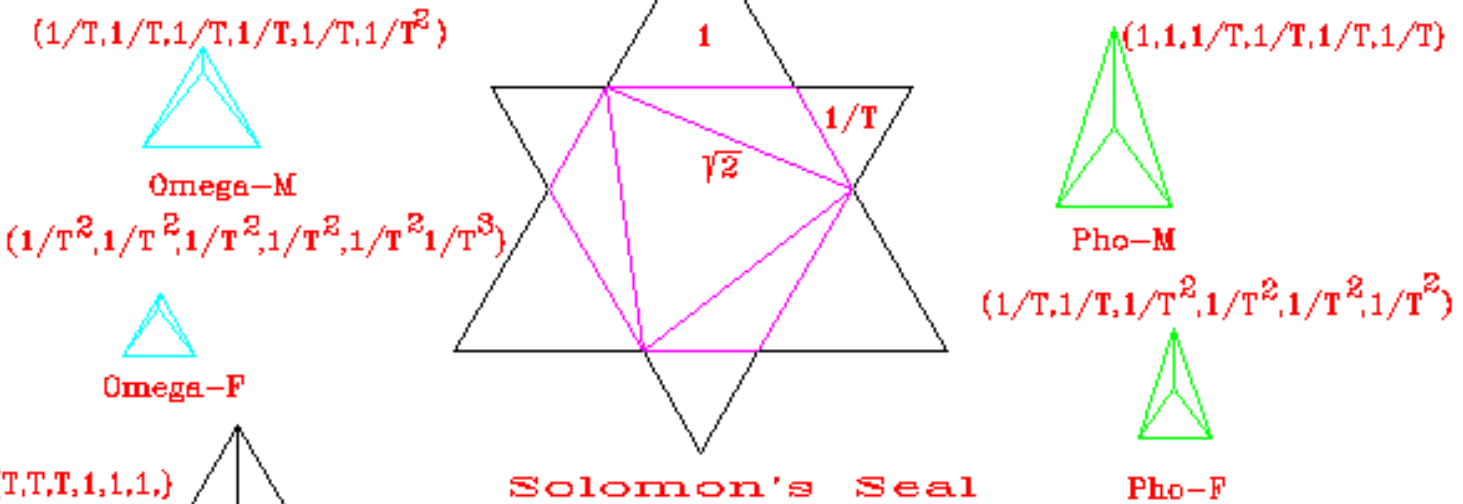
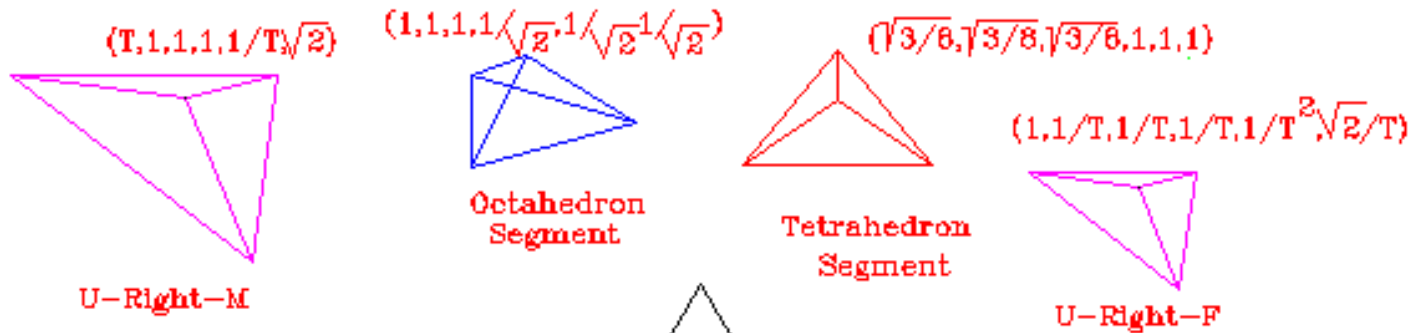
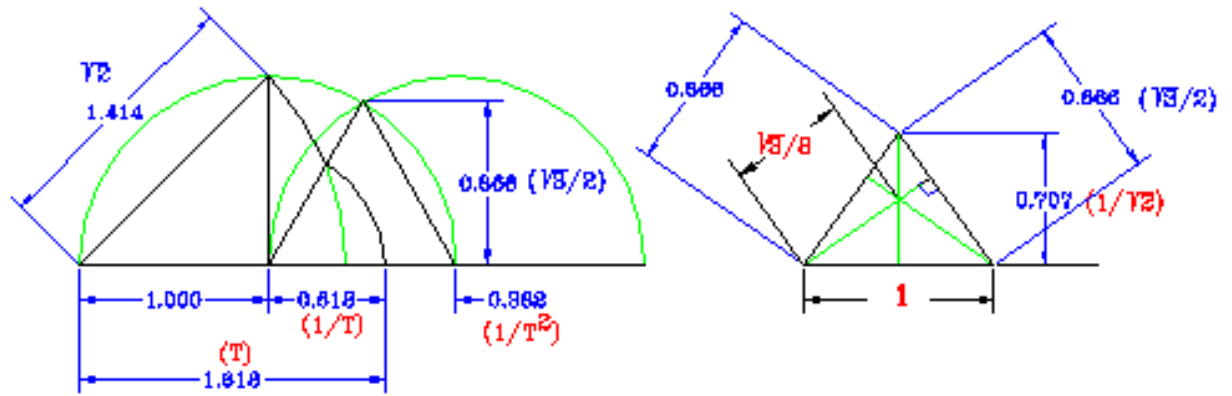

$$T = (\sqrt{5} + 1) / 2 = 1.6180$$

$$(1, 1, 1, 1, 1/T, 1/T, \sqrt{2}/T)$$

$$(T, T, T, 1, 1, \sqrt{2})$$

$$(1, 1, 1, 1, 1/T, 1/T, 1/T)$$

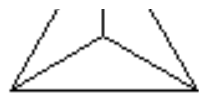

Alpha-F



Kappa-M

# Elements Element4.dwg.

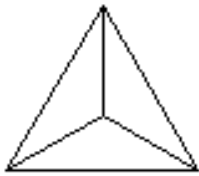

Alpha-Female  
(5)

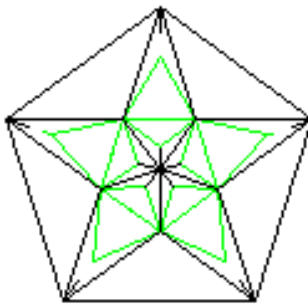

Isocahedron Top  
(12)



Wedge-Female  
(5)



Point-Female  
(10)

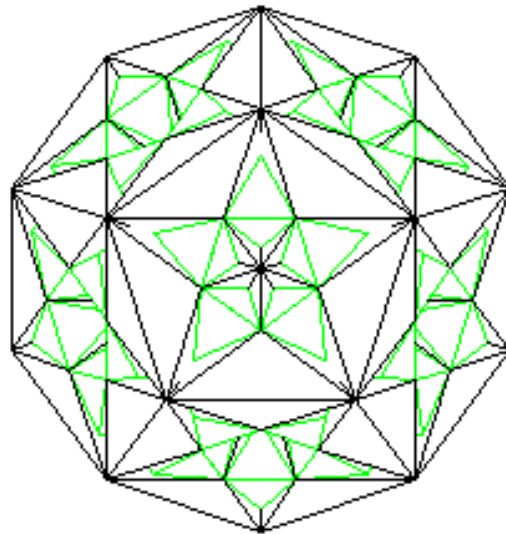

Note; The base platform is an Isocahedron.  
Internal spacer elements consist of a further  
arrangement of Wedge and Point Elements.  
Further external fillers consist of another

# Dodacahedron Shell

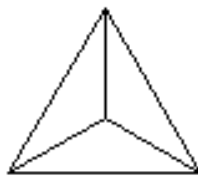

Alpha-Female  
(5)

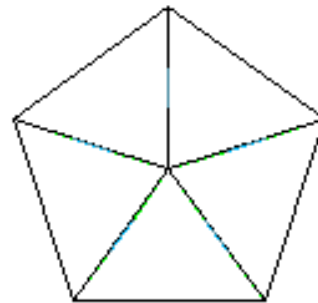

Isocahedron Top



Wedge-Female  
(5)



Point-Female  
(10)

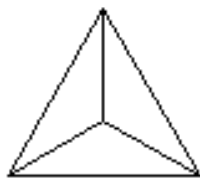

Alpha-Female  
(10)

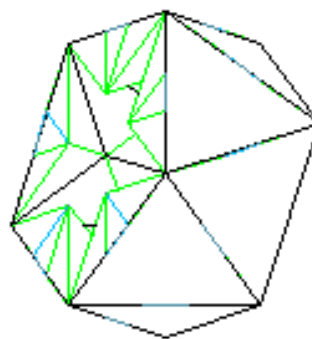

Wedge-Female  
(20)



Point-Female  
(30)

# Truncated Isocahedron Shell

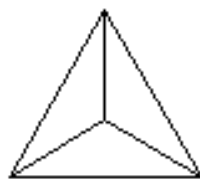

Alpha-Female

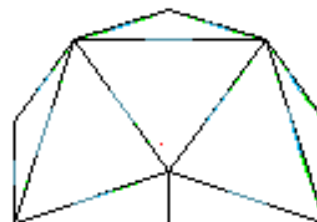

Wedge-Female  
(30)





(20)

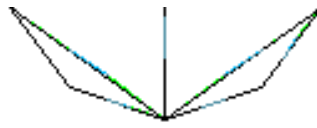

Point-Female  
(50)

## Full Isocahedron Shell

## Isocahedron

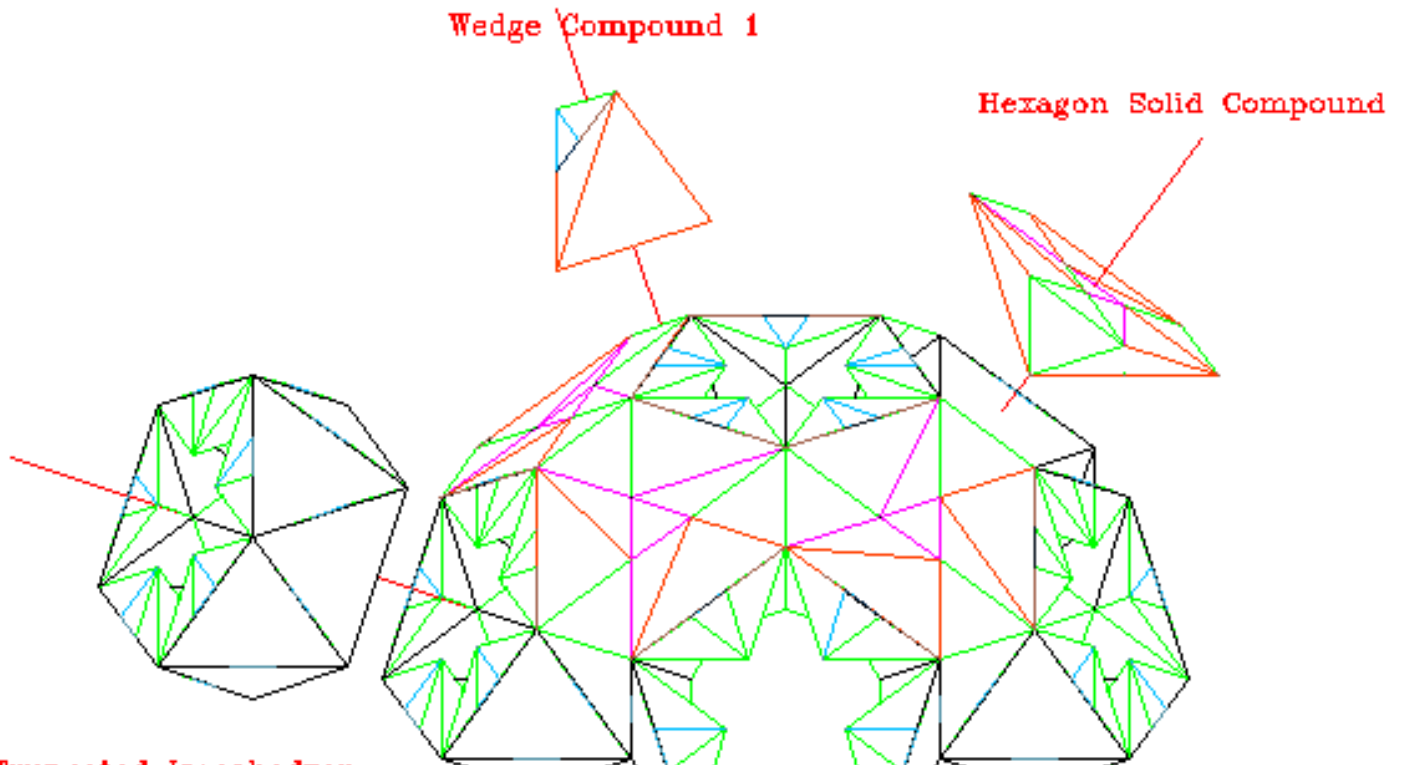

Truncated Isocuboctahedron  
Shell

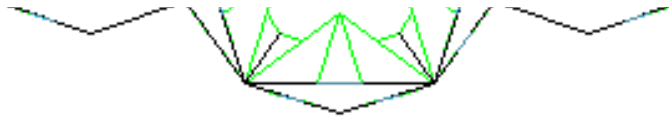

## Partial Hex-Pent Geodesic

- [go to continuation of Level 3 Workbook](#)

**GAMES**[Anagrams](#)[Anagrams for Two](#)[Animal Concentration](#)[Color Concentration](#)[Super Color Concentration](#)[Flower Concentration](#)[Math Quiz](#)[Golf Quiz](#)[Create a Neighborhood](#)**STORIES**[Story Index](#)[Adventure into Gibby-gibby Land](#)[When Puskinville was Mapland](#)[The Dinner Tree](#)**MISCELLANEOUS**[Keyboard Chords](#)[Icosahedrons](#)[Ancient Riddles](#)[Famous Quotes](#)[Odd Facts](#)[Competition Winner Paradox](#)[Plant Search](#)[Quantum Theory in SciFi](#)**Games****[Anagrams](#)**

Interactive word scramble game for one or more players.

(DHTML & JAVASCRIPT. Created with letters you can move and rearrange with your mouse.)

**[Anagrams for Two Players](#)**

Scramble the word of your choice for your opponent to unscramble.

(DHTML & JAVASCRIPT. Created with letters you can move and rearrange with your mouse.)

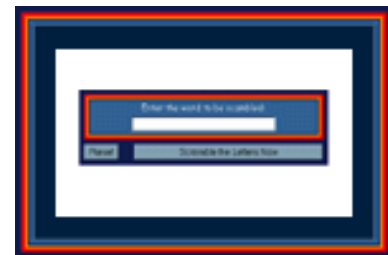
**[Animal Concentration](#)**

24 cards and a dozen wild animals to discover.

(JAVA)





### [Color Concentration](#)

36 cards and a rainbow of colors to mix and match.

(JAVA)

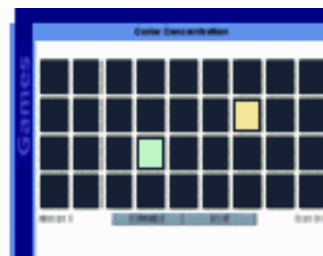

### [Super Color Concentration](#)

60 cards and dozens of colors to dazzle you.

(JAVA)

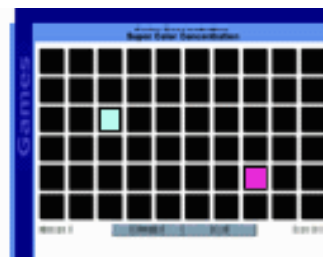

### [Flower Concentration](#)

24 cards and a dozen blossoming bloomings.

(JAVA)

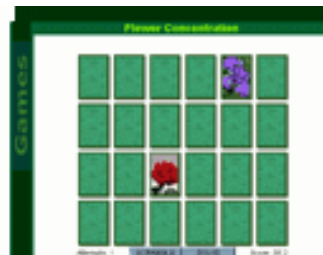

### [Math Quiz](#)

6 Basic Math + 6 Fraction Quizzes.

(JAVASCRIPT)

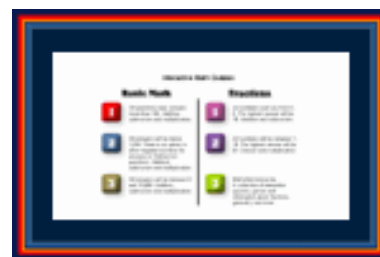

### [Golf Quiz](#)

Questions of course.

(JAVASCRIPT)



### [Create a Neighborhood](#)

Design your own community with images you can move around the screen.

(DHTML)



## Miscellaneous



### [Keyboard Chords](#)

Chart of 144 Keyboard Chords including Keyboard Diagrams and Annotation .



### [Icosahedrons and the Invention of the Planetarium Projector](#)

Geodesic Domes and Charts of the Heavens.  
A brief history of the astronomical devices that led to the inventions of the planetarium projector and the dome.

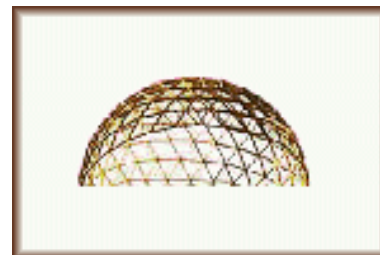

### [Ancient Riddles](#)

The beginning of eternity  
The end of time and space  
The beginning of every end,  
And the end of every place...  
and more. :)



### [Famous Quotes](#)

Quotes, quips and clevernesses.



### [Odd Facts](#)

A collection of strangeness.



### [What Would You Most Like to Read on Opening Your Paper?](#)

Our Second Competition: a paradox.



### [Greenery: Search for Plants](#)

Search for plants in the USDA Database using common name, scientific name or symbol.





## Quantum Theory in Science Fiction

Recommended reading.



## Stories



### The Adventure into Gibby-gibby Land

The Puskins Discover a Secret Path in the Woods that Leads them to a New and Strange Land.



### When Puskinville was Mapland

The Puskins Surprise the Grumpies.



### The Dinner Tree

An Act of Kindness, the Little Gray Puskin and the Magic Dinner Tree.



Find a link that's no longer valid? [Please let us know.](#)  
**Please Note:**  
The information presented on line in the "In A Nutshell" series, is offered as a free, and hopefully, helpful service. Time constraints, however, make it impossible to provide specific answers to individual inquiries.

Created by Tela Communications  
© Copyright JSwift. All Rights Reserved

TOP



# tela communications

A Virtual Web Solutions Company

WWW Solutions

Nutshell Guides

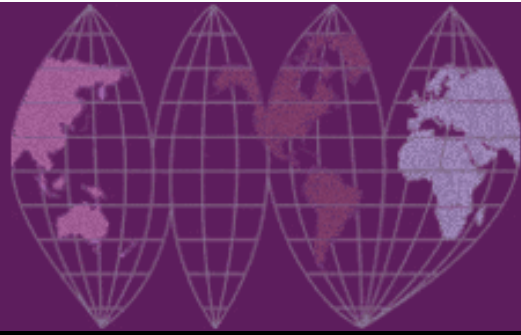

[Privacy Policy](#)

**NEW!**  
[StretchWare Affiliate Program](#)

[Gimme Shelter Newsletter Spring 2004](#)

[Home Work Poster](#)

**Coming Soon**

[Wonderful Houses Around the World Our Newest Children's Book](#)

[FREE 30-day Download StretchWare](#)

The Software that Reminds You to Stretch!

[More Books on Building Septic System Owners' Manual](#)

[Shelter](#)

[Shelters, Shacks, and Shanties](#)

[Wildwood Wisdom](#)

**ARE YOU LIVING OFF THE GRID?**

**We Are Looking For Photos & Stories For Our Next Book Home Work: Off the Grid**

[Click Here to Email a Photo or Two](#)

[Our Fitness Books](#)

[Stretching 20th Anniversary Revised Edition](#)

[Stretching in the](#)



Shelter Publications, Inc., Bolinas, California

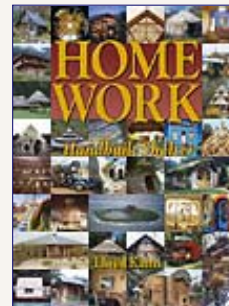

[Look Inside Our Book](#)

## QUALITY BOOKS ON FITNESS, BUILDING, AND ARCHITECTURE

### Fitness Books

We produce the best [fitness](#) books in the world — no kidding! Take a look. [Stretching](#) and workout charts, [running](#) advice, [weight lifting](#), even staying fit while [sitting at a desk](#) . .

### [Stretching](#)

[Stretching: 20th Anniversary Revised Edition](#)  
By Bob Anderson

Can one of the world's most popular fitness books get even better? It can! *Stretching*, by Bob Anderson, has been completely revised, with all new drawings, 25 new stretching routines, and updated stretching information throughout.

\$16.95

[Learn more](#)



\*\*\*\*\*

### [Stretching in the Office](#)

By Bob Anderson

Help for the office worker. Twenty stretching routines to help prevent neck and shoulder stiffness, lower back pain, stiff muscles and tight joints.

\$11.95

[Learn more](#)



\*\*\*\*\*

### More on Staying Flexible

### Books About Shelter, Building, Architecture, and the Home Arts

We wrote the [book](#) on shelter . . . also the [manual](#) on septic systems . . . and reprinted forgotten gems about [shacks](#) and the [wisdom](#) found deep in the wild woods. . .

### [Shelter](#)

Edited by Lloyd Kahn

Our classic namesake book from 1973, with over 1000 photos of amazing handbuilt shelters: huts, tents, domes, yurts, caves, barns, houseboats, treehouses, sheds, and much, very much more.

\$24.95

[Learn more](#)

\*\*\*\*\*

### [Special: Dome Information](#)

\*\*\*\*\*

### [The Septic System Owner's Manual](#)

By Lloyd Kahn, Blair Allen, & Julie Jones

How they work, how to maintain them, what to do if things go wrong. Simple, clear, informative. Great drawings by Peter Aschwanden.

\$17.95

[Learn more](#)





[Office](#)[Galloway's Book on Running](#)[Marathon: You Can Do It!](#)[Getting in Shape](#)[Getting Stronger Revised Edition](#)[Ancient Way to Keep Fit](#)[More Fitness Resources](#)[The Office Fitness Clinic](#)[Online Stretches](#)[101 Stretches Poster](#)[More Fine Books From Shelter  
Symmetry](#)[The Paper Propeller](#)[Getting Your Affairs in Order](#)[Grab Bag](#)[Gimme Shelter Newsletter Archives](#)[Skateboarding \(for the older crowd\)](#)[Top o' the Bridge, Ma...](#)[A trip to the top of the Golden Gate Bridge](#)[Adventures in Baja](#)[Surfing](#)[Travel to a Greek Island](#)[Kayaking to San Francisco](#)[Scooters](#)[New York City](#)[Office Fitness Clinic](#)

How to stay fit even though you sit at a computer or desk each day.

[Online Stretches](#)

Try them now. You'll feel better!

[Lifelong Fitness](#)

It's time to honor that New Year's resolution to get back into shape. Here's the book that will show you how!

[Getting in Shape](#)

By Bob Anderson & Bill Pearl

A unique workout book for anyone who wants to get back into shape. Written by bodybuilding legend Bill Pearl, international stretching authority Bob Anderson, and exercise physiologist Edmund Burke.

\$16.95

[Learn more](#)



\*\*\*\*\*

[Getting Stronger Revised Edition](#)

By Bill Pearl

The most complete book on weight training ever produced, written by 4-time Mr. Universe Bill Pearl. Programs for general conditioning, body building, and strength training for 21 sports. Newly revised, with updated information on nutrition and supplements.

\$21.95

[Learn more](#)

[Running](#)[Galloway's Book on Running](#)

[2nd Edition](#)

By Jeff Galloway

[The West Marin Homeowners' Septic Gazette](#)

An ongoing series of online articles about septic issues that affect Marin County, Calif.

A small slice of the big pizza . . .

\*\*\*\*\*

[The Shelter Bookshelf Classic Reprints:](#)[Shelters, Shacks, & Shanties](#)

By Daniel C. Beard

Written in 1914 by the founder of the Boy Scouts, this unique book shows how to build both simple and complex sheds and shacks. Contains hundreds of wonderful pen-and-ink drawings and illustrations by the author.

\$10.95

[Learn more](#)



\*\*\*\*\*

[Wildwood Wisdom](#)

By Ellsworth Jaeger

Written in 1945, this masterpiece of outdoor living contains 500 richly illustrated pages of woodcraft lore rarely seen today.

\$14.95

[Learn more](#)

[Our Eclectic Mix](#)[The Paper Propeller, The Spinning Quarter, The Jumping Frog](#)

By Arthur Okamura

In this witty little book, author and illustrator Arthur Okamura fashions paper frogs that actually jump, uses a mirror to draw a magical star, and shows how to unpeel a sliced banana. Plus 35 other amazing tricks! Ideal for kids, car rides, and picnics, this book makes anyone an instant magician.

\$7.95

[Learn more](#)

[Symmetry: A Unifying Concept](#)

By Istvan & Magdolna Hargittai

[Prague](#)

[Dome Information](#)

[Join Our . . .](#)

[Shelter Fitness  
Re-Seller Program](#)

Olympic runner Jeff Galloway's definitive guide to running, completely revised and updated. With state-of-the-art training and techniques for both novices and competitive runners.



\$15.95

[Learn more](#)

\* \* \* \* \*

[Marathon: You Can Do It!](#)

By Jeff Galloway

In-depth information, planning, and training for anyone who wants to run a marathon, by Olympic running guru Jeff Galloway.



\$15.95

[Learn more](#)

[Chi Gung](#)

[Ancient Way to Keep Fit](#)

By Zong Wu & Li Mao

Our book on the internal martial arts from ancient China — Taoist exercises, including: Chi Gung, Taoist Yoga, Yijinjing, and self-massage. Beautifully illustrated.

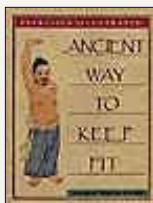

\$18.95

[Learn more](#)

[Posters](#)

[101 Stretches Poster](#)

By Bob Anderson

A large, beautiful four-color poster, laminated, with 2 brass grommets for hanging. Here are 101 stretches from the new revised edition of [Stretching](#). Put this on the wall as a reminder to take stretching breaks throughout the day. You'll feel better!



A fascinating, highly visual journey through the world of symmetry, with 550 photos and some 300 drawings. A valuable book for artists, illustrators, mathematicians, designers, engineers, students, and others interested in the poetry of form.

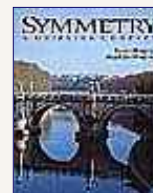

\$18.00

[Learn more](#)

[Getting Your Affairs in Order](#)

By Elmo Petterle

A unique workbook, a single place where you can document the many things that must be taken care of by your survivors after your death. A thoughtful, wonderful legacy for your loved ones.

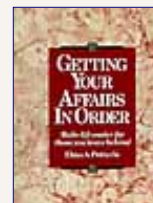

\$24.95

[Learn more](#)

[Grab Bag](#)

[On The Road](#)

Articles by Lloyd Kahn

“Wherever I travel, I shoot photos, take notes, sometimes interview people I run across. The world is a fascinating place and I invariably want to share my observations. When time allows, we put these stories up on the site.”

[Baja California](#)

News from Los Cabos, Baja California Sur, about ranchos, surfing, fishing, desert herbs, shipwrecks, sea serpents, small hotels...

[Surfing](#)

Perfect waves on a deserted island located off the west coast of Baja California.

[Kayaking](#)

Join Lloyd on an ocean kayak trip from his home thru the Golden Gate and into San Francisco.

[Lawyer Jokes](#)

From our book [Skid Marks](#).

[Grab Bag](#)

Subjects of a very diverse nature.

[Plus](#)

- [Who We Are](#)

\$13.95

[Learn more](#)

\* \* \* \* \*

### Stretch & Strengthen Poster

\$15.95

[Learn more](#)

## Shelter Fitness Re-Seller Program

Click [here](#) to find out how you can make money selling our fitness books and software.

- [The Birth of West Coast Publishing](#)
- [Catalog of Books](#)
- [Orders](#)
- [Foreign Translations](#)
- [Search](#)

## Ergonomic Software

*The same machine that causes the problem now contains the solution!*



Try a [FREE 30-DAY DEMO](#)

[StretchWare](#) is software that reminds you to stretch while working at your computer. Developed from the stretching exercises of Bob Anderson, author of our best-selling book *STRETCHING*.

[Learn more](#)

For a color catalog of our books and mail-order info, write:

Shelter Publications  
POB 279  
Bollinas, CA 94924

email: [orders@shelterpub.com](mailto:orders@shelterpub.com)

or call 800-307-0131.

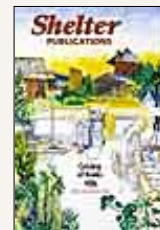

© Entire web site content copyright 2004  
by Shelter Publications, Inc. All rights reserved.

[Top of Page](#)

# The R. Buckminster Fuller FAQ

Christopher J. Fearnley, [cjf@CJFearnley.com](mailto:cjf@CJFearnley.com)

v.1.3.0, 10 May 1999

---

*This is the **Frequently Asked Questions and Answers (FAQ) Resource on R. Buckminster Fuller**. It is based primarily on the history of the discussions, interests, and needs of the readers of the BITNET mailing list *Geodesic* and its USENET gateway `bit.listserv.geodesic` (I will use the word `GEODESIC` or sometimes simply `the list` to refer to these two gatewayed discussion areas). So some of the information could be in error (especially addresses and phone numbers). Please send all errors and suggestions to the FAQ maintainer, Chris Fearnley ([cjf@CJFearnley.com](mailto:cjf@CJFearnley.com)).*

---

## 1. [Introduction](#)

## 2. [Synergetics](#)

- [2.1 What is a tetrahedron \(tetra\), octahedron \(octa\), and an icosahedron \(icosa\)?](#)
- [2.2 What is `synergy`?](#)
- [2.3 What is Fuller's definition of `Universe`?](#)
- [2.4 What is the `Isotropic Vector Matrix` \(IVM\)?](#)
- [2.5 What is an octet truss?](#)
- [2.6 What is the `vector equilibrium` \(VE\)?](#)
- [2.7 What is the `jitterbug`?](#)
- [2.8 What is a sphere?](#)
- [2.9 What is Fuller's concept of `space`?](#)
- [2.10 What is a `system`?](#)
- [2.11 What is the `minimal system`?](#)
- [2.12 What are the A and B quanta modules?](#)
- [2.13 What is the `omnidirectional halo`?](#)
- [2.14 What does Fuller mean by 4D?](#)
- [2.15 Does synergetics provide an extension or modification of the `scientific method`?](#)

- [2.16 Are there connections between synergetics and fullerenes \(besides the name, of course\)?](#)
- [2.17 Why use synergetics' conversion factors and other irrationals?](#)
- [2.18 What is ``precession?''](#)
- [2.19 What is the equation for finding the volume of a pyramid? \[ Steve Mather \]](#)
- [2.20 How to communicate synergetically?](#)
- [2.21 Modeling suggestions?](#)
- [2.22 What applications of synergetics are being discovered?](#)
- [2.23 Is it possible to develop an operational pi?](#)
- [2.24 What are Koski's and Kajikawa's modules?](#)
- [2.25 What is Richard Hawkins' curVE model?](#)
- [2.26 Fuller's \*Synergetics\* and Sex Identity.](#)
- [2.27 Tips for reading \*Synergetics\*.](#)

### **3. Fuller's Ideas About Human Society: Critical Path**

- [3.1 What is the Design Science Revolution?](#)
- [3.2 What is the ``cosmic accounting system?'' --- Fuller's Economics.](#)
- [3.3 What is the World Game?](#)
- [3.4 What were Fuller's views on religion and God?](#)
- [3.5 What is the Global Energy Grid idea?](#)
- [3.6 What is a ``trimtab?''](#)
- [3.7 Was Bucky a socialist?](#)
- [3.8 What were Fuller's views on Education?](#)
- [3.9 What is the difference between ``Class I'' and ``Class II'' evolution?](#)
- [3.10 How to house humanity? And other reflections on Making the World work.](#)
- [3.11 Was Bucky an ``optimist'' or a ``pessimist''?](#)
- [3.12 What about Fuller's plan for a nationless world?](#)

### **4. Geodesic Domes**

- [4.1 What is a geodesic dome?](#)
- [4.2 Dome Math: What you've all been waiting for!!!](#)

- [4.3 How to build a geodesic dome?](#)
- [4.4 Did Fuller invent the Dome?](#)
- [4.5 Dome References](#)

## **5. Other Inventions**

- [5.1 What is a tensegrity model?](#)
- [5.2 What are ``cloud nines?''](#)
- [5.3 What is ``dymaxion?''](#)
- [5.4 What was the ``Dymaxion Car?''](#)
- [5.5 What is a ``fog gun?''](#)
- [5.6 What was Fuller's ``floating city?''](#)
- [5.7 What was the Old Man's River City Project \(circular cities\)?](#)
- [5.8 What was the Dymaxion Deployment Unit?](#)
- [5.9 What is the Dymaxion Map?](#)
- [5.10 What was the Dymaxion House?](#)

## **6. Miscellany**

- [6.1 What are ``fullerenes" and ``buckyballs?''](#)
- [6.2 What is Biosphere II?](#)
- [6.3 What were Fuller's early years like?](#)
- [6.4 Was Fuller formally educated?](#)
- [6.5 Will there be a 1995 commemorative stamp marking Bucky's 100th birthday?](#)
- [6.6 Bibliography: Culled from many postings](#)
- [6.7 Organizations and Corporations mentioned on GEODESIC \(incomplete and dated\)](#)
- [6.8 Computer tools \(may or may not be useful to dome design or synergetics' modeling\).](#)
- [6.9 Fuller's ``failures."](#)
- [6.10 Where would you encourage your best friend to start in the Fuller literature? \(For maximum ease of mastery\) \[Jeff Perth\]](#)
- [6.11 Quotes and Coinages.](#)
- [6.12 Bucky: humanitarian or cold-hearted technocrat --- The value of a man?](#)
- [6.13 What was the nature of Fuller's involvement with Werner Erhardt, EST and the World Hunger Project? \[Lance Fletcher\]](#)

- [6.14 What were relations like between Fuller and his Students?](#)
- [6.15 What is GENESIS II?](#)
- [6.16 Could Fuller's proposed Very Large Structures work?](#)
- [6.17 Why did Fuller apply for patents?](#)
- [6.18 Is there a Bucky CD-ROM available?](#)
- [6.19 Why is overspecialization dangerous?](#)
- [6.20 Letters from Bucky to Mark A. Burginger.](#)

## **7. Net Resources**

- [7.1 The current version of the FAQ is on the Web](#)
- [7.2 Buckminsterfullerenes Update Service and Fullerene Bibliography](#)
- [7.3 List Geodesic: `geodesic@ubvm.bitnet`](#)
- [7.4 FIX \(Fuller Information eXchange\) BBS](#)
- [7.5 Other Fuller related mailing lists](#)
- [7.6 Web Resources](#)

---

[Next](#) [Previous](#) [Contents](#)



Biography



Sculpture



Panoramas



Computer Images

# Kenneth Snelson



Patents



Structure & Tensegrity



The Atom



Articles



# Main Page

From [Wikipedia](#), the free encyclopedia.

**Welcome** to [Wikipedia](#), an [open-content encyclopedia](#) in many languages. In [Other languages](#) this English edition, started in January 2001, we are working on [341469 articles](#). [Sister projects](#) Learn [how to edit pages](#), experiment in the [sandbox](#), and visit our [Community](#) [FAQ](#) [Portal](#) to find out how **you** can edit any article right now.

Browse : [Humanity](#) | [Culture](#) | [Politics](#) | [Natural science](#) | [Technology](#)

*[More categories](#) - [Article overviews](#) - [Alphabetical index](#)*

## Today's featured article



The [Warsaw Uprising](#) was an armed struggle during the [Second World War](#) by the [Polish Home Army](#) (Armia Krajowa) to liberate [Warsaw](#) from [German](#) occupation and [Nazi](#) rule. It started on [August 1, 1944](#) as a part of a nationwide [uprising](#), [Operation Tempest](#). The Polish troops resisted the German-led forces until [October 2](#). An estimated 85% of the city was destroyed during the urban [guerrilla](#) war and after the end of hostilities. The Uprising started at a crucial point in the war as the [Soviet](#) army was approaching Warsaw. Although the Soviet army was within a few hundred metres of the city from [September 16](#) onward, the link between the uprising and the advancing army was never made. This failure and the reasons behind it have been a matter of controversy ever since.

Recently featured: [Anno Domini](#) [PaX](#) [Behistun Inscription](#)

[Archive](#) [By email](#) [More featured articles](#)

## In the news



- [Hurricane Frances](#) moves across [Florida](#). [Insurance](#) claims for damages are estimated to be between US\$2 and \$10 billion. Up to three deaths have been reported in the [Bahamas](#), one in [Gainesville, Florida](#).
- [Izzat Ibrahim al-Douri](#), the "[King of Clubs](#)" and widely considered the right hand man of [Saddam Hussein](#), was reportedly captured in [Tikrit, Iraq](#).
- At least 350 die and hundreds are wounded as the [hostage crisis](#) in [Beslan, North Ossetia](#) ends in a series of explosions and gun battles.
- [Fire](#) destroys or severely damages more than 40,000 irreplaceable books and important collections of literature at the [Duchess Anna](#)

## Selected anniversaries

**September 6:** [Independence Day](#) in [Swaziland](#) (1968); [Labour Day](#) in [Canada](#) and the [U.S.A.](#) (2004)



- [1522](#) - The *Victoria*, carrying [Juan Sebastián Elcano](#) and 17 survivors of [Ferdinand Magellan](#)'s 265-man expedition, returned to [Sanlúcar de Barrameda](#), [Spain](#), becoming the first ship to [circumnavigate](#) the globe.
- [1901](#) - [U.S. President William McKinley](#) is fatally wounded by [anarchist Leon Czolgosz](#) at the [Pan-American Exposition](#) in [Buffalo, New York](#).
- [1972](#) - [Munich Massacre](#) : [Israeli](#) athletes and coaches were killed by [terrorists](#) known as '[Black September](#)' at the [Olympic Games](#).
- [1995](#) - [Baltimore Oriole shortstop Cal Ripken Jr.](#) played his 2131st consecutive professional [baseball](#) games, breaking the 56-year old record set by [New York Yankee first baseman Lou Gehrig](#).

Recent days: [September 5](#) [September 4](#) [September 3](#)

[Archive](#) [More historical anniversaries...](#)

[Amalia Library](#) in [Germany](#), a [UNESCO World Heritage Site](#).

[Recent deaths](#) [More current events...](#)

## Did you know...

From Wikipedia's [newest articles](#):



...that [Richard Blumenthal](#) is [Connecticut's Attorney General](#) and was awarded the [Raymond E. Baldwin Award for Public Service](#) by the [Quinnipiac University School of Law](#) in 2002?  
...that the [history of Buddhism](#) includes a century of [Greco-Buddhist](#) interaction, primarily around [Bactria](#)?  
...that as many as 150 people a year attempt to commit [suicide](#) by jumping from either the [Bosporus Bridge](#) or [Fatih Sultan Mehmet Bridge](#) in [Turkey](#)?  
...that the [Romanian riots](#) of [1989](#) led to the only bloody overthrow of a [Communist](#) regime in [Europe](#)?

[Archive](#) [Start a new article](#)

## Wikipedia in other languages

Wikipedias with over **10,000** articles:

[Dansk \(Danish\)](#) [Deutsch \(German\)](#) [Esperanto](#) [Español \(Spanish\)](#) [Français \(French\)](#) [Italiano \(Italian\)](#) [日本語 \(Japanese\)](#) [Nederlands \(Dutch\)](#) [Polska \(Polish\)](#) [Português \(Portuguese\)](#) [Svenska \(Swedish\)](#) [简体中文 \(Chinese, simplified\)](#) [繁體中文 \(Chinese, traditional\)](#)

Wikipedias with over **1000** articles:

[Afrikaans](#) [العربية \(Arabic\)](#) [Asturianu \(Asturian\)](#) [Български \(Bulgarian\)](#) [Català \(Catalan\)](#) [čeština \(Czech\)](#) [Cymraeg \(Welsh\)](#) [ελληνικά \(Greek\)](#) [Eesti \(Estonian\)](#) [Euskara \(Basque\)](#) [Suomeksi \(Finnish\)](#) [Frysk \(Western Frisian\)](#) [Galego \(Galician\)](#) [עברית \(Hebrew\)](#) [Hrvatski \(Croatian\)](#) [Magyar \(Hungarian\)](#) [Interlingua](#) [Bahasa Indonesia \(Indonesian\)](#) [Íslenska \(Icelandic\)](#) [한국어 \(Korean\)](#) [Latina \(Latin\)](#) [Bahasa Melayu \(Malay\)](#) [Norsk \(Norwegian\)](#) [Român \(Romanian\)](#) [Русский \(Russian\)](#) [Simple English](#) [Slovena ina \(Slovenian\)](#) [Српски \(Serbian\)](#) [Türkçe \(Turkish\)](#) [Українська \(Ukrainian\)](#) [Walon \(Walloon\)](#)

Wikipedias with over **100** articles:

[Беларуская \(Belarusian\)](#) [Bosanski \(Bosnian\)](#) [Kaszëbsczi \(Kashubian\)](#) [فارسی \(Persian\)](#) [Gaeilge \(Irish\)](#) [हिन्दी \(Hindi\)](#) [Ido](#) [Bahasa Jawa \(Javanese\)](#) [Kurdî \(Kurdish\)](#) [Lëtzebuergesch \(Luxembourgish\)](#) [Lietuvis \(Lithuanian\)](#) [Latviešu \(Latvian\)](#) [Bân-lâm-gú \(Southern Min\)](#) [Plattdüütsch \(Low Saxon\)](#) [Langua d'Oc \(Occitan\)](#) [संस्कृतम् \(Sanskrit\)](#) [Slovenina \(Slovak\)](#) [Basa Sunda \(Sundanese\)](#) [தமிழ் \(Tamil\)](#) [ไทย \(Thai\)](#) [Tatarça \(Tatar\)](#) [اردو \(Urdu\)](#) [Tiếng Việt \(Vietnamese\)](#)

[Complete list](#) [Multilingual coordination](#) [Start a Wikipedia in another language](#)

## Wikipedia's sister projects

Wikipedia is run by the non-profit [Wikimedia Foundation](#), which operates several other [multilingual](#) and [open-content](#) projects:



### [Wiktionary](#)

*A dictionary and thesaurus*

### [Wikibooks](#)

*Free textbooks and manuals*

### [Wikiquote](#)

*A collection of quotations*

### [Wikisource](#)

*Free source documents*

### [Meta-Wiki](#)

*Coordination of all Wikimedia projects*

If you find Wikipedia or its sister projects useful, please consider [making a donation](#). (<http://wikimediafoundation.org/fundraising>) Donations are used primarily for purchasing [server equipment](#).

Retrieved from "["http://en.wikipedia.org/wiki/Main\\_Page"](http://en.wikipedia.org/wiki/Main_Page)

## Views

- [Article](#)
- [Discussion](#)
- [View source](#)
- [History](#)

## Personal tools

- [Create an account or log in](#)

## Navigation

- [Main Page](#)
- [Community portal](#)
- [Current events](#)
- [Recent changes](#)
- [Random page](#)
- [Help](#)
- [Donations](#)

## Search

## Toolbox

- [What links here](#)
- [Related changes](#)
- [Special pages](#)

MediaWiki

GNU Free Documentation License

- This page was last modified 01:32, 5 Sep 2004.
- All text is available under the terms of the [GNU Free Documentation License](#) (see [Copyrights](#) for details).
- [About Wikipedia](#)
- [Disclaimers](#)

# July 12

From **Wikipedia**, the free encyclopedia.

**July 12** is the 193rd day (194th in [leap years](#)) of the year in the [Gregorian Calendar](#), with 172 days remaining.

|                                              |                                      |                             |                     |                    |                    |                    |
|----------------------------------------------|--------------------------------------|-----------------------------|---------------------|--------------------|--------------------|--------------------|
| <b>Contents</b>                              | <a href="#">Jun</a>                  | <b><a href="#">July</a></b> | <a href="#">Aug</a> |                    |                    |                    |
| <a href="#">§1</a> <a href="#">Events</a>    | <a href="#">Mo</a>                   | <a href="#">Tu</a>          | <a href="#">We</a>  | <a href="#">Th</a> | <a href="#">Fr</a> | <a href="#">Sa</a> |
| <a href="#">2</a> <a href="#">Births</a>     |                                      |                             |                     | <a href="#">1</a>  | <a href="#">2</a>  | <a href="#">3</a>  |
| <a href="#">3</a> <a href="#">Deaths</a>     | <a href="#">5</a>                    | <a href="#">6</a>           | <a href="#">7</a>   | <a href="#">8</a>  | <a href="#">9</a>  | <a href="#">10</a> |
| <a href="#">4</a> <a href="#">Holidays</a>   | <a href="#">12</a>                   | <a href="#">13</a>          | <a href="#">14</a>  | <a href="#">15</a> | <a href="#">16</a> | <a href="#">17</a> |
| <a href="#">ag</a> <a href="#">d</a>         | <a href="#">19</a>                   | <a href="#">20</a>          | <a href="#">21</a>  | <a href="#">22</a> | <a href="#">23</a> | <a href="#">24</a> |
| <a href="#">6</a> <a href="#">bservances</a> | <a href="#">26</a>                   | <a href="#">27</a>          | <a href="#">28</a>  | <a href="#">29</a> | <a href="#">30</a> | <a href="#">31</a> |
| <a href="#">[edit]</a>                       | <a href="#">2004</a> day arrangement |                             |                     |                    |                    |                    |
|                                              | <a href="#">All days</a>             |                             |                     |                    |                    |                    |

## Events

- **1690** - [William of Orange](#)'s army wins the [Battle of the Boyne](#) as reckoned under [Gregorian calendar](#).
- **1759** - [British](#) cannon start firing on [French](#) at [Quebec](#), from [Lévis, Quebec](#).
- **1812** - [Americans](#) invade [Canada](#) at [Windsor, Ontario](#).
- **1862** - [Medal of Honor](#) authorized by the [U.S. Congress](#).
- **1932** - [Lambeth Bridge](#), [London](#), opened by King [George V of the United Kingdom](#)
- **1933** - [Congress](#) passes the first federal minimum wage law in the [United States](#): 33 cents per hour.
- **1950** - [René Pleven](#) becomes Prime Minister of [France](#)
- **1967** - Four days of [race riots](#) begin in [Newark, New Jersey](#) that will claim the lives of 27 people.
- **1973** - The [1973 National Archives Fire](#) destroys the entire 6th floor of the [National Personnel Records Center](#)
- **1975** - [São Tomé and Príncipe](#) declare independence
- **1979** - The island nation of [Kiribati](#) declares independence
- **1993** - A [magnitude 7.8 earthquake](#) off the shore of [Hokkaido](#), [Japan](#) launches a devastating [tsunami](#), killing 202 on the small island of [Okushiri](#)
- **1998** - [KDE 1.0](#) released.
- **2002** - [Gay rights](#): The [Superior Court of Ontario](#) orders [Ontario](#) to recognize [same-sex marriages](#).
- **2004** - [Pedro Santana Lopes](#) is officially appointed [Prime Minister of Portugal](#).

[\[edit\]](#)

## Births

- **100 BC** - [Gaius Julius Caesar](#), soldier and politician
- **1468** - [Juan del Encina](#), poet and composer
- **1730** - [Josiah Wedgwood](#), potter

- [1807](#) - [Thomas Hawksley](#), [civil engineer](#) (d. [1893](#))
- [1817](#) - [Henry David Thoreau](#), writer, Transcendentalist philosopher (d. [1862](#))
- [1819](#) - [Charles Kingsley](#), writer
- [1849](#) - Sir [William Osler](#), physician, author, professor of medicine (d. [1919](#))
- [1852](#) - [Hipólito Yrigoyen](#), [President](#) of [Argentina](#) ([1916-1922](#), [1928-1930](#); d. [3 July 1933](#)).
- [1854](#) - [George Eastman](#), inventor of the Kodak camera (d. [1932](#))
- [1855](#) - [Edward 'Ned' Hanlan](#), world champion rower (d. [1908](#))
- [1861](#) - [George Washington Carver](#), botanist who discovered many uses for peanuts
- [1868](#) - [Stefan George](#), poet (d. [1933](#))
- [1870](#) - [Louis II of Monaco](#) (d. [1949](#))
- [1882](#) - [Tod Browning](#), film director (d. [1962](#))
- [1884](#) - [Amedeo Modigliani](#), painter and sculptor (d. [1920](#))
- [1886](#) - [Jean Hersholt](#), film director, actor (d. [1956](#))
- [1892](#) - [Bruno Schulz](#), [Polish](#) writer and painter (d. [1942](#))
- [1892](#) - [Harry Piel](#), actor, film director and producer (d. [1963](#))
- [1895](#) - [Oscar Hammerstein II](#), lyricist known for his work with [Richard Rodgers](#) on various musicals (d. [1960](#))
- 1895 - R. [Buckminster Fuller](#), American architect, (d. [1983](#))
- [1902](#) - [Günther Anders](#), philosopher and writer (d. [1992](#))
- [1904](#) - [Deng Xiaoping](#), Chinese politician and leader (d. [1997](#))
- [1904](#) - [Pablo Neruda](#), author, won [Nobel Prize](#) for [literature](#) in [1971](#), (d. [1973](#))
- [1908](#) - [Milton Berle](#), comedian (d. [2002](#))
- [1909](#) - [Joe DeRita](#), AKA "Curly Joe", former member of the [Three Stooges](#) (d. [1993](#))
- [1917](#) - [Andrew Wyeth](#),artist
- [1920](#) - [Beah Richards](#), actress (d. [2000](#))
- [1922](#) - [Mark Hatfield](#), former US Senator from [Oregon](#)
- [1930](#) - [Gordon Pinsent](#), actor, director, writer
- [1932](#) - [Otis Davis](#), American runner
- [1933](#) - [Donald E. Westlake](#), author
- [1934](#) - [Van Cliburn](#), pianist
- [1937](#) - [Bill Cosby](#), comedian, actor
- 1937 - [Lionel Jospin](#), [Prime Minister of France](#)
- [1943](#) - [Christine McVie](#), rock singer
- [1947](#) - [Gareth Edwards](#), former rugby player
- [1948](#) - [Richard Simmons](#), fitness trainer
- 1948 - [Nusrat Fateh Ali Khan](#), musician (d. [1997](#))
- [1964](#) - [Gaby Roslin](#), TV presenter

- [1967](#) - [Richard Herring](#), comedian
- [1971](#) - [Kristi Yamaguchi](#), figure skater
- [1976](#) - [Anna Friel](#), British actress
- [1977](#) - [Seann William Scott](#), actor
- [1984](#) - [Gareth Gates](#), British Singer
- [1991](#) - [Erik Per Sullivan](#), actor, *Malcolm in the Middle*

[\[edit\]](#)

## Deaths

- [1536](#) - [Erasmus of Rotterdam](#), Dutch writer and philosopher
- [1845](#) - [Henrik Wergeland](#), [Norwegian](#) author
- [1918](#) - [Dragutin Lerman](#), [Croatian](#) Africa explorer (b. [1864](#))
- [1919](#) - [Charles Rock](#), actor
- [1921](#) - [Ralph Herz](#), actor
- [1923](#) - [Harry Lonsdale](#), actor
- [1926](#) - [Gertrude Bell](#), archaeologist, writer, spy and administrator known as the "*Uncrowned Queen of Iraq*"
- [1935](#) - [Alfred Dreyfus](#), French military officer
- [1962](#) - [Roger Wolfe Kahn](#), band leader (b. [1907](#))
- [1988](#) - [Josh Logan](#), film director, writer
- [1996](#) - [John Chancellor](#), news anchor (*NBC Nightly News*) (b. [1927](#))
- [2003](#) - [Benny Carter](#), [musician](#)

[\[edit\]](#)

## Holidays and observances

- [Kiribati](#) - [Independence Day](#)
- [Mongolia](#) - [Naadam Holiday](#) (2nd day)
- [Northern Ireland](#) - [Battle of the Boyne](#) Day (see [Irish calendar](#)).
- [São Tomé and Príncipe](#) - [Independence Day](#)
- Sunset and sunrise occur along [Manhattan](#)'s street grid centerline

---

[July 11](#) - [July 13](#) - [June 12](#) - [August 12](#) -- [listing of all days](#)

[January](#) | [February](#) | [March](#) | [April](#) | [May](#) | [June](#) | [July](#) | [August](#) | [September](#) | [October](#) | [November](#) | [December](#)

Retrieved from "[http://en.wikipedia.org/wiki/July\\_12](http://en.wikipedia.org/wiki/July_12)"

**Categories:** [Days](#)

**Views**

- [Article](#)
- [Discussion](#)
- [Edit this page](#)
- [History](#)

#### Personal tools

- [Create an account or log in](#)

#### Navigation

- [Main Page](#)
- [Community portal](#)
- [Current events](#)
- [Recent changes](#)
- [Random page](#)
- [Help](#)
- [Donations](#)

#### Search

#### Toolbox

- [What links here](#)
- [Related changes](#)
- [Special pages](#)

#### In other languages

- [J;30@A:8](#)
- [esky](#)
- [Cymraeg](#)
- [Dansk](#)
- [Deutsch](#)
- [Esperanto](#)
- [Español](#)
- [Français](#)
- [âÑèÙê](#)
- [Italiano](#)
- [å,ž](#)
- [Lëtzebuergesch](#)
- [Nederlands](#)



- [Norsk](#)
- [Polski](#)
- [Português](#)
- [Slovenščina](#)
- [Svenska](#)
- [-†](#)

[MediaWiki](#)

[GNU Free Documentation License](#)

- This page was last modified 23:17, 5 Sep 2004.
- All text is available under the terms of the [GNU Free Documentation License](#) (see [Copyrights](#) for details).
- [About Wikipedia](#)
- [Disclaimers](#)

# 1895

From [Wikipedia](#), the free encyclopedia.

[[edit](#)]

## Events

- [January 5](#) - [Dreyfus Affair](#): [French](#) officer [Alfred Dreyfus](#) is stripped of his rank and sentenced to life imprisonment on [Devil's Island](#)
- [February 14](#) - First showing of [Oscar Wilde](#)'s last play *[The Importance of Being Earnest](#)* (St. James' Theatre in [London](#)).
- [March 1](#) - [William L. Wilson](#) is appointed [United States Postmaster General](#)
- [March 3](#) - In [Munich](#), [bicyclists](#) have to pass a test and display [license plates](#)
- [March 22](#) ? [Auguste](#) and [Louis Lumiere](#) display their first moving picture film in Paris ? it shows workers of their factory leaving for the lunch hour
- [April 6](#) - [Oscar Wilde](#) is arrested after losing a [libel](#) case against the [John Sholto Douglas, 9th Marquess of Queensberry](#).
- [April 14](#) - a major [earthquake](#) severely damages [Ljubljana](#), [Slovenia](#).
- [April 17](#) - The [Treaty of Maguan](#) (also as ?Treaty of Shimonoseki?) was signed between [China](#) and [Japan](#). This marks the end of the first [Sino-Japanese War](#), and the defeated [Qing Empire](#) is forced to renounce its claims on [Korea](#) and to concede the southern portion of the [Fengtien province](#), [Taiwan](#) and the [Pescadores Islands](#) to [Japan](#).
- [May 25](#) - Playwright, poet and novelist [Oscar Wilde](#) is convicted of "[sodomy](#) and gross indecency" and sentenced to serve two years in a [London](#) prison.
- [June 11](#) - [Britain](#) annexes [Togoland](#)
- [June 28](#) - Union of [Nicaragua](#), [Honduras](#) and [El Salvador](#) begins (ends in [1898](#))
- [August 19](#) - [American frontier](#) murderer and outlaw, [John Wesley Hardin](#), is killed by an off-duty policeman in a [saloon](#) in [El Paso, Texas](#).
- [August 29](#) - The sport of [rugby league](#) is formed at a meeting in the George Hotel, [Huddersfield](#), [England](#).

**Years:**

[1892](#) [1893](#) [1894](#) - **[1895](#)** - [1896](#) [1897](#) [1898](#)

**Decades:**

[1860s](#) [1870s](#) [1880s](#) - **[1890s](#)** - [1900s](#) [1910s](#) [1920s](#)

**Centuries:**

[18th century](#) - **[19th century](#)** - [20th century](#)

---

[1895 in art](#)

[1895 in film](#)

[1895 in literature](#)

[1895 in music](#)

[1895 in science](#)

[1895 in sports](#)

---

[List of state leaders in 1895](#)

[List of religious leaders in 1895](#)

- [September 3](#) - The first professional [football](#) game is played, in [Latrobe, Pennsylvania](#), between the Latrobe [YMCA](#) and the Jeannette Athletic Club. (Latrobe won the contest 12-0.).
- [November 5](#) - [George B. Selden](#) is granted the first U.S. [patent](#) for an [automobile](#).
- [November 8](#) - [Wilhelm Röntgen](#) discovers a type of [radiation](#) later known as [X-rays](#).
- [November 27](#) - At the Swedish-Norwegian Club in [Paris](#), [Alfred Nobel](#) signs his [last will and testament](#), setting aside his estate to establish the [Nobel Prize](#) after he dies (he died of a [cerebral hemorrhage](#) on [December 10, 1896](#)).
- [Konstantin Tsiolkovsky](#) proposes a [space elevator](#)
- Last major [earthquake](#) in the [New Madrid Fault Zone](#)
- [Grace Chisholm Young](#), the first woman awarded a doctorate at a German university

[\[edit\]](#)

## Births

- [January 1](#) - [J. Edgar Hoover](#), [FBI](#) director
- [January 20](#) - [George Burns](#), actor, comedian (d. [1996](#))
- [January 21](#) - [Cristobal Balenciaga](#), Spanish-French couturier (d. [1972](#))
- [January 24](#) - [Eugen Roth](#), lyricist and narrator (d. [1976](#))
- [January 30](#) - [Wilhelm Gustloff](#), Swiss Nazi party leader( d. [1936](#))
- [February 2](#) - [George Halas](#), [American football](#) player, coach, co-founder of the [National Football League](#) (d. [1983](#))
- [February 6](#) - [Babe Ruth](#), [Baseball Hall of Famer](#) (d. [1948](#))
- [February 8](#) - [King Vidor](#), director (d. [1982](#))
- [February 11](#) - [Viktor Nikolayevich Trambitsky](#), composer.
- [February 14](#) - [Max Horkheimer](#), philosopher and sociologist (d. [1973](#))
- [February 15](#) - [Earl Thomson](#), Canadian athlete
- [February 21](#) - [Henrik Carl Peter Dam Danish](#) biochemist, winner of the [1943 Nobel Prize in Physiology or Medicine](#) (d. [1976](#))
- [March 3](#) - [Matthew Ridgway](#), [Supreme Allied Commander](#) of [NATO](#), [United States Army Chief of Staff](#)
- [March 17](#) - [Shemp Howard](#), actor ("The [Three Stooges](#)") (d. [1955](#))
- [March 20](#) - [Robert Benoist](#), [Grand Prix motor racing](#) driver/war hero
- [March 29](#) - [Ernst Jünger](#), author (d. [1998](#))
- [March 30](#) - [Nikolai Bulganin](#), [Premier of the Soviet Union](#) (d. [1975](#))

- [April 1](#) - [Alberta Hunter](#), singer (d. [1984](#))
- [April 9](#) - [Mance Lipscomb](#), popular singer
- [April 15](#) - [Clark McConachy](#), [snooker](#) and [billiards](#) player
- [April 20](#) - [Emile Christian](#), [jazz](#) musician (d. [1973](#))
- [April 26](#) - [Nathaniel Kleitman](#), sleep researcher (d. [1999](#))
- [May 6](#) - [Rodolfo Valentino](#), [Italian actor](#)
- [May 8](#) - [Fulton J. Sheen](#), bishop, [television](#) personality (d. [1979](#))
- [May 9](#) - [Richard Bathelmess](#), actor (d. [1963](#))
- [July 10](#) - [Carl Orff](#), German [composer](#) (d. [1982](#))
- [July 12](#) - [Buckminster Fuller](#), American architect
- [July 25](#) - [Yvonne Printemps](#), singer and actress (d. [1977](#))
- [September 11](#) - [Vinoba Bhave](#)
- [September 28](#) - [Louis Pasteur](#), French chemist
- [October 2](#) - [Bud Abbott](#), actor
- [October 4](#) - [Buster Keaton](#), American [actor](#) and [film director](#)
- [October 8](#) - [Ahmet Zog](#), King of [Albania](#)
- [October 19](#) - [Lewis Mumford](#), historian
- [October 21](#) - [Edna Purviance](#), actress
- [October 25](#) - [Levi Eshkol](#), [Prime Minister of Israel](#) (d. [1969](#))
- [November 15](#) - [Antoni S Bonimski](#), [Polish poet](#) and writer (d. [1976](#))
- [November 16](#) - [Paul Hindemith](#), German [composer](#)
- [November 29](#) - [Busby Berkeley](#), film director, choreographer (d. [1976](#))
- [December 2](#) - [Harriet Cohen](#), pianist (d. [1967](#))
- [December 14](#) - King [George VI of the United Kingdom](#)
- [Tuanku Abdul Rahman ibni Almarhum Tuanku Muhammad](#), later [Yang di-Pertuan Besar](#) of [Negeri Sembilan](#) and 1st [Yang di-Pertuan Agong](#) of [Malaysia](#).

[[edit](#)]

## Deaths

- [January 9](#) [Aaron Lufkin Dennison](#) father of the [American System of Watch Manufacturing](#)
- [February 20](#) - [Frederick Douglass](#), ex-slave and author.
- [March 2](#) - [Berthe Morisot](#), [Impressionist Painter](#)
- [March 10](#) - [Charles Frederick Worth](#) couturier

- [May 19](#) - [José Martí](#), Cuban independence leader ([Dos Rios](#))
- [May 21](#) - [Franz von Suppé](#), composer
- [June 29](#) - Sir [Thomas Henry Huxley](#), English [biologist](#)
- [October 25](#) - [Charles Hallé](#), pianist and conductor
- [November 27](#) - [Alexandre Dumas, fils](#), author, playwright

Retrieved from "<http://en.wikipedia.org/wiki/1895>"

[Categories](#): [1895](#)

## Views

- [Article](#)
- [Discussion](#)
- [Edit this page](#)
- [History](#)

## Personal tools

- [Create an account or log in](#)

## Navigation

- [Main Page](#)
- [Community portal](#)
- [Current events](#)
- [Recent changes](#)
- [Random page](#)
- [Help](#)
- [Donations](#)

## Search

## Toolbox

- [What links here](#)
- [Related changes](#)
- [Special pages](#)

## In other languages

- [Afrikaans](#)
- [J;30@A:8](#)
- [Català](#)
- [Dansk](#)
- [Deutsch](#)
- [Español](#)
- [Esperanto](#)
- [Français](#)
- [Interlingua](#)
- [Italiano](#)
- [Nederlands](#)
- [Polski](#)
- [Român](#)
- [Slovenščina](#)
- [!@?A:8 / Srpski](#)
- [Suomi](#)
- [Svenska](#)

[MediaWiki](#)

[GNU Free Documentation License](#)

- This page was last modified 09:01, 11 Aug 2004.
- All text is available under the terms of the [GNU Free Documentation License](#) (see [Copyrights](#) for details).
- [About Wikipedia](#)
- [Disclaimers](#)

# July 1

From **Wikipedia**, the free encyclopedia.

**July 1** is the 182nd day of the year (183rd in [leap years](#)) in the [Gregorian Calendar](#), with 183 days remaining.

|                                                                                                                                                                                                       |                                      |                             |                     |                    |                    |                    |
|-------------------------------------------------------------------------------------------------------------------------------------------------------------------------------------------------------|--------------------------------------|-----------------------------|---------------------|--------------------|--------------------|--------------------|
| <b>Contents</b>                                                                                                                                                                                       | <a href="#">Jun</a>                  | <b><a href="#">July</a></b> | <a href="#">Aug</a> |                    |                    |                    |
| <a href="#">§1</a> <a href="#">Events</a>                                                                                                                                                             | <a href="#">Mo</a>                   | <a href="#">Tu</a>          | <a href="#">We</a>  | <a href="#">Th</a> | <a href="#">Fr</a> | <a href="#">Sa</a> |
| <a href="#">2</a> <a href="#">Births</a>                                                                                                                                                              |                                      |                             |                     | <b>1</b>           | <a href="#">2</a>  | <a href="#">3</a>  |
| <a href="#">3</a> <a href="#">Deaths</a>                                                                                                                                                              | <a href="#">5</a>                    | <a href="#">6</a>           | <a href="#">7</a>   | <a href="#">8</a>  | <a href="#">9</a>  | <a href="#">10</a> |
| <a href="#">4</a> <a href="#">Holidays</a>                                                                                                                                                            | <a href="#">12</a>                   | <a href="#">13</a>          | <a href="#">14</a>  | <a href="#">15</a> | <a href="#">16</a> | <a href="#">17</a> |
| <a href="#">ag</a> <a href="#">d</a>                                                                                                                                                                  | <a href="#">19</a>                   | <a href="#">20</a>          | <a href="#">21</a>  | <a href="#">22</a> | <a href="#">23</a> | <a href="#">24</a> |
| <a href="#">o</a> <a href="#">b</a> <a href="#">s</a> <a href="#">e</a> <a href="#">r</a> <a href="#">v</a> <a href="#">a</a> <a href="#">n</a> <a href="#">c</a> <a href="#">e</a> <a href="#">s</a> | <a href="#">26</a>                   | <a href="#">27</a>          | <a href="#">28</a>  | <a href="#">29</a> | <a href="#">30</a> | <a href="#">31</a> |
| <a href="#">[edit]</a>                                                                                                                                                                                | <a href="#">2004</a> day arrangement |                             |                     |                    |                    |                    |
|                                                                                                                                                                                                       | <a href="#">All days</a>             |                             |                     |                    |                    |                    |

## Events

- **1097** - [Battle of Dorylaeum](#) [Crusaders](#) under [Bohemond of Taranto](#) defeat a Turkish army under Qilich Arslan I.
- **1690** - [Battle of the Boyne](#) as reckoned under [Julian calendar](#).
- **1782** - [American privateers](#) attack [Lunenburg Nova Scotia](#).
- **1858** - The joint reading of [Charles Darwin](#) and [Alfred Russel Wallace](#)'s papers on [evolution](#) to the [Linnean Society](#).
- **1863** - [Battle of Gettysburg](#) in the [American Civil War](#) begins.
- **1867** - The [British North America Act](#) takes effect as the constitution of [Canada](#), creating the [Canadian Confederation](#); [John A. Macdonald](#) sworn as first Prime Minister.
- **1870** - The [United States Department of Justice](#) formally comes into existence.
- **1873** - [Prince Edward Island](#) joins the [Canadian Confederation](#).
- **1878** - Canada joins [Universal Postal Union](#).
- **1881** - World's first international telephone call, between [St. Stephen, New Brunswick](#) and [Calais, Maine](#).
- **1885** - [United States](#) terminates reciprocity and fishery agreement with [Canada](#).
- **1890** - [Canada](#) and [Bermuda](#) linked by [telegraph](#) cable.
- **1904** - [Games of the III Olympiad](#) open in [Saint Louis, Missouri](#).
- **1916** - First day of the [First Battle of the Somme](#). On this first day, 20,000 soldiers of the British Army are killed, and 40,000 wounded. Lasts until November; about one million casualties.
- **1931** - Official opening of [Milan Central Station](#).
- **1923** - [Canadian Parliament](#) suspends all Chinese immigration.
- **1935** - [Regina, Saskatchewan](#) police and [Royal Canadian Mounted Police](#) ambush strikers participating in [On-to-Ottawa-Trek](#).
- **1947** - The Australian real estate franchise [L. J. Hooker](#) lists on the [Australian Stock Exchange](#)

- **1948** - Official opening of New York International Airport (now known as [John F. Kennedy International Airport](#)) at Idlewild.
- **1957** - The [International Geophysical Year](#) begins (until [December 31, 1958](#)).
- **1958** - The [Canadian Broadcasting Corporation](#) links [television](#) broadcasting across [Canada](#) via microwave.
- **1962** - Independence of [Rwanda](#).
- **1962** - Independence of [Burundi](#).
- **1963** - [Zip code](#) introduced for United States mail.
- **1963** - The British Government admits that former diplomat [Kim Philby](#) had worked as a [Soviet](#) agent.
- **1966** - First colour television transmission in Canada, from [Toronto](#).
- **1967** - The [European Community](#) is formally created out of a merger with the [Common Market](#), the [European Coal and Steel Community](#), and the [European Atomic Energy Commission](#).
- **1968** - Nuclear non-proliferation treaty signed by about sixty countries in [Geneva](#), [Switzerland](#).
- **1968** - Formal separation of the [United Auto Workers](#) with the [AFL-CIO](#).
- **1972** - [Andreas Baader](#), [Jan-Carl Raspe](#) and [Holger Meins](#) of the [Red Army Faction](#) are captured in [Frankfurt](#) after a shootout with the [police](#).
- **1979** - [Sony](#) introduces the [Walkman](#).
- **1980** - *[O Canada](#)* officially becomes the [national anthem](#) of [Canada](#).
- **1986** - In an interview with *[Playboy](#)* magazine, [science fiction](#) writer [Arthur C. Clarke](#) comes out as a bisexual.
- **1987** - Excavation begins on the [Channel Tunnel](#).
- **1990** - [East Germany](#) accepts the [deutsche mark](#) as its currency, thus uniting the economies of East and [West Germany](#).
- **1991** - The [Warsaw Pact](#) is officially dissolved.
- **1997** - The [United Kingdom](#) hands [sovereignty](#) over [Hong Kong](#) to the [People's Republic of China](#).
- **1999** - First opening of the [Scottish](#) parliament in nearly three centuries.
- **2000** - [Vermont](#)'s [civil unions](#) law goes into effect.
- **2002** - A Bashkirian Airlines [Tupolev](#) TU-154 and a [DHL](#) (German cargo) [Boeing 757](#) collide in mid-air over southern Germany, killing 71.
- **2003** - 500,000 people take part in a march in [Hong Kong](#) to protest, amongst other things, the government's handling of the plans to implement a new anti-subversion law required under [Article 23](#) of [Hong Kong's Basic Law](#).
- **2004** - Saturn Orbit Insertion of [Cassini-Huygens](#) begins at 01:12 [UT](#) and ends at 02:48 [UT](#).

[\[edit\]](#)

## Births

- **1646** - [Gottfried Wilhelm Leibniz](#), mathematician, philosopher (d. [1716](#))
- **1804** - [George Sand](#) (Amantine Aurore Lucile Dupin), writer (d. [1876](#))
- **1863** - [William Stairs](#), Victorian explorer (d. [1892](#))



- [1872](#) - [Louis Blériot](#), first man to fly across the [English Channel](#) (d. [1936](#))
- [1899](#) - [Charles Laughton](#), [Academy Award](#) winning actor (d. [1962](#))
- [1899](#) - [Thomas A. Dorsey](#), father of [gospel music](#) (d. [1993](#))
- [1902](#) - [William Wyler](#), three-time [Academy Award](#) winning director (d. [1981](#))
- [1903](#) - [Amy Johnson](#), aviator (d. [1941](#))
- [1906](#) - [Estée Lauder](#), [cosmetics](#) pioneer (d. [2004](#))
- [1909](#) - [Bill Stern](#), sportscaster
- [1912](#) - [David R. Brower](#), founder of many environmentalist organizations (d. [2000](#))
- [1916](#) - [Olivia de Havilland](#), actress
- [1917](#) - [Rolf Rodenstock](#), industrialist (d. [1977](#))
- [1930](#) - [Bobby Day](#), singer (d. [1990](#))
- [1931](#) - [Leslie Caron](#), actress
- [1934](#) - [Jean Marsh](#), actress, originator of *[Upstairs, Downstairs](#)*
- [1934](#) - [Sydney Pollack](#), film director, producer, actor
- [1934](#) - [Jamie Farr](#), actor
- [1941](#) - [Twyla Tharpe](#), choreographer
- [1942](#) - [Andraé Crouch](#), singer, conductor, actor
- [1942](#) - [Geneviève Bujold](#), actor
- [1945](#) - [Deborah Harry](#), musician, [Blondie](#)
- [1946](#) - [June Montiero](#), singer formerly of the group the [Toys](#)
- [1951](#) - [Fred Schneider](#), keyboardist, [The B-52s](#)
- [1952](#) - [Dan Aykroyd](#), actor
- [1960](#) - [Evelyn King](#), singer
- [1961](#) - [Diana, Princess of Wales](#), (d. [1997](#))
- [1961](#) - [Carl Lewis](#), [American athletics](#) legend, nine-time [Olympic](#) gold medalist
- [1961](#) - [Michelle Wright](#), singer/guitarist, songwriter, drummer
- [1965](#) - [Harald Zwart](#), [Norwegian film director](#)
- [1967](#) - [Pamela Anderson](#), actress
- [1971](#) - [Missy "Misdemeanor" Elliott](#), [hip hop](#) artist
- [1972](#) - [Claire Forlani](#), actress
- [1976](#) - [Patrick Kluivert](#), [Dutch football](#) player
- [1976](#) - [Ruud van Nistelrooy](#), [Dutch football](#) player
- [1977](#) - [Jarome Iginla](#), [NHL hockey](#) player
- [1977](#) - [Liv Tyler](#), actress

[\[edit\]](#)

# Deaths

- [868](#) - [Ali al-Hadi](#), [Shia Imam](#)
- [1277](#) - [Baibars](#), [Mameluk sultan](#) of [Egypt](#)
- [1566](#) - [Nostradamus](#)
- [1894](#) - [Allan Pinkerton](#), founder [Pinkerton Agency](#)
- [1896](#) - [Harriet Beecher Stowe](#), author
- [1925](#) - [Erik Satie](#), [French composer](#)
- [1950](#) - [Eliel Saarinen](#), architect, father of [Eero Saarinen](#) (b. [1873](#))
- [1964](#) - [Pierre Monteux](#), conductor
- [1965](#) - [Wally Hammond](#), cricketer
- [1974](#) - [Juan Domingo Perón](#), President of [Argentina](#) (b. [1895](#))
- [1983](#) - [R. Buckminster Fuller](#), architect, philosopher
- [1984](#) - [Moshe Feldenkrais](#), founder of the [Feldenkrais Method](#)
- [1991](#) - [Michael Landon](#), actor, director, producer (b. [1936](#))
- [1995](#) - [Wolfman Jack](#), [radio](#) personality (b. [1939](#))
- [1997](#) - [Robert Mitchum](#), actor
- [1999](#) - [Edward Dmytryk](#), director
- 1999 - [Forrest Mars Sr.](#), founder of the Mars company
- [2000](#) - [Walter Matthau](#), [American actor](#)
- [2003](#) - [Herbie Mann](#), jazz flautist
- 2003 - [N!xau](#), [Namibian](#) bushman who appeared in *[The Gods Must Be Crazy](#)* (b. [1944?](#))
- [2004](#) - [Marlon Brando](#), actor

[\[edit\]](#)

## Holidays and observances

- [Canada Day](#) (formerly Dominion Day) - national holiday of [Canada](#)
- [Hong Kong Special Administrative Region](#) Establishment Day
- [World Architecture Day](#)

---

[June 30](#) - [July 2](#) - [June 1](#) - [August 1](#) -- [listing of all days](#)

[January](#) | [February](#) | [March](#) | [April](#) | [May](#) | [June](#) | [July](#) | [August](#) | [September](#) | [October](#) | [November](#) | [December](#)

Retrieved from "[http://en.wikipedia.org/wiki/July\\_1](http://en.wikipedia.org/wiki/July_1)"

**Categories:** [Days](#)

## Views

- [Article](#)
- [Discussion](#)
- [Edit this page](#)
- [History](#)

## Personal tools

- [Create an account or log in](#)

## Navigation

- [Main Page](#)
- [Community portal](#)
- [Current events](#)
- [Recent changes](#)
- [Random page](#)
- [Help](#)
- [Donations](#)

## Search

## Toolbox

- [What links here](#)
- [Related changes](#)
- [Special pages](#)

## In other languages

- [J;30@A:8](#)
- [Català](#)
- [Cymraeg](#)
- [Dansk](#)
- [Deutsch](#)
- [Esperanto](#)
- [Español](#)
- [Français](#)
- [ânĚÙĕ](#)
- [Italiano](#)

- [å,ž](#)
- [Lëtzebuergesch](#)
- [Nederlands](#)
- [Norsk](#)
- [Polski](#)
- [Português](#)
- [Slovenščina](#)
- [Svenska](#)
- [-†](#)

[MediaWiki](#)

[GNU Free Documentation License](#)

- This page was last modified 11:57, 1 Sep 2004.
- All text is available under the terms of the [GNU Free Documentation License](#) (see [Copyrights](#) for details).
- [About Wikipedia](#)
- [Disclaimers](#)

# 1983

From [Wikipedia](#), the free encyclopedia.

## Contents

### [1 Events](#)

[1.1 January 1983](#)

[1.2 February 1983](#)

[1.3 March 1983](#)

[1.4 April 1983](#)

[1.5 May 1983](#)

[1.6 June 1983](#)

[1.7 July 1983](#)

[1.8 August 1983](#)

[1.9 September 1983](#)

[1.10 October 1983](#)

[1.11 November 1983](#)

[1.12 unknown dates](#)

### [2 Year in topic](#)

### [3 Births](#)

[3.1 January 1983](#)

[3.2 March 1983](#)

[3.3 April 1983](#)

[3.4 May 1983](#)

[3.5 June 1983](#)

[3.6 July 1983](#)

[3.7 September 1983](#)

[3.8 October 1983](#)

[3.9 November 1983](#)

### [4 Deaths](#)

[4.1 January 1983](#)

[4.2 February 1983](#)

[4.3 March 1983](#)

[4.4 April 1983](#)

[4.5 May 1983](#)

[4.6 June 1983](#)

### **Years:**

[1980](#) [1981](#) [1982](#) - **[1983](#)** - [1984](#) [1985](#) [1986](#)

### **Decades:**

[1950s](#) [1960s](#) [1970s](#) - **[1980s](#)** - [1990s](#) [2000s](#) [2010s](#)

### **Centuries:**

[19th century](#) - **[20th century](#)** - [21st century](#)

---

[1983 in architecture](#)

[1983 in aviation](#)

[1983 in film](#)

[1983 in literature](#)

[1983 in music](#)

[1983 in sports](#)

[1983 in television](#)

[1983 in Canada](#)

[4.7 July 1983](#)

[4.8 August 1983](#)

[4.9 September 1983](#)

[4.10 October 1983](#)

[4.11 November 1983](#)

[4.12 December 1983](#)

[5 Nobel Prizes](#)

[6 Fictional References to the Year](#)

[\[edit\]](#)

## Events

[\[edit\]](#)

### January 1983

- [Saturday, January 1, 1983](#) - [Beat Raaflaub](#) became [Basel Boys Choir](#)'s new [conductor](#)
- [Saturday, January 1, 1983](#) - the [ARPANET](#) officially changes to use the [Internet Protocol](#), creating the [Internet](#).
- [Saturday, January 1, 1983](#) - compulsory wearing of [seat belts](#) becomes law in the [UK](#).
- [Sunday, January 2, 1983](#) - The musical *[Annie](#)* is performed for the last time after 2,377 shows ([Uris Theatre](#) on Broadway, New York City).
- [Wednesday, January 19, 1983](#) - [Klaus Barbie](#), [Nazi war criminal](#), is arrested in [Bolivia](#).
- [Wednesday, January 19, 1983](#) - The [Apple Lisa personal computer](#) is announced.
- [Saturday, January 22, 1983](#) - [Björn Borg](#) retires from [tennis](#) after winning 5 consecutive [Wimbledon championships](#).
- [Wednesday, January 26, 1983](#) - [Lotus 1-2-3](#) is released.

[\[edit\]](#)

### February 1983

- [Wednesday, February 16, 1983](#) - The [Ash Wednesday](#) bushfires in [Victoria](#) and [South Australia](#) claim the lives of 71 people in [Australia's](#) worst ever fires.
- [Wednesday, February 23, 1983](#) - The [Environmental Protection Agency](#) announces its intent to buy out and evacuate the [dioxin](#)-contaminated community of [Times Beach, Missouri](#).
- [Thursday, February 24, 1983](#) - A special commission of the [United States Congress](#) releases a report critical of the practice of [Japanese internment](#) during [World War II](#).

[[edit](#)]

## March 1983

- [Tuesday, March 1, 1983](#) - [Balearic Islands](#) and [Madrid](#) become [autonomous communities](#) of [Spain](#)
- [Tuesday, March 1, 1983](#) - [Swatch](#) introduce their first timepieces
- [Tuesday, March 1, 1983](#) - [Duran Duran](#)'s album *[Rio](#)* goes gold
- [Tuesday, March 8, 1983](#) - [President Ronald Wilson Reagan](#) calls the [Soviet Union](#) an "[evil empire](#)."
- [Wednesday, March 23, 1983](#) - [Strategic Defense Initiative](#): [President Ronald Reagan](#) makes his initial proposal to develop technology to intercept enemy missiles. The media dub this plan "[Star Wars](#)."
- [Friday, March 25, 1983](#) - [Pop](#) singer [Michael Jackson](#) performs his [Moonwalk](#) dance maneuver for the first time during his performance of [Billie Jean](#) on the [Motown](#) 25 TV special, which would air nationally on [NBC](#) on [May 16](#)

[[edit](#)]

## April 1983

- [Thursday, April 7, 1983](#) - During [STS-6](#), astronauts [Story Musgrave](#) and [Don Peterson](#) perform the first [space shuttle](#) spacewalk (duration: 4 hours, 10 minutes).
- [Friday, April 15, 1983](#) - American Public Radio founded; changes its name to the current [Public Radio International](#) in [1994](#)
- [Monday, April 18, 1983](#) - The U.S Embassy is bombed in [Beirut](#), killing 63 people.
- [Monday, April 25, 1983](#) - [Maine](#) schoolgirl [Samantha Smith](#) is invited to visit the [Soviet Union](#) by its leader [Yuri Andropov](#) after he read her letter in which she expressed fears about [nuclear war](#).

[[edit](#)]

## May 1983

- [Tuesday, May 17, 1983](#) - [Lebanon](#), [Israel](#), and the [United States](#) sign an agreement on Israeli withdrawal from Lebanon.

[[edit](#)]

## June 1983

- [Monday, June 13, 1983](#) - [Pioneer 10](#) becomes the first manmade object to leave the [solar system](#). [\[1\]](#) (*http://quest.nasa.gov/sso/cool/pioneer10/mission/*)
- [Saturday, June 18, 1983](#) - [Sally Ride](#) becomes first American woman in space on the [Space Shuttle Challenger](#).
- [Monday, June 27, 1983](#) - The [Internet Domain Name System](#) was invented by [Paul Mockapetris](#).

[\[edit\]](#)

## July 1983

- [Thursday, July 7, 1983](#) - [Samantha Smith](#) flies to the [Soviet Union](#) (see [Monday, April 25, 1983](#)).
- [Saturday, July 23, 1983](#) - [Gimli Glider](#): [Air Canada](#) flight 143 crash-lands in [Gimli, Manitoba](#).

[\[edit\]](#)

## August 1983

- [Thursday, August 4, 1983](#) - [Thomas Sankara](#) become President in [Upper Volta](#).
- [Thursday, August 18, 1983](#) - [Hurricane Alicia](#) hits the [Texas](#) coast, killing 22 and causing over US\$1 billion in damage (1983 dollars).
- [Sunday, August 21, 1983](#) - [Benigno Aquino, Jr.](#), [Philippines](#) opposition leader, assassinated in [Manila](#).

[\[edit\]](#)

## September 1983

- [Thursday, September 1, 1983](#) - [Cold War](#): [Korean Air Flight KAL-007](#) is shot down by a [Soviet](#) jet fighter when the commercial aircraft entered Soviet airspace. All 269 on board die.
- [Tuesday, September 6, 1983](#) - The [Soviet Union](#) admits to shooting down [Korean Air Flight KAL-007](#), stating that the pilots did not know it was a civilian [aircraft](#) when it violated Soviet airspace.
- [Monday, September 26, 1983](#) - Soviet military officer [Stanislav Petrov](#) averts a worldwide nuclear war

[\[edit\]](#)



## October 1983

- [Wednesday, October 12, 1983](#) - [Japan](#)'s ex Prime Minister [Tanaka Kakuei](#) found guilty of taking a \$2 million bribe from [Lockheed](#) and sentenced to [4 years](#) in jail.
- [Sunday, October 23, 1983](#) - [United States Marine Corps](#) barracks in [Beirut](#) destroyed by suicide bomber, killing 241.
- [Tuesday, October 25, 1983](#) - [United States](#) invades [Grenada](#).
- [Thursday, October 27, 1983](#) - [Pope John Paul II](#) visits [Mehmet Ali Agca](#) in prison to forgive him. Ali Agca is a [Turkish](#) gunman, who attempted to kill Pope John Paul II in [1981](#).
- [Sunday, October 30, 1983](#) - The first democratic elections in [Argentina](#) after [seven years](#) of military rule are held.

[[edit](#)]

## November 1983

- [Wednesday, November 2, 1983](#) - [Martin Luther King Day](#): At the [White House](#) Rose Garden, [US President Ronald Wilson Reagan](#) signs a bill creating a federal holiday on the third [Monday](#) of every [January](#) to honor [American civil rights](#) leader [Martin Luther King Jr.](#)
- [Thursday, November 17, 1983](#) - The [Zapatista Army of National Liberation](#) founded.
- [Saturday, November 26, 1983](#) - [Brinks Mat robbery](#): In [London](#), 6,800 [gold](#) bars worth nearly UK£26 million are taken from the [Brinks Mat](#) vault at [Heathrow Airport](#) (only a fraction of the gold was ever recovered, and only two men were convicted of the crime)<sup>[2]</sup> (<http://www.bbc.co.uk/crime/caseclosed/brinksmat.shtml>).

[[edit](#)]

## unknown dates

- Democratic reform in power in [Argentina](#).
- [IBM](#) announces the [IBM PC XT](#)
- [McDonald's](#) introduces the [McNugget](#)

[[edit](#)]

## Year in topic

- [1983 in film](#)
  - [Wednesday, May 25, 1983](#) - *[Return of the Jedi](#)*
  - [Wednesday, November 23, 1983](#) - *[Terms of Endearment](#)*
  - *[The Big Chill](#)*

- *[The Right Stuff](#)*
- [1983 in literature](#)
- [1983 in music](#)
- [1983 in sports](#)
  - [Sunday, March 6, 1983](#) - The [United States Football League](#) begins its first year of competition
- [1983 in television](#)
  - [Monday, February 28, 1983](#) - Over 125 million [Americans](#) tune in to watch the final episode of *[M\\*A\\*S\\*H](#)*
  - [Monday, March 7, 1983](#) - [The Nashville Network](#) (TNN) begins broadcasting.

[[edit](#)]

## Births

[[edit](#)]

### January 1983

- [Tuesday, January 18, 1983](#) - [Utada Hikaru](#), [Japanese-American](#) R&B singer

[[edit](#)]

### March 1983

- [Monday, March 14, 1983](#) - [Taylor Hanson](#), musician

[[edit](#)]

### April 1983

- [Friday, April 15, 1983](#) - [Ilya Kovalchuk](#), [Russian NHL](#) player
- [Sunday, April 17, 1983](#) - [Miguel Cabrera](#), [Major League Baseball All-Star](#)

[[edit](#)]

### May 1983

- [Monday, May 2, 1983](#) - [Rose Falcon](#), actress/singer
- [Friday, May 27, 1983](#) - [Bobby Convey](#), [American](#) soccer player

[[edit](#)]

## June 1983

- [Monday, June 6, 1983](#) - [Joe Rokocoko](#), [New Zealand rugby](#) player
- [Tuesday, June 21, 1983](#) - [Nadia Yvonne Lopez Ayuna](#), [Mexican](#) singer ([La Academia](#) contestant)

[[edit](#)]

## July 1983

- [Saturday, July 2, 1983](#) - [Michelle Branch](#), pop singer
- [Monday, July 11, 1983](#) - [Marie Eleonor Sernehlot](#), oldest of the [A-Teens](#)

[[edit](#)]

## September 1983

- [Saturday, September 17, 1983](#) - [Jennifer Peña](#), [Tejano](#) singer

[[edit](#)]

## October 1983

- [Saturday, October 29, 1983](#) - [Amit Sebastian Paul](#), member of [A-Teens](#)

[[edit](#)]

## November 1983

- [Friday, November 18, 1983](#) - [Jon Johansen](#), [programmer](#)

[[edit](#)]

## Deaths

[[edit](#)]

## January 1983

- [Tuesday, January 11, 1983](#) - [Shri Ghanshyam Das Birla](#), [Indian](#) industrialist, Gandhian and educationist
- [Saturday, January 15, 1983](#) - [Meyer Lansky](#), mobster
- [Sunday, January 23, 1983](#) - [George Cukor](#), director
- [Friday, January 28, 1983](#) - [Frank Forde](#), fifteenth [Prime Minister of Australia](#)

[[edit](#)]

## February 1983

- [Friday, February 4, 1983](#) - [Karen Carpenter](#), singer, dies of [anorexia nervosa](#)
- [Saturday, February 12, 1983](#) - [Eubie Blake](#), musician, songwriter
- [Monday, February 14, 1983](#) - [Lina Radke](#), [German](#) athlete
- [Friday, February 25, 1983](#) - [Tennessee Williams](#), playwright

[[edit](#)]

## March 1983

- [Thursday, March 3, 1983](#) - [Hergé](#), [Belgian comics](#) creator
- [Tuesday, March 8, 1983](#) - [William Walton](#), composer
- [Tuesday, March 15, 1983](#) - [Rebecca West](#), writer
- [Wednesday, March 23, 1983](#) - [Barney Clark](#), first [artificial heart](#) recipient

[[edit](#)]

## April 1983

- [Monday, April 4, 1983](#) - [Gloria Swanson](#), actress
- [Friday, April 22, 1983](#) - [Earl 'Fatha' Hines](#), musician (b. [1903](#))

[[edit](#)]

## May 1983

- [Wednesday, May 18, 1983](#) - [Frank Aiken](#), [Irish](#) Foreign Minister ([1959-1969](#))
- [Thursday, May 19, 1983](#) - [Jean Rey](#), [President of the European Commission](#)

[[edit](#)]

## June 1983

- [Thursday, June 2, 1983](#) - [Stan Rogers](#), [Canadian](#) musician
- [Sunday, June 12, 1983](#) - [Norma Shearer](#), [Academy Award](#) winning actress
- [Saturday, June 18, 1983](#) - [Marianne Brandt](#), industrial designer and [Bauhaus](#) participant

[[edit](#)]

## July 1983

- [Friday, July 1, 1983](#) - [Buckminster Fuller](#), [American](#) architect
- [Thursday, July 7, 1983](#) - [Vicki Morgan](#), [fashion model](#)
- [Saturday, July 23, 1983](#) - [Georges Auric](#), composer, member of *[Les Six](#)*
- [Friday, July 29, 1983](#) - [Raymond Massey](#), actor

[[edit](#)]

## August 1983

- [Tuesday, August 16, 1983](#) - [Earl Averill](#), [Baseball Hall of Famer](#) (b. [1902](#))
- [Sunday, August 21, 1983](#) - [Benigno Aquino Jr.](#), [Philippine](#) opposition leader

[[edit](#)]

## September 1983

- [Sunday, September 25, 1983](#) - [Leopold III of Belgium](#)
- [Monday, September 26, 1983](#) - [Tino Rossi](#), Corsican singer

[[edit](#)]

## October 1983

- [Thursday, October 6, 1983](#) - [Terence Cardinal Cooke](#), tenth bishop (seventh archbishop) of the [Roman Catholic](#) diocese of [New York](#) (b. [1921](#))
- [Friday, October 28, 1983](#) - [Otto Messmer](#), creator of [Felix the Cat](#)

[[edit](#)]

## November 1983

- [Monday, November 7, 1983](#) - [Germaine Tailleferre](#), composer

[[edit](#)]

## December 1983

- [Friday, December 2, 1983](#) - [Fifi D'Orsay](#), actress
- [Tuesday, December 6, 1983](#) - [Lucienne Boyer](#), [French](#) singer
- [Sunday, December 25, 1983](#) - [Joan Miró](#), [surrealist](#) painter

[[edit](#)]

# Nobel Prizes

- [Physics](#) - [Subrahmanyan Chandrasekhar](#), [William Alfred Fowler](#)
- [Chemistry](#) - [Henry Taube](#)
- [Medicine](#) - [Barbara McClintock](#)
- [Literature](#) - [William Golding](#)
- [Peace](#) - [Lech Walesa](#)
- [Economics](#) - [Gerard Debreu](#)

[[edit](#)]

## Fictional References to the Year

- "1983...(A Merman I Should Turn To Be)", by [Jimi Hendrix](#), from his album *[Electric Ladyland](#)* ([1968](#))

Retrieved from "<http://en.wikipedia.org/wiki/1983>"

[Categories](#): [1983](#)

### Views

- [Article](#)
- [Discussion](#)
- [Edit this page](#)
- [History](#)

### Personal tools

- [Create an account or log in](#)

### Navigation

- [Main Page](#)
- [Community portal](#)
- [Current events](#)
- [Recent changes](#)
- [Random page](#)
- [Help](#)

- [Donations](#)

## Search

## Toolbox

- [What links here](#)
- [Related changes](#)
- [Special pages](#)

## In other languages

- [Afrikaans](#)
- [J;30@A:8](#)
- [Català](#)
- [Cymraeg](#)
- [Dansk](#)
- [Deutsch](#)
- [Eesti](#)
- [•»»·1/2<sup>10</sup>¬](#)
- [Español](#)
- [Esperanto](#)
- [Euskara](#)
- [Français](#)
- [Frysk](#)
- [Hrvatski](#)
- [Interlingua](#)
- [Íslenska](#)
- [Italiano](#)
- [ãÑèÙê](#)
- [Latina](#)
- [Nederlands](#)
- [å,ž](#)
- [Norsk](#)
- [Polski](#)

- [Português](#)
- [Român](#)
- [CAA:89](#)
- [Slovenščina](#)
- [!@?A:8 / Srpski](#)
- [Suomi](#)
- [Svenska](#)
- [Türkçe](#)
- [#: @0W=AL:0](#)
- [-†](#)
- [Walon](#)

[MediaWiki](#)

[GNU Free Documentation License](#)

- This page was last modified 18:20, 1 Sep 2004.
- All text is available under the terms of the [GNU Free Documentation License](#) (see [Copyrights](#) for details).
- [About Wikipedia](#)
- [Disclaimers](#)



# United States

From [Wikipedia](#), the free encyclopedia.

*For other uses, see [United States \(disambiguation\)](#).*

The **United States of America**, also referred to as the **United States**, **U.S.A.**, **U.S.**, **America**<sup>1</sup>, or **the States**, is a [federal republic](#) in central [North America](#), stretching from the [Atlantic](#) coast in the east to the [Pacific Ocean](#) in the west. It shares land borders with [Canada](#) in the north and [Mexico](#)

in the south, shares a marine border with [Russia](#) in the west, and has a collection of districts, territories, and possessions around the world including the states of [Alaska](#) and [Hawaii](#), as well as territories including [Puerto Rico](#), [Midway Atoll](#), and [Guam](#). The country has fifty [states](#), which have a level of local autonomy according to the system of [federalism](#). A United States citizen is usually identified as an *American*.<sup>1</sup>

The United States traces its national origin to the [declaration](#) by thirteen [British colonies](#) in [1776](#)

## United States of America

|                                                                                                      |                                                                                                                                                                                            |                                                                                                                    |
|------------------------------------------------------------------------------------------------------|--------------------------------------------------------------------------------------------------------------------------------------------------------------------------------------------|--------------------------------------------------------------------------------------------------------------------|
|                                                                                                      | <div><span><span>Flag of the United States of America</span></span></div> <div><span><span>(U.S. Flag)</span></span></div>                                                                 | <div><span><span>Great Seal of the U.S.</span></span></div> <div><span><span>(U.S. Great Seal)</span></span></div> |
|                                                                                                      | National <a href="#">Mottos</a><br>(1776 - ): <i><a href="#">E Pluribus Unum</a></i><br>( <a href="#">Latin</a> : "Out of many, one")<br>(1956 - ): <i><a href="#">In God We Trust</a></i> |                                                                                                                    |
|                                                                                                      | <div><span><span>Image:LocationUSA.png</span></span></div>                                                                                                                                 |                                                                                                                    |
| <a href="#">Official language</a>                                                                    | <a href="#">None at Federal Level, Some States Specify English; <i>de facto</i>, Spanish spoken by growing minority, especially in the South</a>                                           |                                                                                                                    |
| <a href="#">Capital</a>                                                                              | <a href="#">Washington, DC</a>                                                                                                                                                             |                                                                                                                    |
| <a href="#">Largest city</a>                                                                         | <a href="#">New York</a>                                                                                                                                                                   |                                                                                                                    |
| <a href="#">President</a>                                                                            | <a href="#">George W. Bush</a>                                                                                                                                                             |                                                                                                                    |
| <a href="#">Area</a><br>- Total<br>- % water                                                         | <a href="#">Ranked 3rd</a><br>5,984,685 sq. miles ( <a href="#">9,631,418 km²</a> )<br>4.875%                                                                                              |                                                                                                                    |
| <a href="#">Population</a><br>- Total ( <a href="#">July 2004</a> est.)<br>- <a href="#">Density</a> | <a href="#">Ranked 3rd</a><br>293,027,571<br>49/m² (32/km²)                                                                                                                                |                                                                                                                    |
| <a href="#">Independence</a><br>- Declared<br>- Recognized                                           | <a href="#">Revolutionary War</a><br><a href="#">July 4, 1776</a><br><a href="#">September 3, 1783</a>                                                                                     |                                                                                                                    |
| <a href="#">GDP</a> (base PPP)<br>- Total ( <a href="#">2003</a> est.)<br>- GDP/head                 | <a href="#">Ranked 1st</a><br>\$10.98 trillion<br>\$37,800                                                                                                                                 |                                                                                                                    |
| <a href="#">Currency</a>                                                                             | <a href="#">US dollar</a> (\$)                                                                                                                                                             |                                                                                                                    |

that they were free and independent states. Before the British, and in terms of territory, the Dutch, Spanish and French had a

|                                                                                                                                                                                                            |                                              |
|------------------------------------------------------------------------------------------------------------------------------------------------------------------------------------------------------------|----------------------------------------------|
| <a href="#">Time zone</a>                                                                                                                                                                                  | <a href="#">UTC -5 to UTC -11</a>            |
| <a href="#">National anthem</a>                                                                                                                                                                            | " <a href="#">The Star-Spangled Banner</a> " |
| <a href="#">Internet TLD</a>                                                                                                                                                                               | .GOV .EDU .MIL .US .UM                       |
| <a href="#">Calling Code</a>                                                                                                                                                                               | 1                                            |
| <a href="#">Edit</a>                                                                                                                                                                                       |                                              |
| <i>(<a href="http://en.wikipedia.org/w/wiki.phtml?title=Template:United_States_infobox&amp;action=edit">http://en.wikipedia.org/w/wiki.phtml?title=Template:United_States_infobox&amp;action=edit</a>)</i> |                                              |

stronger foothold on the [New Continent](#) where various tribes of [Native Americans](#) (also called American Indians, Amerindians, Red Indians, or Indians, though some consider these terms misleading and in some cases offensive) had lived for thousands of years. Since the mid-[20th century](#), it has surpassed all other [nations](#) in contemporary [economic](#), [political](#), [military](#) and [cultural](#) influence.

The country was founded under a tradition of having the rule come from the people under the [representative democracy](#) model. This model of government ([presidential-congressional](#)) has since been adopted by many other countries, mostly in [Central America](#) and [South America](#).

## Contents

### [1 History](#)

### [2 Politics](#)

### [3 Political divisions](#)

### [4 Geography](#)

### [5 Economy](#)

### [6 Demographics](#)

### [7 Culture](#)

#### [7.1 Legal holidays](#)

### [8 Related topics](#)

### [9 Notes](#)

### [10 External links](#)

#### [10.1 United States government](#)

#### [10.2 Other](#)

[\[edit\]](#)

# History

*Main article: [History of the United States](#)*

Following the [European colonization of the Americas](#), the United States became one of the world's first modern [representative democracies](#) after its [break with Great Britain](#), with a [Declaration of Independence](#) in [1776](#). The original political structure was a confederation in [1777](#), ratified in [1781](#) as the [Articles of Confederation](#). After long [debate](#), this was supplanted by the [Constitution](#) of a more centralized [federal](#) government in [1789](#). During the [19th century](#), many new [states](#) were added to the original thirteen as the nation expanded across the [North American](#) continent and acquired a number of overseas possessions. Three major traumatic experiences for the nation were the [Civil War \(1861-1865\)](#) the [Great Depression \(1929-1939\)](#), and the [9/11 attacks](#). Following the end of [World War II](#) and then the collapse of the [Soviet Union](#), the United States has become the world's leading economic and military power.

*See also: [Military history of the United States](#), [Timeline of United States history](#)*

[\[edit\]](#)

# Politics

*Main article: [Politics of the United States](#)*

The United States of America consists of 50 [states](#) with limited [autonomy](#) in which [federal law](#) takes precedence over [state law](#). In general, matters that lie entirely within state borders are the exclusive concern of state governments. These include internal communications; regulations relating to property, industry, business, and public utilities; the state [criminal code](#); and working conditions within the state.

The various state [constitutions](#) differ in some details but generally follow a pattern similar to that of the federal Constitution, including a statement of the rights of the people and a plan for organizing the government. On such matters as the operation of businesses, banks, public utilities and charitable institutions, state constitutions are often more detailed and explicit than the federal Constitution. In recent years, the federal government has assumed broader responsibility in such matters as health, education, welfare, transportation, housing and urban development.

The federal government itself consists of three branches: the [executive branch](#) (headed by the [President](#)), the [legislative branch](#) (the [Congress](#)), and the [judicial branch](#) (headed by the [Supreme Court](#)). The President is elected to a four-year term by the [Electoral College](#) carried out through the process of a nation-wide [popular vote](#). The various legislators are in turn chosen primarily by the popular votes in the 50 states. Members of Congress are elected for terms of two years in the [House of Representatives](#) and six years in the [Senate](#). This tripartite system is duplicated, with variations, (such as elected [governors](#) instead of a president) at the state level. (See [classical definition of republic](#).)

The federal and state government is dominated by two political parties, the [Republicans](#) and the [Democrats](#). The dominant political culture in the United States is, as a whole, somewhat to the [right](#) of the dominant political culture in European democracies, though the issues at odds are somewhat different. Given their complex support bases it is difficult to specifically categorize the two major parties' appeal. Within the United States political culture, the Republican Party is described as center-right and the Democratic Party is described as center-left. Minor party and independent candidates are very occasionally elected, usually to local or state office, but the United States political system has historically supported "catch-all parties" rather than coalition governments. The ideology and policies of the sitting President of the United States commonly play a large role in determining the direction of his political party, as well as the platform of the opposition.

Political parties in the United States do not have formal "leaders" unlike many other countries, although there are complex hierarchies within the political parties that form various executive committees. Party ideology remains very individually-driven, with a diverse spectrum of [moderates](#), [centrists](#), and [radicals](#) within each party.

The two parties exist on both the state and federal level, although the parties' organization, platform, and ideologies are not necessarily uniform across all levels of government.

Both major parties draw some support from all the diverse socio-economic classes which compose the mature multi-ethnic capitalist society which makes up the United States. Business interests provide support to both parties. Funding and support to the Republican Party comes from [morality](#) and [Christian](#) groups, while labor unions and minority ethnic groups provide support to the Democrats. However the major source of funding to both parties comes from the business community. Both parties are funded by business interests, though the Republicans usually raise more money that way. Because elections in the United States are among the most expensive in the world access to funds is vital in the political system due to the financial costs of mounting political campaigns. Thus, through lobbying, corporations, unions, and other organized groups that provide funds and political support to parties and politicians play the largest role in determining political agendas and government decision-making.

The immense cultural, economic, and military influence of the United States has made [foreign relations](#) an especially important topic in its politics, with considerable concern about the image of the United States throughout the world.

[\[edit\]](#)

## Political divisions

*Main article: [Political divisions of the United States](#)*

At the time of the [United States Declaration of Independence](#), the [thirteen colonies](#) transformed themselves into [states](#), initially connected in a loose confederation, and later united as a unified country (cf. *the United States*). In the following years, the number of states within the U.S. grew steadily, due to western expansion, the conquest and purchase of lands by the national government,

and the subdivision of existing states, resulting in the current total of fifty. The states are generally divided into smaller administrative regions: [counties](#), [cities](#) and [townships](#).

The United States also holds several other territories, districts and possessions, notably the [federal district](#) of the [District of Columbia](#), which is the nation's capital, and several overseas [insular areas](#), the most significant of which are [Puerto Rico](#), [American Samoa](#), [Guam](#) and the [United States Virgin Islands](#). The United States has held a Naval Base at an occupied portion of [Guantanamo Bay](#), [Cuba](#) since 1898. The U.S. government claims a lease to this land, which only mutual agreement or United States abandonment of the area can terminate, something the current Cuban government disputes, claiming Cuba was not truly sovereign at the time of the signing.

The United States has made no territorial claim in [Antarctica](#) but has reserved the right to do so.

## Political divisions of the United States



[Alabama](#) | [Alaska](#) | [Arizona](#) | [Arkansas](#) | [California](#) | [Colorado](#) | [Connecticut](#) | [Delaware](#) | [Florida](#) | [Georgia](#) | [Hawaii](#) | [Idaho](#) | [Illinois](#) | [Indiana](#) | [Iowa](#) | [Kansas](#) | [Kentucky](#) | [Louisiana](#) | [Maine](#) | [Maryland](#) | [Massachusetts](#) | [Michigan](#) | [Minnesota](#) | [Mississippi](#) | [Missouri](#) | [Montana](#) | [Nebraska](#) | [Nevada](#) | [New Hampshire](#) | [New Jersey](#) | [New Mexico](#) | [New York](#) | [North Carolina](#) | [North Dakota](#) | [Ohio](#) | [Oklahoma](#) | [Oregon](#) | [Pennsylvania](#) | [Rhode Island](#) | [South Carolina](#) | [South Dakota](#) | [Tennessee](#) | [Texas](#) | [Utah](#) | [Vermont](#) | [Virginia](#) | [Washington](#) | [West Virginia](#) | [Wisconsin](#) | [Wyoming](#)

**Federal district** [District of Columbia](#)

**Insular areas** [American Samoa](#) | [Baker Island](#) | [Guam](#) | [Howland Island](#) | [Jarvis Island](#) | [Johnston Atoll](#) | [Kingman Reef](#) | [Midway Atoll](#) | [Navassa Island](#) | [Northern Mariana Islands](#) | [Palmyra Atoll](#) | [Puerto Rico](#) | [Virgin Islands](#) | [Wake Island](#)

[Edit](http://en.wikipedia.org/w/wiki.phtml?title=Template:United_States&action=edit) ([http://en.wikipedia.org/w/wiki.phtml?title=Template:United\\_States&action=edit](http://en.wikipedia.org/w/wiki.phtml?title=Template:United_States&action=edit))

[[edit](#)]

## Geography

*Main article:* [Geography of the United States](#)



## Map of the United States



### Map of the United States

As the world's third largest country (total area), the United States landscape varies greatly: temperate forestland on the East coast, [mangrove](#) forests in [Florida](#), the [Great Plains](#) in the center of the country, the [Mississippi-Missouri](#) river system, the [Rocky Mountains](#) west of the plains, deserts and temperate coastal zones west of the Rocky Mountains and temperate rainforests in the Pacific Northwest. The arctic regions of [Alaska](#) and the [volcanic](#) islands of [Hawaii](#) only increase the geographic and climatic diversity.

The climate varies along with the landscape, from sub-tropical in [Florida](#) to [tundra](#) in [Alaska](#). Large parts of the country have a continental climate, with warm summers and cold winters. Some parts of the United States, particularly parts of California, have a [Mediterranean climate](#).

[\[edit\]](#)

## Economy

*Main article: [Economy of the United States](#)*

The economy of the United States is described as "mixed" because, while it is organized primarily on a [capitalist model](#) ([entrepreneurship](#) is encouraged, and most enterprises are privately owned), it also limits free markets with [social welfare](#) programs like [Social Security](#), [unemployment benefits](#), and [Medicare](#), as well as [government regulation](#) in virtually every industry.

The U.S. economy is marked by steady growth, low [unemployment](#), low [inflation](#), a large [trade deficit](#) and rapid advances in technology; its economy can be regarded as the most important in the world. Several countries have coupled their [currency](#) with the [dollar](#), or even use it as a currency, and the U.S. [stock markets](#) are globally seen as an indicator of world economy.

The country has rich [mineral](#) resources, with extensive [gold](#), [oil](#), [coal](#) and [uranium](#) deposits. [Successful farm industries](#) rank the country among the top producers of, among others, [corn](#), [wheat](#), [sugar](#) and [tobacco](#). The U.S. [manufacturing sector](#) produces [cars](#), [airplanes](#) and [electronics](#). The biggest industry is now [service](#); about three-quarters of U.S. residents are employed in that sector.

The largest trading partner of the United States is its northern neighbor, [Canada](#). Other major partners are [Mexico](#), the [European Union](#) and the industrialized nations in [Asia](#), such as [Japan](#), [India](#) and [South Korea](#). Trade with [China](#) is also significant.

In 2002, the United States was [ranked](#) as the third most-visited tourist destination in the world. Its 41.9 million visits trailed only [France](#) (77 million) and [Spain](#) (51.7 million).

*See also:* [List of United States companies](#)

[\[edit\]](#)

## Demographics

*Main article:* [Demographics of the United States](#)

The majority of the 290 million people currently living in the United States descend from [European](#) immigrants who have arrived since the establishment of the first colonies. Major components of the European segment of the United States population are descended from immigrants from [Germany](#), [England](#), [Scotland](#), [The Netherlands](#), [Ireland](#) and [Italy](#), with many immigrants also coming from [Scandinavian](#) or [Slavic](#) countries. Other significant immigrant populations came from eastern and southern Europe and French Canada; few immigrants came directly from [France](#). Likewise, while there were few immigrants directly from [Spain](#), [Hispanics](#) from Mexico and South and Central America are considered the largest minority group in the country, comprising 13.4 percent of the population in [2002](#). This has brought increasing use of the [Spanish language](#) in the United States. (*See also:* [Languages in the United States](#)).

About 12.9 percent ([2000](#) census) of the American people are [African Americans](#), many of whom are descendants of the [enslaved Africans](#) brought to the U.S. between the [1620s](#) and [1807](#).

A third significant minority is the [Asian American](#) population (3.6 percent), most of whom are concentrated on the [West Coast](#).

The aboriginal population of [Native Americans](#), such as [American Indians](#) and [Inuit](#), make up less than one percent of the population.

The United States, as a developed nation, is noteworthy for its high level of Christian religious devotion. However, the percentage of Americans calling themselves Christian has declined somewhat in recent years from 86.2 percent in [1990](#) to 76.5 percent in [2001](#).

As of [2001](#), the distribution for major religions in the United States was [Protestant](#) (52 percent), [Roman Catholic](#) (24.5 percent), "none" (13.2 percent), [Jewish](#) (1.3 percent) and between 0.3 and 0.5 percent each for [Muslim](#), [Buddhist](#), [Hindu](#) and [Unitarian Universalist](#). An additional 0.3 to 0.5 percent, each, are professed [Agnostics](#) and [Atheists](#).

The [social structure of the United States](#) is highly stratified, with a large proportion of the wealth

of the country controlled by a small fraction of the population which exerts disproportionate cultural and political influence on the rest of the nation. (Its [Gini coefficient](#) of 40.8 percent is the highest of all developed nations.) However, in terms of relative wealth, most U.S. residents enjoy a standard of personal economic wealth that is far greater than that known in most of the world. For example, 51 percent of all households have access to a [computer](#) and 67.9 percent of U.S. households owned their dwellings in [2002](#).

*See also:* [Immigration to the United States](#)

[\[edit\]](#)

## Culture

*Main article:* [Culture of the United States](#)

U.S. culture has a large influence on the rest of the world, especially the [Western world](#). This influence is sometimes criticized as [cultural imperialism](#). [U.S. music](#) is heard all over the world, and it is the sire of such forms as [blues](#) and [jazz](#) and had a primary hand in the shaping of modern [rock and roll](#) and [popular music](#) culture. Many great [Western classical musicians](#) and forums find their home in the U.S. and [New York City](#) is a hub for international [operatic](#) and [instrumental](#) music as well as the world-famed [Broadway](#) plays and musicals. [U.S. movies](#) (primarily embodied in [Hollywood](#)) and [television](#) shows can be seen almost anywhere. This is in stark contrast to the early days of the republic, when the country was viewed by Europeans as an agricultural backwater with little to offer the culturally "advanced" world centers of Asia and Europe. Nearing the mid-point of its third century of nationhood, the U.S. plays host to the gamut of human intellectual and artistic endeavor in nearly every major city, offering classical and popular music; historical, scientific and art research centers and museums; dance performances, musicals and plays; outdoor art projects and internationally significant architecture. This development is a result of both contributions by private philanthropists and government funding.

The United States is also a great center of higher education, boasting more than 1,500 [universities](#), [colleges](#), and other institutions of higher learning, the top tier of which may be considered to be among the most prestigious and advanced in the world.

*See also:* [Arts and entertainment in the United States](#), [Languages in the United States](#), [Education in the United States](#)

[\[edit\]](#)

## Legal holidays

*Main article:* [Holidays of the United States](#)

| Date                      | Name                           | Remarks                                                      |
|---------------------------|--------------------------------|--------------------------------------------------------------|
| <a href="#">January 1</a> | <a href="#">New Year's Day</a> | Beginning of year, marks traditional end of "holiday season" |



|                                            |                                             |                                                                                                                                                                                                          |
|--------------------------------------------|---------------------------------------------|----------------------------------------------------------------------------------------------------------------------------------------------------------------------------------------------------------|
| <a href="#">January</a> , third Monday     | <a href="#">Martin Luther King, Jr. Day</a> | Honors late Dr. King, <a href="#">Civil Rights</a> leader                                                                                                                                                |
| <a href="#">February</a> , third Monday    | <a href="#">Presidents' Day</a>             | Honors former U.S. Presidents, especially <a href="#">Washington</a> and <a href="#">Lincoln</a>                                                                                                         |
| <a href="#">May</a> , last Monday          | <a href="#">Memorial Day</a>                | Honors servicemen and women who died in service, marks traditional beginning of summer                                                                                                                   |
| <a href="#">July 4</a>                     | <a href="#">Independence Day</a>            | Celebrates <a href="#">Declaration of Independence</a> , usually called the Fourth of July                                                                                                               |
| <a href="#">September</a> , first Monday   | <a href="#">Labor Day</a>                   | Celebrates achievements of workers, marks traditional end of summer. This holiday is held instead of the traditional worldwide Labor Day, <a href="#">May 1</a> , which ironically began in this country |
| <a href="#">October</a> , second Monday    | <a href="#">Columbus Day</a>                | Honors <a href="#">Christopher Columbus</a> , traditional discoverer of the Americas                                                                                                                     |
| <a href="#">November 11</a>                | <a href="#">Veterans' Day</a>               | Traditional observation of a moment of silence at 11 AM remembering those who fought for peace                                                                                                           |
| <a href="#">November</a> , fourth Thursday | <a href="#">Thanksgiving</a>                | Day of thanks for autumn harvest, marks traditional beginning of "holiday season"                                                                                                                        |
| <a href="#">December 25</a>                | <a href="#">Christmas</a>                   | Celebrates the <a href="#">nativity</a> of <a href="#">Jesus Christ</a> , also celebrated as secular winter holiday                                                                                      |

[[edit](#)]

## Related topics

*Main article:* [List of United States-related topics](#)

### Topics in the United States

#### [History](#)

[Timeline](#) ( [Colonial Era](#) | [American Revolution](#) | [Westward Expansion](#) | [Civil War](#) | [World War 1](#) | [Great Depression](#) | [World War 2](#) | [Cold War](#) | [Vietnam War](#) | [Civil Rights](#)) | [Foreign relations](#) | [Military](#) | [Demographic](#) and [Postal](#) history

#### [Politics](#)

[Law](#) ( [Constitution](#) and [Bill of Rights](#) | [Declaration of Independence](#)) | [Political parties](#) ( [Democrats](#) & [Republicans](#)) | [Elections](#) ([Electoral College](#)) | [Political scandals](#) | [Political divisions](#)

## Government

[Federal agencies](#) | [Legislative branch](#) (Congress: [House](#) | [Senate](#)) [Executive branch](#) ( [President](#) & [Vice-President](#) | [Cabinet](#) | [Attorney-General](#) | [Secretary of State](#) | [Law enforcement: FBI](#) | [Intelligence:CIA](#) | [DIA](#) | [NIMA](#) | [NRO](#) | [NSA](#),) | [Judicial branch](#) ( [Supreme Court](#)) | [Military](#) ( [Army](#) | [Navy](#) | [Marines](#) | [Air Force](#))

## Geography

[Appalachian Mtns.](#) | [Rocky Mtns.](#) | [Great Plains](#) | [Midwest](#) | [The South](#) | [Mississippi River](#) | [New England](#) | [Mid-Atlantic](#) | [Pacific Northwest](#) | [Mountains](#) | [Valleys](#) | [Islands](#) | [Rivers](#) | [States](#) | [Cities](#) | [Counties](#) | [Regions](#) | [Extreme points](#)

## Economy

[Dollar](#) | [Wall Street](#) | [Standard of living](#) | [Companies](#) | [Poverty](#) | [circa 2004](#)

## Demographics

[US Census Bureau](#) | [Languages](#) | [Social structure](#) | [Standard of living](#) | [Religion](#)

## Arts & Culture

[Music](#) ([Hippies](#) | [blues](#) | [jazz](#) | [rock and roll](#) | [hip hop](#) | [gospel](#) | [country](#)) | [Film & TV](#) ([Hollywood](#)) | [Literature](#) ( [Poetry](#) | [Transcendentalism](#) | [Harlem Renaissance](#) | [Beat Generation](#)) | [Visual arts](#) ( [Abstract expressionism](#)) | [Cuisine](#) | [Holidays](#) | [Folklore](#) | [Dance](#) | [Architecture](#) | [Education](#) | [Languages](#) | [Media](#)

## **Other**

[United States territory](#) | [Communications](#) | [Transportation](#) ( [Highways](#) and [Interstates](#) | [Railroads](#)) | [Uncle Sam](#) | [Flag](#) | [American Dream](#) | [Media](#) | [Education](#) | [Tourism](#) | [Social issues](#) ( [Immigration](#) | [Affirmative action](#) | [Racial profiling](#) | [Human rights](#) | [War on Drugs](#) | [Pornography](#) | [Gay marriage](#) | [Prisons](#) | [Capital punishment](#)) | [American Exceptionalism](#) | [Anti-Americanism](#) | [American Folklore](#) | [American English](#) | [United States Mexico barrier](#)

## States

[Alabama](#) | [Alaska](#) | [Arizona](#) | [Arkansas](#) | [California](#) | [Colorado](#) | [Connecticut](#) | [Delaware](#) | [Florida](#) | [Georgia](#) | [Hawaii](#) | [Idaho](#) | [Illinois](#) | [Indiana](#) | [Iowa](#) | [Kansas](#) | [Kentucky](#) | [Louisiana](#) | [Maine](#) | [Maryland](#) | [Massachusetts](#) | [Michigan](#) | [Minnesota](#) | [Mississippi](#) | [Missouri](#) | [Montana](#) | [Nebraska](#) | [Nevada](#) | [New Hampshire](#) | [New Jersey](#) | [New Mexico](#) | [New York](#) | [North Carolina](#) | [North Dakota](#) | [Ohio](#) | [Oklahoma](#) | [Oregon](#) | [Pennsylvania](#) | [Rhode Island](#) | [South Carolina](#) | [South Dakota](#) | [Tennessee](#) | [Texas](#) | [Utah](#) | [Vermont](#) | [Virginia](#) | [Washington](#) | [West Virginia](#) | [Wisconsin](#) | [Wyoming](#)

[Reporters without borders](#) [Worldwide Press Freedom Index 2003](#): Rank 31 out of 166 countries (2-way tie) (2002 - 17 out of 139 countries)

[[edit](#)]

## Notes

<sup>1</sup> In the [English](#)-speaking world, *America* has become synonymous with the nation of the United States while *American* refers to United States (U.S.) citizens; this is a standard usage in not only the U.S. itself, but also much of Europe and Australasia. The term *Americas*, on the other hand, includes the North and South American continents as a collective unit. In Spanish-speaking countries, particularly in Central and South America, the word *América* is used not to denote the U.S. but what English-speakers would term the Americas. Thus, some people of the Americas find it off-putting for the U.S. to be referred to as *America* and inhabitants of the U.S. as *Americans*. While, in some quarters, the accuracy and political correctness of such nomenclature is debated, current usage in English by sheer weight of occurrence inclines to *America* and *American* as linked to the nation and citizens of the United States.

[[edit](#)]

# External links

[[edit](#)]

## United States government

- [Official website of the United States government](http://www.firstgov.gov) (*http://www.firstgov.gov*) - Gateway to governmental sites
- [White House](http://www.whitehouse.gov) (*http://www.whitehouse.gov*) - Official site of the US President
- [Senate.gov](http://www.senate.gov) (*http://www.senate.gov*) - Official site of the United States Senate
- [House.gov](http://www.house.gov) (*http://www.house.gov*) - Official site of the United States House of Representatives
- [SCOTUS](http://www.supremecourtus.gov) (*http://www.supremecourtus.gov*) - Official site of the Supreme Court of the United States
- [Portrait of the USA](http://usinfo.state.gov/usa/infousa/facts/factover/homepage.htm) (*http://usinfo.state.gov/usa/infousa/facts/factover/homepage.htm*) - Published by the United States Information Agency, September 1997.
- [US Census Housing and Economic Statistics](http://www.census.gov/hhes/www/) (*http://www.census.gov/hhes/www/*) Updated regularly by US Bureau of the Census.

[[edit](#)]

## Other

- [US Newspapers by State](http://www.mediatico.com/en) (*http://www.mediatico.com/en*)
- [National Motto: History and Constitutionality](http://www.religioustolerance.org/nat_mott.htm) (*http://www.religioustolerance.org/nat\_mott.htm*)
- [Historical Documents](http://www.nationalcenter.org/HistoricalDocuments.html) (*http://www.nationalcenter.org/HistoricalDocuments.html*)
- [Reference: US specific web resources sorted by state](http://www.travel-directory.org/Destinations/North_America/United_States/index.html) (*http://www.travel-directory.org/Destinations/North\_America/United\_States/index.html*)

### **Countries in North America**

[Antigua and Barbuda](#) | [Bahamas](#) | [Barbados](#) | [Belize](#) | [Canada](#) | [Costa Rica](#) | [Cuba](#) | [Dominica](#) | [Dominican Republic](#) | [El Salvador](#) | [Grenada](#) | [Guatemala](#) | [Haiti](#) | [Honduras](#) | [Jamaica](#) | [Mexico](#) | [Nicaragua](#) | [Panama](#) | [Saint Kitts and Nevis](#) | [Saint Lucia](#) | [Saint Vincent and the Grenadines](#) | [Trinidad and Tobago](#) | **United States**

**Dependencies:** [Anguilla](#) | [Aruba](#) | [Bermuda](#) | [Cayman Islands](#) | [Greenland](#) | [Guadeloupe](#) | [Martinique](#) | [Montserrat](#) | [Netherlands Antilles](#) | [Puerto Rico](#) | [Saint-Pierre and Miquelon](#) | [Turks and Caicos Islands](#) | [U.S. Virgin Islands](#) | [British Virgin Islands](#)

Retrieved from "["http://en.wikipedia.org/wiki/United\\_States"](http://en.wikipedia.org/wiki/United_States)

**Categories:** [North American countries](#) | [United States](#) | [Republics](#)

## Views

- [Article](#)
- [Discussion](#)
- [Edit this page](#)
- [History](#)

## Personal tools

- [Create an account or log in](#)

## Navigation

- [Main Page](#)
- [Community portal](#)
- [Current events](#)
- [Recent changes](#)
- [Random page](#)
- [Help](#)
- [Donations](#)

## Search

## Toolbox

- [What links here](#)
- [Related changes](#)
- [Special pages](#)

## In other languages

- [Afrikaans](#)
- [D91\(J\)](#)
- [J;30@A:8](#)
- [Català](#)
- [esky](#)

- [Cymraeg](#)
- [Dansk](#)
- [Deutsch](#)
- [•»»·1/2<sup>1°</sup>□](#)
- [Esperanto](#)
- [Español](#)
- [Suomi](#)
- [Français](#)
- [Gaeilge](#)
- [Galego](#)
- [ãÑèÙê](#)
- [Magyar](#)
- [Interlingua](#)
- [Bahasa Indonesia](#)
- [Íslenska](#)
- [Italiano](#)
- [å,ž](#)
- [\m´](#)
- [Latina](#)
- [Lietuvis](#)
- [Bân-lâm-gú](#)
- [Bahasa Melayu](#)
- [Plattdüütsch](#)
- [Nederlands](#)
- [Norsk](#)
- [Polski](#)
- [Português](#)
- [Român](#)
- [CAA:89](#)
- [Simple English](#)
- [Slovenš ina](#)
- [!@?A:8 / Srpski](#)
- [Svenska](#)
- [Tonga](#)

- [Toki Pona](#)
- [Türkçe](#)
- [#: @0W=AL:0](#)
- ['1/H](#)
- [Tiŋg Viŋt](#)
- [-ɿ\(€S\)](#)
- [-ɿ\(AS\)](#)
- [Diné bizaad](#)

MediaWiki

GNU Free Documentation  
License

- This page was last modified 02:12, 6 Sep 2004.
- All text is available under the terms of the [GNU Free Documentation License](#) (see [Copyrights](#) for details).
- [About Wikipedia](#)
- [Disclaimers](#)

# Visionary

From [Wikipedia](#), the free encyclopedia.

A **visionary** is a person with a clear, distinctive and specific (in some details) vision of the future, usually connected with advances in [technology](#) or political arrangements. Examples would be [Buckminster Fuller](#) in [architecture](#), and some of the pioneers of [personal computing](#). A visionary may function as a secular [prophet](#), emphasising communication and a figurehead role, rather than implementation.

[Visionary art](#) is defined as a category of [primitive art](#) (i.e. art of those not formally trained). Artists may produce art categorised as 'visionary' for its luminous content, without being primitives in any sense (e.g. [Samuel Palmer](#)). An artist celebrated for his visionary, religious take on ordinary life is [Stanley Spencer](#).

Retrieved from "<http://en.wikipedia.org/wiki/Visionary>"

## Views

- [Article](#)
- [Discussion](#)
- [Edit this page](#)
- [History](#)

## Personal tools

- [Create an account or log in](#)

## Navigation

- [Main Page](#)
- [Community portal](#)
- [Current events](#)
- [Recent changes](#)
- [Random page](#)
- [Help](#)
- [Donations](#)

## Search

## Toolbox

- [What links here](#)
- [Related changes](#)
- [Special pages](#)

[MediaWiki](#)

[GNU Free Documentation License](#)

- This page was last modified 17:05, 25 Jun 2004.
- All text is available under the terms of the [GNU Free Documentation License](#) (see [Copyrights](#) for details).
- [About Wikipedia](#)
- [Disclaimers](#)



# Designer

From [Wikipedia](#), the free encyclopedia.

*Designer* is a broad term for a person who [designs](#) any of a variety of things. This usually implies the task of creating or of being [creative](#) in a particular area of expertise. Often times it is used to reference someone who draws or in some ways uses visual cues to organize their work.

*Designer* is also the title for a person practicing in one of the design fields, such as [architecture](#) or [engineering](#), but who is not licensed in that field.

Examples include: [Industrial designer](#), [Interior designer](#), [Fashion designer](#), [Graphic designer](#), [Landscape designer](#), [Stage designer](#), [Systems designer](#) and [Web designer](#).

*See also:* [Visual arts and design](#), [Design](#).

Retrieved from "<http://en.wikipedia.org/wiki/Designer>"

## Views

- [Article](#)
- [Discussion](#)
- [Edit this page](#)
- [History](#)

## Personal tools

- [Create an account or log in](#)

## Navigation

- [Main Page](#)
- [Community portal](#)
- [Current events](#)
- [Recent changes](#)
- [Random page](#)
- [Help](#)
- [Donations](#)

## Search

## Toolbox

- [What links here](#)
- [Related changes](#)
- [Special pages](#)

## In other languages

- [Deutsch](#)
- [ǎ,ž](#)

MediaWiki

GNU Free Documentation License

- This page was last modified 14:14, 24 Apr 2004.
- All text is available under the terms of the [GNU Free Documentation License](#) (see [Copyrights](#) for details).
- [About Wikipedia](#)
- [Disclaimers](#)

# Architect

From [Wikipedia](#), the free encyclopedia.

An **architect** is a person licensed in the art of [planning](#), [designing](#) and overseeing the [constructing](#) of [buildings](#), or more generally, the designer of a scheme or plan. See [Architecture](#) or [Landscape Architecture](#)

Architects are [professionals](#), with requirements for practice varying greatly from place to place (see below).

The most prestigious award a living architect can receive is the [Pritzker Prize](#). It is considered the equivalent of the [Nobel Prize](#) for architecture. Other awards for excellence in architecture are given by the [American Institute of Architects](#) and Royal Institute of British Architects.

Although architect is a specific term referring to a licensed professional, the word is frequently used in a broader sense to define someone who brings order to the built or unbuilt environment through rational and irrational constructs using the tools of reason (for example, [webmasters](#) or [designers](#) sometimes call themselves architects). However, non-licensed designers in the construction industry are prohibited from referring to themselves as architects in most countries.

## Contents

[1 Canada](#)

[2 USA](#)

[3 UK](#)

[4 International](#)

[5 Notable Architects](#)

[6 Notable schools which trained architects](#)

[7 See also](#)

[8 External links](#)

[[edit](#)]

## Canada

In [Canada](#), architects are required to belong to provincial Architectural associations that require them to complete an accredited degree in architecture, finish a multi-year internship process, pass a series of exams, and pay an annual fee to acquire and maintain a license to practice.

The [Royal Architectural Institute of Canada \[1\]](#) (*http://www.raic.org/*) aims to be "the voice of Architecture and its practice in Canada." Architects who are members of this organization are

permitted to use the suffix MRAIC after their names. All members of the RAIC hold accredited degrees in architecture, but not all Canadian architects are members of the RAIC.

[[edit](#)]

## USA

In the [United States](#), architects may hold one of three degrees; a Bachelor of Architecture, a Master of Architecture, or a Doctor of Architecture (abbreviated as B.Arch., M.Arch., and D.Arch., respectively).

Architectural interns are required to pass a series of 8 exams, referred to as the Architectural Registration Examination (the ARE) in order to become licensed. In addition, interns must have eight years of practical experience (which may include accredited degrees in architecture) before they may sit for the ARE.

The [American Institute of Architects](#) [2] (*http://www.aia.org*) is the professional organization dedicated to offering a network of services to architects in the United States. Architects who are members of this organization are permitted to use the suffix AIA after their names. Although all members of the AIA are required to be licensed architects, not all architects are members of the AIA.

[[edit](#)]

## UK

In the [United Kingdom](#), the term *Architect* is protected by law, the latest regulations being made under the [Architects Act 1997](#). Apart from Architects in the construction industry, the only other persons permitted to carry out business using the term are [naval architects](#), [landscape architects](#), and [golf-course architects](#).

Construction industry architects (the subject of this article) must be registered with the [Architects Registration Board](#) [3] (*http://www.arb.org.uk/*) in order to practice, and who also have the power to suspend or revoke registration. The ARB took over an expanded role from the now defunct *Architects Registration Council of the United Kingdom* (ARCUK) as a result of the [1997](#) law. In order to register, an Architect must be qualified in the UK or a [European Economic Area](#) country.

The leading [professional body](#) for architects in the UK is the [Royal Institute of British Architects](#) (RIBA) [4] (*http://www.riba.org*).

See also [UK topics](#).

[[edit](#)]

# International

The professional body for destination architects is the [Institute of Destination Architects and Designers](#) (IDAD) <sup>[5]</sup> (*http://www.idad.org*).

[[edit](#)]

## Notable Architects

The architects in the [list of notable architects](#) are in chronological order of when they did their most important work (or emerged), and alphabetized within each time period.

[[edit](#)]

## Notable schools which trained architects

[Bauhaus](#), [Weimar](#), [Dessau](#), and [Berlin](#)

[Architectural Association School of Architecture](#), [London](#)

[Ecole des Beaux Arts](#), [Paris](#) (until 1968 when 22 [Ecole d'Architecture](#) replace it)

[[edit](#)]

## See also

- [Civil engineer](#)
- [Civil engineering](#)
- [Clerk of the Works](#)
- [Destination/Coastal Architects](#)
- [Landscape architect](#)
- [Landscape architecture`](#)
- [Regional planning](#)
- [Structural engineer](#)
- [Structural engineering](#)
- [Urban planning](#)
- [Urban planner](#)

[[edit](#)]

# External links

- [3D architectural rendering,architectural animation](http://www.3d-sky.com/) (*http://www.3d-sky.com/*)

Retrieved from "<http://en.wikipedia.org/wiki/Architect>"

Categories: [Architecture and engineering occupations](#)

## Views

- [Article](#)
- [Discussion](#)
- [Edit this page](#)
- [History](#)

## Personal tools

- [Create an account or log in](#)

## Navigation

- [Main Page](#)
- [Community portal](#)
- [Current events](#)
- [Recent changes](#)
- [Random page](#)
- [Help](#)
- [Donations](#)

## Search

## Toolbox

- [What links here](#)
- [Related changes](#)
- [Special pages](#)

## In other languages

- [Dansk](#)

- [Deutsch](#)
- [Français](#)
- [Italiano](#)
- [à,ž](#)
- [Nederlands](#)
- [-†\(€S\)](#)

[MediaWiki](#)

[GNU Free Documentation License](#)

- This page was last modified 11:25, 28 Aug 2004.
- All text is available under the terms of the [GNU Free Documentation License](#) (see [Copyrights](#) for details).
- [About Wikipedia](#)
- [Disclaimers](#)

# Inventor

From [Wikipedia](#), the free encyclopedia.

An **inventor** is a person which creates new [inventions](#), typically mechanical or electrical machines or other devices of practical use. Though some inventors may also be [scientists](#), most base their work on the discoveries of other scientists, experimenting with practical applications and combinations of those discoveries, and with improvements and combinations of existing devices, to create new useful devices.

The system of [patents](#) was established to encourage inventors by granting limited-term [monopoly](#) on inventions that are judged sufficiently novel. This system is nowadays frequently abused, especially in the [United States](#), and many people have called for reform or even abolition of the patent system. In the U.S., however, the patent right originates from the [Constitution](#), so inventors will likely continue to protect their inventions that way for many years to come.

The capacity to invent can be developed. See [TRIZ](#), the theory of inventive [problem-solving](#).

See also:

- [List of inventors](#)
- [List of scientists](#)
- [History of Science and Technology](#).
- [scientists](#).

[[edit](#)]

## External link

- [A collection of patents for pioneering electrical engineering technologies, including some by the inventors listed above](#) (*http://eepatents.com/collection.html*)

Retrieved from "<http://en.wikipedia.org/wiki/Inventor>"

### Views

- [Article](#)
- [Discussion](#)
- [Edit this page](#)
- [History](#)

### Personal tools



- [Create an account or log in](#)

## Navigation

- [Main Page](#)
- [Community portal](#)
- [Current events](#)
- [Recent changes](#)
- [Random page](#)
- [Help](#)
- [Donations](#)

## Search

## Toolbox

- [What links here](#)
- [Related changes](#)
- [Special pages](#)

## In other languages

- [Dansk](#)
- [Deutsch](#)
- [Español](#)

[MediaWiki](#)

[GNU Free Documentation License](#)

- This page was last modified 17:58, 10 Mar 2004.
- All text is available under the terms of the [GNU Free Documentation License](#) (see [Copyrights](#) for details).
- [About Wikipedia](#)
- [Disclaimers](#)

# Writer

From [Wikipedia](#), the free encyclopedia.

Though anyone who creates a written work may be called a **writer**, the term is usually reserved for those who write creatively, professionally and/or those who have written in many different forms. Skilled writers are adept at using [language](#) to portray ideas and images, whether it be in [fiction](#) or [non-fiction](#).

A writer may compose in many different forms, including, but not limited to, [poetry](#), [prose](#), [music](#) (see: [composer](#)), [technical writing](#), [journalism](#) and [academic](#) papers.

The work done by a writer is frequently considered part of the [cultural](#) content of a [society](#), and is seen as an [art](#) much like the visual arts (see [painting](#), [sculpture](#), [photography](#)), [music](#), [craft](#) and performance art (see: [drama](#), [theatre](#), [opera](#), [musical](#)).

[Graffiti](#) artists also refer to [themselves](#) as writers, although this may technically be a true description the reference is usually regarded as [slang](#).

[[edit](#)]

## See also

- [author](#)
- [language](#)
- [lists of authors](#)
- [style guide](#)
- [writing](#).

[[edit](#)]

## External links

- [Writers Guild of America, west](#) (*http://www.wga.org*)
- [Writers Guild of America, east](#) (*http://www.wgae.org*)
- [Writers' Guild of Great Britain](#) (*http://www.writersguild.org.uk*)

Retrieved from "<http://en.wikipedia.org/wiki/Writer>"

**Categories:** [Writers](#) | [Literature](#) | [Novelists](#)

## Views

- [Article](#)
- [Discussion](#)
- [Edit this page](#)
- [History](#)

## Personal tools

- [Create an account or log in](#)

## Navigation

- [Main Page](#)
- [Community portal](#)
- [Current events](#)
- [Recent changes](#)
- [Random page](#)
- [Help](#)
- [Donations](#)

## Search

## Toolbox

- [What links here](#)
- [Related changes](#)
- [Special pages](#)

## In other languages

- [Dansk](#)
- [å,ž](#)
- [Plattdüütsch](#)
- [Român](#)
- [Slovenš ina](#)

MediaWiki

**GNU Free Documentation  
License**

- This page was last modified 12:51, 30 Aug 2004.
- All text is available under the terms of the [GNU Free Documentation License](#) (see [Copyrights](#) for details).
- [About Wikipedia](#)
- [Disclaimers](#)

# Image:Bfullerstamp.jpg

From [Wikipedia](#), the free encyclopedia.



[Buckminster Fuller](#) USPS stamp

## File history

Legend: (cur) = this is the current file, (del) = delete this old version, (rev) = revert to this old version.

*Click on date to download the file or see the image uploaded on that date.*

- (del) (cur) [00:53, 21 Jul 2004](#) . . [Gamaliel](#) (32083 bytes) (*[Buckminster Fuller](#) USPS stamp*)

## File links

The following pages link to this file:

- [Buckminster Fuller](#)
- [List of people on stamps of the United States](#)

Retrieved from "<http://en.wikipedia.org/wiki/Image:Bfullerstamp.jpg>"

### Views

- [Image](#)
- [Discussion](#)
- [Edit this page](#)
- [History](#)

## Personal tools

- [Create an account or log in](#)

## Navigation

- [Main Page](#)
- [Community portal](#)
- [Current events](#)
- [Recent changes](#)
- [Random page](#)
- [Help](#)
- [Donations](#)

## Search

## Toolbox

- [What links here](#)
- [Related changes](#)
- [Special pages](#)

MediaWiki

GNU Free Documentation License

- This page was last modified 00:53, 21 Jul 2004.
- All text is available under the terms of the [GNU Free Documentation License](#) (see [Copyrights](#) for details).
- [About Wikipedia](#)
- [Disclaimers](#)

# Editing Buckminster Fuller (section)

From [Wikipedia](#), the free encyclopedia.

"); /\*]]>\*/

[Edit summary](#):

[Cancel](#) | [Editing help](#) (*opens in new window*)

**Your changes will be visible immediately.** If you would just like to test or practice editing, please do that in the [sandbox](#). You are encouraged to create, expand, and improve upon articles; however, bad edits to articles are watched for and will be quickly removed.

All contributions to Wikipedia are released under the GNU Free Documentation License (see [Wikipedia:Copyrights](#) for details). **If you do not want your writing to be edited mercilessly and redistributed at will, do not submit it.**

By submitting your work you promise you wrote it yourself, or copied it from [public domain](#) resources – this does **not** include most web pages. **DO NOT SUBMIT COPYRIGHTED WORK WITHOUT PERMISSION!**

Retrieved from "[http://en.wikipedia.org/wiki/Buckminster\\_Fuller](http://en.wikipedia.org/wiki/Buckminster_Fuller)"

**Views**

- [Article](#)
- [Discussion](#)
- [Edit this page](#)
- [History](#)

### Personal tools

- [Create an account or log in](#)

### Navigation

- [Main Page](#)
- [Community portal](#)
- [Current events](#)
- [Recent changes](#)
- [Random page](#)
- [Help](#)
- [Donations](#)

### Search

### Toolbox

- [What links here](#)
- [Related changes](#)
- [Special pages](#)

[MediaWiki](#)

[GNU Free Documentation License](#)

- [About Wikipedia](#)
- [Disclaimers](#)



# Geodesic dome

From [Wikipedia](#), the free encyclopedia.



The American Pavilion of Expo '67, by R. Buckminster Fuller, now the Biosphère, on Île Sainte-Hélène, Montreal

A **geodesic dome** is an almost spherical structure based on a network of struts arranged on great circles ([geodesics](#)) lying on the surface of a [sphere](#). The geodesics intersect to form triangular elements that create local triangular rigidity and distribute the [stress](#).

Of all known structures, a geodesic dome has the highest ratio of enclosed area to weight. Geodesic domes are far stronger as units than the individual struts would suggest. It is common for a new dome to reach a "critical mass" during construction, shift slightly, and lift any attached scaffolding from the ground.

Geodesic domes are designed by taking a [Platonic solid](#), such as an [icosahedron](#), and then filling each face with a regular pattern of triangles bulged out so that their vertices lie in the surface of a sphere. The trick is that the subpattern of triangles should create "geodesics", great circles to distribute stress across the structure.

There is good reason to believe that geodesic construction can be effectively extended to any shape, although it works best in shapes that lack corners to concentrate stress.

An early example of a geodesic dome was the [1913](#) planetarium dome at the [Carl Zeiss](#) plant in [Jena, Germany](#). However, the most famous individual to be associated with geodesic domes was [Buckminster Fuller](#), who popularised them in the [1940s](#) in line with his "synergetic" thinking.

Fuller had hoped the dome would address the emerging housing crisis - he also had hopes for his [dymaxion house](#). The geodesic dome has also been used to provide a stable structure for industrial

buildings and stadiums.

The dome was introduced to a wider audience at [Expo '67](#) the [Montreal, Canada World's Fair](#) as part of the American Pavilion. The structure's covering later burned down, but the structure itself still stands and, under the name *Biosphère*, currently houses an interpretive [museum](#) about the [Saint Lawrence River](#).

A number of people have built homes in the shape of a geodesic dome. Domes have a number of advantages.

They are very strong. The basic structure erects very quickly with a small crew, and light-weight pieces. Domes as large as fifty meters have been constructed in the wilderness from rough materials without a crane. The dome is also aerodynamic, so it loses relatively little heat to wind chill. Solar heating is possible by placing an arc of windows across the dome: the more heating needed the wider the arc should be, to encompass more of the year.

However, as a housing system the dome has several problems.

On the mundane side the entirety of the furnishing and fitting world is designed with flat surfaces in mind, and installing something as simple as a [sofa](#) results in a half-moon behind the sofa being wasted.

The shape leaves the vast majority of the interior surface unusable because of the sharply sloping roof lines. For example, in a 20 foot tall dome, only the bottom 8 feet or so are really usable. This leaves a large volume that must be heated, yet cannot be lived in.

Dome builders find it hard to seal domes against rain. The most effective method with a wooden dome is to shingle the dome. Another method is to use a one-piece reinforced concrete or plastic dome. Some domes have been constructed from plastic or waxed cardboard triangles that overlapped in such a way as to shed water.

[\[edit\]](#)

## Methods of construction

Wooden domes drill a hole in the width of a strut. A stainless steel band locks the strut's hole to a circle of steel pipe. This method lets the struts be simply cut to the exact needed length. Triangles of exterior plywood are then nailed to the struts. The dome is wrapped with several stapled layers of tar paper, from the bottom to the top in order to shed water, and finished with shingles.

Temporary greenhouse domes have been constructed by stapling plastic sheeting onto a dome constructed from 1x1s. The result is warm, movable by hand in sizes less than 20 feet, and cheap. It should be staked to the ground, because it will fly away in strong wind.

Steel-framework domes can be easily constructed of electrical conduit. One flattens the end of a strut, and drills bolt holes at the needed length. A single bolt secures a vertex of struts. The nuts are usually set with removable locking compound, or if the dome is portable, have a castle nut with a cotter pin. This is the standard way to construct domes for jungle-gyms.

Concrete and foam plastic domes generally start with a steel framework dome, and then wrap it with chicken-wire and wire screen for reinforcement. The chicken wire and screen is tied to the framework with wire ties. The material is sprayed or molded onto the frame. Tests should be performed with small squares to achieve the correct consistency of concrete or plastic. Generally, several coats are necessary on the inside and outside. The last step is to saturate concrete or polyester domes with a thin layer of epoxy compound to shed water.

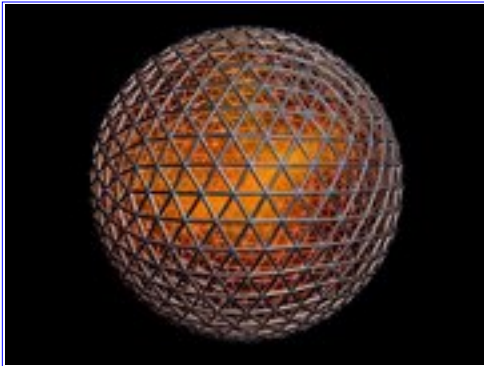

[Ed]

A CGI geodesic sphere rendered using freeware DOME Software and POV-Ray software

Some concrete domes have been constructed from prefabricated prestressed steel-reinforced concrete panels that can be bolted into place. The bolts are within raised receptacles covered with little concrete caps to shed water. The triangles overlap to shed water. The triangles in this method can be molded in forms patterned in sand with wooden patterns, but the concrete triangles are usually so heavy they must be placed with a crane. This construction is well-suited to domes because there is no place for water to pool on the concrete and leak through. The metal fasteners, joints and internal steel frames remain dry, preventing frost and corrosion damage. The concrete resists sun and weathering. Some form of internal flashing or caulking must be placed over the joints to prevent drafts. The 1963 [Cinerama Dome](#) was built from precast concrete hexagons and pentagons.

[edit]

## See also

[Fullerene](#)

[edit]

## External links

- [Build Your Own Geodesic dome](http://www.desertdomes.com/dome.html) (*http://www.desertdomes.com/dome.html*)
- [Geodesic Clubhouse](http://www.yesmag.bc.ca/projects/geodesic.html) (*http://www.yesmag.bc.ca/projects/geodesic.html*)
- [Designs in Various Frequencies](http://www3.sympatico.ca/geodome/index-en.htm) (*http://www3.sympatico.ca/geodome/index-en.htm*)

Retrieved from "[http://en.wikipedia.org/wiki/Geodesic\\_dome](http://en.wikipedia.org/wiki/Geodesic_dome)"

## Views

- [Article](#)
- [Discussion](#)
- [Edit this page](#)
- [History](#)

## Personal tools

- [Create an account or log in](#)

## Navigation

- [Main Page](#)
- [Community portal](#)
- [Current events](#)
- [Recent changes](#)
- [Random page](#)
- [Help](#)
- [Donations](#)

## Search

## Toolbox

- [What links here](#)
- [Related changes](#)
- [Special pages](#)

## In other languages

- [Deutsch](#)
- [à,ž](#)

MediaWiki

GNU Free Documentation License

- This page was last modified 00:16, 21 Aug 2004.
- All text is available under the terms of the [GNU Free Documentation License](#) (see

[Copyrights](#) for details).

- [About Wikipedia](#)
- [Disclaimers](#)

# Radar

From [Wikipedia](#), the free encyclopedia.

*This article is about the device. For the fictional character in M\*A\*S\*H, see [Corporal Walter \(Radar\) O'Reilly](#).*

---

This long range radar antenna (approximately 40m (130ft) in diameter) rotates on a track to observe activities near the horizon.



This long range radar [antenna](#) (approximately 40m (130ft) in [diameter](#)) rotates on a track to observe activities near the [horizon](#).

**Radar** is an [acronym](#) for **radio detection and ranging**. It is a system used to detect, range (determine the distance of), and map objects such as [aircraft](#) and [rain](#). Strong [radio](#) waves are transmitted, and a receiver listens for any [echoes](#). By analysing the reflected signal, the reflector can be located, and sometimes identified. Although the amount of signal returned is tiny, radio signals can easily be detected and [amplified](#).

Radar radio waves can be easily generated at any desired strength, detected at even tiny powers, and then amplified many times. Thus radar is suited to detecting objects at very large ranges where other reflections, like sound or visible light, would be too weak to detect.

## Contents

## [1 Electromagnetics](#)

### [1.1 Reflection](#)

### [1.2 Polarization](#)

### [1.3 Frequency bands](#)

## [2 Distance measurement](#)

### [2.1 Transit time](#)

### [2.2 Frequency modulation](#)

## [3 Signals](#)

## [4 Speed measurement](#)

### [4.1 Doppler effect](#)

### [4.2 Continuous wave](#)

## [5 Position measurement](#)

### [5.1 Early systems](#)

### [5.2 Phased array](#)

## [6 Types and uses of radar](#)

## [7 Radar equation](#)

## [8 History](#)

### [8.1 1800s](#)

### [8.2 1900s](#)

### [8.3 Microwaves](#)

### [8.4 United Kingdom and Germany](#)

### [8.5 Chain Home](#)

### [8.6 Later adaptations](#)

### [8.7 Magnetron](#)

### [8.8 German developments](#)

### [8.9 Würzburg](#)

### [8.10 Comparison](#)

## [9 Specific radar systems](#)

## [10 See also](#)

## [11 Further reading](#)

## [12 External links](#)

[\[edit\]](#)

# Electromagnetics

Radar sets attempt to reflect [electromagnetic waves](#), notably [radio waves](#) and [microwaves](#), from target objects. This reflection is then detected using a radio [receiver](#).

Electromagnetic waves reflect from any large change in the [dielectric](#) or diamagnetic constants. This means that a [solid](#) object in [air](#) or [vacuum](#), or other significant changes in [atomic density](#), will usually reflect radar waves. This is particularly true of [electrically](#)-conductive materials such as [metal](#), making radar particularly well suited to the detection of [aircraft](#) and [ships](#).

Electromagnetic waves do not travel well underwater; thus for underwater applications, [sonar](#), based on sound waves, has to be used instead of radar.

[\[edit\]](#)

## Reflection

Radar [waves](#) reflect in a variety of ways depending on the size of the radio wave and the shape of the target. If the radio wave is much shorter than the reflector's size, the wave will bounce off in a way similar to the way light bounces from a mirror. Early radars used very long [wavelengths](#) that were larger than the targets and received a vague signal, whereas modern systems use shorter [wavelengths](#) (a few [centimetres](#)) that can image objects the size of a loaf of bread or larger.

Radio waves always reflect from [curves](#) and [corners](#), in a way similar to glint from a rounded piece of [glass](#). The most reflective targets have 90° [angles](#) between the [reflective surfaces](#). A surface consisting of three flat surfaces meeting at a single corner, like the corner on a block, will always reflect directly back at the source. These so-called [corner cubes](#) are commonly used as radar reflectors to make otherwise difficult-to-detect objects easier to detect, and are often found on boats in order to improve their detection in a rescue situation. For generally the same reasons objects attempting to avoid detection will angle their surfaces in a way to eliminate corners, which leads to "odd" looking [stealth aircraft](#).

[\[edit\]](#)

## Polarization

[Polarization](#) is the direction that the wave vibrates. Radars use horizontal, vertical, and circular polarization to detect different types of reflections. For example, [circular polarization](#) is used to minimize the interference caused by rain. [Linear polarization](#) returns usually indicate metal surfaces, and help a search radar ignore rain. [Random](#) polarization returns usually indicate a fractal surface like [rock](#) or [dirt](#), and are used by [navigational](#) radars.



Brightness can indicate reflectivity as in this 1960 weather radar image. The radar's frequency determines what it can observe.

[Ed]

Brightness can indicate reflectivity as in this [1960](#) weather radar image. The radar's frequency determines what it can observe.

[edit]

## Frequency bands

The traditional band names originated as code-names during [World War II](#) and are still in military and aviation use throughout the world in the 21st century. They have been adopted in the United States by the [IEEE](#), and internationally by the [ITU](#). Most countries have additional regulations to control which parts of each band are available for civilian or military use.

Other users of the radio spectrum, such as the [broadcasting](#) and electronic countermeasures ([ECM](#)) industries, have replaced the traditional military designations with their own systems.

**Radar Frequency Bands**

| Band Name | Frequency Range          | Wavelength Range         | Notes                                                                                                      |
|-----------|--------------------------|--------------------------|------------------------------------------------------------------------------------------------------------|
| HF        | 3-30 <a href="#">MHz</a> | 10-100 <a href="#">m</a> | 'high frequency'                                                                                           |
| P         | < 300MHz                 | 1m +                     | 'P' for 'previous', applied retrospectively to early radar systems                                         |
| VHF       | 50-330MHz                | 0.9-6m                   | very long range, ground penetrating; 'very high frequency'                                                 |
| UHF       | 300-1000MHz              | 0.3-1m                   | very long range (e.g. <a href="#">ballistic</a> early warning), ground penetrating; 'ultra high frequency' |
| L         | 1-2 <a href="#">GHz</a>  | 15-30 <a href="#">cm</a> | long range <a href="#">air traffic control</a> and <a href="#">surveillance</a> ; 'L' for 'long'           |

|                |           |              |                                                                                                                                                                                                                                  |
|----------------|-----------|--------------|----------------------------------------------------------------------------------------------------------------------------------------------------------------------------------------------------------------------------------|
| S              | 2-4GHz    | 7.5-15cm     | terminal air traffic control, long range weather; 'S' for 'short'                                                                                                                                                                |
| C              | 4-8 GHz   | 3.75-7.5cm   | a compromise (hence 'C') between X and S bands; weather                                                                                                                                                                          |
| X              | 8-12 GHz  | 2.5-3.75 cm  | <a href="#">missile</a> guidance, marine radar, weather; in the <a href="#">USA</a> the narrow range 10.525GHz ±25MHz is used for <a href="#">airport</a> radar.                                                                 |
| K <sub>u</sub> | 12-18GHz  | 1.67-2.5cm   | high-resolution mapping, satellite altimetry; frequency just under K band (hence 'u')                                                                                                                                            |
| K              | 18-27GHz  | 1.11-1.67cm  | from <a href="#">German</a> <i>kurz</i> , meaning 'short'; useless, except for detecting clouds, because of absorption by <a href="#">water vapour</a> , so K <sub>u</sub> and K <sub>a</sub> were used instead for surveillance |
| K <sub>a</sub> | 27-40GHz  | 0.75-1.11cm  | mapping, short range, airport surveillance; frequency just above K band (hence 'a')                                                                                                                                              |
| mm             | 40-300GHz | 1 - 7.5mm    | 'millimetre' band, subdivided as below                                                                                                                                                                                           |
| V              | 40-75GHz  | 0.4 - 0.75cm |                                                                                                                                                                                                                                  |
| W              | 75-110GHz | 0.27 - 0.4cm |                                                                                                                                                                                                                                  |

[\[edit\]](#)

## Distance measurement

[\[edit\]](#)

### Transit time

The easiest way to measure the range of an object is to [broadcast](#) a short pulse of radio signal, and then time how long it takes for the reflection to return. The distance is one-half the round trip time (because the signal has to travel to the target and then back to the receiver) divided by the speed of the signal. For radar the speed is the [speed of light](#), making the round trip times very short. For this reason accurate distance measurement was difficult until the introduction of high performance electronics, with older systems being accurate to perhaps a few percent.

The receiver cannot detect the return while the signal is being sent out there's no way to tell if the signal it hears is the original or the return. This means that a radar has a distinct minimum [range](#), which is the length of the pulse divided by the speed of light, divided by two. In order to detect closer targets you have to use a shorter *pulse length*.

A similar effect imposes a specific maximum range as well. If the return from the target comes in when the next pulse is being sent out, once again the receiver cannot tell the difference. In order to maximize range, one wants to use longer times between pulses, the *inter-pulse* time.

These two effects tend to be at odds with each other, and it is not easy to combine both good short range and good long range in a single radar. This is because the short pulses needed for a good minimum range broadcast have less total [energy](#), making the returns much smaller and the target harder to detect. You could offset this by using more pulses, but this would shorten the maximum range again.

[\[edit\]](#)

## Frequency modulation

Another form of distance measuring radar is based on [frequency modulation](#). Frequency comparison between two signals is considerably more accurate, even with older electronics, than timing the signal. By changing the frequency of the returned signal and comparing that with the original, the difference can be easily measured.

This technique can be used in radar systems, and is often found in aircraft radar [altimeters](#). In these systems a "carrier" radar signal is frequency modulated in a predictable way, typically varying up and down with a [sine wave](#) or sawtooth pattern at audio frequencies. The signal is then sent out from one antenna and received on another, typically located on the bottom of the aircraft, and the signal can be continuously compared.

Since the signal frequency is changing, by the time the signal returns to the aircraft the broadcast has shifted to some other frequency. The amount of that shift is greater over longer times, so greater frequency differences mean a longer distance, the exact amount being the "ramp speed" selected by the electronics. The amount of shift is therefore directly related to the distance travelled, and can be displayed on an instrument. This signal processing is similar to that used in speed detecting [doppler](#) radar. See also the section on Continuous Wave radar below.

[\[edit\]](#)

## Signals

Each radar uses a particular type of [signal](#). Long range radars tend to use long pulses with long delays between them, and short range radars use smaller pulses with less time between them. This pattern of pulses and pauses is known as the *Pulse Repetition Frequency* (or *PRF*), and is one of the main ways to characterize a radar. As electronics have improved many radars now can change their PRF.

[\[edit\]](#)

# Speed measurement

**Speed** is the change in **distance** to an object with respect to **time**. Thus the existing system for measuring distance, combined with a little memory to see where the target last was, is enough to measure speed. At one time the memory consisted of a user making **grease-pencil** marks on the radar screen, and then calculating the speed using a **slide rule**.

[[edit](#)]

## Doppler effect

However there is another effect that can be used to make much more accurate speed measurements, and do so almost instantly (no **memory** required), known as the **Doppler effect**. The Doppler effect is the change in frequency of any signal due to the finite speed at which the signal travels compared to the motion of the object. For instance, sound travels at the fairly slow speed of around 300 m/s, which is why you hear the Doppler effect of an ambulance siren as it passes you at 3 m/s or so. Although this results in a small 1% change in frequency, the human ear is very good at detecting this change.

In the case of radar the speed of light is much faster than sound and thus the resulting shift much smaller. However modern electronics are even better at detecting this change than the human ear is for sound. Speeds as slow as a few centimeters per second can be easily measured, an accuracy typically much better than for the measurement of distance. Practically every modern radar system uses this principle, and is generally referred to as **Pulse Doppler Radar**.

The major use of Doppler is to separate moving objects from clutter. It's common for Doppler radars to have a *frequency range adjust* control to reject low speeds. Another form **color-codes** returns by their speed.

Doppler measures the speed only along the direction from the **reflection** to the radar antenna. In order to measure the object's true speed and direction, the radar set or operator had to remember a return's location. Military organizations traditionally used a manual plotting board for this purpose. **Computers** in the radar systems have made this even more convenient.

[[edit](#)]

## Continuous wave

It is possible to make a radar without any pulsing, known as a **Continuous Wave Radar** (or *CW*), by sending out a very pure signal of a known frequency. Return signals from targets are shifted away from this base frequency via the Doppler effect, so they can be picked up at another **antenna** even if it is physically close to the broadcaster.

The main advantage of the CW radars is that they have no pulsing, and thus no minimum or **maximum ranges** (although the broadcast strength imposes a practical limit on the latter) as well as maximizing power on the target. However they also have the disadvantage of only being able to

detect moving targets, as motionless ones (along the [line of sight](#)) will not cause a Doppler shift and the signal from such a target will be filtered out. Such systems thus find themselves being used at either end of the range spectrum, as radio-altimeters at the close-range end (where the range may be a few [feet](#)) and long distance early-warning radars at the other.

CW radars have the disadvantage that they cannot measure distance, because there are no pulses to time. In order to correct for this problem, frequency shifting methods can be used. When a reflection is received the frequencies can be examined, and by knowing when in the past that particular frequency was sent out, you can do a range calculation similar to using a pulse. It is generally not easy to make a broadcaster that can send out random frequencies cleanly, so instead these [Frequency Modulated Continuous Wave Radar](#) (*FMCW*), use a smoothly varying "ramp" of frequencies up and down. For this reason they are also known as a *chirped* radar.

[\[edit\]](#)

## Position measurement

Radio signals broadcast from a single antenna will spread out in all directions, and likewise a single antenna will receive signals equally from all directions. This leaves the radar with the problem of deciding where the target object is located.

[\[edit\]](#)

## Early systems

Early systems tended to use [omni-directional broadcast](#) antennas, with directional receiver antennas which were pointed in various directions. For instance the first system to be deployed, [chain home](#), used two straight antennas at [right angles](#) for reception, each on a different display. The maximum return would be detected with an antenna at right angles to the target, and a minimum with the antenna pointed directly at it (end on). The operator could determine the direction to a target by [rotating](#) the antenna so one display showed a maximum while the other shows a minimum.

One serious limitation with this type of solution is that the broadcast is sent out in all directions, so the amount of energy in the direction being examined is subject to the [inverse square law](#). To get a reasonable amount of power on the "target", the broadcast should also be steered. More modern systems used a steerable [parabolic](#) "dish" to create a tight broadcast beam, typically using the same dish as the receiver. Such systems often combined two radar frequencies in the same antenna in order to allow automatic steering, or **radar lock**.

Not all radar antennas must rotate to scan the sky.

[E]

Not all radar antennas must rotate to scan the sky.

[edit]

## Phased array

Another method of steering is used in *phased array radar*, which uses the radio signal's interference with itself. If one were to broadcast a single signal from a large number of antennas, the result will be a single beam with the waves in the rest of [space](#) cancelling each other. If the phase of the signal is changed before broadcast, the direction of the beam can be moved because the point of constructive interference will move. Instead of constructing a single large antenna, such a system has a number of small omni-directional antennas referred to as *elements*, usually arranged in a flat plate.

Phased array radars require no physical [movement](#). The beam can be steered by electronically adjusting the [delay lines](#) to each antenna. This means that the beam can scan at thousands of degrees per second, fast enough to irradiate many individual targets, and still run a wide-ranging search periodically. By simply turning some of the antennas on or off, the beam can be spread for searching, narrowed for tracking, or even split into two or more virtual radars.

Phased array radars have been in use since the earliest years of radar use in [World War II](#), but limitations of the electronics led to fairly poor accuracy. Phased array radars were originally used for [missile defense](#). On [ships](#), they are the heart of the [Aegis combat system](#), and are increasingly used in other areas because the lack of moving parts makes them more reliable, and sometimes permits a much larger effective antenna.

As the price of electronics has fallen, phased array radars have become more and more common. Almost all modern military radar systems are based on phased arrays, where the small additional cost is far offset by the improved reliability of a system with no moving parts. Traditional moving-antenna designs are now limited to roles where cost is the main factor, weather radars and similar systems.

Phased array radars are also valued for use in aircraft, since they can track multiple targets. The first aircraft to use phased array radar was the [Mikoyan MiG-31](#).

[edit]

# Types and uses of radar

- "*Search radars*" scan a wide area with pulses of short radio waves. They usually scan the area two to four times a minute. The waves are usually less than a meter long. Ships and planes are metal, and reflect radio waves. The radar measures the distance to the reflector by measuring the time from emission of a pulse to reception, and dividing by the speed of light. To be accepted, the received pulse has to lie within a period of time called the *range gate*. The radar determines the direction because the short radio waves behave like a search light when emitted from the reflector of the radar set's antenna.
- "*Targeting radars*" use the same principle but scan a much smaller area far more often, usually several times a second or more, where a search radar might scan a few times per minute. Some targeting radars have a range gate that can track a target, to eliminate clutter and electronic counter-measures.
- "*Radar [proximity fuses](#)*" are attached to [anti-aircraft artillery](#) shells or other [explosive](#) devices, and detonate the device when it approaches a large object. They use a small rapidly pulsing omnidirectional radar, usually with a powerful battery that has a long storage life, and a very short operational life. The fuses used in anti-aircraft artillery have to be mechanically designed to accept fifty thousand [gravities of acceleration](#), yet still be cheap enough to throw away.
- "*Weather radars*" can resemble search radars. These radar use radio waves with horizontal, dual (horizontal and vertical), or circular polarization. The frequency selection of weather radar is a performance compromise between precipitation reflectivity and attenuation due to atmospheric water vapor. Some weather radar uses [doppler](#) to measure wind speeds.
- "*Navigational radars*" resemble search radar, but use very short waves that reflect from earth and stone. They are common on commercial ships and long-distance commercial aircraft.
- "*General purpose radars*" are increasingly being substituted for pure navigational radars. These generally use navigational radar frequencies, but modulate the pulse so the receiver can determine the type of surface of the reflector. The best general-purpose radars distinguish the rain of heavy storms, as well as land and vehicles. Some can superimpose sonar and map data from [GPS](#) position.
- "*Radar altimeters*" measure an aircraft's true height above ground.
- [Air traffic control](#) uses Primary and Secondary Radars
  - **Primary radar** is a "classical" radar which reflects all kind of echoes, including [aircraft](#) and clouds.
  - **Secondary radar** emit pulses and listen for special answer of digital data emitted by an Aircraft [Transponder](#) as an answer. Transponders emit different kind of data like a 4 octal ID (mode A), the onboard calculated altitude (mode C) or the Callsign (not the [flight number](#)) (mode S). Military use transponders to establish the nationality and intention of an aircraft, so that air defenses can identify possibly hostile radar returns.

- "Mapping radars" are used to scan a large region for [remote sensing](#) and [geography](#) applications. They generally use [synthetic aperture radar](#), which limits them to relatively static targets, normally terrain.
- [Wearable radar](#) (<http://www.wearcam.org/ece431/labs/lab3/lab3.htm>) and miniature radar systems are used as electric seeing aids for the visually impaired, as well as early warning collision detection and situational awareness.

[\[edit\]](#)

## Radar equation

The amount of power  $P_r$  returning to the receiving antenna is given by the radar equation:

$$P_r = \frac{P_t G_t A_r \sigma}{(4\pi)^2 R_t^2 R_r^2}$$

where

- $P_t$  = transmitter power,
- $G_t$  = gain of transmitting antenna,
- $A_r$  = area of receiving antenna,
- $\sigma$  = scattering coefficient of target,
- $R_t$  = distance from transmitter to target,
- $R_r$  = distance from target to receiver.

In the common case where the transmitter and receiver are at the same location,  $R_t = R_r$  and the term  $R_t^2 R_r^2$  can be replaced by  $R^4$ , where  $R$  is the range. This shows that the received power declines as the fourth power of the range, which means that the reflected power from distant targets is very, very small.

Other mathematical developments in radar signal processing include time-frequency analysis (Weyl Heisenberg or wavelet), as well as [the chirplet transform](#) (<http://wearcam.org/chirplet>) which makes use of the fact that radar returns from moving targets typically "chirp" (change their frequency as a function of time, as does the sound of a bird or bat).

[\[edit\]](#)

## History

[\[edit\]](#)



## 1800s

In [1887](#) the German physicist [Heinrich Hertz](#) began experimenting with radio waves in his laboratory. He found that radio waves could be transmitted through different types of materials, and were reflected by others. The existence of [electromagnetic waves](#) was predicted earlier by [James Clerk Maxwell](#), but it was Hertz who first succeeded in generating and detecting radio waves experimentally.

[\[edit\]](#)

## 1900s

By the 1900s a [German engineer](#), [Chistian Huelsmeyer](#), proposed the use of radio echoes to avoid collisions. He invented a device he called the **telemobiloscope**, which consisted of a simple [spark gap](#) aimed using a [funnel](#)-shaped [metal antenna](#). When a reflection was seen by the two straight antennas attached to the receiver, a bell sounded. Although very simple, the system could detect [shipping](#) accurately up to about 3 km. Nevertheless the [naval](#) world seemed uninterested in his invention, and it was not put into production.

[Nikola Tesla](#), in [August 1917](#), proposed principles regarding frequency and power levels for primitive RADAR units. Tesla's study of [high-voltage](#), [high-frequency alternating currents](#) led to this development. Tesla had formed the concept of using radio waves to detect objects at a distance. In the 1917 *The Electrical Experimenter*, Tesla stated the principles in detail.

Tesla stated, "*For instance, by their [standing electromagnetic waves] use we may produce at will, from a sending station, an electrical effect in any particular region of the globe; [with which] we may determine the relative position or course of a moving object, such as a vessel at sea, the distance traversed by the same, or its speed.*" Tesla also proposed the use of these [standing electromagnetic waves](#) along with pulsed reflected waves to determine the relative position, speed, and course of a moving object and other modern concepts of radar.

Tesla had first proposed that radio location might help find [submarines](#) (for which it is not well-suited) with a fluorescent screen indicator, though it was first applied successfully to locate [aircraft](#) (after their later proliferation) and surface [ships](#) during [World War II](#). [Emil Girardeau](#), working with the first [French](#) radar systems, stated he was building radar systems "*conceived according to the principles stated by Tesla*". Tesla first established principles regarding frequency and power level for the first primitive RADAR units in [1934](#).

On [February 12, 1935](#), [Robert Watson-Watt](#) sent a memo of a proposed RADAR system to the [British Air Ministry](#), entitled "*Detection and location of aircraft by radio methods*". The invention of modern radar is generally credited to Watson-Watt. In [1915](#) he joined the [Royal Aircraft Factory](#) at Ditton Park, in [Hampshire](#), [England](#), as a [meteorologist](#), where he attempted to use radio signals generated by lightning strikes to map out thunderstorms. The difficulty in pinpointing the direction of these high-speed signals led to the use of rotating directional antennas, and in [1923](#) the use of [oscilloscopes](#) in order to display them in 2-D. At this point the only missing part of a

functioning radar was the broadcaster.

In [1934](#), Watson-Watt was well established in the area of radio, and was approached by H.E. Wimperis from the Air Ministry, who asked about the use of radio to produce a '[death ray](#)'. While he knew this to be unlikely, he pointed out that in the absence of progress, 'meanwhile attention is being turned to the still difficult, but less unpromising, problem of radio detection and numerical considerations on the method of detection by reflected radio waves will be submitted when required.' Watson-Watt and his assistant Arnold Wilkins published a report on the topic in February [1935](#), titled *The Detection of Aircraft by Radio Methods*.

By the time [World War 2](#) began, viable radar technology existed in the oscilloscope type [SCR-270 Radar](#).

[\[edit\]](#)

## Microwaves

Meanwhile in Germany, Hans Eric Hollmann had been working for some time in the field of microwaves, which were to later become the basis of almost all radar systems. In 1935 he published *Physics and Technique of Ultrashort Waves*, which was then picked up by researchers around the world. At the time he had been most interested in their use for communications, but he and his partner Hans-Karl von Willisen had also worked on radar-like systems.

In the autumn of 1934 their company, GEMA, built the first commercial radar system for detecting ships. Operating in the 50 cm range it could detect ships up to 10 km away, similar in purpose to Huelsmeyer's earlier device. In the summer of 1935 a pulse radar was developed with which they could spot the ship the *Königsberg* 8 km away, with an accuracy of up to 50 m, enough for gun-laying. The same system could also detect an aircraft at 500 m altitude at a distance of 28 km. The military implications were not lost this time around, and construction of land and sea-based versions took place as **Freya** and **Seetakt**.

[\[edit\]](#)

## United Kingdom and Germany

At this point both the [United Kingdom](#) and [Nazi Germany](#) knew of each other's ongoing efforts in their [arms race](#). Both nations were intensely interested in the other's developments in the field, and engaged in an active campaign of espionage and false leaks about their respective equipment. But it was only in Britain that the usefulness of the system became obvious, so while the German systems had the edge technologically (operating on much shorter wavelengths) only Britain started true mass deployment of both the radars and the control systems needed to support them.

[\[edit\]](#)

## Chain Home

Shortly before the outbreak of [World War II](#) several radar stations known as [Chain Home](#) (or *CH*) were constructed in the south of England. As one might expect from the first radar to be deployed, CH was a simple system. The broadcast side was formed from two 300' (100 m) tall steel towers strung with a series of cables between them. The output of a powerful 50 MHz radio of about 200 kW (up to 800 kW in later models) was fed into these cables, pulsed at about 50 times a second. A second set of 240' (73 m) tall wooden towers were used for reception, with a series of crossed antennas at various heights up to 215' (65 m). Most stations had more than one set of each antenna, tuned to operate at different frequencies.

The CH radar was read with an oscilloscope. When a pulse was sent out into the broadcast towers, the scope was triggered to start its beam moving horizontally across the screen very rapidly. The output from the receiver was amplified and fed into the vertical axis of the scope, so a return from an aircraft would deflect the beam upward. This formed a spike on the display, and the distance from the left side - measured with a small scale on the bottom of the screen - would give the distance to the target. By rotating the receiver antennas to make the display disappear, the operator could determine the direction (this is the reason for the cross shaped antennas), the size of the vertical displacement indicated something of the number of aircraft involved, and by comparing the strengths returned from the various antennas up the tower, the altitude could be determined.

CH proved highly effective during the [Battle of Britain](#), and is often credited with allowing the [RAF](#) to defeat the much larger [Luftwaffe](#) forces. Whereas the Luftwaffe had to hunt all over to find the RAF fighters, the RAF knew exactly where the Luftwaffe bombers were, and could converge all of their fighters on them. The RDF stations only worked over the sea, and the positions of enemy aircraft over land had to be relayed by observers and aircraft.

Very early in the battle the Luftwaffe made a series of small raids on a few of the stations, but they were returned to operation in a few days. In the meantime the operators took to broadcasting radar-like signals from other systems in order to fool the Germans into believing that the systems were still operating. Eventually the Germans gave up trying to bomb them. The Luftwaffe apparently never understood the importance of radar to the RAF's efforts, or they would have assigned them a much higher priority -- it is clear they could have knocked them out continually if they wished.

In order to avoid the CH system the Luftwaffe adopted other tactics. One was to approach Britain at very low levels, below the sight line of the radar stations. This was countered to some degree with a series of shorter range stations built right on the coast, known as **Chain Home Low** (*CHL*). These radars had originally been intended to use for naval gun-laying and known as **Coastal Defense** (*CD*), but their narrow beams also meant they could sweep an area much closer to the ground without seeing the reflection of the ground (or water) itself. Unlike the larger CH systems, CHL had to have the broadcast antenna itself turned, as opposed to just the receiver. This was done manually on a pedal-crank system run by WAAFs until more reliable motorized movements were installed in 1941.

[\[edit\]](#)

## Later adaptations

Similar systems were later adapted with a new display to produce the **Ground Controlled Intercept** stations starting in late 1941. In these systems the antenna was rotated mechanically, followed by the display on the operators console. That is, instead of a single line across the bottom of the display from left to right, the line was rotated around the screen at the same speed as the antenna was turning.

The result was a 2-D display of the air around the station with the operator in the middle, with all the aircraft appearing as dots in the proper location in space. These so-called **Plan Position Indicators** (*PPI*) dramatically simplified the amount of work needed to track a target on the operator's part. Such a system with a rotating, or sweeping, line is what most people continue to associate with a radar display.

Rather than avoid the radars, the Luftwaffe took to avoiding the fighters by flying at night and in bad weather. Although the RAF was aware of the location of the bombers, there was little they could do about them unless the fighter pilots could see the opposing planes. However, just this eventuality had already been foreseen, and Watson-Watt (likely at the urging of Tizzard) had already started work on a miniaturized radar system suitable for aircraft, the so-called **AI** (*airborne interception*) set. Initial sets were available in 1941 and fitted to [Bristol Blenheim](#) aircraft, replaced quickly with the better performing [Bristol Beaufighter](#), which quickly put an end to German night- and bad-weather bombing over England.

[\[edit\]](#)

## Magnetron

The next major development in the history of radar was the invention of the [cavity magnetron](#) by Randall and Boot of [Birmingham University](#) in early 1940. This was a small device which generated much more powerful [microwaves](#) than previous devices, which in turn allowed for the detection of much smaller objects and the use of much smaller antennas. The secrecy of the device was so high that it was decided in 1940 to move production to the USA, which resulted in the creation of the [MIT Radiation Lab](#) to develop the device further.

[\[edit\]](#)

## German developments

German developments mirrored those in the United Kingdom, but it appears radar received a much lower priority until later in the war. The [Freya](#) was in fact much more sophisticated than its CH counterpart, and by operating in the 1.2 m wavelength (as opposed to ten times that for the CH) the Freya was able to be much smaller and yet offer better resolution. Yet by the start of the war only eight of these units were in operation, offering much less coverage.

However the Germans did not have an airborne system of any sort deployed until [1942](#), leaving them with the problem of having to get their [fighters](#) into that 300m range solely with ground-based equipment. To fill this need another system known as [Würzburg](#) was deployed,

starting in [1941](#).

[[edit](#)]

## Würzburg

Unlike other systems, the Würzburg was mounted on a highly directional parabolic antenna that was sensitive in only one direction. This made it useless for finding the targets, but once guided to one by an associated Freya it could track it with extreme accuracy: later models were accurate to 0.2 degrees or less. In order to do this the radar sent out two lobes and the return of each was shown on the display. By keeping the returns from both the same strength, the operator kept the Würzburg pointed directly at the target.

The downfall of the German [radar network](#) was that it could only track a single aircraft per Würzburg. In fact the system required two Würzburgs per interception, one for the target, and one for the fighter. This meant that as a raid developed, only a few night fighters could be directed at any one time, as only a small number of the eventual 5,000 Würzburgs would be within their 25km range at any one time.

[[edit](#)]

## Comparison

Compared to the British PPI systems, the German system was far more labour intensive. This problem was compounded by the lackadaisical approach to command staffing. It was several years before the Luftwaffe had a command and control system nearly as sophisticated as the one set up by Watt before the war, after seeing the confusion too much information caused during one test.

German airborne radar units followed a similar pattern. Early **Lichtenstein BC** units were not deployed until 1942, and as they operated on the 2 m wavelength they required large antennas. By this point in the war the British had become experts on jamming German radars, and when a BC-equipped Ju 88 night fighter landed in England one foggy night, it was only a few weeks before the system was rendered completely useless. By late 1943 the Luftwaffe was starting to deploy the greatly improved **SN-2**, but this required huge antennas that slowed the planes as much as 50 km/h. Jamming the SN-2 took longer, but was accomplished. A 9 cm wavelength system known as **Berlin** was eventually developed, but only in the very last months of the war.

[[edit](#)]

## Specific radar systems

- [X-band radar](#)
- [Millimeter cloud radar](#)
- [Doppler radar](#) as weather radar
  - [NEXRAD](#)
- [Radar gun](#) traffic and sports radars

- [Synthetic aperture radar](#)
- [Active Electronically Scanned Array](#) (AESA)

[\[edit\]](#)

## See also

- [LIDAR](#)
- [Sonar](#)
- [Air defense artillery](#)
- [Texas Towers](#)
- [ASTOR](#)
- [Airborne Warning and Control System](#) (AWACS)
-

# Wikipedia:Today's featured article/September 2004

From [Wikipedia](#), the free encyclopedia.

< [Wikipedia:Today's featured article](#)

2004 archive: [February](#) - [March](#) - [April](#) - [May](#) - [June](#) - [July](#) - [August](#) - **September** - [October](#) - [November](#) - [December](#)

---

Today is [Monday, September 6, 2004](#); it is now 03:50 ([UTC](#))

---

[\[edit\]](#)

## Today's featured articles for September 2004

An archive of *Wikipedia's featured articles* that appeared on the [Main Page](#)

---

September 1

A common scold gets her  
comeuppance in the cucking  
stool

Under [English common law](#), a **common scold** was a species of public nuisance a troublesome and angry woman who broke the public peace by habitually arguing and quarrelling with her neighbours. The [Latin](#) name for the offender, *communis rixatrix*, appears in the feminine gender, and makes it clear that only women could commit this crime. The prescribed penalty for this offence involved dunking the convicted offender in water in an instrument called the [cucking stool](#), which by [folk etymology](#) became ducking stool. The stool consisted of a chair attached to a lever, suspended over a body of water; the prisoner was strapped into the chair and dunked into the water for her punishment.

Recently featured: [Ferdinand Magellan](#) [Tank](#) [Traditional counties of England](#)

[Archive](#) [By email](#) [More featured articles](#)

[view](#) - [talk](#) - [history](#)

([http://en.wikipedia.org/w/wiki.phtml?title=Wikipedia:Today%27s\\_featured\\_article/September\\_1,\\_2004&action=history](http://en.wikipedia.org/w/wiki.phtml?title=Wikipedia:Today%27s_featured_article/September_1,_2004&action=history))

---

September 2



**Laika** was one of the [Russian space dogs](#) and the first living being to enter [orbit](#), as a passenger on [Sputnik 2](#), a [Soviet](#) spacecraft. Some classify her as the [first animal to enter space](#), although other animals had entered [space](#) during [sub-orbital](#) flights on previous missions. Laika was found as a stray wandering the streets of [Moscow](#), a female part-[Samoyed terrier](#) weighing approximately 6 kg (13 lb). Laika died on [November 4, 1957](#), a few hours after launch, due to [stress](#) and [overheating](#). Her true [cause of death](#) was not made public until years after the flight, with officials always stating that she was either [euthanized](#) by [poisoned](#) food or died when the oxygen supply ran out. Russian officials have since expressed

regret for allowing Laika to die; to this date, Laika is the only living passenger ever to have been launched into space without the intention of retrieval.

Recently featured: [Common scold](#) [Ferdinand Magellan](#) [Tank](#)

**Archive** [By email](#) [More featured articles](#)

[view](#) - [talk](#) - [history](#)

([http://en.wikipedia.org/w/wiki.phtml?title=Wikipedia:Today%27s\\_featured\\_article/September\\_2,\\_2004&action=history](http://en.wikipedia.org/w/wiki.phtml?title=Wikipedia:Today%27s_featured_article/September_2,_2004&action=history))

---

September 3



The [Behistun Inscription](#) is to [cuneiform](#) what the [Rosetta Stone](#) is to [Egyptian hieroglyphs](#): the document most crucial in the [decipherment](#) of a previously lost script. The inscription is approximately 15 metres high by 25 metres wide, and 100 metres up a cliff from an ancient road connecting the capitals of [Babylonia](#) and [Media](#) ([Babylon](#) and [Ecbatana](#)). It is extremely inaccessible as the mountainside was removed to make the inscription more visible after its completion. The text itself is a statement by [Darius I of Persia](#), written three times in three different scripts and languages: two languages side by side, [Old Persian](#) and [Elamite](#), and [Akkadian](#) above them.

Recently featured: [Laika](#) [Common scold](#) [Ferdinand Magellan](#)

**Archive** [By email](#) [More featured articles](#)

[view](#) - [talk](#) - [history](#)

([http://en.wikipedia.org/w/wiki.phtml?title=Wikipedia:Today%27s\\_featured\\_article/September\\_3,\\_2004&action=history](http://en.wikipedia.org/w/wiki.phtml?title=Wikipedia:Today%27s_featured_article/September_3,_2004&action=history))

---

September 4



In [computer security](#), [PaX](#) is a [patch](#) for the [Linux kernel](#) that implements least privilege protections for [memory pages](#). This approach allows [computer programs](#) to do only what they have to be able to do to execute properly, and nothing more. PaX flags data memory as non-executable and program memory as non-writable; and randomly arranges the program memory. This effectively prevents many [security exploits](#), such as those stemming from [buffer overflows](#). The former prevents direct [code injection](#) absolutely; while the latter makes so-called [return-to-libc](#) (ret2libc) attacks indeterminate, relying on luck to succeed. PaX was first released in [2000](#).

Recently featured: [Behistun Inscription](#) [Laika](#) [Common scold](#)

**Archive** [By email](#) [More featured articles](#)

[view](#) - [talk](#) - [history](#)

([http://en.wikipedia.org/w/wiki.phtml?title=Wikipedia:Today%27s\\_featured\\_article/September\\_4,\\_2004&action=history](http://en.wikipedia.org/w/wiki.phtml?title=Wikipedia:Today%27s_featured_article/September_4,_2004&action=history))

---

September 5





**Anno Domini** (**Latin** for "In the Year of the Lord"; commonly abbreviated AD) refers to the conventional numbering of years in the **Julian** and **Gregorian calendars**. It defines an **epoch** based on the traditionally reckoned year of the birth of **Jesus**. Years before the epoch were denoted *a.C.n.* (for *Ante Christum Natum*, **Latin** for "before the birth of Christ"), although *BC* (Before Christ) is now usually used in **English**. The Anno Domini era is the only system in everyday use in the Western hemisphere, and the main system for commercial and scientific use in the rest of the world. Some non-**Christians** or secular persons, however, object to a system based upon an event in the Christian faith; for this reason, the same epoch is also referred to as the *Common Era*, abbreviated *CE*.

Recently featured: [PaX](#) [Behistun Inscription](#) [Laika](#)

**Archive** [By email](#) [More featured articles](#)

[view](#) - [talk](#) - [history](#)

([http://en.wikipedia.org/w/wiki.phtml?title=Wikipedia:Today%27s\\_featured\\_article/September\\_5,\\_2004&action=history](http://en.wikipedia.org/w/wiki.phtml?title=Wikipedia:Today%27s_featured_article/September_5,_2004&action=history))

---

September 6



The **Warsaw Uprising** was an armed struggle during the **Second World War** by the **Polish Home Army** (Armia Krajowa) to liberate **Warsaw** from **German** occupation and **Nazi** rule. It started on **August 1, 1944** as a part of a nationwide **uprising**, **Operation Tempest**. The Polish troops resisted the German-led forces until **October 2**. An estimated 85% of the city was destroyed during the urban **guerrilla** war and after the end of hostilities. The Uprising started at a crucial point in the war as the **Soviet** army was approaching Warsaw. Although the Soviet army was within a few hundred metres of the city from **September 16** onward, the link between the uprising and the advancing army was never made. This failure and the reasons behind it have been a matter of controversy ever since.

Recently featured: [Anno Domini](#) [PaX](#) [Behistun Inscription](#)

**Archive** [By email](#) [More featured articles](#)

[view](#) - [talk](#) - [history](#)

([http://en.wikipedia.org/w/wiki.phtml?title=Wikipedia:Today%27s\\_featured\\_article/September\\_6,\\_2004&action=history](http://en.wikipedia.org/w/wiki.phtml?title=Wikipedia:Today%27s_featured_article/September_6,_2004&action=history))

---

September 7



**Elizabeth I** was [Queen of England](#) and [Queen of Ireland](#) from [17 November 1558](#) until her death. Sometimes referred to as *The Virgin Queen*, Elizabeth I was the fifth and last monarch of the [Tudor dynasty](#), succeeding her half-sister, [Mary I](#). She reigned over a period of deep religious division in [English](#) history. Elizabeth's reign is referred to as the [Elizabethan era](#) and was marked by several changes in English culture. Elizabeth was a short-tempered, sometimes indecisive ruler. Like her father [Henry VIII](#), she was a writer and poet. She granted [Royal Charters](#) to several famous organisations, including [Trinity College, Dublin](#) (1592) and the [British East India Company](#) (1600).

Recently featured: [Warsaw Uprising](#) [Anno Domini](#) [Anno Domini](#)

[Archive](#) [By email](#) [More featured articles](#)

[view](#) - [talk](#) - [history](#)

([http://en.wikipedia.org/w/wiki.phtml?title=Wikipedia:Today%27s\\_featured\\_article/September\\_7,\\_2004&action=history](http://en.wikipedia.org/w/wiki.phtml?title=Wikipedia:Today%27s_featured_article/September_7,_2004&action=history))

---

September 8

*The [featured article](#) for this day has not been chosen yet. See [Wikipedia:Today's featured article](#) for guidelines.*

[Archive](#) [More featured articles ...](#)

[view](#) - [talk](#) - [history](#)

([http://en.wikipedia.org/w/wiki.phtml?title=Wikipedia:Today%27s\\_featured\\_article/September\\_8,\\_2004&action=history](http://en.wikipedia.org/w/wiki.phtml?title=Wikipedia:Today%27s_featured_article/September_8,_2004&action=history))

---

September 9

*The [featured article](#) for this day has not been chosen yet. See [Wikipedia:Today's featured article](#) for guidelines.*

[Archive](#) [More featured articles ...](#)

[view](#) - [talk](#) - [history](#)

([http://en.wikipedia.org/w/wiki.phtml?title=Wikipedia:Today%27s\\_featured\\_article/September\\_9,\\_2004&action=history](http://en.wikipedia.org/w/wiki.phtml?title=Wikipedia:Today%27s_featured_article/September_9,_2004&action=history))

---

September 10

*The [featured article](#) for this day has not been chosen yet. See [Wikipedia:Today's featured article](#) for guidelines.*

[Archive](#) [More featured articles ...](#)

[view](#) - [talk](#) - [history](#)

([http://en.wikipedia.org/w/wiki.phtml?title=Wikipedia:Today%27s\\_featured\\_article/September\\_10,\\_2004&action=history](http://en.wikipedia.org/w/wiki.phtml?title=Wikipedia:Today%27s_featured_article/September_10,_2004&action=history))

---

September 11

*The [featured article](#) for this day has not been chosen yet. See [Wikipedia:Today's featured article](#) for guidelines.*

**Archive** [More featured articles ...](#)

[view](#) - [talk](#) - [history](#)

([http://en.wikipedia.org/w/wiki.phtml?title=Wikipedia:Today%27s\\_featured\\_article/September\\_11,\\_2004&action=history](http://en.wikipedia.org/w/wiki.phtml?title=Wikipedia:Today%27s_featured_article/September_11,_2004&action=history))

---

September 12

*The [featured article](#) for this day has not been chosen yet. See [Wikipedia:Today's featured article](#) for guidelines.*

**Archive** [More featured articles ...](#)

[view](#) - [talk](#) - [history](#)

([http://en.wikipedia.org/w/wiki.phtml?title=Wikipedia:Today%27s\\_featured\\_article/September\\_12,\\_2004&action=history](http://en.wikipedia.org/w/wiki.phtml?title=Wikipedia:Today%27s_featured_article/September_12,_2004&action=history))

---

September 13

[Template:TFAempty](#)

**Archive** [More featured articles ...](#)

[view](#) - [talk](#) - [history](#)

([http://en.wikipedia.org/w/wiki.phtml?title=Wikipedia:Today%27s\\_featured\\_article/September\\_13,\\_2004&action=history](http://en.wikipedia.org/w/wiki.phtml?title=Wikipedia:Today%27s_featured_article/September_13,_2004&action=history))

---

September 14

[Template:TFAempty](#)

**Archive** [More featured articles ...](#)

[view](#) - [talk](#) - [history](#)

([http://en.wikipedia.org/w/wiki.phtml?title=Wikipedia:Today%27s\\_featured\\_article/September\\_14,\\_2004&action=history](http://en.wikipedia.org/w/wiki.phtml?title=Wikipedia:Today%27s_featured_article/September_14,_2004&action=history))

---

September 15

[Template:TFAempty](#)

**Archive** [More featured articles ...](#)

[view](#) - [talk](#) - [history](#)

([http://en.wikipedia.org/w/wiki.phtml?title=Wikipedia:Today%27s\\_featured\\_article/September\\_15,\\_2004&action=history](http://en.wikipedia.org/w/wiki.phtml?title=Wikipedia:Today%27s_featured_article/September_15,_2004&action=history))

---

September 16

[Template:TFAempty](#)

**Archive** [More featured articles ...](#)

[view](#) - [talk](#) - [history](#)

([http://en.wikipedia.org/w/wiki.phtml?title=Wikipedia:Today%27s\\_featured\\_article/September\\_16,\\_2004&action=history](http://en.wikipedia.org/w/wiki.phtml?title=Wikipedia:Today%27s_featured_article/September_16,_2004&action=history))

---

September 17

[Template:TFAempty](#)

**Archive** [More featured articles ...](#)

[view](#) - [talk](#) - [history](#)

([http://en.wikipedia.org/w/wiki.phtml?title=Wikipedia:Today%27s\\_featured\\_article/September\\_17,\\_2004&action=history](http://en.wikipedia.org/w/wiki.phtml?title=Wikipedia:Today%27s_featured_article/September_17,_2004&action=history))

---

September 18

[Template:TFAempty](#)

**Archive** [More featured articles ...](#)

[view](#) - [talk](#) - [history](#)

([http://en.wikipedia.org/w/wiki.phtml?title=Wikipedia:Today%27s\\_featured\\_article/September\\_18,\\_2004&action=history](http://en.wikipedia.org/w/wiki.phtml?title=Wikipedia:Today%27s_featured_article/September_18,_2004&action=history))

---

September 19

[Template:TFAempty](#)

**Archive** [More featured articles ...](#)

[view](#) - [talk](#) - [history](#)

([http://en.wikipedia.org/w/wiki.phtml?title=Wikipedia:Today%27s\\_featured\\_article/September\\_19,\\_2004&action=history](http://en.wikipedia.org/w/wiki.phtml?title=Wikipedia:Today%27s_featured_article/September_19,_2004&action=history))

---

September 20

[Template:TFAempty](#)

**Archive** [More featured articles ...](#)

[view](#) - [talk](#) - [history](#)

([http://en.wikipedia.org/w/wiki.phtml?title=Wikipedia:Today%27s\\_featured\\_article/September\\_20,\\_2004&action=history](http://en.wikipedia.org/w/wiki.phtml?title=Wikipedia:Today%27s_featured_article/September_20,_2004&action=history))

---

September 21

[Template:TFAempty](#)

**Archive** [More featured articles ...](#)

[view](#) - [talk](#) - [history](#)

([http://en.wikipedia.org/w/wiki.phtml?title=Wikipedia:Today%27s\\_featured\\_article/September\\_21,\\_2004&action=history](http://en.wikipedia.org/w/wiki.phtml?title=Wikipedia:Today%27s_featured_article/September_21,_2004&action=history))

---

September 22

[Template:TFAempty](#)

**Archive** [More featured articles ...](#)

[view](#) - [talk](#) - [history](#)

([http://en.wikipedia.org/w/wiki.phtml?title=Wikipedia:Today%27s\\_featured\\_article/September\\_22,\\_2004&action=history](http://en.wikipedia.org/w/wiki.phtml?title=Wikipedia:Today%27s_featured_article/September_22,_2004&action=history))

---

September 23

[Template:TFAempty](#)

**Archive** [More featured articles ...](#)

[view](#) - [talk](#) - [history](#)

([http://en.wikipedia.org/w/wiki.phtml?title=Wikipedia:Today%27s\\_featured\\_article/September\\_23,\\_2004&action=history](http://en.wikipedia.org/w/wiki.phtml?title=Wikipedia:Today%27s_featured_article/September_23,_2004&action=history))

---

September 24

[Template:TFAempty](#)

**Archive** [More featured articles ...](#)

[view](#) - [talk](#) - [history](#)

([http://en.wikipedia.org/w/wiki.phtml?title=Wikipedia:Today%27s\\_featured\\_article/September\\_24,\\_2004&action=history](http://en.wikipedia.org/w/wiki.phtml?title=Wikipedia:Today%27s_featured_article/September_24,_2004&action=history))

---

September 25

[Template:TFAempty](#)

**Archive** [More featured articles ...](#)

[view](#) - [talk](#) - [history](#)

([http://en.wikipedia.org/w/wiki.phtml?title=Wikipedia:Today%27s\\_featured\\_article/September\\_25,\\_2004&action=history](http://en.wikipedia.org/w/wiki.phtml?title=Wikipedia:Today%27s_featured_article/September_25,_2004&action=history))

---

September 26

[Template:TFAempty](#)

**Archive** [More featured articles ...](#)

[view](#) - [talk](#) - [history](#)

([http://en.wikipedia.org/w/wiki.phtml?title=Wikipedia:Today%27s\\_featured\\_article/September\\_26,\\_2004&action=history](http://en.wikipedia.org/w/wiki.phtml?title=Wikipedia:Today%27s_featured_article/September_26,_2004&action=history))

---

September 27

[Template:TFAempty](#)

**Archive** [More featured articles ...](#)

[view](#) - [talk](#) - [history](#)

([http://en.wikipedia.org/w/wiki.phtml?title=Wikipedia:Today%27s\\_featured\\_article/September\\_27,\\_2004&action=history](http://en.wikipedia.org/w/wiki.phtml?title=Wikipedia:Today%27s_featured_article/September_27,_2004&action=history))

---

September 28

[Template:TFAempty](#)

Archive [More featured articles ...](#)

[view](#) - [talk](#) - [history](#)

([http://en.wikipedia.org/w/wiki.phtml?title=Wikipedia:Today%27s\\_featured\\_article/September\\_28,\\_2004&action=history](http://en.wikipedia.org/w/wiki.phtml?title=Wikipedia:Today%27s_featured_article/September_28,_2004&action=history))

---

September 29

[Template:TFAempty](#)

Archive [More featured articles ...](#)

[view](#) - [talk](#) - [history](#)

([http://en.wikipedia.org/w/wiki.phtml?title=Wikipedia:Today%27s\\_featured\\_article/September\\_29,\\_2004&action=history](http://en.wikipedia.org/w/wiki.phtml?title=Wikipedia:Today%27s_featured_article/September_29,_2004&action=history))

---

September 30

[Template:TFAempty](#)

Archive [More featured articles ...](#)

[view](#) - [talk](#) - [history](#)

([http://en.wikipedia.org/w/wiki.phtml?title=Wikipedia:Today%27s\\_featured\\_article/September\\_30,\\_2004&action=history](http://en.wikipedia.org/w/wiki.phtml?title=Wikipedia:Today%27s_featured_article/September_30,_2004&action=history))

---

2004 archive: [February](#) - [March](#) - [April](#) - [May](#) - [June](#) - [July](#) - [August](#) - **September** - [October](#) - [November](#) - [December](#)

---

Today is [Monday, September 6, 2004](#); it is now 03:50 ([UTC](#))

---

Retrieved from "[http://en.wikipedia.org/wiki/Wikipedia:Today%27s\\_featured\\_article/September\\_2004](http://en.wikipedia.org/wiki/Wikipedia:Today%27s_featured_article/September_2004)"

## Views

- [Project page](#)
- [Discussion](#)
- [Edit this page](#)
- [History](#)

## Personal tools

- [Create an account or log in](#)

## Navigation

- [Main Page](#)
- [Community portal](#)
- [Current events](#)
- [Recent changes](#)
- [Random page](#)
- [Help](#)
- [Donations](#)

## Search

## Toolbox

- [What links here](#)
- [Related changes](#)
- [Special pages](#)

[MediaWiki](#)

[GNU Free Documentation License](#)

- This page was last modified 09:07, 22 Aug 2004.
- All text is available under the terms of the [GNU Free Documentation License](#) (see [Copyrights](#) for details).
- [About Wikipedia](#)
- [Disclaimers](#)

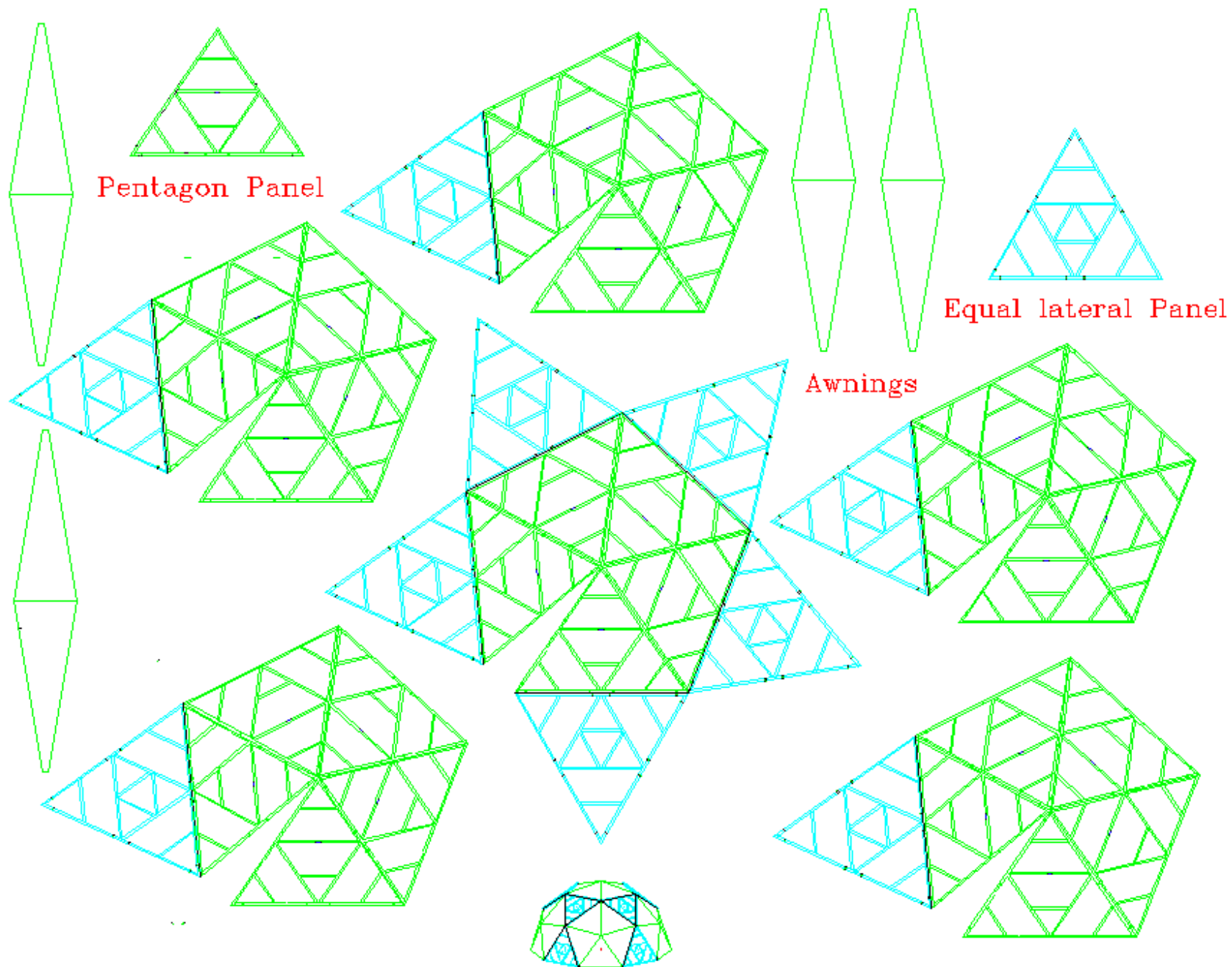

Pentagon Panel

Equal lateral Panel

Awnings



40 Panel  
1/8 Geometric

32cut-6.gif  
32cut-o.dwg.



**MOUNTAIN TRUSS**

5/23/97 rlc

- [Geodesic House Structure](#)

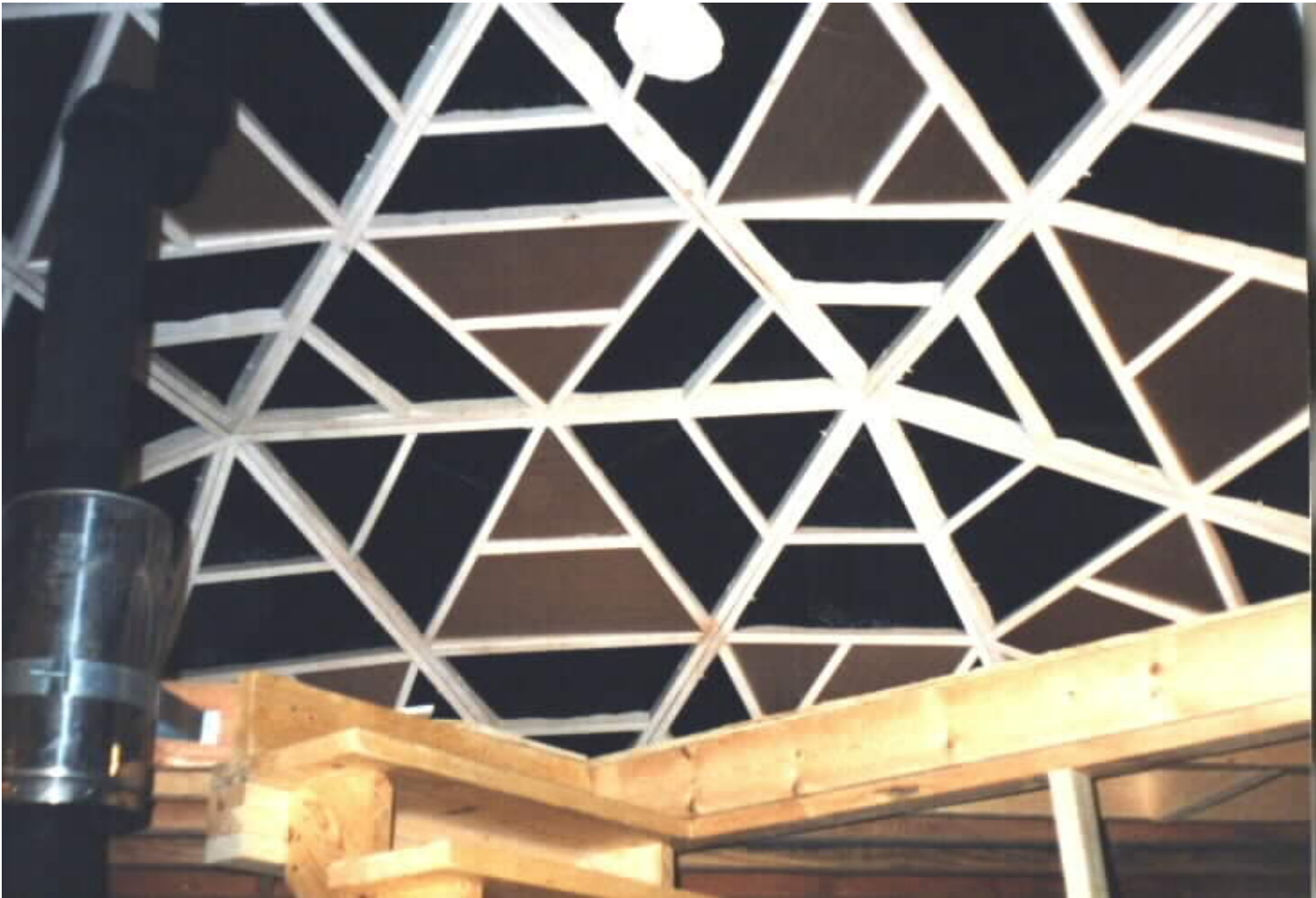

### **Combination board and bubble insulation**

This photo shows a combination of bubble and radiant board insulation being used internal to dome panels. The roof opening is for a roof ventilation turbine. The bubble solar shield has an equivalent of R-5.1 for ceilings and R-8.6 for walls. The 3/4" reflective board insulation has an R-value of 8.4 if used properly in conjunction with a 3/4" airspace. This gives a combination R-factor of 13.5 for a ceiling. With an external 1" board insulation of R-10 plus an additional inside 3/4" board insulation with R-8.4, a total of R-31.9 can be achieved. The 3/4" Super Tuff-R sheathing runs around \$8.99/sheet, or about 33 cents per square foot. For fire protection, the foam sheathing requires a minimum of 1/2" of sheetrock.

---



### **Cutting board insulation using patterns and utility knife**

Hardboard patterns plus a adjustable utility knife is used to cut both the board insulation and the bubble insulation. The bubble insulation is cut 1/4" wider than the patterns while the board insulation is cut exactly to size with a 5 degree bevel to make installation easier.

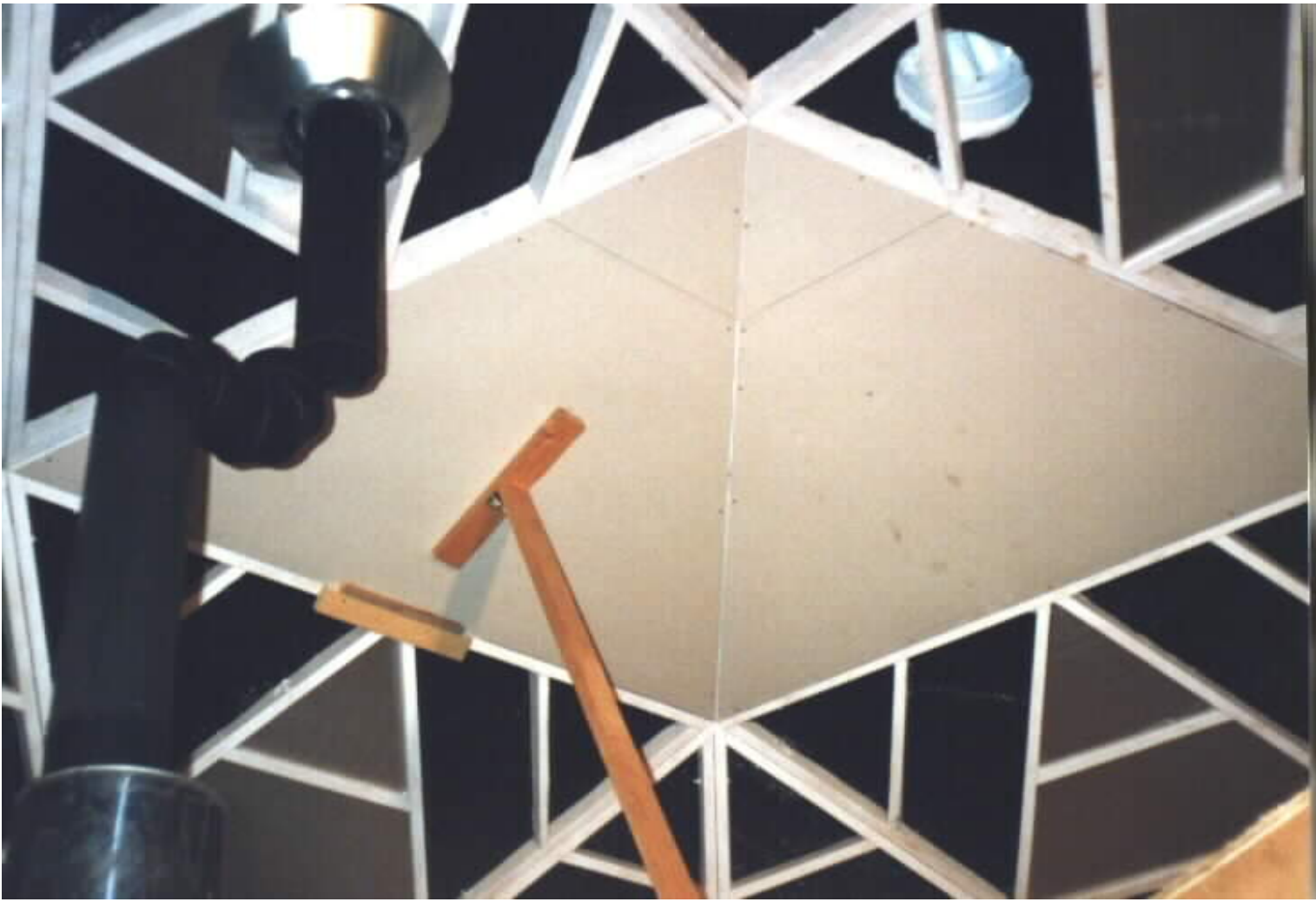

### **Hanging sheetrock using brace board guide board**

The sheetrock is accurately cut using patterns so as to make mudding the sheetrock an option. If one uses screws instead of nails, then the sheetrock simply has to be primed and painted. Caulking would all that would be necessary to close 1/8" the seams. A brace board and position guides are used to accurately place the sheetrock.

---

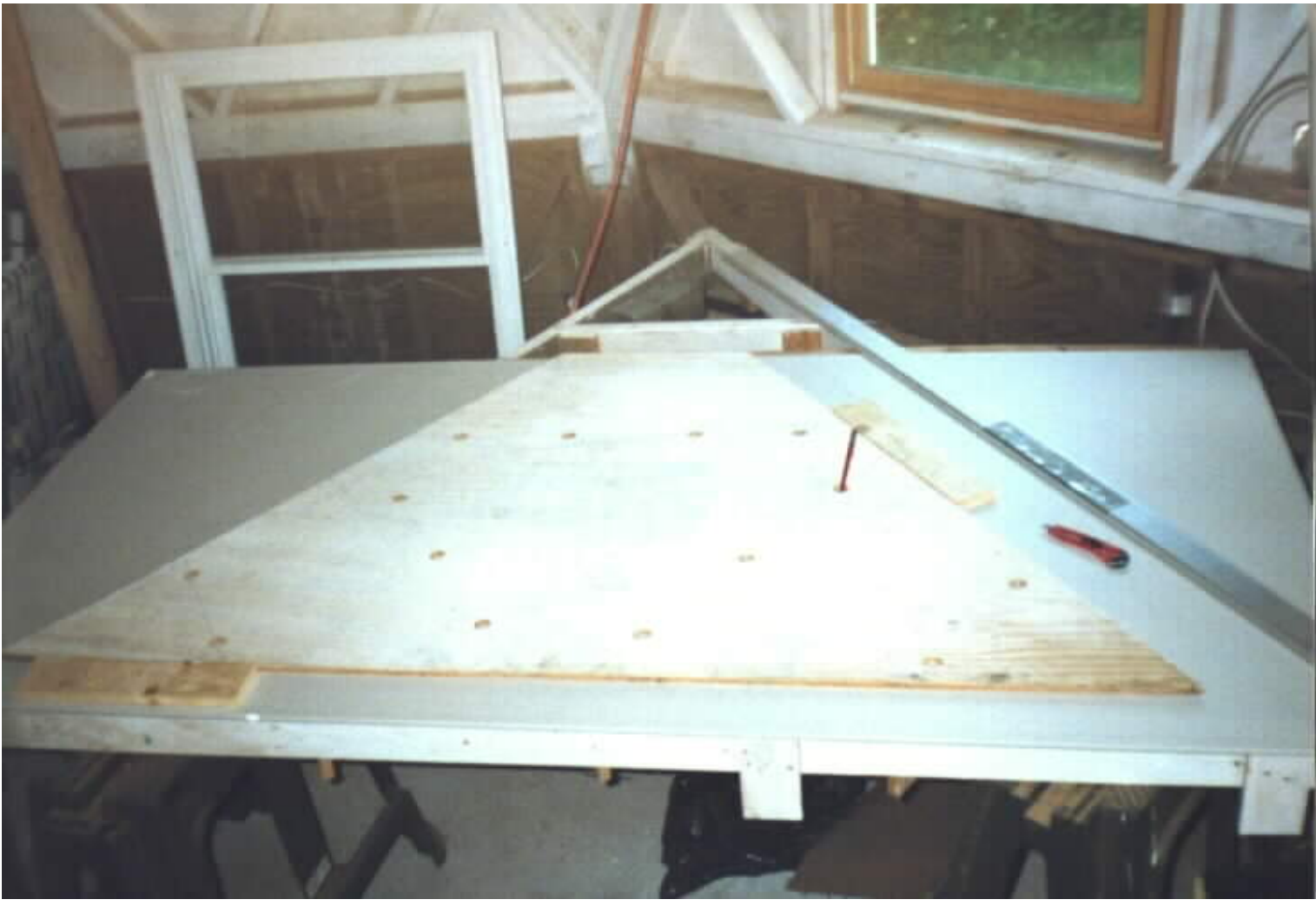

**Marking sheetrock using sheathing pattern plus spacer**

The sheathing cutting guide along with spacer boards are used to mark the sheetrock for cutting. Also the holes in the cutting guide are used to mark the sheetrock for where it is to be attached to the unseen underlying nailers.

---

Note: Any variation or combination of the following types of insulation can be used.

Note: The R-factors were determined by using Solar Shield bubble pack and celestex super Tuff-R.

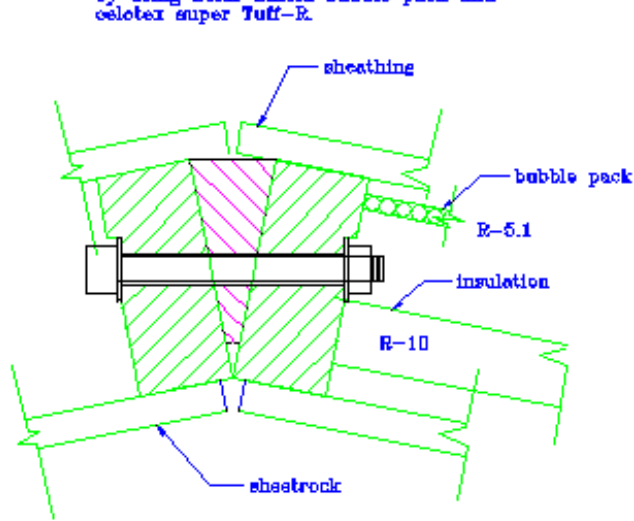

Pentagon Edge Connection

R-15.1

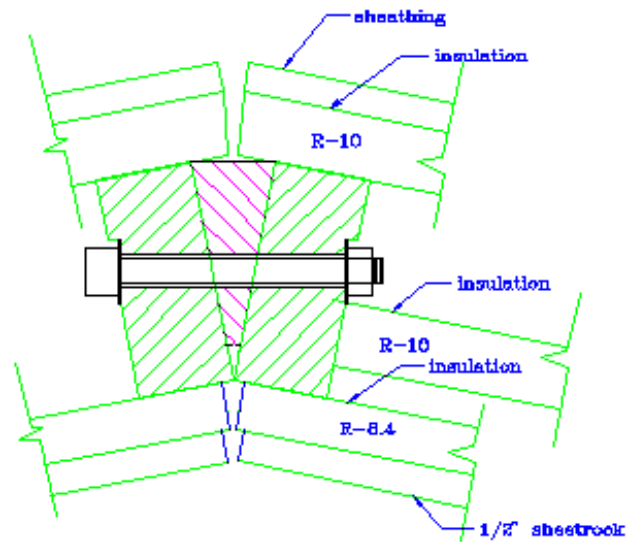

Pentagon Edge Connection

R-28.4

tri-p-ga.dwg  
insulat3.gif  
9/27/99 rlc

### Two Options for insulating

### Two options for insulating dome

- [Return to 24' Dome Page](#)
- [Return to Home Page](#)

## 24' Diameter Dome (shareware book)

---

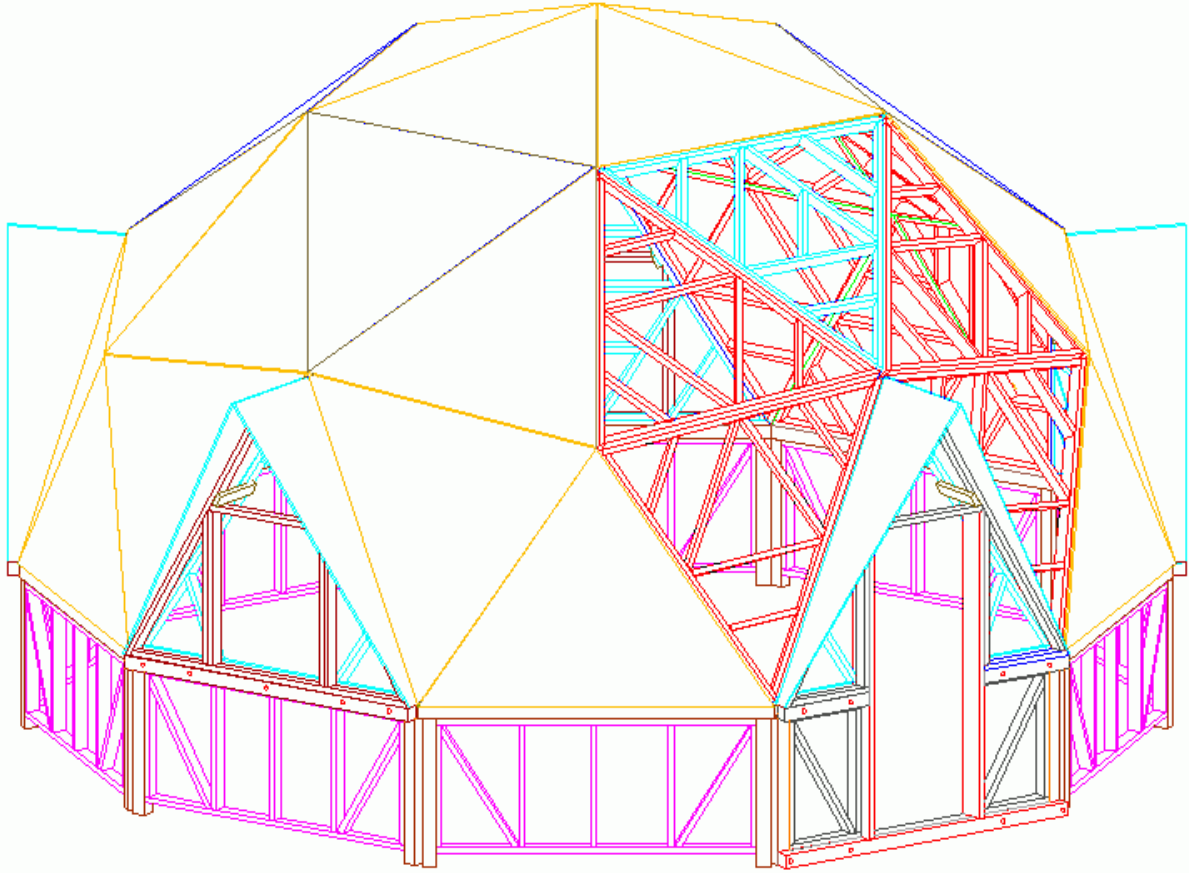

24' Diameter Dome

(Type E)

(2x4 construction)

copyright 1997 RobertConroy

24dom-e3.dwg  
10/13/97 rlc  
revised 11/4/97 rlc

**Shareware Book**

A zip folder containing gif files of the shareware 24' Diameter Dome Book can be found by clicking on the following links.

---

### **Price list (shareware)**

#### **\$24 for plans & material list (shareware)**

- [24' Dome Fabrication Plans \(drawings\)\(shareware\)\(ftp site\)](#)
- [24' Dome Fabrication Plans \(text\) \(shareware\) \(ftp site\)\(material list\)](#)

Send \$24.00 total to: Mountain Truss Corporation, 312 East 79th Street, Kansas City, Missouri 64114 (please include the return name and snail mail address)

---

### **Price List for Printed Plans**

#### **\$48 for printed copy of 24' Dome plans which include material list**

#### **\$48 for second floor suport and joist cutting charts (type IA)**

Send money to: Mountain Truss Corporation, 312 East 79th Street, Kansas City, Missouri 64114 (please include the return name and snail mail address)(please ask for specific plans wanted)

---

page updated 5/9/99 rlc

- [Return to homepage index](#)



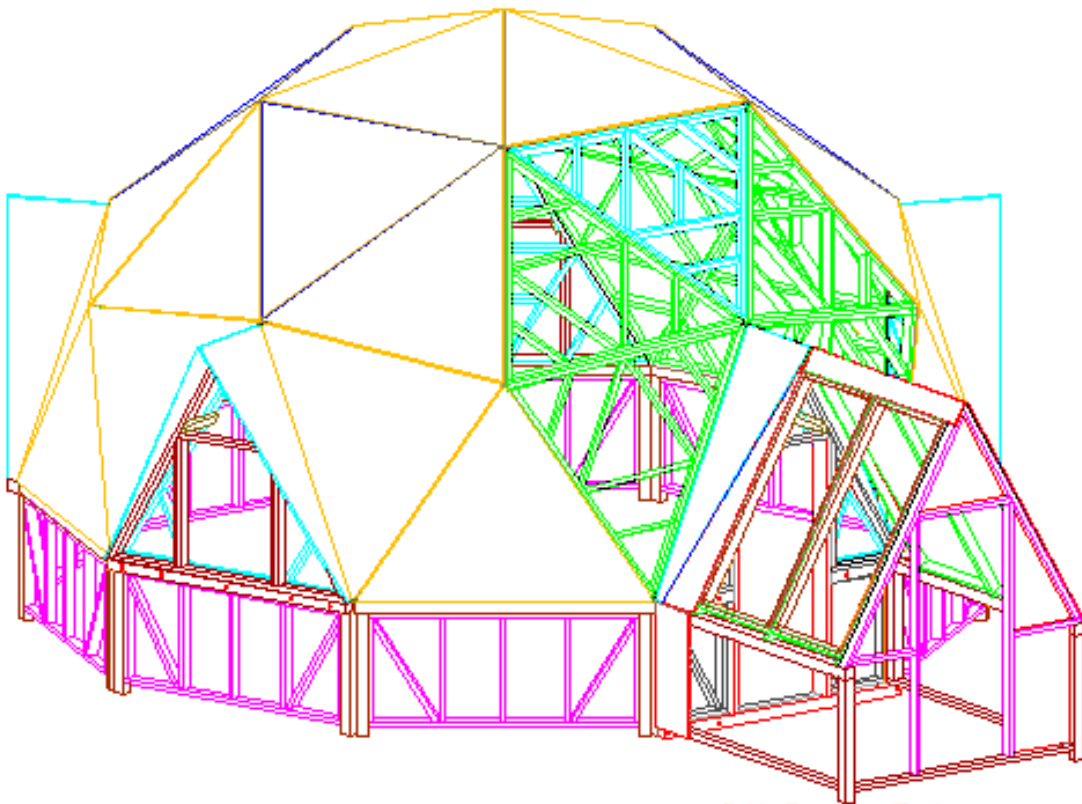

24' Dome Entrance

## 24 Diameter Dome with Greenhouse

24solcal.dwg  
24solcal.gif  
5/12/99 rlc

Energy Computations for 24' Diameter Dome 1/3Heat Loss for Dome Shell

$$Q_S(\text{heat loss for shell})=(U)(\Delta T)(A)(t)$$

$$U=1/R \quad \& \quad R=13$$

U(overall conductance)=1/R=.077  
 A(surface area) = 1200 square feet  
 $\Delta T(\text{temperature difference}) = 65^{\circ}-32^{\circ}=33^{\circ}$   
 t(time)= 24 hours

$$Q_S=.077(33^{\circ})(1200 \text{ square feet})(24 \text{ hours})=73,000 \text{ BTU}$$

Note: R-13 is used as an approximate rating for the surface area.  
 3 1/2" of fiberglass or wet blown glued cellulose will give an R-rating of 13.

Note: An inside temperature of 65° is used instead of 67° because the use of a radiant floor heat system allows for a lower temperature for the same comfort level.

Heat Loss from floor into ground

$$Q_F(\text{heat loss for shell})=(U)(\Delta T)(A)(t)$$

$$U=1/R \quad \& \quad R=6$$

U(overall conductance)=1/R=.16  
 A(surface area) = 400 square feet  
 $\Delta T(\text{average temperature difference}) = (81^{\circ}-65^{\circ})/2 -55^{\circ}= 18^{\circ}$   
 t(time)= 24 hours

$$Q_F=.16(18^{\circ})(400 \text{ square feet})(24 \text{ hours})=28,000 \text{ BTU}$$

Note: The average high temperature of the concrete slab when storing the 75,000 Btu capacity of the double 4x8 solar collectors is 81°.

Heat required for ventilation air

$$Q_V(\text{heat for ventilated air})=(\text{gamma})(V)(\Delta T)$$

gamma(Energy(BTU) required to raise 1 cubic foot of air 1 degree)=.018  
 V(volume of air in cubic feet) = 44,000 /day  
 $\Delta T(\text{average difference in temperature})=65^{\circ}-32^{\circ}=33^{\circ}$

Note: minimum healthy air exchange is (total air volume of building)/4 per hour.

$$Q_V(\text{heat for ventilated air})=(\text{gamma})(V)(\Delta T)$$

$$Q_V=.018(44,000)(33^{\circ}) = 26,000 \text{ BTU}$$

$$Q(\text{total energy required})=Q_S+Q_F+Q_V=127,000 \text{ BTU (British Thermal Units)}$$

Energy Computations for 24' Diameter Dome 2/3Energy InputHot Water Solar Collectors

2- 4' x 8' hot water solar collectors @ 37,500 BTU each=75,000 BTU  
 $Q_W = 75,000 \text{ BTU}$

Greenhouse-Solar Collector

$Q_G = 30,000 \text{ BTU}$  (separate calculation sheet)

Buried Ventilation Moderator

$$Q_{VM} = (\text{gamma})(V)(\Delta T)$$

$$Q_{VM} = 15,500 \text{ BTU/day}$$

$$\text{gamma} = .018 \text{ BTU}/(\text{cubic feet})(^{\circ}\text{F})$$

$$V = (1/4 \text{ vol of structure/hr})(24\text{hr})$$

$$V = 43,500 \text{ cubic feet}$$

$$\Delta T = 55^{\circ} - 32^{\circ} = 20^{\circ}$$

$$Q_W + Q_G + Q_{VM} = 120,000 \text{ BTU}$$

Concrete Heat Storage

$$\phi = \text{Concrete Heat Storage} = .21 \text{ BTU}/(\text{lb})(^{\circ}\text{F})$$

$$Q_{HS} = (\phi)(\text{wt})(\Delta T)$$

$$\text{wt} = 22,000^*$$

$$T = 16^*$$

$$Q_{HS} = 75,000 \text{ BTU}$$

$$\phi = .21 \text{ BTU}/(\text{lb})(^{\circ}\text{F})$$

Concrete Heat Transfer to Interior over 24 hour period

$$Q_{HT}=(U)(A)(\Delta T)(t)$$

U (Overall Conductance) for 4" concrete floor with internal heat source

| Item            | k | t(thickness)(inches) | C    | R=1/C |
|-----------------|---|----------------------|------|-------|
| concrete        | 8 | (2" average)         | 4    | .25   |
| inside air film |   |                      | 1.65 | .606  |

$$\underline{R=.856}$$

$$\underline{U=1/R= 1/.856= 1.17}$$

$$Q_{HT}=(U)(A)(\Delta T)(t)$$

$$Q_{HT}= 1.17(400 \text{ sq ft})(16^{\circ}/2)(24)=138,000 \text{ BTU}$$

Note: Collector output is only 75,000 BTU, therefore loss of stored energy must be decreased by increasing resistance to transfer. This is done best by the strategic use of throw rugs. Transfer of energy needs to be cut in half. The R factor needs to be raised to  $2 \times .856=1.7$ . In other words throw rugs covering half the floor area, 200 s.f., with an R value of 2, needs to be used.

Note: These calculations were done for the Kansas City, Missouri area which has an average temperature of 32° for January.

Note: In the summer, the hot water solar collectors can be shunted to a compound hot water tank to produce hot water for bathing and washing clothes.

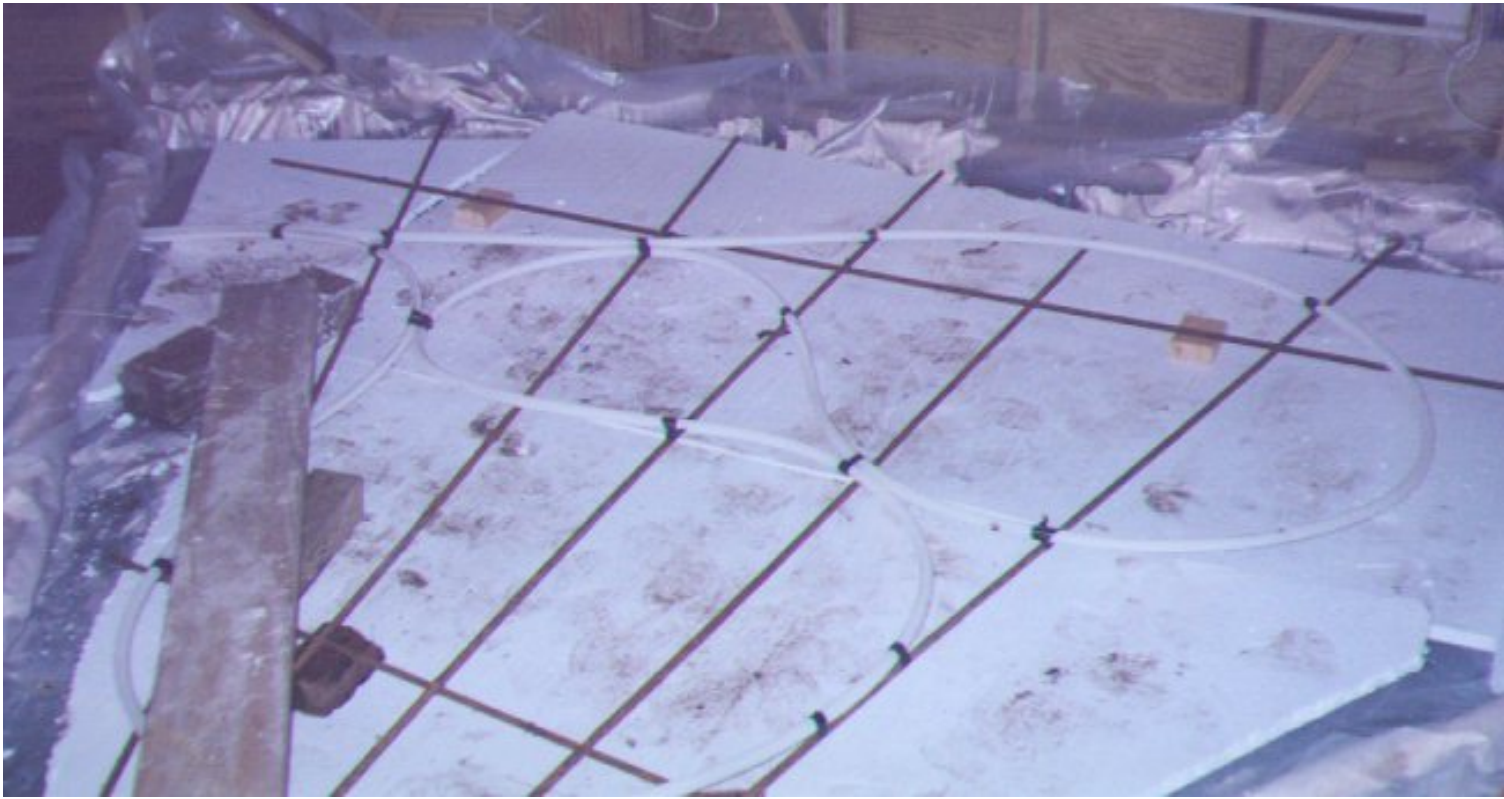

### **Radiant floor heat system**

The ibex cross-linked polyethelene piping is attached to the reinforcing steel with a spacing averaging around 18" on centers. The insulation is preferably a 2" insect resistant EPS insulation placed over a 6 mil vapor barrier.

- [Return to Home Page](#)

## Training

For \$2000 plus expenses I will show how to lay out a fabrication assembly and train 3 workers, on site, how to fabricate the "Mountain Truss".

For \$2000 extra, plus expenses, I will train 3 workers, on site, how to assemble a "Mountain Truss".

---

- [Robert\\_Conroy@compuserve.com](mailto:Robert_Conroy@compuserve.com)
- [return to cover page](#)

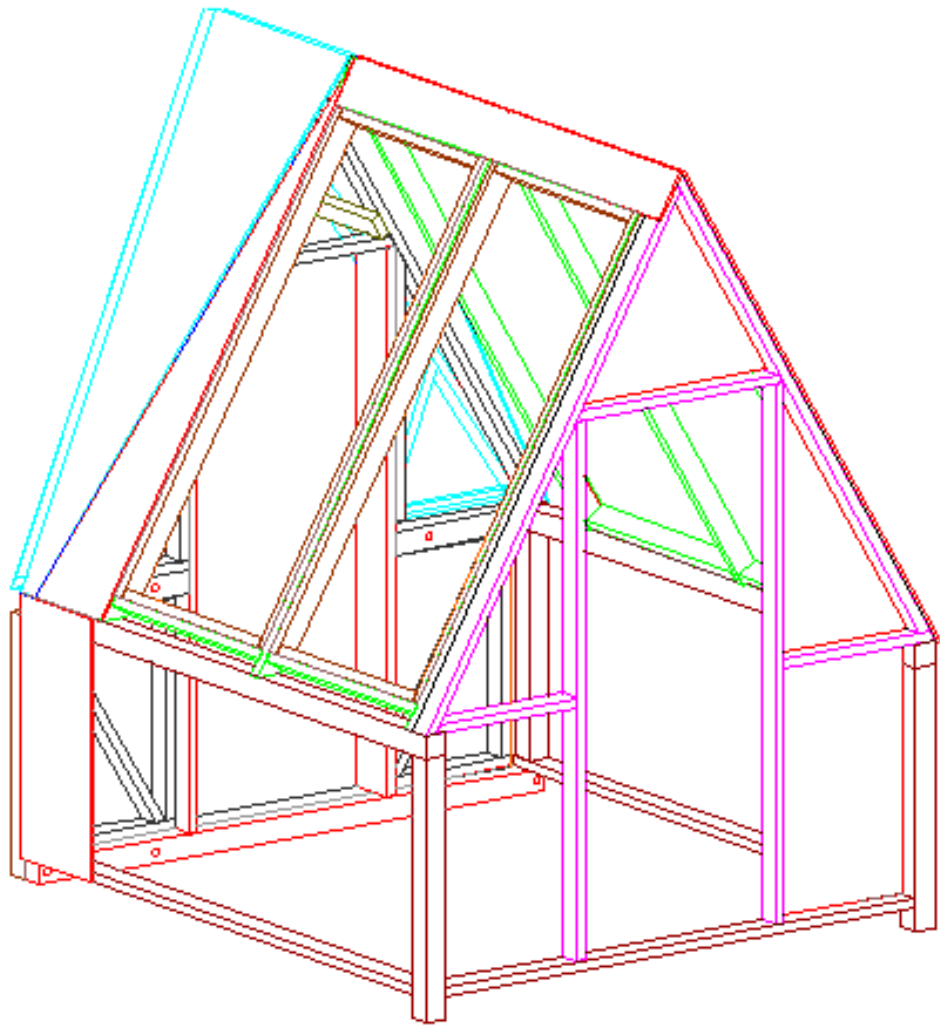

Glass Framing

L

## Greenhouse Attachment for 24' Dome

---



**Post & Beam laid being laid out.**

I used cedar for both the posts & beams. A dry gravel concrete mix was tamped into the post holes once everything was plumbed and aligned.

---





**Roof Truss Installed**

I recommend that cedar be used for roof truss.

---



**Doorway**



### **Sheathing Applied to Greenhouse**

Sheathing is 1/2" plywood which has been primed and painted with elastomeric paint.

---



### Glazing

I framed the tilted glass in cedar 2x4 frames. I routed out a groove for the glass to set. The vertical glass is simply held in place with 2x2 cleats. The glass was salvaged from patio doors which had their seals broken. Simply use a utility knife to cut the sealing gasget from the double glass to make two single glass panes. Movable aluminized insulating board is used to moderate heat gain and heat loss. There is a air vent above both the inner and out door. The adjustable storm door entrance can be used to adjust the fresh air intake.

- [Return to 24' Dome House](#)
- [Return to Home Page](#)

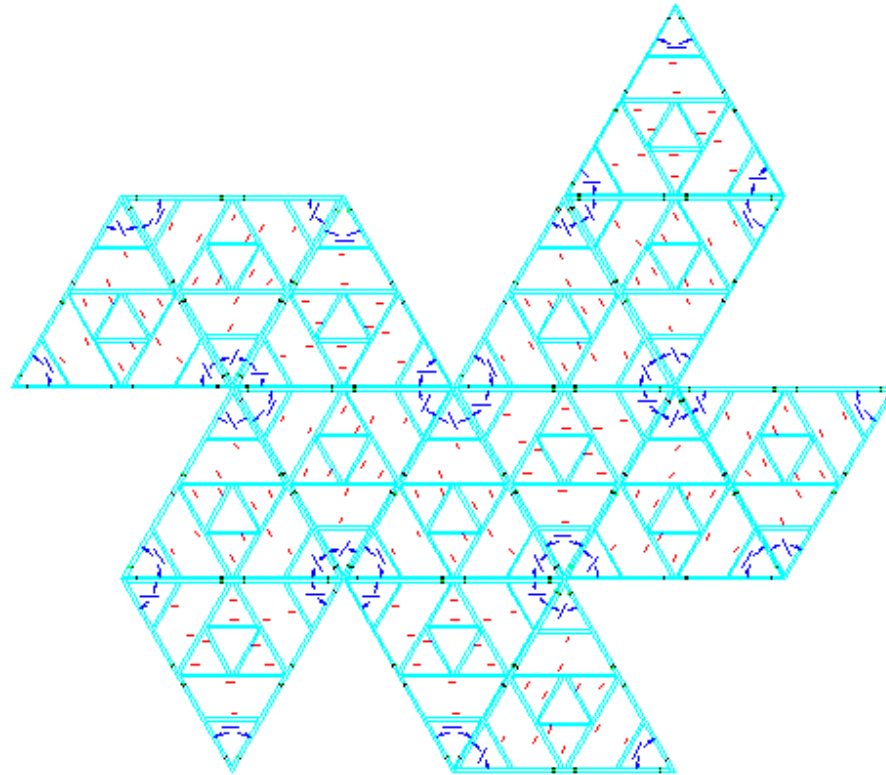
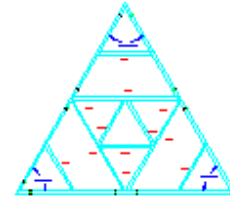

Greenhouse

32cut-o.dwg.  
5/24/97 rlc





**Welcome to...**

**HOT TOPICS!**

It seems that almost every day there are topics of interest...daily events...which impact global food supply, personal security and safety, or simply may be of interest to the Ark Institute's customers. We provide these for your information and encourage you to email us any such topics to be considered for posting in this category.

**BERKEFELD WATER FILTERS**

The Ark Institute® is pleased to carry the **NEW!** BerkeyLight®, the **NEW!** Sport Berkey® and Big Berkey® British Berkefeld® Water Purifiers and Filtration Systems. If you already have a Berkey®, then order extra ceramic filters now. [Click here](#) for full details.



**\*\* Not available in California or Iowa. \*\***

**NEW!**

**So many of you have been calling and writing to ask about The Ark Institute's®**

**Non-hybrid Family Seed Package**

**We have a *limited supply* of a really wonderful new package containing 40 different varieties of Non-hybrid, Non-GMO, chemically Un-treated vegetable and herb seeds (Yes, just like our original package!) and most of the varieties will be different from the ones you may have from us in the past. It is an exciting, excellent collection, many of them heirlooms. These will have a shelf-life of 3-5 years in a cool, dark, dry place, or many years in your freezer. [Click HERE for Details!!](#)**

**SURVIVING A BIOTERRORIST**



# **ATTACK** : Prevention, Treatment, Management.



By Geri Guidetti

\* \* \* \* \*

## **Surviving a Bioterrorist Attack: Prevention, Treatment, Management**

**\$20.00 +\$4.00 s&h**

For mail order, send to:

**The Ark Institute®**

**P.O. Box 1227**

**Jacksonville, OR 97530**

To order by credit card   call

**1-800-255-1912**

**9AM-5PM EST**



---

## Ask Geri!

Visit our [FAQ's](#) page for Geri's archived **Non-hybrid Gardening Forum** questions and answers!

---

[Click here](#) to read The Ark Institute's® ...

Food Supply Updates

To reach Geri Guidetti by email: [arkinstitute@starband.net](mailto:arkinstitute@starband.net)

For Ordering Information, please call **1-800-255-1912**.

---

Copyright © 1996-2004, **Geri Guidetti**.  
All rights reserved.

Web Design: Kristin  
Guidetti

Revised June 8, 2004

Hosted by:  
DVTechnologies

<http://www.dvtech.net>





# The Small Farm Resource

...established 1995



(always under construction....)

*This Banner Could Be Advertising*  
**Your Company**  
*Click Here For More Information*

Welcome to the Small Farm Resource!

- [Aquaculture](#)
- [Bees and Beekeeping](#)
- [Crops - Forage](#)
- [Crops - Orchard/Fruit](#)
- [Crops - Other](#)
- [Equipment](#)
- [Extension Service](#)
- [Gardens](#)
- [Livestock - Exotic](#)
- [Livestock](#)
- [Pests](#)
- [Property Management](#)
- [Wildlife](#)
- [Miscellaneous](#)

- [Farm Related Conferences](#)
- [General Farm Related Links and Mailing Lists](#)
- [Feedback](#)
- [Link Requests](#)
- [Search](#)

Hit  
Counter

Welcome to the Small Farm Resource! These web pages have been created to help disseminate information of use to people with small farms or rural property. This is a cooperative effort. Some of our information comes from people like you. We are merely playing the part of the organizer and repository.

## Warning:

**The information contained in these web pages has not been verified for correctness. Some of the information contained herein is hearsay and may not be correct. Use the information from these pages only at your own risk!**

Some items have no associated document, if you have information to share in these (or existing) areas, by all means, send it to us (see our page on [contributions](#)). Also, if you are looking for small farm information and cannot find it listed here, use our [feedback](#) form to let us know what information you are looking for, and we'll add it to the list (assuming it is of general interest). If you would like to have a link added to our pages, please use our [link request](#) form.

## Notice:

Neither Farm Information Services nor The Small Farm Resource nor any of it's employees warrant that the service and information will be uninterrupted or error free; nor does Farm Information Services nor The Small Farm Resource nor any of it's employees make any warranty as to the results to be obtained from use of the service and information. Neither Farm Information Services nor The Small Farm Resource nor any of it's employees nor anyone else involved in creating, producing or delivering the service and information be liable for any direct, indirect, incidental, special or consequential damages arising out of use of the service or information or inability to use the service or information.



---

**This page was last updated on August  
02, 2002**



[Building Products \(ES\)](#)

**Related Sites:**

---

**PLEASE NOTE!**

In about 20 seconds, you will be automatically forwarded to the [ICC web site](#).

Nearly all of the content from the ICBO server has already been moved to the [ICC web site](#). Feel free to visit the new site, and you can search the page you want from any ICC page.

**Here are the major areas of the new site:**

- [Product store](#)
  - [Codes & Standards](#)
  - [Training](#)
  - [Certification & Licensing](#)
  - [Membership](#)
  - [News & Events](#)
  - [Consumer Safety](#)
  - [Jobs & Services](#)
- 



Designed for  
browsers and



© 2003 IC

---

[\[Home\]](#) [\[Online Product Store\]](#) [\[Code Chat\]](#) [\[Code News\]](#) [\[Building Products \(ICBO ES\)\]](#)  
[\[IFCI\]](#) [\[Calendar\]](#) [\[Certification\]](#) [\[General Information\]](#) [\[Membership\]](#) [\[Chapters\]](#)  
[\[Training\]](#) [\[Job Listings\]](#) [\[Safety Tips\]](#) [\[Related Sites\]](#) [\[Press Room\]](#)

# License Agreement

---

The "Mountain Truss" detailed plans will remain a trade secret and this document will serve as a non disclosure covenant to those who receive a set of plans. Should the holder of the plans decide to go commercial and sell manufactured trusses, then 10% of the sale price shall be remitted to Robert Conroy at the address that follows. As a licence holder the signee will be eligible for updates as long as they remain active license holders.

---

Licencer:  
Robert Conroy  
312 E. 79th ST.  
K.C. MO 64114

Date:

---

Licensee

---

Note: sign and return 2 copies

---

- [Order Form](#)
- [Return to 24' Dome page](#)
- [Return to cover page](#)

# Instructions

Tools needed for construction of elements and compounds:

1. scotch tape
2. straight edge
3. good scissors

Steps in construction of elements:

1. Carefully cut out shapes from cut-out pages with a good scissors.
2. Carefully fold cut-out shapes with the help of a straight edge along connecting lines.
3. Scotch tape figures together into forms represented by diagrams.

## Individual Project

Combine the elements as shown to construct the basic compounds of a Tri-Pent Geodesic.

## Class Room Projects

- a. Combine the basic compounds of a Tri-Pent Geodesic into a half Tri-Pent Geodesic.
- b. By combining different elements and compounds, come up with an interesting undescribed compound.

# Printing and Shareware Instructions

1) Teacher should make copies of the workbook on heavy paper or cardstock. In some cases, colored paper might be appropriate. Printer set to "Fit Aspects".

2) This is a shareware workbook. If teachers or individual students, in individual settings, find the workbook 100% satisfactory, then they are asked to remit a fee. The over all fee for a classroom is \$10.00/class. For independent students, the fee is \$3.00. The classroom fee covers as many copies as necessary for that particular class.  
Remit fee to:

Robert Conroy  
312 East 79th Street  
Kansas City, MO 64114

3) The text portion of the workbook is an interactive WEB page:  
[http://go.ourworld.nu/robert\\_conroy/](http://go.ourworld.nu/robert_conroy/)

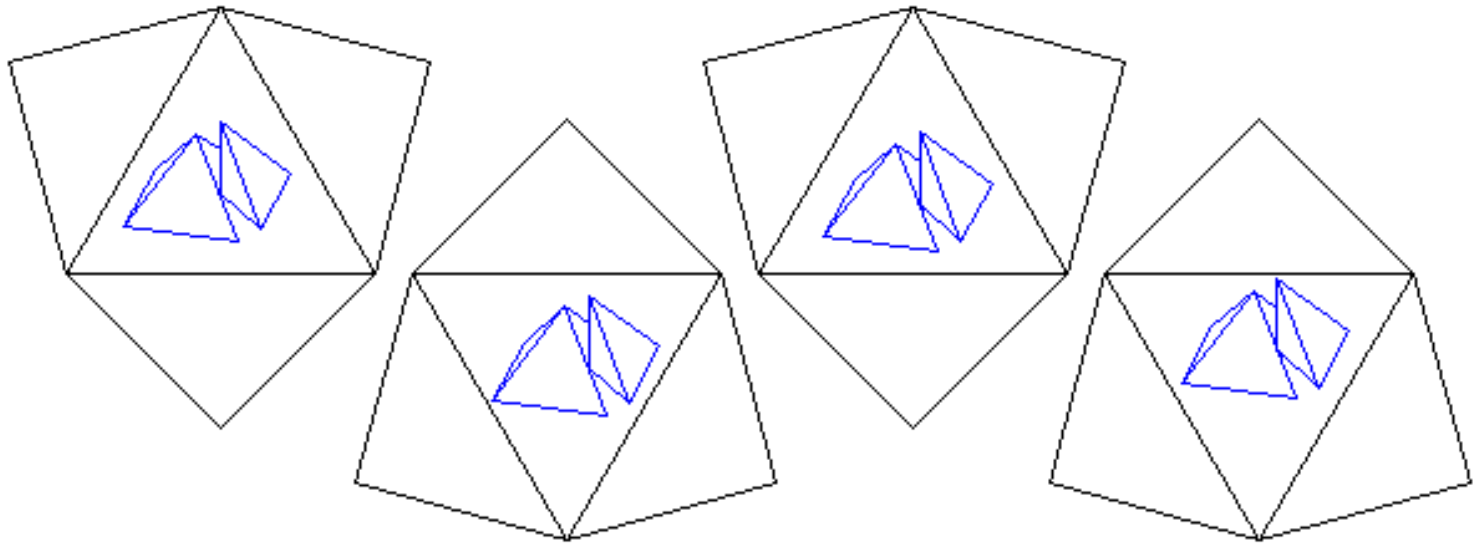

**Octahedron Segments**

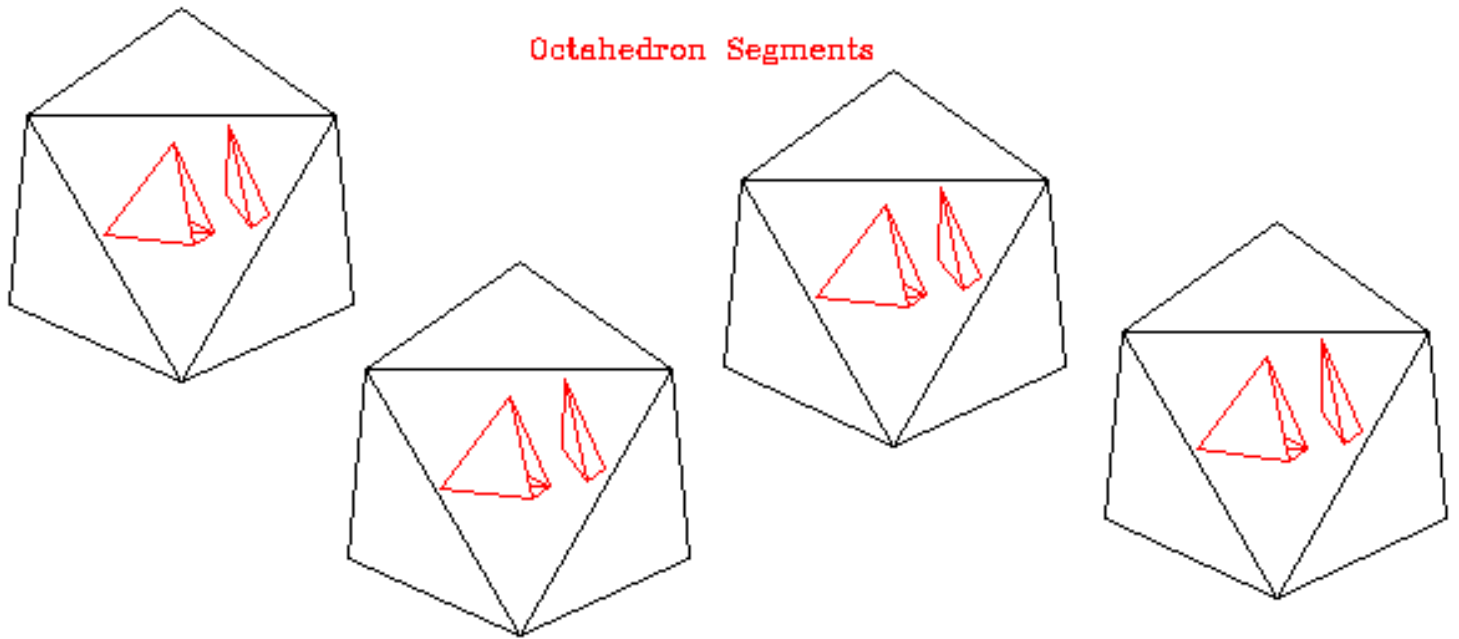

**Tetrahedron Segments**

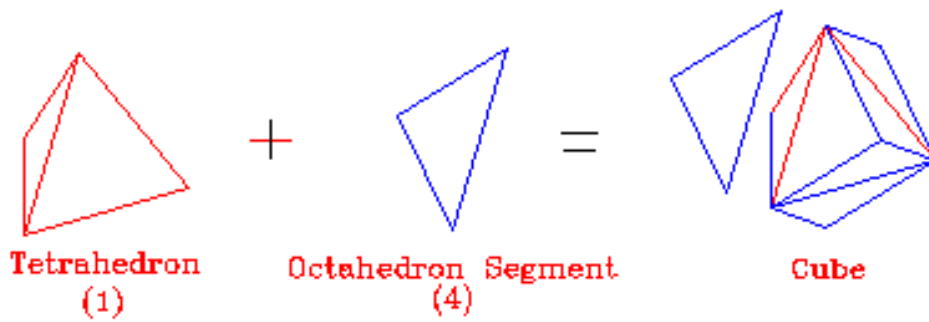



# Octa and Tetra Elements

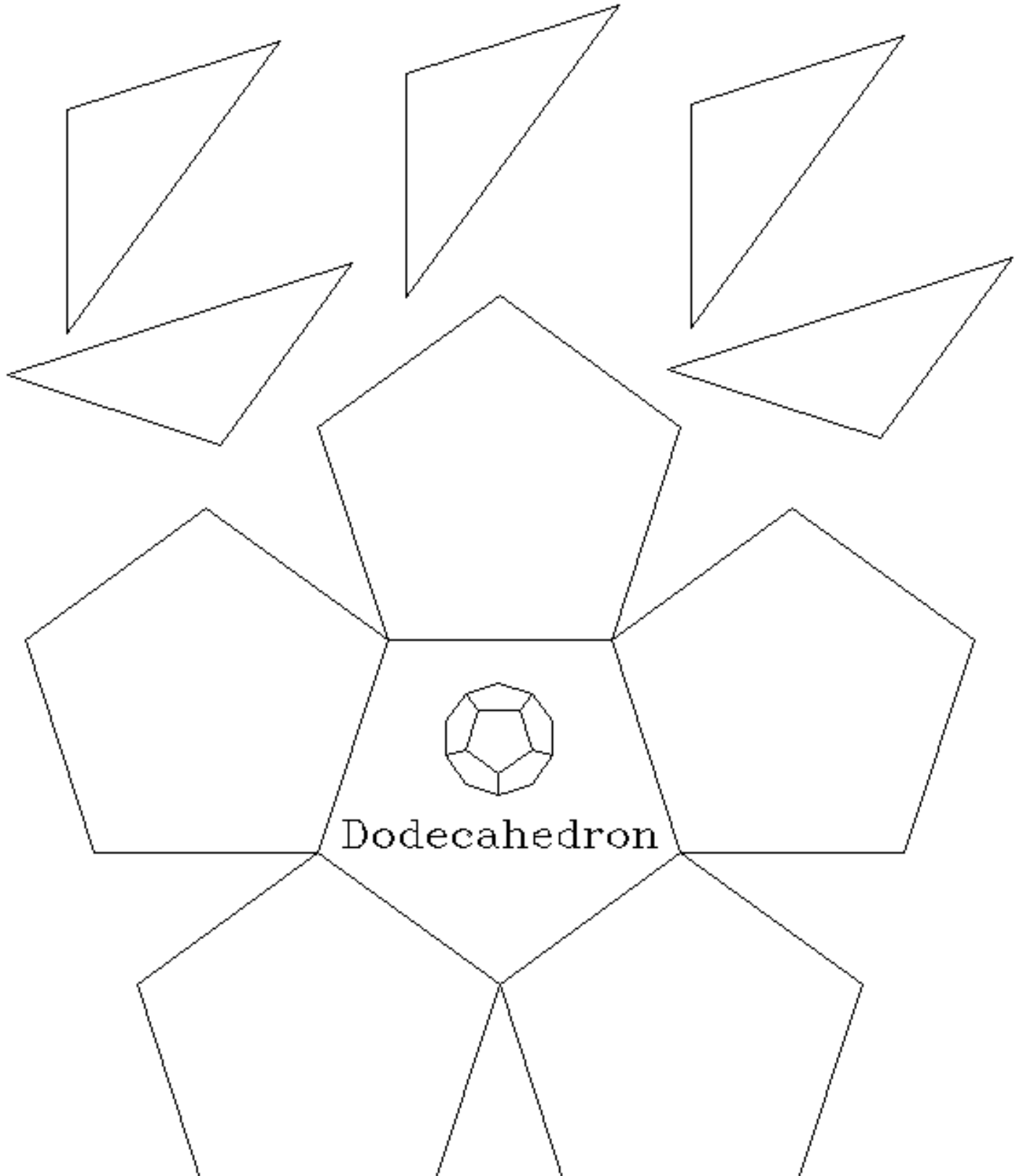



Half

Dodecahedron  
Dodacah3.dwg.(1.6)

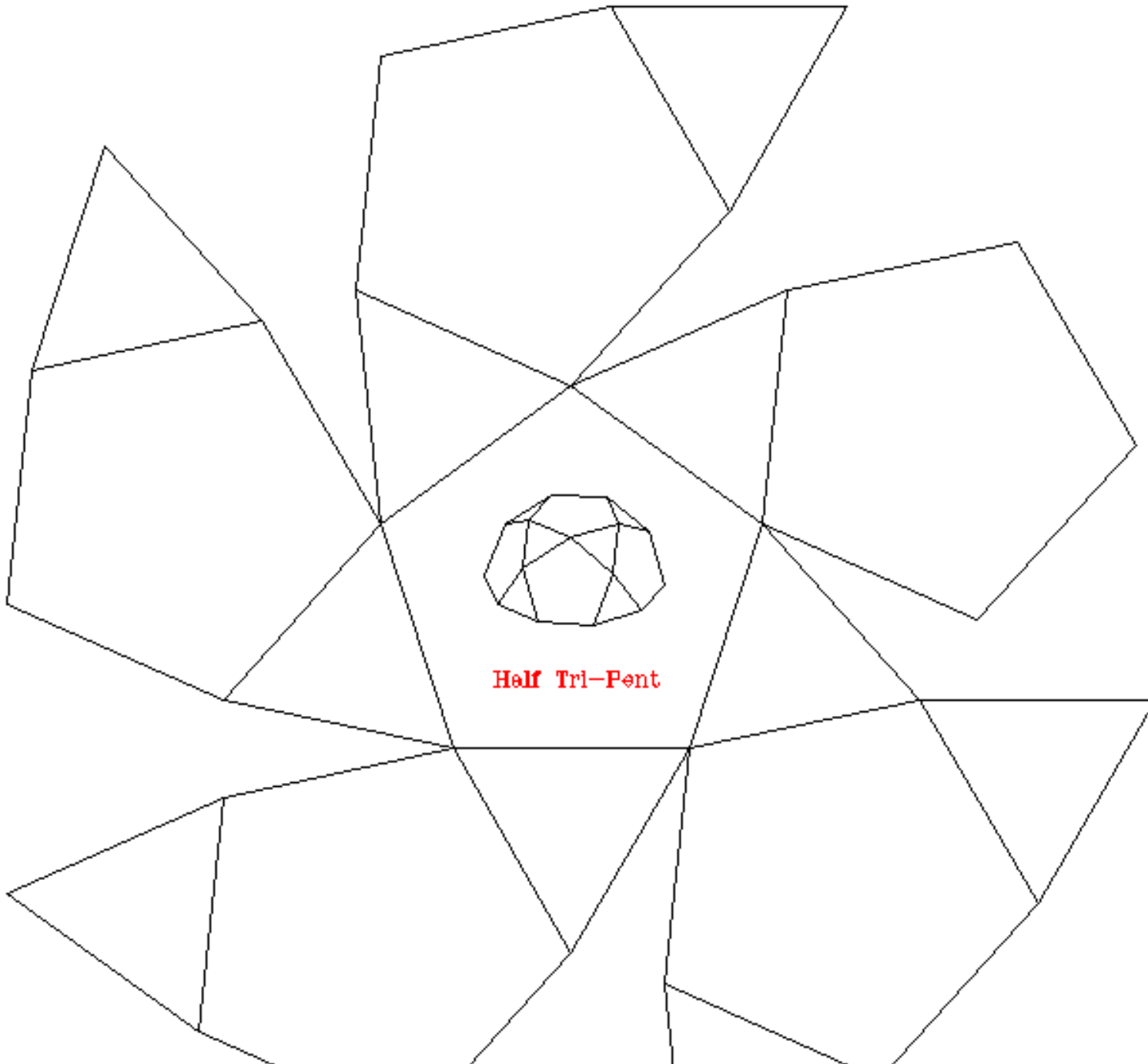

Half Tri-Pent



# Half Tri-Pent

## Tripent6.dwg.(1.6)

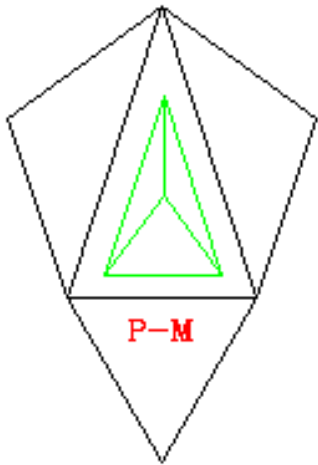

Point Element  
Male

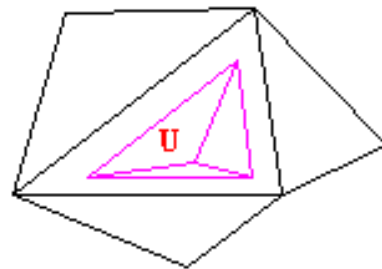
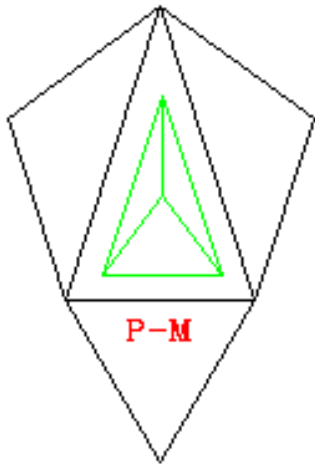

U Right Element

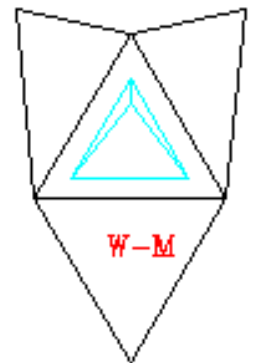

Wedge Element  
Male

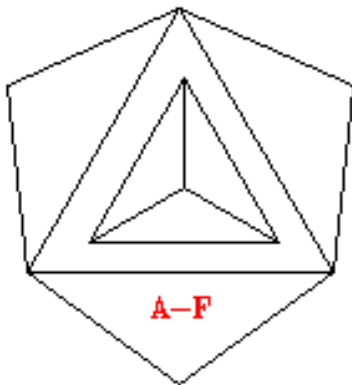

Alpha Element  
Female

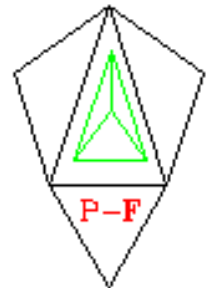
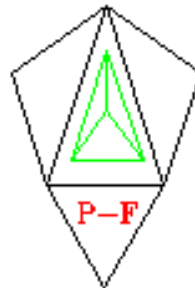
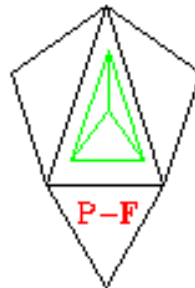

Point Element  
Female

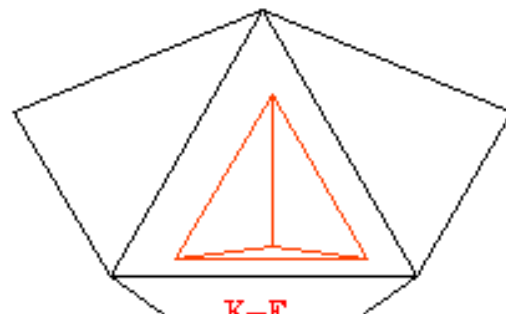



Wedge Element  
Female



Kappa-Element  
Female

## Cut Outs for Tri II Compound

Scale T:1  
Tri-Pent.dwg  
bk2-elt.gif

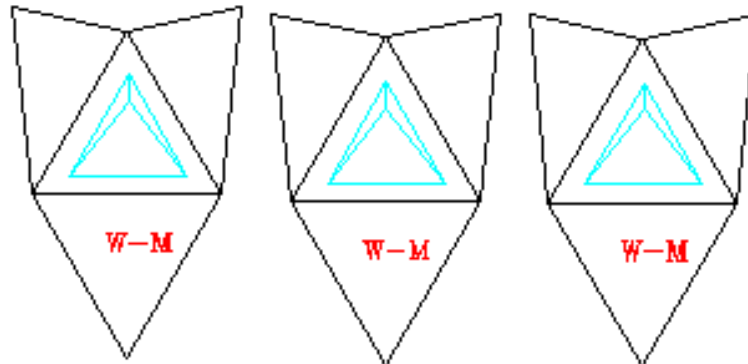

Wedge Element  
Male

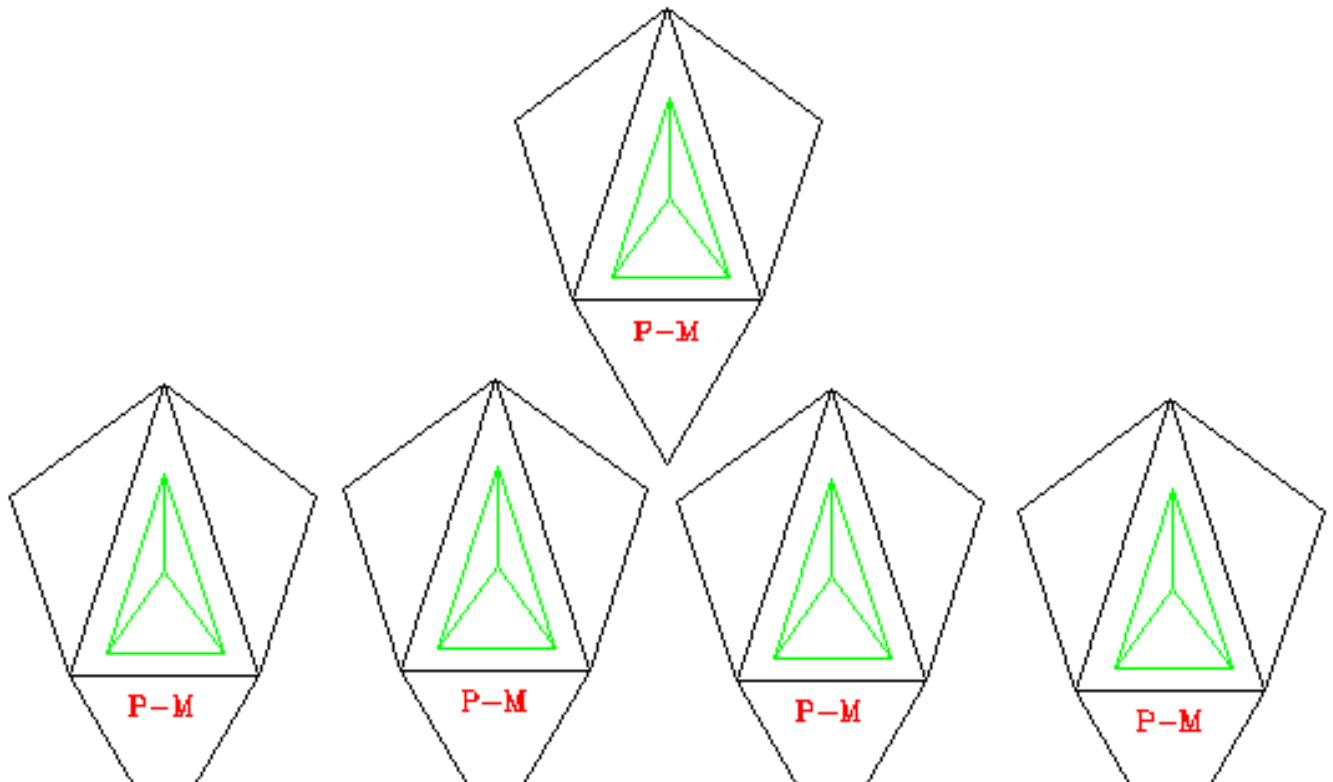



Point Element  
Male

# Cut Outs for Pent II Compound

Scale 1:T

Tri-Pent.dwg

bk2-elpl.gif



Level 2 Workbook Pent II Compound (2)

- [Return to Workbook Shareware Page](#)



**Point-Female**  
(1)



**Wedge-Female**  
(1)



**Unbalanced-Right**  
(3)

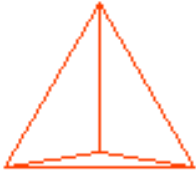

**Kite-Female**  
(9)

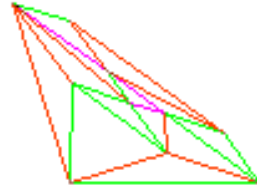

**Hexagon Solid Compound**



**Point-Male**  
(3)



**Point-Female**  
(1)

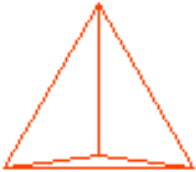

**Kite-Female**  
(1)

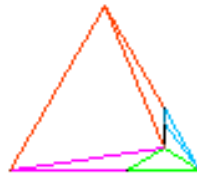

**Wedge Compound 1**



**Wedge-Female**  
(1)



**Unbalanced-Right**  
(1)



**Wedge-Female**  
(20)

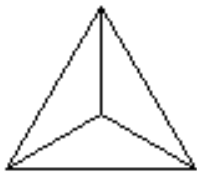

**Alpha-Female**  
(10)

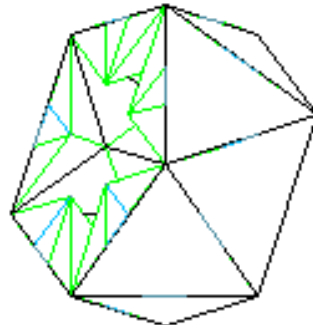

**Truncated Isocahedron Shell**



**Point-Female**  
(30)

# Compounds of Hex-Pent Geodesic

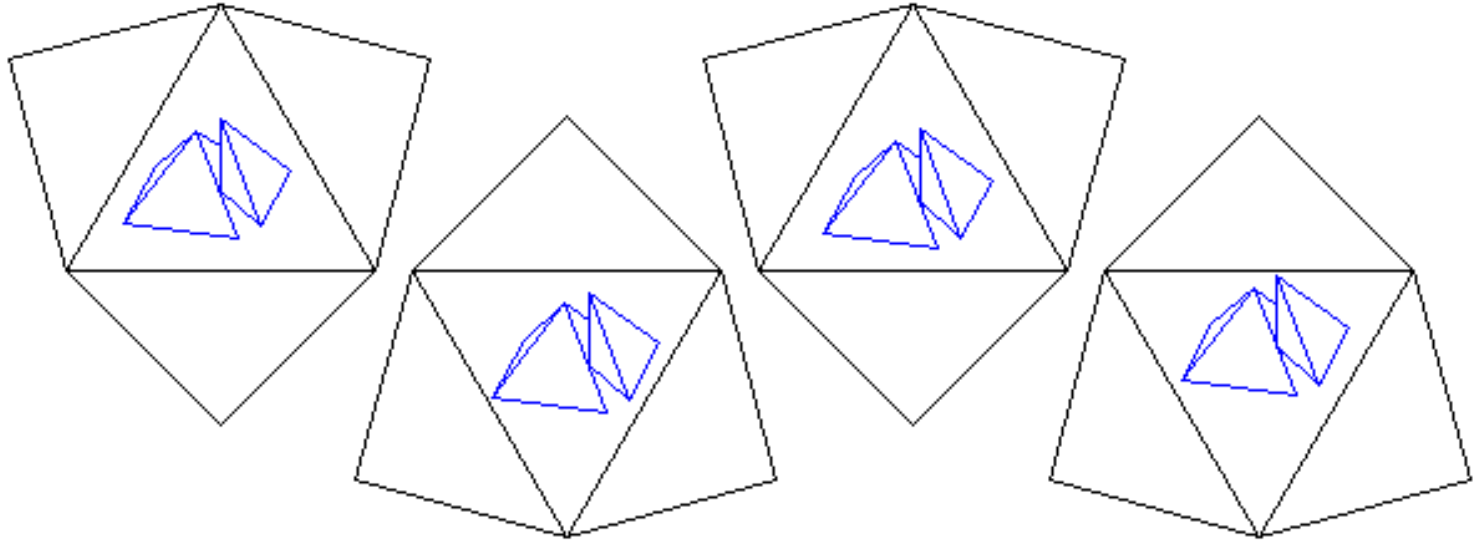

**Octahedron Segments**

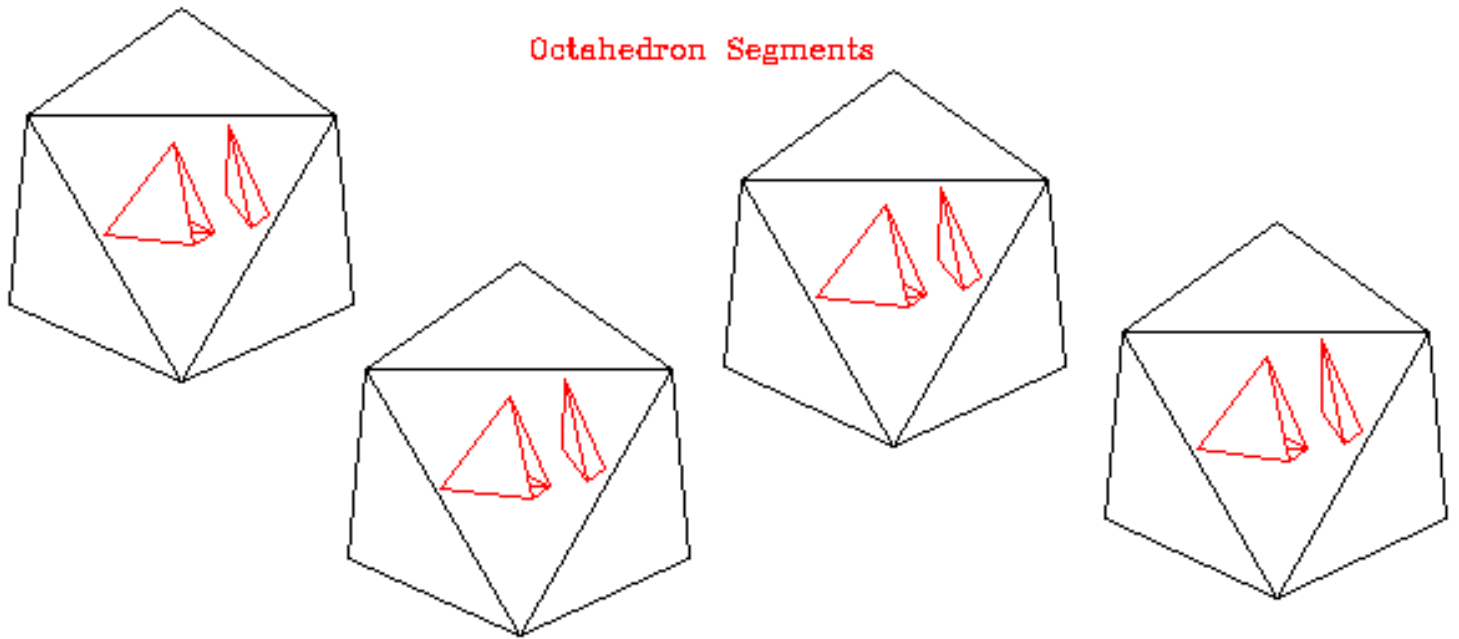

**Tetrahedron Segments**

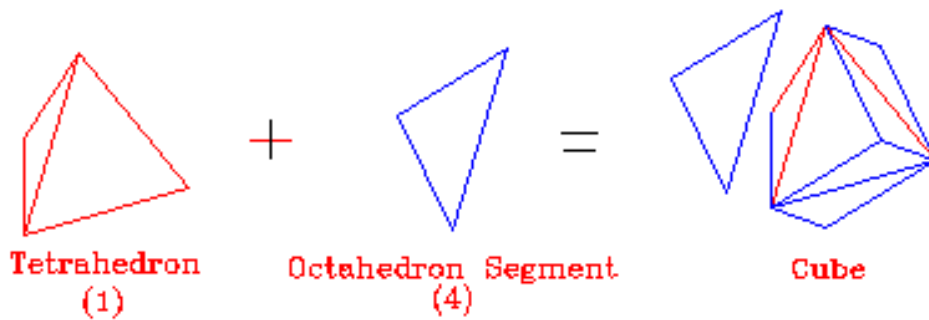



# Octa and Tetra Elements

## Instructions

Tools needed for construction of elements and compounds:

- a) scotch tape
- b) straight edge (ruler)
- c) good scissors

Steps required in constructing elements and compounds:

1. Carefully cut out shapes from the cut-out pages with a good scissors.
2. Carefully fold cut-out shapes with the help of a straight edge along the connecting lines.
3. Scotch tape figures together into forms represented by the diagrams.

**Individual Project**

Construct the compound elements of the Mean Proportional Geodesic from the cut-out section of the workbook. These include the Hexagon Solid Compound, the Wedge Compound, and the Truncated Icosahedron Shell. Construct the Icosahedron, the Dodecahedron, and the Icosidodecahedron also.

**Class Project**

- a) If there are enough students in the class, construct a half mean proportional geodesic from its compound elements.
- b) By combining different elements and compounds, come up with an interesting undescribed compound.

## Printing and Shareware Instructions

1) Teacher should make copies of the workbook on heavy paper or cardstock. In some cases, colored paper might be appropriate. Printer set to "fit aspects".

2) This is a shareware workbook. If teachers or individual students, in individual settings, find the workbook 100% satisfactory, then they are asked to remit a fee. The over all fee for a classroom is \$12.00/class. For independent students, the fee is \$3.00. The classroom fee covers as many copies as necessary for that particular class.

Remit fee to:

Robert Conroy  
312 East 79th Street  
Kansas City, MO 64114

3) The text portion of the workbook is an interactive WEB page:

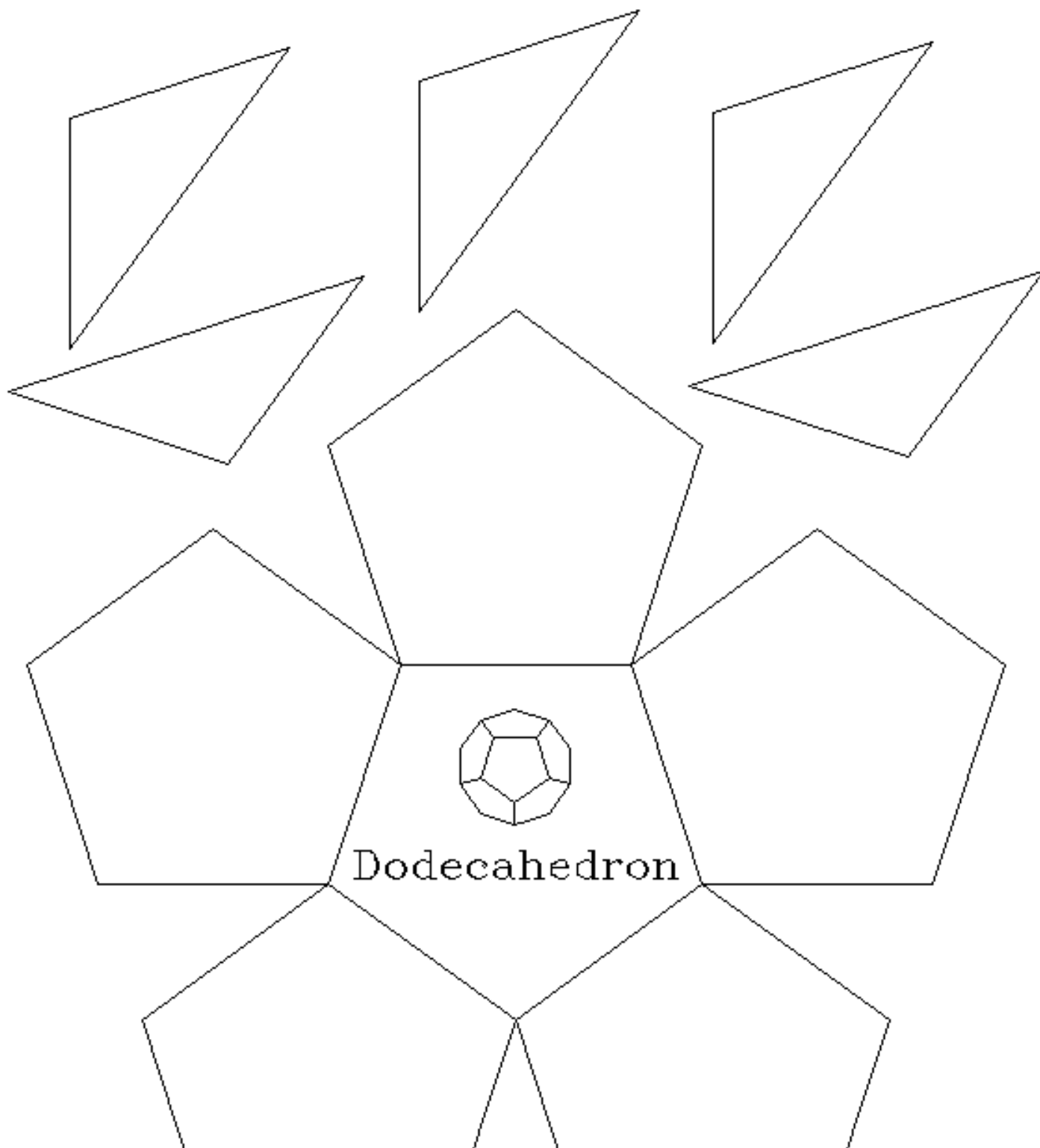

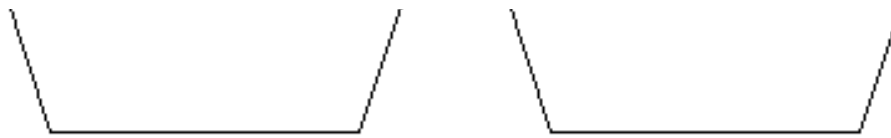

Half

**Dodecahedron**  
**Dodacah3.dwg.(1.6)**

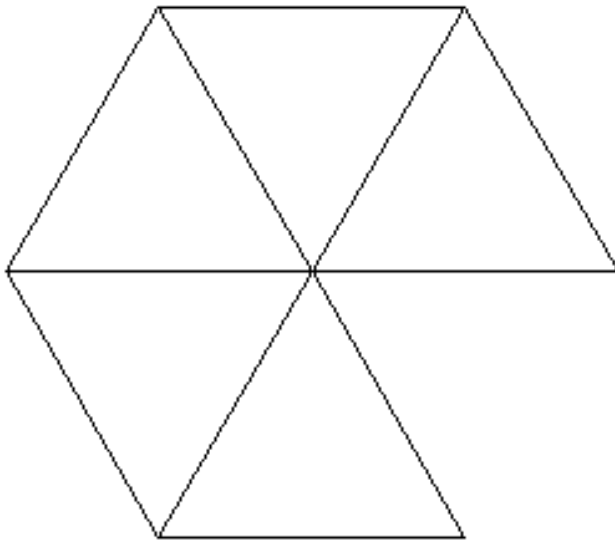

**Isocahedron Top**

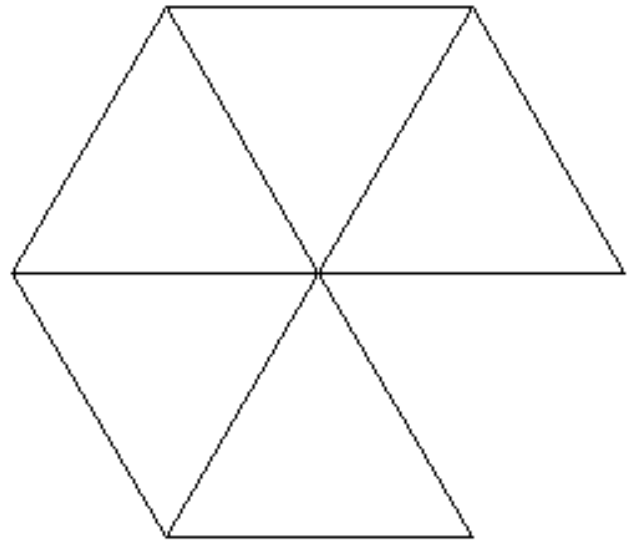

**Isocahedron Top**

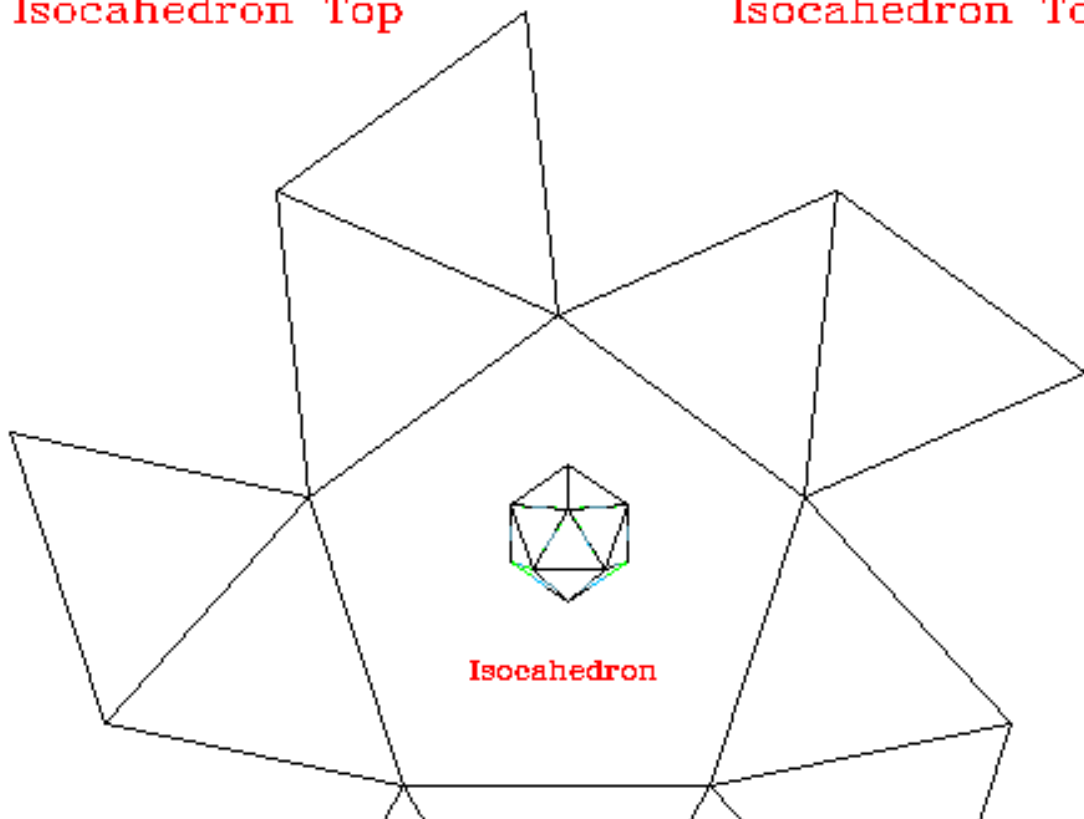

**Isocahedron**

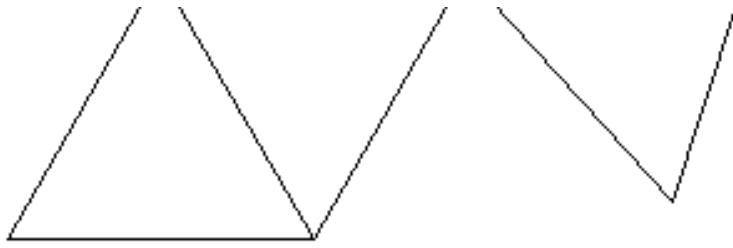

Truncated Isocahedron  
Isocahedron  
Isocah6.dwg.(1.6)

- [Go to Part 3 of 3rd Level Workbook](#)
- [Return to home page](#)

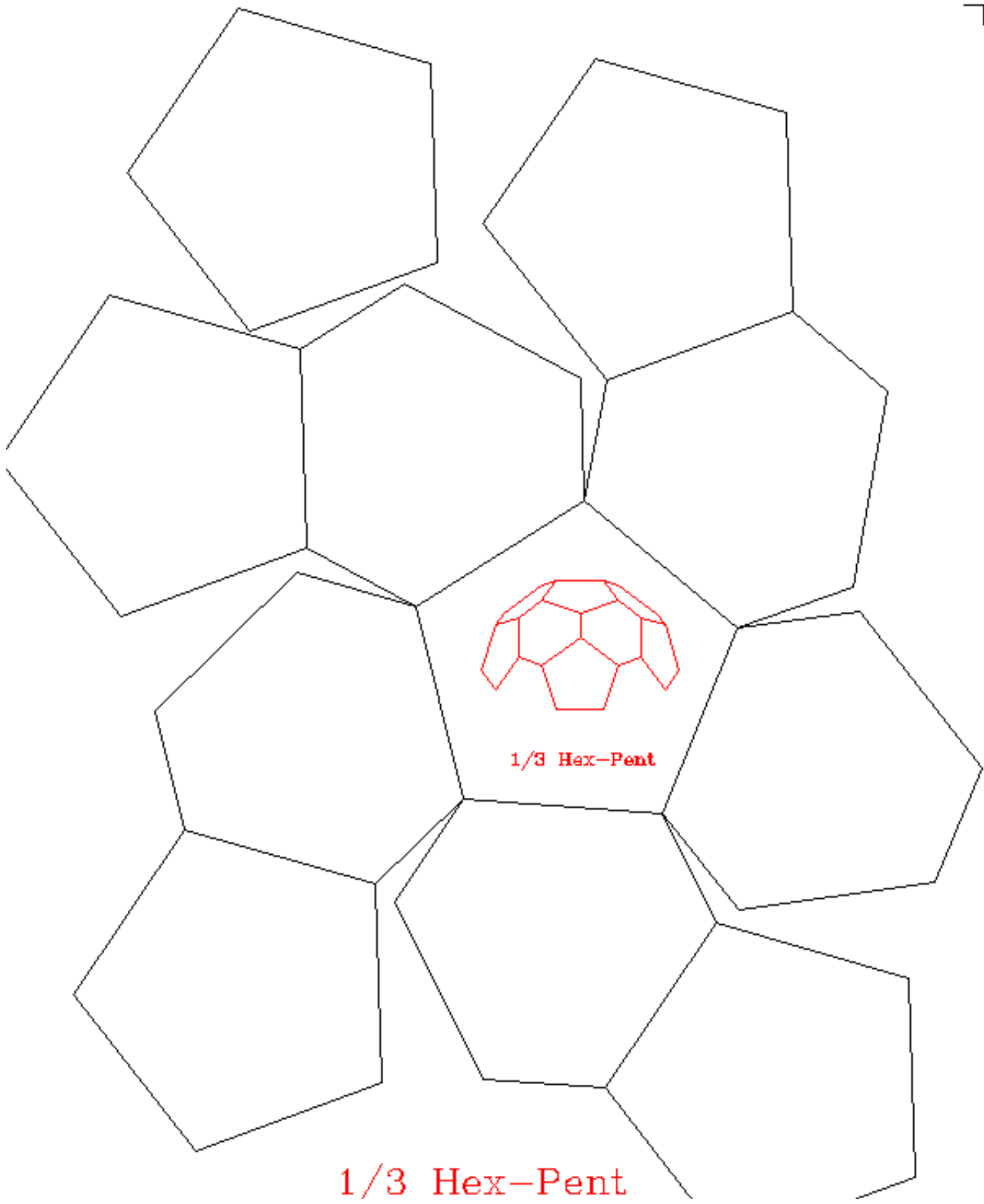

1/3 Hex-Pent

1/3 Hex-Pent

# Hex-Pent.dwg.(1.6)

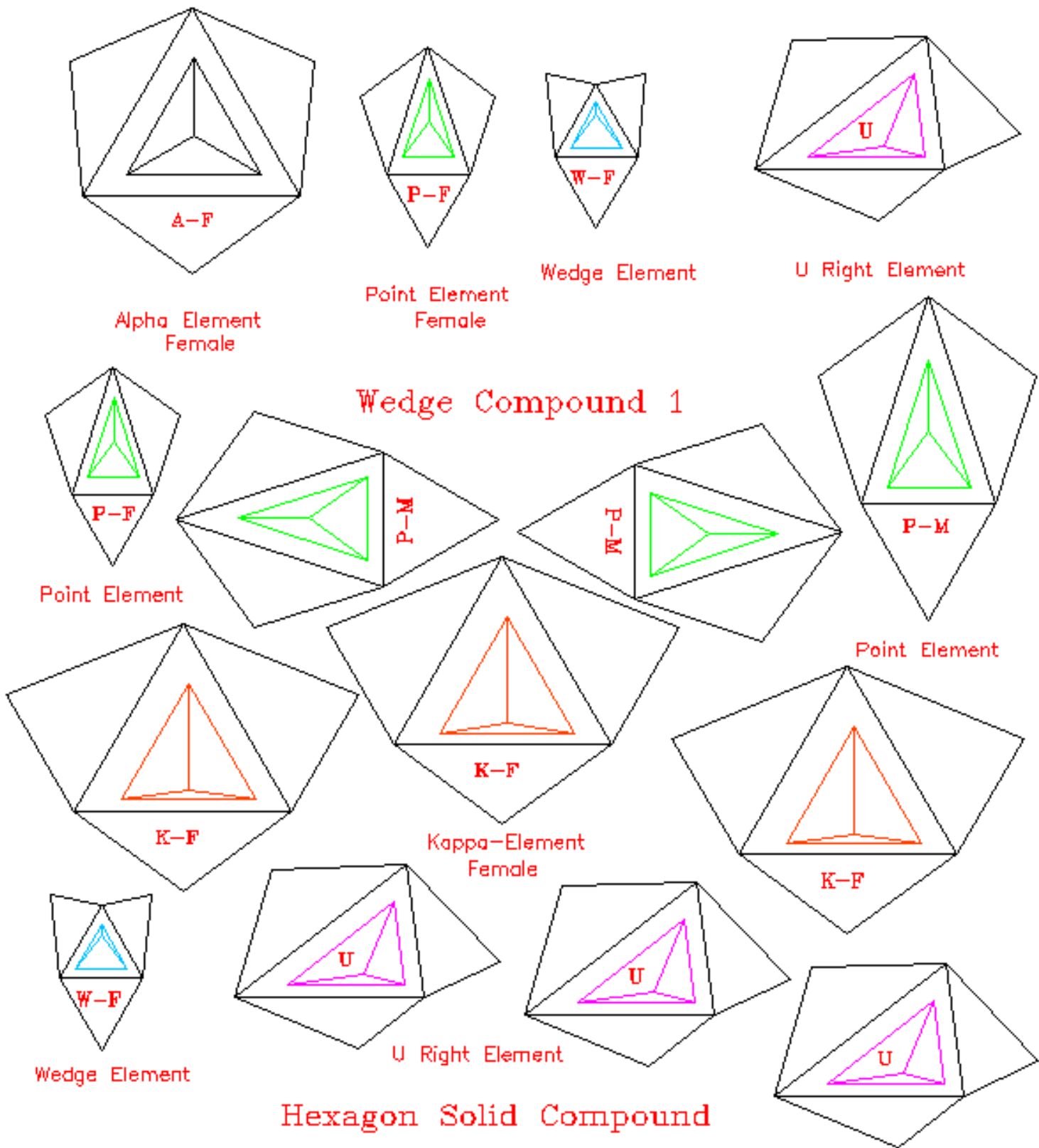

## Cut. Outs for Hexagon Solid

# and Wedge Compound 1

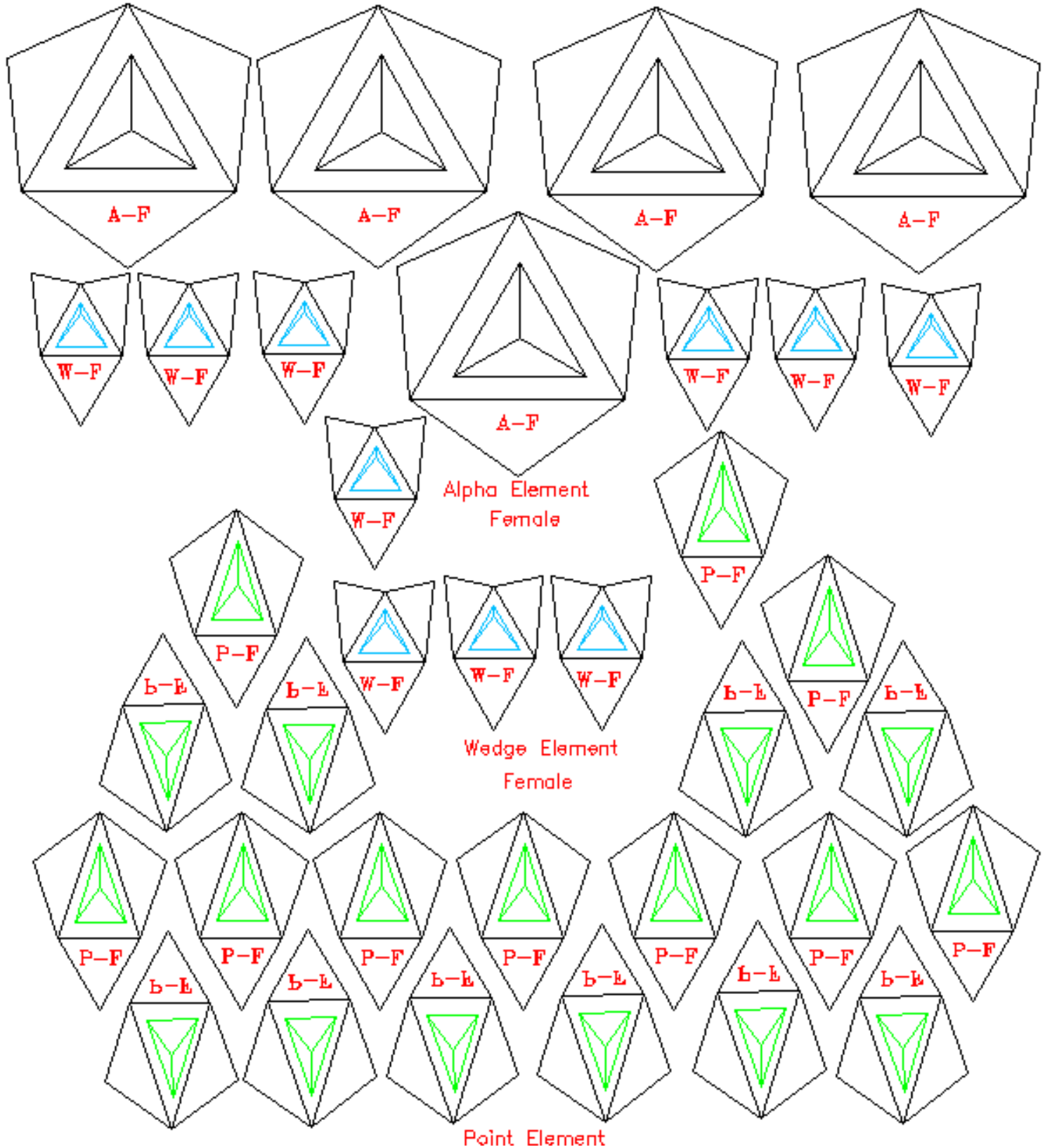

Female

# Cut-Outs for 1/2 Truncated Isocahedron Shell

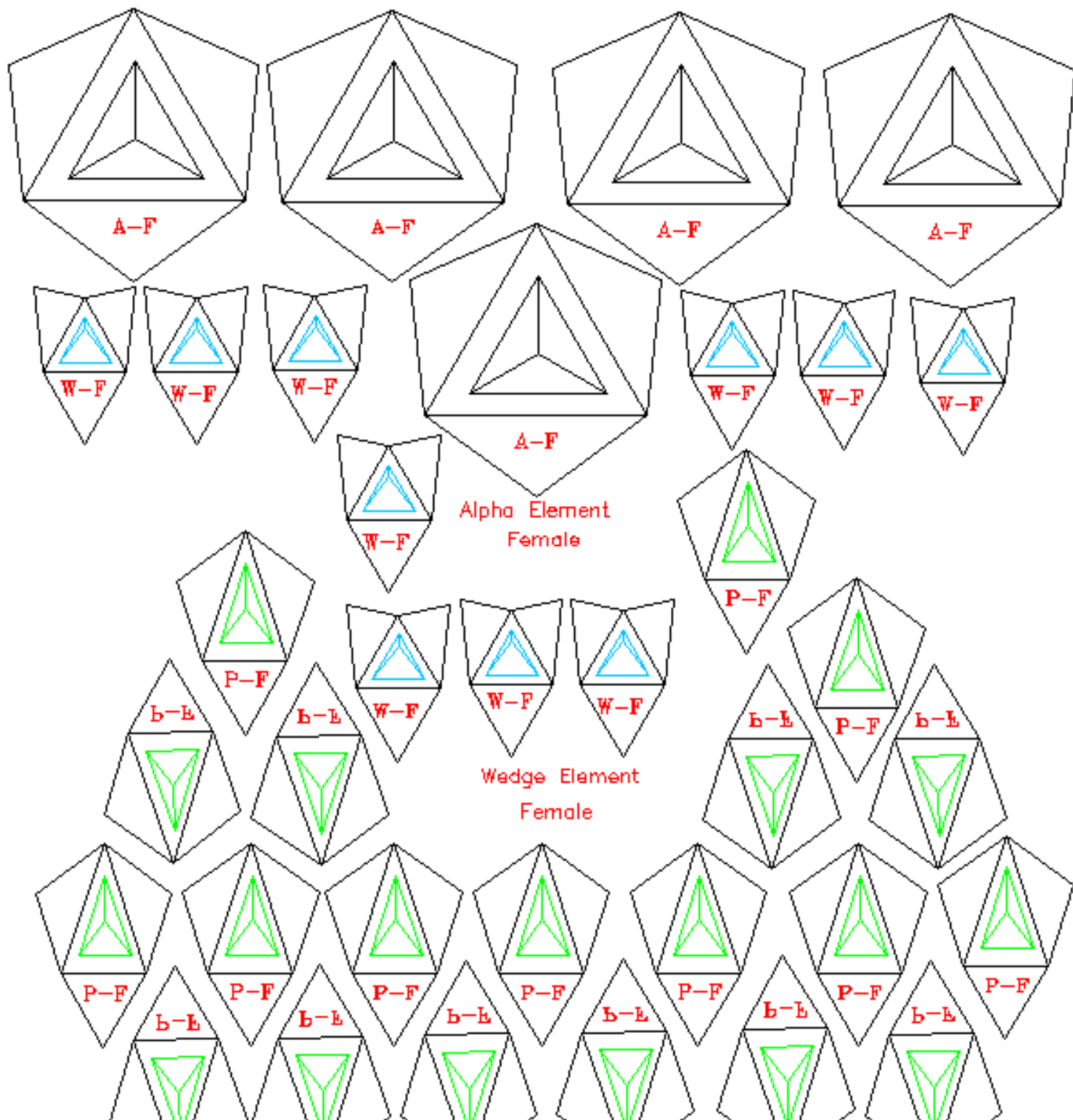





## Cut-Outs for 1/2 Truncated Isocahedron Shell

- [Go to Workbook Shareware Page](#)

[Up](#)

---

## my 7m dome

**NEW** [\[picture of aluminium dome\]](#)

(Well, 6.7m diameter actually (22 feet))

The geometry of the dome is based on an icosahedron, by adding new vertices at the midpoints of each edge, and then pushing these out to the circumscribing sphere. More edges are then added to create a mesh of triangles, with 4 for each original face of the icosahedron. The full polyhedron would have 42 vertices, 80 faces and 120 edges.

There are 2 different edge lengths, 2.06m and 1.82m (about 6'9" and 6'), which in the full "sphere" would be present in equal numbers (60 of each). This structure is only a 1/2 sphere, and lacks the (long) edges around the equator, and hence has 25 long poles, 30 short poles.

The entire sphere would have 12 5-way joints and 30 6-way joints. Breaking at the equator means that this dome has 6 5-way joints (one at the central apex), 10 6-way joints and 10 2-way anchor points. For the structure to be stable these anchor points need staking down.

In the completed dome, so long as forces are only applied to the joints, the structure exhibits great rigidity and strength, since the poles or joints do not experience torque (bending) forces. (This is not, however, the case during construction!)

The total length of aluminium tubing used is 103m or 343'. The total area of the triangles is 64.8 sq metres (~700 sq feet). The total mass is 43kg (96lb), of which the tubes comprise 85%. The central apex joint is capable of taking the weight of a person (80kg) swinging on the end of a rope, and is 11' above the ground. The usable floor area for a 6' individual is approximately 20 sq m, 220 sq ft. Total floor area is 32.6 sq m (~350 sq ft, or half the area of the dome, which would be an exact relationship for a true sphere)

The structure was raised for the first time on the afternoon of Sat 28 Sept 1996, and this took about 4 hours. It was taken down the following day in about 1 hour. Part of the time to put it up was due to the need to drill larger holes to give the bolts (sorry, panel-head machine screws) more clearance. 220 nuts/bolts is quite enough to make you sick of them! 2 nuts and no bolts were lost during this process.

My next project is to create a covering for the current framework-only design. The joints each have auxiliary holes to allow the bolting on of fixing points, exterior or interior.

---

The dome and its creator:

[\[dome from ground level, with me inside\]](#)

---

Cross Eyed stareogram: ([larger version](#))

[two stereo images]

---

During construction:

[only the top section of dome complete]

---

The various components:

[two stacks of aluminium tubes]

[close up of slot in end of tube]

[5-way joint in sheet steel]

[6-way joint in sheet steel]

[2-way anchor point, sheet steel]

[a heap of 220 nuts and bolts]

---

all but the tubes:

[all the joints on the ground]

---

A completed joint in close-up:

[6 tubes bolted onto 6-way joint]

---

Some nutter immediately after materialization in the dome:

[A certain Mr Treadaway, arms outstretched, allegedly]

---

After the aliens land:

[severely solarized and colourized picture of dome]

---

Last updated by [markt@chaos.org.uk](mailto:markt@chaos.org.uk) Fri 4 October 1996



- [PGP key](#) -

[Altavista advanced search](#)



Apparently the world's problems (such as preventing terrorism) are to be solved by a repeat of this:



But then when did sanity or learning the lessons of history ever impinge upon the brains of self-deluded hubristic warmongers? The future hinged on one pretzel, we were unlucky. Some attempts to count those most unlucky can be found, [here](#) and elsewhere. If you are feeling brave, you could see why this is happening, festering between the weasel-words at [PNAC](#)

(For those who don't know, this picture is of one of the hundreds of thousands slaughtered by the USAF in the early 1990s)

# Mark Tillotson's Homepage

"Accept no substitute"



[cute Kells zoomorphics as on a T-shirt wot I painted]

## New Links and Pages

- [My Highly Irregular Trawl of the Web](#)
- [TV Go Home](#) - the uncensored and unrepentent piss-take of the state of current broadcasting



nonsense. **NEW**

- [Total Eclipse, 11/8/99, viewed in Devon, SW England](#)
- official [Cambridge Community Circus](#) homepage
- [Grip Arts](#) - Charles Hull's Circus Theatre company.
- [Cigartin-sized computing](#)
- !Read these books!
  - For the technically minded "[Applied Cryptography 2nd Edition](#)" [Bruce Schneier's](#) crypto bible. ISBN 0471117099
  - For the security minded **NEW** "[Secrets and Lies - Digital Security in a Networked Age](#)" [Bruce](#)

[Schneier's](#) account of what security is and isn't - a MUST read. ISBN 0-471-25311-1

- "[The Fabric of Reality](#)" by [David Deutsch](#) ISBN hardcover 0713990619, paperback 014027541X
- "[Station X](#)" (the story of Bletchley Park by Michael Smith - not the book by George McLeod Winsor!) ISBN 0752221892
- [Hunter S. Thompson's "Fear and Loathing in Las Vegas"](#) ISBN 000655136X or 0679785892 or 0586081321
- [Quantum computation](#) site.
- [Dome construction workshops](#) run by John Moon this year around southern England.

[I became the first site to match the searches "yogurt weaving", "weaving yogurt" or "weave yogurt" on AltaVista - and then jf found me (by accident?) - I wonder.]

[Who am I](#) - [Where am I](#) - What am I [to be determined]

---

## Links & Interests

- [Technical \(Languages, Processor chips, GC, crypto, Digital toys\)](#)
  - [Juggling & Circus Skills Links](#) (including [Cambridge Community Circus](#) and [Stretch People](#))
  - [Music](#)
  - [Comedy series of note](#)
  - [Celtic artwork](#)
  - [String figures, cat's cradle](#) I blame the legendary Tarim for getting me into this pursuit.
  - [Some kite stuff](#) (I recently got myself a 4-line Revolution - try flying that in a gale!) [kite links](#) [more kite links](#)
  - [Scotland, mountains, whisky](#) - you can almost forgive the midges!
  - [my aperiodic tilings page](#) - Penrose and other not-quite-tesselations.
  - my [Geodesic domes page](#) geometry you can live in! (Including details of John Moon's dome construction workshops for 1999)
- 

## More Random stuff - I shall tidy up soon

- [Peter Seebach's hacker FAQ](#)
- [Private Eye](#) Sometimes the words are legible in the cartoons...



- [Ratbert for King!](#) (actually, has Ratbert a specified gender?)
- [Eddy](#) he who laughs last laughs loudest?
- [Tim](#) of the ultra high-wattage bike light league...

- [Paul](#) who can explain \_exactly\_ what pedantry is and is not, and specializes in building an experimental tower of copies of "The Guardian" for bizarre inscrutable reasons.
  - [Borris](#) who kindly helped out by housing these pages at [chaos.org.uk](http://chaos.org.uk) [\[picture\]](#)
  - [Bandy](#) who always confuses dyeing and bleaching and used to go "wooo oooo oooo" a lot.
  - [Ian, aka Roboklutz](#), for character assassination, see the Dilbert Zone.
  - The one and only [Conor](#) - do you believe everything you read on the Web?
  - [The Six Bells](#) A pint of dry cyber thank you.
  - [Harry the Bastard's brother's armoury co](#) - splendid swords!
  - [Japanese Swords](#)
  - [Sprocket](#) (Cambridge film guide)
  - [www.sincity.com](http://www.sincity.com) (the web page of Penn and Teller)
  - [comet Hale Bopp](#) | [larger](#) | [larger, solarized](#) (this image taken on an Olympus OM10, 500mm ?Centon? mirror lens, Kodak 1000ASA film)
- 

## Some mad things to do

- [Cover yourself in a swarm of bees and play jazz](#) rats - they seem to have removed this wonderful article about the bee-wrangler and clarinetist...
  - [Expedite the lighting of barbecues with liquid oxygen](#)
  - Completely [insert 4-inch nails](#) into each nostril!
  - **NEW!** [Wear bananas](#) for the Empire.
- 

## Useful Web sites

- [Cambridge Online City](#)
- [Cambridge Cinema Guide](#)
- [clickable map of UK sites](#)
- [Deja News](#) usenet search engine
- [Yahoo!](#)
- [Webcrawler](#)
- [AltaVista](#) and [advanced search](#) the hugest search engine ever?
- [fearsome search engines](#)
- [Browser Torture Test, HTML 3](#)



?!Hot Links!?

- [Firegirl](#)
- [M Stevens' Hot Links](#)

[Some pointless pictures to waste net bandwidth](#)

---

Last updated by [markt@chaos.org.uk](mailto:markt@chaos.org.uk) Mon 12 May 2003



[Up](#)

---

# my 7m dome

**NEW** (Well, 6.7m diameter actually (22 feet))

The geometry of the dome is based on an icosahedron, by adding new vertices at the midpoints of each edge, and then pushing these out to the circumscribing sphere. More edges are then added to create a mesh of triangles, with 4 for each original face of the icosahedron. The full polyhedron would have 42 vertices, 80 faces and 120 edges.

There are 2 different edge lengths, 2.06m and 1.82m (about 6'9" and 6'), which in the full "sphere" would be present in equal numbers (60 of each). This structure is only a 1/2 sphere, and lacks the (long) edges around the equator, and hence has 25 long poles, 30 short poles.

The entire sphere would have 12 5-way joints and 30 6-way joints. Breaking at the equator means that this dome has 6 5-way joints (one at the central apex), 10 6-way joints and 10 2-way anchor points. For the structure to be stable these anchor points need staking down.

In the completed dome, so long as forces are only applied to the joints, the structure exhibits great rigidity and strength, since the poles or joints do not experience torque (bending) forces. (This is not, however, the case during construction!)

The total length of aluminium tubing used is 103m or 343'. The total area of the triangles is 64.8 sq metres (~700 sq feet). The total mass is 43kg (96lb), of which the tubes comprise 85%. The central apex joint is capable of taking the weight of a person (80kg) swinging on the end of a rope, and is 11' above the ground. The usable floor area for a 6' individual is approximately 20 sq m, 220 sq ft. Total floor area is 32.6 sq m (~350 sq ft, or half the area of the dome, which would be an exact relationship for a true sphere)

The structure was raised for the first time on the afternoon of Sat 28 Sept 1996, and this took about 4 hours. It was taken down the following day in about 1 hour. Part of the time to put it up was due to the need to drill larger holes to give the bolts (sorry, panel-head machine screws) more clearance. 220 nuts/bolts is quite enough to make you sick of them! 2 nuts and no bolts were lost during this process.

My next project is to create a covering for the current framework-only design. The joints each have auxiliary holes to allow the bolting on of fixing points, exterior or interior.

Last updated by [markt@chaos.org.uk](mailto:markt@chaos.org.uk) Fri 4 October 1996

## A short page about Buckminster Fuller (Bucky)

[homepage](#) → [people](#) → [buckminster fuller](#)

Richard Buckminster Fuller: the planet's friendly genius. A scientist, philosopher. Bucky has gained renown as an inventor and designer (of the Dymaxion house, car and map), the creator of the [geodesic dome](#), the man who coined the term "Spaceship Earth" and organized the World Game, the mathematician who discovered Synergetics, and as a dogged individualist whose genius has been felt throughout the world. He made his mark in areas of architecture, mathematics, philosophy, religion, urban development and design, naturalism, physics, numerology, art and literature, industry and technology.

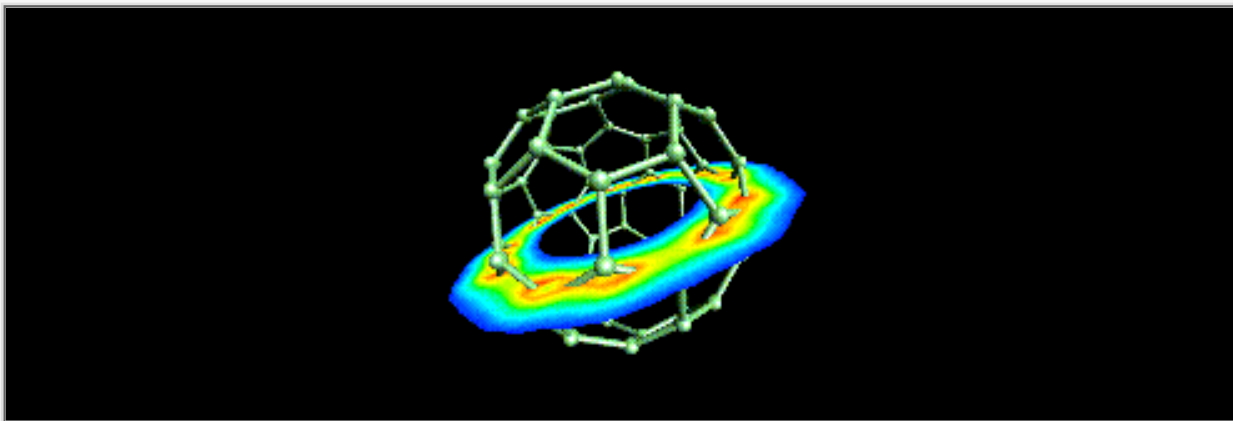

(A display of a 2D slice through the total electron density of C-60 (buckyball).  
Image created by Cary Sandvig - from [SGI gallery / Computer-Aided Chemistry](#).  
Click for larger version. Cool for use as windows background.

Few ideas from Richard Buckminster Fuller's "Critical Path" (pg. 233/234):

"All technical evolution has a fundamental behavior pattern. First there is scientific discovery of a generalized principle, which occur as a subjective realizatin by an experimentally probin individual. Next comes objective employment of that principle in a special case invention. Next the invention is reduced to practice. This gives humanity an increased technical advantage over the physical environment. If successful as a tool of society, the invention is used in bigger, swifter, and everyday ways. For instance, it goes progressively from a little steel steamship to ever-bigger fleets of constantly swifter, higher-powered ocean giants."

"All the technical curves rise in tonnage and volumetric size to reach a 'giant' peak, after which progressive miniturization sets in. After that, a new and more economical art takes over and then goes through the same cycle of doing progressively more with less, first by getting bigger and taking advantage, for instance, of the fact that doubling the length of a ship increases its wetted surface fourfold but increases its payload volume eightfold."

(principle holds true for ships of both air and water)

Then comes the miniaturization, the overall and inexorable trending to DO MORE WITH LESS, known as "progressive ephemeralization". Trends toward an ultimate doing of everything with nothing at all, which is a trend of the omniweighable physical to be mastered by the omniweightless metaphysics of intellect.

This same fundamental evolutionary pattern of bigger, then smaller: Missles (more killing, less human effort, greater distances, higher speeds, increasing accuracy).

► Check this: [Geodesic Domes!](#)

---

Textfiles:

- [The Buckyball: An Excruciatingly Researched Report.](#)
- [The birth of the Geodesic Dome - how Bucky did it.](#)

Images and texts:

- [Photos of some dome houses](#)
- [Geodesic Domes](#)
- [Tensegrity and other structures.](#)
- [Comments about the book Synergetics.](#)

Links to related information:

- [Synergetics Home Page](#) - pages by [Kirby Urner](#)
- [Global Energy Network International](#)
- [Dome Project](#): Dome project at synergetics institute is intended to making dome as a shareware house, stable to live, cheap to buy, easy to build.
- [The Pavilion of Polyhedreality](#)

[Rodrigo A. Siqueira](#)

# The Tensegritoy:

---

Preliminay page setup: draft text; the tensegrity toy: some wanted to know....

---

## The Tensegritoy

The *Tensegritoy* is an educational kit available at various science stores.

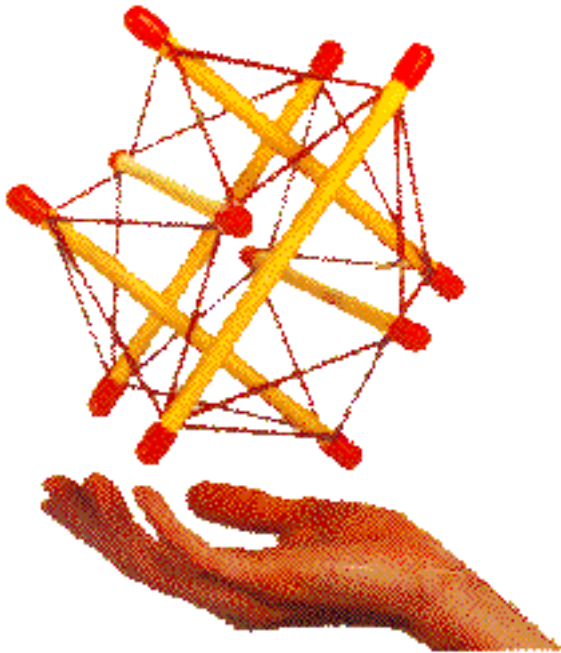

---

The more complicated structure on the right has 30 rods and the manual that comes with the kit describes it as an icosahedron ( suggesting that you build it with the rods touching at the ends, five converging at each vertex, and then spreading the ends apart, yeilding a truncated icosahedron ).

( see: [The Platonic Solids](#) )

**Tensegritoy**  
**Design Science Toys LTD.**  
1362 Route 9  
Tivoli, NY 12583 ( USA )  
Phone: 1-800-227-2316  
FAX: 914-756-4223

The basic Tensegritoy kit comes with 30 twelve inch hardwood dowels and it retails for about \$30.

**Tensegritoy is a registered trademark of  
Tensegrity Systems Corporation  
Tivoli, NY 12583**

**I have no relationship with this company and  
am in no way associated with the product.**

## **Links:**

**[Fuller faq-4](#) Tensegrity structures and domes.**

**[Matt Gorbet's Journal Entries for MAS123](#) An MIT student goes geeky on the toy.**

**Buy it on the web:**

**Catalog: [kits for building geodesic domes and tensegrity structures.](#)**

**Catalog entry: [Tensegritoy](#)**

*I have no relationship with these outlets, and I am not endorsing them.*

**A related topic: [The Platonic Solids: The dodecahedron and the rest.](#)**

---



**[My humble Home Page](#)**

**Previous Page: ( [Tensegrity Structures #3](#) )**

**First Page: ( [Tensegrity Structures #1](#) )**

---

*Last modified: 05/06/96 ( draft )*

*First Created: 05/06/96*

---

**Copyright © 1996 by Paul Flavin. All rights reserved.**

**The images above were obtained from the above sites and to the best of my knowledge are  
not copyrighted.**

# QuasiTiler 3.0

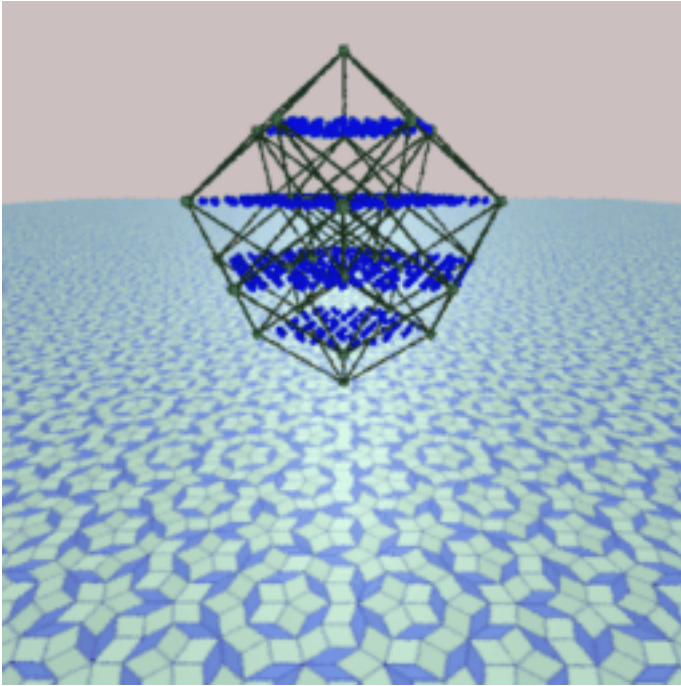

by [Eugenio Durand](#)

World Wide Web front end by [Paul Burchard](#), [Daeron Meyer](#) and [Eugenio Durand](#) at the [Geometry Center](#), University of Minnesota, March 1994.

[CLICK HERE TO START INTERACTIVE APPLICATION.](#)

For more about tilings, go to [ScienceU](#)

---

## Contents

- [Introduction](#)
- [Geometry of Quasicrystals](#)
  - [One dimension, 2 dimensions,  \$n\$  dimensions](#)
  - [Doing it by numbers](#)
  - [What is the picture at the top of the document?](#)
  - [Quasicrystals](#)
- [Using QuasiTiler](#)

- [Tile display](#)
- [Generating plane](#)
- [Things to do with QuasiTiler](#)
- [Things that can go wrong](#)
- [Conclusion](#)
- [Acknowledgements.](#)
- [References](#)

# Introduction

QuasiTiler draws Penrose tilings and their generalizations. This document explains the interesting geometry involved in the processes. The concepts involved are surprisingly simple. The only apparent hurdle that we have to overcome is working in spaces with more than 3 dimensions. However in the next section we start with examples in 2 and 3 dimensions where our intuition is useful. Then we extend the same concepts to more dimensions. I hope that you get some insight on the geometry of higher-dimensional spaces by reading this document and by experimenting with QuasiTiler.

Penrose tilings are well known because of their interesting and sometimes intriguing properties; for example, they are locally but not globally symmetric under 5-fold rotations, quasi-periodic with respect to translations, self-similar, and more. See the [references](#) at the end of this document if you want to find more about Penrose tilings. If you do not know what a Penrose tiling is, there is one in the background of the image at the top of this document.

N.G.deBruijn in 1981 showed that Penrose tilings can be seen as the projection of a relatively simple object in 5-dimensional space. QuasiTiler uses deBruijn's approach to generate tilings.

The original version of QuasiTiler is a NeXTSTEP application, with more features than the ones possible to implement over the web. It is available by anonymous ftp from this server. See the [reference](#) at the end of this document.

## Geometry of Quasicrystals

### One dimension, 2 dimensions, n dimensions

Before we jump into 5 dimensions, let's start with 2. We look first at the coordinate plane, which is a 2-dimensional space. In this plane we consider the points with integer coordinates. We call these points an *integer lattice*. The lattice together with the corresponding edges fills the plane with a grid of squares. We pick any line in the plane and we call it line E for convenience.

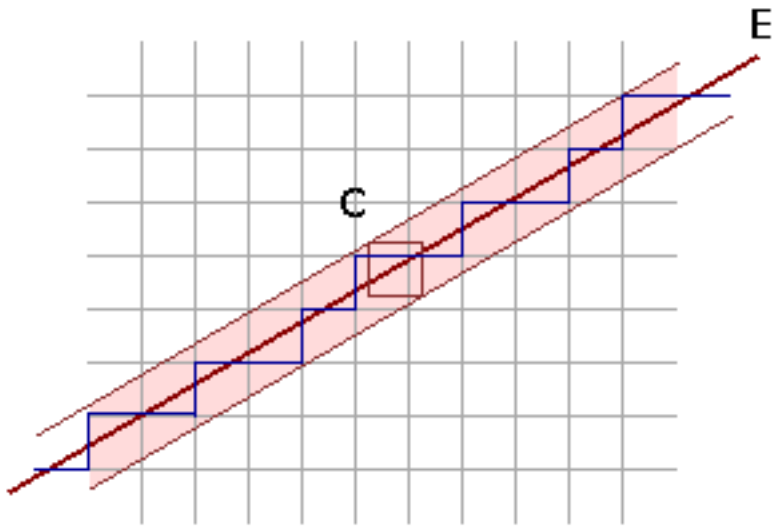

We look now to a region of the plane around the line E. This region is just wide enough to contain any square with side length 1 centered at any point on the line E. We call this region C. Now we select all the points in the lattice that happen to be inside the region C. We also select all the edges that join these selected points. We obtain a funny looking staircase curve as result. Now we project the staircase perpendicularly onto E. Adjacent edges of the staircase collapse to adjacent line segments in E. We have as result a tiling of this one-dimensional space.

Observe that we can choose the line E anyway we want, obtaining a different staircase each time. An important property depends on the slope of E: if we choose the *slope* of E to be a *rational number* then the pattern of the staircase and the projected tiling repeats itself periodically; but if the slope is an *irrational number* the pattern is not periodic. However in this last case, if we choose any piece of the staircase (of finite size) the chosen piece will be repeated an infinite number of times at different places all over the region C: we get a *quasiperiodic* staircase.

QuasiTiler does exactly the same thing. But instead of using the line E and a square grid on the plane, it uses a plane and an integer lattice in spaces of dimension 3, 4, 5 or more. By passing a higher-dimensional cube along E, we get a 2-dimensional staircase sitting in a higher-dimensional space. QuasiTiler then projects the staircase surface onto the plane E. The result is the tiling that you see.

Let's work with the idea in 3 dimensions first: instead of a grid of squares in the plane we consider a 3-dimensional grid of cubes, and a 2-dimensional plane crossing them instead of a line. The vertices of the cubes are the points on the integer lattice. We take a plane E, and as before slice the space with it and look at the region C around the plane E. This region is just wide enough to contain all the cubes of side-length 1 centered at any point in the plane E. We select then all the lattice points inside this region C, together with the corresponding edges and faces. The result is an arrangement of steps, which we project into the plane E. You can see in the next image two different results obtained with QuasiTiler by choosing two different planes.



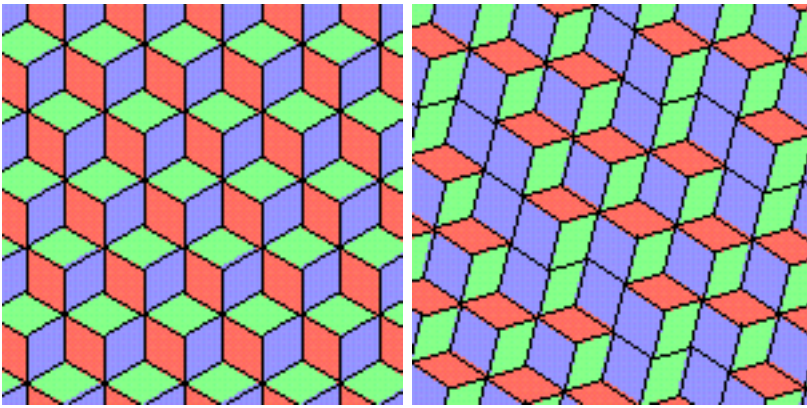

With QuasiTiler we can browse in 4, 5 or more dimensions by taking 2-dimensional "slices" of the corresponding lattice. The results will get more interesting. The more dimensions we have the more things can happen. For example, Penrose tilings are just a particular class of these slices in 5-dimensional space.

QuasiTiler shows also a different view of the same staircase surface sitting in  $n$ -dimensional space by projecting it into the space orthogonal (= perpendicular) to the plane E. The lattice points in C all project into the interior of the projection of the  $n$ -dimensional cube. The image below corresponds to a Penrose tiling.

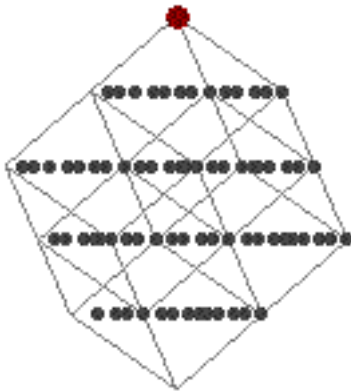

The gray points correspond to the lattice points near the plane E. The region C is represented by the light gray lines, which are the edges of an  $n$ -dimensional cube of side-length 1, with  $n$  equal to 5 in this particular case. Finally the large red dot represents the origin of the coordinate system, and indicates the position of the plane E and the region C relative to the integer lattice and the ambient space. [You are in control](#) of this red dot in the program.

Notice that the orthogonal space to E has dimension  $n-2$ , but QuasiTiler shows you only a 2-dimensional view since a computer screen is flat. This is good enough in most cases anyway. However there is room to improve this flat view. For example, the image at the top of this document shows a 3-dimensional view in perspective of the same object represented in the image above.

# Doing it by numbers

So far we have talked about an arbitrary plane in  $n$ -dimensional space, but we haven't said how we are going to manipulate such an object. We will use some linear algebra from here to the end of this section (do not worry if you do not understand all the details -- the geometry explained up to this point is the important part). We are just going to attach some numbers to the geometry so we can conveniently deal with it. QuasiTiler keeps track of the numbers, but also allows you to deal directly with the numbers if you want.

The plane  $E$  is specified by one position vector and two direction vectors. In QuasiTiler, we call the position vector the *offset*, and the two direction vectors the *generators*. There are some conditions that we are going to impose on these vectors. The first condition is that the two generators need to be *linearly independent*; this is a necessary condition, otherwise we would get a line instead of a plane. The next condition is that the generators are orthogonal to each other and of length 1; this is not necessary, but it will be helpful, as we will see later. The final condition is that offset has to be orthogonal to the plane  $E$ ; this condition is just to simplify the computations. QuasiTiler allows you to enter the numbers directly, and makes sure that all the conditions are satisfied.

To ensure that the offset is orthogonal to the plane  $E$ , the offset vector is always represented as a vector in the *orthogonal complement* of the plane  $E$ , which is an  $(n-2)$ -dimensional space. The position of the large red dot in QuasiTiler's [offset control](#) is determined by the first two coordinates of the offset.

Let's see now the advantages of having the generators orthogonal to each other and of length 1. We consider the *canonical basis* of the ambient space. The canonical basis is just the vectors of the form

$$\begin{aligned} & ( 1, 0, 0, \dots ), \\ & ( 0, 1, 0, \dots ), \\ & ( 0, 0, 1, \dots ), \dots \end{aligned}$$

When the condition on the generators is satisfied, we can tell right away the coordinates of the projection onto the plane  $E$  of the  $k$ -th canonical basis vector; these coordinates are the same as the  $k$ -th coordinates of the two generators. And these projections of the canonical basis are important for us, since they are precisely the edges of our tiles, as we explain next.

Remember that the edges of the surface in the higher dimensional space are just the edge of some  $n$ -dimensional cube with integer coordinates vertices. And the edges of any of these  $n$ -dimensional cubes are a translation of one of the vectors in the canonical basis, which are then projected onto the plane  $E$ . Thus all the edges in the tiling are just the projection of one of the vectors from the canonical basis translated to the corresponding vertex. Furthermore any tile is just a parallelogram determined by a pair of these edges. In other words, the projections of the canonical basis give the coordinates to build the tiles.

# What is the picture at the top of the document?

The picture illustrates the geometry behind QuasiTiler. A tiling obtained by QuasiTiler comes from the projection of a particular surface in  $n$ -dimensional space determined by a set of points with integer coordinates in  $n$ -dimensional space. You can see on the picture two different projections of the same surface.

- In the background is a Penrose tiling, which is the projection of the surface onto the generating plane E (see the [previous section](#)).
- In the foreground is the projection of the vertices of the surface onto the space orthogonal to the generating plane. The vertices of the surface are shown as blue dots. Also shown in green are the edges and vertices of the projection of a 5-dimensional unit "cube."

Notice the vertices of the surface also have structure when projected in the orthogonal space to the plane. For example in this particular case the points are confined to 4 planes. In fact the properties of the Penrose tiling are encoded in the orthogonal view. The position of each projected vertex inside the projected 5-dimensional cube determines the configuration of tiles at the corresponding point in the tiling.

## Quasicrystals

Perhaps you are wondering what might be the results of taking a 3-dimensional slice instead of a 2-dimensional one. It would be a structure similar to the Penrose tilings, whose building units fill space quasiperiodically. Although for nearly 200 years this was assumed to be impossible, such crystals really exist! See the [references](#) at the end of this document.

## Using QuasiTiler

QuasiTiler is implemented as a HTML fill-out form. It is divided in two areas: the first is the tile display together with the input widgets to control how the tiling is displayed. The second area has the widgets to control the generating plane.

## Tile Display

The tiling computed by QuasiTiler is the top-most image. You can control this display in several ways. You can choose which rectangular region of the tiling is displayed, and adjust some aspects of how the tiles are drawn. You have the following options:

- To display a different region of the tiling, **select any point** in the image. A new image will be computed with the selected point at the the center.
- To change the size of the displayed region you can choose one of the following **zoom options**:
  - None. The new region of the tiling has the same size as the last one; this is the default.

- Out. The new region will be larger, with more and smaller tiles.
- In. The new region will be smaller, with fewer and bigger tiles.
- To change how the tiles are drawn, you can choose any of the following **display options**:
  - Edges. If selected, the edges will be displayed as black lines; no edges are displayed otherwise.
  - Tiles. If selected the tiles are shaded with a color depending the shape of the tile; the tiles are not displayed otherwise.
  - Color. Determines whether the tiles are painted with different colors or with shades of gray. Keep in mind that the colors have no particular meaning, they are chosen just to underline the symmetry of the tiling.
  - GIF Only / PostScript Only. Select one of these if you would like to have the next computed image of the tiling returned to you as a stand alone image document. Otherwise QuasiTiler will return a new HTML form with the new tiling included as an inlined image to use interactively.

## Generating Plane

In the the two dimensional example [above](#), we can determine the line E by choosing a point and a direction. A convenient way to describe these point and direction is with two vectors. In the same way a plane can be determined by three vectors. One vector determines a point through which the plane goes; we call this the **offset**. The other two determine the direction of the plane; we call these the **generators**.

## Changing the Offset

The program allows you to modify this parameter in two different ways. One is to select a point in the image that looks similar to the following one.

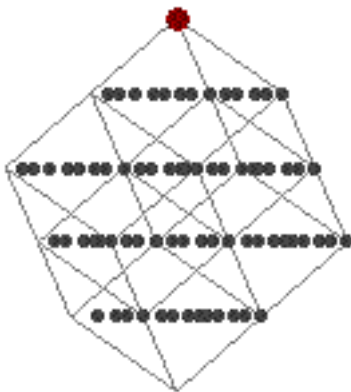

In this image you can see the relative positions of the lattice points inside the region R. The view is a projection into two of the orthogonal directions to the generating plane. You are in control of the

red dot, which represents the center of the coordinate system, *the origin*. Whenever you select a point in this image the origin will move there; the offset of the plane E will change correspondingly. Keep in mind that this method you can only change two coordinates of the offset vector, however this gives more than enough room to explore.

If you insist on changing the offset in all its coordinates you can use the second method. At the bottom of the form there are three columns of numbers. The coordinates of the offset vector are on the first column. Type any values you want and submit the form when you are done. On the technical side, this vector is expressed in the coordinates of the space orthogonal to the generating plane.

## Changing the Generators

QuasiTiler presents you with a sample of the current tiles in an image similar to the one below. The "direction" of the plane, which is given by the generators, determines the shape of the tiles. You can change the generators by selecting a point in the image.

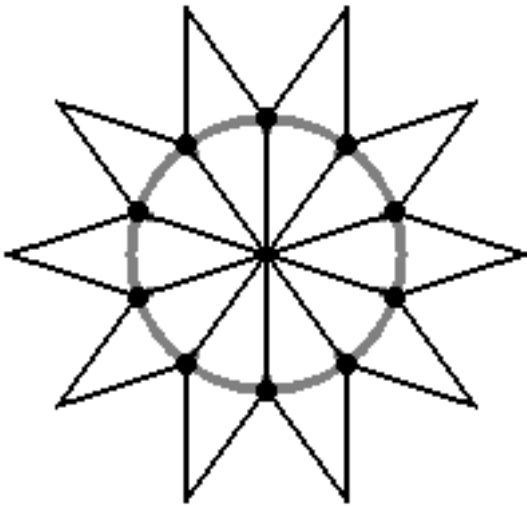

The fat points in the image represent the projection of the *canonical basis* of the ambient space into the generating plane. When you select a point in this image, the program will move the generating plane so that the nearest fat point will move as close as possible to your selection, dragging with it the shape of the tiles. Some directions and shapes will give more pleasing tilings than others. The default values produce tiles symmetric under rotations.

As with the offset, it is possible for you to change the coordinates of generators directly. The coordinates of each generator are on the two columns at the end of the form. Type any values you want and submit the form when you are done. Notice that there are some conditions that must be satisfied by these numbers; QuasiTiler modifies your input to enforce those conditions. This is explained in a [previous section](#).

# Things to do with QuasiTiler

Try any of the [display options](#).

You will always get an interesting result.

Select a point in the offset image.

You will get a different tiling using the same tiles. Notice how the tiling changes with as you change the relative positions of the plane and the lattice. This is the favorite control of the author. You will always get an interesting result.

Change the dimension of the ambient space.

Start with 3 dimensions; the image are not as interesting but you will recognize the cubes that project as the tiling. As you increase the dimension to 4 or 5, try to keep the same image of "stacks of cubes."

Redecorate the bathroom :-)

The tiles are always parallelograms. You can read the shape of each from the numbers in the bottom of the form. Check the [section](#) explains these numbers. But in the default symmetrical case is easier: all the edges have the same length, and the angles are multiples of  $(180 \text{ degrees}) / (\text{dimension of ambient space})$ . You have to [let me know](#) if you actually get involved in a project like this!

## Things that can go wrong

### Time out error

The server has limit on the time it can spend to satisfy your request. Possible reasons for going over the limit are: you zoom out too much, you selected a large dimension, the server is working on other requests simultaneously to yours, or a combination of any of the previous. Try to zoom in or select a smaller dimension.

### Tiles with strange shapes

Some choices of generators produce very asymmetrical tiling. Start over or change dimension to get the default symmetrical settings.

### Missing tiles

In some rare occasions a point in the integer lattice is too close to the border of the region determining the tiling. QuasiTiler can not tell if the point is inside or outside in such case. To be on the safe side, QuasiTiler guess is that the point is outside. But sometimes the guess is wrong and there is a hole in the tiling. A solution is to change some of the less significant digits in the offset.

### The demo is not working

Chances are that your WWW browser does not support forms and/or inlined images. Try to get a newer version that supports this features.

# Conclusion

I hope that you have fun and learn with QuasiTiler, as I did writing it. I just would like to make the following point. There is somehow a general idea that 4, 5 or more dimensions have some sort of mystical properties. I find this idea surprising, maybe even disturbing: as you can see in this program,  $n$ -dimensional spaces are just mathematical concepts, interesting to study on their own, and also useful as tools to find solutions to other problems. For example QuasiTiler uses them to produce interesting and nice looking patterns.

Please send me your [comments](#), I am looking forward to them.

## Acknowledgements

The original motivator to write QuasiTiler was Prof. Marjorie Senechal, Dept. of Mathematics, Smith College, Northampton, MA. During her visit to the Geometry Center she required a convenient way to generate Penrose tilings and so the project started. She has provided the expertise on the subject essential to write QuasiTiler and this document.

## References

### Penrose tilings

Martin Gardner, Mathematical Recreations, *Scientific American*, **236** (January 1977) 110-121 . This is a very enjoyable article.

Martin Gardner, *Penrose Tiles to Trapdoor Ciphers*, W.H.Freeman, New York, 1989.

Roger Penrose, *The Emperor's New Mind*, Oxford University Press, New York, 1989. Yes, he is the same Penrose as in "Penrose tiles." The tiles are mention only briefly though.

N.G.deBruijn, *Algebraic theory of Penrose's nonperiodic tilings of the plane, I, II*, Nederl. Akad. Wetensch. Indag. Math. **43** (1981) 39-52, 53-66. This is deBruijn original paper, hard to read.

Stan Wagon, *Mathematica in Action*, W.H.Freeman, New York, 1991, chapter 4. Here you can find how to generate Penrose tilings using the Mathematica software, together with a nice explanation of some of their properties. The approach used here is different from QuasiTiler. It has further references too.

Ivars Peterson, *The Mathematical Tourist: Snapshots of Modern Mathematics*, chapter 7, W.H.Freeman, New York, 1988. Here the book's author stops short of exploring the same ideas as in this document.

# Quasicrystals

Marjorie Senechal, [online article](#) on this server.

Marjorie Senechal, *Quasicrystals and Geometry*, Cambridge University Press, 1995. To appear.

D. R. Nelson, Quasicrystals, *Scientific American*, **255** (August 1986) 42-51.

D. R. Nelson and B. I. Halperin, Pentagonal and icosahedral order in rapidly cooled metals, *Science*, **229** (19 July 1985) 233-238.

# QuasiTiler

On the [Geometry Forum](#) on this server, there is an [article regarding QuasiTiler](#) with a brief explanation.

Check also a [another explanation](#) to the mathematics behind QuasiTiler, by Prof. Marjorie Senechal, an expert on the subject.

QuasiTiler is also available as a NeXTSTEP application by anonymous ftp from the [Geometry Center FTP](#). To download the Multi-Architecture Binary (Motorola, Intel, HP PA-RISC) [/pub/software/QuasiTiler-3.0.tar.Z](#) click here.

# Other Resources

Many other references and software packages related to tilings are detailed in Doris Schattschneider's list of [tesselation resources](#).

Any comments and suggestions concerning this web server are welcome and should be e-mailed to [webmaster@www.geom.uiuc.edu](mailto:webmaster@www.geom.uiuc.edu).

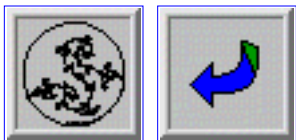

*The Geometry Center  
University of Minnesota  
400 Lind Hall  
207 Church Street S.E.  
Minneapolis, MN 55455*



Yurts, Domes, Portable Geodesic Greenhouses, Emergency Disaster Relief Shelters, Tents, Portable Classrooms, Cabin Tents, Hot Tub and Spa Covers, Pool Covers, Guest Houses, Ski Huts, Base Camps, Youth Camps, Ecotourism Cabins, Camping Tents, Mobile Offices, Shade and Solar Structures...



Shelters

Greenhouses

What's New?

Gillis Designs

Stories

Q's & A's

## Innovative Yurts, Domes, Tents and Gardening Shelters. Many shapes and sizes to 30 feet in diameter. Up in only 30 minutes!

### Portable and Affordable!™

Shelter Systems offers a variety of truly portable Yurts, Domes, Shelters, Greenhouses and Tents that are totally waterproof. These Structures have been serving people around the world for over 25 years. We manufacture a wide range of patented Tensegrity and Geodesic structures using our own tarp fasteners, the "Grip Clips." In Shelter Systems' Yurts, Domes, Shelters, Greenhouses and Tents the covering panels are "shingled," overlapping each other to make a totally waterproof and yet breathable shelter.



Our portable Geotensic™ Yurt structures are truly portable shelters, similar to the Mongolian yurts. Our Shade Structures can provide shade when covered with our sun blocking Shade Covering. Our Solar Structures collect solar energy when covered with our translucent Solar Greenhouse Coverings. Shelter Systems is dedicated to providing portable, affordable and environmentally friendly solutions to shelter and gardening needs.

Permission is granted to electronically copy and to print in hard copy portions of this Web site for the sole purpose of placing an order or using this site as a shopping resource.

#### 30-DAY RISK-FREE TRIAL 1 1/2-YEAR GUARANTEE

Our guarantee is simple. **YOU MUST BE SATISFIED!** If for any reason you're not completely pleased with your purchase, return it in original, clean condition within 30 days of receipt for a full refund or exchange as you wish. All items in this catalog have a warranty against defects in materials and workmanship for **1 1/2 years**. Should any product prove defective we will

Yurts, Domes, Portable Geodesic Greenhouses, Emergency and Nomadic Shelters, Tents

repair or replace it at no cost to you. Special Orders are not returnable. Read [Snow and Wind Warnings](#).

[To order](#) by Fax or Mail.

[Order online with our Secure Order Form!](#)

**For fast credit card orders call 650-323-6202**

Questions? E-mail us at [shelter@best.com](mailto:shelter@best.com). Please feel free to call or write us anytime. Shelter Systems-OL, 224 Walnut St., Menlo Park, CA 94025. FAX 650-323-1220 Phone 650-323-6202.

[Shelters](#)

[Greenhouses](#)

[What's New?](#)

[Gillis Designs](#)

[Stories](#)

[Q's & A's](#)

[Price List](#)

[Shelter Systems' Map of Site](#)

**Shelter Systems** © 1996 - 2003 All Rights Reserved

[Shelter Systems' Home](#)











Florida Housing Center  
Tallahassee, Florida

- [FHBA Home](#)
- [FHBA Shopping Mall](#)
- [Members Only Area](#)
- [SEBC Home](#)



- [About FHBA](#)
- [Advertising Info](#)
- [Award Programs](#)
- [Bookstore](#)
- [Calendars](#)
- [Committees](#)
- [Conferences](#)
- [Consumer Information](#)
- [Contacts](#)
- [Education](#)
- [FHBIA Insurance](#)
- [Governmental Affairs](#)
- [HomeBuilder Magazine](#)
- [Housing Statistics](#)
- [Industry Links](#)
- [Job Board](#)
- [Local Associations](#)
- [Marketplace](#)
- [Membership](#)
- [News Room](#)
- [Search the Site](#)
- [Special Programs](#)
- [Volunteers/](#)
- [Staff Leaders](#)



Welcome to . . .

# The Florida Home Builders Association

**Building Florida's Future**



Learn how you can become  
an FPL BuildSmart builder.



## FHBA Releases Consumer-Based Residential Rebuilding Model Contract

As a service to home owners who have lost all or a portion of their homes as a result of Hurricane Charley, the Florida Home Builders Association (FHBA) today released a Residential Rebuilding Model Contract to aid consumers in their quest to rebuild their homes. The Residential Rebuilding Model Contract is specifically designed to protect citizens from unscrupulous contractors. There are four key elements to FHBA's Residential Rebuilding Model Contract: 1) Consumer Warnings, 2) Florida's Construction Lien Law, 3) Contract Instructions, and 4) Residential Rebuilding Model Contract. Homeowners are encouraged to review all four documents prior to entering into a contractual agreement. The model contract can be used as is or modified to meet the homeowner's particular needs. [Download the contract](#) (Requires Acrobat Reader).

## **Executive Order Allows Contractors to Repair Roofs**

At the urging of Florida's construction-related trade organizations, Governor Jeb Bush recently loosened state license requirements for building contractors making it easier for homeowners to find workers to repair roofs damaged by Hurricane Charley. Bush issued [Executive Order 04-188](#) giving several types of general contractors' authority to repair roofs themselves instead of hiring licensed roof specialists. Hurricane Charley's strong winds and falling trees damaged thousands of roofs across Florida, creating strong demand for the limited supply of contractors to fix them. The order allows Florida licensed residential, building, and general contractors to perform roofing repairs and re-roofing in the following nine counties: Charlotte, Lee, Desoto, Hardee, Polk, Osceola, Orange, Seminole and Volusia. Roofing must be performed by the contractor's employees, or subcontracted to a properly licensed roofing contractor. The order does not include metal or tile roofing, this must still be performed by licensed roofing contractors. Additionally, unlicensed out of state contractors are not permitted to contract per this order. Out of state contractors must either be an employee of the contractor, or obtain Florida licensure.

## What's New



[Disaster Contractors Network](#)

[New Online Training](#)

[Model Contracts](#)

[What Has FHBA Done For You Lately?](#)

[Right to Cure Law: Special Report](#)

[SB1226 Construction Defects](#)

[Mold Contract Language](#)

**IBHS Provides Charley Activity Updates Online**

The nonprofit Institute for Business & Home Safety (IBHS) is providing continuous Hurricane Charley Activity Updates. Log onto [www.ibhs.org](http://www.ibhs.org) to review the latest Updates which include engineering field reports and photos from communities ravished by Hurricane Charley. IBHS's mission is to reduce deaths, injuries, property damage, economic losses and human suffering caused by natural disasters.

**Flagler's debi Peterson Wins National EO Honor**

Executive Officer **debi Peterson** of the **Flagler-Palm Coast HBA** has been honored by the National Association of Home Builders (NAHB) Executive Officers' Council with the **David G. Lloyd Award** as the nation's **Best EO** with under three years experience. Peterson, who brought a wealth of new ideas and energy to her EO assignment at Flagler, was recognized during a black-tie dinner during last week's NAHB EO Seminar in Sandestin. Peterson, recently elected by her peers to serve as Chair of the Florida EOC Council in 2004-2005, has created a number of member services, including a guidebook to local permitting and a twice-a-year membership directory while greatly enhancing the financial performance of the annual Parade of Homes. Two Florida EOs – **Toni Pacelli-Hinkley** of the **BA of South Florida** and **Paul Thompson, CAE**, of **FHBA** – were triple award winners in the NAHB EOC's **Association Executive Achievement (AEA) Awards**. FHBA was honored for its superintendent training program, workers' comp exemption-holder road map, and 2003 leadership directory. **Franck Kaiser** of the **HBCA of Brevard** and Chair of the Florida EOC welcomed over 250 EOs from around the nation to the event with a special beach-bag gift while the BIA of Okaloosa-Walton Counties and Executive Officer Malcolm Patterson served as the conference hosts.



*The Official Online Weekly Newsletter of the Florida Home Builders Association*  
**AUGUST 30, 2004**

- ÿ President's Message
- ÿ Florida Workers Comp Rates to Fall 2.3 Percent
- ÿ Executive Order Allows Contractors to Repair Roofs
- ÿ FHBA Releases Consumer-Based Emergency Rebuild Model Contract
- ÿ Calls to Lift Cement Tariff Intensify in Wake of Charley
- ÿ Members Helping Members Relief Effort Update
- ÿ Hurricane Building Failure Causes Under Review
- ÿ Roofing Tiles Shred Homes During Hurricane
- ÿ DBPR Extends License Renewal for Contractors
- ÿ Steel-Framing Holds its Own in High Wind Events
- ÿ Important Disaster Contact Information
- ÿ Flagler's debi Peterson Wins National EO Honor
- ÿ Calendar of Events

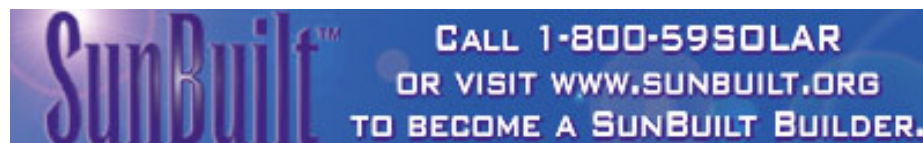

**Get Involved**

**FHBA Member Opportunities to Shape Florida's Future**

**FHBA Foundation**  
**FHB-PAC**



**God Bless America**

**BuilderBooks.com**

**Books to Build On**

**Building Code News**

**Code Changes for 2003 Recap**

**Code Declaratory Statements**

**IEBC 2003**

**Building Code Articles**

**Discussion Board**

**Frequently Asked Questions (FAQ)**

**FHBA Business Partners**





**Maximize Your Potential at New Home Sales Boot Camp**

**Bob Schultz** and **The New Home Specialists** are offering two extraordinary educational opportunities for new home sales professionals that will give you the knowledge, attitude, skills and habits to be successful. **Serious Sales Management** and **The New Home Sales Boot Camp** seminars will be offered at the Delray Beach Marriott, Delray Beach, Florida on **November 12-13, 2004** and **November 16-18, 2004**, respectively. Schultz is a nationally renowned expert in new home sales. Joining Schultz at Boot Camp are the dynamic **Nicki Joy** and **Roland Nairnsey**. **FHBA members get \$100 off each registration.** [View more information.](#)

**FHBA Honors Three with Eagle Awards**

FHBA President Mike Hickman presented three Eagle Awards last week to members who have made unique contributions to the work of the state association. Eagles went to FHBA past president **Barbara Revels** of Flagler Beach, Governmental Affairs Committee Chair **Dave Carter** of Winter Haven, and FHBA Foundation trustee **Bill Paul** of Tampa. Hickman presented the honors during the FHBA Board of Directors meeting at the Summer Builders Conference in Orlando. Revels served with distinction as FHBA President in 2001 and is currently running for the Florida House of Representatives in District 20. Carter has done yeoman's work on numerous governmental affairs issues and currently chairs the FHBA Impact Fee Task Force. Paul has been instrumental in the growth of the FHBA Foundation and the creation of the Future Builders of America program, all while serving as a trustee of the national Home Builders Institute.



*Revels*



*Carter*



**FHBI Addressing Industry Challenges**

The Florida Home Builders Insurance Agency continues to work hard to meet the insurance needs of all FHBA members. For an index of coverages – and a weekly update of developments related to workers' compensation coverage – go to [www.fhbia.com](http://www.fhbia.com).

**Help Your Industry by Giving to FHBA Foundation**



You can shape the future of the home building industry today and for years to come by making a tax-deductible donation to the Florida Home Builders Association Foundation. Generous donors are making it possible to provide financial assistance to young people pursuing careers in the construction trades. They may become your next employee . . . or perhaps more importantly, the type of builder or associate that can carry on the tradition of excellence you have worked so hard to create. [Please, contribute today](#)

Voted  
Best State  
Association  
Website by  
National  
Association of Home  
Builders



**FHBA  
Events**

**Oct 14-16, 2004  
Annual Fall  
Conference**  
Hilton Garden Inn  
Pensacola, FL

**April 3-5, 2005  
Spring Legislative  
Conference**  
Doubletree Hotel  
Tallahassee, FL

**July 14-16, 2005  
SEBC**  
Orange County  
Convention Center  
Orlando, FL  
For information:  
800-895-7322  
[www.sebcshow.net](http://www.sebcshow.net)

**Oct 12-15, 2005  
Annual Fall  
Conference**  
Boca Raton  
Resort & Club  
Boca Raton, FL

### Let Your Voice Be Heard – Contribute to the FHB-PAC



Tired of the regulations that burdens our industry?  
Tired of being blamed for the "problems" of growth?  
If you are, the answer is to elect pro-business,  
pro-housing legislators to the Florida Legislature.  
And the best way to achieve that goal is to  
contribute to FHBA's Political Action Committee . . .  
FHB-PAC. Your dollars will help assure that our  
industry's voice is heard by lawmakers who know  
and understand the importance of housing and the  
home building industry. [Please, contribute today](#)



If you do not see the banner ads above  
or have a problem viewing frames and  
java, update your browser to a higher  
version of Netscape or Microsoft Internet Explorer.



---

**Florida Home Builders Association**  
P.O. Box 1259  
Tallahassee, FL 32302  
PH: 850-224-4316  
FAX: 850-224-1359



ENERGY STAR®

SEARCH

THE QUALITY OF OUR ENVIRONMENT  
IS EVERYONE'S RESPONSIBILITY

| PRODUCTS                                                                                                                                                  | HOME IMPROVEMENT                                                                                                                         | NEW HOMES                                                                                                     | BUSINESS IMPROVEMENT                                                                                                                                                                                                | PARTNER RESOURCES                                                                                                                                                                                                                                                                                                                             | + WHAT IS ENERGY STAR?<br>+ NEWS ROOM |
|-----------------------------------------------------------------------------------------------------------------------------------------------------------|------------------------------------------------------------------------------------------------------------------------------------------|---------------------------------------------------------------------------------------------------------------|---------------------------------------------------------------------------------------------------------------------------------------------------------------------------------------------------------------------|-----------------------------------------------------------------------------------------------------------------------------------------------------------------------------------------------------------------------------------------------------------------------------------------------------------------------------------------------|---------------------------------------|
| <a href="#">Appliances, Lighting, Heating and Cooling &amp; more</a><br><a href="#">Find a Store</a><br><a href="#">Special Offers</a> in certain regions | <a href="#">Solutions to common problems</a><br><a href="#">Home Energy Analysis</a><br><a href="#">Home Sealing Seal &amp; Insulate</a> | <a href="#">Make your next home ENERGY STAR</a><br><a href="#">Find Local Homebuilders and other partners</a> | <a href="#">Reduce building and facility energy use in your organization</a><br><a href="#">Guidelines for Energy Management</a><br><a href="#">Find Labeled Buildings</a><br><a href="#">Education &amp; Gov't</a> | <a href="#">Join ENERGY STAR Who Has Joined?</a><br><a href="#">For Manufacturers &amp; Retailers</a><br><a href="#">For Utilities/Efficiency Program Sponsors</a><br><a href="#">For Home Builders, Lenders, Raters</a><br><a href="#">For Energy Service &amp; Product Providers</a><br><a href="#">New ENERGY STAR Identity Guidelines</a> |                                       |
|                                                                           |                                                                                                                                          | <a href="#">5 Steps You Can Take To Reduce Air Pollution</a>                                                  |                                                                                                                                                                                                                     |                                                                                                                                                                                                                                                                                                                                               |                                       |

**WHAT'S NEW?**

- + [New Campaign Encourages Consumers to Take 5 Steps at Home](#)
- + [Room Air Cleaners Now Can Earn the ENERGY STAR](#)
- + [2005 ENERGY STAR Award Applications Now Available](#)
- + [Beat the Heat and Lower Your Energy Bills This Summer](#)

ENERGY STAR is a government-backed program helping businesses and individuals protect the environment through superior energy efficiency.

[EPA Home](#)  
[EPA Search](#)

[DOE Home](#)  
[DOE Search](#)
[Privacy](#) | [Contact Us](#) | [Site Index](#)
[ENERGY STAR Home](#) | [Products](#) | [Home Improvement](#)
[New Homes](#) | [Business Improvement](#) | [Partner Resources](#)









# AMERICAN INGENUITY

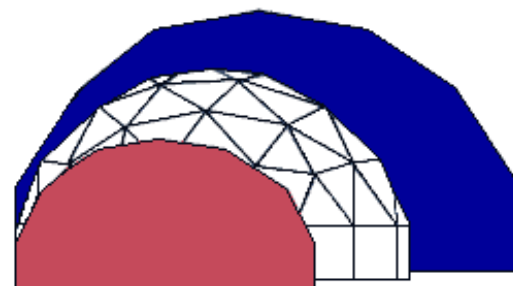

CREATING INTELLIGENT ALTERNATIVES

## Dome Home Views

[click on a thumbnail to see an enlarged image](#)



**Melbourne, Florida**

**first floor view**

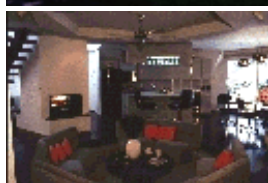

**interior view of above**

**mountainside dome home  
in Arkansas**



**our office complex**

**modern 2nd floor bedroom  
with private loft**

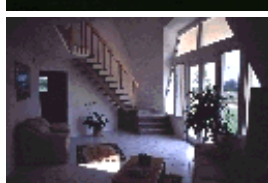

**interior view of our  
offices**

**modern kitchen**



**View from 1st floor  
through 2nd floor to loft**

**inside screen dome looking  
up to 2nd floor balcony**







**aerial view of a three  
dome cluster**

**placing a panel into position**



[Main](#)  
[Dome Pictures](#) | [Floor Plans](#)  
[Planning Kit / Video / Model Dome Kit](#)  
[Mail](#) | [Dome Prices](#) | [Specifications](#) | [FAQ](#) | [Maps](#)  
[Construction Cost Estimates](#)  
[Dome Home Financing](#) | [Dome Construction](#) | [Links](#)  
[The GEO POD - Utility Dome](#)

## AMERICAN INGENUITY, INC.

8777 Holiday Springs Road, Rockledge, Florida 32955-5805

PHONE: 321-639-8777 FAX: 321-639-8778

WEB: <http://www.aidomes.com> EMAIL: [info@aidomes.com](mailto:info@aidomes.com)

© Copyright 2002 [American Ingenuity Domes](#)

[modular geodesic dome](#)



# AMERICAN INGENUITY

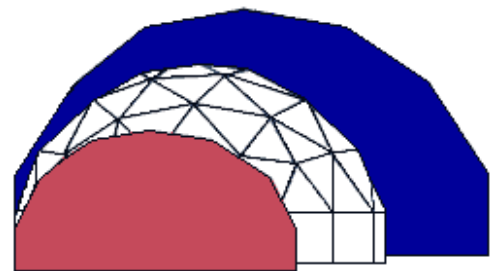

CREATING INTELLIGENT ALTERNATIVES

## Dome Floor Plans

Ready-made floor plans available!

Our building plans contain the complete architectural drawings and details required by building departments. Your floor plan choices are unlimited. You can choose one of our stock plans, modify one of our stock plans, or go with an entirely custom design.

[Order our Planning Kit, which includes our 60-page Stock Floor Plans booklet.](#)

### Floor Plan Examples

Click on a thumbnail to see an enlargement. You may also look at DXF drawings if you have CAD on your PC.

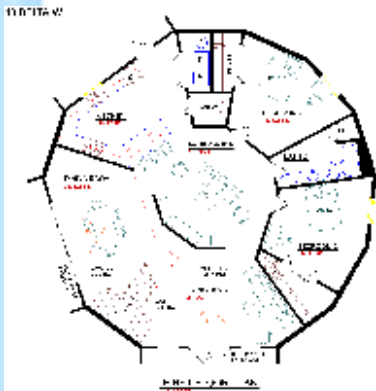

#### 48' DELTA

2,569 square feet  
3 Bedrooms, 2 Baths  
Big Kitchen opens into the Family Room  
Sliding glass doors and skylights grace the vaulted Dining Room  
Skylight over double French doors highlight the vaulted Living Room  
Master Bedroom Suite with balcony, study, walk-in closet, and large bath

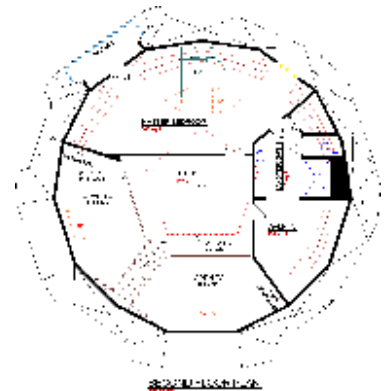

Complete Floor Plan [48DELTA22.dxf](#)

Basic Floor Plan (no interior walls)  
[BASIC48.dxf](#)

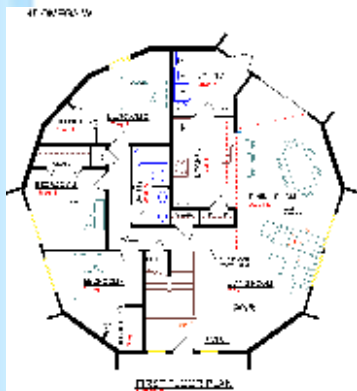

#### 45' OMEGA

2,165 square feet  
4 Bedrooms, 2 Baths  
Vaulted ceiling in Living Room with an overlooking Loft  
Entry with skylight over the stairs  
Large Kitchen with pantry combines with the family sized Dining Room  
Sensible Laundry/Mud Room  
Lots of Closets

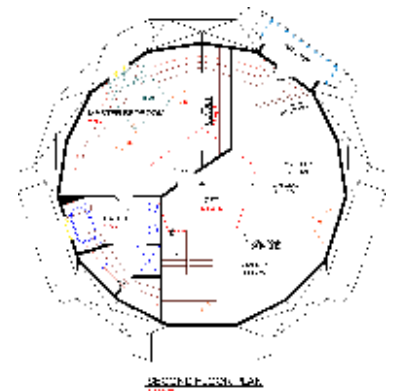

Complete Floor Plan [45OMEGA22.dxf](#)

Basic Floor Plan (no interior walls)  
[BASIC45.dxf](#)

### 34' Zeta

1,218 square feet and optional basement of 825 square feet  
 2 Bedrooms, 2 Baths  
 Open Kitchen with breakfast bar  
 Large upstairs Bedroom overlooks the Living Room & has its own walk-in closet & full bath  
 Vaulted ceiling in Living Room & Dining Room  
 Optional Basement can serve as separate Apartment

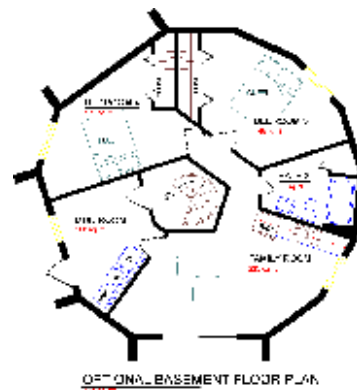
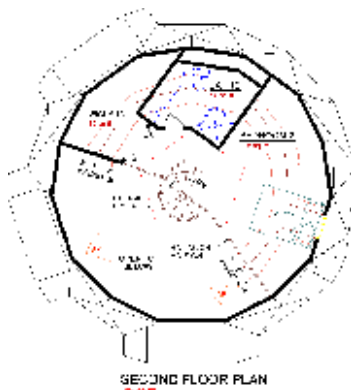
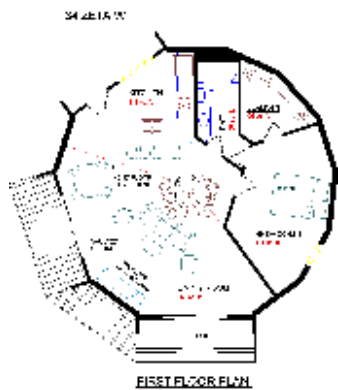

Complete Floor Plan [34ZETA21.dxf](#)

Basic Floor Plan (no interior walls)  
[BASIC34.dxf](#)

30 ALPHA W



### 30' ALPHA

931 square feet  
 1 Bedroom, 1 Bath  
 Economical design  
 Loft with giant closet for weekend guests  
 Big Kitchen with Laundry room behind closet doors

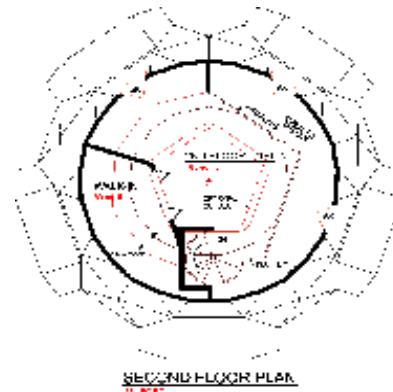

Complete Floor Plan [30ALPHA11.dxf](#)

Basic Floor Plan (no interior walls)  
[BASIC30.dxf](#)

27 ALPHA W

### 27 ALPHA

852 square feet  
 Affordable  
 First Home or Get-a-Way  
 1 Bedroom, 1 Bath  
 Kitchen opens into the Living/Dining area  
 Large second floor bedroom

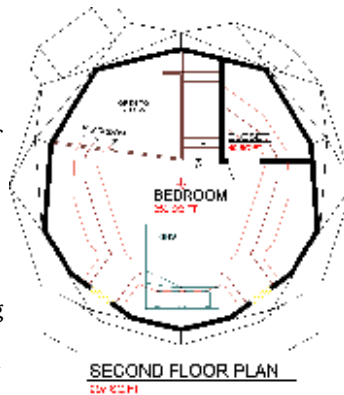

Complete Floor Plan [27Alpha11.dxf](#)



### 45 DELTA and 34 GAMMA

2,417 square feet and optional Garage of 1,305 square feet  
3 Bedrooms, 2½ Baths  
Vaulted Ceiling in enormous Great Room  
Large eat-in Kitchen  
Secluded Game Room over Garage

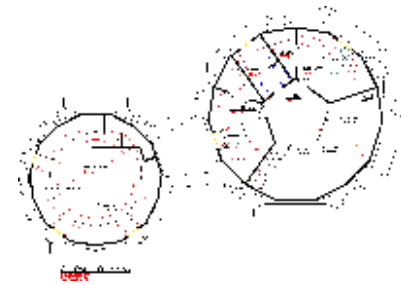

Complete Floor Plan  
[45DELTA\\_34GAMM22.dxf](#)

Basic Floor Plan (no interior walls) [BASIC45.dxf](#) &  
[BASIC34.dxf](#)

### 40' OMICRON

1,787 square feet and optional basement  
Garage of 1,142 square feet  
3 Bedrooms, 2 Baths  
Vaulted ceiling Living Room opening to  
upstairs Study  
Efficient Kitchen shares view with Dining  
Room  
Upstairs Master Suite includes balcony  
Perfect for sloping lot

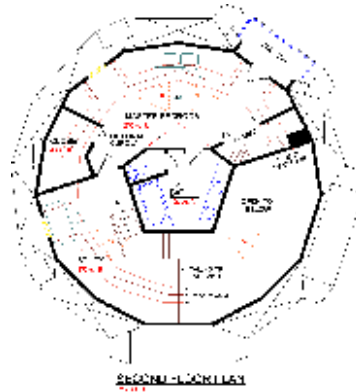
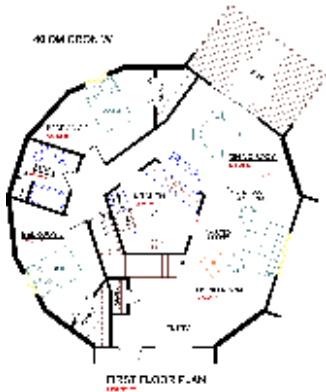

Complete Floor Plan [40OMICRON22.dxf](#)

Basic Floor Plan (no interior walls)  
[BASIC40.dxf](#)

Download a demo version of [Delta Cad](#) and utilize the DXF files.

- [Main](#)
- [Dome Pictures](#) | [Floor Plans](#)
- [Planning Kit / Video / Model Dome Kit](#)
- [Mail](#) | [Dome Prices](#) | [Specifications](#) | [FAQ](#) | [Maps](#)
- [Construction Cost Estimates](#)
- [Dome Home Financing](#) | [Dome Construction](#) | [Links](#)
- [The GEO POD - Utility Dome](#)

## AMERICAN INGENUITY, INC.

8777 Holiday Springs Road, Rockledge, Florida 32955-5805

PHONE: 321-639-8777 FAX: 321-639-8778

Since 1976

WEB: <http://www.aidomes.com> EMAIL: [info@aidomes.com](mailto:info@aidomes.com)

© Copyright 2002 [American Ingenuity Domes](#)  
[modular geodesic dome](#)



# AMERICAN INGENUITY

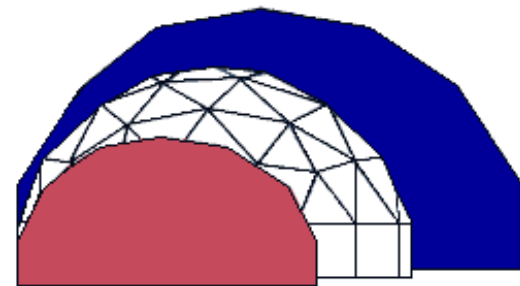

CREATING INTELLIGENT ALTERNATIVES

## Planning Kit - Video - Model Dome Kit

Research and discover the American Ingenuity concept of dome living.

### PLANNING KIT - \$9.00

The Planning Kit includes:

**NEW PERSPECTIVES IN LIVING** a 12 PAGE COLOR BROCHURE

Learn about American Ingenuity advantages, our lifetime structural guarantee, panel composition, kit contents, options, and assembly, and design plans and possibilities. - 40 color photos - 4 drawings - 8½" x 11"

**STOCK FLOOR PLAN BOOKLET** 60+ PAGES

Consider dozens of stock floor plans for our 22', 27', 30', 34', 40', 45', and 48' domes (there are no stock plans for 60' domes). Our stock plans include dome homes with anywhere from one to five bedrooms and 373 to 3,538 square feet, and they incorporate such features as balconies, lofts, skylights, and cupolas. The booklet also includes one and two car garage plans and blank Floor Planners and a scale ruler to aid in designing your own dome. - 11" x 8½" paperback

**PLUS:** Window & Door Specifications sheet - Construction Costs Estimate sheet - North Carolina mountains rental dome brochure - Florida vacation info - Mini dome paper model - Our current newsletter - Popular Science article reprint - **and some other stuff!**

[Order Online Now!](#)

---

### VIDEO: THE HOME OF THE FUTURE - TODAY - \$6.00

Tour dozens of American Ingenuity domes to help you visualize your new home. - Various settings across the country, from the desert to the mountains to the seashore - Learn about advantages, manufacturing, design possibilities, assembly, options, and interior finish - 21 minutes plus Inside Edition segment.

[Order Online Now!](#)

---

### MODEL DOME KIT - \$27.00

Put into perspective the actual living space inside an American Ingenuity dome by constructing a 3-D scale model of your dream home just the way you envision it. When assembled, the plastic ribs and hubs form a representational, see-through, geodesic skeleton. Foam board provided for walls, floors, entryways, and dormers requires cutting and

fitting. Scaled, 2-D furniture is included for each size dome. 24" diameter x 15" high when assembled.

[Order Online Now!](#)



The building of the model dome kit begins with the construction of the rib system.

Next, the foam core board is cut and installed to form the walls and dormers. The window and door treatments illustrated above are not included.



We accept American Express, Discover, Mastercard, and Visa Credit cards.  
(We share NO information with any other firms)

FLORIDA RESIDENTS ONLY ADD 6% SALES TAX

Shipping within the U.S. - \$3.00 regardless of quantity.  
All orders must be prepaid.

Online ordering for US destinations only. All others please call 321-639-8777.

To pay by mail, send check or money order to address below.

[Main](#)  
[Dome Pictures](#) | [Floor Plans](#)  
[Planning Kit / Video / Model Dome Kit](#)  
[Mail](#) | [Dome Prices](#) | [Specifications](#) | [FAQ](#) | [Maps](#)  
[Construction Cost Estimates](#)  
[Dome Home Financing](#) | [Dome Construction](#) | [Links](#)

[The GEO POD - Utility Dome](#)

---

## AMERICAN INGENUITY, INC.

8777 Holiday Springs Road, Rockledge, Florida 32955-5805

PHONE: 321-639-8777 FAX: 321-639-8778

Since 1976

WEB: <http://www.aidomes.com> EMAIL: [info@aidomes.com](mailto:info@aidomes.com)

© Copyright 2002 [American Ingenuity Domes](#)  
[modular geodesic dome](#)





# AMERICAN INGENUITY

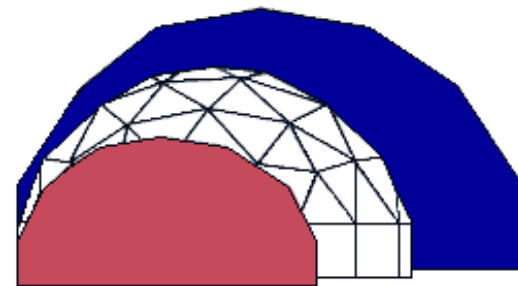

CREATING INTELLIGENT ALTERNATIVES

## DOMES KIT PRICES

**DOMES BUILDING KIT:** Consists of all the triangular and riser component panels for the dome shell and one panel for one entryway. Each component panel has 7" R-28 insulation and a steel reinforced concrete exterior surface (22' dome has 3½" insulation).

**New for 2004!** All triangular and riser panels now include Georgia Pacific 1/4" Dens-Deck wallboard on the interior surface.

| Dome Diameter        | 22'     | 27'      | 30'      | 34'      | 40'      | 45'      | 48'      | 60'      |
|----------------------|---------|----------|----------|----------|----------|----------|----------|----------|
| Living Area Sq. Feet | 373     | 780      | 1,089    | 1,466    | 2,176    | 2,758    | 3,141    | 5,180    |
| Kit Prices           | \$8,360 | \$11,533 | \$14,211 | \$17,046 | \$21,329 | \$25,696 | \$29,665 | \$43,346 |

**BUILDING KIT OPTIONS:** Options are determined by your choice of floor plan; therefore, they are priced separately. Entryways are available as standard, high profile, and garage. 22' and 27' domes can have garage entryways only. Entryway panels have 3½" EPS and are concreted on the interior side. Dormer panels have 3½" EPS wrapped in steel mesh. Both entryway and dormer panels require on-site stuccoing. 22' and 30' domes can have window dormers only on the first floor. Skylights do not open and are installed inside of triangular component panels. There is no charge for a standard link when two domes are purchased. Link panels utilize 7" E.P.S. and are not concreted or wrapped in steel mesh.

| Dome Diameter                 | 22'   | 27'   | 30'   | 34'     | 40'     | 45'     | 48'     | 60'     |
|-------------------------------|-------|-------|-------|---------|---------|---------|---------|---------|
| Entryway (standard or garage) | \$235 | \$255 | \$275 | \$295   | \$315   | \$335   | \$355   | \$465   |
| Entryway (High Profile)       | NA    | NA    | 295   | 325     | 395     | 425     | 455     | NA      |
| Cupola                        | NA    | NA    | \$315 | \$325   | \$335   | \$345   | \$355   | \$375   |
| Window Dormer                 | \$245 | \$245 | \$245 | \$245   | \$245   | \$245   | \$245   | \$295   |
| 1st Floor Door Dormer         | \$265 | \$275 | \$275 | \$275   | \$285   | \$295   | \$295   | \$350   |
| 2nd Floor Door Dormer         | NA    | NA    | NA    | \$275   | \$285   | \$295   | \$295   | NA      |
| Clear Skylight                | \$255 | \$295 | \$255 | \$295   | \$295   | \$295   | \$295   | \$295   |
| Reflective or Low-E Skylight  | \$280 | \$325 | \$280 | \$325   | \$325   | \$325   | \$325   | \$325   |
| 9" R-36 Insulation            | \$600 | \$567 | \$794 | \$1,021 | \$1,305 | \$1,588 | \$1,815 | \$2,495 |
|                               |       |       |       |         |         |         |         |         |

**American Ingenuity Domes are designed with a flexibility that will allow you to create your own personal home. The walls, doors, and windows within entryways & dormers are designed by you and built with your own locally purchased materials.**

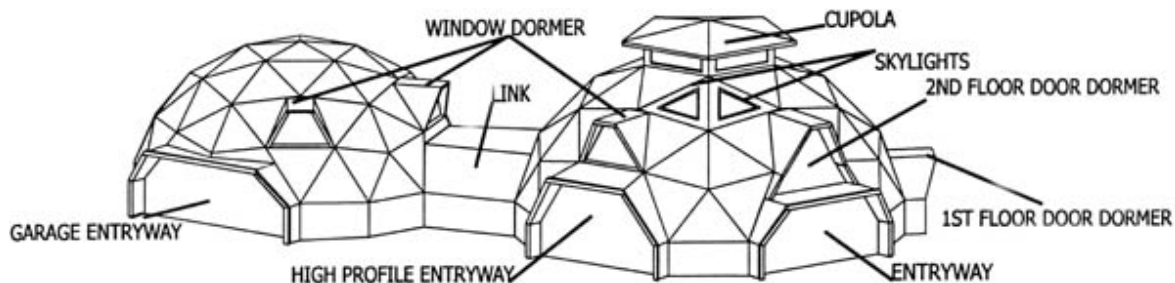

|                      |         |         |         |         |         |
|----------------------|---------|---------|---------|---------|---------|
| Screen Dome Diameter | 22'     | 27'     | 30'     | 34'     | 40'     |
| Kit Prices           | \$2,650 | \$2,977 | \$3,213 | \$3,542 | \$3,949 |

**Bronze or white aluminum 2"X2" frame - Gray or charcoal screening and mounting spline - Two 36" screen door and dormers**

**Assemble the aluminum hubs and ribs and install the screening on the ground in rows, lifting the framework as you go. Additional info available.**

**PAYMENT** Building Kit & Screen Dome Kit orders require a 30% deposit. The balance, in the form of a cashier's check, is due 1 week prior to shipment. Florida residents add 6% sales tax. No credit card charges.

**SHIPPING** Freight is approximately \$1.20 per mile (\$450 minimum) per flatbed truck, from our plant in Rockledge, Florida. One truck can carry one 30', 34', 40', 45', or 48' kit, or two 27' kits, or three 22' kits. A 60' kit requires two trucks. Shipping arrangements can be made by us.

**DELIVERY** Shipping is scheduled at your convenience after receipt of final payment. Allow twelve weeks in summer and eight in winter.

### BUILDING PLANS (3 SETS)

| Dome Diameter       | 22' or 27' | 30'   | 34'   | 40'   | 45'   | 48'   | 60'     |
|---------------------|------------|-------|-------|-------|-------|-------|---------|
| Stock Plans         | \$330      | \$345 | \$365 | \$375 | \$400 | \$420 | N/A     |
| Modified Plans From | \$385      | \$410 | \$430 | \$455 | \$480 | \$500 | N/A     |
| Custom Plans From   | \$455      | \$510 | \$560 | \$615 | \$670 | \$720 | \$1,120 |
| Basment Plans From  | \$170      | \$190 | \$210 | \$230 | \$250 | \$280 | \$375   |

Plan sets contain all blueprints typically provided with any type of housing and include floor plans, exterior elevations, dome shell section view, top view showing panel placement, floor joist framing plans, structural details, and locations of plumbing and electrical fixtures.

Designs utilizing steel joists and studs are available for an additional \$30 per floor.

Stock plans utilize a concrete slab foundation. For raised wood floor designs, call for a quote.

Building plans may be purchased with Master Card, Visa, American Express, Discover, check, or money orders. Plans are shipped UPS ground free of charge. Stock plans are shipped in 1-2 weeks. Allow at least three weeks for modified plans and six weeks for custom plans.

**XE.COM Universal Currency Converter™**

Convert this amount of this type of currency into this type of currency.  
enter any amount  
scroll down to see more currencies scroll down to see more currencies

Universal Currency Converter service and trade mark under license from [xe.com](http://xe.com). [Terms of Use](#)

[Main](#)  
[Dome Pictures](#) | [Floor Plans](#)  
[Planning Kit / Video / Model Dome Kit](#)  
[Mail](#) | [Dome Prices](#) | [Specifications](#) | [FAQ](#) | [Maps](#)  
[Construction Cost Estimates](#)  
[Dome Home Financing](#) | [Dome Construction](#) | [Links](#)  
[The GEO POD - Utility Dome](#)

## AMERICAN INGENUITY, INC.

8777 Holiday Springs Road, Rockledge, Florida 32955-5805

PHONE: 321-639-8777 FAX: 321-639-8778

Since 1976

WEB: <http://www.aidomes.com> EMAIL: [info@aidomes.com](mailto:info@aidomes.com)

© Copyright 2002 [American Ingenuity Domes](#)  
[modular geodesic dome](#)



# AMERICAN INGENUITY

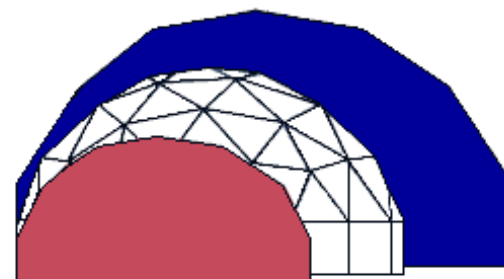

CREATING INTELLIGENT ALTERNATIVES

## SPECIFICATIONS

| Dome Diameters | 22' | 27' | 30' | 34' | 40' | 45' | 48' | 60' |
|----------------|-----|-----|-----|-----|-----|-----|-----|-----|
|----------------|-----|-----|-----|-----|-----|-----|-----|-----|

### AREA AND VOLUME:

|                          |       |       |       |        |        |        |        |        |
|--------------------------|-------|-------|-------|--------|--------|--------|--------|--------|
| 1st Floor (sq ft)        | 373   | 555   | 665   | 852    | 1,178  | 1,489  | 1,693  | 2,552  |
| 2nd Floor (max)          | N/A   | 225   | 424   | 614    | 886    | 1,127  | 1,278  | 1,190  |
| 3rd Floor Loft (sq ft)   | N/A   | N/A   | N/A   | N/A    | 112    | 142    | 170    | 620    |
| Maximum Area (sq ft)     | 373   | 780   | 1,089 | 1,466  | 2,176  | 2,758  | 3,141  | 5,180  |
| Exterior Surface (sq ft) | 1,036 | 1,484 | 1,611 | 1,994  | 2,645  | 3,255  | 3,652  | 4,898  |
| Interior Volume (cu ft)  | 4,279 | 7,312 | 7,997 | 11,172 | 17,330 | 23,901 | 28,540 | 45,210 |

### HEIGHTS:

|                            |       |       |       |        |        |        |        |       |
|----------------------------|-------|-------|-------|--------|--------|--------|--------|-------|
| A: Exterior w/out Cupola   | 15'7" | 18'3" | 17'   | 18'8"  | 21'2"  | 23'2"  | 24'5"  | 26'8" |
| B: Exterior w/Cupola (max) | N/A   | N/A   | 19'8" | 21'4"  | 23'10" | 25'10" | 27'1"  | 29'8" |
| C: Inside Radius to Points | 11'   | 13'6" | 15'   | 17'    | 20'    | 22'6"  | 24'    | 26'   |
| D: Inside without Cupola   | 15'3" | 17'4" | 16'4" | 17'11" | 20'5"  | 22'6"  | 23'9"  | 26'   |
| E: Inside with Cupola      | N/A   | N/A   | 18'6" | 20'1"  | 22'7"  | 24'8"  | 25'11" | 28'6" |
| F: 1st Floor Ceiling       | 7'6"  | 7'6"  | 7'6"  | 7'6"   | 8'     | 8'     | 8'     | 8'    |
| G: 2nd Floor Ceiling (max) | N/A   | 9'1"  | 8'4"  | 9'9"   | 11'7"  | 13'7"  | 14'10" | 17'1" |
| H: Ceiling Under Loft      | N/A   | N/A   | N/A   | N/A    | 7'6"   | 8'     | 8'     | 8'    |
| I: 2nd Floor with Cupola   | N/A   | N/A   | 10'3" | 11'11" | 13'9"  | 15'9"  | 17'    | 19'7" |
| J: 2nd Floor Knee Wall     | 2'    | 2'    | 2'    | 2'     | 2'     | 2'10"  | 3'4"   | 3'    |
| K: 3rd Floor Loft Ceiling  | N/A   | N/A   | N/A   | N/A    | 5'6"   | 6'10"  | 8'1"   | 10'5" |
| L: Entryway                | 8'    | 8'    | 8'    | 8'     | 8'     | 8'     | 8'     | 8'    |
| M: High Profile Entryway   | N/A   | N/A   | 8'    | 8'8"   | 9'7"   | 10'5"  | 10'10" | 11'4" |

### WIDTHS:

|                              |       |        |       |       |        |        |       |       |
|------------------------------|-------|--------|-------|-------|--------|--------|-------|-------|
| N: Entryway (bottom)         | N/A   | N/A    | 12'1" | 13'9" | 16'1"  | 18'2"  | 19'4" | 26'6" |
| Garage Entryway (top)        | 14'9" | 21'10" | 17'   | 19'6" | 22'10" | N/A    | N/A   | N/A   |
| O: Entryway (top)            | N/A   | N/A    | 7'4"  | 8'10" | 11'3"  | 13'5"  | 14'9" | 21'5" |
| Garage Entryway (bottom)     | 9'6"  | 16'8"  | 11'9" | 13'8" | N/A    | N/A    | N/A   | N/A   |
| P: High Prof. Entryway (top) | N/A   | N/A    | 7'4"  | 8'1"  | 9'4"   | 10'11" | 11'   | 17'6" |

### PANEL WEIGHTS:

|                  |         |         |        |         |         |         |         |         |
|------------------|---------|---------|--------|---------|---------|---------|---------|---------|
| Triangular (lbs) | 115-135 | 185-220 | 90-110 | 120-150 | 170-205 | 205-265 | 235-300 | 195-290 |
| Riser (lbs)      | 190     | 235     | 170    | 195     | 235     | 260     | 285     | 200-280 |

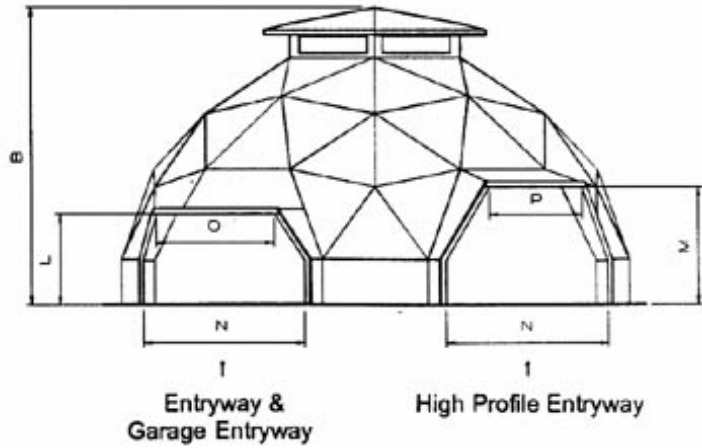
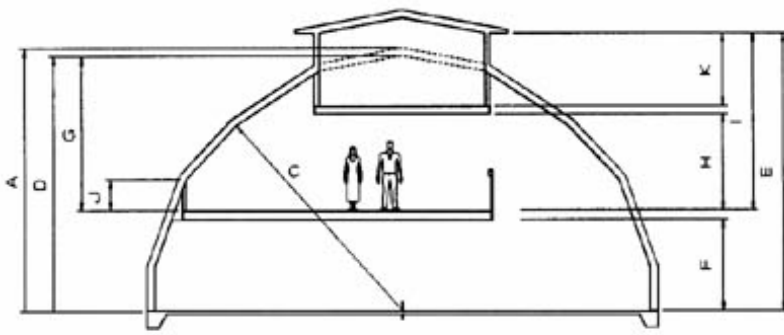

| <b>INSULATION:</b>    | <b>3 1/2" EPS</b>         | <b>7" EPS</b>             | <b>9" EPS</b>             |
|-----------------------|---------------------------|---------------------------|---------------------------|
| Thermal resistance:   | R-14                      | R-28                      | R-36                      |
| Thermal conductivity: | K= 0.0714 BTU/hr/sq ft/°F | K= 0.0357 BTU/hr/sq ft/°F | K= 0.0278 BTU/hr/sq ft/°F |

**DOME GEOMETRY:**

22' and 27' domes are 2-frequency, 1/2 spheres on a 4' vertical riser. 30', 34', 40', 45', and 48' domes are 3-frequency, 3/8 spheres on a 4' vertical riser. 60' domes are 4-frequency, 3/8 spheres on a 4' vertical riser. Frequency is the number of intersections from the center of one pentagon to the next.

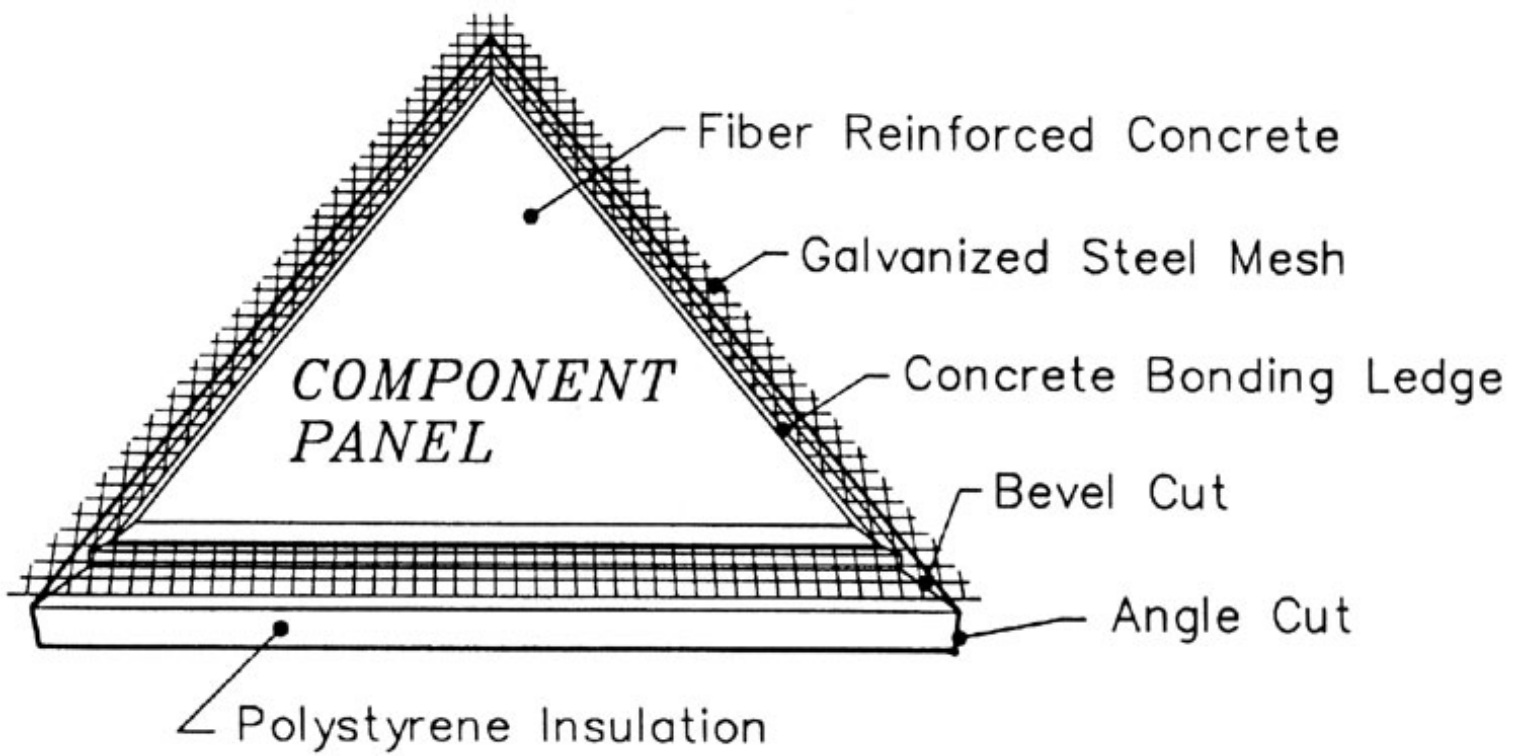

- [Main](#)
- [Dome Pictures](#) | [Floor Plans](#)
- [Planning Kit / Video / Model Dome Kit](#)
- [Mail](#) | [Dome Prices](#) | [Specifications](#) | [FAQ](#) | [Maps](#)
- [Construction Cost Estimates](#)
- [Dome Home Financing](#) | [Dome Construction](#) | [Links](#)
- [The GEO POD - Utility Dome](#)

AMERICAN INGENUITY, INC.

8777 Holiday Springs Road, Rockledge, Florida 32955-5805

PHONE: 321-639-8777 FAX: 321-639-8778

WEB: <http://www.aidomes.com> EMAIL: [info@aidomes.com](mailto:info@aidomes.com)

© Copyright 2002 [American Ingenuity Domes](#)  
[modular geodesic dome](#)



# AMERICAN INGENUITY

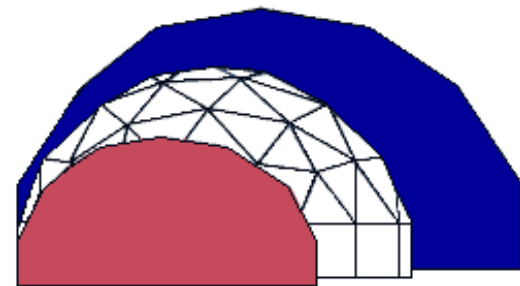

CREATING INTELLIGENT ALTERNATIVES

## ANSWERS TO OUR MOST FREQUENTLY ASKED QUESTIONS

Click on the question to read the answer

### GENERAL

[How long has American Ingenuity been designing and manufacturing domes?](#)

[Can I view an American Ingenuity dome?](#)

[What have some of your dome owners said about their American Ingenuity dome homes?](#)

[Why don't you have an 800 toll free number?](#)

[What does frequency mean in relation to domes?](#)

[What is the largest American Ingenuity dome available?](#)

[What is the shipping cost?](#)

[How does the weight of these domes compare to other houses?](#)

[Are American Ingenuity domes manufactured in any other location?](#)

[Why are the kit prices on the Construction Cost Estimate page different from the kit prices on the Prices page?](#)

[Do you export the concrete dome kits?](#)

[What are the advantages of the dome shape?](#)

[Do you have any pricing comparisons?](#)

[What do the panels weight?](#)

### BUILDING KIT CONTENTS

[What does my American Ingenuity dome kit include?](#)

[What determines the type and number of Building Kit Options I need for my Building Kit?](#)

[Does the Building Kit contain any interior items?](#)

[What is the component panel's composition?](#)

[If I am not ready to assemble my dome, can it sit out outside? If I purchase the kit with the interior board option, can I store the kit outside?](#)

### DESIGN AND BUILDING PLANS

[Where can I build a dome?](#)

[What items should I consider when planning to build my geodesic dome?](#)

[How do we determine what size dome is best for my family?](#)

[What size dome do I build if I do not want a second floor?](#)

[Can the dome be made handicap accessible?](#)

[How do I plan for expansion - the addition of another dome at a later date?](#)

[Do you have separate garage dome kits available?](#)

[Can the domes have basements or be built upon stilts or pilings?](#)

[Can I have windows above doors in an entryway?](#)

[Will I feel closed in, in the dome?](#)

[Will my dome be acceptable to my building department?](#)

[What do the Building Plans contain?](#)

[Do your Building Plans come with an Engineer's seal?](#)

[What format do I email floor plan drawings to you in?](#)

[What programs can I use to read dxf format?](#)

[Can you modify any of the stock plans in the Stock Floor Plan Booklet?](#)

[What all do I consider when putting sketches together for a custom dome floor plan?](#)

[What is a cupola?](#)

[Why do the square footages on the Specifications page differ from the square footages listed on the stock floor plans?](#)

## ASSEMBLY and CONSTRUCTION

[Can I assemble the Dome Kit myself?](#)

[How do I select a builder for my dome?](#)

[What support is used to hold up the component panels until the dome kit is assembled?](#)

[What will it cost per square foot for a completed dome home in my area?](#)

[How long will it take to complete the shell of my dome?](#)

[How long will it take to completely build my dome home?](#)

[What basic items will I need to erect my building kit?](#)

[What type of hoisting mechanism or crane will I need and for how long?](#)

[Can I berm or backfill dirt up around the outside of my dome?](#)

[What kind of vapor barrier will my dome have?](#)

[How will the concrete in my dome withstand the effects of freezing temperatures?](#)

[What do I apply to the interior of the dome shell after I assemble the kit? Can I purchase an interior board on the component panels?](#)

[Are there any special requirements for the foundation?](#)

[How much weight will the second floor support?](#)

[How is the second floor attached to the dome shell?](#)

[Can I use steel studs in my American Ingenuity Dome?](#)

[Can I install conventional doors and windows in the dome exterior? And where are they installed?](#)

[How is the exterior wall within an entryway or dormer built?](#)

[How are the electric and plumbing lines installed in the dome shell?](#)

[How are plumbing vent pipes installed in the wall of the dome shell?](#)

[Can the dome have a fireplace and how is a fireplace installed?](#)

[How are domes connected together?](#)

[What is the Link between the domes made of, etc.?](#)

[What type of paint should I use on the exterior of my dome?](#)

[In most of the photographs the domes are painted white, how can I make the dome exterior more conventional?](#)

[Would you explain briefly what is involved in the assembly of my dome kit?](#)

## ENERGY EFFICIENCY

[What Energy Star rating has the American Ingenuity dome received?](#)

[What do I need to consider when searching for an ENERGY EFFICIENT house?](#)

[How does your insulation R-value compare to other wall R-values?](#)

[Should I be concerned about moisture and dampness?](#)

[Does thermal mass effect energy efficiency?](#)

[Can I use alternative power sources with my American Ingenuity dome?](#)

[Would you give me more information about solar hot water heaters and photovoltaic panels?](#)

[How did the American Ingenuity dome perform in the energy efficiency tests at the Florida Solar Energy Center?](#)

[Which heating and air conditioning system is the most practical and efficient for my location?](#)

[Can a radiant in floor heating system be installed in my dome?](#)

[Why are your dome homes so energy efficient?](#)

## STRENGTH

[When the reporter from Inside Edition visited, what dome advantage did they zero in on?](#)

[What wind, seismic, and snow loads will the dome withstand?](#)

[Have you performed a load test on your panel?](#)

[The panel concrete is not that thick, why is American Ingenuity's dome so strong?](#)

## FINANCING

[What is the resale value of American Ingenuity domes?](#)

[Will it be difficult to get a loan to build my dome?](#)

[Do you sometimes have special pricing? Is there a way to secure lower pricing if I am planning on purchasing in one to five years?](#)



## GENERAL

**Q:** How long has American Ingenuity been designing and manufacturing domes?

**A:** Since 1976, all with the same ownership. We now have more than 450 domes in 44 states, from Maine to Alaska to Hawaii to Florida.

The first American Ingenuity dome was built in 1976 after two years of design research. Founder Michael Busick employed the talents of the Director of the [Florida Solar Energy Center](#), engineering students, and an architectural professor to design the very first foam and concrete geodesic dome.

We built this first dome by propping up the pre-cut insulation panels, hand tying steel mesh to the exterior of the insulation, and spraying concrete over the entire dome exterior. It became our office and model. This early design had no riser walls, pre-formed entryways, or dormers.

Countless designs and construction techniques were analyzed in our early years as we developed a new generation of housing. We also designed our component panel and received a patent on it. These pre-concreted panels produce a better quality dome and eliminate the need for costly concrete pumping equipment.

We have progressed from a prototype structure to a technology that has received three energy awards, a design competition award, exposure on national television and in magazines and other media. We have outgrown two previous office locations as we progressed to our current five dome complex. Our building plans have progressed from simple hand drawings to detailed computer designed blueprints, our assembly manual has grown to more than 80 pages, and we were the first company to offer screen dome, utility dome, and dog dome kits.

**Q:** Can I view an American Ingenuity dome?

**A:** One Saturday each month we offer a tour of our offices and a fully furnished, 34' dome home connected to a 22' dome garage and a 25' screen dome. And at any time, you can informally tour just the office complex, which consists of a 45' dome connected to a 34' dome and a 40' screen dome. Although these domes are offices, not homes, you can still learn a lot and get a good feel for the dome's spaciousness.

Michael and Glenda Busick, the owners of American Ingenuity, are offering their personal 34' vacation dome for rent, so that you may experience dome living first hand. The vacation dome is located in the heart of the Appalachian Mountains, just one mile off the scenic Blue Ridge Parkway and 40 miles northeast of Asheville, North Carolina. Please call our office for details.

**Q:** What have some of your dome owners said about their American Ingenuity dome homes?

**A:** R. Whaley, 34' dome, Florida: "Once the dome is initially heated or cooled, the temperature remains constant. Just think of when you take your soda pop to the beach on the hottest day of the year in an inch of foam. Once the house gets cool or hot as desired, it retains that temperature and stays constant."

The Sparrows, 30' dome, Florida: "We call our home 'Sparrows' Nest'. It may look small from the outside, but there's a lot of room. The house is a rock."

The Drybolas, 45' and 30' domes with 34' screen dome, Florida: "We've had over 200 people stop by and see our dome. Believe me, your product has never been shown off as good! Wish more people by the beaches, who lost everything (in a hurricane) would come by, sure wouldn't have to worry anymore."

From R. Napolitan, Idaho: "The dome is snug and warm. We heat it mostly with a woodstove that's in the basement. Our staircases are open so the heat rises. It stays about 68 degrees without much effort, with our lowest outside temp...5-6 degrees. (2,000+ sq.ft. with basement, 34')

From B. Gates, Illinois: "A pretty neat design, very energy-efficient. I like to keep things environmentally nice. It's almost an organic feeling, being surrounded by curves instead of by rectangles. It seems to be a more relaxing environment to be in." (48')

From D. Partlow, Indiana: "The dome is 'awesome', 'beautiful' and 'breathtaking'. At least that's what visitors say. It is and it's also a very comfortable home to live in. Our June electric bill was \$107, and we are totally electric! We love the house and the great savings on energy!!!" (2,400+ sq.ft.; 48')

From S. Mumphrey, Louisiana: "We're three years in our dome...we still pinch ourselves every morning thinking it's a dream. But it's REAL, and we love it." (45')

From H. Willis, Mississippi: "I like the openness. You can see the kitchen, dining room, living room and bedroom loft when you walk in the front door." (34' with 25' screen dome)

From L. Covington, North Carolina: "Doing everything on my own, not too bad when I think that it will save

me \$25,000 in labor costs for doing everything outside and inside....The folks that ride by are breaking their necks gawking at the dome. A few have stopped for more info and a lot come back from time to time to check the progress." (30')

From K. Millar, South Carolina: "What this house is about is alternatives. Skylights make the house bright and airy. We decorated it with an Oriental theme, even painting the floor with an Asian motif, and we surrounded the house with a Japanese garden." (40')

From J. Holden, Texas: "We just love our four domes, even after 15 years!" (40')

From J. Collar, Utah: "My wife, Mary, devoured articles and books about straw bale, rammed earth, poured adobe, earthships, log, and other unconventional building systems. Finally, Mary announced to me that she had found our house: a precast concrete and styrofoam geodesic dome! As an engineer, I was excited about the sheer practicality. I quickly ran some heat loss calculations and found that at -20 degrees F, we could expect to keep the 2700 sq.ft. of living space at 70 degrees F using little more than 30,000 btuh. With judicious use of a large solar window and a masonry heater fireplace, we could limit our use of propane for backup heating." (45' and 30' Garage dome)

**Q:** Why don't you have an 800 toll free number?

**A:** We do not have an 800 number because we hear from 400 to 600 interested people per month, depending upon the time of the year. If we had an 800 number, our clients that purchase the dome building kit would be paying for everyone else's telephone expenses. Each person who wants to research our kit further can do so by purchasing our Planning Kit and/or video.

**Q:** What does frequency mean in relation to geodesic domes?

**A:** Frequency is simply the number of segments between the centers of pentagons in a geodesic dome. To best visualize this, first note the five panels that make a pentagon at the top of the dome. Starting at the center point, follow any of the seams that radiate from this center to the center of the next pentagon and count the number of intersections. The number of intersections indicates the frequency. A soccer ball exemplifies a three frequency icosahedron. A typical golf ball utilizes dimples in a six frequency design.

Our 22' and 27' domes are two-frequency half-spheres on a 4' vertical riser wall. Our 30', 34', 40', 45' and 48' domes are three-frequency 3/8 spheres on a 4' vertical riser wall. Our 60' dome is a four-frequency, 3/8 sphere on a 4' vertical riser wall.

**Q:** What is the largest American Ingenuity dome available?

**A:** Prompted by requests for a large, single dome for commercial uses, we developed a 60' dome in 1988. Although it can be used to create a grand home of more than 5,000 square feet, we do not recommend first time owner-builders to take on a project of such proportions. A complex of two or more domes offers advantages and may be more practical than a single large dome.

**Q:** What is the shipping cost?

**A:** Having our manufacturing plant located in Florida is advantageous for shipping since more is shipped into than out of the state, leaving many trucks headed out empty. Using an independent trucking agency, we contract to have these trucks carry our building kits for a low cost of approximately \$1.20 per mile with a \$400 minimum. This is less than we could do with our own trucks. Each flatbed truck can carry one large building kit, two 22's or 27's, or possibly two 30' kits. A 60' dome building kit requires two trucks for delivery.

**Q:** How does the weight of these domes compare to other houses?

**A:** Because of the reduced surface area of a dome and its thin shell construction, our domes weigh less than the average house, but are remarkably stronger than other types of structures. Domes are considerably lighter than a concrete block house.

**Q:** Are American Ingenuity domes manufactured in any other location?

**A:** No. Our manufacturing costs here in Florida are well below the national average, which offsets any long distance shipping expense. We can actually manufacture a kit here in Florida and ship it to most states cheaper than we could manufacture it there.

**Q:** Why are the kit prices on the Construction Cost Estimate page different from the kit prices on the Prices page?

**A:** The kit pricing on the Dome Price page includes the dome shell kit plus one entryway. The kit prices on the Construction Cost Estimate page equal the combined pricing of the building kit plus the options based on the floor plans 30' Alpha 11, 34' Delta 11, 40' Alpha 11, 45' Alpha 22 and the 48' Delta 33. For example the 40' Alpha 11 floor plan consists of the 40' kit with one entryway plus the following additional building kit options: one additional entryway, two window dormers, one second floor door dormer and four clear skylights.

**Q:** Do you export the concrete dome kits?

**A:** Yes, to areas such as Puerto Rico, the Caribbean, and Canada. Request for shipment overseas is best handled at the receiving port. We are unable to provide the time required acquiring shipping quotes or arranging for the shipping. Someone at the receiving port would best know which freight lines service your port and would be in a better position to acquire the best pricing. By contacting a freight forwarder at your importing port, they would know the USA port which receives the best service and the most economical ship to use. Also, they can arrange for an inland trucking company to bring the containers to our factory to be loaded. There is an extra fee of \$400 for us to load containers, because we have to rent a telescoping forklift.

**Q:** What are the advantages of the dome shape?

**A:** As a residential building concept, the geodesic dome home translates into a highly comfortable and livable home that has a maximum of floor area enclosed by a minimum of materials. These features combine superior strength and cost-effectiveness in a single structure.

Manufactured dome homes are constructed using a triangular network to form a spherical shape. This method provides for a free-span, self-supporting structure requiring no internal supports such as roof loadbearing partition walls. This allows for maximum flexibility of floor plan design and utilization of interior space.

As an architectural form, the dome is one of the strongest structural forms ever devised. Domes that were built centuries ago enclose many of the great cathedrals of Europe. Domes are structurally superior to rectilinear enclosures. The partial sphere is an aerodynamic shape that is very stable in high winds and can withstand heavy snow loads. For these reasons, residential domes greatly exceed the structural requirements of the major building codes in the United States.

**Q:** Do you have any pricing comparisons?

**A:** When you research other dome kit pricing and contents, generally you will find that our pricing is about 1/3 to 1/2 less, primarily because of the design concept. It is far more practical to build a dome with concrete than wood. Applying the concrete to rigid foam insulation produces a component panel that provides structure, exterior finish, and the insulation. Also, we maintain a lower advertising cost and concentrate more on improving the design than pushing sales. And due to lower labor costs in Florida, we can manufacture in Florida and ship to almost any other location cheaper than it would cost to manufacture there.

Remember to compare apples to apples when pricing each company's kit. Our panel includes the R-28 insulation and most of the exterior finish. In wooden domes you will likely have to purchase the insulation as an added cost and the exterior finish, roofing is certainly an extra cost.

**Q:** What do the panels weigh?

**A:** Depending upon the dome size, the panels weigh between 115 and 300 pounds. If you purchase the optional interior board, the panels will weigh more.

## BUILDING KIT CONTENTS

**Q:** What does my American Ingenuity dome kit include?

**A:** The shell kit package includes triangular panels, 4' high riser panels, entryway panels, galvanized steel mesh, concrete fibers, two concrete admixtures, a reinforcing tension wire, a concrete bonding agent, connecting C-rings, a pair of C-ring pliers, an assembly manual, and an accessory package. Depending upon

which options you select, additional components may include additional entryway panels, window dormer panels, door dormer panels, skylight panels, and cupola panels.

**Q:** What determines the type and number of options I need for my Building Kit?

**A:** Your floor plan selection. On the first floor of our domes, there can be as many as five entryways. On the second floor, there can be as many as five window or door dormers. Our floor plans page displays a few of our stock floor plans, which illustrate different combinations of first floor and second floor options; our Stock Floor Plans booklet contains plans for the 22', 27', 30', 34', 40', 45' and 48' diameter domes.

**Q:** Does the Building Kit contain any interior items?

**A:** No, you purchase the interior items locally. We show furniture within the floor plan to help you visualize a dome home, to allow you to compare the dome room arrangements and room sizes to a conventional house, and to assist you in seeing how conventional furniture will fit within a dome.

Dome interior items are the same as found in a conventional house: framing, plumbing, electrical, doors, windows, flooring, stairs, kitchen cabinets, bathroom fixtures, lighting fixtures, fireplaces, etc.

**Q:** What is the component panel's composition?

**A:** The component panel consists of steel reinforced concrete adhered to rigid expanded polystyrene (EPS) foam insulation. A gypsum and fiberglass wallboard is attached to the interior side of the foam. Each panel is cut at a computer-generated angle so that it fits flush with the adjacent panel. The edges are precisely beveled at the seams where steel mesh and concrete will unite to complete the structure.

The panel concrete is a special formulation containing synthetic fibers and liquid admixtures. We ship these same fibers and admixtures with your building kit so the seam concrete that you mix on site will have the same properties as the panel concrete. The exterior panel concrete, which is 1/2" to 3/4" thick, adheres directly to the steel mesh and EPS insulation without the need of a bonding agent.

A one-inch grid, 16 gauge galvanized steel wire mesh is encased in the concrete of each component panel and extends out over the beveled edges. As your dome panels are assembled, the mesh of each panel overlaps and is hooked to that of the adjacent panels with C-rings. The dome is thus completely encircled by steel mesh.

Except for the 22' dome, which has R-14 insulation, all of our domes have seven inches of sturdy, rigid, R-28 EPS foam insulation forming the core of each component panel. The EPS we use has a density of one pound per cubic foot. The insulation is permanent, chemically and thermally stable, resistant to mildew, non-nutritive to animals, plants, or microorganisms, non-irritating to skin, and chlorofluorocarbon (CFC) and formaldehyde free. Our insulation will not rot, shrink, absorb moisture, compact, or deteriorate due to age or weathering. It also acts as a vapor barrier for your home, providing stable performance year after year.

**Q:** If I am not ready to assemble my dome, can it sit out outside?

**A:** If your kit will be outside for more than a month, or for any length of time in freezing weather, then the panels should be covered in order to eliminate the possibility of freeze-thaw damage. If you expect to have your kit outside for more than two months, request that the edges be painted when you place your order. This will allow you to store it outside for more than a year.

## DESIGN AND BUILDING PLANS

**Q:** Where can I build a dome?

**A:** Almost anywhere. Although, there are a few exceptions. Some developments or communities control the size, cost and appearance of the homes. Before you buy the land ask if there are any restrictions. Zoning ordinances control the use of the land (residential, business, etc.), setbacks from property lines, size, and height limits and similar things, but we have never heard of a zoning restriction on domes. Building departments are basically concerned about safety and structure, not appearance.

**Q:** What items should I consider when planning a time frame for building my geodesic dome?

**A:** We cannot stress enough the importance of starting your preparations early for all aspects of building. What you think may take two months can easily consume four or five months or more.

Some Building Departments require that blueprints be sealed or approved by one of their state architects or engineers prior to giving permits, which takes additional time. Mortgage lenders move slower than you may anticipate. Remember to allow time to have the land cleared, prepped and ready for the foundation. All permits pertaining to electrical, telephone, water, septic tanks, sewer hookups, driveway, and building take time to acquire.

Also, increased demand for American Ingenuity Dome Kits has forced us to assign shipping dates as much as twelve weeks in advance. If you intend to begin building in the summer, start the process before the end of the prior year. Other expectant homeowners will be clogging the system by spring, so if you are the early bird they will be waiting behind you instead of vice versa.

**Q:** How do we determine what size dome is best for my family?

**A:** First, review our Stock Floor Plan Booklet to see how the area within a dome is used. Then compare these sample floor plans with the rooms and square footages of houses you are familiar with. Compare your finances and construction costs to avoid designing a project that is beyond your budget. Think about the future...will you need to increase or decrease?...if you had to move what size home would sell best?

**Q:** What size dome do I build if I do not want a second floor?

**A:** The 27' and 30' domes would be suitable for homes with only a first floor. If you choose to construct a larger dome and include the second floor, you can install an elevator or lift to access the second floor. A lift is less expensive than an elevator.

**Q:** Can the dome be made handicapped accessible?

**A:** Yes, all of the dome floor plans can be modified to be handicapped accessible.

**Q:** How do I plan for expansion - the addition of another dome at a later date?

**A:** When designing your first dome, you can prepare for future expansion by placing an entryway or link at the location where you will later connect another dome. If we are providing you with customized plans we can design them for the future expansion. When you order your first dome, we can provide instructions and materials that will make the connection easier.

**Q:** Do you have separate garage dome kits available?

**A:** Yes. We have developed two new garage dome sizes, 22' and 27'. Their geometry differs from our other domes in that it utilizes fewer, but larger, panels. By having larger panels, we can create the wider opening needed for a garage door. A 9' wide garage door can be installed in a 22' garage dome. The 27' garage dome can have a 16' garage door, and it can have a second floor of 398 square feet. Either of these garage domes can be connected to another dome or built independently.

**Q:** Can the domes have basements or be built upon stilts or pilings?

**A:** Yes. Any of our domes can be built upon a basement, stilts, or pilings. You determine how many openings you want in the basement walls for garage doors, windows, and doors. And you determine if you want the basement sides bermed with dirt. Full basements are the same size and shape as the dome first floor. Our basement plans explain how they are attached to the dome. Basement walls are usually 8" thick when made of poured concrete but will likely increase depending on the height of the basement wall and the height of the backfill.

Bear in mind that building any structure upon stilts or pilings will increase the cost significantly and require you to climb a flight of stairs each time you go in the house.

**Q:** Can I have windows above doors in an entryway?

**A:** Yes. By using a high profile entryway, you can include glass or standard windows over a door, set of doors, or bank of conventional windows. The glass could be semi-circular, stained glass, etc. Any room with a cathedral ceiling, such as a foyer or living room, can benefit from this striking architectural feature.

**Q:** Will the dome make me feel closed in?

**A:** No. In our domes, you can install an abundant number of windows and doors. Your budget and your floor plan selection determine how many you can have. There can be up to five entryways on the first floor and up to five window dormers or door dormers on the second floor.

**Q:** Will my dome be acceptable to my building department?

**A:** Building plans for American Ingenuity domes can comply with all building codes worldwide, including the Universal Building Code, the Standard Building Code, and the B.O.C.A. Code. If required, your plans can be certified by a registered engineering firm. Professional fees will vary by state and complexity of your plan. We suggest you start by asking your building department a few questions such as: What are the requirements for a residential building permit? Are there any additional requirements to build a geodesic dome? Is an architect's or engineer's seal required on the plans?

**Q:** What do the Building Plans contain?

**A:** Building plans include the basic drawings for the dome that are needed when acquiring a building permit. They include a 3D elevation and a 3D perspective view. They also include all the structural drawings and show the placement of the electrical outlets, light fixtures, and plumbing fixtures; however, they do not have the electrical, plumbing, and HVAC layouts. We have found that if these layouts are included, then building inspectors require subcontractors to follow them, while the the subcontractors prefer to do their own layouts.

**Q:** Do your Building Plans come with an Engineer's seal?

**A:** No. Each state only accepts a seal from an engineer that is registered in that state; this prevents us from applying any seal that would be universally accepted. When an engineer seals a set of plans, he is taking responsibility for the structural design for a single dome in the location intended and the seal would not apply to other projects; therefore, it is necessary to seal plans individually as needed.

**Q:** What format can I email floor plan drawings to you in?

**A:** Jpeg, bmp, dxf, or dwg. You can email them if they are in the following format: jpeg format or bmp format (windows bit map). You can also fax drawings to us (321-639-8778). Remember to include your name, telephone number and the best time(s) to contact you.

**Q:** What programs can I use to read dxf format?

**A:** You can read and edit dxf files if you have an autocad program, any other computer-aided drafting program, or a photo editor program such as Adobe or Paint Shop. You can read, but not edit, dxf files using Microsoft Word or Powerpoint. The web site <http://www.deltacad.com> has a computer-aided drafting program that can be downloaded and used for free for 45 days.

**Q:** Can you modify any of the stock plans in the Stock Floor Plan Booklet?

**A:** Yes. While it does incur a charge, it is much less than the expenditure of a complete custom design. Any of the Stock Plans may be modified to provide for structural changes such as:

1. Building a Mirror image
2. Rearranging rooms, moving walls, or adding closets
3. Combining the first floor from one plan with the second floor of another
4. Adding or subtracting entryways, door and window dormers, or balconies
5. Adding bathrooms
6. Adding a full or partial basement
7. Fortifying a floor structure to accommodate special furnishings, such as a waterbed, hot tub, or weight room

We will be happy to quote a price for blueprints and a building kit for your Modified Stock Plan once we review your sketches. Fax your sketch to us at 321-639-8778. Include your name, telephone number, and the best time(s) to contact you, and we will call you back with a quote. Just as in custom plans, you will receive a rough draft. You review the draft, make any changes, and fax it back to us; this process is continued until you approve of a final draft. We then take this final draft and design the structural pages to your Building Plans.

**Q:** What all should I consider when putting sketches together for a custom dome floor plan?

**A:** You might use American Ingenuity's stock designs as a springboard for your own ideas and fashion a special floorplan to accommodate how you and your family live. In the back of the Stock Floor Plan Booklet are scale ruler and scale furniture cut-outs to assist your planning. Keep the following in mind:

- All plans may be built on your choice of foundation, including: concrete slab, raised, stem wall, pier foundation, full or partial basement.
- When planning entryways, door dormers, balconies and window dormers, please note their specific locations on the floor planner located in the back of the Stock Floor Plan Booklet.
- When planning room sizes for your second floor, remember that the headroom decreases as it approaches the knee wall. The floor planner will have the second floor perimeter heights noted.

**Q:** What is a cupola?

**A:** A Cupola is sort of like a hat with windows that sits on top of the dome. When a person wants to have a third floor loft in the 40' or larger domes, the cupola adds about 2' of headroom to the top center of the dome. The top five pentagon panels rest upon 18" tall concrete legs that are built on site. Between the concrete legs, framing is built to install rectangular windows that are purchased locally. See the floor planners in the Stock Floor Plan Booklet for loft heights and square footages.

The topside exterior of the five panels of the cupola and the underside exterior of the eave are prefinished, while the topside and edges of the eave are stuccoed onsite.

Cupolas are not necessary for ventilation or extra light. Domes do not need more light than conventional houses. However, if you build your dome without a cupola, we recommend installing a vent at the peak of your dome for ventilation. The electric fan vent has the added advantage of being easily controlled with a switch or timer.

**Q:** Why do the square footages on the [Specifications Page](#) differ from the square footages listed on the stock floor plans?

**A:** On the Specifications Page, the first and second floor square footages listed are the maximum amount possible. Each time more than one entryway is utilized on the first floor, the first floor area is reduced. The second floor square footage varies from the Specifications Page because some stock plans have 1/3 to 1/2 of the second floor left open. Also, the second floor stock plans area consists of all the space to the knee wall. The knee wall is built along the dome perimeter out of 2x4's and covered with drywall to a height of two to three feet.

## ASSEMBLY and CONSTRUCTION

**Q:** Can I assemble the Dome Kit myself?

**A:** Most of our customers assemble their own dome kit shell themselves, and many of them have no prior construction experience. If you are mechanically inclined and understand the info in the Planning Kit, then you can probably assemble the dome shell. Only one person needs to be familiar with the Building Plans and Assembly Manual, and that person can direct the laborers that assist in lifting the panels and filling the seams with concrete. If you do not have the time or desire to assemble the shell, we can refer you to independent contractors that travel around the country building domes. Or you may want to assemble the shell and fill the seams with one coat of concrete and then hire a concrete professional to add the second coat. You may wish to hire a plasterer or stuccoer to finish the interior if you don't purchase the interior board option. The interior can be completed by plumbers, framers, electricians, etc.

**Q:** How do I select a builder for my dome?

**A:** Whether you are looking for a contractor to handle all the construction of your dome or a sub-contractor to handle only a part, it is best to contact several and choose the one with which you are most comfortable. If you are in Florida, we can refer you to licensed contractors who will build the dome from slab to completed interior.

Also, we know an independent sub-contractor that travels around the country assembling dome shells using your or your contractor's local laborers. It is more cost effective to hire him for the shell assembly than to hire a local subcontractor who has never assembled an American Ingenuity dome kit. Local sub-contractors typically charge more for dome shell assembly, because they are not used to that type of construction.

**Q:** What support is used to hold up the component panels until the dome kit is assembled?

**A:** Our dome kits are erected using a radial or rib system of 2x4's to temporarily hold the panels in place until the concrete has cured.

The radial system is most suitable for a small construction crew and is usually used on our smaller domes (34' or smaller), because the panels weigh less and the center height is less. Panels are held in place while the seams are concreted by 2x4's braced against the floor. The advantages to this system versus the rib system are: panels can be raised using a rolling scaffold and a winch rather than with a crane, requires less time, uses fewer materials.

The rib system is most suitable for a large crew and a fast paced construction, and is preferable for the larger domes (40' and up). It requires use of your own 2x4's and steel hubs borrowed from us to erect a free standing framework matching the geometry of the dome. With the rib system in place, a crane or other hoisting mechanism can be used to set as many as 2 rows of panels in one day. Since the rib system matches the dome geometry, a panel cannot be inadvertently positioned incorrectly.

Once all the concrete cures in the seams and on the entryways, dormers, link, and cupola, the rib system is disassembled, the hubs are returned to American Ingenuity, and the 2x4's are recycled as interior framing. We require a \$500 deposit for use of the hubs. There is no rental charge for up to four months. After that, the rental fee is \$10 per month.

**Q:** What will it cost per square foot for a completed dome home?

**A:** If you hire a contractor to do all the work, you can expect the finished price per square foot on your dome home to be about the same as a conventional house of the same square footage. However, substantial savings can be realized by doing some or all of the labor yourself.

For an example of estimated square footage costs, see our [Construction Cost Estimate page](#).

**Q:** How long will it take to complete the shell of my dome?

**A:** After the concrete slab or flooring is finished, it will take approximately 600 man-hours to complete a 30' dome shell. You can expect another 100 man-hours to frame the entryways and dormers and install your locally purchased windows and doors. Time would not be required to install insulation, roofing or exterior trim as in other homes. Our 48' dome will require about twice that amount of time to reach the same stage of completion as the 30'. Construction time will also vary depending upon weather, experience, and available equipment.

**Q:** How long will it take to completely build my dome home?

**A:** About the same amount of time as a conventional house.

**Q:** What items will I need to supply in order to erect my building kit?

**A:** Depending on the size of your dome, you will need:

- 4-10 cubic yards of sand
- 35-90 bags of Portland cement
- a concrete mixer
- a steel scaffold, crane, or transverse lift (latter two can be rented)
- basic hand tools (trowels, ladders, buckets, etc.)

**Q:** What type of hoisting mechanism or crane will I need and for how long?

**A:** The panels of our smaller domes can be placed using a scaffold. The panel is then held in place with a prop support until the seam concrete hardens. The panels for the larger domes are best placed using a crane capable of lifting 300-400 pounds, 25 feet up and 25 feet out. Rentals on transverse lifts (also called boom lifts, horizontal boom fork lifts, roofing lifts, or shooters) are available from national rental chains, found in your local telephone book.

With a four person work crew and proper bracing of the panels, two rows of panels on a 45' dome can be placed in a day, or 5-8 hours of crane time. In most cases, total crane operating time will vary from about 10 hours for a smaller dome to 14 hours for a 48' dome.



**Q:** Can I berm or backfill dirt up around the outside of my dome?

**A:** Our dome lends itself very well to berming because of the strength of the dome shape and the totally concrete exterior wall, with no materials to rot. Our domes have been bermed with as much as eight feet of backfill. However, if you earth berm your dome, we recommend a drain system to drain the water away from the foundation. Plans for this drain system are included with our basement plans.

Our dome can be bermed higher, but we do not recommend it. Any structure that is not buried would never have to withstand loads greater than 100 pounds per square foot. But if a structure is buried, the earth could cause loads in excess of 500 pounds per square foot. Our domes are not designed for such extreme conditions. If you plan to earth-berm your dome, let us know when ordering your plans so that we can advise you of any necessary modifications.

**Q:** What kind of vapor barrier will my dome have?

**A:** Approximately one quarter of the energy consumed by an air conditioner is used to extract water vapor from inside the house. Water vapor easily passes through most building materials and is readily swept into homes through joints, seams, and the attic. Our EPS insulation provides a good vapor barrier and our building method provides a tight, leak proof home.

**Q:** How will the concrete in my dome withstand the effects of freezing temperatures?

**A:** Concrete is an excellent and common building material in all temperate zones throughout the world. Concrete is only affected by freezing temperatures if it is porous and absorbs water. The richness and density of our concrete prevents water absorption. Our concrete is also formulated with an air entrainment admixture which further improves the freeze-thaw characteristics, and the exterior paint provides an additional seal.

So that the concrete you mix on-site has the same properties, we provide you with the same concrete ingredients that are used in the panel concrete....synthetic fibers, liquid admixtures, and a bonding agent.

**Q:** What do I apply to the interior of the dome shell after I assemble the kit? Can I purchase an interior board on the component panels?

**A:** You can purchase the building kit with or without the interior gypsum. If you do not purchase the optional interior gypsum, on site you can trowel either plaster or stucco directly to the EPS or you can glue drywall directly to the EPS. The interior board supplied by us consists of 1/4" Georgia Pacific Glass Mat Gypsum with fiberglass reinforcing on both sides. It is adhered to the EPS insulation utilizing urethane adhesive. The gypsum mat is resistant to mildew and water.

**Q:** Are there any special requirements for the foundation?

**A:** The only thing unusual about our foundation is its shape. Because our dome is lighter than most other buildings, it has less loading on the foundation. Reinforcing bars connect the riser walls to the foundation at the vertical seams. Our stock building plans include drawings for a concrete slab foundation. Plans for raised wood floors or basements are also available.

**Q:** How much weight will the second floor support?

**A:** At least 40 pounds per square foot, the same as other houses. We can easily design for a more demanding loads such as waterbeds, libraries, whirlpool tubs, or spas.

**Q:** How is the second floor attached to the dome shell?

**A:** Most often, the second floor joists are set on top of the first floor walls, the same as in conventional framing. In areas where additional support is needed, or where there are no first floor walls, the floor may be hung from the dome shell by anchoring a 5/8" threaded rod vertically into the concrete of a seam. Because of the incredible strength of our dome we are able to use the shell to support the second floor.

**Q:** Can I use steel studs in my American Ingenuity Dome?

**A:** Yes, we can design your dome to utilize steel joist and steel studs by designing them into your plans.

There are many benefits in using steel framing over wood framing. Steel joists can span great distances; thus, larger rooms are possible because fewer supports are needed for the floor above. Durability is also a benefit. Unlike wood, steel framing will not rot, shrink, swell, split or warp; and because of its zinc coating, it will not rust. Steel framing is impervious to termites and rodents and is non-combustible. The environment benefits as well. Much of steel framing is made from recycled steel, and what little waste is leftover from construction can be recycled again. Also, steel does not require the use pesticides and other toxic substances used to treat wood. Steel is priced competitively with wood and is easy to install; plywood flooring and wall board are attached with screws. Like our dome, steel studs are fire and termite resistant, affordable and earth friendly. A perfect match.

**Q:** Can I install conventional doors and windows in the dome exterior? And where are they installed?

**A:** Yes. They are installed under the entryways and dormers within 2x4 walls that are built on-site.

**Q:** How is the exterior wall within an entryway or dormer built?

**A:** It is constructed on-site using typical 2x4 wood framing techniques, allowing you to personalize an important part of your dome, including your choice of locally purchased standard doors and windows. (Be sure to select energy efficient windows with double glass and insulated doors.) Using your own custom design, the entryway exterior finish can be stucco, siding, brick, rock, or any other material.

**Q:** How are the electric and plumbing lines installed in the wall of the dome shell?

**A:** Almost all of the electric and plumbing lines will be contained in the interior frame walls, in the same manner as conventional housing. If you want to install electrical wiring in the exterior dome walls, simply cut a groove in the EPS insulation and insert the wire. To install electrical boxes, conduit, or plumbing pipes, cut out the insulation slightly larger than needed, insert the box or pipe, and fill in the opening with spray foam. The spray foam will harden in about half an hour, holding the box or pipe secure.

**Q:** How are plumbing vent pipes installed in the dome shell?

**A:** The plumbing vent pipes can be routed sideways through the interior framing and can sometimes be joined together before they exit the dome. All you need do is make a hole through the panel in the appropriate location, insert the pipe, re-concrete, caulk, and paint.

**Q:** Can the dome have a fireplace and how is a fireplace installed?

**A:** Yes, the dome can have a fireplace. We suggest that domeowners try to locate their fireplace toward the middle of the dome rather than along the outside edge. This puts more of the flue pipe inside the house where it can radiate heat. As long as the flue pipe is round, you simply cut a hole in the concrete, enlarge the hole in the foam so that you can replace the foam with 2" of fiberglass insulation, concrete around the vent pipe, caulk, and paint.

**Q:** What is the link between the domes made of?

**A:** Links are made of the same materials as the dome panels. The thickness of the EPS in a link is usually 7" when it takes the place of an entryway (two panels wide) and 3 1/2" when it connects like a door dormer (one panel wide).

Link panels are not concreted or meshed. They are precut, but they require some trimming where they connect to the dome. After the panels are in place, they get covered with steel mesh and then concrete is applied to the specified thickness.

**Q:** What type of paint should I use on the exterior of my dome?

**A:** We recommend a good quality concrete primer followed by an acrylic latex house paint. Because of the reduced surface area and lack of trim, most domes can be painted in just one day. Your dome can be painted in any of color, but we suggest that you avoid darker shades. You can purchase the paint locally or it can be ordered from us and shipped with your building kit.

**Q:** In most of the photographs the domes are painted white. How can I make the dome exterior look more conventional?

**A:** Here are some suggestions:

- Install stone, cedar, or wood on the vertical walls around the doors and windows in the entryways and dormers.
- Install a wooden deck off a second floor balcony, or connect two second floor balconies by a continuous deck.
- Paint the dome a warm tan or soft moss green.
- Landscape with trees around the dome. Install trellises with roses or vines that can climb to the second floor deck, concealing the first floor of the dome.
- Build a porch or deck off the first floor.
- Install canopies off the top of the entryways and door dormers.

**Q:** Would you explain briefly what is involved in the assembly of my dome kit?

**A:** · **Foundation:** Once you've chosen a home site, you may build your dome on a slab, raised, or basement foundation - or even on pilings or stilts, if necessary.

· **Temporary Support System:** During the kit assembly process, the panels of larger domes are held in place by a wooden support system. On our smaller domes, a simpler radial support system can be used, in which each panel is braced by temporary supports.

· **Panels:** Following the detailed instructions in the Assembly Manual, four foot high riser panels are anchored to rebars extending out of your prepared foundation. The riser walls are interconnected with subsequent rows of triangular panels. The steel mesh of adjacent panels is overlapped and hooked with C-rings. The upper panels of larger domes need to be placed using an elementary hoisting system or small crane.

· **Seams:** As the rows of panels are positioned, the seams are first half filled with the special fiber concrete mixed at the job site. Additives supplied with your kit render the same formulation as the panel concrete. Then, start at the top of the dome and come down using the bonding agent and concrete and fill the seams; finish the seam tops by sponge rubbing them to match the sand texture of the prefinished panels. To vary the exterior appearance to your taste, the seam concrete can be rounded, accentuated, or flat.

· **Openings:** The many openings for doors and windows are created by structural entryway and dormer panels. They are set in place, connected to the other panels, then stuccoed with a layer of our special formula concrete.

· **Painting:** After the final coat of seam concrete, additional sealing with a concrete primer, two coats of good quality exterior latex paint are applied.

· **Completion:** After your kit is assembled, you have the freedom to finish your home as you desire. Your choice of windows and doors are installed within the dormers and entryways in a stud wall which can be finished in concrete, stone, or wood. If you do not purchase the interior board option, you can finish the interior wall with drywall, paneling, plaster, or stucco. Interior walls are attached to the dome as they are framed, then finished to taste. The second floor joist rests on load bearing first floor walls and/or is suspended from the dome shell.

## ENERGY EFFICIENCY

**Q:** What Energy Star rating has the American Ingenuity dome received?

**A:** A 5+ Energy Star rating, the highest rating given. Energy Star is a joint program between the Environmental Protection Agency and the United States Department of Energy that is designed to promote products, buildings, and homes that use less energy without sacrificing quality.

American Ingenuity has received the Energy Star endorsement for our dome homes, making us the first among geodesic dome companies. Our domes not only qualified but far exceeded their efficiency standards. When financing, this rating will entitle you to the maximum benefits, such as reduced fees and lower interest rates. Energy Star's web site: [www.energystar.gov](http://www.energystar.gov)

**Q:** What do I need to consider when searching for an energy efficient house?

**A:** To best answer that question, let's examine how most of the heating and air conditioning is lost in a house. The major loss is usually through the walls and ceiling, with the amount of loss directly proportional to their combined area. Solution: minimize the surface area of the house. Domes have about 20 to 40% less surface area than a conventional house of the same square footage, resulting in a 20 to 40% improvement in energy efficiency.

The insulation value of the walls and ceilings are important, but you cannot just compare R-values. R-values provided for conventional houses represent optimum conditions. They do not take into consideration that the insulation is interrupted by the framing, has voids, settles, and absorbs moisture. In our domes, the EPS insulation is continuous, rigid, and will not settle or absorb moisture. R-28 EPS insulation in our dome exceeds the performance of R-45 fiberglass in a conventional house.

Blower tests have repeatedly shown that wood frame houses lose 10-25% of their heating and AC through the numerous leaks in the walls, attic, electrical outlets, etc. It is very difficult to seal these leaks due to their volume and inaccessibility. American Ingenuity domes are sealed airtight on the outside of the insulation, therefore eliminating the energy absorbing leaks.

The insulation on heating and AC ducts is usually only R-6 to R-8. In addition, when the fan is running, the air in the ducts is under pressure and thus the ducts are more inclined to leak. Ducts in the attic, or anywhere outside the insulation envelope, account for sizable energy loss. In American Ingenuity domes all of the ducts are inside the insulation; therefore, there is zero loss in the ducts even if they leak and are not insulated at all.

Now you understand why our dome owners experience heating and cooling savings in excess of 50% .

**Q:** How does your insulation R-value compare to other wall R-values?

**A:** The following are comprehensive wall values based on the average value of the complete wall. For example, the comprehensive R-value of 2x4 solid wood with 3 1/2" fiberglass is R-8, an 8" concrete block with 3/4" air and 3/4" Celotex is R-9; a 2x6 solid wood construction with 5 1/2" fiberglass is R-11, and a 2x4 solid wood with 3" urethane is R-13. The wall value of our 7" EPS insulation is R-28 and our 9" EPS insulation is R-36.

**Q:** Should I be concerned about moisture and dampness?

**A:** No. Moisture is added inside a house as a result of washing, cooking, showers, etc. When the air conditioner is operating, the moisture level will be controlled by condensation at the evaporator coil. Moisture can accumulate inside a house if it's not air conditioned. It can be easily controlled by occasionally opening a window at the top of the dome where most of the moisture accumulates. If you build without a cupola, then you instead install an exhaust fan at the peak of the dome, which allows you to remove excess moisture with the flip of a switch.

**Q:** Can I use alternative power sources with my American Ingenuity dome?

**A:** Yes. By providing your own alternative power you can live in a remote location (less expensive land) and still have all the amenities of a developed area. The alternative power systems typically consist of a power source, a storage device, and a conversion system. Most systems use photovoltaic cells, but in some cases gasoline, diesel, wind, or water driven generators are practical. The storage device is usually large batteries. The conversion system allows you to have 110 volts AC and use conventional appliances. The technology is very refined and the systems are top notch. The cost of the system will depend directly on the amount of power that you need.

If you are also connected to the local power grid, you will not need batteries for backup, and in most cases you get paid for putting power back into the system.

Utilizing an alternate power source does have a few drawbacks - Cost: while systems are getting more affordable, they are still expensive. It is still less expensive to buy power from power companies unless you are far from the power lines. Maintenance and reliability: Most systems are very reliable but occasionally need attention. Several of our dome owners have alternative power systems and are very satisfied with the results.

The following appeared in the June/July 1998 **Home Power** magazine:

"What do you need when you are going to live in a high desert (7,500 feet) 40 miles from the nearest town with the winters reaching down to 20 degrees below zero? That is where Jim and Mary Collar planned to build their solar retirement home. To extend electric power to their home site it would cost \$22,000.00, so the Collars decided to produce their power using photovoltaic solar cells with a back up generator. Their primary source of heat would be their fireplace. In 1995, after researching many alternative-building methods, they found their house, an American Ingenuity 45' dome home and 30' dome garage. The dome kit was selected for its strength, energy efficiency and its affordability. They selected subcontractors for the construction of their two domes, with Mary being the general contractor. Jim was commuting 40 miles to his job, but on evenings and weekends they could work together. They were asked by the state of Utah to participate in "Utahs 1998 Tour of Innovative Homes", which is in conjunction with the American Solar Energy Society's National Tour of Solar Homes. "

**Q:** How did the American Ingenuity dome perform in the energy efficiency tests at the Florida Solar Energy Center?

**A:** Superbly. Test findings were released after a yearlong study prepared for the U.S. Department of Energy by the [Florida Solar Energy Center](#), a governmental consumer agency, in cooperation with the University of Oregon and the University of Central Florida. This study compared an American Ingenuity

dome with an energy efficient, conventionally built structure and a super efficient styrofoam house designed by Dow Chemical. Our test dome far surpassed both the conventional and Dow test houses in being the selected as the most energy efficient. In the summer, the energy savings for our dome exceeded 36% and in the winter the energy savings exceeded 42%. In areas of severe cold and heat, savings would be expected to be considerably higher.

Also, the blower door test showed our dome to be 56% tighter than the conventional test structure and 29% tighter than the Dow house.

Visit the Florida Solar Energy Center website at [www.fsec.ucf.edu](http://www.fsec.ucf.edu).

**Q:** Which heating and air conditioning system is the most practical and efficient for my location?

**A:** Keep in mind that the superb energy efficiency of the dome will reduce your heating and air conditioning needs by about half. Therefore, it is usually not economical to purchase super-efficient systems. Smaller sized domes can be cooled with only a window air conditioner. The best heating system will vary with the area and the type of fuel that is readily available. A ventilated wood stove may provide all the needed heat in cold climates for even our larger domes. A ground water (or water-to-air) heat pump is very efficient for both heating and cooling. They use the constant, moderate temperature of the underground earth to absorb or provide heat. They can even efficiently produce heat when the outside temperature is below freezing.

**Q:** Can a radiant in floor heating system be installed in my dome?

**A:** Yes. Please visit the Radiant Floor Company at [www.radiantcompany.com](http://www.radiantcompany.com).

**Q:** Why are your dome homes so energy efficient?

**A:**

- Insulation that does not degrade with time, moisture, or compaction
- Spherical shape means reduced exposed surface
- Airtight exterior virtually eliminates energy leakage
- Solid thermal envelope.
- Uniform R-value. The insulation is not interrupted with structural members (e.g. 2X4's roof trusses). The only breaks are for doors and windows.

## STRENGTH

**Q:** When **Inside Edition** visited, what dome advantage did they zero in on?

**A:** The theme of the segment revolved around the super strength of our domes and how they withstand hurricane forces. The reporter and camera crew first went to Miami, Florida and interviewed the owners of an American Ingenuity dome that survived a direct hit from hurricane Andrew.

The program director had previously asked us for a way to illustrate the domes' ability to withstand hurricane force winds. Being unable to call up a 200 mph wind, our best option was to provide a computer analysis. The computer simulated a force equal to 230 mph winds. Our dome stood rock solid. In fact, to see the movement in the dome, the deflection had to be magnified 50 times. A square structure was also modeled, but it collapsed with 150 mph winds.

**Q:** What wind, seismic, and snow loads will the dome withstand?

**A:** Because the structure of our dome is steel reinforced concrete, it is incredibly strong and easily enhanced to accommodate unusual requirements. The standard design will withstand hurricane force winds, extreme snow loads, and 9.0 earthquakes. If that's not enough, just tell us what you need.

Our dome design has proven itself by withstanding Hurricane Andrew's 200 mph winds, a tornado that slammed a steel horse trailer against a dome, heavy snow loads of the Northwest Territory of Canada, a 115 foot tall hickory tree impact, a lightning strike, and many other conditions over a 25 year period.

More about the tree impact: There was no damage to the Brack's 48' dome after winds in excess of 75 mph hit North Carolina in July of 1996. The real test came when a 115' high, 30" in diameter hickory tree was blown over and fell on their dome. The impact snapped a branch 10 inches in diameter. The tree slid off and landed on a deck post, driving it and its 16 inch square concrete footer six feet into the ground. The insurance agent who inspected the damage to the deck conveyed his amazement about the dome's strength with this comment: "If that had been a frame house, the tree would have ended up in the basement!"

More about the lightning strike: American Ingenuity's 45' office dome was once struck by lightning. It hit the outer edge of an entryway, and the only damage it did was to knock off a handful of concrete at the point of impact! A couple of our computers have not been the same since, but the cost to repair the dome was less than \$30 in materials and labor.

**Q:** Have you performed a load test on your panel?

**A:** Yes. In October 2000, we performed a load test on our largest house panel, a panel from a 48' dome kit with the standard 7" EPS insulation, 3/4" concrete exterior reinforced with steel mesh, and fiber reinforced plaster on the interior. The panel was placed horizontally. Its weight and the weight of everything placed on it was only supported along the outer edge of the panel. Plywood sides were attached to the panel edges so that the weight (sand) could be spread evenly, providing a uniform load. The sand was added in 470 pound increments.

Steel rulers were attached to the panel at the center and six other locations, extending high enough to be visible when the panel was fully loaded with the sand. A surveyor's transit allowed us to measure the deflection.

After 3,783 pounds of sand were dumped on the panel, its center had deflected less than 1/16 inch. Three days later, the deflections had only increased to 3/32 inch. Our own amazement at the strength made us more brave, so we cut through the interior plaster on the bottom of the panel. Even then, the deflection was less than 3/16 inch.

We had not expected this exceptional strength. We could not mound the sand any higher, so we set a pallet of 40 cement bags on top of the sand. That doubled the weight on the panel, but the center deflection increased to only 3/8 inch after 24 hours.

A 120 mph wind will exert a pressure of 30 pounds per square foot. Snow loads exceeding 50 pounds per square foot are rare. But in this test, our panel withstood a force of 180 pounds per square foot.

**Q:** The panel concrete is not that thick. Why is American Ingenuity's dome so strong?

**A:** The panel concrete does not need to be thick, because the strength comes from the steel reinforced concreted seams, which are about 6" wide and 4" deep. The seams almost act like steel beams.

## FINANCING

**Q:** What is the resale value of American Ingenuity domes?

**A:** In more than 28 years and out of more than 450 kits sold and erected, less than ten of our dome owners have ever sold their dome. Therefore, it's difficult to provide an answer to that question that would have any statistical validity. However, available evidence suggests that our domes have a resale value comparable to conventional houses of the same square footage.

**Q:** Will it be difficult to get a loan to build my dome?

**A:** Conventional mortgage lenders tend to be ultra conservative when considering a dome. Mortgage brokers or indirect sources for financing may be more flexible and quicker for you. Ask us for our list of possible lenders. Refinancing other property or acquiring loans from other sources may be easier while avoiding the restrictions and requirements of conventional construction loans. Another popular option is the pay-as-you-go method. Combined with partial financing, this can get you into your new dome. For a helpful, in depth look at financing, visit our page about [Financing Your Dome](#).

**Q:** Do you sometimes have special pricing? Is there a way to secure lower pricing if I am planning on purchasing in one to five years?

**A:** Typically, we offer a discount on our kits during the winter months. Every year as temperatures fall, construction activity also drops. If you take delivery of your dome kit during our slower winter months, you can save hundreds of dollars. These special prices cannot be combined with other discounts or savings. Note: even severe freezing weather will not damage the panels when stored outside.

If you are planning on purchasing your dome kit in one to five years, you have a couple of options to pursue in order to secure lower pricing. One is to place a 10% deposit on your dome building kit before April of the current year and lock in a 6% discount off that years kit pricing until January of the following year. If you are not ready to receive shipment by then, you may continue to hold the discounted pricing by placing an additional 10% deposit each year that you delay shipment. Or you can do nothing and still receive 6% off

the current building kit prices when you do take delivery.

The second way you can save money on your building kit is to utilize our five year layaway program. Patience is a great virtue. It is typical to take years before a person can purchase their dome kit. So hang in there! Sometimes saving or setting money aside is a difficult task and a little incentive is needed. We've often had requests from those who would like to make monthly payments towards their kit, so we came up with a layaway plan.

Layaway requires an initial 5% down payment with up to 60 monthly payments thereafter. For example, a dome kit costing \$12,630 would require \$630 down, with 60 monthly installments of \$200. You may reduce that time with larger monthly payments. The price of your dome kit will not change as our prices increase. You will automatically freeze the kit pricing for up to five years and realize a considerable savings. If you change your mind, all payments are completely refundable if your kit has not yet been manufactured. After we begin manufacturing your kit, partial refunds are still available.

Anytime after your combined payments exceed 30% , you can order your kit and schedule a shipment date (allow 3 months) . The balance is due seven days prior to shipment.

[Main](#)  
[Dome Pictures](#) | [Floor Plans](#)  
[Planning Kit / Video / Model Dome Kit](#)  
[Mail](#) | [Dome Prices](#) | [Specifications](#) | [FAQ](#) | [Maps](#)  
[Construction Cost Estimates](#)  
[Dome Home Financing](#) | [Dome Construction](#) | [Links](#)  
  
[The GEO POD - Utility Dome](#)

## AMERICAN INGENUITY, INC.

8777 Holiday Springs Road, Rockledge, Florida 32955-5805

PHONE: 321-639-8777 FAX: 321-639-8778

Established in 1976

WEB: <http://www.aidomes.com> EMAIL: [info@aidomes.com](mailto:info@aidomes.com)

© Copyright 2002 [American Ingenuity Domes](#)  
[modular geodesic dome](#)



# AMERICAN INGENUITY

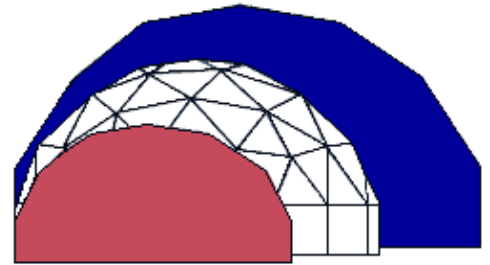

CREATING INTELLIGENT ALTERNATIVES

## American Ingenuity, Inc. Driving Directions

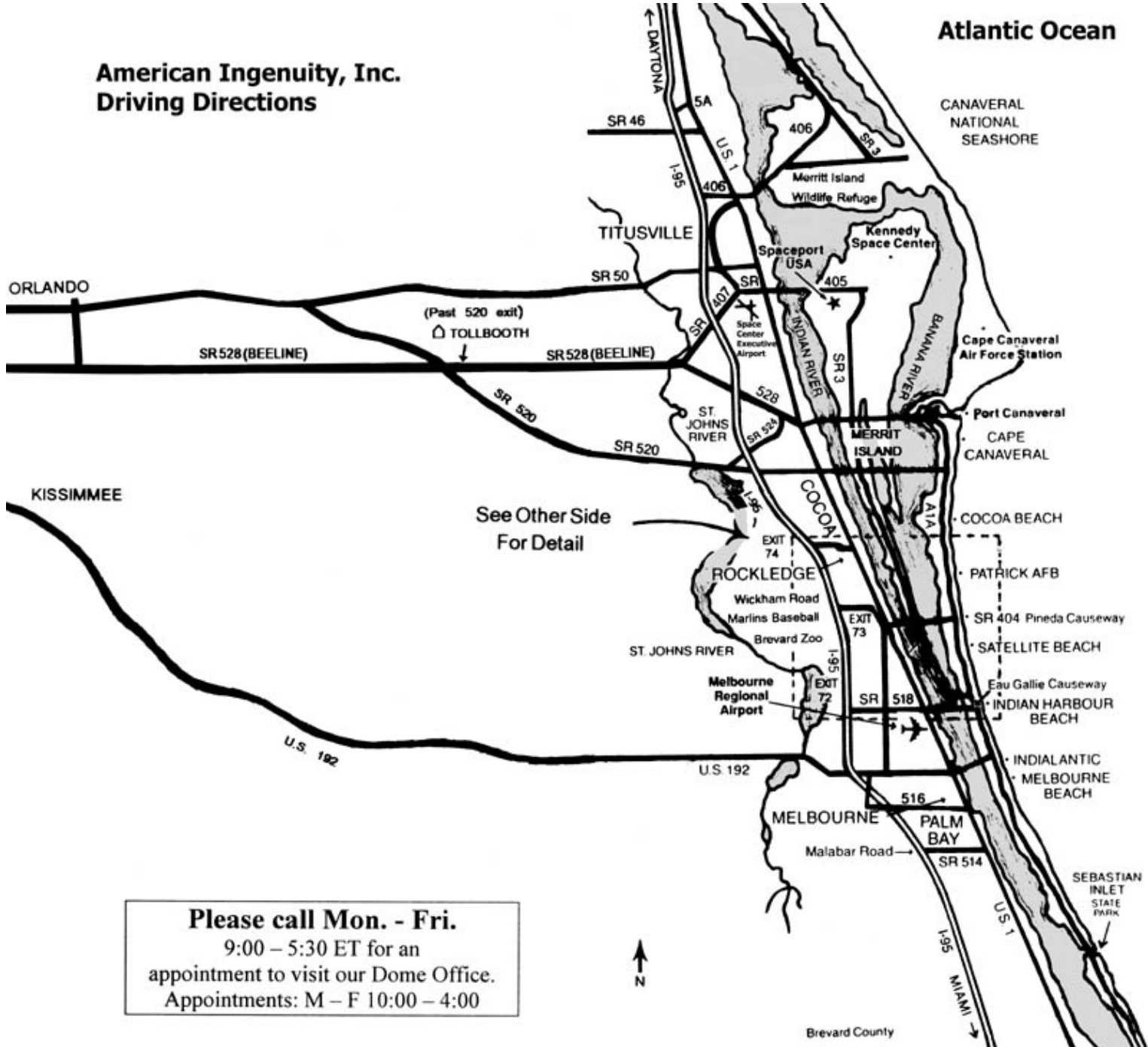

**Please call Mon. - Fri.**  
 9:00 – 5:30 ET for an  
 appointment to visit our Dome Office.  
 Appointments: M – F 10:00 – 4:00

You can get detailed driving directions to American Ingenuity, Inc. at <http://www.mapquest.com>

### [To Map 2](#)

- [Main](#)
- [Dome Pictures](#) | [Floor Plans](#)
- [Planning Kit / Video / Model Dome Kit](#)
- [Mail](#) | [Dome Prices](#) | [Specifications](#) | [FAQ](#) | [Maps](#)



[Construction Cost Estimates](#)  
[Dome Home Financing](#) | [Dome Construction](#) | [Links](#)

[The GEO POD - Utility Dome](#)

# AMERICAN INGENUITY, INC.

8777 Holiday Springs Road

Rockledge, Florida 32955-5805

PHONE: 321-639-8777 FAX: 321-639-8778

Established in 1976

WEB: <http://www.aidomes.com> EMAIL: [info@aidomes.com](mailto:info@aidomes.com)

© Copyright 2002 [American Ingenuity Domes](#)  
[modular geodesic dome](#)



# AMERICAN INGENUITY

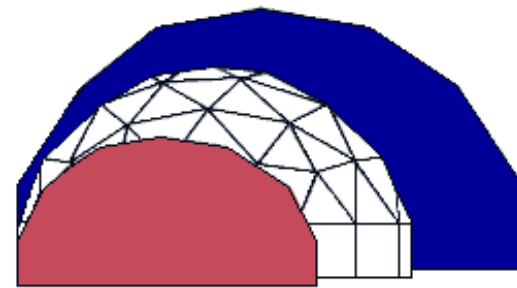

CREATING INTELLIGENT ALTERNATIVES

## CONSTRUCTION COST ESTIMATES

The following prices are approximations to help you in estimating the cost of your completed dome. Labor costs can be substantially reduced by supplying some sweat equity. Some items listed may not be needed, thus lowering costs. Or, you may choose to add items such as a whirlpool tub, hardwood floors, or custom cabinetry, thus increasing costs.

| DOMESIZE                          | 30'             |                 | 34'             |                 | 40'              |                 | 45'              |                 | 48'              |                 |
|-----------------------------------|-----------------|-----------------|-----------------|-----------------|------------------|-----------------|------------------|-----------------|------------------|-----------------|
| ITEM                              | Material        | Labor           | Material        | Labor           | Material         | Labor           | Material         | Labor           | Material         | Labor           |
| Dome Kit w/out cupola             | \$16,076        | \$0             | \$18,911        | \$0             | \$23,914         | \$0             | \$28,831         | \$0             | \$32,785         | \$0             |
| Dome Kit assembly                 | 1,965           | 13,344          | 2,300           | 15,720          | 2,900            | 19,800          | 3,420            | 23,280          | 3,950            | 26,880          |
| Concrete slab/found'n             | 1,521           | 1,792           | 1,885           | 2,212           | 3,354            | 3,920           | 3,510            | 4,060           | 3,900            | 4,480           |
| Windows: qty. - cost              | 6-1,500         | 660             | 7-1,450         | 660             | 6-1,500          | 660             | 7-1,740          | 770             | 6-1,500          | 1,540           |
| Exterior doors: qty.-cost         | 3-900           | 220             | 2-600           | 220             | 3-900            | 440             | 5-1,500          | 500             | 4-1,200          | 330             |
| Rough plumbing                    | 451             | 1,272           | 682             | 1,920           | 880              | 2,484           | 1,078            | 3,000           | 1,155            | 3,240           |
| Rough electrical                  | 574             | 1,166           | 868             | 1,760           | 1,120            | 2,277           | 1,372            | 2,750           | 1,470            | 2,970           |
| AC/Heat & ducting                 | * 600           | 0               | 1,815           | 1,210           | 2,090            | 1,397           | 2,497            | 1,650           | 2,750            | 1,815           |
| Interior framing                  | 2,040           | 2,040           | 3,036           | 3,036           | 4,200            | 4,200           | 5,040            | 5,040           | 5,580            | 5,580           |
| Stairway                          | 744             | 682             | 744             | 682             | 912              | 836             | 912              | 836             | 912              | 836             |
| Drywall and finish                | 1,130           | 2,520           | 1,440           | 3,216           | 1,820            | 4,080           | 2,020            | 4,512           | 2,300            | 5,160           |
| Shell interior finish             | 270             | 1,800           | 339             | 2,300           | 429              | 2,890           | 540              | 3,650           | 648              | 4,370           |
| Int. doors, trim, finish          | 616             | 1,133           | 1,045           | 1,936           | 1,364            | 2,552           | 1,595            | 2,970           | 1,760            | 3,300           |
| Painting - int. & ext.            | 1,133           | 1,694           | 1,430           | 2,178           | 1,870            | 2,783           | 2,145            | 3,190           | 2,530            | 3,773           |
| Cabinets & vanities               | 2,088           | 528             | 2,784           | 696             | 3,960            | 1,896           | 4,440            | 1,104           | 4,884            | 1,200           |
| Plumbing fixtures                 | 726             | 198             | 1,452           | 396             | 1,870            | 506             | 2,310            | 627             | 2,662            | 726             |
| Electrical fixtures               | 351             | 110             | 639             | 220             | 990              | 330             | 1,188            | 396             | 1,530            | 506             |
| Carpet and flooring               | 1,584           | 396             | 2,316           | 564             | 3,636            | 900             | 4,560            | 1,140           | 5,160            | 1,284           |
| Kitchen appliances                | 930             | 50              | 1,320           | 100             | 1,700            | 100             | 2,000            | 100             | 2,000            | 100             |
| <b>TOTAL</b>                      | <b>\$35,199</b> | <b>\$29,605</b> | <b>\$45,346</b> | <b>\$39,026</b> | <b>\$59,409</b>  | <b>\$52,051</b> | <b>\$70,198</b>  | <b>\$59,575</b> | <b>\$75,076</b>  | <b>\$68,090</b> |
| <b>TOTAL material &amp; labor</b> | <b>\$64,804</b> |                 | <b>\$84,372</b> |                 | <b>\$111,460</b> |                 | <b>\$129,773</b> |                 | <b>\$143,166</b> |                 |
| Square Footage                    | 931 sq. ft.     |                 | 1,381 sq. ft.   |                 | 1,864 sq. ft.    |                 | 2,281 sq. ft.    |                 | 2,569 sq. ft.    |                 |
| Cost per sq. ft.                  | \$70            |                 | \$61            |                 | \$60             |                 | \$57             |                 | \$56             |                 |

\* Window AC and space heater.

Cost estimates are based on 30', 40', and 45' Alpha, and 34' and 48' Delta (without cupola), utilizing standard grade components. Labor costs are figured at \$10/hour for unskilled labor and \$20/hour for skilled labor. These estimates do not include costs of land, engineering and permit fees, plans, site preparation, well, septic/sewer, or water. Prices listed are provided for the purpose of estimation only and will vary with design, location, builder, and upgrades.

[Main](#)  
[Dome Pictures](#) | [Floor Plans](#)  
[Planning Kit / Video / Model Dome Kit](#)  
[Mail](#) | [Dome Prices](#) | [Specifications](#) | [FAQ](#) | [Maps](#)

# AMERICAN INGENUITY, INC.

8777 Holiday Springs Road, Rockledge, Florida 32955-5805

PHONE: 321-639-8777 FAX: 321-639-8778

WEB: <http://www.aidomes.com> EMAIL: [info@aidomes.com](mailto:info@aidomes.com)

© Copyright 2002 [American Ingenuity Domes](#)  
[modular geodesic dome](#)



# AMERICAN INGENUITY

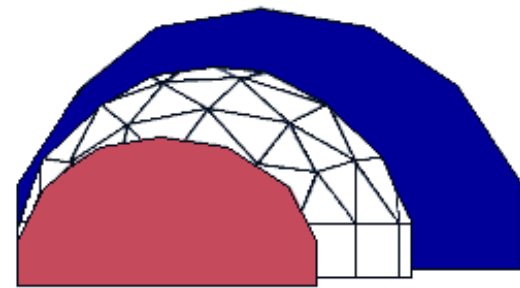

CREATING INTELLIGENT ALTERNATIVES

Download and view this 17 page booklet about financing your dome.

[financing.doc](#)

[Main](#)

[Dome Pictures](#) | [Floor Plans](#)

[Planning Kit / Video / Model Dome Kit](#)

[Mail](#) | [Dome Prices](#) | [Specifications](#) | [FAQ](#) | [Maps](#)

[Construction Cost Estimates](#)

[Dome Home Financing](#) | [Dome Construction](#) | [Links](#)

[The GEO POD - Utility Dome](#)

---

## AMERICAN INGENUITY, INC.

8777 Holiday Springs Road, Rockledge, Florida 32955-5805

PHONE: 321-639-8777 FAX: 321-639-8778

WEB: <http://www.aidomes.com> EMAIL: [info@aidomes.com](mailto:info@aidomes.com)

© Copyright 2002 [American Ingenuity Domes](#)  
[modular geodesic dome](#)



# AMERICAN INGENUITY

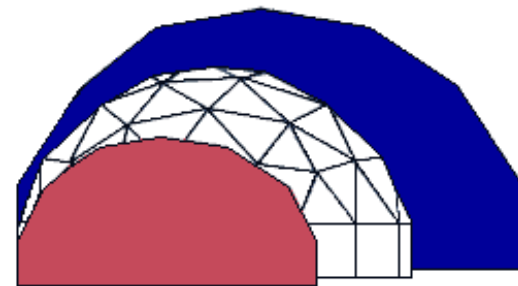

CREATING INTELLIGENT ALTERNATIVES

## Geodesic Dome Building Overview

The **American Ingenuity** geodesic dome shell kit is designed with unique and practical materials. We developed simplified, effective construction techniques, invented a component panel and created a home which offers the ultimate in energy efficiency and practicality. We have been in business, with the same owner, over 25 years and we have domes in 44 states.

**Whatever size floorplan you seek**, whether for a modest starter home or a grand estate, **American Ingenuity** domes are flexible enough to adapt to your conditions. Building plans include the basic drawings for the dome that are needed when you acquire a building permit. The plans are composed on our computer aided drafting system as stock plans, or custom plans based on your individual requirements and design. Some of the pages are a 3-D elevation and a 3-D perspective view. These plans include all the structural drawings, show the placement of the electrical outlets, light fixtures, plumbing fixtures; however, they do not have the electrical, plumbing, HVAC layouts. We have found if the layouts are included, then the inspectors require the subcontractors to follow the diagrams when usually the subs like to do their own layouts.

**The following is a quick overview of our kit contents and our building process** to give you an idea of what is required and how time-wise building an **American Ingenuity** dome can be prior to the purchase of your personal dome. When you purchase a dome shell kit from us, the full "Assembly Manual" is included and is much more extensive and precise.

**Over one half of our clients assemble their kit**, many with no construction experience. The Component Panels, Building Plans and Assembly Manual come marked with numbers and letters. If you do not have the time or do not want to assemble the dome kit, we know of independent subcontractors that travel around the country assembling the dome shell using your or your contractor's laborers.

**The American Ingenuity dome building kit includes** one entryway and all the panels to assemble the dome shell. The dome shell kit package includes Triangular Panels, 4' Riser Wall Panels, Entryway Panels, Galvanized Steel Mesh, Concrete Fibers, Two Concrete Admixtures, Reinforcing Tension Wire, Concrete Bonding Agent, Connecting C-Rings, C-Ring Pliers, Assembly Manual, Accessory Package.

**For freedom and flexibility of design, you can select additional building kit options** which are determined by your choice of floor plan. The options include: additional Entryway Panels (garage, high profile, or standard), Window Dormer Panels (first floor and or second floor), Door Dormer Panels (first floor and or second floor), Skylight Panels, Cupola Panels, R-36 Insulation and Interior Board. Within the entryways and dormers, on site you build a vertical wall to install your doors and windows. No interior items are included in the kit. We believe you should not pay shipping on items you can purchase locally such as; plumbing, electrical, framing, flooring, kitchen cabinets, bathroom fixtures, stairs, fireplaces, windows, doors, etc.

**The basic building process consists** of placing the preconcreted, insulated panels, overlapping and interlocking the steel mesh and concreting the seams and options. You do not concrete the entire dome exterior. Only the panel seams and the building kit options are concreted on site.

**Entryway panels** utilize 3 1/2" E.P.S., are preconcreted on the underside surface and have a precast trough on the outer edge. You place rebar into the trough, fill the trough with concrete and concrete the outside surface.

**Window and door dormer panels** consist of 3 1/2" E.P.S. wrapped with steel mesh ready for on site stucco. The openings under the entryways and dormers are framed in on the site to fit your choice of standard windows and doors that you purchase locally.

**Non-opening skylights** are preinstalled in triangular component panels. A skylight consists of two pieces of 1/4" thick tempered safety glass (like car side window glass) about 46" h x 50" w with 1/2" air space. Desican is installed between the two pieces of glass to keep "sweating" down. Gas between pieces of glass does not stop sweating. The skylight provides over 8 square feet of glass. We put together the glass panels at our factory. A triangular hole is cast in the component panel where the skylight sits on a ledge. Aluminum strips, stainless steel screws and black weather stripping are used to install the skylight. Skylight panels are

factory installed but are shipped unseated unless specifically requested by the owner. The skylights can be removed by removing the aluminum strips, screws, etc. The skylights are available in Clear, Low E (reflects radiant heat), or Reflective.

The **interior board option** consists of 1/4" Georgia Pacific Dens Glass Mat Gypsum adhered to the E.P.S. insulation of each component panel with urethane adhesive. This advanced gypsum board is resistant to mildew and water.

Once your kit is assembled and if you purchased the interior board option, the board on the interior of the dome shell is ready to be finished almost identically to the method drywall board seams are finished. There will be a 1/2" gap between the panels that allows you to insert electrical wiring without cutting the interior board. This 1/2" gap is filled with a nonshrinking joint compound like "Gold Bond Pro Form". Then those seams and the other interior shell seams are finished with typical joint compound and fiberglass joint tape. Applying a textured paint will likely hide the board seams and complete the dome shell interior.

If you did not purchase the optional interior board you can trowel plaster or stucco directly to the rigid E.P.S. interior dome shell surface. Or you can glue drywall board directly to the E.P.S. insulation.

The **interior framing of the dome** is built much like conventional housing and can be either wood or metal. Some of the second floor can be hung from the dome concreted seams by suspension rods allowing for very "open" first floor plan designs. The **American Ingenuity** dome is capable of supporting a large amount of weight, including the 2nd floor, from the concrete dome shell. This weight is suspended by threaded steel rods which anchor into the concrete seams and extend vertically down into the dome. Over 3,000 lbs. can be supported by a 5/8" threaded rod suspended in one of the concrete seams. The location of the suspension rods is determined by your floor plan selection. The Building Plans will show the suspension rod's positioning. The suspension rod with nut sets on a 3" x 7" steel plate, which is embedded in the concrete seam. The seam is reinforced with #4 rebar & two layers of galvanized steel mesh. The second floor can support at least 40 pounds per square foot, the same as other houses. We can easily design for a more demanding second floor load such as for waterbeds, whirlpool tubs, spas, libraries, etc.

Almost all of the **electrical and plumbing** will be contained in the interior frame walls and installed in the same manner as conventional housing. To install electrical wiring in the exterior dome walls: simply cut a groove in the E.P.S insulation and insert the wire. To install electrical boxes, conduit or plumbing pipes: cut the E.P.S. insulation slightly larger than needed, insert the box or pipe and fill in the opening with spray expanding foam. The spray foam will harden in about 1/2 an hour, holding the box or pipe secure.

"It is a terrific thing to get a building built that has the qualities of greatness in it."

-Frank Lloyd Wright

[Click on any picture for a full size view.](#)



Your dome can be built on your choice of foundation including: concrete slab, raised, stem wall or pier foundation, full or partial basement, stilts or pilings.

Because of the reduced surface area of a dome and its thin shell construction, our domes weigh less than the average house, but are remarkably stronger. **American Ingenuity** domes are considerably lighter than a concrete block house. A finished 27' dome shell weights about 25,000 lbs.; a finished 48' in diameter dome weights about 42,000 lbs.

You do not have to build the dome on a certain soil type. Sand or rock are the easiest to build on and clay may be the most troublesome as it expands when wet. If your neighbors needed a soil sample before they could build their conventional house then you may need it too. Or if you feel something abnormal, ask your builder or neighbors. Because we cannot evaluate your soil suitability from here, you would need to consult with someone locally about the suitability of your topsoil. Possibly a building department or soil's engineer.

Your dome foundation does not require anything more than 2000 lbs. per sq.ft. soil bearing capacity. Basically if you can build a regular house on your soil, you can certainly build a dome. What is unusual about the foundation is the shape and rebars are designed to come out of the foundation and be concreted into the dome riser wall seams. Always use a vapor barrier with your slab of 6 mil. plastic sheeting and 6" x 6" steel mesh.



The above photo shows a building kit loaded onto a semi truck ready for shipment to the client. The domes behind the truck are two of our factory domes, a 48' and a 45' with the 60' dome not pictured.

On the smaller domes 22', 27', 30' and 34' we recommend a "radial support" method to prop up the panels during the kit assembly. On the larger domes 40', 45', 48' and 60' we recommend the use of the temporary "wooden rib system" which is illustrated by the photo on the right. The rib system consists of your own 2x4's (cut and drilled to our specs) and steel hubs on loan from **American Ingenuity** to erect a free standing geodesic framework. The "Rib System" dictates the exact panel placement. Once all the seams and options have been concreted the "Rib System" is removed and recycled into the interior framing and the hubs returned to us. Click on FAQ at the bottom of each web site page to see more information about the "Rib System".



The panel assembly process begins with positioning of the four foot high riser panels on the floor, aligning them with the rib system. The riser panels do not need expanding foam under them or any other sealant. Plumb the risers and fill any gaps between them with E.P.S. insulation wedges or expanding foam. Then overlap the steel mesh from adjoining riser panels, interlock the mesh with C-rings every 8" and apply the first coat of special formulated concrete.



The panel concrete is a special formulation containing synthetic fibers and liquid admixtures. We ship these same fibers and admixtures with your building kit. These ingredients improve the concrete's characteristics, create super toughness, extend durability, make concrete impervious to water, give higher tensile and compressive strength, provide elasticity for expansion, improve freeze protection. The concrete in your dome out performs other exteriors because of its specially developed formula. Because of its exceptional composition, it actually gains strength over the years. The Concrete Mix recipe for your seam concrete includes 5 gal of water, 1 bag Portland Cement (type 1 or 111), 2 oz. Admixture A, 5 oz Admixture B, ¼ large bag fibers, 20 gal. Sand (any sand normally used in either concrete or masonry).



The typical method for lifting the panels is by crane. Other lifting devices successfully employed by our dome owners include: a boom added to a tractor, a block and tackle, transverse fork lift, a hoist fastened to the top of the framework with wood ramps up the side of the dome, etc. Monthly rentals on transverse lifts also called Boom Lifts, Horizontal Boom Fork Lifts, Roofing Lifts, Shooters are available from National Rental Chains.





Here are some examples of a rolling scaffold being used to hoist and place panels. It is made from rented steel scaffolds with caster wheels. A boom made of 2x8 lumber is attached at the top and a hand crank boat winch pulls the lifting rope through pulleys and down to ground level. The wheels allow the panel to be rolled into place.



These photos illustrate the use of scaffolds on the exterior for filling and finishing seams and concreting the options. You install the panels and trowel concrete into the seams half way. Up to two rows of panels can be installed and seams concreted at one time.



This first photo illustrates exterior planking to allow for easier concrete work. The seams above are unfinished. To finish the seams, start at the top of the dome and work down. This will allow you to practice on easier seams and ones that are less visible and any spills will not be on finished work. The concrete seams are usually finished in one of three styles: **Straight:** The most time consuming, the most attractive at highlighting the geometry and well worth the extra effort. **Flat:** The quickest, the least cost and least labor intensive. **Rounded:** requires the most skill to be consistent but like the flat seam it can be completed with two coats. Finally a sponge is used to rub the seam concrete to produce a "sponge finish". This allows the seam finish to match the panel "sponge finish" texture.



Additional supports under the steel hubs are required to hold the weight until all the seams and options are concreted. Then the extra supports and temporary wooden rib system are removed. The dome shell is self supporting. Interior walls and second floor joists are conventionally built.



This photo illustrates a conventional interior wall covered with drywall. If the inside of the dome shell will be plastered, it is best to install all the framing and drywall first and plaster up to the drywall. If the inside of the dome shell will be covered with drywall, it is best to do the framing after the shell is drywalled. This subcontractor is applying fiber reinforced stucco directly to the E.P.S. insulation. On site the opening under the entryway was 2x4 framed and insulated with E.P.S..



An owner/builder is finishing her concreted seams with a sponge. The seam sponge finish matches the panel texture.



A finished dome prior to painting. This is a 34' dome home connected to a 22' dome one car garage. The high profile entryway was framed in to accept two windows, a door and fixed glass above the door and windows.



A 40' dome before painting.



During painting using a latex house paint.



The above dome is a 34' in diameter built on a full basement. Behind the deck railing is a standard entryway that was framed in on site to accept a door and window. This dome was painted a blue grey; however, you can paint your dome any color tan or moss green, etc.

Another finished American Ingenuity dome. The dome on the left has a standard entryway framed in to accept six small windows. The wall under the second floor dormer contains two small windows. And the cupola on top was framed in to accept five opening windows.

[Main](#)  
[Dome Pictures](#) | [Floor Plans](#)  
[Planning Kit / Video / Model Dome Kit](#)  
[Mail](#) | [Dome Prices](#) | [Specifications](#) | [FAQ](#) | [Maps](#)  
[Construction Cost Estimates](#)  
[Dome Home Financing](#) | [Dome Construction](#) | [Job Opportunities](#) | [Links](#)  
[The GEO POD - Utility Dome](#)

---

## AMERICAN INGENUITY, INC.

8777 Holiday Springs Road, Rockledge, Florida 32955-5805

PHONE: 321-639-8777 FAX: 321-639-8778

WEB: <http://www.aidomes.com> EMAIL: [info@aidomes.com](mailto:info@aidomes.com)

© Copyright 2002 [American Ingenuity Domes](#)  
[modular geodesic dome](#)



# AMERICAN INGENUITY

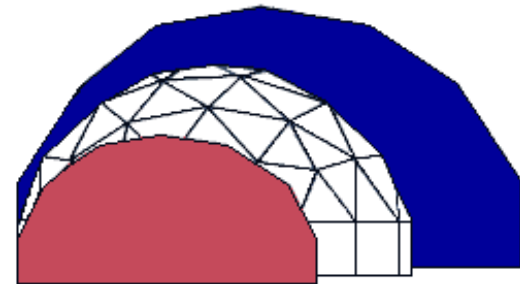

CREATING INTELLIGENT ALTERNATIVES

---

The Official Buckminster Fuller Site



---

More Buckminster Fuller Links and Related Sites

[A Fuller Explanation](#)

[R. Buckminster Fuller on Yahoo](#)

[Buckminster Fuller's Dymaxion House](#)

[The Planet's Friendly Genius](#)

[Synergetics](#)

[Dr. K. Eric Drexler's online version of "Engines of Creation"](#)

[Buckminster Fuller Virtual Institute](#)

---

American Ingenuity invites you to inspect some other major dome manufacturers.

[Timberline Geodesics](#)

[Oregon Domes](#)

[Monolithic Domes](#)

---

[Worldflower Garden Domes](#)

---

[Animated Ideas](#) -custom-made scale models of your home



---

[Architectural Designs](#)

competitively priced home plans from 60 architects and residential building designers

---

[EcoIQ.com](#) This green design and building website is for everyone interested in making smart choices about how we build our structures and infrastructure -- choices that are both economically and ecologically intelligent.

---

The House and Home Building Guide



[The Educated Home Buyer](#) - Provides unbiased tips and valuable resources for the home buyer. Explains how to choose and work with a mortgage lender and real estate agent. Built and maintained by a former mortgage loan officer.

---

[The Southern Designer](#)

---

Jim Salmon's Home Inspection website - contains home repair resources and online discussions boards.



[The Most Comprehensive Real Estate Directory on the Web](#)

Pick a State:

Alabama



[Stone River Hardwoods - Hardwood Floors & Flooring](#)

Stone River Hardwoods supplies high quality hardwood floors in various stains and widths, from standard to wide plank flooring.

---

[HomeBuildingPitfalls.com](http://HomeBuildingPitfalls.com) Get the insider's secrets you need in order to save thousands of dollars and get the high quality new home you deserve.

---



Arizona Specialty Woodcrafts - Woodworking Tools, Plans, Kits, Hardware

---

[Interior Doors Direct](#)

Hardwood interior doors sold direct to consumers and builders.  
Raised panel, flat panel, and divided lite french doors.

---

<http://www.realestateabc.com>

---

[StartRemodeling.com](#)

---

Professional Education Associates - Environmental, real estate, and land use publications - consulting and education seminars, including "The Real Estate Guide to the Environment" for real estate professionals and "The Home and Land Buyer's Guide to the Environment" for consumers.

<http://www.erols.com/profed>

---

[National Hurricane Center - Tropical Prediction Center](#)

---



[Homepower.com](#)

"The Hands-On Journal of Home-Made Power."

---

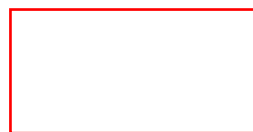

[modular geodesic dome](#)

Monitor this website for changes <http://www.changedetection.com>

[Main](#)

[Dome Pictures](#) | [Floor Plans](#)

[Planning Kit / Video / Model Dome Kit](#)

[Mail](#) | [Dome Prices](#) | [Specifications](#) | [FAQ](#) | [Maps](#)  
[Construction Cost Estimates](#)  
[Dome Home Financing](#) | [Dome Construction](#) | [Job Opportunities](#) | [Links](#)

[The GEO POD - Utility Dome](#)

AMERICAN INGENUITY, INC.

8777 Holiday Springs Road, Rockledge, Florida 32955-5805

PHONE: 321-639-8777 FAX: 321-639-8778

Established in 1976

WEB: <http://www.aidomes.com> EMAIL: [info@aidomes.com](mailto:info@aidomes.com)

Â© Copyright 2002 [American Ingenuity Domes](#)

# AMERICAN INGENUITY



## Utility Dome Kit - The GEO POD

Compare the American Ingenuity Geo Pod to high maintenance storage buildings, tents, and yurts. The Geo Pod utility dome withstands hurricanes, tornados, earthquakes, and forest fires much better than conventional storage sheds. Engineered with super-insulated, nearly indestructible materials, it's the perfect solution for remote storage and temporary housing needs. And, like all of our award-winning structurally superior domes, the Geo Pod will provide decades and decades of maintenance-free service, flexibility, security, and expandability.



(Doors not included)

The Geo Pod has a diameter of 12 feet and gives you 116 square feet of utility space for only \$349 plus shipping. The Geo Pod ships UPS in 6 boxes using the 70-pound oversize rule.

Pod construction requires the assembly of the EPS foam panels and coating of the panels with a mixture of cement, sand, and provided admixture. Recommended, but not required, is the construction of a concrete slab. Builders can expect to spend more than one day assembling their Geo Pod.



[GEO POD Construction Manual](#)



To order, please call 321-639-8777.

[Main](#)  
[Dome Pictures](#) | [Floor Plans](#)  
[Planning Kit / Video / Model Dome Kit](#)  
[Mail](#) | [Dome Prices](#) | [Specifications](#) | [FAQ](#) | [Maps](#)  
[Construction Cost Estimates](#) | [Dome Home Financing](#) | [Dome Construction](#) | [Links](#)

## AMERICAN INGENUITY, INC.

8777 Holiday Springs Road, Rockledge, Florida 32955-5805

PHONE: 321-639-8777 FAX: 321-639-8778

Established in 1976

WEB: <http://www.aidomes.com> EMAIL: [info@aidomes.com](mailto:info@aidomes.com)

© Copyright 2002 [American Ingenuity Domes](#)  
[modular geodesic dome](#)



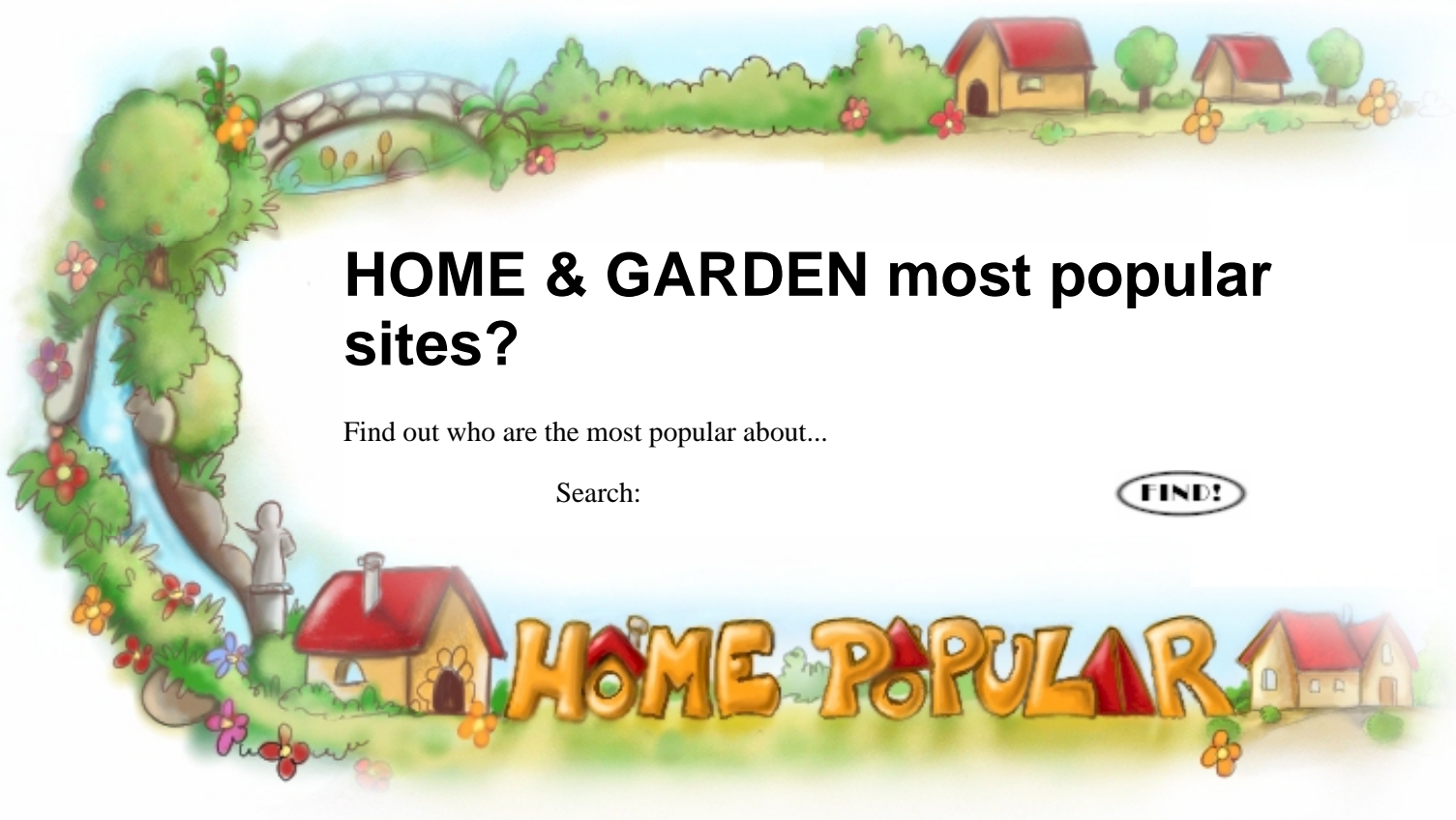

## HOME & GARDEN most popular sites?

Find out who are the most popular about...

Search:

**FIND!**

[House Plans](#) | [Home Building](#) | [Gardening](#) | [Real Estate](#) | [Financing](#)  
[Home Improvement](#) | [Home Decorating](#) | [Furniture](#) | [Home Security](#) | [Shopping](#)

**NEED CONTRACTOR**

**ASK REALS**

**HouseReal**

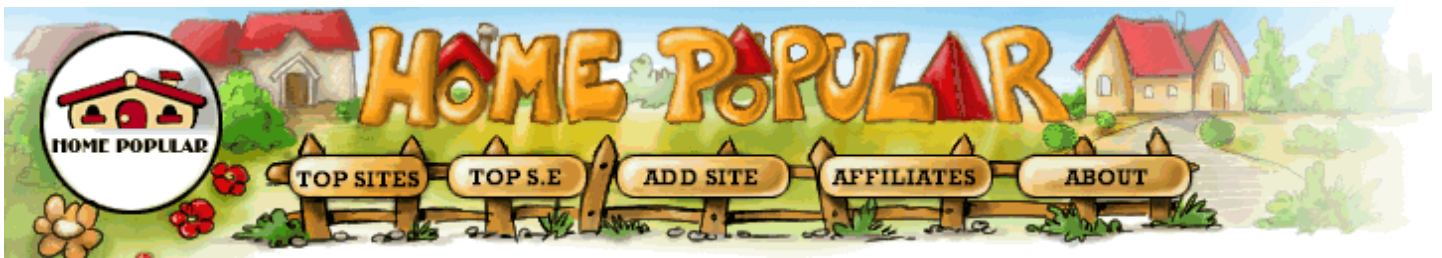

Search:



## Your search was empty!

Please perform a different search, with a keyword having at least 3 characters.

Thank You.

©Copyright  CYBERTONIC All rights reserved.

**sell my home for sale by owner, real estate listing, real estate sale by owner, house for sale by owner, buying a home, agent services and more.**

**HOMESalez.com™**  
YOUR NEXT MOVE

*When it comes to real estate everyone knows the importance of location!*

Now there's a new address for buyers, sellers, agents, for sale by owner and companies eager to publicize their properties & respective services! How can I sell my home? Try these sites...

[United States](#)  [Canada](#)  [Australia](#)  [United Kingdom](#) 

**HomeSalez.com has home for sale by owner, residential real estate sale and property for sale around the world. We help real estate agents and owners sell cottage, sell land, sell house for sale, sell home for sale real estate listing for sale by owner or buying a home.**

**sell my home or buying a home try our  
home search property search home finder  
service**













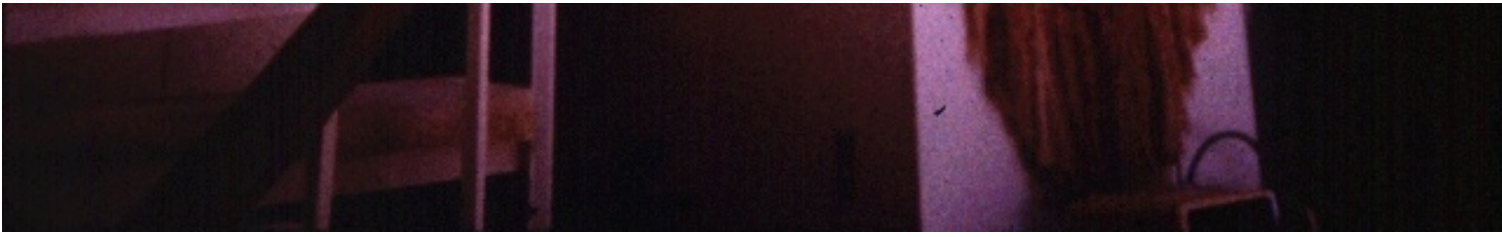



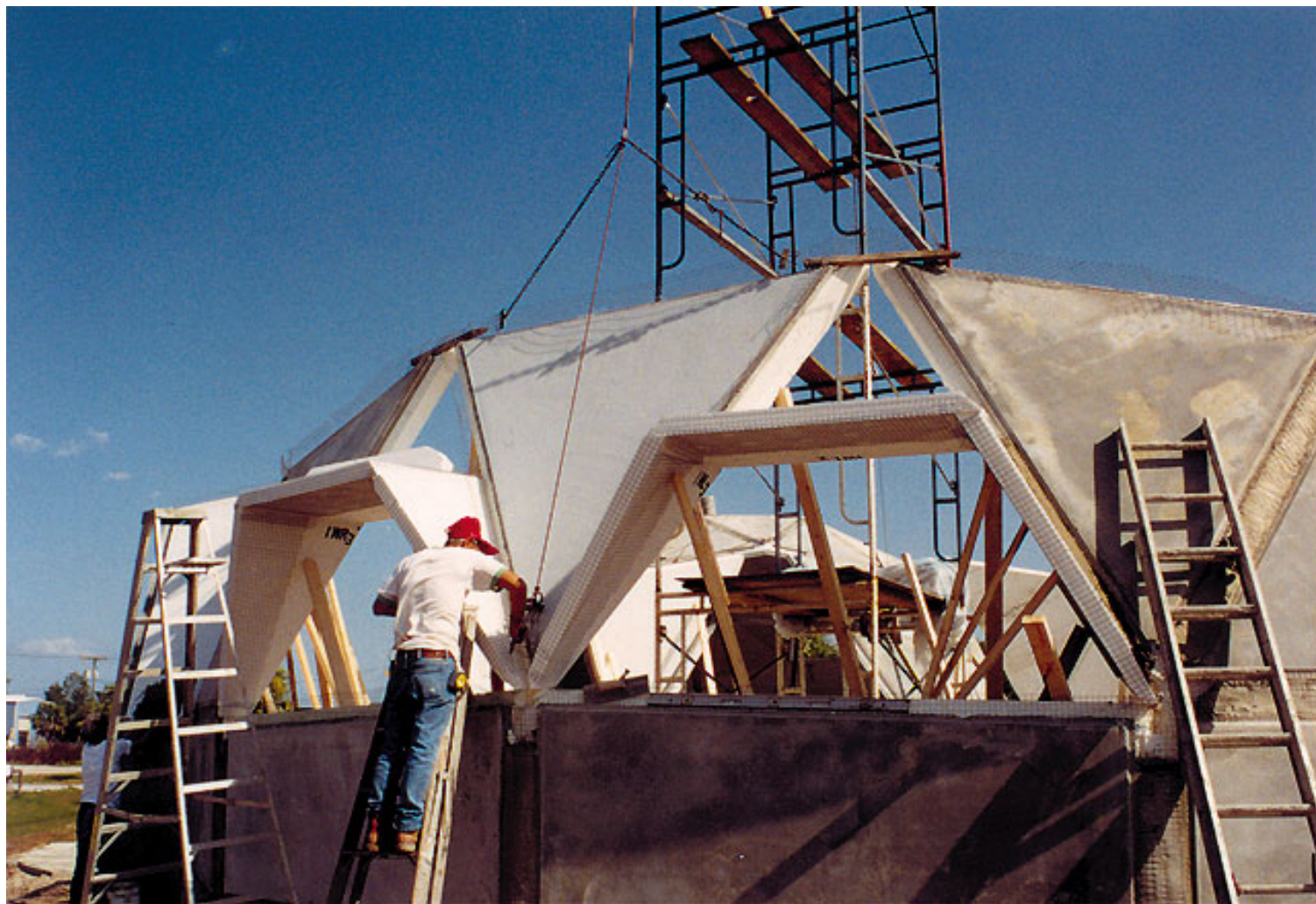

[Planning Kit](#)Code: **PK**Price: **\$9.00**Quantity in Basket: *none*

Discover and research the American Ingenuity concept of dome living. The Planning Kit includes: NEW PERSPECTIVES IN LIVING a 12 PAGE COLOR BROCHURE Learn about the development of our component panel dome shell kit, American Ingenuity advantages, Domeowner's Warranty, panel description, kit assembly, kit contents, kit options, design possibilities, plan design - 40 color photos - 4 drawings - 8½" x 11".

[Video](#)Code: **V**Price: **\$6.00**Quantity in Basket: *none*

Tour dozens of American Ingenuity domes to help you visualize your new dome - Various settings across the country from the desert to the mountains to the seashore - Shows advantages, manufacturing, design possibilities, shell kit assembly, kit options, interior finish - Interiors & exteriors - 21 minutes plus Inside Edition segment.

[Model Dome Kit](#)Code: **MDK**Price: **\$27.00**Quantity in Basket: *none*

Puts into perspective the actual living space inside the American Ingenuity domes by constructing a 3-D scale model of your dream home as you envision it. The plastic ribs and hubs when assembled form a representational, see-thru geodesic skeleton. Foam board is provided for walls, floors, entryways, and dormers requiring cutting and fitting. Scaled, 2-D furniture for each size dome. 24" diameter x 15" high when assembled.

# 48 DELTA W

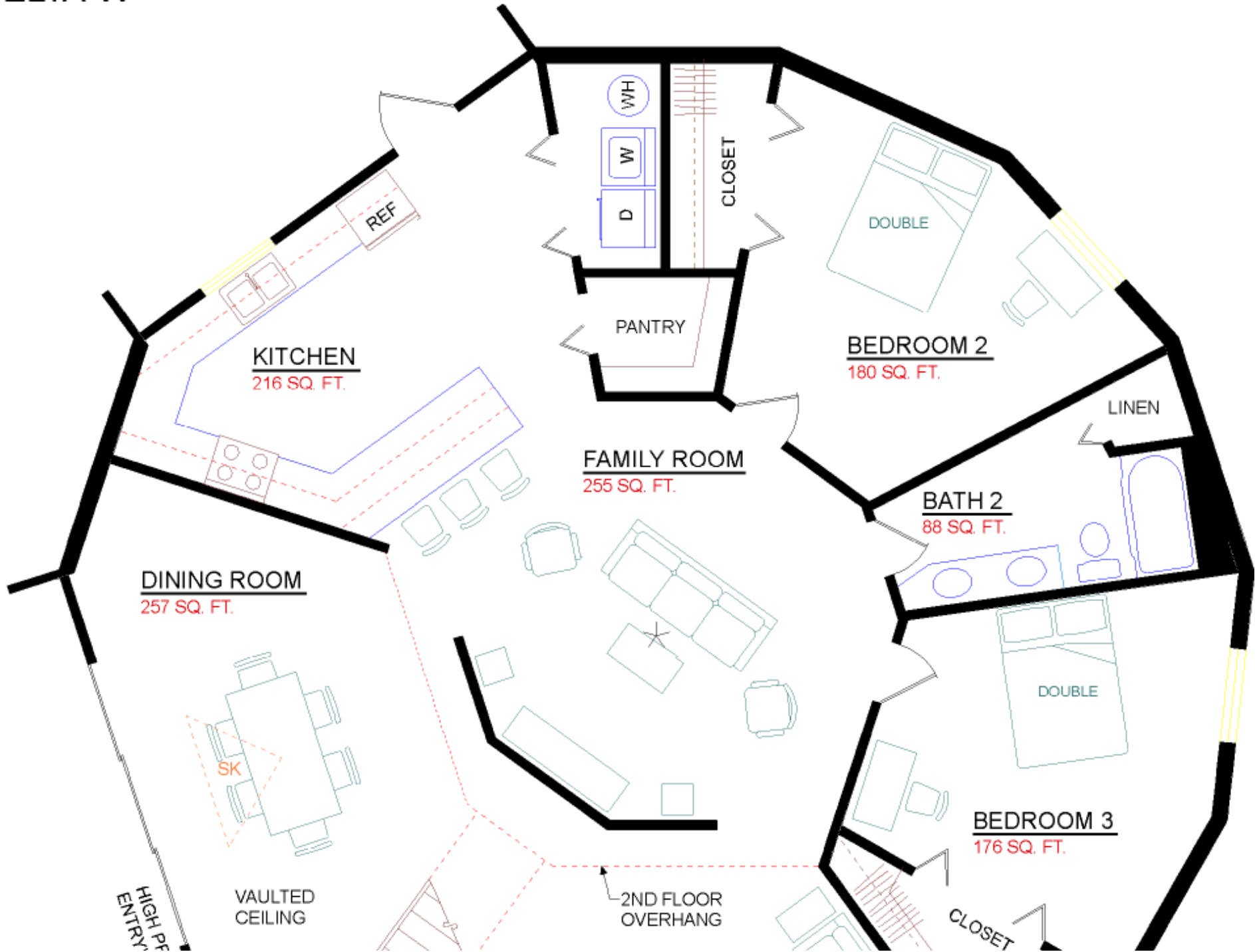

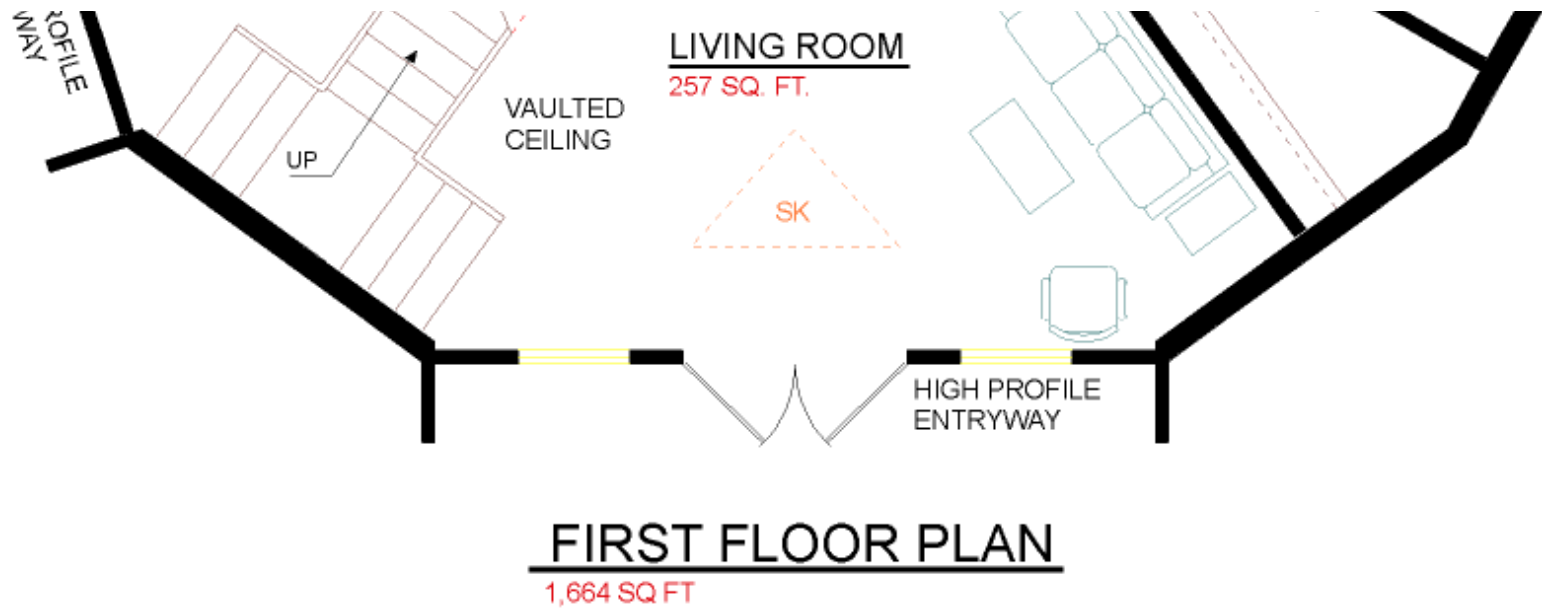



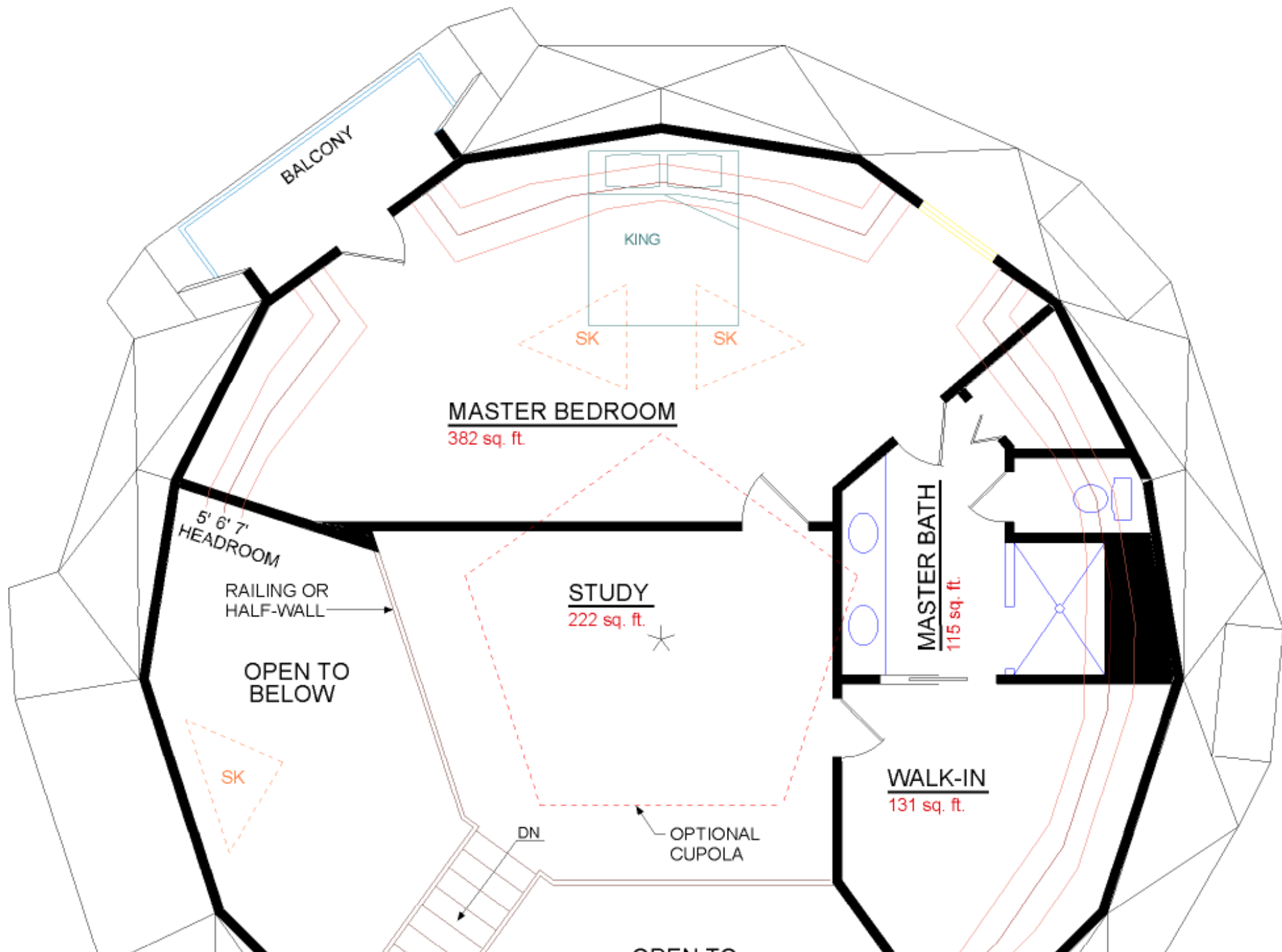

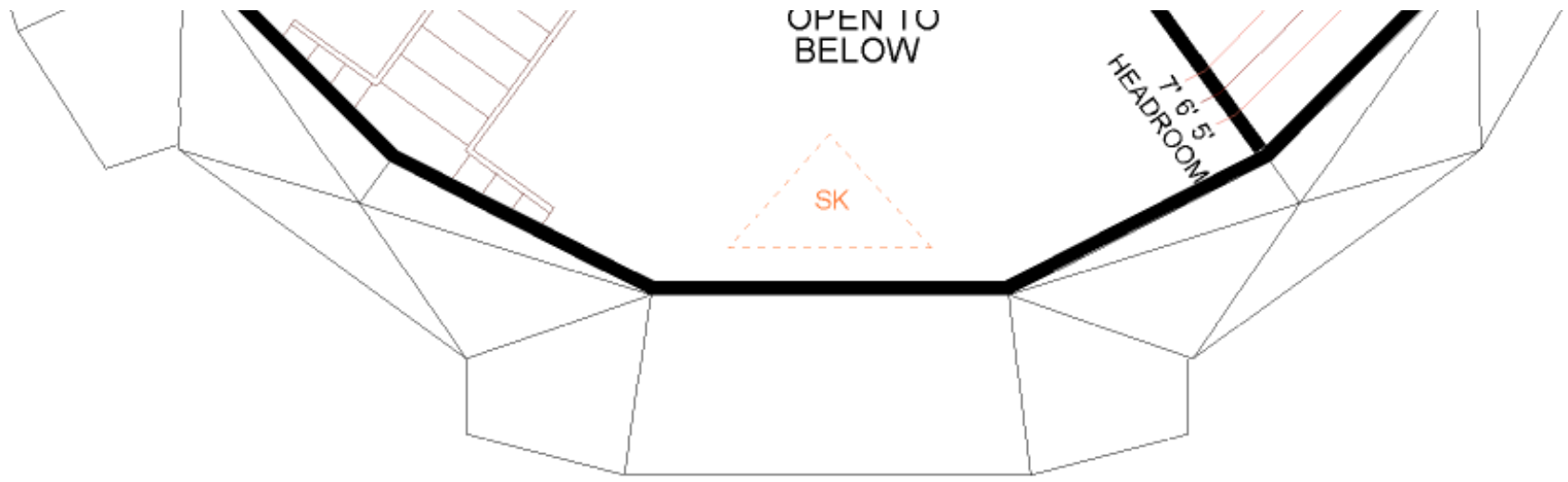

**SECOND FLOOR PLAN**  
905 SQ FT

0  
SECTION  
2  
HEADER  
9  
\$ACADVER  
1  
AC1009  
9  
\$INSBASE  
10  
0.0  
20  
0.0  
30  
0.0  
9  
\$EXTMIN  
10  
4328.357352  
20  
4260.376275  
30  
0.0  
9  
\$EXTMAX  
10  
5536.153732  
20  
5091.24841  
30  
0.0  
9  
\$LIMMIN  
10  
0.0  
20  
0.0  
9  
\$LIMMAX  
10  
12.0  
20  
9.0  
9  
\$ORTHOMODE  
70  
0  
9  
\$REGENMODE  
70  
1  
9  
\$FILLMODE  
70  
1  
9  
\$QTEXTMODE  
70  
0  
9

\$MIRRTEXT

70

1

9

\$DRAGMODE

70

2

9

\$LTSCALE

40

1.0

9

\$OSMODE

70

0

9

\$ATTMODE

70

1

9

\$TEXTSIZE

40

0.2

9

\$TRACEWID

40

0.05

9

\$TEXTSTYLE

7

STANDARD

9

\$CLAYER

8

0

9

\$CELTYPE

6

BYLAYER

9

\$CECOLOR

62

256

9

\$DIMSCALE

40

1.0

9

\$DIMASZ

40

0.18

9

\$DIMEXO

40

0.0625

9

\$DIMDLI

40

0.38

9

\$DIMRND

40  
0.0  
9  
\$DIMDLE  
40  
0.0  
9  
\$DIMEXE  
40  
0.18  
9  
\$DIMTP  
40  
0.0  
9  
\$DIMTM  
40  
0.0  
9  
\$DIMTXT  
40  
0.18  
9  
\$DIMCEN  
40  
0.09  
9  
\$DIMTSZ  
40  
0.0  
9  
\$DIMTOL  
70  
0  
9  
\$DIMLIM  
70  
0  
9  
\$DIMTIH  
70  
1  
9  
\$DIMTOH  
70  
1  
9  
\$DIMSE1  
70  
0  
9  
\$DIMSE2  
70  
0  
9  
\$DIMITAD  
70  
0  
9  
\$DIMZIN  
70

0

9

\$DIMBLK

1

9

\$DIMASO

70

1

9

\$DIMSHO

70

1

9

\$DIMPOST

1

9

\$DIMAPOST

1

9

\$DIMALT

70

0

9

\$DIMALTD

70

2

9

\$DIMALTF

40

25.4

9

\$DIMLFAC

40

1.0

9

\$DIMTOFL

70

0

9

\$DIMITVP

40

0.0

9

\$DIMITIX

70

0

9

\$DIMSOXD

70

0

9

\$DIMSAH

70

0

9

\$DIMBLK1

1

9  
\$DIMBLK2  
1

9  
\$DIMSTYLE  
2  
STANDARD  
9  
\$DIMCLRD  
70  
0

9  
\$DIMCLRE  
70  
0

9  
\$DIMCLRT  
70  
0

9  
\$DIMTFAC  
40  
1.0  
9

9  
\$DIMGAP  
40  
0.09  
9

9  
\$LUNITS  
70  
2

9  
\$LUPREC  
70  
4

9  
\$SKETCHINC  
40  
0.1  
9

9  
\$FILLETRAD  
40  
0.5  
9

9  
\$AUNITS  
70  
0

9  
\$AUPREC  
70  
0

9  
\$MENU  
1  
.

9  
\$ELEVATION  
40  
0.0  
9

\$PELEVATION  
40  
0.0  
9  
\$THICKNESS  
40  
0.0  
9  
\$LIMCHECK  
70  
0  
9  
\$BLIPMODE  
70  
0  
9  
\$CHAMFERA  
40  
0.5  
9  
\$CHAMFERB  
40  
0.5  
9  
\$SKPOLY  
70  
0  
9  
\$TDCREATE  
40  
2452222.678566  
9  
\$TDUPDATE  
40  
2452222.678566  
9  
\$TDINDWG  
40  
0.0  
9  
\$TDUSRTIMER  
40  
0.0  
9  
\$USRTIMER  
70  
1  
9  
\$ANGBASE  
50  
0.0  
9  
\$ANGDIR  
70  
0  
9  
\$PDMODE  
70  
0  
9  
\$PDSIZE



40  
0.0  
9  
\$PLINEWID  
40  
0.0  
9  
\$COORDS  
70  
1  
9  
\$SPLFRAME  
70  
0  
9  
\$SPLINETYPE  
70  
6  
9  
\$SPLINESEGS  
70  
8  
9  
\$ATTDIA  
70  
0  
9  
\$ATTREQ  
70  
1  
9  
\$HANDLING  
70  
1  
9  
\$HANDSEED  
5  
10173  
9  
\$SURFTAB1  
70  
6  
9  
\$SURFTAB2  
70  
6  
9  
\$SURFTYPE  
70  
6  
9  
\$SURFU  
70  
6  
9  
\$SURFV  
70  
6  
9  
\$UCSNAME  
2

9  
\$UCSORG  
10  
0.0  
20  
0.0  
30  
0.0  
9  
\$UCSXHR  
10  
1.0  
20  
0.0  
30  
0.0  
9  
\$UCSYDIR  
10  
0.0  
20  
1.0  
30  
0.0  
9  
\$PUCSNAME  
2

9  
\$PUCSORG  
10  
0.0  
20  
0.0  
30  
0.0  
9  
\$PUCSXHR  
10  
1.0  
20  
0.0  
30  
0.0  
9  
\$PUCSYDIR  
10  
0.0  
20  
1.0  
30  
0.0  
9  
\$USERI1  
70  
0  
9  
\$USERI2  
70  
0

```
9
$USERI3
70
0
9
$USERI4
70
0
9
$USERI5
70
0
9
$USERR1
40
0.0
9
$USERR2
40
0.0
9
$USERR3
40
0.0
9
$USERR4
40
0.0
9
$USERR5
40
0.0
9
$WORLDVIEW
70
1
9
$SHADEDGE
70
3
9
$SHADEDIF
70
70
9
$TILEMODE
70
1
9
$MAXACTVP
70
48
9
$PLIMCHECK
70
0
9
$PEXTMIN
10
1.000000E+020
20
```

1.000000E+020  
30  
1.000000E+020  
9  
\$PEXTMAX  
10  
-1.000000E+020  
20  
-1.000000E+020  
30  
-1.000000E+020  
9  
\$PLIMMIN  
10  
0.0  
20  
0.0  
9  
\$PLIMMAX  
10  
12.0  
20  
9.0  
9  
\$UNITMODE  
70  
0  
9  
\$VISRETAIN  
70  
1  
9  
\$PLINEGEN  
70  
0  
9  
\$PSLTSCALE  
70  
1  
0  
ENDSEC  
0  
SECTION  
2  
TABLES  
0  
TABLE  
2  
VPORT  
70  
3  
0  
VPORT  
2  
\*ACTIVE  
70  
0  
10  
0.0  
20  
0.0

11  
1.0  
21  
1.0  
12  
4932.255542  
22  
4675.812342  
13  
0.0  
23  
0.0  
14  
0.5  
24  
0.5  
15  
0.5  
25  
0.5  
16  
0.0  
26  
0.0  
36  
1.0  
17  
0.0  
27  
0.0  
37  
0.0  
40  
840.019351  
41  
1.700368  
42  
50.0  
43  
0.0  
44  
0.0  
50  
0.0  
51  
0.0  
71  
0  
72  
100  
73  
1  
74  
1  
75  
0  
76  
0  
77  
0  
78

```
0
0
ENDTAB
0
TABLE
2
LTYPE
70
2
0
LTYPE
2
CONTINUOUS
70
0
3
Solid line
72
65
73
0
40
0.0
0
LTYPE
2
HIDDEN
70
0
3
-----
72
65
73
2
40
0.375
49
0.25
49
-0.125
0
ENDTAB
0
TABLE
2
LAYER
70
254
0
LAYER
2
0
70
0
62
7
6
CONTINUOUS
0
LAYER
```

2  
1FLR  
70  
0  
62  
7  
6  
CONTINUOUS  
0  
LAYER  
2  
1WD  
70  
0  
62  
9  
6  
CONTINUOUS  
0  
LAYER  
2  
1W  
70  
0  
62  
9  
6  
CONTINUOUS  
0  
LAYER  
2  
1STR  
70  
0  
62  
11  
6  
CONTINUOUS  
0  
LAYER  
2  
1CP  
70  
0  
62  
4  
6  
CONTINUOUS  
0  
LAYER  
2  
1TXT  
70  
0  
62  
14  
6  
CONTINUOUS  
0  
LAYER  
2

1DIM  
70  
0  
62  
9  
6  
CONTINUOUS  
0  
LAYER  
2  
1HDN  
70  
0  
62  
11  
6  
HIDDEN  
0  
LAYER  
2  
2FLR  
70  
0  
62  
6  
6  
CONTINUOUS  
0  
LAYER  
2  
2WD  
70  
0  
62  
9  
6  
CONTINUOUS  
0  
LAYER  
2  
2W  
70  
0  
62  
9  
6  
CONTINUOUS  
0  
LAYER  
2  
2STR  
70  
0  
62  
11  
6  
CONTINUOUS  
0  
LAYER  
2  
2CP



70  
0  
62  
4  
6  
CONTINUOUS  
0  
LAYER  
2  
2TXT  
70  
0  
62  
4  
6  
CONTINUOUS  
0  
LAYER  
2  
2DIM  
70  
0  
62  
9  
6  
CONTINUOUS  
0  
LAYER  
2  
7FT  
70  
0  
62  
13  
6  
CONTINUOUS  
0  
LAYER  
2  
6FT  
70  
0  
62  
13  
6  
CONTINUOUS  
0  
LAYER  
2  
5FT  
70  
0  
62  
13  
6  
CONTINUOUS  
0  
LAYER  
2  
2HDN  
70

0  
62  
11  
6  
HIDDEN  
0  
LAYER  
2  
1SOLID  
70  
0  
62  
7  
6  
CONTINUOUS  
0  
LAYER  
2  
2NDB  
70  
0  
62  
6  
6  
CONTINUOUS  
0  
LAYER  
2  
2SOLID  
70  
0  
62  
6  
6  
CONTINUOUS  
0  
LAYER  
2  
FUR  
70  
0  
62  
15  
6  
CONTINUOUS  
0  
LAYER  
2  
TEXT1  
70  
0  
62  
4  
6  
CONTINUOUS  
0  
ENDTAB  
0  
TABLE  
2  
STYLE

70  
19  
0  
STYLE  
2  
STANDARD  
70  
0  
40  
0.0  
41  
1.0  
50  
0.0  
71  
0  
42  
0.2  
3  
txt  
4

0  
STYLE  
2  
ROMANS  
70  
0  
40  
0.0  
41  
0.75  
50  
0.0  
71  
0  
42  
5.0  
3  
romans  
4

0  
STYLE  
2  
TAHOMA  
70  
0  
40  
0.0  
41  
1.0  
50  
0.0  
71  
0  
42  
8.0  
3  
txt  
4

0  
ENDTAB  
0  
TABLE  
2  
VIEW  
70  
1  
0  
VIEW  
2  
OLE1  
70  
0  
40  
797.907929  
10  
83.131331  
20  
694.44191  
41  
1356.736828  
11  
0.0  
21  
0.0  
31  
1.0  
12  
0.0  
22  
0.0  
32  
0.0  
42  
50.0  
43  
0.0  
44  
0.0  
50  
0.0  
71  
0  
0  
ENDTAB  
0  
TABLE  
2  
UCS  
70  
0  
0  
ENDTAB  
0  
TABLE  
2  
APPID  
70  
1

0  
APPID  
2  
ACAD  
70  
0  
0  
ENDTAB  
0  
TABLE  
2  
DIMSTYLE  
70  
1  
0  
DIMSTYLE  
2  
STANDARD  
70  
0  
3  
4  
5  
6  
7  
40  
1.0  
41  
0.18  
42  
0.0625  
43  
0.38  
44  
0.18  
45  
0.0  
46  
0.0  
47  
0.0  
48  
0.0  
140  
0.18  
141  
0.09  
142  
0.0  
143  
25.4  
144  
1.0  
145  
0.0  
146

1.0  
147  
0.09  
71  
0  
72  
0  
73  
1  
74  
1  
75  
0  
76  
0  
77  
0  
78  
0  
170  
0  
171  
2  
172  
0  
173  
0  
174  
0  
175  
0  
176  
0  
177  
0  
178  
0  
0  
ENDTAB  
0  
ENDSEC  
0  
SECTION  
2  
BLOCKS  
0  
BLOCK  
8  
0  
2  
\$MODEL\_SPACE  
70  
0  
10  
0.0  
20  
0.0  
30  
0.0  
3  
\$MODEL\_SPACE

```
1
0
ENDBLK
5
1A
8
0
0
BLOCK
67
1
8
0
2
$PAPER_SPACE
70
0
10
0.0
20
0.0
30
0.0
3
$PAPER_SPACE
1
0
ENDBLK
5
17
67
1
8
0
0
BLOCK
8
0
2
D
70
0
10
5.967081
20
9.580194
30
0.0
3
D
1
0
CIRCLE
5
47
8
0
10
```

5.967081

20

9.580194

30

0.0

40

0.126908

0

ENDBLK

5

49

8

0

0

BLOCK

8

0

2

RVKZ

70

0

10

0.0

20

0.0

30

0.0

3

RVKZ

1

0

LINE

5

1E48

8

0

10

28.966007

20

-29.196261

30

0.0

11

28.966007

21

-28.220448

31

0.0

0

LINE

5

1E49

8

0

10

10.157046

20

-30.592494

30

0.0



11  
10.157046  
21  
-29.196261  
31  
0.0  
0  
LINE  
5  
1E4A  
8  
0  
10  
9.032276  
20  
-30.592494  
30  
0.0  
11  
10.157046  
21  
-30.592494  
31  
0.0  
0  
LINE  
5  
1E4B  
8  
0  
10  
9.032276  
20  
-28.220448  
30  
0.0  
11  
9.032276  
21  
-30.592494  
31  
0.0  
0  
LINE  
5  
1E4C  
8  
0  
10  
10.157046  
20  
-29.196261  
30  
0.0  
11  
28.966007  
21  
-29.196261  
31  
0.0  
0

ARC  
5  
1E4D  
8  
0  
10  
-18.579733  
20  
-22.579431  
30  
0.0  
40  
2.0  
50  
180.0  
51  
270.0  
0  
ARC  
5  
1E4E  
8  
0  
10  
-18.579733  
20  
-11.409846  
30  
0.0  
40  
2.0  
50  
90.0  
51  
180.0  
0  
ARC  
5  
1E4F  
8  
0  
10  
-3.181702  
20  
-11.409846  
30  
0.0  
40  
2.0  
50  
0.0  
51  
90.0  
0  
ARC  
5  
1E50  
8  
0  
10  
-3.181702

20  
-22.579431  
30  
0.0  
40  
2.0  
50  
270.0  
51  
0.0  
0

LINE

5  
1E51  
8  
0  
10  
-20.579733  
20  
-11.409846  
30  
0.0  
11  
-20.579733  
21  
-22.579431  
31  
0.0  
0

LINE

5  
1E52  
8  
0  
10  
-18.579733  
20  
-24.579431  
30  
0.0  
11  
-3.181702  
21  
-24.579431  
31  
0.0  
0

LINE

5  
1E53  
8  
0  
10  
-1.181702  
20  
-11.409846  
30  
0.0  
11  
-1.181702  
21

-22.579431

31

0.0

0

LINE

5

1E54

8

0

10

-18.579733

20

-9.409846

30

0.0

11

-3.181702

21

-9.409846

31

0.0

0

LINE

5

1E55

8

0

10

3.119283

20

-7.167052

30

0.0

11

-24.880717

21

-7.167052

31

0.0

0

LINE

5

1E56

8

0

10

32.973524

20

-7.167052

30

0.0

11

4.973524

21

-7.167052

31

0.0

0

LINE

5

1E57

8  
0  
10  
-24.880717  
20  
-2.220448  
30  
0.0  
11  
-24.880717  
21  
-28.220448  
31  
0.0  
0

LINE

5  
1E58  
8  
0  
10  
3.119283  
20  
-2.220448  
30  
0.0  
11  
-24.880717  
21  
-2.220448  
31  
0.0  
0

LINE

5  
1E59  
8  
0  
10  
3.119283  
20  
-28.220448  
30  
0.0  
11  
3.119283  
21  
-2.220448  
31  
0.0  
0

LINE

5  
1E5A  
8  
0  
10  
-24.880717  
20  
-28.220448  
30

0.0  
11  
3.119283  
21  
-28.220448  
31  
0.0  
0  
LINE  
5  
1E5B  
8  
0  
10  
4.973524  
20  
-2.220448  
30  
0.0  
11  
4.973524  
21  
-28.220448  
31  
0.0  
0  
LINE  
5  
1E5C  
8  
0  
10  
32.973524  
20  
-2.220448  
30  
0.0  
11  
4.973524  
21  
-2.220448  
31  
0.0  
0  
LINE  
5  
1E5D  
8  
0  
10  
32.973524  
20  
-28.220448  
30  
0.0  
11  
32.973524  
21  
-2.220448  
31  
0.0

```
0
LINE
5
1E5E
8
0
10
4.973524
20
-28.220448
30
0.0
11
32.973524
21
-28.220448
31
0.0
0
ENDBLK
5
1E60
8
0
0
BLOCK
8
0
2
RVK000
70
0
10
0.0
20
0.0
30
0.0
3
RVK000
1
0
POLYLINE
5
C707
8
0
66
1
10
0.0
20
0.0
30
0.0
70
1
0
VERTEX
5
```

10049  
8  
0  
10  
-17.973133  
20  
-10.592392  
30  
0.0  
0

VERTEX

5  
1004A  
8  
0  
10  
22.026867  
20  
-10.592392  
30  
0.0  
0

VERTEX

5  
1004B  
8  
0  
10  
22.026867  
20  
9.407608  
30  
0.0  
0

VERTEX

5  
1004C  
8  
0  
10  
-17.973133  
20  
9.407608  
30  
0.0  
0

SEQEND

5  
1004D  
8  
0  
0

LINE

5  
C708  
8  
0  
10  
7.217473  
20  
-13.409939



30  
0.0  
11  
-4.443928  
21  
-13.409939  
31  
0.0  
0  
ARC  
5  
C709  
8  
0  
10  
1.386772  
20  
-14.0002  
30  
0.0  
40  
18.5  
50  
248.436041  
51  
291.563959  
0  
ARC  
5  
C70A  
8  
0  
10  
1.386772  
20  
-14.0002  
30  
0.0  
40  
16.5  
50  
248.436036  
51  
291.563954  
0  
LINE  
5  
C70B  
8  
0  
10  
6.038901  
20  
-27.409939  
30  
0.0  
11  
-3.265357  
21  
-27.409939  
31

0.0  
0  
ARC  
5  
C70C  
8  
0  
10  
-5.045171  
20  
-30.275338  
30  
0.0  
40  
1.0  
50  
68.436041  
51  
248.436041  
0  
ARC  
5  
C70D  
8  
0  
10  
-3.265357  
20  
-25.909939  
30  
0.0  
40  
1.5  
50  
186.115504  
51  
270.0  
0  
ARC  
5  
C70E  
8  
0  
10  
-4.443928  
20  
-14.909939  
30  
0.0  
40  
1.5  
50  
90.0  
51  
186.115504  
0  
LINE  
5  
C70F  
8  
0

10  
-5.935392  
20  
-15.069739  
30  
0.0  
11  
-4.756821  
21  
-26.069739  
31  
0.0  
0  
ARC  
5  
C710  
8  
0  
10  
7.818715  
20  
-30.275338  
30  
0.0  
40  
1.0  
50  
291.563959  
51  
111.563959  
0  
ARC  
5  
C711  
8  
0  
10  
6.038901  
20  
-25.909939  
30  
0.0  
40  
1.5  
50  
270.0  
51  
353.884496  
0  
ARC  
5  
C712  
8  
0  
10  
7.217473  
20  
-14.909939  
30  
0.0  
40

1.5  
50  
353.884496  
51  
90.0  
0  
LINE  
5  
C713  
8  
0  
10  
7.530365  
20  
-26.069739  
30  
0.0  
11  
8.708936  
21  
-15.069739  
31  
0.0  
0  
ENDBLK  
5  
C715  
8  
0  
0  
BLOCK  
8  
0  
2  
SK1419  
70  
0  
10  
0.0  
20  
0.0  
30  
0.0  
3  
SK1419  
1  
0  
POLYLINE  
5  
F00B  
8  
0  
66  
1  
10  
0.0  
20  
0.0  
30  
0.0

70  
1  
0  
VERTEX  
5  
100B2  
8  
0  
10  
1.270778  
20  
9.398729  
30  
0.0  
42  
0.127517  
0  
VERTEX  
5  
100B3  
8  
0  
10  
1.943443  
20  
6.80407  
30  
0.0  
42  
0.106161  
0  
VERTEX  
5  
100B4  
8  
0  
10  
4.053264  
20  
4.392992  
30  
0.0  
42  
0.085463  
0  
VERTEX  
5  
100B5  
8  
0  
10  
7.023183  
20  
2.884763  
30  
0.0  
42  
0.074986  
0  
VERTEX  
5

100B6  
8  
0  
10  
10.770778  
20  
2.319549  
30  
0.0  
42  
0.074986  
0  
VERTEX  
5  
100B7  
8  
0  
10  
14.518373  
20  
2.884763  
30  
0.0  
42  
0.085463  
0  
VERTEX  
5  
100B8  
8  
0  
10  
17.488293  
20  
4.392992  
30  
0.0  
42  
0.106161  
0  
VERTEX  
5  
100B9  
8  
0  
10  
19.598113  
20  
6.80407  
30  
0.0  
42  
0.127517  
0  
VERTEX  
5  
100BA  
8  
0  
10  
20.270778

20  
9.398729  
30  
0.0  
42  
0.127517  
0  
VERTEX  
5  
100BB  
8  
0  
10  
19.598113  
20  
11.993387  
30  
0.0  
42  
0.106161  
0  
VERTEX  
5  
100BC  
8  
0  
10  
17.488293  
20  
14.404465  
30  
0.0  
42  
0.085463  
0  
VERTEX  
5  
100BD  
8  
0  
10  
14.518373  
20  
15.912694  
30  
0.0  
42  
0.074986  
0  
VERTEX  
5  
100BE  
8  
0  
10  
10.770778  
20  
16.477908  
30  
0.0  
42

0.074986  
0  
VERTEX  
5  
100BF  
8  
0  
10  
7.023183  
20  
15.912694  
30  
0.0  
42  
0.085463  
0  
VERTEX  
5  
100C0  
8  
0  
10  
4.053264  
20  
14.404465  
30  
0.0  
42  
0.106161  
0  
VERTEX  
5  
100C1  
8  
0  
10  
1.943443  
20  
11.993387  
30  
0.0  
42  
0.127517  
0  
SEQEND  
5  
100C2  
8  
0  
0  
ENDBLK  
5  
F00D  
8  
0  
0  
BLOCK  
8  
0  
2  
D24



70  
0  
10  
0.0  
20  
0.0  
30  
0.0  
3  
D24  
1  
  
0  
ARC  
5  
F00F  
8  
0  
10  
0.0  
20  
0.0  
30  
0.0  
40  
28.0  
50  
0.0  
51  
47.905695  
0  
LINE  
5  
F010  
8  
0  
10  
0.70537  
20  
-0.708839  
30  
0.0  
11  
20.540198  
21  
19.028933  
31  
0.0  
0  
LINE  
5  
F011  
8  
0  
10  
0.0  
20  
0.0  
30  
0.0  
11

19.847489

21

19.750371

31

0.0

0

ENDBLK

5

F013

8

0

0

BLOCK

8

0

2

D26

70

0

10

0.0

20

0.0

30

0.0

3

D26

1

0

LINE

5

F015

8

0

10

0.70537

20

-0.708839

30

0.0

11

21.95872

21

20.440514

31

0.0

0

ARC

5

F016

8

0

10

0.0

20

0.0

30

0.0

40

30.0

50  
0.0  
51  
47.705014  
0  
LINE  
5  
F017  
8  
0  
10  
0.0  
20  
0.0  
30  
0.0  
11  
21.265167  
21  
21.161112  
31  
0.0  
0  
ENDBLK  
5  
F019  
8  
0  
0  
BLOCK  
8  
0  
2  
D20  
70  
0  
10  
0.0  
20  
0.0  
30  
0.0  
3  
D20  
1  
0  
LINE  
5  
F01B  
8  
0  
10  
0.70537  
20  
-0.708839  
30  
0.0  
11  
17.70273  
21

16.205349

31

0.0

0

ARC

5

F01C

8

0

10

0.0

20

0.0

30

0.0

40

24.0

50

0.0

51

48.417222

0

LINE

5

F01D

8

0

10

0.0

20

0.0

30

0.0

11

17.012134

21

16.92889

31

0.0

0

ENDBLK

5

F01F

8

0

0

BLOCK

8

0

2

D30

70

0

10

0.0

20

0.0

30

0.0

3

D30

1

0

LINE

5

F021

8

0

10

0.0

20

0.0

30

0.0

11

25.518201

21

25.393335

31

0.0

0

LINE

5

F022

8

0

10

0.70537

20

-0.708839

30

0.0

11

26.213724

21

24.674697

31

0.0

0

ARC

5

F023

8

0

10

0.0

20

0.0

30

0.0

40

36.0

50

0.0

51

47.269132

0

ENDBLK

5

F025

8

0  
0  
BLOCK  
8  
0  
2  
SINK  
70  
0  
10  
0.0  
20  
0.0  
30  
0.0  
3  
SINK  
1  
  
0  
LINE  
5  
F027  
8  
0  
62  
12  
10  
-11.423382  
20  
0.290579  
30  
0.0  
11  
-4.070461  
21  
0.290579  
31  
0.0  
0  
ARC  
5  
F028  
8  
0  
62  
12  
10  
-3.539353  
20  
0.0  
30  
0.0  
40  
0.81632  
50  
200.85243  
51  
159.14757  
0  
ARC

5  
F029  
8  
0  
62  
12  
10  
-11.423382  
20  
0.0  
30  
0.0  
40  
0.5  
50  
35.532036  
51  
324.467964  
0

LINE  
5  
F02A  
8  
0  
62  
12  
10  
-11.423382  
20  
-0.290579  
30  
0.0  
11  
-4.070461  
21  
-0.290579  
31  
0.0  
0

ARC  
5  
F02B  
8  
0  
62  
12  
10  
-2.5  
20  
-15.0  
30  
0.0  
40  
1.0  
50  
270.0  
51  
0.0  
0  
ARC  
5

F02C  
8  
0  
62  
12  
10  
-21.5  
20  
-15.0  
30  
0.0  
40  
1.0  
50  
180.0  
51  
270.0  
0  
ARC  
5  
F02D  
8  
0  
62  
12  
10  
-21.5  
20  
15.0  
30  
0.0  
40  
1.0  
50  
90.0  
51  
180.0  
0  
ARC  
5  
F02E  
8  
0  
62  
12  
10  
-2.5  
20  
15.0  
30  
0.0  
40  
1.0  
50  
0.0  
51  
90.0  
0  
LINE  
5  
F02F



8  
0  
62  
12  
10  
-5.375024  
20  
-2.234276  
30  
0.0  
11  
-5.375024  
21  
-12.633536  
31  
0.0  
0

LINE

5  
F030  
8  
0  
62  
12  
10  
-6.375024  
20  
-13.633536  
30  
0.0  
11  
-18.674376  
21  
-13.633536  
31  
0.0  
0

LINE

5  
F031  
8  
0  
62  
12  
10  
-19.674376  
20  
-12.633536  
30  
0.0  
11  
-19.674376  
21  
-2.234276  
31  
0.0  
0

LINE

5  
F032  
8

0  
62  
12  
10  
-18.674376  
20  
-1.234276  
30  
0.0  
11  
-6.375024  
21  
-1.234276  
31  
0.0  
0  
ARC  
5  
F033  
8  
0  
62  
12  
10  
-6.375024  
20  
-2.234276  
30  
0.0  
40  
1.0  
50  
0.0  
51  
90.0  
0  
ARC  
5  
F034  
8  
0  
62  
12  
10  
-6.375024  
20  
-12.633536  
30  
0.0  
40  
1.0  
50  
270.0  
51  
0.0  
0  
ARC  
5  
F035  
8  
0

62  
12  
10  
-18.674376  
20  
-12.633536  
30  
0.0  
40  
1.0  
50  
180.0  
51  
270.0  
0  
ARC  
5  
F036  
8  
0  
62  
12  
10  
-18.674376  
20  
-2.234276  
30  
0.0  
40  
1.0  
50  
90.0  
51  
180.0  
0  
LINE  
5  
F037  
8  
0  
62  
12  
10  
-1.5  
20  
-15.0  
30  
0.0  
11  
-1.5  
21  
15.0  
31  
0.0  
0  
LINE  
5  
F038  
8  
0  
62

12  
10  
-22.5  
20  
-15.0  
30  
0.0  
11  
-22.5  
21  
15.0  
31  
0.0  
0  
LINE  
5  
F039  
8  
0  
62  
12  
10  
-21.5  
20  
-16.0  
30  
0.0  
11  
-2.5  
21  
-16.0  
31  
0.0  
0  
LINE  
5  
F03A  
8  
0  
62  
12  
10  
-21.5  
20  
16.0  
30  
0.0  
11  
-2.5  
21  
16.0  
31  
0.0  
0  
ARC  
5  
F03B  
8  
0  
62  
12

10  
-18.674376  
20  
2.234276  
30  
0.0  
40  
1.0  
50  
180.0  
51  
270.0  
0  
ARC  
5  
F03C  
8  
0  
62  
12  
10  
-18.674376  
20  
12.633536  
30  
0.0  
40  
1.0  
50  
90.0  
51  
180.0  
0  
ARC  
5  
F03D  
8  
0  
62  
12  
10  
-6.375024  
20  
12.633536  
30  
0.0  
40  
1.0  
50  
360.0  
51  
90.0  
0  
ARC  
5  
F03E  
8  
0  
62  
12  
10

-6.375024

20

2.234276

30

0.0

40

1.0

50

270.0

51

360.0

0

LINE

5

F03F

8

0

62

12

10

-18.674376

20

1.234276

30

0.0

11

-6.375024

21

1.234276

31

0.0

0

LINE

5

F040

8

0

62

12

10

-19.674376

20

12.633536

30

0.0

11

-19.674376

21

2.234276

31

0.0

0

LINE

5

F041

8

0

62

12

10

-6.375024

20  
13.633536  
30  
0.0  
11  
-18.674376  
21  
13.633536  
31  
0.0  
0  
LINE  
5  
F042  
8  
0  
62  
12  
10  
-5.375024  
20  
2.234276  
30  
0.0  
11  
-5.375024  
21  
12.633536  
31  
0.0  
0  
ENDBLK  
5  
F044  
8  
0  
0  
BLOCK  
8  
0  
2  
WC  
70  
0  
10  
0.0  
20  
0.0  
30  
0.0  
3  
WC  
1  
0  
LINE  
5  
F046  
8  
0  
10

-9.728475  
20  
-10.113584  
30  
0.0  
11  
-2.724267  
21  
-10.113584  
31  
0.0  
0  
LINE  
5  
F047  
8  
0  
10  
-2.724267  
20  
10.113584  
30  
0.0  
11  
-9.728475  
21  
10.113584  
31  
0.0  
0  
ARC  
5  
F048  
8  
0  
10  
-9.728475  
20  
-9.389317  
30  
0.0  
40  
0.724267  
50  
180.0  
51  
270.0  
0  
INSERT  
5  
F049  
8  
0  
2  
D  
10  
-21.451416  
20  
0.0  
30  
0.0



41  
65.184  
42  
53.595733  
43  
65.184  
50  
180.0  
0  
LINE  
5  
F04A  
8  
0  
10  
-10.452741  
20  
9.389317  
30  
0.0  
11  
-10.452741  
21  
6.912647  
31  
0.0  
0  
LINE  
5  
F04B  
8  
0  
10  
-10.452741  
20  
-6.912647  
30  
0.0  
11  
-11.276398  
21  
-5.436794  
31  
0.0  
0  
LINE  
5  
F04C  
8  
0  
10  
-11.276398  
20  
-5.436794  
30  
0.0  
11  
-11.276398  
21  
5.337834  
31

0.0  
0  
LINE  
5  
F04D  
8  
0  
10  
-10.452741  
20  
-6.912647  
30  
0.0  
11  
-10.452741  
21  
-9.389317  
31  
0.0  
0  
LINE  
5  
F04E  
8  
0  
10  
-11.276398  
20  
5.337834  
30  
0.0  
11  
-10.452741  
21  
6.912647  
31  
0.0  
0  
ARC  
5  
F04F  
8  
0  
10  
-9.728475  
20  
9.389317  
30  
0.0  
40  
0.724267  
50  
90.0  
51  
180.0  
0  
ARC  
5  
F050  
8  
0

10  
-2.724267  
20  
-9.389317  
30  
0.0  
40  
0.724267  
50  
270.0  
51  
0.0  
0  
LINE  
5  
F051  
8  
0  
10  
-2.0  
20  
-9.389317  
30  
0.0  
11  
-2.0  
21  
9.389317  
31  
0.0  
0  
ARC  
5  
F052  
8  
0  
10  
-2.724267  
20  
9.389317  
30  
0.0  
40  
0.724267  
50  
0.0  
51  
90.0  
0  
ENDBLK  
5  
F054  
8  
0  
0  
BLOCK  
8  
0  
2  
WASHDRY  
70

0

10  
0.0  
20  
0.0  
30  
0.0  
3  
WASHDRY  
1

0  
INSERT  
5  
F056  
8  
0  
2  
RVKZ  
10  
2.220448  
20  
3.119283  
30  
0.0  
50  
270.0  
0

ENDBLK  
5  
F058  
8  
0

0  
BLOCK  
8  
0  
2  
CHAIR  
70

0

10  
0.0  
20  
0.0  
30  
0.0  
3  
CHAIR  
1

0  
LINE  
5  
F05A  
8  
0  
10  
-16.817547  
20  
-4.012034

30  
0.0  
11  
-16.817547  
21  
5.292224  
31  
0.0  
0  
LINE  
5  
F05B  
8  
0  
10  
-2.817547  
20  
-5.190605  
30  
0.0  
11  
-2.817547  
21  
6.470796  
31  
0.0  
0  
LINE  
5  
F05C  
8  
0  
10  
-15.477347  
20  
-5.503498  
30  
0.0  
11  
-4.477347  
21  
-6.682069  
31  
0.0  
0  
LINE  
5  
F05D  
8  
0  
10  
-4.477347  
20  
7.96226  
30  
0.0  
11  
-15.477347  
21  
6.783688  
31

0.0  
0  
ARC  
5  
F05E  
8  
0  
10  
-4.317547  
20  
-5.190605  
30  
0.0  
40  
1.5  
50  
263.884496  
51  
0.0  
0  
ARC  
5  
F05F  
8  
0  
10  
-4.317547  
20  
6.470796  
30  
0.0  
40  
1.5  
50  
0.0  
51  
96.115504  
0  
ARC  
5  
F060  
8  
0  
10  
-15.317547  
20  
5.292224  
30  
0.0  
40  
1.5  
50  
96.115504  
51  
180.0  
0  
ARC  
5  
F061  
8  
0

10  
-15.317547  
20  
-4.012034  
30  
0.0  
40  
1.5  
50  
180.0  
51  
263.884496  
0  
ARC  
5  
F062  
8  
0  
10  
-3.407809  
20  
0.640095  
30  
0.0  
40  
16.5  
50  
158.436036  
51  
201.563954  
0  
ARC  
5  
F063  
8  
0  
10  
-3.407809  
20  
0.640095  
30  
0.0  
40  
18.5  
50  
158.436041  
51  
201.563959  
0  
ARC  
5  
F064  
8  
0  
10  
-19.682946  
20  
-5.791848  
30  
0.0  
40

1.0  
50  
201.563959  
51  
21.563959  
0  
ARC  
5  
F065  
8  
0  
10  
-19.682946  
20  
7.072039  
30  
0.0  
40  
1.0  
50  
338.436041  
51  
158.436041  
0  
ENDBLK  
5  
F067  
8  
0  
0  
BLOCK  
8  
0  
2  
BEDD  
70  
0  
10  
0.0  
20  
0.0  
30  
0.0  
3  
BEDD  
1  
0  
LINE  
5  
F069  
8  
0  
10  
-5.040355  
20  
25.291817  
30  
0.0  
11  
-18.60384



21  
25.291817  
31  
0.0  
0  
LINE  
5  
F06A  
8  
0  
10  
-4.812507  
20  
1.470798  
30  
0.0  
11  
-18.831688  
21  
1.470798  
31  
0.0  
0  
POLYLINE  
5  
F06B  
8  
0  
66 1  
10  
0.0  
20  
0.0  
30  
0.0  
0  
VERTEX  
5  
100C3  
8  
0  
10  
-18.60384  
20  
25.291817  
30  
0.0  
42  
0.031322  
0  
VERTEX  
5  
100C4  
8  
0  
10  
-19.412172  
20  
12.400906  
30

0.0  
42  
0.050567  
0  
SEQEND  
5  
100C5  
8  
0  
0  
POLYLINE  
5  
F06C  
8  
0  
66  
1  
10  
0.0  
20  
0.0  
30  
0.0  
0  
VERTEX  
5  
100C6  
8  
0  
10  
-5.040355  
20  
25.291817  
30  
0.0  
42  
-0.031322  
0  
VERTEX  
5  
100C7  
8  
0  
10  
-4.232023  
20  
12.400906  
30  
0.0  
42  
-0.050567  
0  
SEQEND  
5  
100C8  
8  
0  
0  
POLYLINE  
5  
F06D

8  
0  
66  
1  
10  
0.0  
20  
0.0  
30  
0.0  
0  
VERTEX  
5  
100C9  
8  
0  
10  
-4.232023  
20  
12.400906  
30  
0.0  
42  
-0.026536  
0  
VERTEX  
5  
100CA  
8  
0  
10  
-4.812507  
20  
1.470798  
30  
0.0  
42  
-0.064406  
0  
SEQEND  
5  
100CB  
8  
0  
0  
POLYLINE  
5  
F06E  
8  
0  
66  
1  
10  
0.0  
20  
0.0  
30  
0.0  
0  
VERTEX  
5

100CC  
8  
0  
10  
-19.412172  
20  
12.400906  
30  
0.0  
42  
0.026536  
0  
VERTEX  
5  
100CD  
8  
0  
10  
-18.831688  
20  
1.470798  
30  
0.0  
42  
0.064406  
0  
SEQEND  
5  
100CE  
8  
0  
0  
POLYLINE  
5  
F06F  
8  
0  
66  
1  
10  
0.0  
20  
0.0  
30  
0.0  
0  
VERTEX  
5  
100CF  
8  
0  
10  
-19.412172  
20  
-11.747483  
30  
0.0  
42  
-0.026536  
0  
VERTEX

5  
100D0  
8  
0  
10  
-18.831688  
20  
-0.817375  
30  
0.0  
42  
-0.064406  
0

SEQEND

5  
100D1  
8  
0  
0  
POLYLINE  
5  
F070  
8  
0  
66  
1

10  
0.0  
20  
0.0  
30  
0.0  
0

VERTEX

5  
100D2  
8  
0  
10  
-4.232023  
20  
-11.747483  
30  
0.0  
42  
0.026536  
0

VERTEX

5  
100D3  
8  
0  
10  
-4.812507  
20  
-0.817375  
30  
0.0  
42  
0.064406  
0

SEQEND

5

100D4

8

0

0

POLYLINE

5

F071

8

0

66

1

10

0.0

20

0.0

30

0.0

0

VERTEX

5

100D5

8

0

10

-5.040355

20

-24.638394

30

0.0

42

0.031322

0

VERTEX

5

100D6

8

0

10

-4.232023

20

-11.747483

30

0.0

42

0.050567

0

SEQEND

5

100D7

8

0

0

POLYLINE

5

F072

8

0

66

1

10  
0.0  
20  
0.0  
30  
0.0  
0  
VERTEX  
5  
100D8  
8  
0  
10  
-18.60384  
20  
-24.638394  
30  
0.0  
42  
-0.031322  
0  
VERTEX  
5  
100D9  
8  
0  
10  
-19.412172  
20  
-11.747483  
30  
0.0  
42  
-0.050567  
0  
SEQEND  
5  
100DA  
8  
0  
0  
LINE  
5  
F073  
8  
0  
10  
-4.812507  
20  
-0.817375  
30  
0.0  
11  
-18.831688  
21  
-0.817375  
31  
0.0  
0  
LINE  
5

F074  
8  
0  
10  
-5.040355  
20  
-24.638394  
30  
0.0  
11  
-18.60384  
21  
-24.638394  
31  
0.0  
0

LINE

5  
F075  
8  
0  
10  
-23.495098  
20  
2.823481  
30  
0.0  
11  
-36.89435  
21  
-26.673288  
31  
0.0  
0

LINE

5  
F076  
8  
0  
10  
-23.642743  
20  
-5.96973  
30  
0.0  
11  
-26.920797  
21  
-26.673288  
31  
0.0  
0

LINE

5  
F077  
8  
0  
10  
-23.495098  
20  
27.326712



30  
0.0  
11  
-23.495098  
21  
-4.093113  
31  
0.0  
0  
LINE  
5  
F078  
8  
0  
10  
-4.495098  
20  
-26.673288  
30  
0.0  
11  
-78.495098  
21  
-26.673288  
31  
0.0  
0  
LINE  
5  
F079  
8  
0  
10  
-4.495098  
20  
27.326712  
30  
0.0  
11  
-78.495098  
21  
27.326712  
31  
0.0  
0  
LINE  
5  
F07A  
8  
0  
10  
-80.495098  
20  
25.326712  
30  
0.0  
11  
-80.495098  
21  
-24.673288  
31

0.0  
0  
LINE  
5  
F07B  
8  
0  
10  
-2.495098  
20  
25.326712  
30  
0.0  
11  
-2.495098  
21  
-24.673288  
31  
0.0  
0  
ARC  
5  
F07C  
8  
0  
10  
-78.495098  
20  
25.326712  
30  
0.0  
40  
2.0  
50  
90.0  
51  
180.0  
0  
ARC  
5  
F07D  
8  
0  
10  
-78.495098  
20  
-24.673288  
30  
0.0  
40  
2.0  
50  
180.0  
51  
270.0  
0  
ARC  
5  
F07E  
8  
0

10  
-4.495098  
20  
-24.673288  
30  
0.0  
40  
2.0  
50  
270.0  
51  
0.0  
0  
ARC  
5  
F07F  
8  
0  
10  
-4.495098  
20  
25.326712  
30  
0.0  
40  
2.0  
50  
360.0  
51  
90.0  
0  
ARC  
5  
F080  
8  
0  
10  
-35.495098  
20  
-4.093113  
30  
0.0  
40  
12.0  
50  
351.002884  
51  
360.0  
0  
ENDBLK  
5  
F082  
8  
0  
0  
BLOCK  
8  
0  
2  
COFFTBL  
70

0  
10  
0.0  
20  
0.0  
30  
0.0  
3  
COFFTBL  
1  
  
0  
POLYLINE  
5  
F084  
8  
0  
66  
1  
10  
0.0  
20  
0.0  
30  
0.0  
70  
1  
0  
VERTEX  
5  
100DB  
8  
0  
10  
0.0  
20  
0.0  
30  
0.0  
0  
VERTEX  
5  
100DC  
8  
0  
10  
33.0  
20  
0.0  
30  
0.0  
0  
VERTEX  
5  
100DD  
8  
0  
10  
33.0  
20  
18.0

30  
0.0  
0  
VERTEX  
5  
100DE  
8  
0  
10  
0.0  
20  
18.0  
30  
0.0  
0  
SEQEND  
5  
100DF  
8  
0  
0  
ENDBLK  
5  
F086  
8  
0  
0  
BLOCK  
8  
0  
2  
SOFALG  
70  
0  
10  
0.0  
20  
0.0  
30  
0.0  
3  
SOFALG  
1  
0  
LINE  
5  
F088  
8  
0  
10  
-36.0  
20  
15.0  
30  
0.0  
11  
-36.0  
21  
35.0  
31

0.0  
0  
LINE  
5  
F089  
8  
0  
10  
-4.0  
20  
-42.0  
30  
0.0  
11  
-4.0  
21  
42.0  
31  
0.0  
0  
LINE  
5  
F08A  
8  
0  
10  
-14.793404  
20  
15.0  
30  
0.0  
11  
-14.793404  
21  
35.0  
31  
0.0  
0  
LINE  
5  
F08B  
8  
0  
10  
-7.291663  
20  
15.0  
30  
0.0  
11  
-7.291663  
21  
35.0  
31  
0.0  
0  
LINE  
5  
F08C  
8  
0

10  
-33.5  
20  
-37.5  
30  
0.0  
11  
-17.293404  
21  
-37.5  
31  
0.0  
0

LINE  
5  
F08D  
8

0  
10  
-33.5  
20  
12.5  
30  
0.0  
11  
-17.293404  
21  
12.5  
31  
0.0  
0

LINE  
5  
F08E  
8

0  
10  
-33.5  
20  
-12.5  
30  
0.0  
11  
-17.293404  
21  
-12.5  
31  
0.0  
0

LINE  
5  
F08F  
8

0  
10  
-33.5  
20  
-42.0  
30  
0.0  
11

-4.0  
21  
-42.0  
31  
0.0  
0  
LINE  
5  
F090  
8  
0  
10  
-36.0  
20  
-35.0  
30  
0.0  
11  
-36.0  
21  
-15.0  
31  
0.0  
0  
ARC  
5  
F091  
8  
0  
10  
-33.5  
20  
-35.0  
30  
0.0  
40  
2.5  
50  
180.0  
51  
270.0  
0  
LINE  
5  
F092  
8  
0  
10  
-34.5  
20  
-38.5  
30  
0.0  
11  
-34.5  
21  
-41.0  
31  
0.0  
0  
ARC



5  
F093  
8  
0  
10  
-33.5  
20  
-38.5  
30  
0.0  
40  
1.0  
50  
90.0  
51  
180.0  
0  
ARC  
5  
F094  
8  
0  
10  
-33.5  
20  
-41.0  
30  
0.0  
40  
1.0  
50  
180.0  
51  
270.0  
0  
LINE  
5  
F095  
8  
0  
10  
-36.0  
20  
-10.0  
30  
0.0  
11  
-36.0  
21  
10.0  
31  
0.0  
0  
ARC  
5  
F096  
8  
0  
10  
-33.5  
20

-10.0  
30  
0.0  
40  
2.5  
50  
180.0  
51  
270.0  
0  
ARC  
5  
F097  
8  
0  
10  
-33.5  
20  
-15.0  
30  
0.0  
40  
2.5  
50  
90.0  
51  
180.0  
0  
ARC  
5  
F098  
8  
0  
10  
-33.5  
20  
10.0  
30  
0.0  
40  
2.5  
50  
90.0  
51  
180.0  
0  
ARC  
5  
F099  
8  
0  
10  
-33.5  
20  
15.0  
30  
0.0  
40  
2.5  
50  
180.0

51  
270.0  
0  
LINE  
5  
F09A  
8  
0  
10  
-14.793404  
20  
-35.0  
30  
0.0  
11  
-14.793404  
21  
-15.0  
31  
0.0  
0  
LINE  
5  
F09B  
8  
0  
10  
-7.291663  
20  
-35.0  
30  
0.0  
11  
-7.291663  
21  
-15.0  
31  
0.0  
0  
ARC  
5  
F09C  
8  
0  
10  
-17.293404  
20  
-35.0  
30  
0.0  
40  
2.5  
50  
270.0  
51  
0.0  
0  
LINE  
5  
F09D  
8

0  
10  
-12.293404  
20  
-37.5  
30  
0.0  
11  
-9.791663  
21  
-37.5  
31  
0.0  
0  
ARC  
5  
F09E  
8  
0  
10  
-12.293404  
20  
-35.0  
30  
0.0  
40  
2.5  
50  
180.0  
51  
270.0  
0  
ARC  
5  
F09F  
8  
0  
10  
-9.791663  
20  
-35.0  
30  
0.0  
40  
2.5  
50  
270.0  
51  
0.0  
0  
LINE  
5  
F0A0  
8  
0  
10  
-9.62035  
20  
-37.494124  
30  
0.0

11  
-9.62035  
21  
-42.0  
31  
0.0  
0  
LINE  
5  
FOA1  
8  
0  
10  
-14.793404  
20  
-10.0  
30  
0.0  
11  
-14.793404  
21  
10.0  
31  
0.0  
0  
LINE  
5  
FOA2  
8  
0  
10  
-7.291663  
20  
-10.0  
30  
0.0  
11  
-7.291663  
21  
10.0  
31  
0.0  
0  
ARC  
5  
FOA3  
8  
0  
10  
-17.293404  
20  
-10.0  
30  
0.0  
40  
2.5  
50  
270.0  
51  
0.0  
0

ARC  
5  
F0A4  
8  
0  
10  
-17.293404  
20  
-15.0  
30  
0.0  
40  
2.5  
50  
0.0  
51  
90.0  
0  
LINE  
5  
F0A5  
8  
0  
10  
-12.293404  
20  
-12.5  
30  
0.0  
11  
-9.791663  
21  
-12.5  
31  
0.0  
0  
ARC  
5  
F0A6  
8  
0  
10  
-9.791663  
20  
-15.0  
30  
0.0  
40  
2.5  
50  
90.0  
51  
90.0  
0  
ARC  
5  
F0A7  
8  
0  
10  
-12.293404

20  
-15.0  
30  
0.0  
40  
2.5  
50  
90.0  
51  
180.0  
0  
ARC  
5  
F0A8  
8  
0  
10  
-12.293404  
20  
-10.0  
30  
0.0  
40  
2.5  
50  
180.0  
51  
270.0  
0  
ARC  
5  
F0A9  
8  
0  
10  
-9.791663  
20  
-10.0  
30  
0.0  
40  
2.5  
50  
270.0  
51  
0.0  
0  
ARC  
5  
F0AA  
8  
0  
10  
-9.791663  
20  
-15.0  
30  
0.0  
40  
2.5  
50

0.0  
51  
90.0  
0  
LINE  
5  
F0AB  
8  
0  
10  
-12.293404  
20  
12.5  
30  
0.0  
11  
-9.791663  
21  
12.5  
31  
0.0  
0  
ARC  
5  
F0AC  
8  
0  
10  
-9.791663  
20  
15.0  
30  
0.0  
40  
2.5  
50  
270.0  
51  
0.0  
0  
ARC  
5  
F0AD  
8  
0  
10  
-12.293404  
20  
15.0  
30  
0.0  
40  
2.5  
50  
180.0  
51  
270.0  
0  
ARC  
5  
F0AE



8  
0  
10  
-17.293404  
20  
15.0  
30  
0.0  
40  
2.5  
50  
270.0  
51  
0.0  
0  
ARC  
5  
F0AF  
8  
0  
10  
-17.293404  
20  
10.0  
30  
0.0  
40  
2.5  
50  
0.0  
51  
90.0  
0  
ARC  
5  
F0B0  
8  
0  
10  
-12.293404  
20  
10.0  
30  
0.0  
40  
2.5  
50  
90.0  
51  
180.0  
0  
ARC  
5  
F0B1  
8  
0  
10  
-9.791663  
20  
10.0  
30

0.0  
40  
2.5  
50  
0.0  
51  
90.0  
0  
LINE  
5  
F0B2  
8  
0  
10  
-17.293404  
20  
37.5  
30  
0.0  
11  
-33.5  
21  
37.5  
31  
0.0  
0  
LINE  
5  
F0B3  
8  
0  
10  
-4.0  
20  
42.0  
30  
0.0  
11  
-33.5  
21  
42.0  
31  
0.0  
0  
ARC  
5  
F0B4  
8  
0  
10  
-33.5  
20  
38.5  
30  
0.0  
40  
1.0  
50  
180.0  
51  
270.0

0  
ARC  
5  
F0B5  
8  
0  
10  
-33.5  
20  
35.0  
30  
0.0  
40  
2.5  
50  
90.0  
51  
180.0  
0  
LINE  
5  
F0B6  
8  
0  
10  
-34.5  
20  
41.0  
30  
0.0  
11  
-34.5  
21  
38.5  
31  
0.0  
0  
ARC  
5  
F0B7  
8  
0  
10  
-33.5  
20  
41.0  
30  
0.0  
40  
1.0  
50  
90.0  
51  
180.0  
0  
LINE  
5  
F0B8  
8  
0  
10

-9.62035  
20  
42.0  
30  
0.0  
11  
-9.62035  
21  
37.494124  
31  
0.0  
0  
LINE  
5  
F0B9  
8  
0  
10  
-12.293404  
20  
37.5  
30  
0.0  
11  
-9.791663  
21  
37.5  
31  
0.0  
0  
ARC  
5  
F0BA  
8  
0  
10  
-9.791663  
20  
35.0  
30  
0.0  
40  
2.5  
50  
0.0  
51  
90.0  
0  
ARC  
5  
F0BB  
8  
0  
10  
-12.293404  
20  
35.0  
30  
0.0  
40  
2.5

50  
90.0  
51  
180.0  
0  
ARC  
5  
F0BC  
8  
0  
10  
-17.293404  
20  
35.0  
30  
0.0  
40  
2.5  
50  
0.0  
51  
90.0  
0  
ENDBLK  
5  
F0BE  
8  
0  
0  
BLOCK  
8  
0  
2  
CHAIR2  
70  
0  
10  
0.0  
20  
0.0  
30  
0.0  
3  
CHAIR2  
1  
0  
ARC  
5  
F0C0  
8  
0  
10  
-12.734388  
20  
1.856075  
30  
0.0  
40  
20.0  
50

143.130102

51

216.869898

0

LINE

5

FOC1

8

0

10

-10.859388

20

-13.185911

30

0.0

11

-23.609388

21

-13.185911

31

0.0

0

ARC

5

FOC2

8

0

10

-11.296888

20

-11.685911

30

0.0

40

1.5625

50

253.739795

51

106.260205

0

ARC

5

FOC3

8

0

10

-23.171888

20

-11.685911

30

0.0

40

1.5625

50

73.739795

51

286.260205

0

ARC

5

FOC4

8  
0  
10  
-28.079065  
20  
-9.264424  
30  
0.0  
40  
1.096801  
50  
233.309935  
51  
32.027413  
0  
ARC  
5  
F0C5  
8  
0  
10  
-28.079065  
20  
12.976573  
30  
0.0  
40  
1.096801  
50  
327.972587  
51  
126.690065  
0  
ARC  
5  
F0C6  
8  
0  
10  
-10.55798  
20  
1.856075  
30  
0.0  
40  
19.640192  
50  
147.575753  
51  
212.424247  
0  
ARC  
5  
F0C7  
8  
0  
10  
-25.734388  
20  
10.856075  
30

0.0  
40  
3.0  
50  
90.0  
51  
117.584441  
0  
ARC  
5  
F0C8  
8  
0  
10  
-25.734388  
20  
-7.143925  
30  
0.0  
40  
3.0  
50  
242.415559  
51  
270.0  
0  
ARC  
5  
F0C9  
8  
0  
10  
-8.734388  
20  
10.856075  
30  
0.0  
40  
3.0  
50  
0.0  
51  
90.0  
0  
ARC  
5  
F0CA  
8  
0  
10  
-8.734388  
20  
-7.143925  
30  
0.0  
40  
3.0  
50  
270.0  
51  
360.0



0  
ARC  
5  
F0CB  
8  
0  
10  
-23.171888  
20  
15.356075  
30  
0.0  
40  
1.5625  
50  
73.739795  
51  
286.260205  
0  
ARC  
5  
F0CC  
8  
0  
10  
-11.296888  
20  
15.356075  
30  
0.0  
40  
1.5625  
50  
253.739795  
51  
106.260205  
0  
LINE  
5  
F0CD  
8  
0  
10  
-28.734388  
20  
9.296189  
30  
0.0  
11  
-28.734388  
21  
-5.58404  
31  
0.0  
0  
LINE  
5  
F0CE  
8  
0  
10

-25.734388

20

-10.143925

30

0.0

11

-8.734388

21

-10.143925

31

0.0

0

LINE

5

F0CF

8

0

10

-8.734388

20

13.856075

30

0.0

11

-25.734388

21

13.856075

31

0.0

0

LINE

5

F0D0

8

0

10

-5.734388

20

-7.143925

30

0.0

11

-5.734388

21

10.856075

31

0.0

0

LINE

5

F0D1

8

0

10

-10.859388

20

16.856075

30

0.0

11

-23.609388

21  
16.856075  
31  
0.0  
0  
ENDBLK  
5  
F0D3  
8  
0  
0  
BLOCK  
8  
0  
2  
BEDKING  
70  
0  
10  
0.0  
20  
0.0  
30  
0.0  
3  
BEDKING  
1  
0  
LINE  
5  
F0D5  
8  
0  
10  
-5.185736  
20  
-2.907159  
30  
0.0  
11  
-20.248476  
21  
-2.907159  
31  
0.0  
0  
LINE  
5  
F0D6  
8  
0  
10  
-5.405377  
20  
-28.653984  
30  
0.0  
11  
-20.028835  
21

-28.653984

31

0.0

0

POLYLINE

5

F0D7

8

0

66

1

10

0.0

20

0.0

30

0.0

0

VERTEX

5

100E0

8

0

10

-20.94857

20

-14.907159

30

0.0

42

-0.029146

0

VERTEX

5

100E1

8

0

10

-20.248476

20

-2.907159

30

0.0

42

-0.064406

0

SEQEND

5

100E2

8

0

0

POLYLINE

5

F0D8

8

0

66

1

10

0.0

```
20
0.0
30
0.0
0
VERTEX
5
100E3
8
0
10
-20.028835
20
-28.653984
30
0.0
42
-0.033415
0
VERTEX
5
100E4
8
0
10
-20.94857
20
-14.907159
30
0.0
42
-0.050567
0
SEQEND
5
100E5
8
0
0
POLYLINE
5
F0D9
8
0
66
1
10
0.0
20
0.0
30
0.0
0
VERTEX
5
100E6
8
0
10
-4.485642
20
```

-14.907159

30

0.0

42

0.029146

0

VERTEX

5

100E7

8

0

10

-5.185736

20

-2.907159

30

0.0

42

0.064406

0

SEQEND

5

100E8

8

0

0

POLYLINE

5

F0DA

8

0

66

1

10

0.0

20

0.0

30

0.0

0

VERTEX

5

100E9

8

0

10

-5.405377

20

-28.653984

30

0.0

42

0.033415

0

VERTEX

5

100EA

8

0

10

-4.485642

```
20
-14.907159
30
0.0
42
0.050567
0
SEQEND
5
100EB
8
0
0
POLYLINE
5
F0DB
8
0
66
1
10
0.0
20
0.0
30
0.0
0
VERTEX
5
100EC
8
0
10
-5.405377
20
26.839666
30
0.0
42
-0.033415
0
VERTEX
5
100ED
8
0
10
-4.485642
20
13.092841
30
0.0
42
-0.050567
0
SEQEND
5
100EE
8
0
0
```

POLYLINE

5

F0DC

8

0

66

1

10

0.0

20

0.0

30

0.0

0

VERTEX

5

100EF

8

0

10

-4.485642

20

13.092841

30

0.0

42

-0.029146

0

VERTEX

5

100F0

8

0

10

-5.185736

20

1.092841

30

0.0

42

-0.064406

0

SEQEND

5

100F1

8

0

0

POLYLINE

5

F0DD

8

0

66

1

10

0.0

20

0.0

30

0.0



```
0
VERTEX
5
100F2
8
0
10
-20.028835
20
26.839666
30
0.0
42
0.033415
0
VERTEX
5
100F3
8
0
10
-20.94857
20
13.092841
30
0.0
42
0.050567
0
SEQEND
5
100F4
8
0
0
POLYLINE
5
F0DE
8
0
66
1
10
0.0
20
0.0
30
0.0
0
VERTEX
5
100F5
8
0
10
-20.94857
20
13.092841
30
0.0
42
```

0.029146  
0  
VERTEX  
5  
100F6  
8  
0  
10  
-20.248476  
20  
1.092841  
30  
0.0  
42  
0.064406  
0  
SEQEND  
5  
100F7  
8  
0  
0  
LINE  
5  
F0DF  
8  
0  
10  
-5.405377  
20  
26.839666  
30  
0.0  
11  
-20.028835  
21  
26.839666  
31  
0.0  
0  
LINE  
5  
F0E0  
8  
0  
10  
-5.185736  
20  
1.092841  
30  
0.0  
11  
-20.248476  
21  
1.092841  
31  
0.0  
0  
LINE  
5  
F0E1

8  
0  
10  
-24.17631  
20  
-0.97813  
30  
0.0  
11  
-40.497491  
21  
-36.907159  
31  
0.0  
0

LINE

5  
FOE2  
8

0  
10  
-24.17631  
20  
-8.838841  
30  
0.0  
11  
-28.620446  
21  
-36.907159  
31  
0.0  
0

LINE

5  
FOE3  
8

0  
10  
-24.17631  
20  
35.092841  
30  
0.0  
11  
-24.17631  
21  
-8.838841  
31  
0.0  
0

LINE

5  
FOE4  
8

0  
10  
-3.17631  
20  
-36.907159  
30

0.0  
11  
-87.17631  
21  
-36.907159  
31  
0.0  
0  
LINE  
5  
FOE5  
8  
0  
10  
-3.17631  
20  
35.092841  
30  
0.0  
11  
-87.17631  
21  
35.092841  
31  
0.0  
0  
LINE  
5  
FOE6  
8  
0  
10  
-87.17631  
20  
35.092841  
30  
0.0  
11  
-87.17631  
21  
-36.907159  
31  
0.0  
0  
LINE  
5  
FOE7  
8  
0  
10  
-3.17631  
20  
35.092841  
30  
0.0  
11  
-3.17631  
21  
-36.907159  
31  
0.0

0  
ENDBLK

5  
F0E9

8  
0  
0  
BLOCK

8  
0  
2

FD26  
70  
0

10  
0.0  
20

0.0  
30  
0.0

3  
FD26  
1

0  
LINE  
5

F0EB  
8  
0

10  
0.0  
20

0.0  
30  
0.0

11  
7.4997  
21

12.989861  
31  
0.0

0  
LINE  
5

F0EC  
8  
0

10  
7.4997  
20

11.323261  
30  
0.0

11  
14.277741  
21

-0.41665  
31  
0.0

0

LINE  
5  
FOED  
8  
0  
10  
7.4997  
20  
12.989861  
30  
0.0  
11  
14.9994  
21  
0.0  
31  
0.0  
0

LINE  
5  
FOEE  
8  
0  
10  
0.721659  
20  
-0.41665  
30  
0.0  
11  
7.4997  
21  
11.323261  
31  
0.0  
0

ENDBLK  
5  
FOF0  
8  
0  
0  
BLOCK  
8  
0  
2  
TBLSM  
70  
0

10  
0.0  
20  
0.0  
30  
0.0  
3  
TBLSM  
1

0  
LINE

5  
F0F2  
8  
0  
10  
18.0  
20  
-36.0  
30  
0.0  
11  
-18.0  
21  
-36.0  
31  
0.0  
0  
LINE  
5  
F0F3  
8  
0  
10  
-18.0  
20  
36.0  
30  
0.0  
11  
18.0  
21  
36.0  
31  
0.0  
0  
ARC  
5  
F0F4  
8  
0  
10  
0.145408  
20  
49.436171  
30  
0.0  
40  
96.985565  
50  
264.90508  
51  
275.09492  
0  
ARC  
5  
F0F5  
8  
0  
10  
0.145408  
20

49.436171  
30  
0.0  
40  
98.985565  
50  
264.903836  
51  
275.096164  
0  
LINE  
5  
F0F6  
8  
0  
10  
7.689933  
20  
-45.270226  
30  
0.0  
11  
-7.399116  
21  
-45.270226  
31  
0.0  
0  
LINE  
5  
F0F7  
8  
0  
10  
7.689933  
20  
45.270226  
30  
0.0  
11  
-7.399116  
21  
45.270226  
31  
0.0  
0  
ARC  
5  
F0F8  
8  
0  
10  
0.145408  
20  
-49.436171  
30  
0.0  
40  
98.985565  
50  
84.903836



51  
95.096164  
0  
ARC  
5  
F0F9  
8  
0  
10  
0.145408  
20  
-49.436171  
30  
0.0  
40  
96.985565  
50  
84.90508  
51  
95.09492  
0  
LINE  
5  
F0FA  
8  
0  
10  
-18.0  
20  
-36.0  
30  
0.0  
11  
-18.0  
21  
36.0  
31  
0.0  
0  
ARC  
5  
F0FB  
8  
0  
10  
67.436171  
20  
15.731705  
30  
0.0  
40  
96.985565  
50  
174.90508  
51  
185.09492  
0  
ARC  
5  
F0FC  
8

0  
10  
67.436171  
20  
15.731705  
30  
0.0  
40  
98.985565  
50  
174.903836  
51  
185.096164  
0

LINE

5  
F0FD  
8  
0  
10  
-27.270226  
20  
23.27623  
30  
0.0  
11  
-27.270226  
21  
8.187181  
31  
0.0  
0

LINE

5  
F0FE  
8  
0  
10  
-8.650448  
20  
-36.0  
30  
0.0  
11  
-8.398656  
21  
-44.300546  
31  
0.0  
0

LINE

5  
F0FF  
8  
0  
10  
-9.009822  
20  
-47.618755  
30  
0.0

11  
-9.100757  
21  
-48.614614  
31  
0.0  
0  
ARC  
5  
F100  
8  
0  
10  
-8.511894  
20  
-47.664222  
30  
0.0  
40  
0.5  
50  
84.90508  
51  
174.782623  
0  
ARC  
5  
F101  
8  
0  
10  
-8.602829  
20  
-48.660081  
30  
0.0  
40  
0.5  
50  
174.782623  
51  
264.903836  
0  
ARC  
5  
F102  
8  
0  
10  
-7.399116  
20  
-44.270226  
30  
0.0  
40  
1.0  
50  
181.737498  
51  
270.0  
0

ARC  
5  
F103  
8  
0  
10  
67.436171  
20  
-15.440888  
30  
0.0  
40  
98.985565  
50  
174.903836  
51  
185.096164  
0

ARC  
5  
F104  
8  
0  
10  
67.436171  
20  
-15.440888  
30  
0.0  
40  
96.985565  
50  
174.90508  
51  
185.09492  
0

ARC  
5  
F105  
8  
0  
10  
-30.660081  
20  
-24.189125  
30  
0.0  
40  
0.5  
50  
185.096164  
51  
275.217377  
0

ARC  
5  
F106  
8  
0  
10  
-29.664222

20  
-24.09819  
30  
0.0  
40  
0.5  
50  
275.217377

51  
5.09492  
0

LINE

5  
F107  
8

0  
10  
-29.618755  
20  
-24.596119  
30

0.0  
11  
-30.614614  
21

-24.687054  
31  
0.0  
0

ARC

5  
F108  
8

0  
10  
-30.660081  
20  
-6.692651  
30

0.0  
40  
0.5  
50

84.782623  
51  
174.903836  
0

ARC

5  
F109  
8

0  
10  
-29.664222  
20  
-6.783586  
30

0.0  
40  
0.5  
50

354.90508

51

84.782623

0

LINE

5

F10A

8

0

10

-29.618755

20

-6.285658

30

0.0

11

-30.614614

21

-6.194723

31

0.0

0

LINE

5

F10B

8

0

10

-29.618755

20

6.576475

30

0.0

11

-30.614614

21

6.48554

31

0.0

0

ARC

5

F10C

8

0

10

-29.664222

20

7.074403

30

0.0

40

0.5

50

275.217377

51

5.09492

0

ARC

5

F10D

8  
0  
10  
-30.660081  
20  
6.983468  
30  
0.0  
40  
0.5  
50  
185.096164  
51  
275.217377  
0  
ARC  
5  
F10E  
8  
0  
10  
-26.270226  
20  
-7.896364  
30  
0.0  
40  
1.0  
50  
91.737498  
51  
180.0  
0  
ARC  
5  
F10F  
8  
0  
10  
-26.270226  
20  
-22.985413  
30  
0.0  
40  
1.0  
50  
180.0  
51  
268.262502  
0  
LINE  
5  
F110  
8  
0  
10  
-18.0  
20  
-24.236745  
30

0.0  
11  
-26.300546  
21  
-23.984953  
31  
0.0  
0  
LINE  
5  
F111  
8  
0  
10  
-27.270226  
20  
-7.896364  
30  
0.0  
11  
-27.270226  
21  
-22.985413  
31  
0.0  
0  
LINE  
5  
F112  
8  
0  
10  
-18.0  
20  
-6.645032  
30  
0.0  
11  
-26.300546  
21  
-6.896823  
31  
0.0  
0  
LINE  
5  
F113  
8  
0  
10  
-18.0  
20  
6.935849  
30  
0.0  
11  
-26.300546  
21  
7.18764  
31  
0.0



0  
ARC  
5  
F114  
8  
0  
10  
-26.270226  
20  
8.187181  
30  
0.0  
40  
1.0  
50  
180.0  
51  
268.262502  
0  
LINE  
5  
F115  
8  
0  
10  
-29.618755  
20  
24.886936  
30  
0.0  
11  
-30.614614  
21  
24.977871  
31  
0.0  
0  
ARC  
5  
F116  
8  
0  
10  
-29.664222  
20  
24.389007  
30  
0.0  
40  
0.5  
50  
354.90508  
51  
84.782623  
0  
ARC  
5  
F117  
8  
0  
10

-30.660081

20

24.479942

30

0.0

40

0.5

50

84.782623

51

174.903836

0

LINE

5

F118

8

0

10

-18.0

20

24.527562

30

0.0

11

-26.300546

21

24.27577

31

0.0

0

ARC

5

F119

8

0

10

-26.270226

20

23.27623

30

0.0

40

1.0

50

91.737498

51

180.0

0

ARC

5

F11A

8

0

10

-7.399116

20

44.270226

30

0.0

40

1.0

50  
90.0  
51  
178.262502  
0  
ARC  
5  
F11B  
8  
0  
10  
-8.602829  
20  
48.660081  
30  
0.0  
40  
0.5  
50  
95.096164  
51  
185.217377  
0  
ARC  
5  
F11C  
8  
0  
10  
-8.511894  
20  
47.664222  
30  
0.0  
40  
0.5  
50  
185.217377  
51  
275.09492  
0  
LINE  
5  
F11D  
8  
0  
10  
-9.009822  
20  
47.618755  
30  
0.0  
11  
-9.100757  
21  
48.614614  
31  
0.0  
0  
LINE  
5

F11E  
8  
0  
10  
-8.650448  
20  
36.0  
30  
0.0  
11  
-8.398656  
21  
44.300546  
31  
0.0  
0

LINE

5

F11F

8  
0  
10  
18.0  
20  
36.0  
30  
0.0  
11  
18.0  
21  
-36.0  
31  
0.0  
0

LINE

5

F120

8  
0  
10  
27.270226  
20  
23.27623  
30  
0.0  
11  
27.270226  
21  
8.187181  
31  
0.0  
0

ARC

5

F121

8  
0  
10  
-67.436171  
20  
15.731705

30  
0.0  
40  
98.985565  
50  
354.903836  
51  
5.096164  
0  
ARC  
5  
F122  
8  
0  
10  
-67.436171  
20  
15.731705  
30  
0.0  
40  
96.985565  
50  
354.90508  
51  
5.09492  
0  
LINE  
5  
F123  
8  
0  
10  
8.941265  
20  
-36.0  
30  
0.0  
11  
8.689473  
21  
-44.300546  
31  
0.0  
0  
LINE  
5  
F124  
8  
0  
10  
9.300639  
20  
-47.618755  
30  
0.0  
11  
9.391574  
21  
-48.614614  
31

0.0  
0  
ARC  
5  
F125  
8  
0  
10  
8.802711  
20  
-47.664222  
30  
0.0  
40  
0.5  
50  
5.217377  
51  
95.09492  
0  
ARC  
5  
F126  
8  
0  
10  
8.893645  
20  
-48.660081  
30  
0.0  
40  
0.5  
50  
275.096164  
51  
5.217377  
0  
ARC  
5  
F127  
8  
0  
10  
7.689933  
20  
-44.270226  
30  
0.0  
40  
1.0  
50  
270.0  
51  
358.262502  
0  
LINE  
5  
F128  
8  
0

10  
18.0  
20  
6.935849  
30  
0.0  
11  
26.300546  
21  
7.18764  
31  
0.0  
0  
LINE  
5  
F129  
8  
0  
10  
18.0  
20  
-6.645032  
30  
0.0  
11  
26.300546  
21  
-6.896823  
31  
0.0  
0  
LINE  
5  
F12A  
8  
0  
10  
18.0  
20  
-24.236745  
30  
0.0  
11  
26.300546  
21  
-23.984953  
31  
0.0  
0  
ARC  
5  
F12B  
8  
0  
10  
-67.436171  
20  
-15.440888  
30  
0.0  
40

96.985565  
50  
354.90508  
51  
5.09492  
0  
ARC  
5  
F12C  
8  
0  
10  
-67.436171  
20  
-15.440888  
30  
0.0  
40  
98.985565  
50  
354.903836  
51  
5.096164  
0  
ARC  
5  
F12D  
8  
0  
10  
26.270226  
20  
-7.896364  
30  
0.0  
40  
1.0  
50  
0.0  
51  
88.262502  
0  
LINE  
5  
F12E  
8  
0  
10  
27.270226  
20  
-7.896364  
30  
0.0  
11  
27.270226  
21  
-22.985413  
31  
0.0  
0  
LINE



5  
F12F  
8  
0  
10  
29.618755  
20  
-24.596119  
30  
0.0  
11  
30.614614  
21  
-24.687054  
31  
0.0  
0  
ARC  
5  
F130  
8  
0  
10  
29.664222  
20  
-24.09819  
30  
0.0  
40  
0.5  
50  
174.90508  
51  
264.782623  
0  
ARC  
5  
F131  
8  
0  
10  
30.660081  
20  
-24.189125  
30  
0.0  
40  
0.5  
50  
264.782623  
51  
354.903836  
0  
ARC  
5  
F132  
8  
0  
10  
26.270226  
20

-22.985413  
30  
0.0  
40  
1.0  
50  
271.737498  
51  
0.0  
0  
ARC  
5  
F133  
8  
0  
10  
26.270226  
20  
8.187181  
30  
0.0  
40  
1.0  
50  
271.737498  
51  
0.0  
0  
ARC  
5  
F134  
8  
0  
10  
30.660081  
20  
6.983468  
30  
0.0  
40  
0.5  
50  
264.782623  
51  
354.903836  
0  
ARC  
5  
F135  
8  
0  
10  
29.664222  
20  
7.074403  
30  
0.0  
40  
0.5  
50  
174.90508

51  
264.782623  
0  
LINE  
5  
F136  
8  
0  
10  
29.618755  
20  
6.576475  
30  
0.0  
11  
30.614614  
21  
6.48554  
31  
0.0  
0  
LINE  
5  
F137  
8  
0  
10  
29.618755  
20  
-6.285658  
30  
0.0  
11  
30.614614  
21  
-6.194723  
31  
0.0  
0  
ARC  
5  
F138  
8  
0  
10  
29.664222  
20  
-6.783586  
30  
0.0  
40  
0.5  
50  
95.217377  
51  
185.09492  
0  
ARC  
5  
F139  
8

0  
10  
30.660081  
20  
-6.692651  
30  
0.0  
40  
0.5  
50  
5.096164  
51  
95.217377  
0  
LINE  
5  
F13A  
8  
0  
10  
18.0  
20  
24.527562  
30  
0.0  
11  
26.300546  
21  
24.27577  
31  
0.0  
0  
ARC  
5  
F13B  
8  
0  
10  
7.689933  
20  
44.270226  
30  
0.0  
40  
1.0  
50  
1.737498  
51  
90.0  
0  
ARC  
5  
F13C  
8  
0  
10  
8.893645  
20  
48.660081  
30  
0.0

40  
0.5  
50  
354.782623  
51  
84.903836  
0  
ARC  
5  
F13D  
8  
0  
10  
8.802711  
20  
47.664222  
30  
0.0  
40  
0.5  
50  
264.90508  
51  
354.782623  
0  
LINE  
5  
F13E  
8  
0  
10  
9.300639  
20  
47.618755  
30  
0.0  
11  
9.391574  
21  
48.614614  
31  
0.0  
0  
LINE  
5  
F13F  
8  
0  
10  
8.941265  
20  
36.0  
30  
0.0  
11  
8.689473  
21  
44.300546  
31  
0.0  
0

ARC  
5  
F140  
8  
0  
10  
26.270226  
20  
23.27623  
30  
0.0  
40  
1.0  
50  
0.0  
51  
88.262502  
0

ARC  
5  
F141  
8  
0  
10  
30.660081  
20  
24.479942  
30  
0.0  
40  
0.5  
50  
5.096164  
51  
95.217377  
0

ARC  
5  
F142  
8  
0  
10  
29.664222  
20  
24.389007  
30  
0.0  
40  
0.5  
50  
95.217377  
51  
185.09492  
0

LINE  
5  
F143  
8  
0  
10  
29.618755

20  
24.886936  
30  
0.0  
11  
30.614614  
21  
24.977871  
31  
0.0  
0  
ENDBLK  
5  
F145  
8  
0  
0  
BLOCK  
8  
0  
2  
FD60  
70  
0  
10  
0.0  
20  
0.0  
30  
0.0  
3  
FD60  
1  
0  
LINE  
5  
F147  
8  
0  
10  
0.866025  
20  
-0.5  
30  
0.0  
11  
9.0  
21  
13.588457  
31  
0.0  
0  
LINE  
5  
F148  
8  
0  
10  
9.0  
20

15.588457

30

0.0

11

18.0

21

0.0

31

0.0

0

LINE

5

F149

8

0

10

9.0

20

13.588457

30

0.0

11

17.133975

21

-0.5

31

0.0

0

LINE

5

F14A

8

0

10

0.0

20

0.0

30

0.0

11

9.0

21

15.588457

31

0.0

0

LINE

5

F14B

8

0

10

63.0

20

13.588457

30

0.0

11

71.133975

21

-0.5



31  
0.0  
0  
LINE  
5  
F14C  
8  
0  
10  
63.0  
20  
15.588457  
30  
0.0  
11  
72.0  
21  
0.0  
31  
0.0  
0  
LINE  
5  
F14D  
8  
0  
10  
54.0  
20  
0.0  
30  
0.0  
11  
63.0  
21  
15.588457  
31  
0.0  
0  
LINE  
5  
F14E  
8  
0  
10  
54.866025  
20  
-0.5  
30  
0.0  
11  
63.0  
21  
13.588457  
31  
0.0  
0  
ENDBLK  
5  
F150  
8

0  
0  
BLOCK  
8  
0  
2  
FD50  
70  
0  
10  
0.0  
20  
0.0  
30  
0.0  
3  
FD50  
1  
  
0  
LINE  
5  
F152  
8  
0  
10  
0.0  
20  
0.0  
30  
0.0  
11  
7.4997  
21  
12.989861  
31  
0.0  
0  
LINE  
5  
F153  
8  
0  
10  
7.4997  
20  
11.323261  
30  
0.0  
11  
14.277741  
21  
-0.41665  
31  
0.0  
0  
LINE  
5  
F154  
8  
0

10  
7.4997  
20  
12.989861  
30  
0.0  
11  
14.9994  
21  
0.0  
31  
0.0  
0

LINE

5  
F155  
8  
0

10  
0.721659  
20  
-0.41665  
30  
0.0  
11  
7.4997  
21  
11.323261  
31  
0.0  
0

LINE

5  
F156  
8  
0

10  
45.722259  
20  
-0.41665  
30  
0.0  
11  
52.5003  
21  
11.323261  
31  
0.0  
0

LINE

5  
F157  
8  
0

10  
52.5003  
20  
12.989861  
30  
0.0  
11

60.0  
21  
0.0  
31  
0.0  
0  
LINE  
5  
F158  
8  
0  
10  
52.5003  
20  
11.323261  
30  
0.0  
11  
59.278341  
21  
-0.41665  
31  
0.0  
0  
LINE  
5  
F159  
8  
0  
10  
45.0006  
20  
0.0  
30  
0.0  
11  
52.5003  
21  
12.989861  
31  
0.0  
0  
ENDBLK  
5  
F15B  
8  
0  
0  
BLOCK  
8  
0  
2  
FD20  
70  
0  
10  
0.0  
20  
0.0  
30  
0.0

3  
FD20  
1

0  
LINE  
5  
F15D  
8  
0  
10  
0.866025  
20  
-0.5  
30  
0.0  
11  
6.0  
21  
8.392305  
31  
0.0  
0

LINE  
5  
F15E  
8  
0  
10  
6.0  
20  
8.392305  
30  
0.0  
11  
11.133975  
21  
-0.5  
31  
0.0  
0

LINE  
5  
F15F  
8  
0  
10  
6.0  
20  
10.392305  
30  
0.0  
11  
12.0  
21  
0.0  
31  
0.0  
0

LINE  
5

F160  
8  
0  
10  
0.0  
20  
0.0  
30  
0.0  
11  
6.0  
21  
10.392305

31  
0.0  
0  
ENDBLK

5  
F162

8  
0  
0  
BLOCK  
8  
0

2  
SD120  
70  
0

10  
0.0  
20  
0.0  
30  
0.0  
3

SD120  
1

0

LINE  
5

F164  
8  
0

10  
47.0  
20  
0.5  
30  
0.0  
11

97.0  
21  
0.5  
31

0.0  
0

LINE  
5

F165

8  
0  
10  
47.0  
20  
-0.5  
30  
0.0  
11  
97.0  
21  
-0.5  
31  
0.0  
0

LINE

5  
F166  
8

0  
10  
0.0  
20  
-1.0  
30  
0.0  
11  
49.0  
21  
-1.0  
31  
0.0  
0

LINE

5  
F167  
8

0  
10  
0.0  
20  
-2.0  
30  
0.0  
11  
49.0  
21  
-2.0  
31  
0.0  
0

LINE

5  
F168  
8

0  
10  
49.0  
20  
-2.0  
30

0.0  
11  
49.0  
21  
-1.0  
31  
0.0  
0  
LINE  
5  
F169  
8  
0  
10  
47.0  
20  
-0.5  
30  
0.0  
11  
47.0  
21  
0.5  
31  
0.0  
0  
LINE  
5  
F16A  
8  
0  
10  
95.0  
20  
2.0  
30  
0.0  
11  
144.0  
21  
2.0  
31  
0.0  
0  
LINE  
5  
F16B  
8  
0  
10  
95.0  
20  
1.0  
30  
0.0  
11  
144.0  
21  
1.0  
31  
0.0



0  
LINE  
5  
F16C  
8  
0  
10  
97.0  
20  
-0.5  
30  
0.0  
11  
97.0  
21  
0.5  
31  
0.0  
0  
LINE  
5  
F16D  
8  
0  
10  
95.0  
20  
1.0  
30  
0.0  
11  
95.0  
21  
2.0  
31  
0.0  
0  
ENDBLK  
5  
F16F  
8  
0  
0  
BLOCK  
8  
0  
2  
PD24  
70  
0  
10  
0.0  
20  
0.0  
30  
0.0  
3  
PD24  
1  
0

LINE  
5  
F171  
8  
0  
10  
41.999999  
20  
-0.500048  
30  
0.0  
11  
13.999999  
21  
-0.500016  
31  
0.0  
0

LINE  
5  
F172  
8  
0  
10  
42.000001  
20  
0.499952  
30  
0.0  
11  
14.000001  
21  
0.499984  
31  
0.0  
0

LINE  
5  
F173  
8  
0  
10  
13.999999  
20  
-0.500016  
30  
0.0  
11  
14.000001  
21  
0.499984  
31  
0.0  
0

LINE  
5  
F174  
8  
0  
10  
41.999999

20  
-0.500048  
30  
0.0  
11  
42.000001  
21  
0.499952  
31  
0.0  
0  
ENDBLK  
5  
F176  
8  
0  
0  
BLOCK  
8  
0  
2  
DESKSM  
70  
0  
10  
0.0  
20  
0.0  
30  
0.0  
3  
DESKSM  
1  
0  
INSERT  
5  
F178  
8  
0  
2  
RVK000  
10  
-11.52124  
20  
1.842154  
30  
0.0  
50  
270.0  
0  
ENDBLK  
5  
F17A  
8  
0  
0  
BLOCK  
8  
0  
2

D28  
70  
0  
10  
0.0  
20  
0.0  
30  
0.0  
3  
D28  
1  
0  
LINE  
5  
F17C  
8  
0  
10  
0.70537  
20  
-0.708839  
30  
0.0  
11  
23.377137  
21  
21.85199  
31  
0.0  
0  
LINE  
5  
F17D  
8  
0  
10  
0.0  
20  
0.0  
30  
0.0  
11  
22.682845  
21  
22.571853  
31  
0.0  
0  
ARC  
5  
F17E  
8  
0  
10  
0.0  
20  
0.0  
30  
0.0

40  
32.0  
50  
0.0  
51  
47.527035  
0  
ENDBLK  
5  
F180  
8  
0  
0  
BLOCK  
8  
0  
2  
\*U296  
70  
1  
10  
0.0  
20  
0.0  
30  
0.0  
3  
\*U296  
1  
0  
SOLID  
5  
FB10  
8  
0  
6  
CONTINUOUS  
10  
1705.898212  
20  
398.905197  
30  
0.0  
11  
1705.312426  
21  
400.31941  
31  
0.0  
12  
1705.312426  
22  
397.490983  
32  
0.0  
13  
1705.312426  
23  
397.490983  
33

0.0  
0  
SOLID  
5  
FB11  
8  
0  
6  
CONTINUOUS  
10  
1703.898212  
20  
400.905197  
30  
0.0  
11  
1705.312426  
21  
397.490983  
31  
0.0  
12  
1705.312426  
22  
400.31941  
32  
0.0  
13  
1705.312426  
23  
400.31941  
33  
0.0  
0  
SOLID  
5  
FB12  
8  
0  
6  
CONTINUOUS  
10  
1705.312426  
20  
397.490983  
30  
0.0  
11  
1703.898212  
21  
400.905197  
31  
0.0  
12  
1703.898212  
22  
396.905197  
32  
0.0  
13  
1703.898212

23  
396.905197  
33  
0.0  
0  
SOLID  
5  
FB13  
8  
0  
6  
CONTINUOUS  
10  
1702.483998  
20  
400.31941  
30  
0.0  
11  
1703.898212  
21  
396.905197  
31  
0.0  
12  
1703.898212  
22  
400.905197  
32  
0.0  
13  
1703.898212  
23  
400.905197  
33  
0.0  
0  
SOLID  
5  
FB14  
8  
0  
6  
CONTINUOUS  
10  
1703.898212  
20  
396.905197  
30  
0.0  
11  
1702.483998  
21  
400.31941  
31  
0.0  
12  
1702.483998  
22  
397.490983  
32

0.0  
13  
1702.483998  
23  
397.490983  
33  
0.0  
0  
SOLID  
5  
FB15  
8  
0  
6  
CONTINUOUS  
10  
1701.898212  
20  
398.905197  
30  
0.0  
11  
1702.483998  
21  
397.490983  
31  
0.0  
12  
1702.483998  
22  
400.31941  
32  
0.0  
13  
1702.483998  
23  
400.31941  
33  
0.0  
0  
ENDBLK  
5  
FB17  
8  
0  
0  
BLOCK  
8  
0  
2  
\*U297  
70  
1  
10  
0.0  
20  
0.0  
30  
0.0  
3  
\*U297



1

0

SOLID

5

FB19

8

0

6

CONTINUOUS

10

1802.980178

20

469.439528

30

0.0

11

1802.394391

21

470.853742

31

0.0

12

1802.394391

22

468.025315

32

0.0

13

1802.394391

23

468.025315

33

0.0

0

SOLID

5

FB1A

8

0

6

CONTINUOUS

10

1800.980178

20

471.439528

30

0.0

11

1802.394391

21

468.025315

31

0.0

12

1802.394391

22

470.853742

32

0.0

13

1802.394391

23

470.853742

33

0.0

0

SOLID

5

FB1B

8

0

6

CONTINUOUS

10

1802.394391

20

468.025315

30

0.0

11

1800.980178

21

471.439528

31

0.0

12

1800.980178

22

467.439528

32

0.0

13

1800.980178

23

467.439528

33

0.0

0

SOLID

5

FB1C

8

0

6

CONTINUOUS

10

1799.565964

20

470.853742

30

0.0

11

1800.980178

21

467.439528

31

0.0

12

1800.980178

22

471.439528

32  
0.0  
13  
1800.980178  
23  
471.439528  
33  
0.0  
0  
SOLID  
5  
FB1D  
8  
0  
6  
CONTINUOUS  
10  
1800.980178  
20  
467.439528  
30  
0.0  
11  
1799.565964  
21  
470.853742  
31  
0.0  
12  
1799.565964  
22  
468.025315  
32  
0.0  
13  
1799.565964  
23  
468.025315  
33  
0.0  
0  
SOLID  
5  
FB1E  
8  
0  
6  
CONTINUOUS  
10  
1798.980178  
20  
469.439528  
30  
0.0  
11  
1799.565964  
21  
468.025315  
31  
0.0  
12

1799.565964

22

470.853742

32

0.0

13

1799.565964

23

470.853742

33

0.0

0

ENDBLK

5

FB20

8

0

0

BLOCK

8

0

2

\*U298

70

1

10

0.0

20

0.0

30

0.0

3

\*U298

1

0

SOLID

5

FB22

8

0

6

CONTINUOUS

10

1900.062143

20

539.97386

30

0.0

11

1899.476357

21

541.388074

31

0.0

12

1899.476357

22

538.559647

32

0.0

13  
1899.476357  
23  
538.559647  
33  
0.0  
0  
SOLID  
5  
FB23  
8  
0  
6  
CONTINUOUS  
10  
1898.062143  
20  
541.97386  
30  
0.0  
11  
1899.476357  
21  
538.559647  
31  
0.0  
12  
1899.476357  
22  
541.388074  
32  
0.0  
13  
1899.476357  
23  
541.388074  
33  
0.0  
0  
SOLID  
5  
FB24  
8  
0  
6  
CONTINUOUS  
10  
1899.476357  
20  
538.559647  
30  
0.0  
11  
1898.062143  
21  
541.97386  
31  
0.0  
12  
1898.062143  
22

537.97386  
32  
0.0  
13  
1898.062143  
23  
537.97386  
33  
0.0  
0  
SOLID  
5  
FB25  
8  
0  
6  
CONTINUOUS  
10  
1896.64793  
20  
541.388074  
30  
0.0  
11  
1898.062143  
21  
537.97386  
31  
0.0  
12  
1898.062143  
22  
541.97386  
32  
0.0  
13  
1898.062143  
23  
541.97386  
33  
0.0  
0  
SOLID  
5  
FB26  
8  
0  
6  
CONTINUOUS  
10  
1898.062143  
20  
537.97386  
30  
0.0  
11  
1896.64793  
21  
541.388074  
31  
0.0

12  
1896.64793  
22  
538.559647  
32  
0.0  
13  
1896.64793  
23  
538.559647  
33  
0.0  
0  
SOLID  
5  
FB27  
8  
0  
6  
CONTINUOUS  
10  
1896.062143  
20  
539.97386  
30  
0.0  
11  
1896.64793  
21  
538.559647  
31  
0.0  
12  
1896.64793  
22  
541.388074  
32  
0.0  
13  
1896.64793  
23  
541.388074  
33  
0.0  
0  
ENDBLK  
5  
FB29  
8  
0  
0  
BLOCK  
8  
0  
2  
\*U299  
70  
1  
10  
0.0  
20

0.0  
30  
0.0  
3  
\*U299  
1  
  
0  
SOLID  
5  
FD5C  
8  
0  
6  
CONTINUOUS  
10  
629.382983  
20  
372.337062  
30  
0.0  
11  
628.797197  
21  
373.751275  
31  
0.0  
12  
628.797197  
22  
370.922848  
32  
0.0  
13  
628.797197  
23  
370.922848  
33  
0.0  
0  
SOLID  
5  
FD5D  
8  
0  
6  
CONTINUOUS  
10  
627.382983  
20  
374.337062  
30  
0.0  
11  
628.797197  
21  
370.922848  
31  
0.0  
12  
628.797197



22  
373.751275  
32  
0.0  
13  
628.797197  
23  
373.751275  
33  
0.0  
0  
SOLID  
5  
FD5E  
8  
0  
6  
CONTINUOUS  
10  
628.797197  
20  
370.922848  
30  
0.0  
11  
627.382983  
21  
374.337062  
31  
0.0  
12  
627.382983  
22  
370.337062  
32  
0.0  
13  
627.382983  
23  
370.337062  
33  
0.0  
0  
SOLID  
5  
FD5F  
8  
0  
6  
CONTINUOUS  
10  
625.96877  
20  
373.751275  
30  
0.0  
11  
627.382983  
21  
370.337062  
31

0.0  
12  
627.382983  
22  
374.337062  
32  
0.0  
13  
627.382983  
23  
374.337062  
33  
0.0  
0  
SOLID  
5  
FD60  
8  
0  
6  
CONTINUOUS  
10  
627.382983  
20  
370.337062  
30  
0.0  
11  
625.96877  
21  
373.751275  
31  
0.0  
12  
625.96877  
22  
370.922848  
32  
0.0  
13  
625.96877  
23  
370.922848  
33  
0.0  
0  
SOLID  
5  
FD61  
8  
0  
6  
CONTINUOUS  
10  
625.382983  
20  
372.337062  
30  
0.0  
11  
625.96877

21  
370.922848  
31  
0.0  
12  
625.96877  
22  
373.751275  
32  
0.0  
13  
625.96877  
23  
373.751275  
33  
0.0  
0  
ENDBLK  
5  
FD63  
8  
0  
0  
BLOCK  
8  
0  
2  
\*U300  
70  
1  
10  
0.0  
20  
0.0  
30  
0.0  
3  
\*U300  
1  
0  
SOLID  
5  
FD65  
8  
0  
6  
CONTINUOUS  
10  
510.458466  
20  
285.885485  
30  
0.0  
11  
509.87268  
21  
287.299699  
31  
0.0  
12

509.87268  
22  
284.471272  
32  
0.0  
13  
509.87268  
23  
284.471272  
33  
0.0  
0  
SOLID  
5  
FD66  
8  
0  
6  
CONTINUOUS  
10  
508.458466  
20  
287.885485  
30  
0.0  
11  
509.87268  
21  
284.471272  
31  
0.0  
12  
509.87268  
22  
287.299699  
32  
0.0  
13  
509.87268  
23  
287.299699  
33  
0.0  
0  
SOLID  
5  
FD67  
8  
0  
6  
CONTINUOUS  
10  
509.87268  
20  
284.471272  
30  
0.0  
11  
508.458466  
21  
287.885485

31  
0.0  
12  
508.458466  
22  
283.885485  
32  
0.0  
13  
508.458466  
23  
283.885485  
33  
0.0  
0  
SOLID  
5  
FD68  
8  
0  
6  
CONTINUOUS  
10  
507.044253  
20  
287.299699  
30  
0.0  
11  
508.458466  
21  
283.885485  
31  
0.0  
12  
508.458466  
22  
287.885485  
32  
0.0  
13  
508.458466  
23  
287.885485  
33  
0.0  
0  
SOLID  
5  
FD69  
8  
0  
6  
CONTINUOUS  
10  
508.458466  
20  
283.885485  
30  
0.0  
11

507.044253

21

287.299699

31

0.0

12

507.044253

22

284.471272

32

0.0

13

507.044253

23

284.471272

33

0.0

0

SOLID

5

FD6A

8

0

6

CONTINUOUS

10

506.458466

20

285.885485

30

0.0

11

507.044253

21

284.471272

31

0.0

12

507.044253

22

287.299699

32

0.0

13

507.044253

23

287.299699

33

0.0

0

ENDBLK

5

FD6C

8

0

0

BLOCK

8

0

2

\*U301

70  
1  
10  
0.0  
20  
0.0  
30  
0.0  
3  
\*U301  
1  
  
0  
SOLID  
5  
FD6E  
8  
0  
6  
CONTINUOUS  
10  
543.832341  
20  
183.171394  
30  
0.0  
11  
543.246555  
21  
184.585608  
31  
0.0  
12  
543.246555  
22  
181.757181  
32  
0.0  
13  
543.246555  
23  
181.757181  
33  
0.0  
0  
SOLID  
5  
FD6F  
8  
0  
6  
CONTINUOUS  
10  
541.832341  
20  
185.171394  
30  
0.0  
11  
543.246555  
21

181.757181

31

0.0

12

543.246555

22

184.585608

32

0.0

13

543.246555

23

184.585608

33

0.0

0

SOLID

5

FD70

8

0

6

CONTINUOUS

10

543.246555

20

181.757181

30

0.0

11

541.832341

21

185.171394

31

0.0

12

541.832341

22

181.171394

32

0.0

13

541.832341

23

181.171394

33

0.0

0

SOLID

5

FD71

8

0

6

CONTINUOUS

10

540.418128

20

184.585608

30

0.0



11  
541.832341  
21  
181.171394  
31  
0.0  
12  
541.832341  
22  
185.171394  
32  
0.0  
13  
541.832341  
23  
185.171394  
33  
0.0  
0  
SOLID  
5  
FD72  
8  
0  
6  
CONTINUOUS  
10  
541.832341  
20  
181.171394  
30  
0.0  
11  
540.418128  
21  
184.585608  
31  
0.0  
12  
540.418128  
22  
181.757181  
32  
0.0  
13  
540.418128  
23  
181.757181  
33  
0.0  
0  
SOLID  
5  
FD73  
8  
0  
6  
CONTINUOUS  
10  
539.832341  
20

183.171394

30

0.0

11

540.418128

21

181.757181

31

0.0

12

540.418128

22

184.585608

32

0.0

13

540.418128

23

184.585608

33

0.0

0

ENDBLK

5

FD75

8

0

0

BLOCK

8

0

2

\*U302

70

1

10

0.0

20

0.0

30

0.0

3

\*U302

1

0

SOLID

5

FD8B

8

0

6

CONTINUOUS

10

674.706103

20

339.252729

30

0.0

11

674.120317

21  
340.666942  
31  
0.0  
12  
674.120317  
22  
337.838515  
32  
0.0  
13  
674.120317  
23  
337.838515  
33  
0.0  
0  
SOLID  
5  
FD8C  
8  
0  
6  
CONTINUOUS  
10  
672.706103  
20  
341.252729  
30  
0.0  
11  
674.120317  
21  
337.838515  
31  
0.0  
12  
674.120317  
22  
340.666942  
32  
0.0  
13  
674.120317  
23  
340.666942  
33  
0.0  
0  
SOLID  
5  
FD8D  
8  
0  
6  
CONTINUOUS  
10  
674.120317  
20  
337.838515  
30

0.0  
11  
672.706103  
21  
341.252729  
31  
0.0  
12  
672.706103  
22  
337.252729  
32  
0.0  
13  
672.706103  
23  
337.252729  
33  
0.0  
0  
SOLID  
5  
FD8E  
8  
0  
6  
CONTINUOUS  
10  
671.29189  
20  
340.666942  
30  
0.0  
11  
672.706103  
21  
337.252729  
31  
0.0  
12  
672.706103  
22  
341.252729  
32  
0.0  
13  
672.706103  
23  
341.252729  
33  
0.0  
0  
SOLID  
5  
FD8F  
8  
0  
6  
CONTINUOUS  
10  
672.706103

20  
337.252729  
30  
0.0  
11  
671.29189  
21  
340.666942  
31  
0.0  
12  
671.29189  
22  
337.838515  
32  
0.0  
13  
671.29189  
23  
337.838515  
33  
0.0  
0  
SOLID  
5  
FD90  
8  
0  
6  
CONTINUOUS  
10  
670.706103  
20  
339.252729  
30  
0.0  
11  
671.29189  
21  
337.838515  
31  
0.0  
12  
671.29189  
22  
340.666942  
32  
0.0  
13  
671.29189  
23  
340.666942  
33  
0.0  
0  
ENDBLK  
5  
FD92  
8  
0  
0

BLOCK

8

0

2

\*U303

70

1

10

0.0

20

0.0

30

0.0

3

\*U303

1

0

SOLID

5

FD94

8

0

6

CONTINUOUS

10

748.422372

20

363.204557

30

0.0

11

747.836586

21

364.618771

31

0.0

12

747.836586

22

361.790344

32

0.0

13

747.836586

23

361.790344

33

0.0

0

SOLID

5

FD95

8

0

6

CONTINUOUS

10

746.422372

20

365.204557

30  
0.0  
11  
747.836586  
21  
361.790344  
31  
0.0  
12  
747.836586  
22  
364.618771  
32  
0.0  
13  
747.836586  
23  
364.618771  
33  
0.0  
0  
SOLID  
5  
FD96  
8  
0  
6  
CONTINUOUS  
10  
747.836586  
20  
361.790344  
30  
0.0  
11  
746.422372  
21  
365.204557  
31  
0.0  
12  
746.422372  
22  
361.204557  
32  
0.0  
13  
746.422372  
23  
361.204557  
33  
0.0  
0  
SOLID  
5  
FD97  
8  
0  
6  
CONTINUOUS  
10

745.008159

20

364.618771

30

0.0

11

746.422372

21

361.204557

31

0.0

12

746.422372

22

365.204557

32

0.0

13

746.422372

23

365.204557

33

0.0

0

SOLID

5

FD98

8

0

6

CONTINUOUS

10

746.422372

20

361.204557

30

0.0

11

745.008159

21

364.618771

31

0.0

12

745.008159

22

361.790344

32

0.0

13

745.008159

23

361.790344

33

0.0

0

SOLID

5

FD99

8

0



6  
CONTINUOUS  
10  
744.422372  
20  
363.204557  
30  
0.0  
11  
745.008159  
21  
361.790344  
31  
0.0  
12  
745.008159  
22  
364.618771  
32  
0.0  
13  
745.008159  
23  
364.618771  
33  
0.0  
0  
ENDBLK  
5  
FD9B  
8  
0  
0  
BLOCK  
8  
0  
2  
\*U304  
70  
1  
10  
0.0  
20  
0.0  
30  
0.0  
3  
\*U304  
1  
0  
SOLID  
5  
FD9D  
8  
0  
6  
CONTINUOUS  
10  
477.084591  
20

388.599576

30

0.0

11

476.498805

21

390.01379

31

0.0

12

476.498805

22

387.185362

32

0.0

13

476.498805

23

387.185362

33

0.0

0

SOLID

5

FD9E

8

0

6

CONTINUOUS

10

475.084591

20

390.599576

30

0.0

11

476.498805

21

387.185362

31

0.0

12

476.498805

22

390.01379

32

0.0

13

476.498805

23

390.01379

33

0.0

0

SOLID

5

FD9F

8

0

6

CONTINUOUS

10  
476.498805  
20  
387.185362  
30  
0.0  
11  
475.084591  
21  
390.599576  
31  
0.0  
12  
475.084591  
22  
386.599576  
32  
0.0  
13  
475.084591  
23  
386.599576  
33  
0.0  
0  
SOLID  
5  
FDA0  
8  
0  
6  
CONTINUOUS  
10  
473.670378  
20  
390.01379  
30  
0.0  
11  
475.084591  
21  
386.599576  
31  
0.0  
12  
475.084591  
22  
390.599576  
32  
0.0  
13  
475.084591  
23  
390.599576  
33  
0.0  
0  
SOLID  
5  
FDA1  
8

0  
6  
CONTINUOUS  
10  
475.084591  
20  
386.599576  
30  
0.0  
11  
473.670378  
21  
390.01379  
31  
0.0  
12  
473.670378  
22  
387.185362  
32  
0.0  
13  
473.670378  
23  
387.185362  
33  
0.0  
0  
SOLID  
5  
FDA2  
8  
0  
6  
CONTINUOUS  
10  
473.084591  
20  
388.599576  
30  
0.0  
11  
473.670378  
21  
387.185362  
31  
0.0  
12  
473.670378  
22  
390.01379  
32  
0.0  
13  
473.670378  
23  
390.01379  
33  
0.0  
0  
ENDBLK

5  
FDA4  
8  
0  
0  
BLOCK  
8  
0  
2  
\*U305  
70  
1  
10  
0.0  
20  
0.0  
30  
0.0  
3  
\*U305  
1  
0  
SOLID  
5  
FDA6  
8  
0  
6  
CONTINUOUS  
10  
583.912225  
20  
405.218289  
30  
0.0  
11  
583.326439  
21  
406.632502  
31  
0.0  
12  
583.326439  
22  
403.804075  
32  
0.0  
13  
583.326439  
23  
403.804075  
33  
0.0  
0  
SOLID  
5  
FDA7  
8  
0  
6

CONTINUOUS

10  
581.912225  
20  
407.218289  
30  
0.0  
11  
583.326439  
21  
403.804075  
31  
0.0  
12  
583.326439  
22  
406.632502  
32  
0.0  
13  
583.326439  
23  
406.632502  
33  
0.0  
0

SOLID

5  
FDA8  
8  
0

6

CONTINUOUS

10  
583.326439  
20  
403.804075  
30  
0.0  
11  
581.912225  
21  
407.218289  
31  
0.0  
12  
581.912225  
22  
403.218289  
32  
0.0  
13  
581.912225  
23  
403.218289  
33  
0.0  
0

SOLID

5  
FDA9

8  
0  
6  
CONTINUOUS  
10  
580.498011  
20  
406.632502  
30  
0.0  
11  
581.912225  
21  
403.218289  
31  
0.0  
12  
581.912225  
22  
407.218289  
32  
0.0  
13  
581.912225  
23  
407.218289  
33  
0.0  
0

SOLID  
5  
FDAA  
8  
0  
6  
CONTINUOUS  
10  
581.912225  
20  
403.218289  
30  
0.0  
11  
580.498011  
21  
406.632502  
31  
0.0  
12  
580.498011  
22  
403.804075  
32  
0.0  
13  
580.498011  
23  
403.804075  
33  
0.0  
0

SOLID  
5  
FDAB  
8  
0  
6  
CONTINUOUS  
10  
579.912225  
20  
405.218289  
30  
0.0  
11  
580.498011  
21  
403.804075  
31  
0.0  
12  
580.498011  
22  
406.632502  
32  
0.0  
13  
580.498011  
23  
406.632502  
33  
0.0  
0  
ENDBLK  
5  
FDAD  
8  
0  
0  
BLOCK  
8  
0  
2  
\*U306  
70  
1  
10  
0.0  
20  
0.0  
30  
0.0  
3  
\*U306  
1  
0  
SOLID  
5  
FDAF  
8  
0



6  
CONTINUOUS  
10  
583.912262  
20  
482.728149  
30  
0.0  
11  
583.326475  
21  
484.142362  
31  
0.0  
12  
583.326475  
22  
481.313935  
32  
0.0  
13  
583.326475  
23  
481.313935  
33  
0.0  
0

SOLID

5  
FDB0  
8  
0

6  
CONTINUOUS  
10  
581.912262  
20  
484.728149  
30  
0.0  
11  
583.326475  
21  
481.313935  
31  
0.0  
12  
583.326475  
22  
484.142362  
32  
0.0  
13  
583.326475  
23  
484.142362  
33  
0.0  
0

SOLID

5

FDB1  
8  
0  
6  
CONTINUOUS  
10  
583.326475  
20  
481.313935  
30  
0.0  
11  
581.912262  
21  
484.728149  
31  
0.0  
12  
581.912262  
22  
480.728149  
32  
0.0  
13  
581.912262  
23  
480.728149  
33  
0.0  
0

SOLID  
5

FDB2  
8  
0  
6  
CONTINUOUS  
10  
580.498048  
20  
484.142362  
30  
0.0  
11  
581.912262  
21  
480.728149  
31  
0.0  
12  
581.912262  
22  
484.728149  
32  
0.0  
13  
581.912262  
23  
484.728149  
33  
0.0

0  
SOLID  
5  
FDB3  
8  
0  
6  
CONTINUOUS  
10  
581.912262  
20  
480.728149  
30  
0.0  
11  
580.498048  
21  
484.142362  
31  
0.0  
12  
580.498048  
22  
481.313935  
32  
0.0  
13  
580.498048  
23  
481.313935  
33  
0.0  
0  
SOLID  
5  
FDB4  
8  
0  
6  
CONTINUOUS  
10  
579.912262  
20  
482.728149  
30  
0.0  
11  
580.498048  
21  
481.313935  
31  
0.0  
12  
580.498048  
22  
484.142362  
32  
0.0  
13  
580.498048  
23

484.142362  
33  
0.0  
0  
ENDBLK  
5  
FDB6  
8  
0  
0  
ENDSEC  
0  
SECTION  
2  
ENTITIES  
0  
SOLID  
5  
F4E0  
8  
1SOLID  
10  
4934.034602  
20  
4626.076725  
30  
0.0  
11  
4929.848339  
21  
4588.190242  
31  
0.0  
12  
4926.148193  
22  
4625.269068  
32  
0.0  
13  
4922.14522  
23  
4589.041397  
33  
0.0  
0  
LINE  
5  
F4E1  
8  
1FLR  
10  
4926.148193  
20  
4625.269068  
30  
0.0  
11  
4922.14522  
21  
4589.041397

31  
0.0  
0  
LINE  
5  
F4E2  
8  
1FLR  
10  
4934.034602  
20  
4626.076725  
30  
0.0  
11  
4929.848339  
21  
4588.190242  
31  
0.0  
0  
SOLID  
5  
F4E3  
8  
1SOLID  
10  
4765.837336  
20  
4602.502188  
30  
0.0  
11  
4758.628615  
21  
4624.688351  
31  
0.0  
12  
4761.105756  
22  
4602.502188  
32  
0.0  
13  
4754.348862  
23  
4623.29777  
33  
0.0  
0  
LINE  
5  
F4E4  
8  
1FLR  
10  
4765.837336  
20  
4602.502188  
30

0.0  
11  
4758.628615  
21  
4624.688351  
31  
0.0  
0  
LINE  
5  
F4E5  
8  
1FLR  
10  
4761.105756  
20  
4602.502188  
30  
0.0  
11  
4754.348862  
21  
4623.29777  
31  
0.0  
0  
INSERT  
5  
F4E6  
8  
1CP  
2  
SK1419  
10  
4777.734079  
20  
4609.670953  
30  
0.0  
50  
8.082928  
0  
INSERT  
5  
F4E7  
8  
FUR  
2  
BEDD  
10  
4835.042704  
20  
4613.814211  
30  
0.0  
50  
98.082928  
0  
SOLID  
5  
F4E8

8  
1SOLID  
10  
4924.736524  
20  
4629.61374  
30  
0.0  
11  
4764.425666  
21  
4606.84686  
31  
0.0  
12  
4926.148193  
22  
4625.269068  
32  
0.0  
13  
4765.837336  
23  
4602.502188  
33  
0.0  
0

LINE  
5  
F4E9  
8  
1FLR  
10  
4926.148193  
20  
4625.269068  
30  
0.0  
11  
4765.837336  
21  
4602.502188  
31  
0.0  
0

LINE  
5  
F4EA  
8  
1FLR  
10  
4906.747742  
20  
4627.059026  
30  
0.0  
11  
4764.425666  
21  
4606.84686  
31

0.0  
0  
LINE  
5  
F4EB  
8  
1HDN  
10  
4511.787599  
20  
4635.507682  
30  
0.0  
11  
4551.597449  
21  
4512.985687  
31  
0.0  
0  
SOLID  
5  
F4EC  
8  
1SOLID  
10  
4371.88417  
20  
4582.093017  
30  
0.0  
11  
4358.155155  
21  
4624.34658  
31  
0.0  
12  
4367.604416  
22  
4580.702441  
32  
0.0  
13  
4353.875401  
23  
4622.956004  
33  
0.0  
0  
LINE  
5  
F4ED  
8  
1FLR  
10  
4358.155155  
20  
4624.34658  
30  
0.0



11  
4371.88417  
21  
4582.093017  
31  
0.0  
0  
LINE  
5  
F4EE  
8  
1FLR  
10  
4353.875401  
20  
4622.956004  
30  
0.0  
11  
4367.604416  
21  
4580.702441  
31  
0.0  
0  
INSERT  
5  
F4EF  
8  
FUR  
2  
SOFALG  
10  
4670.788291  
20  
4630.050621  
30  
0.0  
50  
54.000005  
0  
POLYLINE  
5  
F4F0  
8  
TEXT1  
66  
1  
10  
0.0  
20  
0.0  
30  
0.0  
40  
1.5  
41  
1.5  
0  
VERTEX  
5

10135  
8  
TEXT1  
10  
4557.838276  
20  
4261.301081  
30  
0.0  
0  
VERTEX  
5  
10136  
8  
TEXT1  
10  
4730.303519  
20  
4261.301081  
30  
0.0  
0  
SEQEND  
5  
10137  
8  
TEXT1  
0  
TEXT  
5  
F4F1  
8  
TEXT1  
10  
4564.479048  
20  
4264.301081  
30  
0.0  
40  
12.0  
1  
FIRST FLOOR PLAN  
7  
TAHOMA  
0  
LINE  
5  
F4F2  
8  
1HDN  
10  
4722.166235  
20  
4482.658704  
30  
0.0  
11  
4593.338968  
21  
4482.658704

31  
0.0  
0  
INSERT  
5  
F4F3  
8  
1WD  
2  
D30  
10  
4679.571031  
20  
4327.709033  
30  
0.0  
50  
180.000062  
0  
LINE  
5  
F4F4  
8  
1TXT  
10  
4603.085543  
20  
4423.71834  
30  
0.0  
11  
4686.307771  
21  
4423.71834  
31  
0.0  
0  
TEXT  
5  
F4F5  
8  
1DIM  
10  
4631.966416  
20  
4461.303291  
30  
0.0  
40  
6.0  
1  
2ND FLOOR  
7  
ROMANS  
0  
INSERT  
5  
F4F6  
8  
FUR  
2

TBLSM

10  
4462.430623  
20  
4537.372864  
30  
0.0  
50  
198.0

0  
LINE

5  
F4F7  
8  
1STR  
10  
4489.43091  
20  
4416.534418  
30  
0.0  
11  
4464.156184  
21  
4381.746658  
31  
0.0  
0

LINE

5  
F4F8  
8  
1STR  
10  
4462.733327  
20  
4435.9313  
30  
0.0  
11  
4491.048945  
21  
4415.358849  
31  
0.0  
0

LINE

5  
F4F9  
8  
1STR  
10  
4463.908895  
20  
4437.549336  
30  
0.0  
11  
4490.606479  
21  
4418.152453

31  
0.0  
0  
LINE  
5  
F4FA  
8  
1STR  
10  
4480.531716  
20  
4423.000045  
30  
0.0  
11  
4455.25699  
21  
4388.212285  
31  
0.0  
0  
SOLID  
5  
F4FB  
8  
1SOLID  
10  
4523.937676  
20  
4328.123867  
30  
0.0  
11  
4427.044945  
21  
4398.520557  
31  
0.0  
12  
4527.142837  
22  
4335.374708  
32  
0.0  
13  
4432.950455  
23  
4403.80948  
33  
0.0  
0  
LINE  
5  
F4FC  
8  
1FLR  
10  
4427.839536  
20  
4397.943219  
30

0.0  
11  
4523.142963  
21  
4328.701388  
31  
0.0  
0  
LINE  
5  
F4FD  
8  
1FLR  
10  
4432.950215  
20  
4403.809621  
30  
0.0  
11  
4527.142964  
21  
4335.374743  
31  
0.0  
0  
TEXT  
5  
F4FE  
8  
1DIM  
10  
4439.295404  
20  
4465.278607  
30  
0.0  
40  
6.0  
1  
VAULTED  
0  
SOLID  
5  
F4FF  
8  
1SOLID  
10  
4430.111632  
20  
4402.887316  
30  
0.0  
11  
4416.382617  
21  
4445.140879  
31  
0.0  
12  
4425.831878

22  
4401.496739  
32  
0.0  
13  
4412.102863  
23  
4443.750302  
33  
0.0  
0  
LINE  
5  
F500  
8  
1FLR  
10  
4412.102863  
20  
4443.750302  
30  
0.0  
11  
4425.831878  
21  
4401.496739  
31  
0.0  
0  
LINE  
5  
F501  
8  
1FLR  
10  
4416.382617  
20  
4445.140879  
30  
0.0  
11  
4430.111632  
21  
4402.887316  
31  
0.0  
0  
TEXT  
5  
F502  
8  
1DIM  
10  
4381.83835  
20  
4469.158499  
30  
0.0  
40  
6.0  
1

ENTRYWAY

50

288.0

7

ROMANS

0

TEXT

5

F503

8

1DIM

10

4391.077184

20

4472.160379

30

0.0

40

6.0

1

HIGH PROFILE

50

288.0

7

ROMANS

0

SOLID

5

F504

8

1SOLID

10

4401.565341

20

4393.61209

30

0.0

11

4432.950215

21

4403.809621

31

0.0

12

4402.801405

22

4389.807863

32

0.0

13

4427.839536

23

4397.943219

33

0.0

0

LINE

5

F505

8

1FLR



10  
4427.839536  
20  
4397.943219  
30  
0.0  
11  
4402.801405  
21  
4389.807863  
31  
0.0  
0  
LINE  
5  
F506  
8  
1FLR  
10  
4425.831638  
20  
4401.496668  
30  
0.0  
11  
4401.565341  
21  
4393.61209  
31  
0.0  
0  
LINE  
5  
F507  
8  
1FLR  
10  
4401.565341  
20  
4393.61209  
30  
0.0  
11  
4402.801405  
21  
4389.807863  
31  
0.0  
0  
LINE  
5  
F508  
8  
1STR  
10  
4463.908895  
20  
4437.549336  
30  
0.0  
11

4437.458601

21

4401.14354

31

0.0

0

LINE

5

F509

8

1STR

10

4471.632521

20

4429.465673

30

0.0

11

4446.357795

21

4394.677913

31

0.0

0

LINE

5

F50A

8

1FLR

10

4432.950215

20

4403.809621

30

0.0

11

4430.111394

21

4402.887238

31

0.0

0

LINE

5

F50B

8

1FLR

10

4367.604416

20

4580.702441

30

0.0

11

4371.88417

21

4582.093017

31

0.0

0

INSERT

5  
F50C  
8  
1WD  
2  
SD120  
10  
4414.004976  
20  
4444.368336  
30  
0.0  
50  
108.0  
0

POLYLINE

5  
F50D  
8  
1HDN  
66  
1  
10  
0.0  
20  
0.0  
30  
0.0  
70  
1

0  
VERTEX  
5  
10138  
8  
1HDN  
10  
4461.5823  
20  
4535.53238  
30  
0.0  
0

VERTEX  
5  
10139  
8  
1HDN  
10  
4436.195734  
20  
4492.006573  
30  
0.0  
0

VERTEX  
5  
1013A  
8  
1HDN  
10

4415.46031  
20  
4555.823648  
30  
0.0  
0  
SEQEND  
5  
1013B  
8  
1HDN  
0  
LINE  
5  
F50E  
8  
1FLR  
10  
4412.102863  
20  
4443.750302  
30  
0.0  
11  
4416.382617  
21  
4445.140879  
31  
0.0  
0  
TEXT  
5  
F50F  
8  
1DIM  
10  
4439.295404  
20  
4454.992893  
30  
0.0  
40  
6.0  
1  
CEILING  
0  
TEXT  
5  
F510  
8  
1DIM  
10  
4393.252378  
20  
4606.067185  
30  
0.0  
40  
6.0  
1  
257 SQ. FT.

7  
ROMANS  
0  
TEXT  
5  
F511  
8  
1DIM  
10  
4430.67229  
20  
4527.353667  
30  
0.0  
40  
6.0  
1

SK  
7  
ROMANS  
0

LINE  
5  
F512  
8  
1STR  
62  
1

10  
4552.090589  
20  
4434.726104  
30  
0.0  
11  
4544.021878  
21  
4452.762366  
31  
0.0  
0

LINE  
5  
F513  
8  
1STR  
10  
4518.087024  
20  
4452.573662  
30  
0.0  
11  
4547.21166  
21  
4431.413427  
31  
0.0  
0

LINE  
5

F514  
8  
1STR  
10  
4511.621396  
20  
4443.674468  
30  
0.0  
11  
4540.746032  
21  
4422.514232  
31  
0.0  
0

LINE  
5  
F515  
8  
1STR  
10  
4533.248543  
20  
4476.844362  
30  
0.0  
11  
4490.606479  
21  
4418.152453  
31  
0.0  
0

LINE  
5  
F516  
8  
1STR  
10  
4534.190646  
20  
4474.738449  
30  
0.0  
11  
4491.048945  
21  
4415.358849  
31  
0.0  
0

LINE  
5  
F517  
8  
1HDN  
10  
4552.090589  
20  
4434.726104

30  
0.0  
11  
4589.134854  
21  
4485.713171  
31  
0.0  
0  
TEXT  
5  
F518  
8  
1DIM  
10  
4550.106235  
20  
4407.503249  
30  
0.0  
40  
6.0  
1  
VAULTED  
0  
TEXT  
5  
F519  
8  
1DIM  
10  
4550.106235  
20  
4397.217534  
30  
0.0  
40  
6.0  
1  
CEILING  
0  
LINE  
5  
F51A  
8  
1W  
10  
4590.226925  
20  
4327.889979  
30  
0.0  
11  
4554.349183  
21  
4327.89002  
31  
0.0  
0  
LINE  
5

F51B

8

1W

10

4554.349188

20

4332.39002

30

0.0

11

4590.22693

21

4332.389979

31

0.0

0

LINE

5

F51C

8

1W

10

4554.349186

20

4330.14002

30

0.0

11

4590.226928

21

4330.139979

31

0.0

0

LINE

5

F51D

8

1STR

10

4549.664768

20

4375.244198

30

0.0

11

4523.214474

21

4338.838403

31

0.0

0

LINE

5

F51E

8

1STR

10

4539.590005

20

4380.09179



30  
0.0  
11  
4514.315279  
21  
4345.30403  
31  
0.0  
0  
LINE  
5  
F51F  
8  
1FLR  
10  
4527.142959  
20  
4302.374743  
30  
0.0  
11  
4523.142959  
21  
4302.374744  
31  
0.0  
0  
SOLID  
5  
F520  
8  
1SOLID  
10  
4527.142959  
20  
4302.374743  
30  
0.0  
11  
4527.142964  
21  
4335.374743  
31  
0.0  
12  
4523.142959  
22  
4302.374744  
32  
0.0  
13  
4523.142963  
23  
4328.701388  
33  
0.0  
0  
LINE  
5  
F521  
8

1FLR  
10  
4523.142963  
20  
4328.701388  
30  
0.0  
11  
4523.142959  
21  
4302.374744  
31  
0.0  
0  
LINE  
5  
F522  
8  
1FLR  
10  
4527.142963  
20  
4327.890044  
30  
0.0  
11  
4527.142959  
21  
4302.374743  
31  
0.0  
0  
SOLID  
5  
F523  
8  
1SOLID  
10  
4554.349188  
20  
4332.39002  
30  
0.0  
11  
4527.142958  
21  
4332.390052  
31  
0.0  
12  
4554.349183  
22  
4327.89002  
32  
0.0  
13  
4527.142957  
23  
4327.890052  
33  
0.0

0  
LINE  
5  
F524  
8  
1FLR  
10  
4527.142957  
20  
4327.890052  
30  
0.0  
11  
4554.349183  
21  
4327.89002  
31  
0.0  
0

LINE  
5  
F525  
8  
1FLR  
10  
4527.142958  
20  
4332.390052  
30  
0.0  
11  
4554.349188  
21  
4332.39002  
31  
0.0  
0

LINE  
5  
F526  
8  
1FLR  
10  
4527.142964  
20  
4335.374743  
30  
0.0  
11  
4527.142963  
21  
4332.390044  
31  
0.0  
0

LINE  
5  
F527  
8  
1FLR  
10

4554.349183

20

4327.89002

30

0.0

11

4554.349188

21

4332.39002

31

0.0

0

LINE

5

F528

8

1STR

10

4522.967185

20

4394.641081

30

0.0

11

4549.664768

21

4375.244198

31

0.0

0

LINE

5

F529

8

1STR

10

4520.173581

20

4394.198614

30

0.0

11

4548.489199

21

4373.626163

31

0.0

0

LINE

5

F52A

8

1STR

10

4552.090589

20

4434.726104

30

0.0

11

4522.967185

21  
4394.641081  
31  
0.0  
0  
LINE  
5  
F52B  
8  
1STR  
10  
4551.148487  
20  
4436.832017  
30  
0.0  
11  
4520.173581  
21  
4394.198614  
31  
0.0  
0  
LINE  
5  
F52C  
8  
1STR  
10  
4505.155769  
20  
4434.775273  
30  
0.0  
11  
4534.280405  
21  
4413.615038  
31  
0.0  
0  
LINE  
5  
F52D  
8  
1STR  
10  
4498.690141  
20  
4425.876079  
30  
0.0  
11  
4527.814777  
21  
4404.715844  
31  
0.0  
0  
LINE  
5

F52E

8

1STR

10

4530.690811

20

4386.557418

30

0.0

11

4505.416085

21

4351.769658

31

0.0

0

TEXT

5

F52F

8

1DIM

10

4479.49743

20

4391.266709

30

0.0

40

5.0

1

UP

7

ROMANS

72

2

11

4489.02124

21

4393.766709

31

0.0

73

2

0

LINE

5

F530

8

1DIM

10

4519.333599

20

4425.911432

30

0.0

11

4494.11124

21

4388.766709

31

0.0

0  
LINE  
5  
F531  
8  
1STR  
10  
4521.791616  
20  
4393.023045  
30  
0.0  
11  
4496.516891  
21  
4358.235285  
31  
0.0  
0

LINE  
5  
F532  
8  
1DIM  
10  
4494.11124  
20  
4388.766709  
30  
0.0  
11  
4489.11124  
21  
4388.766709  
31  
0.0  
0

LINE  
5  
F533  
8  
1DIM  
10  
4489.11124  
20  
4388.766709  
30  
0.0  
11  
4480.449811  
21  
4388.766709  
31  
0.0  
0

LINE  
5  
F534  
8  
1STR  
10

4492.224514

20

4416.976884

30

0.0

11

4521.34915

21

4395.816649

31

0.0

0

SOLID

5

F535

8

1DIM

10

4518.644182

20

4426.379566

30

0.0

11

4520.023015

21

4425.443298

31

0.0

12

4522.142403

22

4430.04793

32

0.0

13

4522.142403

23

4430.04793

33

0.0

0

INSERT

5

F536

8

1WD

2

D30

10

4607.571031

20

4327.708961

30

0.0

41

-1.0

50

180.0

0

SOLID



5  
F537  
8  
1SOLID  
10  
4607.571027  
20  
4332.389964  
30  
0.0  
11  
4590.22693  
21  
4332.389979  
31  
0.0  
12  
4607.571021  
22  
4327.889964  
32  
0.0  
13  
4590.226925  
23  
4327.889979  
33  
0.0  
0

LINE  
5  
F538  
8  
1FLR  
10  
4590.226925  
20  
4327.889979  
30  
0.0  
11  
4607.571021  
21  
4327.889964  
31  
0.0  
0

LINE  
5  
F539  
8  
1FLR  
10  
4590.22693  
20  
4332.389979  
30  
0.0  
11  
4607.571027  
21

4332.389964

31

0.0

0

LINE

5

F53A

8

1FLR

10

4590.226925

20

4327.889979

30

0.0

11

4590.22693

21

4332.389979

31

0.0

0

LINE

5

F53B

8

1FLR

10

4607.571027

20

4327.889962

30

0.0

11

4607.571032

21

4332.389962

31

0.0

0

TEXT

5

F53C

8

1TXT

10

4603.085543

20

4426.71834

30

0.0

40

8.0

1

LIVING ROOM

0

TEXT

5

F53D

8

1DIM

10  
4603.085543  
20  
4414.71834  
30  
0.0  
40  
6.0  
1  
257 SQ. FT.

7  
ROMANS  
0  
POLYLINE

5  
F53E  
8  
1HDN  
66  
1

10  
0.0  
20  
0.0  
30  
0.0  
70  
1

0  
VERTEX  
5  
1013C

8  
1HDN  
10  
4677.121655  
20  
4365.715554  
30  
0.0  
0

VERTEX  
5  
1013D

8  
1HDN  
10  
4643.571034  
20  
4403.309824  
30  
0.0  
0

VERTEX  
5  
1013E

8  
1HDN  
10  
4610.020413  
20

4365.715553

30

0.0

0

SEQEND

5

1013F

8

1HDN

0

TEXT

5

F53F

8

1DIM

10

4637.217708

20

4374.023415

30

0.0

40

6.0

1

SK

7

ROMANS

0

LINE

5

F540

8

1HDN

10

4593.338968

20

4482.658704

30

0.0

11

4551.597449

21

4512.985687

31

0.0

0

SOLID

5

F541

8

1SOLID

10

4565.442816

20

4545.570783

30

0.0

11

4621.023473

21

4505.18908

31  
0.0  
12  
4561.614888  
22  
4542.78963  
32  
0.0  
13  
4619.561335  
23  
4500.68908  
33  
0.0  
0

POLYLINE

5  
F542  
8  
FUR  
66  
1  
10  
0.0  
20  
0.0  
30  
0.0  
70

1

0  
VERTEX

5  
10140  
8  
FUR  
10  
4568.413268  
20  
4546.312894  
30  
0.0  
0

VERTEX

5  
10141  
8  
FUR  
10  
4619.816469  
20  
4508.966302  
30  
0.0  
0

VERTEX

5  
10142  
8  
FUR  
10

4630.3966  
20  
4523.52861  
30  
0.0  
0  
VERTEX  
5  
10143  
8  
FUR  
10  
4578.993399  
20  
4560.875203  
30  
0.0  
0  
SEQEND  
5  
10144  
8  
FUR  
0  
LINE  
5  
F543  
8  
1FLR  
10  
4565.442816  
20  
4545.570783  
30  
0.0  
11  
4621.023473  
21  
4505.18908  
31  
0.0  
0  
LINE  
5  
F544  
8  
1FLR  
10  
4561.614888  
20  
4542.78963  
30  
0.0  
11  
4619.561335  
21  
4500.68908  
31  
0.0  
0  
LINE

5  
F545  
8  
1HDN  
10  
4533.248543  
20  
4476.844362  
30  
0.0  
11  
4556.774153  
21  
4509.224592  
31  
0.0  
0

LINE  
5  
F546  
8  
1STR  
10  
4524.552651  
20  
4461.472856  
30  
0.0  
11  
4547.623894  
21  
4444.710658  
31  
0.0  
0

LINE  
5  
F547  
8  
1STR  
62  
1  
10  
4543.437721  
20  
4454.068152  
30  
0.0  
11  
4541.500644  
21  
4453.376084  
31  
0.0  
0

ARC  
5  
F548  
8  
1STR  
62

1

10  
4545.76533  
20  
4453.66713  
30  
0.0  
40  
1.160758  
50  
261.202841  
51  
109.660497  
0  
ARC  
5  
F549  
8  
1STR  
62

1

10  
4541.110111  
20  
4454.469173  
30  
0.0  
40  
1.160758  
50  
81.202841  
51  
289.660497  
0  
LINE  
5  
F54A  
8  
1STR  
62

1

10  
4544.021878  
20  
4452.762366  
30  
0.0  
11  
4545.587808  
21  
4452.520026  
31  
0.0  
0  
LINE  
5  
F54B  
8  
1STR  
62

1



10  
4542.853564  
20  
4455.373937  
30  
0.0  
11  
4541.287634  
21  
4455.616277  
31  
0.0  
0

LINE

5  
F54C  
8  
1STR  
62

1

10  
4543.437721  
20  
4454.068152  
30  
0.0  
11  
4545.374798  
21  
4454.760219  
31  
0.0  
0

LINE

5  
F54D  
8  
1STR  
62

1

10  
4542.853564  
20  
4455.373937  
30  
0.0  
11  
4533.248543  
21  
4476.844362  
31  
0.0  
0

LINE

5  
F54E  
8  
1STR  
10

4531.018279  
20

4470.372051

30

0.0

11

4538.612228

21

4464.854737

31

0.0

0

SOLID

5

F54F

8

1SOLID

10

4549.403278

20

4594.935377

30

0.0

11

4565.442816

21

4545.570783

31

0.0

12

4545.123524

22

4593.5448

32

0.0

13

4561.614888

23

4542.78963

33

0.0

0

LINE

5

F550

8

1FLR

10

4561.614888

20

4542.78963

30

0.0

11

4545.123524

21

4593.5448

31

0.0

0

LINE

5

F551

8  
1FLR  
10  
4565.442816  
20  
4545.570783  
30  
0.0  
11  
4549.403278  
21  
4594.935377  
31  
0.0  
0

LINE  
5  
F552  
8  
1FLR  
10  
4545.123524  
20  
4593.5448  
30  
0.0  
11  
4549.403278  
21  
4594.935377  
31  
0.0  
0

POLYLINE  
5  
F553  
8  
FUR  
66  
1  
10  
0.0  
20  
0.0  
30  
0.0  
70  
1  
0

VERTEX  
5  
10145  
8  
FUR  
10  
4560.08242  
20  
4570.387549  
30  
0.0  
0

VERTEX

5

10146

8

FUR

10

4555.447165

20

4584.653396

30

0.0

0

VERTEX

5

10147

8

FUR

10

4569.713013

20

4589.288651

30

0.0

0

VERTEX

5

10148

8

FUR

10

4574.348268

20

4575.022803

30

0.0

0

SEQEND

5

10149

8

FUR

0

SOLID

5

F554

8

1SOLID

10

4621.023473

20

4505.18908

30

0.0

11

4672.928481

21

4505.18908

31

0.0

12

4619.561335

22  
4500.68908  
32  
0.0  
13  
4672.928481  
23  
4500.68908  
33  
0.0  
0

LINE  
5  
F555  
8  
1FLR  
10  
4621.023473  
20  
4505.18908  
30  
0.0  
11  
4672.928481  
21  
4505.18908  
31  
0.0  
0

LINE  
5  
F556  
8  
1FLR  
10  
4619.561335  
20  
4500.68908  
30  
0.0  
11  
4672.928481  
21  
4500.68908  
31  
0.0  
0

SOLID  
5  
F557  
8  
1DIM  
10  
4618.903501  
20  
4476.977954  
30  
0.0  
11  
4620.528669  
21

4477.34756

31

0.0

12

4618.607268

22

4482.03826

32

0.0

13

4618.607268

23

4482.03826

33

0.0

0

LINE

5

F558

8

1DIM

10

4622.509073

20

4464.881903

30

0.0

11

4627.509073

21

4464.881903

31

0.0

0

LINE

5

F559

8

1DIM

10

4619.716085

20

4477.162757

30

0.0

11

4622.509073

21

4464.881903

31

0.0

0

TEXT

5

F55A

8

1DIM

10

4631.966416

20

4451.589006

30  
0.0  
40  
6.0  
1  
OVERHANG  
7  
ROMANS  
0  
POLYLINE  
5  
F55B  
8  
FUR  
66  
1  
10  
0.0  
20  
0.0  
30  
0.0  
70  
1  
0  
VERTEX  
5  
1014A  
8  
FUR  
10  
4646.282057  
20  
4507.759846  
30  
0.0  
0  
VERTEX  
5  
1014B  
8  
FUR  
10  
4661.282057  
20  
4507.759846  
30  
0.0  
0  
VERTEX  
5  
1014C  
8  
FUR  
10  
4661.282057  
20  
4522.759846  
30  
0.0  
0

VERTEX

5

1014D

8

FUR

10

4646.282057

20

4522.759846

30

0.0

0

SEQEND

5

1014E

8

FUR

0

LINE

5

F55C

8

1FLR

10

4672.928481

20

4500.68908

30

0.0

11

4672.928481

21

4505.18908

31

0.0

0

INSERT

5

F55D

8

FUR

2

COFFTBL

10

4619.547984

20

4586.265994

30

0.0

50

324.000005

0

LINE

5

F55E

8

0

10

4643.571033

20

4594.664104



30  
0.0  
11  
4636.913637  
21  
4596.827223  
31  
0.0  
0  
LINE  
5  
F55F  
8  
0  
10  
4643.571033  
20  
4594.664104  
30  
0.0  
11  
4647.68553  
21  
4589.000985  
31  
0.0  
0  
LINE  
5  
F560  
8  
0  
10  
4643.571033  
20  
4594.664104  
30  
0.0  
11  
4639.456536  
21  
4589.000985  
31  
0.0  
0  
LINE  
5  
F561  
8  
0  
10  
4643.571033  
20  
4594.664104  
30  
0.0  
11  
4650.228428  
21  
4596.827223  
31

0.0  
0  
CIRCLE  
5  
F562  
8  
0  
10  
4643.571033  
20  
4594.664104  
30  
0.0  
40  
0.0001  
0  
LINE  
5  
F563  
8  
0  
10  
4643.571033  
20  
4594.664104  
30  
0.0  
11  
4643.571033  
21  
4601.664104  
31  
0.0  
0  
SOLID  
5  
F564  
8  
1SOLID  
10  
4920.617164  
20  
4504.646338  
30  
0.0  
11  
4860.097127  
21  
4398.520691  
31  
0.0  
12  
4913.090229  
22  
4507.09199  
32  
0.0  
13  
4854.191617  
23  
4403.809611

33  
0.0  
0  
LINE  
5  
F565  
8  
1FLR  
10  
4860.097127  
20  
4398.520691  
30  
0.0  
11  
4920.617164  
21  
4504.646338  
31  
0.0  
0  
LINE  
5  
F566  
8  
1FLR  
10  
4854.191617  
20  
4403.809611  
30  
0.0  
11  
4913.090229  
21  
4507.09199  
31  
0.0  
0  
SOLID  
5  
F567  
8  
1SOLID  
10  
4831.960621  
20  
4446.572041  
30  
0.0  
11  
4867.137835  
21  
4426.511609  
31  
0.0  
12  
4829.731418  
22  
4442.662993  
32

0.0  
13  
4864.908631  
23  
4422.602562  
33  
0.0  
0  
LINE  
5  
F568  
8  
1FLR  
10  
4831.960621  
20  
4446.572041  
30  
0.0  
11  
4867.137835  
21  
4426.511609  
31  
0.0  
0  
LINE  
5  
F569  
8  
1FLR  
10  
4829.731418  
20  
4442.662993  
30  
0.0  
11  
4864.908631  
21  
4422.602562  
31  
0.0  
0  
INSERT  
5  
F56A  
8  
FUR  
2  
SOFALG  
10  
4761.964477  
20  
4428.751068  
30  
0.0  
50  
36.000005  
0  
SOLID

5  
F56B  
8  
1SOLID  
10  
4808.625755  
20  
4371.313508  
30  
0.0  
11  
4727.154525  
21  
4483.448774  
31  
0.0  
12  
4804.985181  
22  
4368.66847  
32  
0.0  
13  
4722.166235  
23  
4482.658704  
33  
0.0  
0

LINE  
5  
F56C  
8  
1HDN  
10  
4818.333951  
20  
4378.366941  
30  
0.0  
11  
4731.738114  
21  
4497.555607  
31  
0.0  
0

LINE  
5  
F56D  
8  
1CP  
10  
4821.570016  
20  
4380.718086  
30  
0.0  
11  
4756.396212  
21

4470.421923

31

0.0

0

LINE

5

F56E

8

1FLR

10

4727.154525

20

4483.448774

30

0.0

11

4808.625755

21

4371.313508

31

0.0

0

LINE

5

F56F

8

1FLR

10

4722.166235

20

4482.658704

30

0.0

11

4804.985181

21

4368.66847

31

0.0

0

SOLID

5

F570

8

1SOLID

10

4860.097121

20

4398.520557

30

0.0

11

4763.20439

21

4328.123867

31

0.0

12

4854.191611

22

4403.80948

32  
0.0  
13  
4759.999229  
23  
4335.374708  
33  
0.0  
0

POLYLINE

5  
F571  
8  
FUR  
66  
1  
10  
0.0  
20  
0.0  
30  
0.0  
70

1

0

VERTEX

5  
1014F  
8  
FUR  
10  
4763.140439  
20  
4374.993205  
30  
0.0  
0

VERTEX

5  
10150  
8  
FUR  
10  
4771.800295  
20  
4363.073963  
30  
0.0  
0

VERTEX

5  
10151  
8  
FUR  
10  
4792.576862  
20  
4378.169057  
30  
0.0  
0

VERTEX

5

10152

8

FUR

10

4783.917005

20

4390.088299

30

0.0

0

SEQEND

5

10153

8

FUR

0

LINE

5

F572

8

1FLR

10

4759.99902

20

4335.374524

30

0.0

11

4854.191617

21

4403.809611

31

0.0

0

LINE

5

F573

8

1FLR

10

4763.999013

20

4328.701161

30

0.0

11

4860.097127

21

4398.520691

31

0.0

0

INSERT

5

F574

8

FUR

2

CHAIR2



10  
4738.407528  
20  
4364.437105  
30  
0.0  
41  
0.9  
42  
0.9  
43  
0.9  
50  
90.0  
0

LINE

5  
F575  
8

1W  
10  
4732.792877  
20  
4330.140013  
30  
0.0  
11  
4696.915135  
21  
4330.139975  
31  
0.0  
0

LINE

5  
F576  
8

1W  
10  
4732.792875  
20  
4332.390013  
30  
0.0  
11  
4696.915133  
21  
4332.389975  
31  
0.0  
0

LINE

5  
F577  
8

1W  
10  
4696.915138  
20  
4327.889975  
30

0.0  
11  
4732.792879  
21  
4327.890013  
31  
0.0  
0  
TEXT  
5  
F578  
8  
1DIM  
10  
4682.054108  
20  
4316.672451  
30  
0.0  
40  
6.0  
1  
HIGH PROFILE  
7  
ROMANS  
0  
TEXT  
5  
F579  
8  
1DIM  
10  
4682.054108  
20  
4306.958165  
30  
0.0  
40  
6.0  
1  
ENTRYWAY  
7  
ROMANS  
0  
LINE  
5  
F57A  
8  
1FLR  
10  
4696.915138  
20  
4327.889975  
30  
0.0  
11  
4696.915133  
21  
4332.389975  
31  
0.0

0  
LINE  
5  
F57B  
8  
1FLR  
10  
4679.571027  
20  
4327.889879  
30  
0.0  
11  
4679.571032  
21  
4332.389879  
31  
0.0  
0  
SOLID  
5  
F57C  
8  
1SOLID  
10  
4679.571037  
20  
4332.389962  
30  
0.0  
11  
4696.915133  
21  
4332.389975  
31  
0.0  
12  
4679.571041  
22  
4327.889962  
32  
0.0  
13  
4696.915138  
23  
4327.889975  
33  
0.0  
0  
LINE  
5  
F57D  
8  
1FLR  
10  
4696.915133  
20  
4332.389975  
30  
0.0  
11

4679.571037

21

4332.389962

31

0.0

0

LINE

5

F57E

8

1FLR

10

4696.915138

20

4327.889975

30

0.0

11

4679.571041

21

4327.889962

31

0.0

0

SOLID

5

F57F

8

1SOLID

10

4759.998989

20

4302.374524

30

0.0

11

4759.99902

21

4335.374524

31

0.0

12

4763.998989

22

4302.37452

32

0.0

13

4763.999013

23

4328.701161

33

0.0

0

LINE

5

F580

8

1FLR

10

4759.999008

20  
4327.889787  
30  
0.0  
11  
4759.998989  
21  
4302.374524  
31  
0.0  
0  
LINE  
5  
F581  
8  
1FLR  
10  
4763.999013  
20  
4328.701161  
30  
0.0  
11  
4763.998989  
21  
4302.37452  
31  
0.0  
0  
LINE  
5  
F582  
8  
1FLR  
10  
4759.998989  
20  
4302.374524  
30  
0.0  
11  
4763.998989  
21  
4302.37452  
31  
0.0  
0  
SOLID  
5  
F583  
8  
1SOLID  
10  
4732.792875  
20  
4332.390013  
30  
0.0  
11  
4759.999105  
21

4332.390044

31

0.0

12

4732.792879

22

4327.890013

32

0.0

13

4759.999105

23

4327.890044

33

0.0

0

LINE

5

F584

8

1FLR

10

4759.999105

20

4332.390044

30

0.0

11

4732.792875

21

4332.390013

31

0.0

0

LINE

5

F585

8

1FLR

10

4759.999105

20

4327.890044

30

0.0

11

4732.792879

21

4327.890013

31

0.0

0

LINE

5

F586

8

1FLR

10

4732.792879

20

4327.890013

30  
0.0  
11  
4732.792875  
21  
4332.390013  
31  
0.0  
0

LINE

5  
F587  
8  
1FLR  
10  
4759.99902  
20  
4335.374524  
30  
0.0  
11  
4759.999014  
21  
4332.389787  
31  
0.0  
0

INSERT

5  
F588  
8  
FUR  
2  
COFFTBL  
10  
4699.701855  
20  
4402.943539  
30  
0.0  
50  
306.000005  
0

INSERT

5  
F589  
8  
FUR  
2  
DESKSM  
10  
4742.613933  
20  
4525.47366  
30  
0.0  
50  
161.999995  
0

INSERT

5

F58A

8

1WD

2

FD60

10

4769.415864

20

4482.2393

30

0.0

50

330.305281

0

SOLID

5

F58B

8

1SOLID

10

4748.376638

20

4563.326004

30

0.0

11

4722.166235

21

4482.658704

31

0.0

12

4752.656392

22

4561.935428

32

0.0

13

4727.154525

23

4483.448774

33

0.0

0

LINE

5

F58C

8

1FLR

10

4752.656392

20

4561.935428

30

0.0

11

4733.429502

21

4502.761162

31

0.0



0  
LINE  
5  
F58D  
8  
1FLR  
10  
4748.376638  
20  
4563.326004  
30  
0.0  
11  
4722.166235  
21  
4482.658704  
31  
0.0  
0

LINE  
5  
F58E  
8  
1FLR  
10  
4732.009447  
20  
4498.390684  
30  
0.0  
11  
4727.154525  
21  
4483.448774  
31  
0.0  
0

POLYLINE  
5  
F58F  
8  
FUR  
66  
1  
10  
0.0  
20  
0.0  
30  
0.0  
70  
1  
0

VERTEX  
5  
10154  
8  
FUR  
10  
4701.31516  
20

4457.688148

30

0.0

0

VERTEX

5

10155

8

FUR

10

4709.975017

20

4445.768905

30

0.0

0

VERTEX

5

10156

8

FUR

10

4730.751583

20

4460.863999

30

0.0

0

VERTEX

5

10157

8

FUR

10

4722.091727

20

4472.783242

30

0.0

0

SEQEND

5

10158

8

FUR

0

LINE

5

F590

8

1CP

10

4753.92491

20

4484.067068

30

0.0

11

4739.176359

21

4470.61809

31  
0.0  
0  
LINE  
5  
F591  
8  
1CP  
10  
4756.396212  
20  
4470.421923  
30  
0.0  
11  
4763.511469  
21  
4483.145904  
31  
0.0  
0  
SOLID  
5  
F592  
8  
1SOLID  
10  
4733.429502  
20  
4502.761162  
30  
0.0  
11  
4769.415864  
21  
4482.2393  
31  
0.0  
12  
4732.009447  
22  
4498.390684  
32  
0.0  
13  
4767.186661  
23  
4478.330252  
33  
0.0  
0  
LINE  
5  
F593  
8  
1FLR  
10  
4733.429502  
20  
4502.761162  
30

0.0  
11  
4769.415864  
21  
4482.2393  
31  
0.0  
0  
LINE  
5  
F594  
8  
1FLR  
10  
4732.009447  
20  
4498.390684  
30  
0.0  
11  
4767.186661  
21  
4478.330252  
31  
0.0  
0  
LINE  
5  
F595  
8  
1CP  
10  
4757.980762  
20  
4478.724324  
30  
0.0  
11  
4742.494782  
21  
4466.012276  
31  
0.0  
0  
LINE  
5  
F596  
8  
1CP  
10  
4751.528269  
20  
4453.300228  
30  
0.0  
11  
4767.567321  
21  
4464.90688  
31  
0.0

0  
LINE  
5  
F597  
8  
1CP  
10  
4771.25446  
20  
4460.669532  
30  
0.0  
11  
4755.76848  
21  
4447.957484  
31  
0.0  
0

LINE  
5  
F598  
8  
1CP  
10  
4753.556197  
20  
4451.089438  
30  
0.0  
11  
4769.595247  
21  
4462.880322  
31  
0.0  
0

LINE  
5  
F599  
8  
1CP  
10  
4744.153993  
20  
4463.801484  
30  
0.0  
11  
4760.193045  
21  
4475.408136  
31  
0.0  
0

LINE  
5  
F59A  
8  
1CP  
10

4747.656776

20

4458.642974

30

0.0

11

4763.695825

21

4470.433858

31

0.0

0

LINE

5

F59B

8

1CP

10

4761.299186

20

4473.565812

30

0.0

11

4746.550634

21

4460.116834

31

0.0

0

LINE

5

F59C

8

1CP

10

4765.355038

20

4468.223068

30

0.0

11

4749.869058

21

4455.51102

31

0.0

0

LINE

5

F59D

8

1CP

10

4740.2825

20

4469.14423

30

0.0

11

4756.321549

21  
4480.935114  
31  
0.0  
0  
LINE  
5  
F59E  
8  
1FLR  
10  
4767.186661  
20  
4478.330252  
30  
0.0  
11  
4769.415864  
21  
4482.2393  
31  
0.0  
0  
LINE  
5  
F59F  
8  
1CP  
10  
4757.42769  
20  
4445.746692  
30  
0.0  
11  
4773.466742  
21  
4457.353344  
31  
0.0  
0  
INSERT  
5  
F5A0  
8  
FUR  
2  
CHAIR2  
10  
4681.927493  
20  
4559.549955  
30  
0.0  
41  
0.9  
42  
0.9  
43  
0.9  
50

185.976129

0

INSERT

5

F5A1

8

1WD

2

D26

10

4752.656392

20

4561.935428

30

0.0

41

-1.0

50

251.999995

0

LINE

5

F5A2

8

1FLR

10

4748.376638

20

4563.326004

30

0.0

11

4752.656392

21

4561.935428

31

0.0

0

SOLID

5

F5A3

8

1SOLID

10

4761.926905

20

4590.467122

30

0.0

11

4765.837336

21

4602.502188

31

0.0

12

4757.647151

22

4591.857699

32

0.0



13  
4761.105756  
23  
4602.502188  
33  
0.0  
0

LINE

5  
F5A4  
8  
1FLR

10  
4765.837336  
20  
4602.502188  
30  
0.0  
11

4761.926905  
21  
4590.467122  
31  
0.0  
0

LINE

5  
F5A5  
8  
1FLR

10  
4757.647151  
20  
4591.857699  
30  
0.0  
11

4761.926905  
21  
4590.467122  
31  
0.0  
0

LINE

5  
F5A6  
8  
1FLR

10  
4761.105756  
20  
4602.502188  
30  
0.0  
11

4757.647151  
21  
4591.857699  
31  
0.0  
0

LINE

5

F5A7

8

1TXT

10

4797.136962

20

4498.28133

30

0.0

11

4874.986964

21

4498.28133

31

0.0

0

TEXT

5

F5A8

8

1TXT

10

4797.136962

20

4501.28133

30

0.0

40

8.0

1

BEDROOM 3

0

TEXT

5

F5A9

8

1DIM

10

4797.136962

20

4489.28133

30

0.0

40

6.0

1

176 SQ. FT.

7

ROMANS

0

TEXT

5

F5AA

8

1DIM

10

4784.750147

20

4458.060187

30  
0.0  
40  
6.0  
1  
CLOSET  
50  
330.085201  
7  
ROMANS  
0  
LINE  
5  
F5AB  
8  
1FLR  
10  
4829.731418  
20  
4442.662993  
30  
0.0  
11  
4831.960621  
21  
4446.572041  
31  
0.0  
0  
TEXT  
5  
F5AC  
8  
FUR  
10  
4828.780109  
20  
4565.311826  
30  
0.0  
40  
5.0  
1  
DOUBLE  
7  
ROMANS  
0  
SOLID  
5  
F5AD  
8  
1SOLID  
10  
4924.79632  
20  
4542.468506  
30  
0.0  
11  
4920.617164  
21

4504.646338

31

0.0

12

4917.093202

22

4543.319661

32

0.0

13

4913.090229

23

4507.09199

33

0.0

0

LINE

5

F5AE

8

1FLR

10

4917.093202

20

4543.319661

30

0.0

11

4913.090229

21

4507.09199

31

0.0

0

LINE

5

F5AF

8

1FLR

10

4924.79632

20

4542.468506

30

0.0

11

4920.617164

21

4504.646338

31

0.0

0

LINE

5

F5B0

8

1W

10

4929.848339

20

4588.190242

30  
0.0  
11  
4924.79632  
21  
4542.468506  
31  
0.0  
0

LINE

5  
F5B1  
8  
1W  
10  
4922.14522  
20  
4589.041397  
30  
0.0  
11  
4917.093202  
21  
4543.319661  
31  
0.0  
0

LINE

5  
F5B2  
8  
1W  
10  
4925.99678  
20  
4588.615819  
30  
0.0  
11  
4920.944761  
21  
4542.894084  
31  
0.0  
0

LINE

5  
F5B3  
8  
1FLR  
10  
4924.79632  
20  
4542.468506  
30  
0.0  
11  
4917.093202  
21  
4543.319661  
31

0.0  
0  
LINE  
5  
F5B4  
8  
1FLR  
10  
4929.848339  
20  
4588.190242  
30  
0.0  
11  
4922.14522  
21  
4589.041397  
31  
0.0  
0  
SOLID  
5  
F5B5  
8  
1SOLID  
10  
4583.688032  
20  
4880.618408  
30  
0.0  
11  
4703.454034  
21  
4880.618408  
31  
0.0  
12  
4585.356939  
22  
4872.868408  
32  
0.0  
13  
4701.785127  
23  
4872.868408  
33  
0.0  
0  
LINE  
5  
F5B6  
8  
1FLR  
10  
4703.453824  
20  
4880.618436  
30  
0.0

11  
4584.670426  
21  
4880.618304  
31  
0.0  
0  
LINE  
5  
F5B7  
8  
1FLR  
10  
4701.785403  
20  
4872.868434  
30  
0.0  
11  
4585.356857  
21  
4872.868305  
31  
0.0  
0  
TEXT  
5  
F5B8  
8  
1DIM  
10  
4681.477439  
20  
4803.053252  
30  
0.0  
40  
6.0  
1  
CLOSET  
50  
90.0  
7  
ROMANS  
0  
LINE  
5  
F5B9  
8  
1FLR  
10  
4672.436785  
20  
4708.868369  
30  
0.0  
11  
4679.780485  
21  
4703.53286  
31

0.0  
0  
LINE  
5  
F5BA  
8  
1FLR  
10  
4671.347889  
20  
4713.368369  
30  
0.0  
11  
4679.500613  
21  
4757.864754  
31  
0.0  
0  
LINE  
5  
F5BB  
8  
1TXT  
10  
4607.938351  
20  
4673.823244  
30  
0.0  
11  
4691.938351  
21  
4673.823244  
31  
0.0  
0  
TEXT  
5  
F5BC  
8  
1TXT  
10  
4607.938351  
20  
4676.823244  
30  
0.0  
40  
8.0  
1  
FAMILY ROOM  
0  
SOLID  
5  
F5BD  
8  
1SOLID  
10  
4682.425518



20  
4707.173437  
30  
0.0  
11  
4673.898923  
21  
4713.368369  
31  
0.0  
12  
4679.780485  
22  
4703.53286  
32  
0.0  
13  
4672.436785  
23  
4708.868369  
33  
0.0  
0  
SOLID  
5  
F5BE  
8  
1SOLID  
10  
4675.685034  
20  
4712.070684  
30  
0.0  
11  
4688.530973  
21  
4782.181955  
31  
0.0  
12  
4671.347889  
22  
4713.368369  
32  
0.0  
13  
4684.104656  
23  
4782.992955  
33  
0.0  
0  
SOLID  
5  
F5BF  
8  
1SOLID  
10  
4683.654995  
20

4773.249289

30

0.0

11

4607.2786

21

4773.249289

31

0.0

12

4682.865208

22

4768.749289

32

0.0

13

4606.255795

23

4768.749289

33

0.0

0

LINE

5

F5C0

8

1FLR

10

4673.898923

20

4713.368369

30

0.0

11

4682.425518

21

4707.173437

31

0.0

0

LINE

5

F5C1

8

1FLR

10

4675.685034

20

4712.070684

30

0.0

11

4688.530973

21

4782.181955

31

0.0

0

LINE

5

F5C2

8  
1CP  
10  
4501.043928  
20  
4785.635352  
30  
0.0  
11  
4418.956971  
21  
4725.995586  
31  
0.0  
0

LINE

5  
F5C3  
8  
1CP  
10  
4459.961826  
20  
4681.923195  
30  
0.0  
11  
4485.955426  
21  
4673.477368  
31  
0.0  
0

LINE

5  
F5C4  
8  
1HDN  
10  
4392.232587  
20  
4721.411977  
30  
0.0  
11  
4518.26099  
21  
4812.977126  
31  
0.0  
0

TEXT

5  
F5C5  
8  
1TXT  
10  
4447.571314  
20  
4726.654529  
30

0.0  
40  
8.0  
1  
KITCHEN  
0  
LINE  
5  
F5C6  
8  
1TXT  
10  
4447.571314  
20  
4723.654529  
30  
0.0  
11  
4509.353391  
21  
4723.654529  
31  
0.0  
0  
TEXT  
5  
F5C7  
8  
1DIM  
10  
4447.571314  
20  
4714.654529  
30  
0.0  
40  
6.0  
1  
216 SQ. FT.  
7  
ROMANS  
0  
SOLID  
5  
F5C8  
8  
1SOLID  
10  
4515.906434  
20  
4831.661427  
30  
0.0  
11  
4456.081569  
21  
4788.19602  
31  
0.0  
12  
4518.551472

22  
4828.020854  
32  
0.0  
13  
4458.7266  
23  
4784.555441  
33  
0.0  
0  
LINE  
5  
F5C9  
8  
1FLR  
10  
4515.906434  
20  
4831.661427  
30  
0.0  
11  
4456.081569  
21  
4788.19602  
31  
0.0  
0  
LINE  
5  
F5CA  
8  
1FLR  
10  
4518.551472  
20  
4828.020854  
30  
0.0  
11  
4458.7266  
21  
4784.555441  
31  
0.0  
0  
LINE  
5  
F5CB  
8  
1TXT  
10  
4393.252378  
20  
4615.067185  
30  
0.0  
11  
4479.743484  
21

4615.067185

31

0.0

0

LINE

5

F5CC

8

1HDN

10

4488.06228

20

4660.175264

30

0.0

11

4383.386514

21

4694.18646

31

0.0

0

SOLID

5

F5CD

8

1SOLID

10

4378.287751

20

4678.494022

30

0.0

11

4512.760658

21

4634.801154

31

0.0

12

4379.678323

22

4682.773778

32

0.0

13

4514.151233

23

4639.080909

33

0.0

0

LINE

5

F5CE

8

1FLR

10

4379.678323

20

4682.773778

30  
0.0  
11  
4514.151233  
21  
4639.080909  
31  
0.0  
0  
LINE  
5  
F5CF  
8  
1FLR  
10  
4378.287751  
20  
4678.494022  
30  
0.0  
11  
4512.760658  
21  
4634.801154  
31  
0.0  
0  
SOLID  
5  
F5D0  
8  
1SOLID  
10  
4353.107464  
20  
4626.076725  
30  
0.0  
11  
4390.117194  
21  
4739.980962  
31  
0.0  
12  
4360.993872  
22  
4625.269068  
32  
0.0  
13  
4396.972161  
23  
4735.998855  
33  
0.0  
0  
LINE  
5  
F5D1  
8

1FLR  
10  
4389.813655  
20  
4739.046853  
30  
0.0  
11  
4353.411139  
21  
4627.011005  
31  
0.0  
0

LINE  
5  
F5D2  
8  
1FLR  
10  
4396.972222  
20  
4735.999126  
30  
0.0  
11  
4360.993945  
21  
4625.268958  
31  
0.0  
0

LINE  
5  
F5D3  
8  
1FLR  
10  
4353.411139  
20  
4627.011005  
30  
0.0  
11  
4328.373011  
21  
4618.875629  
31  
0.0  
0

SOLID  
5  
F5D4  
8  
1SOLID  
10  
4329.609078  
20  
4615.071402  
30  
0.0



11  
4360.993945  
21  
4625.268958  
31  
0.0  
12  
4328.373011  
22  
4618.875629  
32  
0.0  
13  
4353.411139  
23  
4627.011005  
33  
0.0  
0

LINE

5  
F5D5  
8  
1FLR  
10  
4353.875401  
20  
4622.956004  
30  
0.0  
11  
4329.609078  
21  
4615.071402  
31  
0.0  
0

LINE

5  
F5D6  
8  
1FLR  
10  
4329.609078  
20  
4615.071402  
30  
0.0  
11  
4328.373011  
21  
4618.875629  
31  
0.0  
0

LINE

5  
F5D7  
8  
1FLR  
10

4360.993945

20

4625.268958

30

0.0

11

4358.155155

21

4624.34658

31

0.0

0

LINE

5

F5D8

8

1CP

10

4418.956971

20

4725.995586

30

0.0

11

4409.920063

21

4698.182739

31

0.0

0

LINE

5

F5D9

8

1CP

10

4409.920063

20

4698.182739

30

0.0

11

4431.430128

21

4691.193699

31

0.0

0

TEXT

5

F5DA

8

1TXT

10

4393.252378

20

4618.067185

30

0.0

40

8.0

1  
DINING ROOM

0  
CIRCLE

5  
F5DB

8  
0

62  
12

10  
4447.78775

20  
4669.452462

30  
0.0

40  
3.5

0  
CIRCLE

5  
F5DC

8  
1CP

62  
12

10  
4447.78775

20  
4669.452462

30  
0.0

40  
3.5

0  
POLYLINE

5  
F5DD

8  
1CP

66  
1

10  
0.0

20  
0.0

30  
0.0

70  
1

0  
VERTEX

5  
10159

8  
1CP

10  
4452.545422

20  
4659.097837

30

0.0  
0  
VERTEX  
5  
1015A  
8  
1CP  
10  
4460.270842  
20  
4682.874252  
30  
0.0  
0  
VERTEX  
5  
1015B  
8  
1CP  
10  
4431.739145  
20  
4692.144756  
30  
0.0  
0  
VERTEX  
5  
1015C  
8  
1CP  
10  
4424.013725  
20  
4668.368342  
30  
0.0  
0  
SEQEND  
5  
1015D  
8  
1CP  
0  
LINE  
5  
F5DE  
8  
1CP  
10  
4453.472473  
20  
4661.951007  
30  
0.0  
11  
4424.940775  
21  
4671.221511  
31  
0.0

0  
CIRCLE  
5  
F5DF  
8  
1CP  
62  
12  
10  
4437.217242  
20  
4684.007369  
30  
0.0  
40  
3.5  
0

CIRCLE  
5  
F5E0  
8  
1CP  
62  
12  
10  
4433.949056  
20  
4673.948923  
30  
0.0  
40  
3.5  
0

CIRCLE  
5  
F5E1  
8  
1CP  
62  
12  
10  
4451.055935  
20  
4679.510908  
30  
0.0  
40  
3.5  
0

SOLID  
5  
F5E2  
8  
1SOLID  
10  
4422.102882  
20  
4763.509003  
30  
0.0  
11

4392.572961

21

4742.05421

31

0.0

12

4424.747913

22

4759.868424

32

0.0

13

4395.217989

23

4738.41363

33

0.0

0

LINE

5

F5E3

8

1FLR

10

4422.102882

20

4763.509003

30

0.0

11

4392.572961

21

4742.05421

31

0.0

0

LINE

5

F5E4

8

1FLR

10

4424.747913

20

4759.868424

30

0.0

11

4395.217989

21

4738.41363

31

0.0

0

SOLID

5

F5E5

8

1SOLID

10

4377.575334

20  
4762.696705  
30  
0.0  
11  
4396.972222  
21  
4735.999126  
31  
0.0  
12  
4374.339263  
22  
4760.345568  
32  
0.0  
13  
4389.813655  
23  
4739.046853  
33  
0.0  
0

LINE

5  
F5E6  
8  
1FLR  
10  
4392.572961  
20  
4742.05421  
30  
0.0  
11  
4377.575334  
21  
4762.696705  
31  
0.0  
0

LINE

5  
F5E7  
8  
1FLR  
10  
4389.813655  
20  
4739.046853  
30  
0.0  
11  
4374.339263  
21  
4760.345568  
31  
0.0  
0

LINE

5

F5E8  
8  
1FLR  
10  
4396.972222  
20  
4735.999126  
30  
0.0  
11  
4395.217989  
21  
4738.41363  
31  
0.0  
0

LINE  
5  
F5E9  
8  
1FLR  
10  
4377.575334  
20  
4762.696705  
30  
0.0  
11  
4374.339263  
21  
4760.345568  
31  
0.0  
0

INSERT  
5  
F5EA  
8  
1CP  
2  
SINK  
10  
4442.789593  
20  
4772.929538  
30  
0.0  
50  
126.000062  
0

LINE  
5  
F5EB  
8  
1W  
10  
4423.425397  
20  
4761.688713  
30  
0.0



11  
4457.404084  
21  
4786.375731  
31  
0.0  
0  
LINE  
5  
F5EC  
8  
1W  
10  
4422.102882  
20  
4763.509003  
30  
0.0  
11  
4456.081569  
21  
4788.19602  
31  
0.0  
0  
LINE  
5  
F5ED  
8  
1W  
10  
4458.7266  
20  
4784.555441  
30  
0.0  
11  
4424.747913  
21  
4759.868424  
31  
0.0  
0  
LINE  
5  
F5EE  
8  
1FLR  
10  
4424.747913  
20  
4759.868424  
30  
0.0  
11  
4422.102882  
21  
4763.509003  
31  
0.0  
0

LINE

5

F5EF

8

1FLR

10

4458.7266

20

4784.555441

30

0.0

11

4456.081569

21

4788.19602

31

0.0

0

INSERT

5

F5F0

8

1CP

2

WASHDRY

10

4642.994176

20

4813.161166

30

0.0

0

INSERT

5

F5F1

8

1WD

2

FD50

10

4602.184176

20

4778.836521

30

0.0

50

100.145886

0

LINE

5

F5F2

8

1CP

62

12

10

4526.965107

20

4800.996964

30

0.0

11  
4502.694616  
21  
4783.36338  
31  
0.0  
0

LINE

5  
F5F3  
8  
1CP  
62

12

10  
4527.897974  
20  
4799.202595  
30  
0.0  
11

4503.870188  
21  
4781.745348  
31  
0.0  
0

POLYLINE

5  
F5F4  
8  
1CP  
66

1

10  
0.0  
20  
0.0  
30  
0.0  
70

1

0

VERTEX

5  
1015E  
8  
1CP  
10

4512.232828  
20  
4821.27416  
30  
0.0  
0

VERTEX

5  
1015F  
8  
1CP  
10

4526.671214

20

4801.401472

30

0.0

0

VERTEX

5

10160

8

1CP

10

4502.400723

20

4783.767888

30

0.0

0

VERTEX

5

10161

8

1CP

10

4487.962337

20

4803.640576

30

0.0

0

SEQEND

5

10162

8

1CP

0

SOLID

5

F5F5

8

1SOLID

10

4650.296438

20

4771.030219

30

0.0

11

4650.296438

21

4878.052007

31

0.0

12

4645.796438

22

4770.767134

32

0.0

13

4645.796438

23  
4878.052002  
33  
0.0  
0  
LINE  
5  
F5F6  
8  
1HDN  
10  
4662.296438  
20  
4773.397985  
30  
0.0  
11  
4662.296438  
21  
4875.27438  
31  
0.0  
0  
LINE  
5  
F5F7  
8  
1DIM  
10  
4666.296438  
20  
4773.397985  
30  
0.0  
11  
4666.296438  
21  
4875.27438  
31  
0.0  
0  
LINE  
5  
F5F8  
8  
1CP  
10  
4578.616183  
20  
4696.301008  
30  
0.0  
11  
4557.455882  
21  
4725.425597  
31  
0.0  
0  
LINE  
5

F5F9  
8  
1CP  
10  
4578.616183  
20  
4696.301008  
30  
0.0  
11  
4504.275973  
21  
4642.289573  
31  
0.0  
0  
INSERT  
5  
F5FA  
8  
FUR  
2  
CHAIR  
10  
4562.962637  
20  
4684.038182  
30  
0.0  
41  
1.1  
42  
1.1  
43  
1.1  
50  
126.000056  
0  
LINE  
5  
F5FB  
8  
1CP  
10  
4557.455882  
20  
4725.425597  
30  
0.0  
11  
4485.955426  
21  
4673.477368  
31  
0.0  
0  
LINE  
5  
F5FC  
8  
1HDN

10  
4564.509315  
20  
4715.7174  
30  
0.0  
11  
4488.06228  
21  
4660.175264  
31  
0.0  
0  
LINE  
5  
F5FD  
8  
1HDN  
10  
4571.562747  
20  
4706.009203  
30  
0.0  
11  
4490.169134  
21  
4646.87316  
31  
0.0  
0  
INSERT  
5  
F5FE  
8  
FUR  
2  
CHAIR  
10  
4524.520181  
20  
4656.944416  
30  
0.0  
41  
1.1  
42  
1.1  
43  
1.1  
50  
126.000056  
0  
LINE  
5  
F5FF  
8  
1FLR  
10  
4512.760658  
20

4634.801154

30

0.0

11

4514.151233

21

4639.080909

31

0.0

0

INSERT

5

F600

8

FUR

2

CHAIR

10

4543.134422

20

4669.884723

30

0.0

41

1.1

42

1.1

43

1.1

50

126.000056

0

LINE

5

F601

8

1CP

62

12

10

4502.694616

20

4783.36338

30

0.0

11

4503.870188

21

4781.745348

31

0.0

0

TEXT

5

F602

8

1DIM

10

4607.938351

20

4664.823244



30  
0.0  
40  
6.0  
1  
255 SQ. FT.  
7  
ROMANS  
0  
INSERT  
5  
F603  
8  
FUR  
2  
CHAIR2  
10  
4597.349996  
20  
4620.999092  
30  
0.0  
41  
-0.9  
42  
0.9  
43  
0.9  
50  
102.023882  
0  
TEXT  
5  
F604  
8  
1DIM  
10  
4623.931118  
20  
4741.773521  
30  
0.0  
40  
6.0  
1  
PANTRY  
7  
ROMANS  
0  
SOLID  
5  
F605  
8  
1SOLID  
10  
4673.898923  
20  
4713.368369  
30  
0.0  
11

4618.47142  
21  
4713.368369  
31  
0.0  
12  
4672.436785  
22  
4708.868369  
32  
0.0  
13  
4614.705224  
23  
4708.868369  
33  
0.0  
0  
LINE  
5  
F606  
8  
1FLR  
10  
4672.436785  
20  
4708.868369  
30  
0.0  
11  
4614.705224  
21  
4708.868369  
31  
0.0  
0  
LINE  
5  
F607  
8  
1FLR  
10  
4673.898923  
20  
4713.368369  
30  
0.0  
11  
4618.47142  
21  
4713.368369  
31  
0.0  
0  
POLYLINE  
5  
F608  
8  
1CP  
66

10  
0.0  
20  
0.0  
30  
0.0  
0  
VERTEX  
5  
10163  
8  
1CP  
10  
4669.295141  
20  
4768.749289  
30  
0.0  
0  
VERTEX  
5  
10164  
8  
1CP  
10  
4661.346795  
20  
4725.368369  
30  
0.0  
0  
VERTEX  
5  
10165  
8  
1CP  
10  
4616.323978  
20  
4725.368369  
30  
0.0  
0  
SEQEND  
5  
10166  
8  
1CP  
0  
INSERT  
5  
F609  
8  
1WD  
2  
FD26  
10  
4610.715143  
20  
4731.16511  
30

0.0  
50  
100.145886  
0  
LINE  
5  
F60A  
8  
1FLR  
10  
4615.144774  
20  
4731.957808  
30  
0.0  
11  
4610.715143  
21  
4731.16511  
31  
0.0  
0  
SOLID  
5  
F60B  
8  
1SOLID  
10  
4615.144774  
20  
4731.957808  
30  
0.0  
11  
4618.47142  
21  
4713.368369  
31  
0.0  
12  
4610.715143  
22  
4731.16511  
32  
0.0  
13  
4614.705224  
23  
4708.868369  
33  
0.0  
0  
LINE  
5  
F60C  
8  
1FLR  
10  
4614.705224  
20  
4708.868369

30  
0.0  
11  
4610.715143  
21  
4731.16511  
31  
0.0  
0  
LINE  
5  
F60D  
8  
1FLR  
10  
4618.47142  
20  
4713.368369  
30  
0.0  
11  
4615.144774  
21  
4731.957808  
31  
0.0  
0  
LINE  
5  
F60E  
8  
1FLR  
10  
4606.613807  
20  
4779.629219  
30  
0.0  
11  
4602.184176  
21  
4778.836521  
31  
0.0  
0  
LINE  
5  
F60F  
8  
1FLR  
10  
4609.860121  
20  
4761.48868  
30  
0.0  
11  
4605.43049  
21  
4760.695982  
31

0.0  
0  
SOLID  
5  
F610  
8  
1SOLID  
10  
4606.613807  
20  
4779.629219  
30  
0.0  
11  
4609.860121  
21  
4761.48868  
31  
0.0  
12  
4602.184176  
22  
4778.836521  
32  
0.0  
13  
4605.43049  
23  
4760.695982  
33  
0.0  
0  
LINE  
5  
F611  
8  
1FLR  
10  
4605.43049  
20  
4760.695982  
30  
0.0  
11  
4602.184176  
21  
4778.836521  
31  
0.0  
0  
LINE  
5  
F612  
8  
1FLR  
10  
4609.860121  
20  
4761.48868  
30  
0.0

11  
4606.613807  
21  
4779.629219  
31  
0.0  
0  
SOLID  
5  
F613  
8  
1SOLID  
10  
4565.959948  
20  
4899.565868  
30  
0.0  
11  
4585.356857  
21  
4872.868305  
31  
0.0  
12  
4569.196016  
22  
4901.917009  
32  
0.0  
13  
4584.670426  
23  
4880.618304  
33  
0.0  
0  
LINE  
5  
F614  
8  
1FLR  
10  
4584.670426  
20  
4880.618304  
30  
0.0  
11  
4569.196016  
21  
4901.917009  
31  
0.0  
0  
LINE  
5  
F615  
8  
1FLR  
10

4580.957311

20

4878.923763

30

0.0

11

4565.959948

21

4899.565868

31

0.0

0

SOLID

5

F616

8

1SOLID

10

4580.957311

20

4878.923763

30

0.0

11

4545.031023

21

4852.821728

31

0.0

12

4583.602344

22

4875.283186

32

0.0

13

4547.676061

23

4849.181154

33

0.0

0

LINE

5

F617

8

1FLR

10

4583.602344

20

4875.283186

30

0.0

11

4547.676061

21

4849.181154

31

0.0

0

LINE



5  
F618  
8  
1FLR  
10  
4580.957311  
20  
4878.923763  
30  
0.0  
11  
4545.031023  
21  
4852.821728  
31  
0.0  
0

INSERT

5  
F619  
8  
1WD  
2  
D30  
10  
4545.031023  
20  
4852.821728  
30  
0.0  
41  
-1.0  
50  
36.000062  
0

LINE

5  
F61A  
8  
1FLR  
10  
4518.551472  
20  
4828.020854  
30  
0.0  
11  
4515.906434  
21  
4831.661427  
31  
0.0  
0

TEXT

5  
F61B  
8  
1DIM  
10  
4505.425625  
20

4791.1411

30

0.0

40

6.0

1

REF

50

36.266828

7

ROMANS

0

ARC

5

F61C

8

1CP

62

12

10

4528.544014

20

4797.97314

30

0.0

40

0.5

50

306.000062

51

36.000062

0

ARC

5

F61D

8

1CP

62

12

10

4528.544014

20

4797.97314

30

0.0

40

0.2

50

306.000062

51

36.000062

0

LINE

5

F61E

8

1CP

62

12

10

4527.486962

20  
4796.587111  
30  
0.0  
11  
4528.837907  
21  
4797.568632  
31  
0.0  
0

LINE

5  
F61F  
8  
1CP  
62  
12

10  
4527.310626  
20  
4796.829816  
30  
0.0  
11  
4528.661571  
21  
4797.811337  
31  
0.0  
0

LINE

5  
F620  
8  
1CP  
62  
12

10  
4527.486962  
20  
4796.587111  
30  
0.0  
11  
4527.310626  
21  
4796.829816  
31  
0.0  
0

LINE

5  
F621  
8  
1CP  
62  
12

10  
4526.965107  
20

4800.996964

30

0.0

11

4528.948522

21

4798.267033

31

0.0

0

LINE

5

F622

8

1CP

62

12

10

4527.897974

20

4799.202595

30

0.0

11

4528.705817

21

4798.090697

31

0.0

0

LINE

5

F623

8

1FLR

10

4547.676061

20

4849.181154

30

0.0

11

4545.031023

21

4852.821728

31

0.0

0

LINE

5

F624

8

1FLR

10

4565.959948

20

4899.565868

30

0.0

11

4569.196016

21  
4901.917009  
31  
0.0  
0  
TEXT  
5  
F625  
8  
1DIM  
10  
4632.196618  
20  
4824.046421  
30  
0.0  
40  
6.0  
1  
W  
50  
90.0  
7  
ROMANS  
0  
TEXT  
5  
F626  
8  
1DIM  
10  
4632.745409  
20  
4850.370679  
30  
0.0  
40  
6.0  
1  
WH  
50  
90.0  
7  
ROMANS  
0  
TEXT  
5  
F627  
8  
1DIM  
10  
4631.647824  
20  
4796.076898  
30  
0.0  
40  
6.0  
1  
D  
50

90.0  
7  
ROMANS  
0  
CIRCLE  
5  
F628  
8  
1CP  
10  
4629.889435  
20  
4857.257309  
30  
0.0  
40  
10.0  
0  
LINE  
5  
F629  
8  
1FLR  
10  
4585.356857  
20  
4872.868305  
30  
0.0  
11  
4583.602344  
21  
4875.283186  
31  
0.0  
0  
LINE  
5  
F62A  
8  
1FLR  
10  
4596.0445  
20  
4838.690964  
30  
0.0  
11  
4591.614869  
21  
4837.898266  
31  
0.0  
0  
SOLID  
5  
F62B  
8  
1SOLID  
10  
4596.0445

20  
4838.690964  
30  
0.0  
11  
4589.928343  
21  
4872.86831  
31  
0.0  
12  
4591.614869  
22  
4837.898266  
32  
0.0  
13  
4585.356857  
23  
4872.868305  
33  
0.0  
0

LINE

5  
F62C  
8  
1FLR  
10  
4591.614869  
20  
4837.898266  
30  
0.0  
11  
4585.356857  
21  
4872.868305  
31  
0.0  
0

LINE

5  
F62D  
8  
1FLR  
10  
4596.0445  
20  
4838.690964  
30  
0.0  
11  
4589.928343  
21  
4872.86831  
31  
0.0  
0

LINE

5

F62E

8

1CP

10

4652.085306

20

4870.007437

30

0.0

11

4672.303524

21

4869.265985

31

0.0

0

LINE

5

F62F

8

1CP

10

4672.489012

20

4867.041628

30

0.0

11

4652.270794

21

4866.114811

31

0.0

0

LINE

5

F630

8

1CP

10

4652.085306

20

4863.149002

30

0.0

11

4672.674499

21

4862.778275

31

0.0

0

LINE

5

F631

8

1CP

10

4672.118036

20

4858.885649



30  
0.0  
11  
4651.714328  
21  
4859.071013  
31  
0.0  
0

LINE

5  
F632  
8  
1CP  
10  
4652.456281  
20  
4854.622297  
30  
0.0  
11  
4672.303524  
21  
4855.178387  
31  
0.0  
0

LINE

5  
F633  
8  
1CP  
10  
4672.859987  
20  
4850.915034  
30  
0.0  
11  
4652.085306  
21  
4852.027213  
31  
0.0  
0

LINE

5  
F634  
8  
1CP  
10  
4652.270794  
20  
4848.134587  
30  
0.0  
11  
4672.859987  
21  
4848.690677  
31

0.0  
0  
LINE  
5  
F635  
8  
1FLR  
10  
4890.169905  
20  
4735.998855  
30  
0.0  
11  
4865.637341  
21  
4762.954768  
31  
0.0  
0  
TEXT  
5  
F636  
8  
1DIM  
10  
4862.942343  
20  
4702.798857  
30  
0.0  
40  
6.0  
1  
LINEN  
7  
ROMANS  
0  
ARC  
5  
F637  
8  
1CP  
10  
4885.605999  
20  
4669.245728  
30  
0.0  
40  
13.0  
50  
8.082928  
51  
188.082928  
0  
SOLID  
5  
F638  
8  
1SOLID

10  
4897.024872  
20  
4739.980962  
30  
0.0  
11  
4871.368998  
21  
4768.171146  
31  
0.0  
12  
4890.169905  
22  
4735.998855  
32  
0.0  
13  
4865.637341  
23  
4762.954768  
33  
0.0  
0  
SOLID  
5  
F639  
8  
1SOLID  
10  
4865.948817  
20  
4686.41208  
30  
0.0  
11  
4904.502593  
21  
4691.887375  
31  
0.0  
12  
4863.452294  
22  
4681.512378  
32  
0.0  
13  
4905.914263  
23  
4687.542703  
33  
0.0  
0  
LINE  
5  
F63A  
8  
1FLR  
10

4897.024872

20

4739.980962

30

0.0

11

4871.368998

21

4768.171146

31

0.0

0

LINE

5

F63B

8

1FLR

10

4904.502593

20

4691.887375

30

0.0

11

4865.948817

21

4686.41208

31

0.0

0

LINE

5

F63C

8

1FLR

10

4898.311368

20

4686.462962

30

0.0

11

4863.452294

21

4681.512378

31

0.0

0

LINE

5

F63D

8

1CP

10

4901.516202

20

4628.336126

30

0.0

11

4881.71489

21  
4625.524002  
31  
0.0  
0  
SOLID  
5  
F63E  
8  
1SOLID  
10  
4890.169905  
20  
4735.998855  
30  
0.0  
11  
4747.09366  
21  
4660.18929  
31  
0.0  
12  
4891.581574  
22  
4731.654182  
32  
0.0  
13  
4748.50533  
23  
4655.844618  
33  
0.0  
0  
LINE  
5  
F63F  
8  
1FLR  
10  
4747.09366  
20  
4660.18929  
30  
0.0  
11  
4890.169905  
21  
4735.998855  
31  
0.0  
0  
LINE  
5  
F640  
8  
1FLR  
10  
4748.50533  
20

4655.844618

30

0.0

11

4891.581574

21

4731.654182

31

0.0

0

LINE

5

F641

8

1W

10

4868.503169

20

4765.562957

30

0.0

11

4837.541439

21

4799.583116

31

0.0

0

LINE

5

F642

8

1W

10

4871.368998

20

4768.171146

30

0.0

11

4840.407267

21

4802.191306

31

0.0

0

INSERT

5

F643

8

1WD

2

FD60

10

4701.506963

20

4853.003023

30

0.0

50

259.617305

0  
LINE  
5  
F644  
8  
1W  
10  
4865.637341  
20  
4762.954768  
30  
0.0  
11  
4834.67561  
21  
4796.974927  
31  
0.0  
0  
INSERT  
5  
F645  
8  
FUR  
2  
BEDD  
10  
4783.713292  
20  
4835.567954  
30  
0.0  
50  
65.694719  
0  
INSERT  
5  
F646  
8  
FUR  
2  
DESKSM  
10  
4847.912277  
20  
4778.886718  
30  
0.0  
50  
42.305314  
0  
LINE  
5  
F647  
8  
1TXT  
10  
4736.15359  
20  
4729.070616  
30

0.0  
11  
4812.189495  
21  
4729.070616  
31  
0.0  
0  
TEXT  
5  
F648  
8  
1TXT  
10  
4736.15359  
20  
4732.070616  
30  
0.0  
40  
8.0  
1  
BEDROOM 2  
0  
TEXT  
5  
F649  
8  
1DIM  
10  
4736.15359  
20  
4720.070616  
30  
0.0  
40  
6.0  
1  
180 SQ. FT.  
7  
ROMANS  
0  
LINE  
5  
F64A  
8  
1CP  
10  
4838.450682  
20  
4638.570393  
30  
0.0  
11  
4775.846716  
21  
4629.67956  
31  
0.0  
0  
TEXT



5  
F64B  
8  
1TXT  
10  
4772.802654  
20  
4656.734881  
30  
0.0  
40  
8.0  
1  
BATH 2  
0  
TEXT  
5  
F64C  
8  
1DIM  
10  
4772.802654  
20  
4644.734881  
30  
0.0  
40  
6.0  
1  
88 SQ. FT.  
7  
ROMANS  
0  
LINE  
5  
F64D  
8  
1TXT  
10  
4772.802654  
20  
4653.734881  
30  
0.0  
11  
4831.571314  
21  
4653.734881  
31  
0.0  
0  
INSERT  
5  
F64E  
8  
1WD  
2  
D26  
10  
4682.425518  
20

4707.173437

30

0.0

50

324.000005

0

SOLID

5

F64F

8

1SOLID

10

4747.09366

20

4660.18929

30

0.0

11

4706.696029

21

4689.539881

31

0.0

12

4743.265732

22

4657.408137

32

0.0

13

4704.050996

23

4685.899305

33

0.0

0

LINE

5

F650

8

1FLR

10

4704.050996

20

4685.899305

30

0.0

11

4743.265732

21

4657.408137

31

0.0

0

LINE

5

F651

8

1FLR

10

4706.696029

20  
4689.539881  
30  
0.0  
11  
4747.09366  
21  
4660.18929  
31  
0.0  
0  
LINE  
5  
F652  
8  
1FLR  
10  
4704.050996  
20  
4685.899305  
30  
0.0  
11  
4706.696029  
21  
4689.539881  
31  
0.0  
0  
SOLID  
5  
F653  
8  
1SOLID  
10  
4749.976139  
20  
4651.317934  
30  
0.0  
11  
4747.09366  
21  
4660.18929  
31  
0.0  
12  
4745.696386  
22  
4649.927352  
32  
0.0  
13  
4743.265732  
23  
4657.408137  
33  
0.0  
0  
LINE  
5

F654  
8  
1FLR  
10  
4749.976139  
20  
4651.317934  
30  
0.0  
11  
4747.09366  
21  
4660.18929  
31  
0.0  
0

INSERT

5  
F655  
8  
1WD  
2  
D24  
10  
4749.976139  
20  
4651.317934  
30  
0.0  
50  
288.0  
0

LINE

5  
F656  
8  
1FLR  
10  
4754.348862  
20  
4623.29777  
30  
0.0  
11  
4758.628615  
21  
4624.688351  
31  
0.0  
0

LINE

5  
F657  
8  
1FLR  
10  
4745.696386  
20  
4649.927352  
30  
0.0

11  
4743.265732  
21  
4657.408137  
31  
0.0  
0  
LINE  
5  
F658  
8  
1FLR  
10  
4745.696386  
20  
4649.927352  
30  
0.0  
11  
4749.976139  
21  
4651.317934  
31  
0.0  
0  
LINE  
5  
F659  
8  
1CP  
10  
4775.846716  
20  
4629.67956  
30  
0.0  
11  
4760.592091  
21  
4618.645393  
31  
0.0  
0  
LINE  
5  
F65A  
8  
1FLR  
10  
4679.780485  
20  
4703.53286  
30  
0.0  
11  
4682.425518  
21  
4707.173437  
31  
0.0  
0

LINE

5

F65B

8

1FLR

10

4688.530973

20

4782.181955

30

0.0

11

4684.104656

21

4782.992955

31

0.0

0

LINE

5

F65C

8

1FLR

10

4680.311612

20

4762.291071

30

0.0

11

4684.104656

21

4782.992955

31

0.0

0

INSERT

5

F65D

8

1CP

2

SK1419

10

4813.707694

20

4615.234544

30

0.0

50

8.082928

0

LINE

5

F65E

8

1CP

10

4872.735146

20

4667.417847

30  
0.0  
11  
4878.322874  
21  
4628.07238  
31  
0.0  
0

LINE  
5  
F65F  
8  
1CP  
10  
4874.040701  
20  
4633.942812  
30  
0.0  
11  
4868.814146  
21  
4670.745108  
31  
0.0  
0

INSERT  
5  
F660  
8  
1CP  
2  
WC  
10  
4859.224593  
20  
4620.309927  
30  
0.0  
50  
278.082928  
0

LINE  
5  
F661  
8  
1CP  
10  
4841.403413  
20  
4617.779015  
30  
0.0  
11  
4838.450682  
21  
4638.570393  
31  
0.0  
0

ARC  
5  
F662  
8  
1CP  
10  
4881.293071  
20  
4628.494198  
30  
0.0  
40  
3.0  
50  
188.082928  
51  
278.082928  
0

LINE  
5  
F663  
8  
1CP  
10  
4875.639712  
20  
4632.741495  
30  
0.0  
11  
4874.040701  
21  
4633.942812  
31  
0.0  
0

LINE  
5  
F664  
8  
1CP  
10  
4877.045774  
20  
4622.840839  
30  
0.0  
11  
4875.639712  
21  
4632.741495  
31  
0.0  
0

INSERT  
5  
F665  
8  
1WD  
2  
FD20



10  
4860.110952  
20  
4687.81853  
30  
0.0  
50  
117.917072

0  
LINE  
5  
F666  
8  
1CP  
10  
4868.6094  
20  
4682.244775  
30  
0.0  
11  
4870.015463  
21  
4672.344119  
31  
0.0  
0

LINE  
5  
F667  
8  
1CP  
10  
4870.015463  
20  
4672.344119  
30  
0.0  
11  
4868.814146  
21  
4670.745108  
31  
0.0  
0

SOLID  
5  
F668  
8  
1SOLID  
10  
4865.948817  
20  
4686.41208  
30  
0.0  
11  
4864.08727  
21  
4689.925399  
31

0.0  
12  
4863.452294  
22  
4681.512378  
32  
0.0  
13  
4860.110952  
23  
4687.81853  
33  
0.0  
0  
LINE  
5  
F669  
8  
1FLR  
10  
4865.948817  
20  
4686.41208  
30  
0.0  
11  
4864.08727  
21  
4689.925399  
31  
0.0  
0  
LINE  
5  
F66A  
8  
1FLR  
10  
4863.452294  
20  
4681.512378  
30  
0.0  
11  
4860.110952  
21  
4687.81853  
31  
0.0  
0  
LINE  
5  
F66B  
8  
1FLR  
10  
4860.110952  
20  
4687.81853  
30  
0.0

11  
4864.08727  
21  
4689.925399  
31  
0.0  
0  
LINE  
5  
F66C  
8  
1FLR  
10  
4871.368998  
20  
4768.171146  
30  
0.0  
11  
4865.637341  
21  
4762.954768  
31  
0.0  
0  
SOLID  
5  
F66D  
8  
1SOLID  
10  
4814.794946  
20  
4830.333635  
30  
0.0  
11  
4703.454118  
21  
4880.618303  
31  
0.0  
12  
4810.143046  
22  
4823.93084  
32  
0.0  
13  
4701.785209  
23  
4872.868305  
33  
0.0  
0  
LINE  
5  
F66E  
8  
1FLR  
10

4814.794946

20

4830.333635

30

0.0

11

4703.453824

21

4880.618436

31

0.0

0

LINE

5

F66F

8

1FLR

10

4810.143046

20

4823.93084

30

0.0

11

4701.785209

21

4872.868305

31

0.0

0

LINE

5

F670

8

1FLR

10

4701.506963

20

4853.003023

30

0.0

11

4697.080646

21

4853.814023

31

0.0

0

SOLID

5

F671

8

1SOLID

10

4701.506963

20

4853.003023

30

0.0

11

4704.889821

21  
4871.466174  
31  
0.0  
12  
4697.080646  
22  
4853.814023  
32  
0.0  
13  
4700.571836  
23  
4872.868432  
33  
0.0  
0  
LINE  
5  
F672  
8  
1FLR  
10  
4701.506963  
20  
4853.003023  
30  
0.0  
11  
4704.889821  
21  
4871.466174  
31  
0.0  
0  
LINE  
5  
F673  
8  
1FLR  
10  
4697.080646  
20  
4853.814023  
30  
0.0  
11  
4700.571836  
21  
4872.868432  
31  
0.0  
0  
TEXT  
5  
F674  
8  
FUR  
10  
4746.583532  
20

4792.960117

30

0.0

40

5.0

1

DOUBLE

7

ROMANS

0

SOLID

5

F675

8

1SOLID

10

4840.407267

20

4802.191306

30

0.0

11

4814.794946

21

4830.333635

31

0.0

12

4834.67561

22

4796.974927

32

0.0

13

4810.143046

23

4823.93084

33

0.0

0

LINE

5

F676

8

1FLR

10

4840.407267

20

4802.191306

30

0.0

11

4814.794946

21

4830.333635

31

0.0

0

LINE

5

F677

8  
1FLR  
10  
4834.67561  
20  
4796.974927  
30  
0.0  
11  
4810.143046  
21  
4823.93084  
31  
0.0  
0

LINE  
5  
F678  
8  
1FLR  
10  
4840.407267  
20  
4802.191306  
30  
0.0  
11  
4834.67561  
21  
4796.974927  
31  
0.0  
0

LINE  
5  
F679  
8  
2NDB  
10  
4923.594701  
20  
4812.05849  
30  
0.0  
11  
4926.78894  
21  
4758.235588  
31  
0.0  
0

SOLID  
5  
F67A  
8  
1SOLID  
10  
4897.024872  
20  
4739.980962  
30

0.0  
11  
4934.034602  
21  
4626.076725  
31  
0.0  
12  
4890.169905  
22  
4735.998855  
32  
0.0  
13  
4926.148193  
23  
4625.269068  
33  
0.0  
0

LINE

5  
F67B  
8  
1FLR  
10  
4934.034602  
20  
4626.076725  
30  
0.0  
11  
4897.024872  
21  
4739.980962  
31  
0.0  
0

LINE

5  
F67C  
8  
1FLR  
10  
4926.148193  
20  
4625.269068  
30  
0.0  
11  
4890.169905  
21  
4735.998855  
31  
0.0  
0

LINE

5  
F67D  
8  
1CP



10  
4904.06458  
20  
4631.728142  
30  
0.0  
11  
4898.476851  
21  
4671.073609  
31  
0.0  
0

SOLID

5  
F67E  
8  
1SOLID  
10  
4905.914263  
20  
4687.542703  
30  
0.0  
11  
4924.736524  
21  
4629.61374  
31  
0.0

12  
4898.311368  
22  
4686.462962  
32  
0.0  
13  
4906.747742  
23  
4627.059026  
33  
0.0  
0

LINE

5  
F67F  
8  
1FLR  
10  
4902.766664  
20  
4687.09569  
30  
0.0  
11  
4911.203037  
21  
4627.691754  
31  
0.0  
0

LINE

5

F680

8

1FLR

10

4898.311368

20

4686.462962

30

0.0

11

4906.747742

21

4627.059026

31

0.0

0

LINE

5

F681

8

1FLR

10

4924.736524

20

4629.61374

30

0.0

11

4911.203037

21

4627.691754

31

0.0

0

ARC

5

F682

8

1CP

10

4901.094383

20

4631.306323

30

0.0

40

3.0

50

278.082928

51

8.082928

0

LINE

5

F683

8

1FLR

10

4905.914263

20  
4687.542703  
30  
0.0  
11  
4902.766664  
21  
4687.09569  
31  
0.0  
0  
LINE  
5  
F684  
8  
2NDB  
10  
4947.371115  
20  
4819.783912  
30  
0.0  
11  
4923.594701  
21  
4812.05849  
31  
0.0  
0  
SOLID  
5  
F685  
8  
2SOLID  
10  
5101.517179  
20  
4829.155799  
30  
0.0  
11  
5098.171737  
21  
4839.452003  
31  
0.0  
12  
5070.541453  
22  
4843.952003  
32  
0.0  
13  
5101.517179  
23  
4829.155799  
33  
0.0  
0  
SOLID  
5

F686  
8  
2SOLID  
10  
5070.541453  
20  
4843.952003  
30  
0.0  
11  
5275.753044  
21  
4843.952003  
31  
0.0  
12  
5098.171737  
22  
4839.452003  
32  
0.0  
13  
5275.753044  
23  
4839.452003  
33  
0.0  
0  
SOLID  
5  
F687  
8  
2SOLID  
10  
5005.449366  
20  
4860.370125  
30  
0.0  
11  
5101.517179  
21  
4829.155799  
31  
0.0  
12  
5006.839966  
22  
4864.649872  
32  
0.0  
13  
5070.541453  
23  
4843.952003  
33  
0.0  
0  
LINE  
5  
F688

8  
2FLR  
10  
5005.449366  
20  
4860.370125  
30  
0.0  
11  
5101.517179  
21  
4829.155799  
31  
0.0  
0

LINE

5  
F689  
8  
7FT  
10  
5095.425041  
20  
4937.580878  
30  
0.0  
11  
5048.645686  
21  
4876.240448  
31  
0.0  
0

LINE

5  
F68A  
8  
7FT  
10  
5074.683867  
20  
4966.127358  
30  
0.0  
11  
5095.427029  
21  
4937.578082  
31  
0.0  
0

LINE

5  
F68B  
8  
2NDB  
10  
5134.754909  
20  
5081.754225  
30

0.0  
11  
4988.77325  
21  
4975.692001  
31  
0.0  
0  
INSERT  
5  
F68C  
8  
2WD  
2  
D26  
10  
5083.856646  
20  
4972.796377  
30  
0.0  
41  
-1.0  
50  
216.000038  
0  
LINE  
5  
F68D  
8  
2CP  
10  
5120.828168  
20  
5069.163684  
30  
0.0  
11  
5005.051123  
21  
4985.046467  
31  
0.0  
0  
LINE  
5  
F68E  
8  
2CP  
10  
5120.385696  
20  
5066.37007  
30  
0.0  
11  
5007.844728  
21  
4984.604008  
31  
0.0

0  
LINE  
5  
F68F  
8  
2FLR  
10  
5275.753044  
20  
4843.952003  
30  
0.0  
11  
5070.541453  
21  
4843.952003  
31  
0.0  
0  
LINE  
5  
F690  
8  
2DIM  
10  
5102.564898  
20  
4801.479544  
30  
0.0  
11  
5074.042166  
21  
4801.479544  
31  
0.0  
0  
SOLID  
5  
F691  
8  
2SOLID  
10  
5026.782857  
20  
4658.075974  
30  
0.0  
11  
5094.126414  
21  
4590.800727  
31  
0.0  
12  
5022.837445  
22  
4655.65665  
32  
0.0  
13

5091.448625

23

4587.115066

33

0.0

0

LINE

5

F692

8

2FLR

10

5094.126242

20

4590.800491

30

0.0

11

5026.782686

21

4658.075737

31

0.0

0

LINE

5

F693

8

2NDB

10

5021.713705

20

4591.121755

30

0.0

11

5116.808027

21

4521.987603

31

0.0

0

LINE

5

F694

8

2NDB

62

8

10

5177.837547

20

4543.042156

30

0.0

11

5081.413457

21

4573.303092

31

0.0



0  
LINE  
5  
F695  
8  
2NDB  
62  
8

10  
5081.413457  
20  
4573.303092  
30  
0.0  
11  
5116.808027  
21  
4521.987603  
31  
0.0  
0

LINE  
5  
F696  
8  
2STR  
10  
5146.677907  
20  
4697.157515  
30  
0.0  
11  
5086.714857  
21  
4614.625257  
31  
0.0  
0

LINE  
5  
F697  
8  
2STR  
10  
5149.47151  
20  
4697.59998  
30  
0.0  
11  
5087.157324  
21  
4611.831653  
31  
0.0  
0

LINE  
5  
F698  
8

2STR

10

5088.332893

20

4613.449689

30

0.0

11

5117.457528

21

4592.289453

31

0.0

0

SOLID

5

F699

8

2SOLID

10

5094.126242

20

4590.800491

30

0.0

11

5178.919108

21

4547.542156

31

0.0

12

5091.448453

22

4587.11483

32

0.0

13

5177.837547

23

4543.042156

33

0.0

0

LINE

5

F69A

8

2FLR

10

5091.448453

20

4587.11483

30

0.0

11

5177.837547

21

4543.042156

31

0.0

0  
LINE  
5  
F69B  
8  
2STR  
10  
5058.841706  
20  
4632.404104  
30  
0.0  
11  
5087.157324  
21  
4611.831653  
31  
0.0  
0

LINE  
5  
F69C  
8  
2NDB  
62  
8  
10  
5022.837273  
20  
4655.656413  
30  
0.0  
11  
5081.413457  
21  
4573.303092  
31  
0.0  
0

LINE  
5  
F69D  
8  
2NDB  
10  
5021.671978  
20  
4591.108517  
30  
0.0  
11  
5022.837445  
21  
4655.65665  
31  
0.0  
0

LINE  
5  
F69E  
8

2STR  
10  
5076.640094  
20  
4619.472849  
30  
0.0  
11  
5071.923379  
21  
4612.980832  
31  
0.0  
0  
LINE  
5  
F69F  
8  
2FLR  
10  
5091.448453  
20  
4587.11483  
30  
0.0  
11  
5022.837273  
21  
4655.656413  
31  
0.0  
0  
LINE  
5  
F6A0  
8  
2NDB  
10  
4968.3668  
20  
4630.272089  
30  
0.0  
11  
4997.418921  
21  
4584.850789  
31  
0.0  
0  
LINE  
5  
F6A1  
8  
2NDB  
62  
8  
10  
5081.413457  
20  
4573.303092

30  
0.0  
11  
5021.713705  
21  
4591.121755  
31  
0.0  
0

LINE

5  
F6A2  
8  
2NDB  
10  
4997.418921  
20  
4584.850789  
30  
0.0  
11  
5021.195335  
21  
4592.576211  
31  
0.0  
0

LINE

5  
F6A3  
8  
2NDB  
62  
8  
10  
5081.413457  
20  
4573.303092  
30  
0.0  
11  
5091.448453  
21  
4587.11483  
31  
0.0  
0

LINE

5  
F6A4  
8  
2STR  
10  
5085.539289  
20  
4613.007222  
30  
0.0  
11  
5079.801874  
21

4605.110329

31

0.0

0

LINE

5

F6A5

8

2CP

10

5039.694979

20

4966.050409

30

0.0

11

5036.054404

21

4963.405372

31

0.0

0

LINE

5

F6A6

8

2NDB

10

5014.063534

20

4940.88299

30

0.0

11

4988.77325

21

4975.692001

31

0.0

0

LINE

5

F6A7

8

2NDB

10

4988.77325

20

4975.692001

30

0.0

11

4970.586255

21

4949.685222

31

0.0

0

LINE

5

F6A8

8  
2NDB  
10  
5049.099552  
20  
4953.106143  
30  
0.0  
11  
5039.694979  
21  
4966.050409  
31  
0.0  
0

SOLID

5  
F6A9  
8  
2SOLID  
10  
5083.856646  
20  
4972.796377  
30  
0.0  
11  
5048.979671  
21  
4947.456555  
31  
0.0  
12  
5081.21161  
22  
4976.436952  
32  
0.0  
13  
5045.459427  
23  
4950.461253  
33  
0.0  
0

LINE

5  
F6AA  
8  
2CP  
10  
5039.694979  
20  
4966.050409  
30  
0.0  
11  
5008.299518  
21  
4956.472286  
31

0.0  
0  
SOLID  
5  
F6AB  
8  
2SOLID  
10  
5049.099552  
20  
4953.106143  
30  
0.0  
11  
5039.694979  
21  
4966.050409  
31  
0.0  
12  
5045.458977  
22  
4950.461107  
32  
0.0  
13  
5036.054404  
23  
4963.405372  
33  
0.0  
0  
LINE  
5  
F6AC  
8  
2CP  
10  
5022.634191  
20  
4960.845506  
30  
0.0  
11  
5005.051123  
21  
4985.046467  
31  
0.0  
0  
LINE  
5  
F6AD  
8  
2CP  
10  
5024.65779  
20  
4961.462865  
30  
0.0



11  
5007.844728  
21  
4984.604008  
31  
0.0  
0  
LINE  
5  
F6AE  
8  
2FLR  
10  
5083.856646  
20  
4972.796377  
30  
0.0  
11  
5048.979221  
21  
4947.456409  
31  
0.0  
0  
LINE  
5  
F6AF  
8  
2FLR  
10  
5081.21161  
20  
4976.436952  
30  
0.0  
11  
5049.099552  
21  
4953.106143  
31  
0.0  
0  
LINE  
5  
F6B0  
8  
2NDB  
10  
4986.254344  
20  
4768.247604  
30  
0.0  
11  
4947.371115  
21  
4819.783912  
31  
0.0  
0

LINE

5

F6B1

8

2FLR

10

5005.449366

20

4860.370125

30

0.0

11

4990.868148

21

4768.609319

31

0.0

0

LINE

5

F6B2

8

2NDB

62

8

10

4985.237227

20

4869.303091

30

0.0

11

4986.254172

21

4768.247367

31

0.0

0

SOLID

5

F6B3

8

2SOLID

10

5005.807004

20

4862.619922

30

0.0

11

4990.86832

21

4768.609555

31

0.0

12

5001.47425

22

4864.02772

32

0.0

13  
4986.254344  
23  
4768.247604  
33  
0.0  
0  
LINE  
5  
F6B4  
8  
2FLR  
10  
5001.474078  
20  
4864.027483  
30  
0.0  
11  
4986.254172  
21  
4768.247367  
31  
0.0  
0  
LINE  
5  
F6B5  
8  
2NDB  
10  
4968.3668  
20  
4630.272089  
30  
0.0  
11  
5022.837445  
21  
4655.65665  
31  
0.0  
0  
SOLID  
5  
F6B6  
8  
2SOLID  
10  
4990.86832  
20  
4768.609555  
30  
0.0  
11  
5026.782898  
21  
4658.076098  
31  
0.0  
12

4986.254344

22

4768.247604

32

0.0

13

5022.837445

23

4655.65665

33

0.0

0

LINE

5

F6B7

8

2FLR

10

4986.254172

20

4768.247367

30

0.0

11

5022.837273

21

4655.656413

31

0.0

0

LINE

5

F6B8

8

2NDB

10

4968.3668

20

4630.272089

30

0.0

11

4926.78894

21

4758.235588

31

0.0

0

LINE

5

F6B9

8

2NDB

10

4986.254344

20

4768.247604

30

0.0

11

4926.78894

21  
4758.235588

31  
0.0  
0

POLYLINE

5  
F6BA

8  
2HDN  
66

1

10  
0.0

20  
0.0  
30  
0.0

70

1

0

VERTEX

5  
10167

8  
2HDN

10  
5055.041566

20  
4728.358984

30  
0.0  
0

VERTEX

5  
10168

8  
2HDN

10  
5029.655

20  
4684.833178

30  
0.0  
0

VERTEX

5  
10169

8  
2HDN

10  
5008.919576

20  
4748.650252

30  
0.0  
0

SEQEND

5  
1016A

8

2HDN

0

LINE

5

F6BB

8

2FLR

10

4990.868148

20

4768.609319

30

0.0

11

5026.782726

21

4658.075861

31

0.0

0

LINE

5

F6BC

8

2STR

10

5067.7409

20

4625.938477

30

0.0

11

5064.044884

21

4620.851335

31

0.0

0

LINE

5

F6BD

8

2STR

10

5060.017274

20

4634.02214

30

0.0

11

5086.714858

21

4614.625257

31

0.0

0

LINE

5

F6BE

8

2STR

10  
5060.017274  
20  
4634.02214  
30  
0.0  
11  
5056.166389  
21  
4628.721839  
31  
0.0  
0  
TEXT  
5  
F6BF  
8  
2TXT  
10  
5032.457497  
20  
4769.045089  
30  
0.0  
40  
8.0  
1  
OPEN TO  
0  
TEXT  
5  
F6C0  
8  
2TXT  
10  
5032.457497  
20  
4755.330803  
30  
0.0  
40  
8.0  
1  
BELOW  
0  
TEXT  
5  
F6C1  
8  
2DIM  
10  
5027.12744  
20  
4719.415458  
30  
0.0  
40  
6.0  
1  
SK  
7

ROMANS

0

LINE

5

F6C2

8

2NDB

62

8

10

5045.458977

20

4950.461107

30

0.0

11

4985.237227

21

4869.303091

31

0.0

0

LINE

5

F6C3

8

2NDB

62

8

10

4985.237227

20

4869.303091

30

0.0

11

5001.474078

21

4864.027483

31

0.0

0

LINE

5

F6C4

8

2NDB

10

5045.458977

20

4950.461107

30

0.0

11

4983.709548

21

4931.622601

31

0.0

0

LINE



5  
F6C5  
8  
2NDB  
62  
8  
10  
4985.237227  
20  
4869.303091  
30  
0.0  
11  
4983.709548  
21  
4931.622601  
31  
0.0  
0

LINE  
5  
F6C6  
8  
2NDB  
10  
4983.709548  
20  
4931.622601  
30  
0.0  
11  
4947.412745  
21  
4819.797119  
31  
0.0  
0

LINE  
5  
F6C7  
8  
2NDB  
62  
8  
10  
4947.412745  
20  
4819.797119  
30  
0.0  
11  
4985.237227  
21  
4869.303091  
31  
0.0  
0

LINE  
5  
F6C8  
8

2NDB  
10  
4983.709548  
20  
4931.622601  
30  
0.0  
11  
4970.586255  
21  
4949.685222  
31  
0.0  
0

LINE  
5  
F6C9  
8  
2FLR  
10  
5001.474078  
20  
4864.027483  
30  
0.0  
11  
5045.458977  
21  
4950.461107  
31  
0.0  
0

LINE  
5  
F6CA  
8  
6FT  
10  
5048.645686  
20  
4895.65685  
30  
0.0  
11  
5028.145406  
21  
4855.361535  
31  
0.0  
0

LINE  
5  
F6CB  
8  
5FT  
10  
5048.645686  
20  
4915.073253  
30  
0.0

11  
5019.668544  
21  
4858.115832  
31  
0.0  
0  
SOLID  
5  
F6CC  
8  
2SOLID  
10  
5048.97954  
20  
4947.456555  
30  
0.0  
11  
5005.807282  
21  
4862.619832  
31  
0.0  
12  
5045.459427  
22  
4950.461253  
32  
0.0  
13  
5001.474528  
23  
4864.027629  
33  
0.0  
0  
LINE  
5  
F6CD  
8  
2FLR  
10  
5006.839966  
20  
4864.649872  
30  
0.0  
11  
5048.97909  
21  
4947.456409  
31  
0.0  
0  
LINE  
5  
F6CE  
8  
2FLR  
10

5006.839966

20

4864.649872

30

0.0

11

5070.541453

21

4843.952003

31

0.0

0

TEXT

5

F6CF

8

2DIM

10

5004.668779

20

4837.589073

30

0.0

40

6.0

1

HEADROOM

50

341.999934

0

TEXT

5

F6D0

8

2DIM

10

5024.058251

20

4807.391332

30

0.0

40

6.0

1

RAILING OR

7

ROMANS

0

TEXT

5

F6D1

8

2DIM

10

5024.058251

20

4797.677046

30

0.0

40

6.0

1  
HALF-WALL  
7  
ROMANS  
0  
LINE  
5  
F6D2  
8  
7FT  
10  
5048.645686  
20  
4876.240448  
30  
0.0  
11  
5036.622268  
21  
4852.607238  
31  
0.0  
0  
TEXT  
5  
F6D3  
8  
2DIM  
10  
5013.410636  
20  
4844.203502  
30  
0.0  
40  
6.0  
1  
5'  
50  
341.999934  
0  
TEXT  
5  
F6D4  
8  
2DIM  
10  
5031.389498  
20  
4838.648448  
30  
0.0  
40  
6.0  
1  
7'  
50  
341.999934  
0  
TEXT  
5

F6D5  
8  
2DIM  
10  
5022.664582  
20  
4841.55814  
30  
0.0  
40  
6.0  
1  
6'  
50  
341.999934  
0

LINE  
5  
F6D6  
8  
7FT  
10  
5036.622268  
20  
4852.607238  
30  
0.0  
11  
5035.469619  
21  
4845.358553  
31  
0.0  
0

LINE  
5  
F6D7  
8  
6FT  
10  
5028.145406  
20  
4855.361535  
30  
0.0  
11  
5026.992759  
21  
4848.112863  
31  
0.0  
0

LINE  
5  
F6D8  
8  
5FT  
10  
5019.668544  
20  
4858.115832

30  
0.0  
11  
5018.515899  
21  
4850.867173  
31  
0.0  
0

LINE  
5  
F6D9  
8  
2NDB  
10  
5045.458977  
20  
4950.461107  
30  
0.0  
11  
5036.054404  
21  
4963.405372  
31  
0.0  
0

LINE  
5  
F6DA  
8  
2CP  
10  
5036.054404  
20  
4963.405372  
30  
0.0  
11  
5004.658955  
21  
4953.827254  
31  
0.0  
0

LINE  
5  
F6DB  
8  
2CP  
10  
5008.299518  
20  
4956.472286  
30  
0.0  
11  
5004.658955  
21  
4953.827254  
31

0.0  
0  
LINE  
5  
F6DC  
8  
5FT  
10  
5070.018346  
20  
4943.098612  
30  
0.0  
11  
5048.645686  
21  
4915.073253  
31  
0.0  
0  
LINE  
5  
F6DD  
8  
6FT  
10  
5082.721694  
20  
4940.339745  
30  
0.0  
11  
5048.645686  
21  
4895.65685  
31  
0.0  
0  
LINE  
5  
F6DE  
8  
5FT  
10  
5060.679027  
20  
4955.951793  
30  
0.0  
11  
5070.020225  
21  
4943.095294  
31  
0.0  
0  
LINE  
5  
F6DF  
8  
6FT



10  
5067.681447  
20  
4961.039576  
30  
0.0  
11  
5082.723627  
21  
4940.336688  
31  
0.0  
0  
TEXT  
5  
F6E0  
8  
2DIM  
10  
5057.275161  
20  
5005.824585  
30  
0.0  
40  
6.0  
1  
BALCONY  
50  
35.999635  
7  
ROMANS  
0  
LINE  
5  
F6E1  
8  
2FLR  
10  
5081.21161  
20  
4976.436952  
30  
0.0  
11  
5083.856646  
21  
4972.796377  
31  
0.0  
0  
LINE  
5  
F6E2  
8  
2NDB  
10  
5514.10071  
20  
4697.465054  
30

0.0  
11  
5452.387883  
21  
4591.107837  
31  
0.0  
0  
LINE  
5  
F6E3  
8  
7FT  
10  
5360.889289  
20  
4617.01346  
30  
0.0  
11  
5354.351569  
21  
4613.677259  
31  
0.0  
0  
TEXT  
5  
F6E4  
8  
2DIM  
10  
5345.53605  
20  
4612.808542  
30  
0.0  
40  
6.0  
1  
7'  
50  
306.000067  
0  
TEXT  
5  
F6E5  
8  
2DIM  
10  
5328.770416  
20  
4620.122358  
30  
0.0  
40  
6.0  
1  
HEADROOM  
50  
306.000067

0  
LINE  
5  
F6E6  
8  
2NDB  
62  
8

10  
5451.222875  
20  
4655.656267  
30  
0.0  
11  
5452.387883  
21  
4591.107837  
31  
0.0  
0

LINE  
5  
F6E7  
8  
6FT  
10  
5366.128262  
20  
4609.802594  
30  
0.0  
11  
5398.116451  
21  
4641.751445  
31  
0.0  
0

LINE  
5  
F6E8  
8  
5FT  
10  
5371.36725  
20  
4602.591747  
30  
0.0  
11  
5416.58255  
21  
4647.751442  
31  
0.0  
0

LINE  
5  
F6E9  
8

2NDB

62

8

10

5392.646272

20

4573.303093

30

0.0

11

5451.222949

21

4655.656535

31

0.0

0

SOLID

5

F6EA

8

2SOLID

10

5379.93403

20

4590.800254

30

0.0

11

5447.277587

21

4658.0755

31

0.0

12

5382.611819

22

4587.114593

32

0.0

13

5451.223121

23

4655.656298

33

0.0

0

LINE

5

F6EB

8

2FLR

10

5382.611648

20

4587.11483

30

0.0

11

5451.222949

21

4655.656535

31  
0.0  
0  
LINE  
5  
F6EC  
8  
2FLR  
10  
5379.933858  
20  
4590.800491  
30  
0.0  
11  
5447.277415  
21  
4658.075737  
31  
0.0  
0  
LINE  
5  
F6ED  
8  
2STR  
10  
5145.549855  
20  
4627.552709  
30  
0.0  
11  
5119.075564  
21  
4591.113885  
31  
0.0  
0  
LINE  
5  
F6EE  
8  
2STR  
10  
5144.607753  
20  
4629.658622  
30  
0.0  
11  
5116.28196  
21  
4590.671418  
31  
0.0  
0  
SOLID  
5  
F6EF  
8

2SOLID

10  
5381.545368  
20  
4592.410366  
30  
0.0

11  
5323.86764  
21  
4671.796842  
31  
0.0

12  
5377.904792  
22  
4589.765332  
32  
0.0

13  
5319.36764  
23  
4670.334702  
33  
0.0

0  
LINE  
5  
F6F0  
8  
2FLR

10  
5323.86764  
20  
4671.796842  
30  
0.0

11  
5384.22316  
21  
4588.724707  
31  
0.0

0  
LINE  
5  
F6F1  
8  
2FLR

10  
5319.36764  
20  
4670.334702  
30  
0.0

11  
5380.582584  
21  
4586.079673  
31  
0.0

0  
LINE  
5  
F6F2  
8  
2STR  
10  
5101.851932  
20  
4632.057095  
30  
0.0

11  
5130.976568  
21  
4610.89686  
31  
0.0  
0

LINE  
5  
F6F3  
8  
2STR  
10  
5095.092412  
20  
4622.753392  
30  
0.0

11  
5124.217048  
21  
4601.593157  
31  
0.0  
0

POLYLINE  
5  
F6F4  
8  
TEXT1  
66

1  
10  
0.0  
20  
0.0  
30  
0.0  
40  
1.5  
41  
1.5  
0

VERTEX  
5  
1016B  
8  
TEXT1  
10

5137.173868  
20  
4450.254619  
30  
0.0  
0  
VERTEX  
5  
1016C  
8  
TEXT1  
10  
5335.342356  
20  
4450.254619  
30  
0.0  
0  
SEQEND  
5  
1016D  
8  
TEXT1  
0  
TEXT  
5  
F6F5  
8  
TEXT1  
10  
5146.30493  
20  
4453.254619  
30  
0.0  
40  
12.0  
1  
SECOND FLOOR PLAN  
7  
TAHOMA  
0  
LINE  
5  
F6F6  
8  
2NDB  
10  
5303.532504  
20  
4483.393312  
30  
0.0  
11  
5296.222707  
21  
4543.042234  
31  
0.0  
0  
LINE



5  
F6F7  
8  
2NDB  
10  
5303.532504  
20  
4483.393312  
30  
0.0  
11  
5168.983719  
21  
4483.393313  
31  
0.0  
0

LINE  
5  
F6F8  
8  
2NDB  
10  
5357.251481  
20  
4521.987339  
30  
0.0  
11  
5296.222707  
21  
4543.042234  
31  
0.0  
0

LINE  
5  
F6F9  
8  
2NDB  
62  
8  
10  
5296.222707  
20  
4543.042234  
30  
0.0  
11  
5392.646272  
21  
4573.303093  
31  
0.0  
0

SOLID  
5  
F6FA  
8  
2SOLID  
10

5295.140993

20

4547.542156

30

0.0

11

5379.933858

21

4590.800491

31

0.0

12

5296.222707

22

4543.042234

32

0.0

13

5382.611648

23

4587.11483

33

0.0

0

LINE

5

F6FB

8

2FLR

10

5379.933858

20

4590.800491

30

0.0

11

5295.140993

21

4547.542156

31

0.0

0

LINE

5

F6FC

8

2FLR

10

5382.611648

20

4587.11483

30

0.0

11

5296.222707

21

4543.042234

31

0.0

0

SOLID

5  
F6FD  
8  
2SOLID  
10  
5178.919108  
20  
4547.542156  
30  
0.0  
11  
5295.140888  
21  
4547.542233  
31  
0.0  
12  
5177.837547  
22  
4543.042156  
32  
0.0  
13  
5296.222707  
23  
4543.042234  
33  
0.0  
0

LINE  
5  
F6FE  
8  
2FLR  
10  
5178.919108  
20  
4547.542156  
30  
0.0  
11  
5295.140888  
21  
4547.542233  
31  
0.0  
0

LINE  
5  
F6FF  
8  
2FLR  
10  
5177.837547  
20  
4543.042156  
30  
0.0  
11  
5296.222707  
21

4543.042234

31

0.0

0

LINE

5

F700

8

2NDB

10

5177.837547

20

4543.042156

30

0.0

11

5116.808027

21

4521.987603

31

0.0

0

LINE

5

F701

8

2NDB

10

5177.837547

20

4543.042156

30

0.0

11

5168.983719

21

4483.393313

31

0.0

0

LINE

5

F702

8

2NDB

10

5116.808023

20

4496.987603

30

0.0

11

5168.983719

21

4483.393313

31

0.0

0

LINE

5

F703

8  
2NDB  
10  
5116.808027  
20  
4521.987603  
30  
0.0  
11  
5116.808023  
21  
4496.987603  
31  
0.0  
0

LINE  
5  
F704  
8  
2STR  
10  
5119.075564  
20  
4591.113885  
30  
0.0  
11  
5145.773147  
21  
4571.717002  
31  
0.0  
0

LINE  
5  
F705  
8  
2STR  
10  
5116.28196  
20  
4590.671418  
30  
0.0  
11  
5144.597578  
21  
4570.098967  
31  
0.0  
0

LINE  
5  
F706  
8  
2STR  
10  
5145.773147  
20  
4571.717002  
30

0.0  
11  
5141.922232  
21  
4566.41666  
31  
0.0  
0  
LINE  
5  
F707  
8  
2FLR  
10  
5094.126242  
20  
4590.800491  
30  
0.0  
11  
5178.919108  
21  
4547.542156  
31  
0.0  
0  
LINE  
5  
F708  
8  
2STR  
10  
5117.899995  
20  
4589.495849  
30  
0.0  
11  
5112.162596  
21  
4581.598978  
31  
0.0  
0  
LINE  
5  
F709  
8  
2STR  
10  
5135.698384  
20  
4576.564594  
30  
0.0  
11  
5132.002353  
21  
4571.477432  
31  
0.0

0  
LINE  
5  
F70A  
8  
2STR  
10  
5126.79919  
20  
4583.030222  
30  
0.0  
11  
5122.082475  
21  
4576.538205  
31  
0.0  
0  
POLYLINE  
5  
F70B  
8  
2HDN  
66  
1  
10  
0.0  
20  
0.0  
30  
0.0  
70  
1  
0  
VERTEX  
5  
1016E  
8  
2HDN  
10  
5270.580921  
20  
4558.542158  
30  
0.0  
0  
VERTEX  
5  
1016F  
8  
2HDN  
10  
5237.0303  
20  
4596.136429  
30  
0.0  
0  
VERTEX  
5

10170  
8  
2HDN  
10  
5203.479679  
20  
4558.542158  
30  
0.0  
0  
SEQEND  
5  
10171  
8  
2HDN  
0  
TEXT  
5  
F70C  
8  
2DIM  
10  
5234.71666  
20  
4568.325286  
30  
0.0  
40  
6.0  
1  
SK  
7  
ROMANS  
0  
TEXT  
5  
F70D  
8  
2TXT  
10  
5254.40743  
20  
4605.123456  
30  
0.0  
40  
8.0  
1  
BELOW  
0  
LINE  
5  
F70E  
8  
2NDB  
62  
8  
10  
5392.646272  
20  
4573.303093



30  
0.0  
11  
5452.387802  
21  
4591.108084  
31  
0.0  
0

LINE  
5  
F70F  
8  
2NDB  
10  
5357.251481  
20  
4521.987339  
30  
0.0

11  
5452.387802  
21  
4591.108084  
31  
0.0  
0

LINE  
5  
F710  
8  
2NDB  
62

8

10  
5392.646272  
20  
4573.303093  
30  
0.0  
11  
5357.251481  
21  
4521.987339  
31  
0.0  
0

LINE  
5  
F711  
8  
2NDB  
10  
5303.532504  
20  
4483.393312  
30  
0.0  
11  
5355.708326  
21

4496.987567

31

0.0

0

LINE

5

F712

8

2NDB

10

5355.708326

20

4496.987567

30

0.0

11

5355.70833

21

4521.987567

31

0.0

0

LINE

5

F713

8

5FT

10

5371.367262

20

4602.59176

30

0.0

11

5364.829564

21

4599.25557

31

0.0

0

LINE

5

F714

8

6FT

10

5366.128275

20

4609.80261

30

0.0

11

5359.590566

21

4606.466415

31

0.0

0

TEXT

5

F715

8  
2DIM  
10  
5350.999478  
20  
4605.409799  
30  
0.0  
40  
6.0  
1  
6'  
50  
306.000067  
0

TEXT  
5  
F716  
8  
2DIM  
10  
5356.374994  
20  
4597.426235  
30  
0.0  
40  
6.0  
1  
5'  
50  
306.000067  
0

LINE  
5  
F717  
8  
2NDB  
62  
8  
10  
5382.611648  
20  
4587.11483  
30  
0.0  
11  
5392.646272  
21  
4573.303093  
31  
0.0  
0

LINE  
5  
F718  
8  
2FLR  
10  
5501.505501  
20

4731.369796

30

0.0

11

5529.358388

21

4728.503323

31

0.0

0

LINE

5

F719

8

2NDB

10

5508.064015

20

4795.097414

30

0.0

11

5501.505501

21

4731.369796

31

0.0

0

LINE

5

F71A

8

2NDB

62

8

10

5487.805976

20

4768.247221

30

0.0

11

5526.689058

21

4819.783219

31

0.0

0

LINE

5

F71B

8

2NDB

62

8

10

5487.805976

20

4768.247221

30

0.0

11  
5514.10071  
21  
4697.465054  
31  
0.0  
0  
LINE  
5  
F71C  
8  
2NDB  
62  
8

10  
5451.222875  
20  
4655.656267  
30  
0.0  
11  
5514.10071  
21  
4697.465054  
31  
0.0  
0

LINE  
5  
F71D  
8  
2NDB  
10  
5526.647231  
20  
4819.797031  
30  
0.0  
11  
5490.350219  
21  
4931.622664  
31  
0.0  
0

LINE  
5  
F71E  
8  
2NDB  
62  
8  
10  
5526.647231  
20  
4819.797031  
30  
0.0  
11  
5488.822503  
21

4869.303091

31

0.0

0

LINE

5

F71F

8

2NDB

10

5460.772291

20

4940.646374

30

0.0

11

5418.008188

21

4988.348103

31

0.0

0

LINE

5

F720

8

2FLR

10

5481.620879

20

4959.336917

30

0.0

11

5438.856776

21

5007.038645

31

0.0

0

LINE

5

F721

8

7FT

10

5399.37774

20

4966.130902

30

0.0

11

5378.635202

21

4937.581173

31

0.0

0

SOLID

5

F722

8  
2SOLID  
10  
5428.601045  
20  
4950.461261  
30  
0.0  
11  
5398.511598  
21  
4972.322493  
31  
0.0  
12  
5425.081011  
22  
4947.456409  
32  
0.0  
13  
5395.866566  
23  
4968.681916  
33  
0.0  
0

LINE

5  
F723  
8  
2NDB  
62

8

10  
5428.601045  
20  
4950.461261  
30  
0.0  
11  
5408.269218  
21  
5023.180894  
31  
0.0  
0

LINE

5  
F724  
8  
2FLR

10  
5425.081011  
20  
4947.456409  
30  
0.0  
11  
5390.203449  
21

4972.796406

31

0.0

0

LINE

5

F725

8

2FLR

10

5424.960467

20

4953.106292

30

0.0

11

5392.84848

21

4976.436984

31

0.0

0

INSERT

5

F726

8

FUR

2

BEDKING

10

5237.288455

20

5025.288092

30

0.0

50

89.999936

0

LINE

5

F727

8

2HDN

10

5253.722847

20

4957.749753

30

0.0

11

5305.695511

21

4929.283989

31

0.0

0

LINE

5

F728

8

2HDN



10  
5305.695511  
20  
4929.283989  
30  
0.0  
11  
5253.722846  
21  
4907.749753  
31  
0.0  
0  
LINE  
5  
F729  
8  
2STR  
10  
5185.415279  
20  
4671.485308  
30  
0.0  
11  
5318.531674  
21  
4671.485308  
31  
0.0  
0  
LINE  
5  
F72A  
8  
2HDN  
10  
5296.000552  
20  
4710.152547  
30  
0.0  
11  
5331.055778  
21  
4818.041438  
31  
0.0  
0  
LINE  
5  
F72B  
8  
2STR  
10  
5184.765439  
20  
4669.485308  
30  
0.0  
11

5319.984761

21

4669.485308

31

0.0

0

TEXT

5

F72C

8

2TXT

10

5254.40743

20

4618.837742

30

0.0

40

8.0

1

OPEN TO

0

LINE

5

F72D

8

2HDN

10

5331.055778

20

4818.041438

30

0.0

11

5237.030298

21

4886.354948

31

0.0

0

INSERT

5

F72E

8

2WD

2

D28

10

5307.753044

20

4843.952003

30

0.0

41

-1.0

50

360.0

0

LINE

5

F72F

8  
0  
10  
5237.030299  
20  
4787.490708  
30  
0.0  
11  
5237.030299  
21  
4794.490708  
31  
0.0  
0  
TEXT  
5  
F730  
8  
2DIM  
10  
5199.498511  
20  
4788.471192  
30  
0.0  
40  
6.0  
1  
222 sq. ft.  
7  
ROMANS  
0  
LINE  
5  
F731  
8  
2HDN  
10  
5143.00482  
20  
4818.041437  
30  
0.0  
11  
5178.919356  
21  
4707.507859  
31  
0.0  
0  
LINE  
5  
F732  
8  
2STR  
10  
5142.652542  
20  
4702.554249  
30

0.0  
11  
5101.517179  
21  
4829.155799  
31  
0.0  
0  
LINE  
5  
F733  
8  
2STR  
10  
5140.95124  
20  
4701.318181  
30  
0.0  
11  
5099.166098  
21  
4829.919545  
31  
0.0  
0  
LINE  
5  
F734  
8  
2HDN  
10  
5178.919356  
20  
4707.507859  
30  
0.0  
11  
5295.14124  
21  
4707.507857  
31  
0.0  
0  
LINE  
5  
F735  
8  
2STR  
10  
5149.47151  
20  
4697.59998  
30  
0.0  
11  
5142.652542  
21  
4702.554249  
31  
0.0

0  
LINE  
5  
F736  
8  
2STR  
10  
5146.677907  
20  
4697.157515  
30  
0.0  
11  
5140.95124  
21  
4701.318181  
31  
0.0  
0

LINE  
5  
F737  
8  
2STR  
10  
5141.527374  
20  
4686.665788  
30  
0.0  
11  
5170.652009  
21  
4665.505553  
31  
0.0  
0

LINE  
5  
F738  
8  
2STR  
10  
5122.130491  
20  
4659.968205  
30  
0.0  
11  
5151.255127  
21  
4638.80797  
31  
0.0  
0

LINE  
5  
F739  
8  
2STR  
10

5115.370971

20

4650.664501

30

0.0

11

5144.495607

21

4629.504266

31

0.0

0

LINE

5

F73A

8

2STR

10

5135.061746

20

4677.766593

30

0.0

11

5164.186382

21

4656.606358

31

0.0

0

LINE

5

F73B

8

2STR

10

5128.596119

20

4668.867399

30

0.0

11

5157.720754

21

4647.707164

31

0.0

0

LINE

5

F73C

8

2STR

10

5142.227841

20

4626.382952

30

0.0

11

5178.596174

21  
4676.439677  
31  
0.0  
0  
LINE  
5  
F73D  
8  
2STR  
10  
5143.169943  
20  
4624.27704  
30  
0.0  
11  
5179.038638  
21  
4673.646073  
31  
0.0  
0  
LINE  
5  
F73E  
8  
2STR  
10  
5142.227841  
20  
4626.382952  
30  
0.0  
11  
5178.596174  
21  
4676.439677  
31  
0.0  
0  
LINE  
5  
F73F  
8  
2DIM  
10  
5141.48953  
20  
4655.422528  
30  
0.0  
11  
5167.551751  
21  
4690.695183  
31  
0.0  
0  
LINE  
5

F740  
8  
2STR  
10  
5108.611452  
20  
4641.360798  
30  
0.0  
11  
5137.736087  
21  
4620.200563  
31  
0.0  
0

SOLID  
5  
F741  
8  
2DIM  
10  
5142.159291  
20  
4654.92668  
30  
0.0  
11  
5140.81977  
21  
4655.918377  
31  
0.0  
12  
5138.514441  
22  
4651.403966  
32  
0.0  
13  
5138.514441  
23  
4651.403966  
33  
0.0  
0

LINE  
5  
F742  
8  
2DIM  
10  
5167.551751  
20  
4690.695183  
30  
0.0  
11  
5172.551751  
21  
4690.695183



31  
0.0  
0  
LINE  
5  
F743  
8  
2STR  
10  
5147.993001  
20  
4695.564982  
30

0.0  
11  
5177.117637  
21  
4674.404747  
31  
0.0  
0

LINE  
5  
F744  
8  
2STR  
10  
5179.038638  
20  
4673.646073  
30

0.0  
11  
5184.765439  
21  
4669.485308  
31  
0.0  
0

LINE  
5  
F745  
8  
2STR  
10  
5178.596174  
20  
4676.439677  
30

0.0  
11  
5185.415279  
21  
4671.485308  
31  
0.0  
0

LINE  
5  
F746  
8

2DIM

10

5172.551751

20

4690.695183

30

0.0

11

5180.975085

21

4690.695183

31

0.0

0

TEXT

5

F747

8

2DIM

10

5172.641751

20

4693.195183

30

0.0

40

5.0

1

DN.

7

ROMANS

11

5172.641751

21

4695.695183

31

0.0

73

2

0

SOLID

5

F748

8

2DIM

10

5230.906506

20

4701.695085

30

0.0

11

5232.285339

21

4702.631353

31

0.0

12

5228.787119

22

4706.299718

32  
0.0  
13  
5228.787119  
23  
4706.299718  
33  
0.0  
0

LINE

5  
F749  
8  
2DIM  
10  
5231.595923  
20  
4702.163219  
30  
0.0  
11

5238.674845  
21  
4691.738157  
31  
0.0  
0

LINE

5  
F74A  
8  
2DIM  
10  
5238.674845  
20  
4691.738157  
30  
0.0  
11

5243.674845  
21  
4691.738157  
31  
0.0  
0

TEXT

5  
F74B  
8  
2DIM  
10  
5248.042162  
20  
4688.097768  
30  
0.0  
40

6.0  
1

OPTIONAL

7

ROMANS

0

TEXT

5

F74C

8

2DIM

10

5248.042162

20

4678.383483

30

0.0

40

6.0

1

CUPOLA

7

ROMANS

0

LINE

5

F74D

8

0

10

5237.030299

20

4787.490708

30

0.0

11

5232.915802

21

4781.827589

31

0.0

0

LINE

5

F74E

8

0

10

5237.030299

20

4787.490708

30

0.0

11

5241.144796

21

4781.827589

31

0.0

0

LINE

5

F74F

8

0

10  
5237.030299  
20  
4787.490708  
30  
0.0  
11  
5243.687695  
21  
4789.653827  
31  
0.0  
0

CIRCLE

5  
F750  
8  
0

10  
5237.030299  
20  
4787.490708  
30  
0.0  
40  
0.0001  
0

LINE

5  
F751  
8  
0

10  
5237.030299  
20  
4787.490708  
30  
0.0  
11  
5230.372903  
21  
4789.653827  
31  
0.0  
0

LINE

5  
F752  
8  
2TXT

10  
5134.838236  
20  
4890.094256  
30  
0.0  
11  
5248.838236  
21  
4890.094256  
31

0.0  
0  
TEXT  
5  
F753  
8  
2TXT  
10  
5134.838236  
20  
4893.094256  
30  
0.0  
40  
8.0  
1  
MASTER BEDROOM  
0  
LINE  
5  
F754  
8  
2HDN  
10  
5168.364215  
20  
4929.283991  
30  
0.0  
11  
5220.33688  
21  
4907.749753  
31  
0.0  
0  
LINE  
5  
F755  
8  
2HDN  
10  
5220.33688  
20  
4957.749753  
30  
0.0  
11  
5168.364215  
21  
4929.283991  
31  
0.0  
0  
LINE  
5  
F756  
8  
2FLR  
10  
5275.753044

20  
4839.452003  
30  
0.0  
11  
5098.171737  
21  
4839.452003  
31  
0.0  
0  
LINE  
5  
F757  
8  
2HDN  
10  
5237.030298  
20  
4886.354948  
30  
0.0  
11  
5143.00482  
21  
4818.041437  
31  
0.0  
0  
LINE  
5  
F758  
8  
2FLR  
10  
5101.517179  
20  
4829.155799  
30  
0.0  
11  
5098.171737  
21  
4839.452003  
31  
0.0  
0  
SOLID  
5  
F759  
8  
2DIM  
10  
5102.564898  
20  
4802.312877  
30  
0.0  
11  
5102.564898  
21

4800.64621

31

0.0

12

5107.564898

22

4801.479544

32

0.0

13

5107.564898

23

4801.479544

33

0.0

0

TEXT

5

F75A

8

2DIM

10

5134.838236

20

4881.094256

30

0.0

40

6.0

1

382 sq. ft.

7

ROMANS

0

LINE

5

F75B

8

2TXT

10

5199.498511

20

4797.471192

30

0.0

11

5259.498511

21

4797.471192

31

0.0

0

TEXT

5

F75C

8

2TXT

10

5199.498511

20

4800.471192



30  
0.0  
40  
8.0  
1  
STUDY  
0  
LINE  
5  
F75D  
8  
2FLR  
10  
5275.753044  
20  
4843.952003  
30  
0.0  
11  
5275.753044  
21  
4839.452003  
31  
0.0  
0  
LINE  
5  
F75E  
8  
2HDN  
10  
5220.33688  
20  
4907.749753  
30  
0.0  
11  
5220.33688  
21  
4957.749753  
31  
0.0  
0  
TEXT  
5  
F75F  
8  
2DIM  
10  
5195.892764  
20  
4929.26292  
30  
0.0  
40  
6.0  
1  
SK  
7  
ROMANS  
0

LINE

5

F760

8

2HDN

10

5253.722846

20

4907.749753

30

0.0

11

5253.722847

21

4957.749753

31

0.0

0

TEXT

5

F761

8

2DIM

10

5262.315227

20

4929.26292

30

0.0

40

6.0

1

SK

7

ROMANS

0

LINE

5

F762

8

2CP

10

5450.094609

20

4770.52158

30

0.0

11

5429.365907

21

4800.554617

31

0.0

0

SOLID

5

F763

8

2SOLID

10

5470.317904

20  
4833.879671  
30  
0.0  
11  
5470.317904  
21  
4770.52158  
31  
0.0  
12  
5450.094609  
22  
4833.879671  
32  
0.0  
13  
5450.094609  
23  
4770.52158  
33  
0.0  
0  
SOLID  
5  
F764  
8  
2SOLID  
10  
5472.82019  
20  
4833.879671  
30  
0.0  
11  
5482.888085  
21  
4770.52158  
31  
0.0  
12  
5470.317904  
22  
4833.879671  
32  
0.0  
13  
5470.317904  
23  
4770.52158  
33  
0.0  
0  
LINE  
5  
F765  
8  
2FLR  
10  
5472.82019  
20

4833.879671

30

0.0

11

5483.191926

21

4768.609486

31

0.0

0

LINE

5

F766

8

2FLR

10

5454.594609

20

4770.52158

30

0.0

11

5454.594609

21

4833.879671

31

0.0

0

LINE

5

F767

8

2FLR

10

5450.094609

20

4770.52158

30

0.0

11

5450.094609

21

4833.879671

31

0.0

0

INSERT

5

F768

8

2CP

2

SK1419

10

5343.387012

20

4783.379752

30

0.0

50

90.0

0  
LINE  
5  
F769  
8  
2CP  
10  
5427.093767  
20  
4800.554617  
30  
0.0

11  
5406.365064  
21  
4770.52158  
31  
0.0

0  
LINE  
5  
F76A  
8  
7FT  
10  
5439.812144  
20  
4749.298695  
30  
0.0

11  
5441.602431  
21  
4826.420383  
31  
0.0

0  
LINE  
5  
F76B  
8  
6FT  
10  
5451.710987  
20  
4754.533567  
30  
0.0

11  
5453.015106  
21  
4810.71218  
31  
0.0

0  
LINE  
5  
F76C  
8  
5FT  
10

5463.609831

20

4759.768439

30

0.0

11

5464.427781

21

4795.003976

31

0.0

0

LINE

5

F76D

8

2FLR

10

5323.86764

20

4858.405318

30

0.0

11

5323.86764

21

4758.742659

31

0.0

0

LINE

5

F76E

8

2FLR

10

5319.36764

20

4860.48527

30

0.0

11

5319.36764

21

4758.742659

31

0.0

0

SOLID

5

F76F

8

2SOLID

10

5323.86764

20

4858.405318

30

0.0

11

5323.86764

21  
4758.742659  
31  
0.0  
12  
5319.36764  
22  
4860.48527  
32  
0.0  
13  
5319.36764  
23  
4758.742659  
33  
0.0  
0  
LINE  
5  
F770  
8  
2TXT  
10  
5371.248879  
20  
4781.631727  
30  
0.0  
11  
5371.248879  
21  
4868.631727  
31  
0.0  
0  
TEXT  
5  
F771  
8  
2TXT  
10  
5368.248879  
20  
4781.631727  
30  
0.0  
40  
8.0  
1  
MASTER BATH  
50  
90.0  
0  
LINE  
5  
F772  
8  
2NDB  
62  
8  
10

5488.822503

20

4869.303091

30

0.0

11

5487.805901

21

4768.247538

31

0.0

0

SOLID

5

F773

8

2SOLID

10

5483.192125

20

4768.609082

30

0.0

11

5468.25344

21

4862.619449

31

0.0

12

5487.806073

22

4768.247301

32

0.0

13

5472.586195

23

4864.027247

33

0.0

0

LINE

5

F774

8

1CP

10

5344.86764

20

4876.268968

30

0.0

11

5344.86764

21

4770.52158

31

0.0

0

LINE



5  
F775  
8  
2FLR  
10  
5472.586023  
20  
4864.027483  
30  
0.0  
11  
5487.805901  
21  
4768.247538  
31  
0.0  
0

LINE  
5  
F776  
8  
2FLR  
10  
5401.865064  
20  
4770.52158  
30  
0.0  
11  
5398.013453  
21  
4770.52158  
31  
0.0  
0

SOLID  
5  
F777  
8  
2SOLID  
10  
5482.888085  
20  
4770.52158  
30  
0.0  
11  
5398.013453  
21  
4770.52158  
31  
0.0  
12  
5482.351067  
22  
4766.02158  
32  
0.0  
13  
5398.013453  
23

4766.02158

33

0.0

0

LINE

5

F778

8

2FLR

10

5482.351067

20

4766.02158

30

0.0

11

5398.013453

21

4766.02158

31

0.0

0

LINE

5

F779

8

2TXT

10

5345.879243

20

4714.02451

30

0.0

11

5405.879243

21

4714.02451

31

0.0

0

LINE

5

F77A

8

7FT

10

5379.650352

20

4635.751448

30

0.0

11

5423.532964

21

4699.196502

31

0.0

0

LINE

5

F77B

8  
6FT  
10  
5398.116451  
20  
4641.751445  
30  
0.0  
11  
5430.082352  
21  
4687.967435  
31  
0.0  
0

LINE  
5  
F77C  
8  
2FLR  
10  
5323.86764  
20  
4728.742659  
30  
0.0  
11  
5323.86764  
21  
4671.796842  
31  
0.0  
0

LINE  
5  
F77D  
8  
2FLR  
10  
5319.36764  
20  
4728.742659  
30  
0.0  
11  
5319.36764  
21  
4670.334702  
31  
0.0  
0

SOLID  
5  
F77E  
8  
2SOLID  
10  
5323.86764  
20  
4730.742659  
30

0.0  
11  
5323.86764  
21  
4671.796842  
31  
0.0  
12  
5319.36764  
22  
4730.742659  
32  
0.0  
13  
5319.36764  
23  
4670.334702  
33  
0.0  
0

LINE  
5  
F77F  
8  
7FT  
10  
5360.889274  
20  
4617.013441  
30  
0.0  
11  
5379.650352  
21  
4635.751448  
31  
0.0  
0

LINE  
5  
F780  
8  
2WD  
10  
5370.013453  
20  
4766.02158  
30  
0.0  
11  
5323.86764  
21  
4766.02158  
31  
0.0  
0

LINE  
5  
F781  
8  
2WD

10  
5370.013453  
20  
4770.52158  
30  
0.0  
11  
5323.86764  
21  
4770.52158  
31  
0.0  
0

LINE

5  
F782  
8  
2WD  
10  
5370.013453  
20  
4770.52158  
30  
0.0  
11  
5342.013453  
21  
4770.52158  
31  
0.0  
0

LINE

5  
F783  
8  
2WD  
10  
5342.013453  
20  
4766.02158  
30  
0.0  
11  
5370.013453  
21  
4766.02158  
31  
0.0  
0

TEXT

5  
F784  
8  
2TXT  
10  
5345.879243  
20  
4717.02451  
30  
0.0  
40

8.0  
1  
WALK-IN  
0  
TEXT  
5  
F785  
8  
2DIM  
10  
5345.879243  
20  
4705.02451  
30  
0.0  
40  
6.0  
1  
131 sq. ft.  
7  
ROMANS  
0  
INSERT  
5  
F786  
8  
2WD  
2  
D24  
10  
5323.86764  
20  
4758.742659  
30  
0.0  
50  
270.0  
0  
SOLID  
5  
F787  
8  
2SOLID  
10  
5342.013453  
20  
4770.52158  
30  
0.0  
11  
5323.86764  
21  
4770.52158  
31  
0.0  
12  
5342.013453  
22  
4766.02158  
32  
0.0

13  
5323.86764  
23  
4766.02158  
33  
0.0  
0

LINE

5  
F788  
8  
2WD  
10  
5342.013453  
20  
4770.52158  
30  
0.0  
11

5342.013453  
21  
4766.02158  
31  
0.0  
0

LINE

5  
F789  
8  
2FLR  
10  
5342.013453  
20  
4770.52158  
30  
0.0  
11

5342.013453  
21  
4766.02158  
31  
0.0  
0

INSERT

5  
F78A  
8  
2WD  
2  
PD24  
10  
5342.013453  
20  
4768.27158  
30  
0.0  
0

LINE

5  
F78B  
8

2FLR

10

5398.013453

20

4770.52158

30

0.0

11

5398.013453

21

4766.02158

31

0.0

0

LINE

5

F78C

8

6FT

10

5430.082352

20

4687.967435

30

0.0

11

5451.710987

21

4754.533567

31

0.0

0

LINE

5

F78D

8

5FT

10

5436.631741

20

4676.738367

30

0.0

11

5463.609831

21

4759.768439

31

0.0

0

LINE

5

F78E

8

7FT

10

5423.532964

20

4699.196502

30

0.0



11  
5439.812144  
21  
4749.298695  
31  
0.0  
0  
SOLID  
5  
F78F  
8  
2SOLID  
10  
5447.277587  
20  
4658.0755  
30  
0.0  
11  
5483.192019  
21  
4768.609006  
31  
0.0  
12  
5451.223121  
22  
4655.656298  
32  
0.0  
13  
5487.806073  
23  
4768.247301  
33  
0.0  
0  
LINE  
5  
F790  
8  
2FLR  
10  
5447.277415  
20  
4658.075737  
30  
0.0  
11  
5483.191926  
21  
4768.609486  
31  
0.0  
0  
LINE  
5  
F791  
8  
2FLR  
10

5451.222949

20

4655.656535

30

0.0

11

5487.805901

21

4768.247538

31

0.0

0

LINE

5

F792

8

5FT

10

5416.58255

20

4647.751442

30

0.0

11

5436.631741

21

4676.738367

31

0.0

0

LINE

5

F793

8

2FLR

10

5450.094609

20

4770.52158

30

0.0

11

5406.365064

21

4770.52158

31

0.0

0

LINE

5

F794

8

2CP

10

5406.365064

20

4770.52158

30

0.0

11

5406.365064

21  
4773.260878  
31  
0.0  
0  
LINE  
5  
F795  
8  
2CP  
10  
5401.865064  
20  
4770.52158  
30  
0.0  
11  
5401.865064  
21  
4773.260878  
31  
0.0  
0  
LINE  
5  
F796  
8  
2CP  
10  
5406.365064  
20  
4773.260878  
30  
0.0  
11  
5401.865064  
21  
4773.260878  
31  
0.0  
0  
LINE  
5  
F797  
8  
2FLR  
10  
5482.888085  
20  
4770.52158  
30  
0.0  
11  
5454.594609  
21  
4770.52158  
31  
0.0  
0  
LINE  
5

F798  
8  
6FT  
10  
5406.380271  
20  
4961.043272  
30  
0.0  
11  
5391.338544  
21  
4940.340056  
31  
0.0  
0  
SOLID  
5  
F799  
8  
2SOLID  
10  
5402.035756  
20  
4885.624143  
30  
0.0  
11  
5406.365064  
21  
4880.534731  
31  
0.0  
12  
5398.608129  
22  
4882.708431  
32  
0.0  
13  
5401.865064  
23  
4878.879671  
33  
0.0  
0  
LINE  
5  
F79A  
8  
2FLR  
10  
5401.865064  
20  
4878.879671  
30  
0.0  
11  
5398.608129  
21  
4882.708431

31  
0.0  
0  
LINE  
5  
F79B  
8  
2FLR  
10  
5398.608129  
20  
4882.708431  
30  
0.0  
11  
5402.035756  
21  
4885.624143  
31  
0.0  
0  
LINE  
5  
F79C  
8  
7FT  
10  
5425.414913  
20  
4876.240447  
30  
0.0  
11  
5378.635556  
21  
4937.580878  
31  
0.0  
0  
LINE  
5  
F79D  
8  
6FT  
10  
5425.414913  
20  
4895.656849  
30  
0.0  
11  
5391.338904  
21  
4940.339745  
31  
0.0  
0  
SOLID  
5  
F79E  
8

2SOLID

10  
5370.817045  
20  
4904.250706  
30  
0.0

11  
5423.2081  
21  
4948.817156  
31  
0.0

12  
5373.732756  
22  
4900.823078  
32  
0.0

13  
5426.130097  
23  
4945.394876  
33  
0.0

0  
LINE  
5  
F79F  
8  
2FLR

10  
5426.130097  
20  
4945.394876  
30  
0.0

11  
5382.652446  
21  
4908.410613  
31  
0.0

0  
LINE  
5  
F7A0  
8  
2FLR

10  
5423.2081  
20  
4948.817156  
30  
0.0

11  
5370.817045  
21  
4904.250706  
31  
0.0

0  
INSERT  
5  
F7A1  
8  
2WD  
2  
D20  
10  
5401.865064  
20  
4867.874881  
30  
0.0  
41  
-1.0  
50  
90.0  
0  
INSERT  
5  
F7A2  
8  
2WD  
2  
D26  
10  
5373.732756  
20  
4900.823078  
30  
0.0  
50  
220.38615  
0  
SOLID  
5  
F7A3  
8  
2SOLID  
10  
5350.881907  
20  
4881.385004  
30  
0.0  
11  
5323.86764  
21  
4858.405318  
31  
0.0  
12  
5347.966196  
22  
4884.812632  
32  
0.0  
13  
5319.36764  
23

4860.48527

33

0.0

0

LINE

5

F7A4

8

2FLR

10

5350.881907

20

4881.385004

30

0.0

11

5323.86764

21

4858.405318

31

0.0

0

LINE

5

F7A5

8

2FLR

10

5347.966196

20

4884.812632

30

0.0

11

5319.36764

21

4860.48527

31

0.0

0

INSERT

5

F7A6

8

2CP

2

SK1419

10

5343.387012

20

4827.715011

30

0.0

50

90.0

0

SOLID

5

F7A7

8

2SOLID



10  
5319.36764  
20  
4839.452003  
30  
0.0  
11  
5307.753044  
21  
4839.452003  
31  
0.0  
12  
5319.36764  
22  
4843.952003  
32  
0.0  
13  
5307.753044  
23  
4843.952003  
33  
0.0  
0  
LINE  
5  
F7A8  
8  
2FLR  
10  
5319.36764  
20  
4843.952003  
30  
0.0  
11  
5307.753044  
21  
4843.952003  
31  
0.0  
0  
LINE  
5  
F7A9  
8  
2FLR  
10  
5319.36764  
20  
4839.452003  
30  
0.0  
11  
5307.753044  
21  
4839.452003  
31  
0.0  
0

LINE

5

F7AA

8

2FLR

10

5307.753044

20

4843.952003

30

0.0

11

5307.753044

21

4839.452003

31

0.0

0

TEXT

5

F7AB

8

2DIM

10

5380.758304

20

4789.063415

30

0.0

40

6.0

1

115 sq. ft.

50

90.0

7

ROMANS

0

LINE

5

F7AC

8

2FLR

10

5347.966196

20

4884.812632

30

0.0

11

5350.881907

21

4881.385004

31

0.0

0

LINE

5

F7AD

8

2FLR

10  
5379.224819  
20  
4905.494901  
30  
0.0  
11  
5373.732756  
21  
4900.823078  
31  
0.0  
0  
LINE  
5  
F7AE  
8  
2FLR  
10  
5370.817045  
20  
4904.250706  
30  
0.0  
11  
5373.732756  
21  
4900.823078  
31  
0.0  
0  
INSERT  
5  
F7AF  
8  
2WD  
2  
FD26  
10  
5400.321943  
20  
4884.166287  
30  
0.0  
50  
130.38615  
0  
SOLID  
5  
F7B0  
8  
2SOLID  
10  
5382.652446  
20  
4908.410613  
30  
0.0  
11  
5386.485297  
21

4903.904821

31

0.0

12

5379.224819

22

4905.494901

32

0.0

13

5383.05767

23

4900.98911

33

0.0

0

LINE

5

F7B1

8

2FLR

10

5386.485297

20

4903.904821

30

0.0

11

5382.652446

21

4908.410613

31

0.0

0

LINE

5

F7B2

8

2FLR

10

5383.05767

20

4900.98911

30

0.0

11

5379.224819

21

4905.494901

31

0.0

0

LINE

5

F7B3

8

2FLR

10

5383.05767

20

4900.98911

30  
0.0  
11  
5386.485297  
21  
4903.904821  
31  
0.0  
0

LINE

5  
F7B4  
8  
2NDB  
62

8

10  
5488.822503  
20  
4869.303091  
30  
0.0  
11  
5428.601045  
21  
4950.461261  
31  
0.0  
0

LINE

5  
F7B5  
8  
2NDB  
62

8

10  
5488.822503  
20  
4869.303091  
30  
0.0  
11  
5490.350219  
21  
4931.622664  
31  
0.0  
0

LINE

5  
F7B6  
8  
2FLR  
10

5472.586023  
20  
4864.027483  
30  
0.0  
11

5428.601045

21

4950.461261

31

0.0

0

SOLID

5

F7B7

8

2SOLID

10

5406.365064

20

4880.534731

30

0.0

11

5406.365064

21

4867.874881

31

0.0

12

5401.865064

22

4878.879671

32

0.0

13

5401.865064

23

4867.874881

33

0.0

0

LINE

5

F7B8

8

2FLR

10

5406.365064

20

4867.874881

30

0.0

11

5406.365064

21

4880.534731

31

0.0

0

LINE

5

F7B9

8

2FLR

10

5401.865064

20  
4867.874881  
30  
0.0  
11  
5401.865064  
21  
4878.879671  
31  
0.0  
0  
SOLID  
5  
F7BA  
8  
2SOLID  
10  
5472.586023  
20  
4864.027483  
30  
0.0  
11  
5428.601045  
21  
4950.461261  
31  
0.0  
12  
5467.358408  
22  
4864.378153  
32  
0.0  
13  
5425.081011  
23  
4947.456409  
33  
0.0  
0  
SOLID  
5  
F7BB  
8  
2SOLID  
10  
5406.365064  
20  
4878.879671  
30  
0.0  
11  
5459.978783  
21  
4878.879671  
31  
0.0  
12  
5406.365064  
22

4874.379671

32

0.0

13

5462.268771

23

4874.379671

33

0.0

0

LINE

5

F7BC

8

6FT

10

5445.915192

20

4855.361535

30

0.0

11

5425.414913

21

4895.656849

31

0.0

0

LINE

5

F7BD

8

5FT

10

5454.392053

20

4858.115831

30

0.0

11

5425.414913

21

4915.073252

31

0.0

0

LINE

5

F7BE

8

2FLR

10

5462.268771

20

4874.379671

30

0.0

11

5406.365064

21

4874.379671



31  
0.0  
0  
LINE  
5  
F7BF  
8  
6FT  
10  
5453.015106  
20  
4810.71218  
30  
0.0  
11  
5445.915192  
21  
4855.361535  
31  
0.0  
0  
SOLID  
5  
F7C0  
8  
2SOLID  
10  
5406.365064  
20  
4838.379671  
30  
0.0  
11  
5472.10512  
21  
4838.379671  
31  
0.0  
12  
5401.865064  
22  
4833.879671  
32  
0.0  
13  
5472.82019  
23  
4833.879671  
33  
0.0  
0  
LINE  
5  
F7C1  
8  
2FLR  
10  
5472.10512  
20  
4838.379671  
30

0.0  
11  
5406.365064  
21  
4838.379671  
31  
0.0  
0

INSERT

5  
F7C2  
8  
2CP  
2

WC  
10  
5464.774084  
20  
4854.956532  
30  
0.0  
0

LINE

5  
F7C3  
8  
7FT  
10  
5441.602431  
20  
4826.420383  
30

0.0  
11  
5437.43833  
21  
4852.607238  
31  
0.0  
0

LINE

5  
F7C4  
8  
2CP  
10  
5450.094609  
20  
4833.879671  
30

0.0  
11  
5429.365907  
21  
4803.846635  
31  
0.0  
0

LINE

5  
F7C5

8  
2CP  
10  
5406.365064  
20  
4803.260878  
30  
0.0  
11  
5406.365064  
21  
4833.879671  
31  
0.0  
0

LINE

5  
F7C6  
8  
2CP  
10  
5401.865064  
20  
4803.260878  
30  
0.0  
11  
5401.865064  
21  
4833.879671  
31  
0.0  
0

LINE

5  
F7C7  
8  
2CP  
10  
5427.093767  
20  
4803.846635  
30  
0.0  
11  
5406.365064  
21  
4833.879671  
31  
0.0  
0

CIRCLE

5  
F7C8  
8  
2CP  
10  
5428.229837  
20  
4802.200626  
30

0.0  
40  
2.0  
0  
LINE  
5  
F7C9  
8  
2CP  
10  
5406.365064  
20  
4803.260878  
30  
0.0  
11  
5401.865064  
21  
4803.260878  
31  
0.0  
0  
LINE  
5  
F7CA  
8  
2FLR  
10  
5450.094609  
20  
4833.879671  
30  
0.0  
11  
5401.865064  
21  
4833.879671  
31  
0.0  
0  
LINE  
5  
F7CB  
8  
7FT  
10  
5437.43833  
20  
4852.607238  
30  
0.0  
11  
5425.414913  
21  
4876.240447  
31  
0.0  
0  
LINE  
5  
F7CC

8  
2FLR  
10  
5401.865064  
20  
4867.874881  
30  
0.0  
11  
5406.365064  
21  
4867.874881  
31  
0.0  
0  
SOLID  
5  
F7CD  
8  
2SOLID  
10  
5406.365064  
20  
4838.379671  
30  
0.0  
11  
5406.365064  
21  
4843.874881  
31  
0.0  
12  
5401.865064  
22  
4833.879671  
32  
0.0  
13  
5401.865064  
23  
4843.874881  
33  
0.0  
0  
LINE  
5  
F7CE  
8  
2FLR  
10  
5401.865064  
20  
4843.874881  
30  
0.0  
11  
5406.365064  
21  
4843.874881  
31

0.0  
0  
LINE  
5  
F7CF  
8  
2FLR  
10  
5406.365064  
20  
4838.379671  
30  
0.0  
11  
5406.365064  
21  
4843.874881  
31  
0.0  
0  
LINE  
5  
F7D0  
8  
2FLR  
10  
5401.865064  
20  
4833.879671  
30  
0.0  
11  
5401.865064  
21  
4843.874881  
31  
0.0  
0  
LINE  
5  
F7D1  
8  
5FT  
10  
5464.427781  
20  
4795.003976  
30  
0.0  
11  
5454.392053  
21  
4858.115831  
31  
0.0  
0  
LINE  
5  
F7D2  
8  
2NDB

62

8

10

5472.586023

20

4864.027483

30

0.0

11

5488.822503

21

4869.303091

31

0.0

0

LINE

5

F7D3

8

2FLR

10

5468.253269

20

4862.619686

30

0.0

11

5472.10512

21

4838.379671

31

0.0

0

LINE

5

F7D4

8

2FLR

10

5472.82019

20

4833.879671

30

0.0

11

5454.594609

21

4833.879671

31

0.0

0

LINE

5

F7D5

8

2FLR

10

5468.253269

20

4862.619686

30

0.0  
11  
5462.268771  
21  
4874.379671  
31  
0.0  
0  
LINE  
5  
F7D6  
8  
2FLR  
10  
5468.253269  
20  
4862.619686  
30  
0.0  
11  
5467.358408  
21  
4864.378153  
31  
0.0  
0  
LINE  
5  
F7D7  
8  
2NDB  
62  
8  
10  
5428.601045  
20  
4950.461261  
30  
0.0  
11  
5490.350219  
21  
4931.622664  
31  
0.0  
0  
LINE  
5  
F7D8  
8  
2FLR  
10  
5459.978783  
20  
4878.879671  
30  
0.0  
11  
5406.365064  
21  
4878.879671



31  
0.0  
0  
LINE  
5  
F7D9  
8  
2FLR  
10  
5459.978783  
20  
4878.879671  
30  
0.0  
11  
5425.081011  
21  
4947.456409  
31  
0.0  
0  
LINE  
5  
F7DA  
8  
5FT  
10  
5425.414913  
20  
4915.073252  
30  
0.0  
11  
5404.042251  
21  
4943.098611  
31  
0.0  
0  
LINE  
5  
F7DB  
8  
2FLR  
10  
5406.365064  
20  
4880.534731  
30  
0.0  
11  
5402.035756  
21  
4885.624143  
31  
0.0  
0  
LINE  
5  
F7DC  
8

5FT  
10  
5413.382803  
20  
4955.955643  
30  
0.0  
11  
5404.041885  
21  
4943.098939  
31  
0.0  
0  
LINE  
5  
F7DD  
8  
2FLR  
10  
5460.772291  
20  
4940.646374  
30  
0.0  
11  
5481.620879  
21  
4959.336917  
31  
0.0  
0  
LINE  
5  
F7DE  
8  
2FLR  
10  
5481.620879  
20  
4959.336917  
30  
0.0  
11  
5490.350219  
21  
4931.622664  
31  
0.0  
0  
LINE  
5  
F7DF  
8  
2FLR  
10  
5408.269218  
20  
5023.180894  
30  
0.0

11  
5295.827289  
21  
5072.9518  
31  
0.0  
0  
LINE  
5  
F7E0  
8  
5FT  
10  
5300.154456  
20  
5006.080297  
30  
0.0  
11  
5237.030299  
21  
5016.038399  
31  
0.0  
0  
LINE  
5  
F7E1  
8  
2NDB  
62  
8  
10  
5237.029864  
20  
5052.241149  
30  
0.0  
11  
5332.825393  
21  
5020.046249  
31  
0.0  
0  
LINE  
5  
F7E2  
8  
7FT  
10  
5336.0161  
20  
4968.54572  
30  
0.0  
11  
5263.222258  
21  
4994.080314  
31

0.0  
0  
LINE  
5  
F7E3  
8  
6FT  
10  
5334.714388  
20  
4981.479856  
30  
0.0  
11  
5281.688357  
21  
5000.080305  
31  
0.0  
0  
SOLID  
5  
F7E4  
8  
2SOLID  
10  
5331.05598  
20  
5015.769773  
30  
0.0  
11  
5237.0305  
21  
5030.613041  
31  
0.0  
12  
5332.825843  
22  
5020.046102  
32  
0.0  
13  
5237.0305  
23  
5035.168769  
33  
0.0  
0  
LINE  
5  
F7E5  
8  
2FLR  
10  
5237.03005  
20  
5030.613187  
30  
0.0

11  
5331.05553  
21  
5015.769919  
31  
0.0  
0  
LINE  
5  
F7E6  
8  
2FLR  
10  
5237.03005  
20  
5035.168915  
30  
0.0  
11  
5332.825393  
21  
5020.046249  
31  
0.0  
0  
LINE  
5  
F7E7  
8  
2NDB  
62  
8  
10  
5332.825393  
20  
5020.046249  
30  
0.0  
11  
5295.827289  
21  
5072.9518  
31  
0.0  
0  
LINE  
5  
F7E8  
8  
2NDB  
10  
5295.827289  
20  
5072.9518  
30  
0.0  
11  
5178.232233  
21  
5072.95193  
31

0.0

0

LINE

5

F7E9

8

7FT

10

5210.83834

20

4994.080314

30

0.0

11

5138.044498

21

4968.545721

31

0.0

0

LINE

5

F7EA

8

2NDB

62

8

10

5237.029864

20

5052.241149

30

0.0

11

5141.234537

21

5020.046222

31

0.0

0

LINE

5

F7EB

8

6FT

10

5237.030299

20

5007.125302

30

0.0

11

5192.372241

21

5000.080305

31

0.0

0

LINE

5

F7EC

8  
5FT  
10  
5237.030299  
20  
5016.038399  
30  
0.0  
11  
5173.906142  
21  
5006.080297  
31  
0.0  
0  
SOLID  
5  
F7ED  
8  
2SOLID  
10  
5237.0305  
20  
5030.613334  
30  
0.0  
11  
5143.005021  
21  
5015.770065  
31  
0.0  
12  
5237.0305  
22  
5035.169061  
32  
0.0  
13  
5141.234987  
23  
5020.046368  
33  
0.0  
0  
LINE  
5  
F7EE  
8  
2FLR  
10  
5237.03005  
20  
5030.613187  
30  
0.0  
11  
5143.004571  
21  
5015.769919  
31

0.0  
0  
LINE  
5  
F7EF  
8  
2FLR  
10  
5237.03005  
20  
5035.168915  
30  
0.0  
11  
5141.234537  
21  
5020.046222  
31  
0.0  
0  
LINE  
5  
F7F0  
8  
2NDB  
62  
8  
10  
5178.232233  
20  
5072.95193  
30  
0.0  
11  
5237.029864  
21  
5052.241149  
31  
0.0  
0  
LINE  
5  
F7F1  
8  
2CP  
10  
5131.829965  
20  
5032.990487  
30  
0.0  
11  
5150.64071  
21  
5059.889346  
31  
0.0  
0  
LINE  
5  
F7F2



8  
2CP  
10  
5128.18939  
20  
5030.345451  
30  
0.0  
11  
5147.000128  
21  
5057.2443  
31  
0.0  
0

LINE

5  
F7F3  
8  
2NDB  
10  
5160.045286  
20  
5046.945086  
30  
0.0  
11  
5134.754909  
21  
5081.754225  
31  
0.0  
0

LINE

5  
F7F4  
8  
2NDB  
10  
5141.234537  
20  
5020.046222  
30  
0.0  
11  
5178.232233  
21  
5072.95193  
31  
0.0  
0

LINE

5  
F7F5  
8  
2CP  
10  
5137.198927  
20  
5043.228333  
30

0.0  
11  
5120.385696  
21  
5066.37007  
31  
0.0  
0  
LINE  
5  
F7F6  
8  
2CP  
10  
5138.411406  
20  
5044.962109  
30  
0.0  
11  
5120.828168  
21  
5069.163684  
31  
0.0  
0  
LINE  
5  
F7F7  
8  
6FT  
10  
5192.372241  
20  
5000.080305  
30  
0.0  
11  
5139.34621  
21  
4981.479856  
31  
0.0  
0  
LINE  
5  
F7F8  
8  
5FT  
10  
5173.906142  
20  
5006.080297  
30  
0.0  
11  
5140.647922  
21  
4994.413992  
31  
0.0

0  
LINE  
5  
F7F9  
8  
2FLR  
10  
5143.004571  
20  
5015.769919  
30  
0.0  
11  
5108.127145  
21  
4990.429951  
31  
0.0  
0  
SOLID  
5  
F7FA  
8  
2SOLID  
10  
5105.482109  
20  
4994.070525  
30  
0.0  
11  
5141.234987  
21  
5020.046368  
31  
0.0  
12  
5108.127145  
22  
4990.429951  
32  
0.0  
13  
5143.004571  
23  
5015.769919  
33  
0.0  
0  
LINE  
5  
F7FB  
8  
2FLR  
10  
5137.593963  
20  
5017.401186  
30  
0.0  
11

5105.482109

21

4994.070525

31

0.0

0

LINE

5

F7FC

8

7FT

10

5117.302261

20

4997.092812

30

0.0

11

5138.045455

21

4968.54356

31

0.0

0

LINE

5

F7FD

8

2FLR

10

5105.482109

20

4994.070525

30

0.0

11

5108.127145

21

4990.429951

31

0.0

0

LINE

5

F7FE

8

5FT

10

5131.307101

20

5007.268377

30

0.0

11

5140.648314

21

4994.411888

31

0.0

0

LINE

5  
F7FF  
8  
6FT  
10  
5124.304681  
20  
5002.180594  
30  
0.0  
11  
5139.346885  
21  
4981.477724  
31  
0.0  
0

LINE  
5  
F800  
8  
2NDB  
10  
5131.829965  
20  
5032.990487  
30  
0.0  
11  
5141.234537  
21  
5020.046222  
31  
0.0  
0

LINE  
5  
F801  
8  
2NDB  
10  
5128.18939  
20  
5030.345451  
30  
0.0  
11  
5137.593963  
21  
5017.401186  
31  
0.0  
0

LINE  
5  
F802  
8  
2CP  
10  
5131.829965  
20

5032.990487

30

0.0

11

5128.18939

21

5030.345451

31

0.0

0

SOLID

5

F803

8

2SOLID

10

5141.234537

20

5020.046222

30

0.0

11

5131.829965

21

5032.990487

31

0.0

12

5137.593963

22

5017.401186

32

0.0

13

5128.18939

23

5030.345451

33

0.0

0

LINE

5

F804

8

2NDB

10

5134.754909

20

5081.754225

30

0.0

11

5165.108943

21

5091.014548

31

0.0

0

LINE

5

F805

8  
2NDB  
10  
5178.232233  
20  
5072.95193  
30  
0.0  
11  
5165.108943  
21  
5091.014548  
31  
0.0  
0

LINE  
5  
F806  
8  
2CP  
10  
5150.64071  
20  
5059.889346  
30  
0.0  
11  
5147.000128  
21  
5057.2443  
31  
0.0  
0

LINE  
5  
F807  
8  
2NDB  
62  
8  
10  
5237.029864  
20  
5052.241149  
30  
0.0  
11  
5295.827289  
21  
5072.9518  
31  
0.0  
0

LINE  
5  
F808  
8  
7FT  
10  
5263.222258  
20

4994.080314

30

0.0

11

5237.030299

21

4998.212206

31

0.0

0

LINE

5

F809

8

6FT

10

5281.688357

20

5000.080305

30

0.0

11

5237.030299

21

5007.125302

31

0.0

0

TEXT

5

F80A

8

FUR

10

5219.192011

20

4977.063453

30

0.0

40

5.0

1

KING

7

ROMANS

0

LINE

5

F80B

8

7FT

10

5237.030299

20

4998.212206

30

0.0

11

5210.83834

21

4994.080314



31  
0.0  
0  
LINE  
5  
F80C  
8  
2NDB  
62  
8  
10  
5237.03005  
20  
5035.168915  
30  
0.0  
11  
5237.029864  
21  
5052.241149  
31  
0.0  
0  
LINE  
5  
F80D  
8  
2NDB  
62  
8  
10  
5332.825393  
20  
5020.046249  
30  
0.0  
11  
5408.269218  
21  
5023.180894  
31  
0.0  
0  
LINE  
5  
F80E  
8  
7FT  
10  
5356.758671  
20  
4997.095425  
30  
0.0  
11  
5336.0161  
21  
4968.54572  
31  
0.0  
0

LINE

5

F80F

8

6FT

10

5349.75614

20

5002.183055

30

0.0

11

5334.714388

21

4981.479856

31

0.0

0

SOLID

5

F810

8

2SOLID

10

5360.269815

20

4994.544463

30

0.0

11

5331.05602

21

5015.769649

31

0.0

12

5362.914847

22

4998.185039

32

0.0

13

5332.825843

23

5020.046102

33

0.0

0

LINE

5

F811

8

2FLR

10

5368.577958

20

4994.070525

30

0.0

11

5336.465971

21  
5017.401217  
31  
0.0  
0  
LINE  
5  
F812  
8  
2FLR  
10  
5365.932927  
20  
4990.429947  
30  
0.0  
11  
5331.05557  
21  
5015.769795  
31  
0.0  
0  
LINE  
5  
F813  
8  
5FT  
10  
5333.412676  
20  
4994.413992  
30  
0.0  
11  
5300.154456  
21  
5006.080297  
31  
0.0  
0  
LINE  
5  
F814  
8  
5FT  
10  
5342.753608  
20  
5007.270684  
30  
0.0  
11  
5333.412676  
21  
4994.413992  
31  
0.0  
0  
LINE  
5

F815  
8  
2W  
10  
5397.189082  
20  
4970.502205  
30  
0.0  
11  
5361.592331  
21  
4996.364751  
31  
0.0  
0

LINE  
5  
F816  
8  
2W  
10  
5398.511598  
20  
4972.322493  
30  
0.0  
11  
5362.914847  
21  
4998.185039  
31  
0.0  
0

LINE  
5  
F817  
8  
2W  
10  
5395.866566  
20  
4968.681916  
30  
0.0  
11  
5360.269815  
21  
4994.544463  
31  
0.0  
0

LINE  
5  
F818  
8  
2FLR  
10  
5368.577958  
20  
4994.070525

30  
0.0  
11  
5365.932927  
21  
4990.429947  
31  
0.0  
0

LINE

5  
F819  
8  
2FLR  
10  
5392.84848  
20  
4976.436984  
30  
0.0  
11  
5390.203449  
21  
4972.796406  
31  
0.0  
0

LINE

5  
F81A  
8  
2FLR  
10  
5438.856776  
20  
5007.038645  
30  
0.0  
11  
5408.269218  
21  
5023.180894  
31  
0.0  
0

LINE

5  
F81B  
8  
2FLR  
10  
5418.008188  
20  
4988.348103  
30  
0.0  
11  
5438.856776  
21  
5007.038645  
31

0.0  
0  
LINE  
5  
F81C  
8  
2FLR  
10  
5535.916902  
20  
4792.230941  
30  
0.0  
11  
5529.358388  
21  
4728.503323  
31  
0.0  
0  
LINE  
5  
F81D  
8  
2FLR  
10  
5529.358388  
20  
4728.503323  
30  
0.0  
11  
5514.10071  
21  
4697.465054  
31  
0.0  
0  
LINE  
5  
F81E  
8  
2FLR  
10  
5535.916902  
20  
4792.230941  
30  
0.0  
11  
5526.689058  
21  
4819.783219  
31  
0.0  
0  
LINE  
5  
F81F  
8  
2FLR

10  
5508.064015  
20  
4795.097414  
30  
0.0  
11  
5535.916902  
21  
4792.230941  
31  
0.0  
0  
ENDSEC  
0  
EOF



## XE.COM Terms of Use

<http://www.xe.com/legal/>

Links

[XE.com Home](#) | [Currency Services Site Map](#)

Advertisement

Know a family we can help? Or would you like to help?  
Click here to visit us at [www.familit.org](http://www.familit.org) ▶  
National Center for Family Literacy

Ad Council  
John F. and James L. Knight Foundation  
National Center for Family Literacy

For information on advertising on this page, [click here](#).

### Quick Index

- [Terms of Use](#)
- [Disclaimer](#)
- [Privacy Policy](#)
- [Confidentiality and Transmissions over the Internet](#)
- [User Conduct and Obligations](#)
- [Indemnification by User](#)
- [Third Party Websites, Content and Products and Services](#)
- [Proprietary Rights](#)
- [Notice of Copyright Infringement](#)
- [General](#)
- [Contact Information](#)

### Terms of Use

Welcome to the website of XE.com Inc. (XE.com). This website is best viewed using a contemporary browser.

Use of this website, and information distributed in conjunction with this website, including without limitation the XE.com E-Mail Update Service, is offered to you on your acceptance of these Terms of Use, our Privacy Policy and other notices posted on this website. Your use of this website or of any content presented in any and all areas of the website indicates your acknowledgment and agreement to these Terms of Use, our Privacy Policy and other notices posted on this website. If you do not agree to be bound by and comply with all of the foregoing, you may not access or use our currency information, services, or website. We suggest you print a copy of each of these documents for your records.

XE.com shall have the right, at its sole discretion, to modify, add or remove any



terms or conditions of these Terms of Use without notice or liability to you. Any changes to these Terms of Use shall be effectively immediately following the posting of such changes on this website. The most recent version of these Terms of Use may always be found at <http://www.xe.com/legal/>. You agree to review these Terms of Use from time to time and agree that any subsequent use by you of this website following changes to these Terms of Use shall constitute your acceptance of all such changes. These Terms of Use were last modified on May 13, 2003.

## Disclaimer

This website is for informational purposes only and is not intended to provide specific commercial, financial, investment, accounting, tax, or legal advice. It is provided to you solely for your own personal, non-commercial use and not for purposes of resale, distribution, public display or performance, or any other uses by you in any form or manner whatsoever. Unless otherwise indicated on this website, you may display, download, archive, and print a single copy of any information on this website, or otherwise distributed from XE.com, for such personal, non-commercial use, provided it is done pursuant to the User Conduct and Obligations set forth herein.

XE.com has used its best commercial efforts to obtain the most accurate and timely information available, including information pertaining to currency rates, all of which are complex and subject to rapid change. Accordingly, we do not guarantee the accuracy, timeliness, reliability or completeness of any of the information contained on, downloaded or accessed from this website.

The performance of this website and all information contained on, downloaded or accessed from this website are provided to you on an "as is" basis, without warranties of any kind whatsoever, including any implied warranties or warranties of merchantability, fitness for a particular purpose or non-infringement of the rights of third parties. XE.com shall be not responsible for any problems or technical malfunction of any telephone network or lines, computer on-line systems, servers, Internet access providers, computer equipment, software, or any combination thereof including any injury or damage to your or any other person's computer as a result of using this website.

XE.com reserves the right, at its sole discretion, to modify, disable access to or discontinue, temporarily or permanently, any part or all of this website or any information contained thereon without liability or notice to you.

As a visitor to our website, you acknowledge and agree that any reliance on or use by you of any information available on this website shall be entirely at your own risk. In no event shall XE.com nor any of its data providers be liable for any direct, indirect, consequential or exemplary damages arising from the use or the performance of this website, even if XE.com or such provider has been advised of the possibility of such damages.

## Privacy Policy

You have read and agree to all of the terms and conditions of our Privacy Policy, which is located at: <http://www.xe.com/xenon/privacy.htm>.

## Confidentiality and Transmissions over the Internet

The transmission of data or information (including communications by e-mail) over the Internet or other publicly accessible networks is not secure, and is subject to possible loss, interception or alteration while in transit. Accordingly, we do not assume any liability for any damage you may experience or costs you may incur as a result of any transmissions over the Internet or other publicly accessible networks, such as transmissions involving the exchange of e-mail with us (including those which may contain your personal information). While we shall take commercially reasonable efforts to safeguard the privacy of the information you provide us and treat such information in accordance with our Privacy Policy, in no event will the information you provide to us be deemed to be confidential, create any fiduciary obligations to you on our part, or result in any liability to you on our part in the event that such information is inadvertently released by us or accessed by third parties without our consent.

## User Conduct and Obligations

You agree to follow all applicable laws and regulations when using this website. Furthermore, you agree that you shall not:

- . upload, post or otherwise transmit through or to this website any content that:
  - i. is unlawful, abusive, threatening, harmful, obscene, lewd, offensive, defamatory or otherwise objectionable;
  - ii. might infringe the intellectual property rights, privacy rights, rights of publicity, or other proprietary rights of others;
  - iii. contains any viruses, trojan horses, time bombs, or any other harmful programs or elements;
- b. disrupt, place unreasonable burdens or excessive loads on, interfere with or attempt to gain unauthorized access to any portion of our website, its computer systems, servers or networks;
- c. provide false information about yourself to us, impersonate any other person, or otherwise attempt to mislead others about your identity or the origin of any content, message or other communication;
- d. transmit junk mail, chain letters, or other unsolicited bulk e-mail or duplicative messages;
- e. collect information about other visitors to our website without their consent or otherwise systematically extract data or data fields, including without limitation any financial data or e-mail addresses;
- f. sell access to or the use of this website, including any content contained on, downloaded or accessed from this website, except as specifically permitted in writing by XE.com;

- g. redistribute any content, including financial data, provided by us in any manner whatsoever including by means of printed publication, fax broadcast, web pages, e-mail, web newsgroups or forums, or any other electronic or paper-based service or method;
- h. intentionally alter the format in which financial data is provided by us or otherwise circumvent our regular interfaces to such data; and
- i. embed or import any financial data provided by us into any information services (whether or not web-based), data files or application software, including without limitation accounting and payroll systems, except as except as specifically permitted in writing by XE.com.

By uploading, posting or otherwise transmitting through or to our website any content, you grant to us, our successors and assigns, a non-exclusive, world-wide, royalty free, perpetual, non-revocable license to use or distribute such content in any manner otherwise than as stated in our Privacy Policy.

### **Indemnification by User**

You agree to indemnify, defend and hold us and our affiliates, business partners, officers, directors, employees and agents harmless from any loss, liability, claim, demand, damage, or expense (including reasonable legal fees) asserted by any third party relating in any way to your use of this website or breach of these Terms of Use. We reserve the right to assume the exclusive defence and control of any matter subject to indemnification by you, which shall not excuse your indemnity obligations.

### **Third Party Websites, Content and Products and Services**

Links or pointers to other websites and references to products and services offered by third parties are provided to you for convenience only and do not constitute an endorsement or approval by us of (i) the organizations that operate such websites; (ii) the content, privacy policies or other terms of use on such websites; or (iii) such third party products and services. As we have no control or responsibility over websites or content maintained by other organizations, or for products and services offered by third parties, we do not assume any liability for your use of any of the foregoing, which use you acknowledge and agree shall be at your own risk.

### **Proprietary Rights**

XE, XE.COM, UNIVERSAL CURRENCY CONVERTER, the spinning 'X' and currency logos, and other identifying marks of XE Corporation are and shall remain the trade-marks and trade names and exclusive property of XE Corporation, and any unauthorized use of these marks is unlawful. Other trade-marks on this website are the property of their respective owners. All content on this website, including without limitation all programs, compiled binaries, interface layout, interface text, documentation and graphics, is the copyrighted property of XE.com and is protected by international copyright law. The content on this website may be used

by you only for your personal, non-commercial use as provided for in these Terms of Use, but may not be taken out of context or presented in a misleading or discriminatory manner. Any rights not expressly granted to you are reserved by us.

## Notice of Copyright Infringement

Our policy is to comply with all intellectual property laws and to act expeditiously upon receiving any notice of claimed infringement. If you believe that your work has been reproduced on this website in a manner that constitutes copyright infringement, please provide a notice of copyright infringement containing all of the following information:

1. A physical or electronic signature of a person authorized to act on behalf of the copyright owner for the purposes of the complaint.
2. Identification of the copyrighted work claimed to have been infringed.
3. Identification of the material on our website that is claimed to be infringing or to be the subject of infringing activity.
4. The address, telephone number or e-mail address of the complaining party.
5. A statement that the complaining party has a good-faith belief that use of the material in the manner complained of is not authorized by the copyright owner, its agent or the law.
6. A statement, under penalty of perjury, that the information in the notice of copyright infringement is accurate, and that the complaining party is authorized to act on behalf of the owner of the right that is allegedly infringed.

All notices of copyright infringement should be sent to:

**XE.com**

330 Bay Street, Suite 1109

Toronto ON M5H 2S8

Canada

Attention: Intellectual Property Manager

Facsimile: +1 416 214-5607

E-mail: [copyright@xe.com](mailto:copyright@xe.com)

**IMPORTANT:** We at XE.com are committed to establishing our services in as many languages as possible. However, our company is based in Canada and our staff are English-speaking. We apologize, but we can only correspond in English.

## General

If any provision of these Terms of Use is held invalid or unenforceable in any respect by any court having competent jurisdiction, such provision shall be enforced to the maximum extent permitted by law, and the remaining provisions of these Terms of Use shall continue in full force and effect. No waiver of any provision of these Terms of Use shall be deemed a further or continuing waiver of such provision or any other provision of these Terms of Use.

You agree that these Terms of Sale, our Privacy Policy and other notices posted on this website have been drawn up in English. Although translations in other languages of any of the foregoing documents may be available, such translations may not be up to date or complete. Accordingly, you agree that in the event of any conflict between the English language version of the forgoing documents and any other translations thereto, the English language version of such documents shall govern.

These Terms of Use shall be governed by and construed in accordance with the laws of the Province of Ontario and the laws of Canada applicable therein, without regard to conflict of laws provisions thereto. The parties consent to the exclusive jurisdiction of the courts of, and venue and situs in, Toronto, Ontario.

## Contact

If you have any questions or concerns about our website or these Terms of Use, please feel free to contact us at [currency@xe.com](mailto:currency@xe.com).

[TOP](#)

Copyright © 2004 XE.com | [Terms of Use](#)



# FLORIDA SOLAR ENERGY CENTER

A Research Institute of the University of Central Florida



[| Education & Training](#) | [| Environment](#) | [| Homes & Buildings](#) | [| Photovoltaics](#) | [| Solar Energy](#) |

## About Us

- [Building Tour](#)
- [Staff Directory](#)
- [Qualifications](#)
- [Directions & Local Hotels](#)
- [What's New](#)
- [News Releases](#)
- [Job Opportunities](#)

## Publications

- [Search](#)
- [Consumer Corner](#)
- [Energy Q&A](#)
- [On Sale](#)
- [Online](#)
- [Resources](#)
- [FSEC Library](#)
- [Documents](#)
- [Databases](#)
- [Related Links](#)

## Contact Us

- [Staff Directory](#)

[Site Guide](#) | [Home](#)



**NREL's 17th Industry Growth Forum**  
 America's largest Clean Energy Investment Forum

**Orlando, Florida**  
**October 18 - 20, 2004**



## FLORIDA SOLAR STANDARDS ONLINE

FSEC is seeking input on revised solar energy system standards for Florida

**Florida Universities NASA Hydrogen Research**  
[online here](#)

## Florida's Energy Future

Now posted on Florida Department of Environmental Protection's site

-  [Executive Summary](#) (120 kB)
-  [Download full report](#) (1.2 MB)
-  [Download the appendices](#) (3 MB)



The FLORIDA HYDROGEN PARTNERSHIP  
 Moving Florida to the forefront of the nation's hydrogen economy

[Visit this new Website Dedicated to Florida's Energy Future](#)

Search the FSEC Website:

**SEARCH PUBLICATIONS**  
[Search FSEC's Publications](#)



**Cocoa Weather**  
 Sunny  
 79° F

**information monitors**  
 (Real time data!)

[Accredited PV Systems Test Lab](#)



**Building AMERICA**  
 U.S. Department of Energy  
**Industrialized Housing Partnership**

Want to save energy and improve indoor air quality in homes? [Click here](#) for details on this U.S. DOE funded project.

[Visit Florida's solar industry website](#)



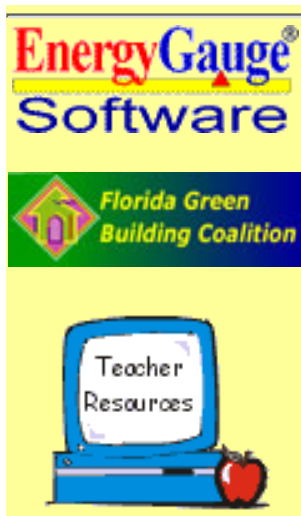

[| Education & Training |](#) [| Environment |](#) [| Homes & Buildings |](#)  
[| Photovoltaics |](#) [| Solar Energy |](#)



Please direct questions and comments about this web page to [Webmaster](#)

© Copyright 2003. FSEC. All rights reserved.

1679 Clearlake Road, Cocoa, Florida 32922  
Hours: Mon-Fri, 8:00 a.m. - 5:00 p.m.  
Phone (321) 638-1000 FAX (321) 638-1010

Revised:  
June 23, 2004

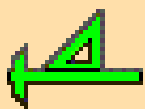

- [Home](#)
- [Order](#)
- [DEMO](#)
- [Upgrade](#)
- [Register](#)
- [Features](#)
- [Samples](#)
- [Troubleshooting](#)
- [Contact Us](#)
- [Y2K](#)

# DELTA CAD®

## Professional

Version 5.0

## World's easiest CAD Program



[Try our DEMO](#)

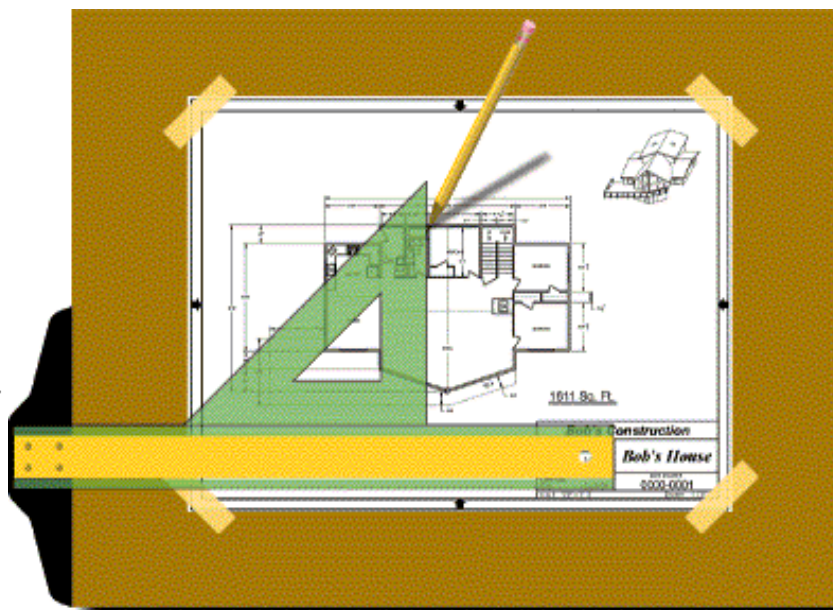

## Over 150,000 sold!!!

Y2K Compatible

Version 5.0 For Windows™ 95, 98, NT(4.0), 2000, ME, or XP

Order DeltaCad Now \$39.95





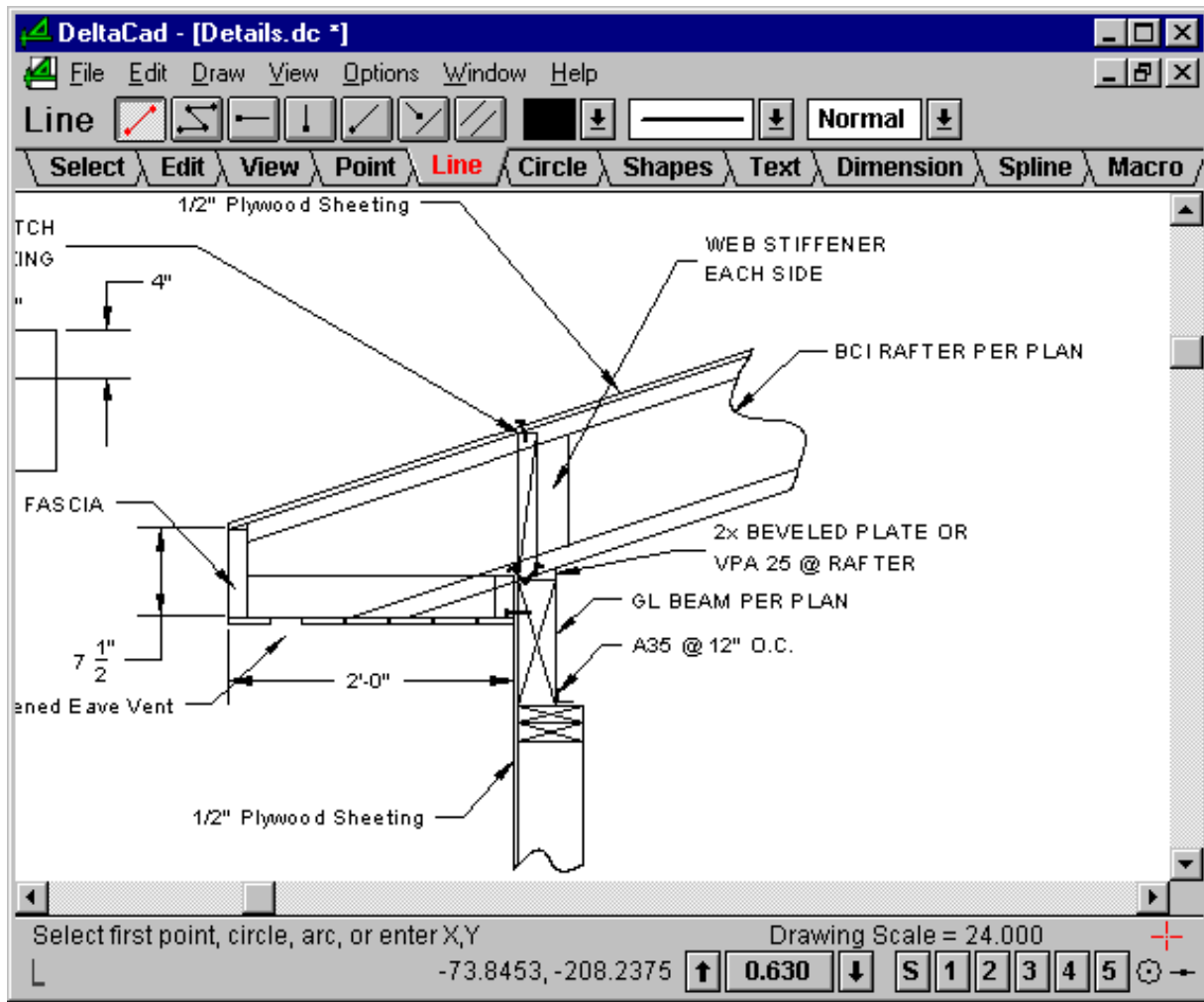



P.O. Box 666  
Barton VT 05822, USA  
Toll free: 1-866-Warm-Toes  
(1-866-927-6863)  
[info@radiantcompany.com](mailto:info@radiantcompany.com)

"Your package of parts and instructions made the job easy. It's harder to put a bike together! I am extremely impressed with your company's help and your website has the answers to the questions I had. We absolutely love the radiant floor heat. It's like a heating pad on your feet."  
Bill Stock  
Wind Lake, Wisconsin

[System Types](#)

[Frequently Asked Questions](#)

[Radiant Dictionary](#)

[Prices](#)

[Getting Started](#)

[Installation Details, Details, Details](#)

[Heat Sources](#)

[Contact Us](#)

## We're **Hot** to Help You with **Radiant Heat!**

If you're a do-it-yourselfer looking for help designing a radiant heating system and it seems like nobody in the industry is willing to help you...then you've found the right company. If you've received quotes of 10, 20, and even \$30,000! for a radiant heating system and are still recovering from the shock....relief is right here.

Our technicians have designed thousands of radiant floor systems for do-it-yourselfers. We work WITH you....and we give you ALL the information in simple, easy to understand language.

This website, our installation manual, and our do-it-yourself installation packages take the mystery and guesswork out of what is, in reality, a very basic and straightforward technology.

We sell directly to the customer....with no distributors or middlemen.

This is a proven technology. Our manifolds, pumps, and controllers are of the finest quality and will give you years of trouble free service.

We'll guide you every step of the way and we won't leave you stranded with a box of parts and a question mark.

Call our TOLL FREE [technical support line](#) and request our [free installation manual](#). It's easy to read and packed with innovative, cost-cutting installation tips. You CAN have the ultimate heating system, and we'll show you how.

Being from Vermont, we know about radiant heat and how to keep you warm!

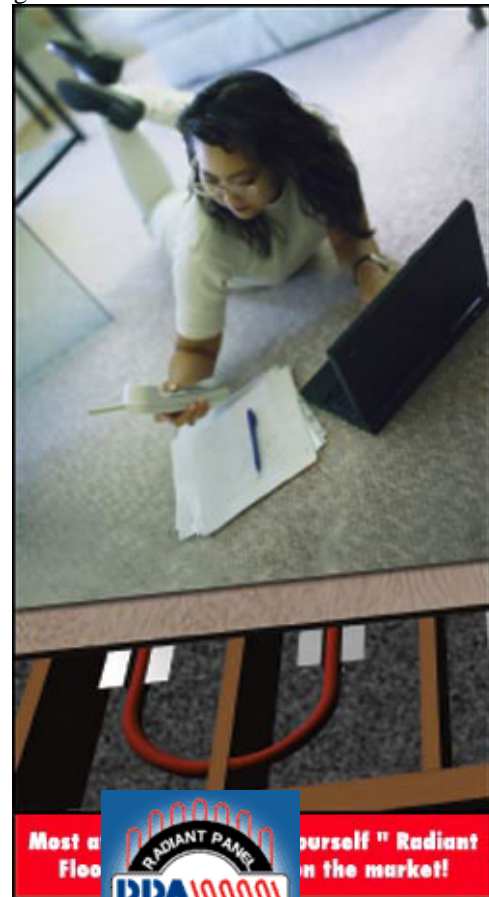

Most a Floor **RADIANT PANEL** yourself " Radiant on the market!



Member: [Radiant Panel Association](#)





Typical slab layout using 7/8" Pex tubing

**Temperature outside our office in  
Barton, Vermont**



**The Radiant Heat in our office  
keeps us at a constant 72° F in  
winter**















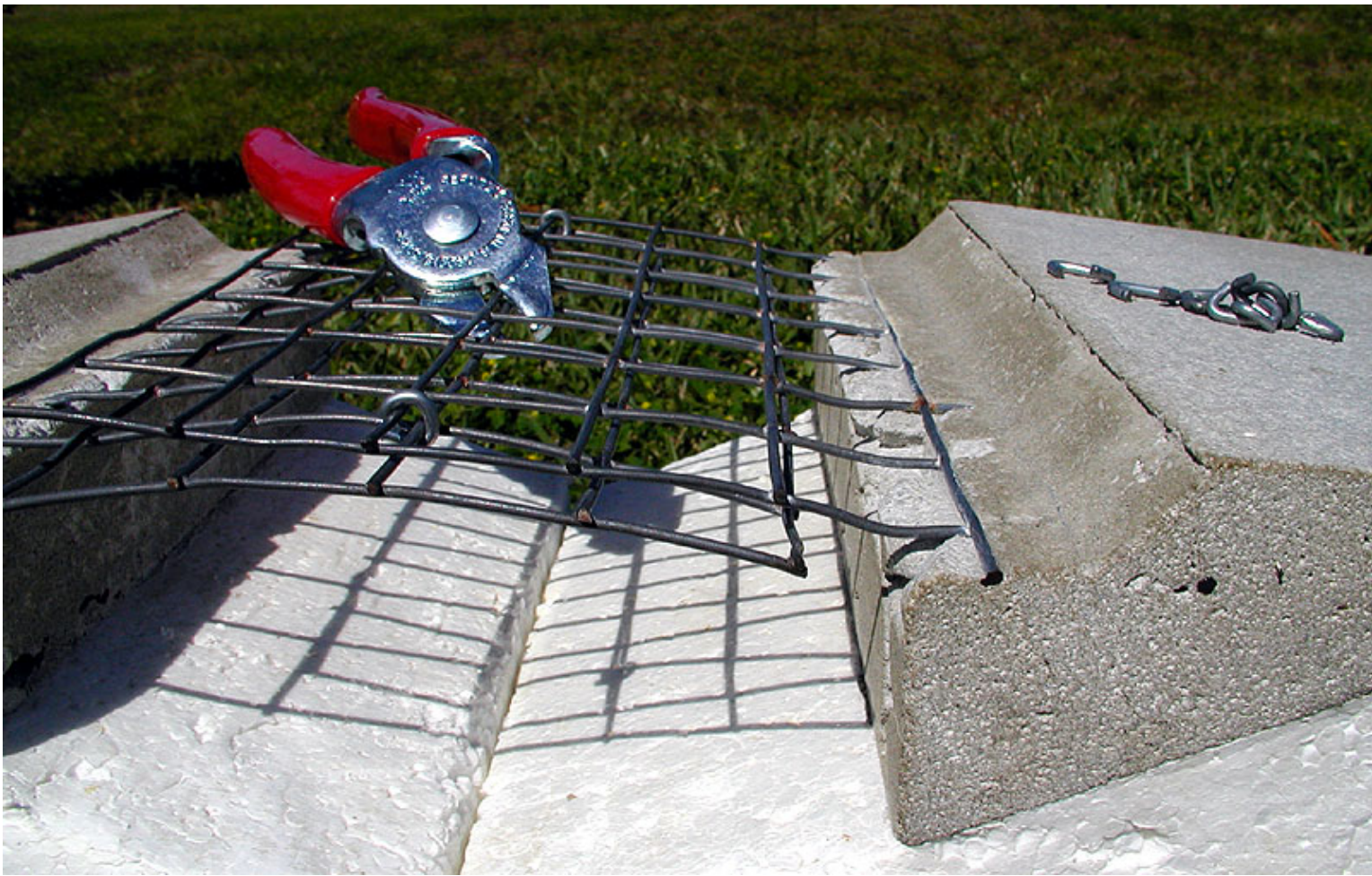





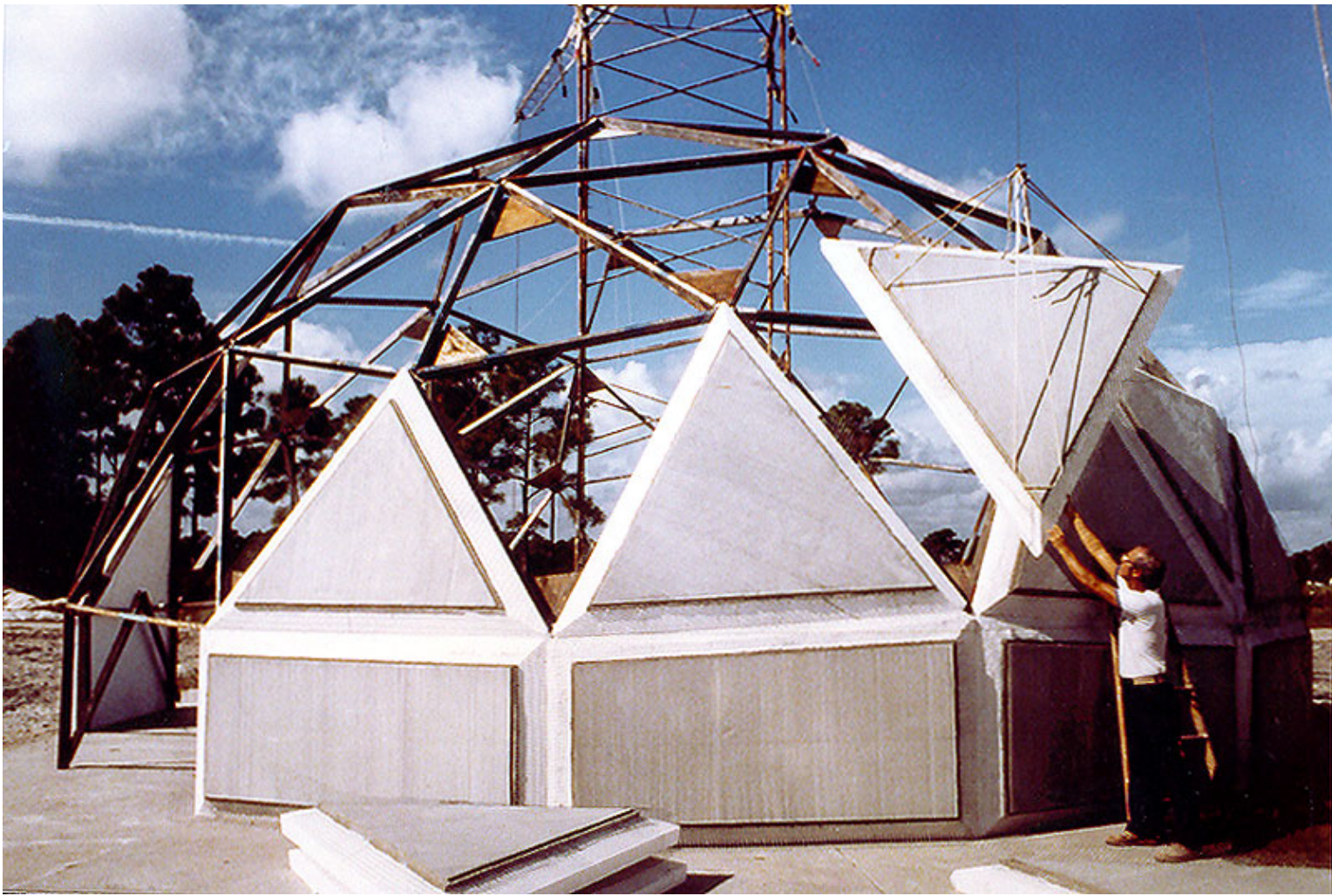

















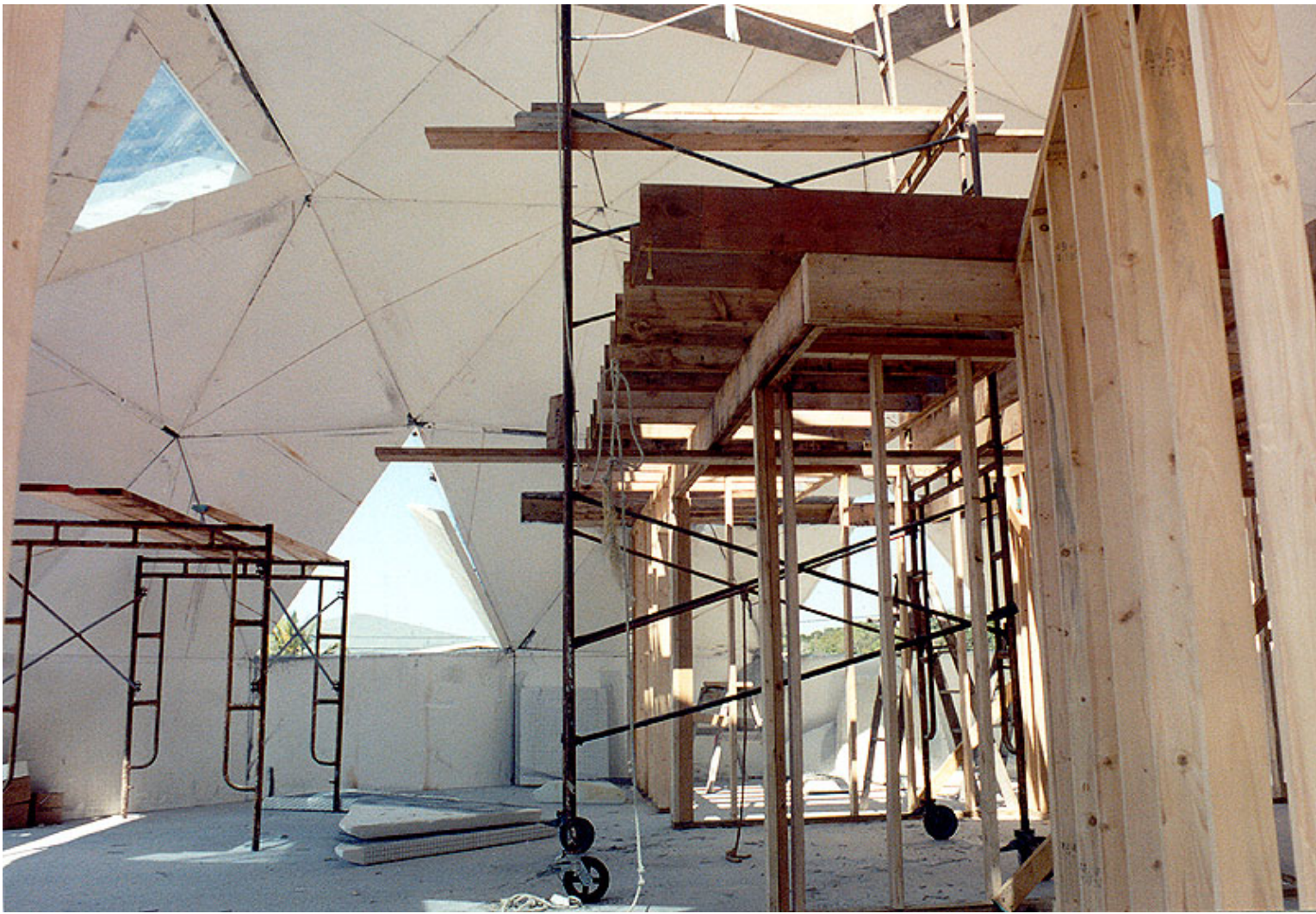



















# AMERICAN INGENUITY

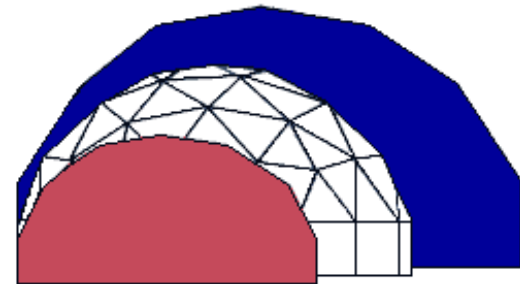

CREATING INTELLIGENT ALTERNATIVES

## Employment Opportunities at American Ingenuity

We are experiencing a rapid increase in the interest and demand for our Geodesic Dome.

Employment opportunities are open in these areas for individuals wanting a challenging position working with a company that is dedicated to energy efficient housing with excellent growth potential.

### CONSTRUCTION

There is an increasing need for trained builders to direct and assist in the erection of our domes. A contractor license or experience in construction is not required. We will teach you everything that is needed in our plant and on-site supervised project. Requires and understanding of construction concepts, mechanical aptitude, good physical condition, versatile people skills, and a willingness to do physical work outdoors in varying environments. After training you can work directly with the homeowner as an independent contractor. You will be able to quote your price and choose locations where you want to work, sometimes out of the country in Canada, Mexico, and the Caribbean Islands.

### MANUFACTURING

All positions are in Florida. You must be willing to move to Florida.

[Main](#)  
[Dome Pictures](#) | [Floor Plans](#)  
[Planning Kit / Video / Model Dome Kit](#)  
[Mail](#) | [Dome Prices](#) | [Specifications](#) | [FAQ](#) | [Maps](#)  
[Construction Cost Estimates](#)  
[Dome Home Financing](#) | [Dome Construction](#) | [Job Opportunities](#) | [Links](#)  
[The GEO POD - Utility Dome](#)

---

## AMERICAN INGENUITY, INC.

8777 Holiday Springs Road, Rockledge, Florida 32955-5805

PHONE: 321-639-8777 FAX: 321-639-8778

Established in 1976

WEB: <http://www.aidomes.com> EMAIL: [info@aidomes.com](mailto:info@aidomes.com)

© Copyright 2002 [American Ingenuity Domes](#)  
[modular geodesic dome](#)



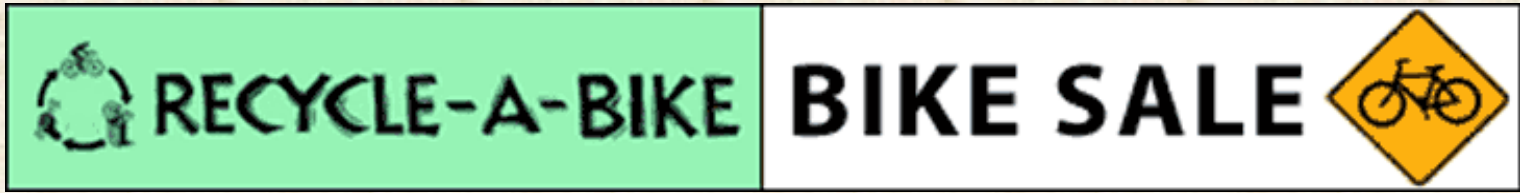

Amy C. Edmondson

A Fuller Explanation

## Contents

Chapters 1 through 8

[ [Chapters 9 through 16](#) ]

|                                                          |                       |
|----------------------------------------------------------|-----------------------|
| Series Editor Foreward .....                             | <a href="#">xv</a>    |
| Preface .....                                            | <a href="#">xix</a>   |
| Acknowledgments .....                                    | <a href="#">xxi</a>   |
| Note to Readers .....                                    | <a href="#">xxiii</a> |
| Introduction .....                                       | <a href="#">xxv</a>   |
| <b>1. Return to Modelability</b> .....                   | <a href="#">1</a>     |
| From Geometry to Geodesics: A Personal Perspective ..... | <a href="#">3</a>     |
| Operational Mathematics .....                            | <a href="#">6</a>     |
| Experimental Evidence .....                              | <a href="#">7</a>     |
| Nature's Coordinate System .....                         | <a href="#">9</a>     |
| Universe .....                                           | <a href="#">11</a>    |
| Generalized Principles .....                             | <a href="#">12</a>    |
| Return to Modelability .....                             | <a href="#">14</a>    |
| <b>2. The Irrationality of Pi</b> .....                  | <a href="#">15</a>    |
| "Nature Isn't Using Pi" .....                            | <a href="#">16</a>    |
| Finite Accounting System .....                           | <a href="#">18</a>    |



|                                                                 |                  |
|-----------------------------------------------------------------|------------------|
| Which way is "Up"?                                              | <u>19</u>        |
| .....                                                           |                  |
| Visual Literacy                                                 | <u>22</u>        |
| .....                                                           |                  |
| Peaceful Coexistence                                            | <u>23</u>        |
| .....                                                           |                  |
| <b>3. Systems and Synergy</b>                                   | <b><u>25</u></b> |
| .....                                                           |                  |
| Conceptual and Real Systems                                     | <u>28</u>        |
| .....                                                           |                  |
| Limits of Resolution as Part of the Whole-System Approach ..... | <u>30</u>        |
| Synergy                                                         | <u>33</u>        |
| .....                                                           |                  |
| <b>4. Tools of the Trade</b> .....                              | <b><u>36</u></b> |
| Plato's Discovery                                               | <u>37</u>        |
| .....                                                           |                  |
| Triangles                                                       | <u>38</u>        |
| .....                                                           |                  |
| Squares                                                         | <u>40</u>        |
| .....                                                           |                  |
| Pentagons                                                       | <u>41</u>        |
| .....                                                           |                  |
| A limited Family                                                | <u>41</u>        |
| .....                                                           |                  |
| Euler's Law                                                     | <u>43</u>        |
| .....                                                           |                  |
| Duality                                                         | <u>45</u>        |
| .....                                                           |                  |
| Truncation and Stellation                                       | <u>46</u>        |
| .....                                                           |                  |
| An Experiment                                                   | <u>48</u>        |
| .....                                                           |                  |
| "Intertransformability"                                         | <u>51</u>        |
| .....                                                           |                  |
| Symmetry                                                        | <u>52</u>        |
| .....                                                           |                  |
| <b>5. Structure and "Pattern Integrity"</b>                     | <b><u>54</u></b> |
| .....                                                           |                  |
| Pattern Integrity                                               | <u>56</u>        |
| .....                                                           |                  |
| Structure .....                                                 | <u>60</u>        |
| <b>6. Angular Topology</b>                                      | <b><u>65</u></b> |
| .....                                                           |                  |
| Frequency and Size                                              | <u>66</u>        |
| .....                                                           |                  |
| Units of Measurement                                            | <u>66</u>        |
| .....                                                           |                  |
| Time and Repetition: Frequency versus Continuum .....           | <u>67</u>        |
| Topology and Vectors                                            | <u>68</u>        |
| .....                                                           |                  |

|                                                            |                   |
|------------------------------------------------------------|-------------------|
| Vector Polyhedra .....                                     | <u>68</u>         |
| Dimension .....                                            | <u>70</u>         |
| Size .....                                                 | <u>72</u>         |
| Planes of Symmetry .....                                   | <u>73</u>         |
| Other Applications of Dimension .....                      | <u>74</u>         |
| Angular Topology .....                                     | <u>75</u>         |
| Angular Takeout: An Example .....                          | <u>78</u>         |
| Angle Types .....                                          | <u>79</u>         |
| <b>7. Vector Equilibrium</b> .....                         | <b><u>82</u></b>  |
| "Nature's Own Geometry" .....                              | <u>84</u>         |
| Spatial Considerations .....                               | <u>85</u>         |
| Planar Equilibrium .....                                   | <u>87</u>         |
| Cuboctahedron as Vector Equilibrium .....                  | <u>90</u>         |
| VE: Results .....                                          | <u>91</u>         |
| Degrees of Freedom .....                                   | <u>93</u>         |
| <b>8. Tales Told by the Spheres: Closest Packing</b> ..... | <b><u>100</u></b> |
| Equilibrium: Equalization of Distances .....               | <u>100</u>        |
| Symmetry versus Specificity of Form .....                  | <u>101</u>        |
| Organization of Identical Units .....                      | <u>101</u>        |
| New Level of Focus .....                                   | <u>102</u>        |
| Background: Closepacking .....                             | <u>102</u>        |
| Planes of Symmetry .....                                   | <u>106</u>        |
| Fuller Observations .....                                  | <u>109</u>        |
| Tetrahedra .....                                           | <u>110</u>        |
| Vector Equilibrium .....                                   | <u>114</u>        |
| Frequency .....                                            | <u>114</u>        |
| Icosahedron .....                                          | <u>117</u>        |
| Further Discoveries: Nests .....                           | <u>120</u>        |
| "Interprecessing" .....                                    | <u>121</u>        |

|                                                          |                            |
|----------------------------------------------------------|----------------------------|
| A Final Philosophical Note .....                         | <a href="#"><u>125</u></a> |
| <b>Appendices</b> .....                                  | <a href="#"><u>271</u></a> |
| A. Trigonometric Calculations .....                      | <a href="#"><u>271</u></a> |
| B. Volume Calculations for three Prime Sructural Systems | <a href="#"><u>273</u></a> |
| C. Sources of Additional Information .....               | <a href="#"><u>277</u></a> |
| D. Special Properties of the Tetrahedron .....           | <a href="#"><u>279</u></a> |
| E. Glossary .....                                        | <a href="#"><u>281</u></a> |
| <br>                                                     |                            |
| Bibliography .....                                       | <a href="#"><u>287</u></a> |
| Notes .....                                              | <a href="#"><u>289</u></a> |
| Index .....                                              | <a href="#"><u>A-H</u></a> |
| Index .....                                              | <a href="#"><u>I-R</u></a> |
| Index .....                                              | <a href="#"><u>S-T</u></a> |
| Index .....                                              | <a href="#"><u>U-Z</u></a> |



# Architects > Richard Buckminster Fuller

[Directory](#) > [Arts](#) > [Design Arts](#) > [Architecture](#) > [Architects](#) > [Masters](#) > **Fuller, Richard Buckminster (1895-1983)**

Search

the Web just this category

[Advanced Search](#) | [Suggest a Site](#)



[email this category to a friend](#)

## CATEGORIES

---

- [Fullerenes@](#)
- [Synergetics@](#)

## SITE LISTINGS

---

- [Buckminster Fuller Institute, The](#) - committed to a successful and sustainable future for all of humanity.
- [Bucky Collection](#) - a short page about the planet's friendly genius.
- [Fuller, R. Buckminster](#) - includes list of books written by and about Fuller.
- [R. Buckminster Fuller's Dymaxion House](#) - online companion to the 2001 exhibit at the Henry Ford Museum of the restored prototype of Fuller's round aluminum house.
- [R. Buckminster Fuller: Thinking Out Loud](#) - PBS Special on the architect's work, inventions, interviews, and other resources.
- [FAQ - R. Buckminster Fuller](#)

## SPONSOR RESULTS

[Buckminster Fuller on eBay](#)

Find buckminster fuller items at low prices. With over 5 million ...  
www.ebay.com

[Buckminster Fuller: Compare Prices](#)

Compare prices from over 30,000 stores. At BizRate.com, find deals, ...  
www.bizrate.com

[Buckminster Fuller - \\$10.89](#)

Make Overstock.com your one-stop-shop for all your media needs. Find ...  
www.overstock.com

SPONSOR RESULTS ([What's this?](#)) ([Become a Sponsor](#))

---

- [Buckminster Fuller on eBay](#) - Find buckminster fuller items at low prices. With over 5 million items for sale every day, you'll find all kinds of unique things on eBay - the World's Online Marketplace.  
www.ebay.com
- [Buckminster Fuller: Compare Prices](#) - Compare prices from over 30,000 stores. At BizRate.com, find deals, consumer reviews, and store ratings to save money.  
www.bizrate.com

[Buy Buckminster Fuller Books at BN.com](#)

Buy books by Buckminster Fuller at Barnes & Noble. Get free shipping ...  
www.barnesandnoble.com

[Buckminster Fuller at Amazon.com](#)

Buy books at Amazon.com. Low prices and easy shopping. Search the ...  
www.amazon.com

[See your message here...](#)

---

Copyright © 2004 Yahoo! Inc. All rights reserved. [Privacy Policy](#) - [Terms of Service](#) - [Copyright Policy](#)



[Skip Intro](#)

This page requires the Flash plug-in. Get Flash:

[http://www.macromedia.com/shockwave/download/index.cgi?P1\\_Prod\\_Version=ShockwaveFlash](http://www.macromedia.com/shockwave/download/index.cgi?P1_Prod_Version=ShockwaveFlash)

**You are here:**

[About](#)>[Homework Help](#)>[Inventors](#)>[Famous Inventions](#)>[Invention History Databases](#)>[Inventions A to Z Listings](#)>[G Start Inventions](#)>

The Planet's Friendly Genius - Buckminster Fuller and the Geodesic Dome



SPECIAL OFFER!  
**Award Winning Hosting**

CLICK HERE

Search

[Inventors](#) **The Planet's Friendly Genius -  
Buckminster Fuller**

By [Mary Bellis](#)

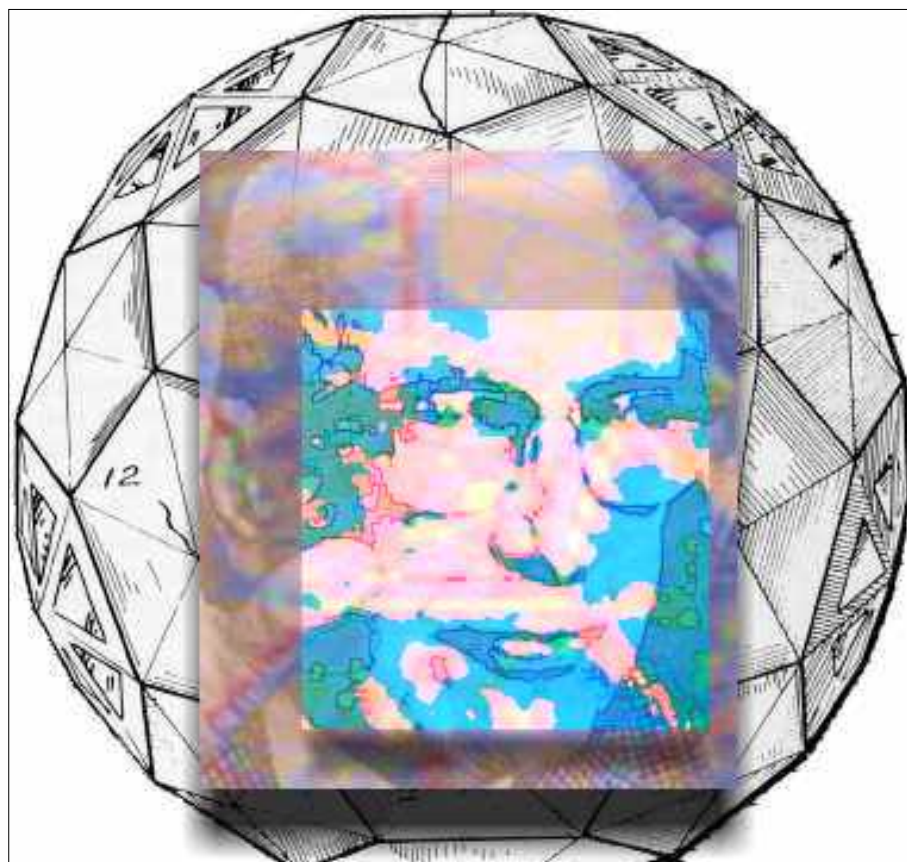

Advertisement



Richard Buckminster Fuller and His Beloved Geodesic Dome  
July 12, 1895 - July 1, 1983

Inventors are among the few people on this planet who have the ability to change life for all of us. When this ability is combined with a true love of mankind's and the planet's future, it is truly a sign of a great soul. Richard Buckminster Fuller, inventor, engineer, architect, mathematician, designer, poet, and philosopher was a great soul and visionary who believed technology could save the World from itself, providing it was properly used.

In 1927, 'Bucky' Fuller had little reason to be optimistic about the future. The year found Bucky jobless and broke with a wife and newborn daughter Alegra, to support. His first daughter Alexandra had died four years previous and Buckminster Fuller was still living in mourning. He had attempted suicide and was drinking heavily. In the darkness of that year, Buckminster Fuller went through a spiritual rebirth that changed the course of his life. He decided to dedicate his life to finding out how much difference one man could make in the world.

Renouncing personal and financial gain, Buckminster Fuller entered two years of seclusion to begin in his own words:

"the search for the principles governing the universe and help advance the evolution of humanity in accordance with them... finding ways of doing more with less to the end that all people everywhere can have more and more"

From 1927 on, Buckminster Fuller considered his life a living-experiment; he even gave himself the nickname '[Guinea Pig B](#)' to denote his new life-purpose.

Buckminster Fuller left his two-year seclusion with a new word on his lips 'Dymaxion', a contraction of the words 'dynamic', 'maximum' and 'ion' that to him represented resource-efficient and self-sustaining technologies. Under the Dymaxion ideal, Fuller developed a series of inventions from lightweight homes, streamlined cars to the geodesic dome.

[Highlights of Buckminster Fuller's Inventions and Achievements](#)  
[The Geodesic Dome](#)



[Home](#)

[Essentials](#)

[20th Century Inventions - Timelines](#)  
[History of Computers/Internet](#)  
[Find: A to Z Inventions](#)  
[Find: A to Z Inventors](#)  
[Industrial Revolution](#)

[Articles & Resources](#)

[Famous Inventions](#)  
[Famous Inventors](#)  
[Black](#)

[Inventors](#)  
[Women Inventors](#)  
[Technology](#)

[Timelines](#)  
[Patent Trademark Copyright](#)  
[Funding](#)

[Licensing](#)  
[Marketing](#)  
[Professional](#)

[Inventing](#)  
[Inventing 101 - Beginners](#)  
[Lesson Plans](#)

[Kid Inventors](#)  
[Brain Candy](#)  
[Robots](#)  
[Trivia](#)  
[Science](#)

[Clip Art](#)  
[Wacky Patents and Gadgets](#)

[Buyer's Guide](#)

[Before You Buy](#)  
[Top Picks](#)  
[History of](#)

[Television](#)  
[Before You Buy An Inventors Log](#)

[Book](#)  
[Patent It Yourself by David](#)

[Pressman](#)  
[Product Reviews](#)

[Articles](#)

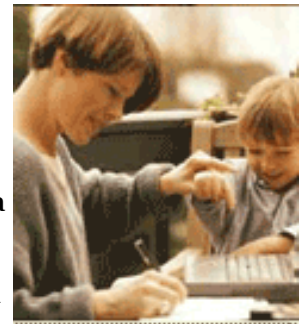

Do any of the following describe you?

- Unable to focus
- Tense or nervous
- Tired
- Angry or cranky

[Click Here](#)

Take a self-quiz to see if you suffer from depression...



[Forums](#)

[Help](#)

**FREE Newsletter**

**Sign Up Now** for the Inventors

newsletter!

- Bucky's most famous invention (patented in 1954) was the geodesic dome.
- The geodesic dome combines the sphere, the most efficient container of volume per square foot, with the tetrahedron, which provides the greatest strength for the least volume of weight.
- The geodesic dome can withstand winds of 210 mph, while at the same time it is light and easily transportable.
- Quick to build, a geodesic dome can be put up in hours.
- A geodesic dome can withstand hurricanes and earthquakes far better than conventional buildings.
- The geodesic dome is the only structure that actually gets stronger, lighter in density and cheaper per square foot with size.
- Over 200,000 of such geodesic domes have been built.
- People use geodesic domes as homes and shelter from pole to pole.
- Famous Geodesic Domes: Walt Disney [Epcot Center](#): Expo 67:

Click here for a [QuickTime movie](#) of a flying geodesic dome (2606k)



[The Birth of the Geodesic Dome: How Bucky Did It](#) by Lloyd Steven Sieden (The Futurist, Vol.23, No.6, November - December 1989) article adapted from Buckminster Fuller's Universe: An Appreciation by Lloyd Steven Sieden

[Geodesic Domes](#)

Great sites to read more about history, geometry, manufacturers, prototypes and other resources for domes.

**Most Popular**

[Famous Inventions - A - History of Inventions](#)  
[The History of Computers - Computer History Timeline](#)  
[Twentieth Century Inventions 1900 to 1999 - Inventors](#)  
[The History of Famous Inventors - A - Past and Present](#)  
[Automobile History - The History of Cars and Engines](#)

**What's Hot**

[The History of Comic Books](#)  
[The History of Roads and Asphalt](#)  
[Famous Trademarks and Inventions - September](#)  
[The History of Prosthetics](#)  
[Clatonia Joaquin Dorticus](#)

Continue with Part Two >> [Buckminster Fuller - The Planet's](#)

## [Friendly Genius](#)

### Subscribe to the Inventors Newsletter

Name

Email

all illustrations created by mary bellis



From [Mary Bellis](#),

Your Guide to [Inventors](#).

**FREE** Newsletter. [Sign Up Now!](#)

[Important disclaimer information about this About site.](#)

[Topic Index](#)

[back to top](#)



[email to a friend](#)



font size



[Our Story](#) | [Be a Guide](#) | [Advertising Info](#) | [Investor Relations](#) | [Work at About](#) | [Site Map](#) | [Icons](#) | [Help](#)

©2004 About, Inc. All rights reserved. A PRIMEDIA Company.

[User Agreement](#) | [Privacy Policy](#) | [Kids' Privacy Policy](#)

### Featured Channels

[Automotive](#)[Computing & Technology](#)[Health & Fitness](#)[Jobs & Careers](#)[Parenting & Family](#)[Money](#)

### Most Popular

[Famous Inventions - A - History of Inventions](#)[The History of Computers - Computer History Timeline](#)[Twentieth Century Inventions 1900 to 1999 - Inventors](#)[The History of Famous Inventors - A - Past and Present](#)[Automobile History - The History of Cars and Engines](#)

### What's Hot

[The History of Comic Books](#)[The History of Roads and Asphalt](#)[Famous Trademarks and Inventions - September](#)[The History of Prosthetics](#)[Clatonia](#)

[Joaquin Dorticus](#)

# SYNERGETICS

Explorations in the Geometry of Thinking

by

**R. Buckminster Fuller**

in collaboration with E. J. Applewhite

First Published by Macmillan Publishing Co. Inc. 1975, 1979.



---

[Sources of Further Information](#)

# Engines of Creation

## *The Coming Era of Nanotechnology*

---

by [K. Eric Drexler](#)

*Engines of Creation* was originally published in hardcover by Anchor Books in 1986, and in paperback in 1987. WWW version reprinted and adapted by [Russell Whitaker](#), with permission of the copyright holder.

ISBN 0-385-19973-2

---

**NOTE:** 18 April 2002: Thanks to work done by David Littleton, the complete text of *Engines of Creation* can be [downloaded as a PDF file](#) (1.2 Mb). Requires [ACROBAT READER](#) by ADOBE.

---

**NOTE:** 25 March 2000: Thanks to work done by Graham Reed, the complete text of *Engines of Creation* can be [downloaded in PDB format](#) (660 Kb), a standard document file for Palm Pilot.

---

**NOTE:** 25 March 2000: Thanks to work done by Marc Macé, *Engines of Creation* has been translated into French and is available as [plain text](#) (780 Kb), or it can be [downloaded in rich text format](#) (1.1 Mb).

---

**NOTE:** as of 20 May 1996, a [mirror of this book has been set up in Poland](#) by [Miloslaw Smyk](#). - *Russell*

---

# Table of Contents

## INTRODUCTION TO THE WEB VERSION

FOREWORD - by *Marvin Minsky*

## ACKNOWLEDGMENTS

### **PART ONE - THE FOUNDATIONS OF FORESIGHT**

- 1 - [Engines of Construction](#)
- 2 - [The Principles of Change](#)
- 3 - [Predicting and Projecting](#)

### **PART TWO - PROFILES OF THE POSSIBLE**

- 4 - [Engines of Abundance](#)
- 5 - [Thinking Machines](#)
- 6 - [The World Beyond Earth](#)
- 7 - [Engines of Healing](#)
- 8 - [Long Life in an Open World](#)
- 9 - [A Door to the Future](#)
- 10 - [The Limits to Growth](#)

### **PART THREE - DANGERS AND HOPES**

- 11 - [Engines of Destruction](#)
- 12 - [Strategies and Survival](#)
- 13 - [Finding the Facts](#)
- 14 - [The Network of Knowledge](#)
- 15 - [Worlds Enough, and Time](#)

## AFTERWORD

## GLOSSARY

## NOTES AND REFERENCES

© Copyright 1986, K. Eric Drexler. All rights reserved.  
Published for the WWW by [Russell Whitaker](#).

---

**To support  
Foresight:**



**Hello**  
Please support the Foresight Institute.  
**amazon honor system** [Learn more.](#)



---

[Sources of Further Information](#)

---

[Home](#) | [New on this Website](#) | [Site Map](#) | [Search](#)

[About Foresight](#) | [Nanotechnology](#) | [Web Enhancement](#) | [News](#) | [Events](#) | [Publications](#) | [Prizes & Awards](#)

**GETTING INVOLVED** : [Free Electronic Membership](#) | [Regular Membership](#) | [Become a Senior Associate](#)



Use [CritSuite](#) to comment on this page and to see others' comments.

---

Foresight materials on the Web are ©1986-2002 Foresight Institute. All rights reserved.













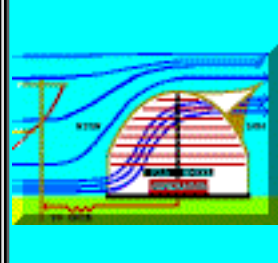

Last updated 18 April 2002. The URL of this document is: <http://www.foresight.org/EOC/index.html>

Send requests for information about Foresight Institute activities and membership to [foresight@foresight.org](mailto:foresight@foresight.org).

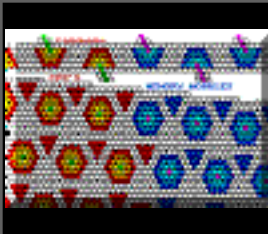
Send comments and questions about material on this web site and reports of errors to [webmaster@foresight.org](mailto:webmaster@foresight.org).

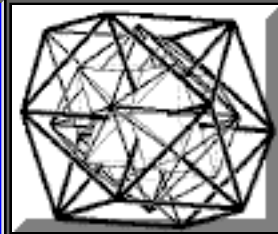
# BUCKMINSTER FULLER VIRTUAL INSTITUTE

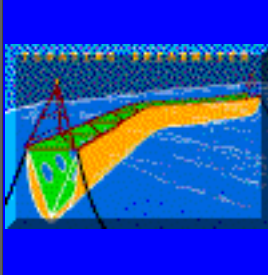
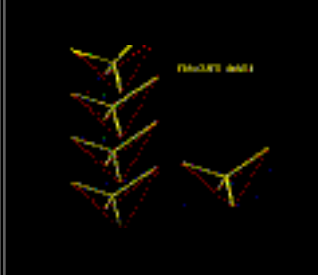
DO.....MORE.....WITH.....LESS

|                                                                                     |                                                                                     |                                                                                                                                                                    |                                                                                       |
|-------------------------------------------------------------------------------------|-------------------------------------------------------------------------------------|--------------------------------------------------------------------------------------------------------------------------------------------------------------------|---------------------------------------------------------------------------------------|
|    |    |                                                                                  |    |
|    |    | <a href="#">GRAND STRATEGY</a><br><a href="#">SELECTED IDEAS</a><br><a href="#">BIBLIOGRAPHY</a><br><a href="#">MASTER INDEX</a><br><a href="#">GLOSSARY; PICS</a> |    |
|   |   |                                                                                 |   |
|  |  |                                                                                |  |

|                            |                                     |                                                                      |
|----------------------------|-------------------------------------|----------------------------------------------------------------------|
| <a href="#">SITE MAP</a>   | <a href="#">SEARCH THIS SITE!</a>   | <a href="mailto:buckminster.info">buckminster.info</a>               |
| <a href="#">WHAT'S NEW</a> | powered by <a href="#">FreeFind</a> | Maintained by Joe S. Moore                                           |
| <a href="#">FAQ</a>        |                                     | <a href="mailto:joe_s_moore@hotmail.com">joe_s_moore@hotmail.com</a> |

Tuesday, November 25, 2003

Buckminster Fuller geodesic dome synergetics tensegrity tetrahedron octahedron icosahedron dymaxion energy food transportation housing computer city

Visitors since April, 1998: [an error occurred while processing this directive]





# Worldflower Garden Domes™

## Geodesic Dome Constructions

[CLICK TO ENTER](#)



© Copyright 1997-2004 Worldflower Garden Domes



ARTWORK in Motion

7

## Design and Fabrication Specializing in Animated Models and Props



### Why Animated Ideas?

Animation is that which gives life to a static object.  
Sometimes that life can be a simple movement or  
Even the mere suggestion of movement.

**Nothing captures the attention of the human eye more than the  
Illusion of life.**

**Whether you need a concept designed or a custom item built  
to your own specifications, Animated Ideas can offer you a solution.**

**From Movie Props to Museum Artwork  
Advertising to Exhibitions  
Side shows or Store Displays  
Theme park and Theatre props  
Model buildings or Private artwork**

**With over 17 years of experience in the Industry, covering both the  
artistic and technical aspects of design and fabrication  
You can be assured a high quality product,**

**For more information, explore this website or contact**

**[Animated Ideas](#)**

**For callers in the United States, tel: 407-349-2820**

This website represents a portfolio of work completed whole or in part by [the artist, Luke Sawh](#)

and/or his business Animated Ideas.

Where applicable, any other companies or individuals involved  
shall be credited accordingly for work that was carried out under contract.

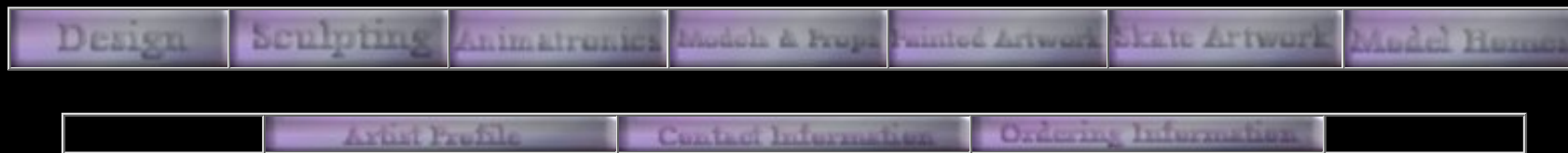

Copyright © 2003 Animated Ideas. All rights reserved.

Email: [info@animatedideas.net](mailto:info@animatedideas.net)



Join our Design Improvement Movement.....Actively participate in the design and construction plans for your dream house...Good, healthy humor...Great gobs of information...Priceless insights into the world of architectural design and wood frame building construction...Design and construction stuff and thingies you won't find anywhere else on the Web...People search and travel, looking for what you've found. Stick to Google and Yahoo.com. Learn about design health, construction health. No games. No jokes. No autos. No hotels. No news. No weather. No recipes. We do have info on mortgages, a dictionary, and song lyrics.....We have pictures, too.... You can use PayPal (owned by Ebay)....We are home designers, light commercial designers, light industrial designers.....We do custom home designs,homeplanning, residential design, commercial designs, industrial designs, blue prints, home building plan designs, home floor plans, designers house floor plans, house plan blue prints, new homes, remodeling, house remodeling, home remodeling.....We provide homebuilding information, selected house plans sites, free homeplanning information, free home planning information, houseplans, contractors construction homebuilding information, building lots.....We can consult with you and design and draft sample plans, bid plans, southern architectural house plans, home plans, homeplans, floor plans, floorplans, home design, architecture blueprints, houses, house floor plans, dream home plan, accessible living plans, small house plans, luxury floor plans, home styles, victorian, ranch, contemporary, colonial, craftsman, country, cottage, a frame, duplex farm house, vacation , designers, cottages, architecture, design, construction, architectural, colonial, craftsman, country, houseplan blueprints, ranch style, cabins, cottages, victorian, colonial, contemporary, large home plans, cabin house plans, contemporary house plans, cottage blueprints, cottage house plans, dream home, duplex home plans, floor plans, garage floorplans.....We do not offer stock house plans, stock plans, stock houseplans..... We are not architects or engineers.

# Before The Architect



powered by [FreeFind](#)

**Residential architecture has two parents: construction and design. House construction serves. House design satisfies.** [AG 2004](#)

**Best of Web: house plan information.** See [Site Map 1](#) and [Site Map 2](#). CONTENT-RICH ... 200+ text pages; 550+ pics; 6925 links

**Best-Seller publication - "[House Construction Design Standards](#)" - A MUST for contractors, designers, & do-it-yourselfers ready to tackle a new house or major addition.**



I. Before The Architect consults on house plans, designs houseplans, and drafts house plans.

II. Before The Architect - reviews houseplan designs, offers 2nd opinions on house plans, modifies stock houseplans, develops dream house plans - new construction and major remodels. 70+ years of builder & designer experience. [Learn how to get the house plans and new construction you deserve.](#) [Find out our fees and services.](#)

III. Before The Architect overbuilds by today's low standards of house plan design and residential construction, focusing a) safety, b) convenience, c) durability.

IV. Before The Architect operates nationwide.

**Feedback:**

-  a client, after first meeting with a 40-year custom builder: "... He said it's the best set of plans he's ever seen . . ."
-  a client, about the house built with our plans: "...We love it. We love it every day. ....The two best things about working with you were that you made us understand that taking time to think things through was good, really good.... You were absolutely right.... There were no bad things at all. The other best thing was your detail in drawings and specs...took the wiggle-room right out from underneath the builder and his subs. . ."

 a mechanical engineer and custom builder in Florida who reviewed "[House Construction Design Standards](#)": "I love your work, Quality by Planning."

[Residential DESIGN & CONSTRUCTION TIPS & TRICKS](#) for a better home . [Concept Drawings](#) . [Model Drawings](#) . [Builder Drawings](#) . [Great information](#) . [ACTUAL PLANS](#) . [Protect your remodeling investment](#) . [Excellent tutorials](#) . [Practiced opinions](#) . [Build Without Fear](#) . [One-of-a-kind insights](#) . [Good fun](#) . [Design Curved Stairs, in .pdf or in hard copy](#) . [A House Roof Plan w/ 30+ segments](#) . [French Country style 34-sheet plan set](#)

[Design Standards](#) . [Bid Plan](#) . [Framing Plan](#) . [Electrical Plan](#) . [Plumbing Isometrics](#) . [Site Map1&2](#) . [Craftsman Tutorial](#) . [Foundation Plan](#) . [Famous Quotes](#) . [HOUSE PLANS](#) . [E-Publication](#) . [French Country Style Article](#) . [Craftsman Style Article](#) . [19 Deadly Sins Roof](#) . [Design Tips & Tricks](#) . [REAL PLAN SHEETS](#) . [Discount Dan The House Plans Man - Public Service Notice](#) . [17-Sheet Major Addition](#) . [Commercial Interior Design](#) . [Testimonials](#)

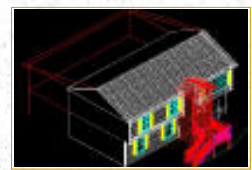
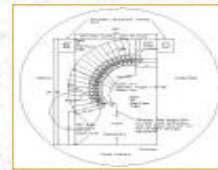
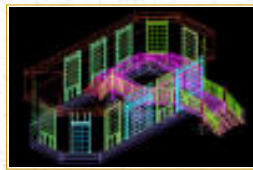
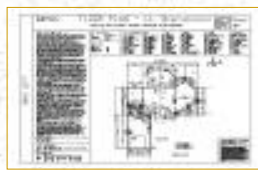
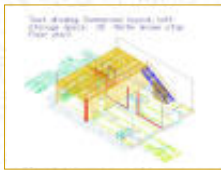

[jrp2h2000@yahoo.com](mailto:jrp2h2000@yahoo.com) Ê 770-889-6964 Ê 2985 Heatherwyn Way, Cumming, GA 30040

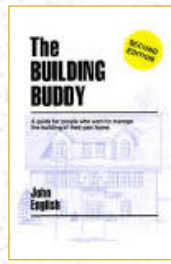

**Advisors:** **KERRY ROGAN, Master Roofer, Cornerstone Roofing, 770-844-9800, North GA, [kerryrogan@aol.com](mailto:kerryrogan@aol.com);** Computer Technology, **TRENT CHAU, Computer Technology Consultant, [trentchau@fractalcanvas.net](mailto:trentchau@fractalcanvas.net)**

.....

[ [Directions](#) ] [ [Design & Drawings](#) ] [ [Mrs. AG's Designs](#) ] [ [Background](#) ] [ [Shopping Lists](#) ]



# House plans, floor plans and home plans to suit your every need

Architectural Designs ...selling quality house plans for over 30 years

Questions? 800-854-7852

[Home](#)

[About Us](#)

[Services](#)

[Plans Include](#)

[Contact Us](#)

[Help](#)

[Affiliates](#)

[Builders](#)

[Links](#)

[Search](#)

[Search Results](#)

[How to Modify](#)

[How to Order](#)

[Cost Estimates](#)

[Testimonials](#)

## QuikSearch Our 5910 House Plans

Find House Plan Number:



Search:

Total Living Area (sq. ft.)

to

Sort by:

Number of Floors:

House Style:

Bedrooms:

Baths:

Foundation:

Special Features:

Maximum Dimensions:  
Width (feet)

Depth (feet)

### Our Editors' Weekly Picks



This week's [favorite home plans](#), selected by the editors of **Architectural Designs** magazine.

## Our Most Popular Home Plans

[Small House Plans \(up to 1500 sq. ft.\)](#)  
[Affordable House Plans \(1500-2500 sq. ft.\)](#)  
[Luxury Home Plans \(2500+ sq. ft.\)](#)  
[100 Most Popular House Plans](#)

## Our Newest Home Plans



Select from our  
288 newest plans

## Featured Home Plan Styles

[Beach House Plans](#)  
[Cape Cod House Plans](#)  
[Carriage House Plans](#)  
[Colonial House Plans](#)  
[Contemporary House Plans](#)  
[Cottage House Plans](#)  
[Country House Plans](#)  
[Craftsman Home Plans](#)  
[European House Plans](#)  
[Farmhouse Plans](#)  
[Florida House Plans](#)  
[Garage Plans](#)  
[Log Home Plans](#)  
[Mediterranean House Plans](#)  
[Multi-Family House Plans](#)  
[Narrow Lot House Plans](#)  
[Northwest House Plans](#)  
[Ranch House Plans](#)  
[Sloping Lot House Plans](#)  
[Southern Living House Plans](#)  
[Traditional House Plans](#)  
[Vacation Home Plans](#)  
[Victorian House Plans](#)  
[House Plan Style Information](#)

### Today's Featured Design



© Copyright

[Plan W3372SR](#)

House plans and home plans are in our blood. The second generation has joined this family-run house plan business to help you find your dream house plan. Look through house plans from dozens of U.S. and Canadian home designers. Whether you are looking for a quick building estimate, a free home design modification estimate, or eight sets of a country house plan to fulfill your needs, you have come to the right place!

### Featured Services

**FREE!** Regular Shipping on All House Plans,  
U.S. & Canada

### Free House Plan Modification Estimates:

Get a free home plan modification estimate in two business days. Add square footage to the house plan, redesign a bathroom or the kitchen, make the garage bigger or request another house plan modification you desire. [Find out how!](#)

### Builder Discount:

Plan on buying multiple floor plans in the coming year? If so, you qualify for a discount on our home plans. [Read more](#) on how to save on your floor plans purchase today

### Exclusive Offers



### QuikQuote:

Our exclusive cost estimating service is only \$29.95 for a 24-hour response. [Learn more](#) about this service.

### Personalized Construction Cost Estimate

A 100-page customized report detailing labor and material costs to build any plan we offer. [Find out more](#) about this exclusive service.

### Virtual Tour

Take a [Virtual Tour](#) of house plan [W5994ND](#). Double columns resting on stone bases adorn the front porch of this country house plan. View it from all angles and walk-through this popular home design.



**Subscribe**

to our quarterly magazine or buy it at leading newsstands including Barnes & Noble and Borders.

All house plans are Copyright ©2004 by the architects and designers represented on our web site



[Home](#) | [Contact Us](#) | [Copyright](#) | [Privacy Policy](#) | [House Plans](#) | [Site Map](#)

Architectural Designs :: 57 Danbury Road :: Wilton, CT 06897  
USA & Canada 1-800-854-7852 or 1-877-229-2447 :: International 262-521-4596  
Fax 1-203-761-8600 :: Email: [info@architecturaldesigns.com](mailto:info@architecturaldesigns.com)



[Home Plans](#)  
[House Plans](#)

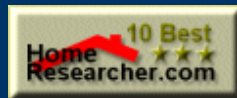

[HomePopular](#) [house plan](#) [home plan](#) [floor plan](#)

[HomeSalez.com](#)

[House plans - home plans by Allplans.com](#)  
[House Plans at PlanHouse](#)



ecoIQ.com

# Green Design & Building



## EcoIQ.com On Green Design & Building

The *EcoIQ.com Green Design & Building* website is for everyone interested in making smart choices about how we build our structures and infrastructure -- choices that are both **economically** and **ecologically intelligent**.

## Online Publications About Green Design & Building

**EcoIQ Magazine** is an online journal focusing significant attention on the efforts around the nation and around the world to design and build our structures and infrastructure to be more sustainable.

Individuals and organizations may submit news briefs, resource listings, reviews, and feature or opinion articles. Articles dealing with [Green Design & Building](#) and related issues are available [here](#). The complete EcoIQ Magazine, as well as links to all archived articles, are available [here](#).



**The EcoGateway** includes The Link Center, The EcoIQ Directories, Anthologies, and Calendars. Altogether, the EcoGateway includes more than 10,000 links.

Individuals and organizations may submit home page links, directory resources, online articles, and calendar events. The EcoGateway sections and pages related to green design and building may be accessed [here](#). More details and links to EcoIQ online green design and building publications are available [here](#).



[EcoSpeakers.com](#)



[EcoFootage.com](#)



## Speakers & Writers Focusing On Green Design & Building

EcoIQ works to expand the audience for the valuable ideas and good work of speakers, authors, journalists,



## [Video Documentaries](#)



## [Online Images](#)



## [Syndicated Features](#)



## [EcoTalk.com](#)



## [EcoTapes.com](#)



## [EcoOutlet Books](#)



## [EcoIntelligence.com](#)

and researchers who focus on green design and building. Our [EcoSpeakers.com](#) promotes speakers on [green design and building](#) and related issues for conferences and for community, business, and university speaker series. Our online store, [The EcoOutlet](#), provides green design and building related [books](#), [articles and reports](#), and [published speeches](#) to serve the educational, training, and professional development needs of individuals, schools, teachers, libraries, and other organizations. Our books cover ecological design principles, building a natural and healthy home, certification of forest products, straw bale building, remodeling for energy efficiency, and more.



[EcoIQ Syndicated Features](#) distributes feature and opinion articles for web sites, newsletters, magazines, and community and environmental media. [EcoTalk.com](#) and [EcoTapes.com](#) distribute [videotaped talks](#) and [audiotaped talks](#) respectively for use in classes, training programs, and meetings.

# Video & Television On Green Design & Building

[EcoFootage.com](#) provides inexpensive royalty-free video stock footage in collections. Green design and building related scenes of clean energy and of the recycling and reuse of construction and demolition debris are included. The digital revolution has made communication and marketing using video media (VHS, CDs, DVDs, and MPEGs online) much more affordable, and our [EcoFootage.com](#) service connects videographers with video producers and connects both with the advocates, nonprofits, service providers, and product producers who can now afford to employ video media. [The EcoOutlet](#) provides green design and building related [video documentaries](#) and [videotaped talks](#) to serve the educational, training, and professional development needs of individuals, schools, teachers, libraries, and other organizations. Documentary topics include using solar energy and recycled materials in new buildings, green design of large buildings, rammed earth construction, and protecting forests.



[EcoIQTV.com](#) and [EcoIntelligence.com](#) produce and distribute video shorts, talks, and interviews at low or no cost to educational channels, public access cable, college and university channels, PBS stations, web sites, and others.

# Online & Print Images Of Green Design & Building



[EcoIQTV.com](http://EcoIQTV.com)



[EcoIQ Magazine](#)



[The EcoGateway](#)



[EcoPhotos.com](http://EcoPhotos.com) and [EcoIQ Online Images](http://EcoIQ Online Images) provide photos for online and print applications (as well as for power point, multi-media CD or video productions). Images cover both the natural world and human communities, and they illustrate both threats to our sustainability as well as solutions. They include shots of the recycling and reuse of construction and demolition debris as well as of conventional wood frame construction. Images are delivered immediately upon purchase via an online link, and are available individually from [EcoPhotos.com](http://EcoPhotos.com) and in small collections from [EcoIQ Online Images](http://EcoIQ Online Images). Alternatively, [EcoCDs.com](http://EcoCDs.com) provides images on CDs (collections are bundled into broad groupings by subject matter and priced at a discount). [EcoSlides.com](http://EcoSlides.com) provides reproduction grade duplicates of original photographic slides for a variety of educational and commercial uses.



## Other EcoIQ.com Topic-Focused Sites

In addition to this Green Design & Building topic site, EcoIQ.com also provides the other topic-focused sites shown below. These topics are connected in the fabric of the real world ... everything is indeed connected to everything else. Actions which help in one topic area usually have impacts, often positive but sometimes negative, in several other topic areas.

[Sustainability](#) | [Land Use](#) | [Air & Atmosphere](#)  
[Water & Wastewater](#) | [Energy](#) | [Transportation & Communication](#)  
[Solid Waste & Recycling](#) | [Toxic & Hazardous Materials](#)  
[Pollution Prevention](#) | [Urban Greening](#)  
[Conserving the Built Environment](#)

## Be Part of EcoIQ.com: It's Your Choice

You and/or your organization could be part of EcoIQ.com. As described above, information about your website, your projects, your events, and your ideas can be submitted to EcoIQ Magazine and The EcoGateway. If you are a producer of educational resources or a speaker, there are places for you throughout the Eco Family of sites. Find out more details about [your options here](#). Additionally, if you or your business or organization would like to consider advertising in EcoIQ Magazine or The EcoGateway, you can find out how [here](#). EcoIQ.com always appreciates links to its sites.

[Your Options To Be Part Of EcoIQ.com](#)  
[Advertise On EcoIQ.com](#)



[Green Design & Building Home](#)  
[Magazine On Green Design & Building](#)  
[Directories For Green Design & Building](#)

[Home](#) | [EcoIQ Magazine](#) | [EcoGateway](#) | [EcoOutlet](#)  
[Speakers & Writers](#) | [Video & TV](#) | [Images, CDs & Slides](#)  
[Education & Training](#) | [About EcoIQ.com](#) | [Navigating EcoIQ.com](#)  
[Cont@ct Us](#)



[Contact Us](#)

© Copyright 1998-2004 EcoIQ

[Site Credits](#)

# House and home building cost guide

Building a new house or home? Want to save thousands of dollars in cost? Look no further. Our new residential building home guide contains dozens of useful convenience and money savings tips.

The house and home building guide also contains important healthy house building tips  
[new house or home building cost guide](#) [new house or home construction tips](#)

## “Save Thousands ‘WITHOUT’ Being the GC!”

4620 Derby Lane w Doylestown, PA 18901 w 215/604-3654 w [Order](#) w [Newsletter](#) w [Affiliates](#) w [Links](#)

www

Subscribe to our monthly newsletter.

-  
Timely, money saving building tips

|  |
|--|
|  |
|  |
|  |
|  |



## The New Home Building Guide

www

**For a Limited Time**

**Free House Plan (\$500 value) With every purchase!**

[Click For Details](#)

**This special offer is guaranteed for more days**

- ◆ Will show you how to **save thousands** when building your new home **without** being the general contractor.
- ◆ Contains dozens of **money saving** and **convenience tips**. These trinkets of gold will make your life easier for years to come.
- ◆ Contains important healthy house building tips that will **help you build a healthier house**. **This is especially important information** for those with **allergies** or other **chronic illnesses**.
- ◆ Comes with a **straight forward** guarantee, either you are satisfied or you get your **money back**.
- ◆ Arms you with **information** and **tools** that will help you **avoid the house building horrors** and **give you peace of mind**.
- ◆ Can be **ordered online** and downloaded **immediately**. No waiting around for your order to arrive. **Get started now**.

www

### Dear Home Building Consumer,

The House-N-Home Building Guide has been almost a decade in the making. Back in the early 1990's my wife and I were living in an old Victorian home built in 1888. It was loaded with charm, but short on modern amenities. One day she was taking her winter coats out of a closet where they had been stored over the summer. She discovered, much to her surprise, that the linings of these coats were covered with mold. Within two days she had moved out; she is extremely allergic to molds and was having some health problems at the time. She moved in with her parents and I was left to sell the house, which I was fortunately able to do in a few weeks.

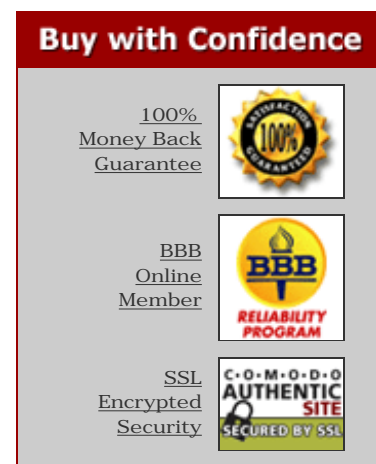

We began looking for a house to buy. After some amount of looking and discussion we agreed that we would instead, build a house. Unwittingly, the saga that would lead to the publication of this guide had begun. We went through all of the normal steps of buying land, designing the house, selecting a builder, securing financing, overseeing the building process, and finally 17 months later, after taking our builder to small claims court, we moved in.

Thankfully we did a lot of things correctly. But, unfortunately there were many things we should have done differently. As soon as we had finished the process I wrote about 9 pages of notes for myself to use when we built our second house. About this time a baby came into our lives and my notes went into a file and stayed there for more than six years.

"Your building guide is the BEST! In the past I have purchased a few books on how to build or how to be your own GC" but nothing has compared to your product....!"

**Rose Reiner  
Minot AFB ND**

[More Testimonials](#)

The Internet had blossomed during those six years and I recognized the potential value of the education I had received in the "school of hard knocks". At the same time I was somewhat uncomfortable with presenting myself as an expert in the area of house building. I decided to see what information was available. I went first to the Internet and bought almost every new house building guide I could find and read them. I was quite surprised at what I found. The information fell into two basic groups. One group provided only a general overview of the home building process, with a few checklists and timetables, but overall was really pretty useless. The second group attempted to teach consumers how to be the GC and save money by taking on the role of a builder. Next I went to Amazon.com and bought several books on building a new home. Once again I found that many of these were written by builders. And once again I found that, while there was some good information in these, none of them contained what I considered to be the most critical information, i.e. **how to save thousands of dollars when building a new home without being the GC.** In my mind this was the most most critical detail and **no one** was writing from that perspective.

Having finally convinced myself that the information I had compiled was important, generally unavailable elsewhere, and could save the homeowner a bundle, I made the decision to write the House-N-Home Building Guide.

### Saving Real Money

The House and Home Building Guide will show you how to save thousands of dollars on your building project. If you are building an average sized house in the U.S. (~\$150,000) you should be able to save \$5000-\$10,000 or about 5-10% of the construction costs of your home. **The best part is that you can realize these types of savings without being the General Contractor (GC) on your house building project.** This is an extremely important point because being the GC on a house is almost a full time job - and few people today have that amount of free time. Furthermore, even if you were one of the lucky few who had the time, without the practical experience, you would have a very difficult time managing the process. For most people the bottom line is that a builder, whom you hire, will be responsible for all of the nitty gritty details of getting the house built - not you. He is your house building expert and you should use him for his expertise.

This House and Home Building Guide walks you through, step-by-step, and shows you exactly what you need to do to save money. But it goes well beyond that, by incorporating the logistics of how you save this money into an example set of **specifications** and an example **contract**. What you get then, is not just a single document -**but 8 documents, a complete house building kit:**

- **The House Building Guide**
- **Sample Building Contract**
- **Example Specification**
- **Complete House Plans**
- **Builders Questionnaire and Interview Guide**
- **Lot/Land Purchase Checklist**
- **Comprehensive punchlist**
- **Healthy House Building Tips**

These documents are available in a Word (.doc) format to enable you to use the specifications and contract as templates and modify them for your use. They are also available as pdf files.

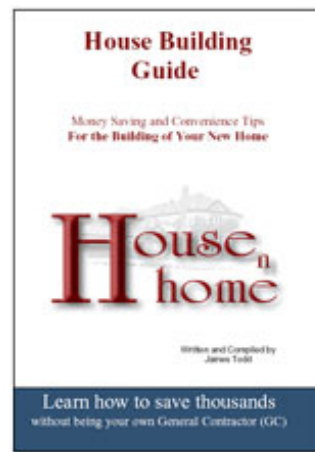

By putting into practice the tips in the House and Home Building Guide you should easily save **50 fold** the purchase price. In fact if you followed through on just one of the money savings tips contained in the Guide, you would pay for its cost many times over. This analysis doesn't even take into consideration the value of the many convenience tips. What else could you ask for? Here is a quick look at just a few of the other things contained in the Guide.

[View the Table of Contents](#)

---

### **Insider Secrets – What Builders Don't Want You To Know**

Here are eight things your builder would prefer you didn't know. Once you read the Guide you will understand why:

- a Why builders **love** change orders and why it is so critical that you have as few of these as possible.
- a Why all warranties are not alike and **what kind of warranty you must avoid**.
- a Why homeowners have the leverage in the building process.
- a How to achieve **“apples to apples” comparability** when requesting bids from builders.
- a Two things you can do yourself and save money.
- a Five things you can delay or postpone if you are running short on money.
- a Why your specifications must be as detailed as possible.
- a Twelve (12) major items on which you can easily avoid a builder's markup.

---

### **What Home Owners Must Know About Builders**

The vast majority of people can't do it all themselves. A good builder is indispensable. This Guide can help you find one and show you:

- a Why you need a good builder.
- a Why 98% of people **shouldn't be their own GC**.
- a How to choose a builder.
- a What questions to ask when interviewing a builder.
- a How to audit a prospective builder's construction site.

---

### **Learn From My Mistakes, Don't Repeat Them**

The House and Home Building Guide is packed with dozens of money saving and convenience tips and practical advice. Get educated before jumping into the building process or your ignorance could cost you big bucks. Here is some additional information you will find in the Guide:

- a The best and easiest way to develop your floor plan.
- a Twenty-nine convenience tips that could save you **thousands of dollars and hundreds of hours** over a lifetime.
- a Why the right credit card is important and how it could save you hundreds of dollars.
- a How a call to your local electrical utility might pay for the cost of this Guide 5-10 times over.
- a Which clauses are important in a house building contract.
- a An **easy way to enforce your contract** if the builder doesn't live up to his end of the bargain.
- a How to assemble your punch list.
- a Thirty (30) important questions to examine when buying land.
- a How to easily check if land is near an environmentally contaminated site.
- a Why a **credit check on both yourself and your prospective builder** is important.

---

### Healthy House Building Tips

The information contained in Healthy House Building Tips will **surprise and alarm** you. Everyone who is building a new house should be aware of the things contained in this document. For those with allergies, chronic illness, multiple chemical sensitivities, asthma, or respiratory illness this information is **absolutely essential**. The bottom line is that two trends in house building have converged to make the typical new house constructed today **less healthy than it was 50 years ago**. These trends are the increasing tendency to use man made materials and the construction of "tighter" homes with less outside



air exchange. Did you know that the **indoor air quality in most new homes is 5-10 times worse than outdoor air, even in the most polluted industrial areas?** That is why the information found in the Healthy House Building Tips document is so important. Here is an example section.

*Perhaps the worst offenders when it comes to building healthier houses are carpets and specifically man-made carpets. They can contain a variety of substances that outgas for many years. These gases are precisely what you are smelling when you enter a carpet store or a newly carpeted room. The many nice features you can purchase for carpeting such as color fastness, stain proofing, fire resistance, etc. are achieved by the use of chemicals. Carpets outgas these chemicals at the highest rates for the first few years but continue slowly for many years thereafter. The good news is that if you are aware of the air quality problems associated with the normal new house construction project, much can be done to mitigate these problems, and at a reasonable cost.*

### Free Newsletter

Each month we publish a newsletter that addresses the topics of indoor air quality, home building convenience items, and money saving tips. You can subscribe to this newsletter by providing the information requested below. This is a private mailing list, and will never be sold or given away. You can unsubscribe at any time.



|                |  |
|----------------|--|
| First Name     |  |
| Last Name      |  |
| E-mail Address |  |

*This is my first newsletter, but I find it excellent. I can already see that it is going to address many of the issues that concern me and my wife as we begin to build our dream house in the Napa Valley,... Thank you.*

### Special Bonus #1 - Introductory Discount

If you have read all the way to this point, you probably have an interest in purchasing this Guide and are wondering what it costs. Pricing the Guide was a real dilemma for me. Literally, the implementation of just one of the money savings tips discussed would save hundreds of dollars-- and the total value of all the money saving and convenience is easily in the thousands. My nearest competitors, who show people how to save money by being their own GC, are charging \$69.95. I think my Guide is worth more, because it doesn't force you to undertake the enormous task of being the GC to save money. Nonetheless, using the \$69.95 price as my benchmark, I am offering an introductory price of less than 50% or \$29.95 for the electronic version of the Guide. For an additional \$7.95, my cost to cover printing and shipping, you can have a printed version (book) mailed to your home.

### Special Bonus #2

The Healthy Home Building Tips is a separate stand alone Guide which normally sells for \$9.95. It contains important, if not critical, information that will affect your health for years to come. This second Guide will be included free to all purchasers.

### Special Bonuses #3 and 4

I have included as stand alone documents with the Guide an example set of specifications and a sample house building contract. These two documents are provided in a Word format so you can edit or modify them for your own use. These two documents together represent a \$12.95 value.

### Bonus #5, Limited Time Offer - A Free House Plan

**Every purchaser of the House-N-Home Guide will receive a free house plan.** I spent more than \$600 to have these plan drawn up. This is a value of at least **\$500, and probably hundreds more** judging by the prices for similar plans on some of the House Plan websites. It's a tremendous bonus gift ([Click here for more details](#)) that you will not find anywhere else, but I can only guarantee this free gift if you act within the next **days**.



### 100% Money Back Lifetime (Double) Guarantee

We insist that you order the House and Home Building Guide entirely at our risk. That's why this Guide and accompanying documents comes with a **Risk Free, Lifetime 100% Money Back Guarantee**. There is absolutely **No Risk** on your part. This means you can return it anytime: next week, next year or ten years from now....**BUT**... you still get to keep the Healthy House Tips.



...However, a significant portion of the information and data within the Guide was not relevant to an Irish/European customer... I was impressed by the speed of your response in (a) accepting my feedback as valid and (b) fully refunding me my money. In short, your promised guarantee was delivered upon and I regret that you do not provide a

### BBB Online Reliability



But a guarantee is only as good as the business that stands behind it. House-N-Home-Building is a member of BBB Online, one of the most well known and respected business reliability organizations in the U.S. BBB Online members must subscribe to a code of ethics for transacting business online.

### SSL Confidence

Looking for even more security?  
House-N-Home-Building's SSL certificate insures that any information you provide to us is secure. The Comodo seal indicates that any sensitive information you give us is encrypted using 128 bit encryption technology. Comodo provides a \$2500 insurance policy should the

similar service for folk outside of USA/North America.

--Eamon Brennan,  
Ireland

end user lose money from what was thought to be a trusted session. Click on any of these seals to double check House-N-Home-Building's status (may be shown as our parent company Todd, Michael and James).

### Final Bonus For Internet Customers

Throughout the Guide, there are references to resources that I have used and recommend. All **purchasers** get **free** access to this **password protected** web page with these information sources.

**Remember all of this important information is available to you within seconds of ordering!**

**By clicking the order button below, you will be transferred to our secure server, where you will complete your order by providing the required information.**

Yes, I would like to order

Phone Orders and Customer Support  
Now Available 24/7  
215/604-3654

---

House-n-Home is a division of Todd, Michael and James, Inc.

4620 Derby Lane t Doylestown, PA 18901

215/604-3654 (P) t 215/766-2887 (F) t [info@house-n-home-building.com](mailto:info@house-n-home-building.com)

© Copyright, 2001-2004, Todd, Michael & James, Inc., All rights reserved

---

Fc 451239



[top sites](#) [home+building](#) [home building directory](#)

[FREE counter and Web statistics from sitetracker.com](#)



educatedhomebuyer.com

Home

About Us

Loan Calculator

Building a Home

Closing Costs



Home Buyer Tips

## Discover the secrets of getting the best deal on a home and mortgage

Here's how to avoid making the mistakes that most homebuyers make --- mistakes that will cost you thousands!

"Your home buyers guide is required reading, just excellent! From choosing the right real estate agent through the closing process, your information is right on the mark. You have written a concise, informative and understandable guide for the real estate consumer --- giving the reader a true buying advantage."

**Florence Tanner, RE/MAX Harbor Realty, Punta Gorda, Florida** [www.florencetanner.com](http://www.florencetanner.com)

Dear Home Buyer,

If you'd like to

- pay the lowest possible closing costs when you purchase a home,
- understand exactly what price to offer for any home, and
- save \$3070 or more on your mortgage loan,

then this might be the most important web site you'll ever visit.

Here's why:

I've put together over 35 pages of tips, advice and techniques designed to guarantee that you completely understand the home buying process, save money and avoid being taken advantage of

**---and I know what I'm talking about, I was employed in the real estate industry for over ten years first as a real estate agent and later as a mortgage loan officer. I'm quoted as an industry expert on a number of major websites,**

including MSN.com ([click here for a link to the article](#)).

While mortgage lenders, real estate agents and other real estate professionals are all licensed, closing costs and agreed upon sales prices are not regulated in any way---so it's not unusual for a home buyer to:

- **pay more than reasonable closing costs**
- **accept higher than market interest rates**
- **or pay more for a house than it's actually worth.....*and not even know it.***

## Would you know if you paid too much for a house or mortgage?

Unless you completely understand how the real estate industry works, you could become one of the many homebuyers who pay too much.

- One study showed that borrowers who received a mortgage loan in 2000 paid **\$23,942,858 in unnecessary upfront fees**---*and that study included only borrowers in the state of Colorado!*

*the entire study is available at:*

<http://www.acorn.org/acorn10/predatorylending/plreports/DreamDeferredCo.pdf>

- Don't live in Colorado? The problem is not state specific -- the same organization that did the Colorado study estimated that **borrowers who received a loan in Arizona in 2001 paid \$33,382,596 in unnecessary up-front fees**---it happens everywhere in the United States.
- Fannie Mae, the nation's largest source of financing for home mortgages, has estimated that **as many as half of all borrowers in subprime (higher than market interest rate) loans could have instead qualified for a lower cost mortgage.**

I've put together a home buyer's guide packed with real estate industry inside information that will prepare you to buy a home with confidence---**and avoid becoming part of a statistic** like the ones you just read about.

Now, I know you're probably skeptical. That's normal and healthy.

**Let me give you three good reasons** you need to read my guide if you are buying a home:

### Reason # 1. **This is Information You Can't Find Anywhere Else**

There are dozens, maybe even hundreds of home buyer guides available today. But try and find one that tells you how to negotiate with a lender---you can't because many of these other home buyer guides are written and distributed by lenders! They don't want you to really understand their business....if you do, they can't get away with overcharging you.

**Relying on a homebuyer guide written by a mortgage lender or real estate agent for all of your information would be like stopping at a car dealer and expecting to find a booklet that tells you how to negotiate the best deal on a car purchase!**

*I'm no longer affiliated with any real estate agency or lender so I*

can give you honest, unbiased advice rather than a commercial disguised as information.

My husband and I recently went to contract on a new construction home. There are many reasons I wish I found your site earlier in the game, but we have benefited even at this point. We had to use their lender to get some substantial incentives, however, I had no idea what fees & charges were negotiable and what weren't. After reading your guide, I was able to get our closing costs lowered \$350.00! This is information that \*just isn't out there\* in the general domain. **L. Collins, Aurora, Colorado**

## **Reason #2. I Worked in the Real Estate Industry for Over Ten Years and Witnessed All of the Tricks & Scams Firsthand**

I was President and owner of Lakeshore Mortgage in Rocky River, Ohio; developed an FHA loan program for a leading regional bank, and was affiliated with a leading Century 21 franchise. I participated in hundreds of real estate transactions over ten plus years--and saw the results up close (and unfortunately witnessed a lot of people get taken advantage of by other unscrupulous real estate professionals). Only someone who has worked in an industry for a long period of time can provide you with useful information about that industry.

## **Reason #3. Overcharging and Unfair Dealing Has Become a Major Problem in the Real Estate Industry Today and If You Don't Completely Understand the Home Buying Process, You Could Be Taken Advantage Of**

Just listen to what a leading Federal Trade Commission Official had to say in a Senate Hearing:

As a result of unfair and deceptive practices, and other Federal Law violations by certain lenders, vulnerable borrowers ..... are facing the possibility of paying significant and unnecessary fees....*Jodie Bernstein, Director of the Bureau of Consumer Protection of the Federal Trade Commission, March 1998 U.S. Senate Special Committee Hearing*

And the problem doesn't stop with mortgage overcharging---

- The problem of property flipping--- where **uninformed and unsuspecting borrowers pay substantially more than a property is worth** because they rely on the seller or a broker for home buying guidance-- is so widespread that some cities have passed laws in an attempt to stop the practice.
- The city of Dayton, Ohio's law, for example, bans loans that "over appraise the value of the property." Great in theory, but do they really have the resources to enforce this in practice? Will the city prosecutors all become real estate appraisers?

**You need real estate knowledge to protect yourself---don't expect anyone else to look out for you....especially if they are benefiting in some way from your house sale transaction.**

**For a sample of the kind of information I provide in my homebuyer's guide.... Just enter your first name, email address, and the month you expect to purchase a home---"Mortgage Closing Costs You Shouldn't Pay" will be emailed to you immediately.**We do not sell or share email addresses with any other company.

**Your First Name:**

**Your E-Mail Address:**

**The Month You Expect to Buy a House:**



## Here is a Summary of the Benefits you Receive from my Home Buyer's Guide and How it Will Help You Avoid Being Taken Advantage Of

- My guide shows you how to determine the market value of any property without relying on your real estate agent or anyone else for help.
  - Did you know that in many cases as a buyer, **your** real estate agent actually has a legal responsibility to represent the seller and get you to pay the highest price possible?
- You'll know exactly what price to offer on any home.
  - Eliminate any fear you have of overpaying for a home. Know when the property is actually being offered at a below market price---and not just being advertised that way.
- The guide includes a script to use when you are loan shopping.
  - Many mortgage shoppers believe that the more lenders they call, the better deal they'll find. Unless you know how to speak with a loan officer, you can call hundreds of lenders and still not find the lowest rate available.
- Save 1/8% or more on the originally quoted interest rate by understanding how to deal with a loan officer--thousands over the life of your loan (1/8% on a \$100,000 loan = \$3070 savings)
- I explain how a lender qualifies a borrower.
  - You enjoy the comfort of knowing that you qualify for a loan and won't be taken advantage of by being placed in a high interest loan product.
  - The steps to take before you buy a home can make the difference between getting and not getting your dream home
- What questions to ask a home inspector - before you hire him

- Also be aware of a hidden motivation your home inspector might have that could skew the results of the report he provides you
- All closing costs that you are likely to encounter are defined and a \$ value range is provided for each closing cost
  - A very common title company and lender trick is to slip \$50, \$100 or \$200 onto one or more costs to boost their profit. Know how to recognize this.
- I list the 5 things that can make a property's value drop like a rock.
  - Do you know which homes on your real estate agent's list you shouldn't even bother looking at and why?
  - You won't purchase a home that you can't resell in the future.
- Chapter 2 reveals the 3 different types of lenders.
  - You'll understand which type of lender will be able to serve you best based on your situation.
- I show you what to look for at closing.
  - You will avoid becoming the victim of a "bait and switch" lender or unscrupulous seller.
- I explain how a lender makes a profit on a loan.
  - You need to understand this before you can negotiate the best loan deal.

**Now, you're probably wondering how I can provide all of this information.**

**Let me explain.**

- I spent the better part of my free time over three months putting everything I know about the home buying process into an e-book.
- I concentrated on things you don't find in the typical "How to buy a house" books; **things like how to save \$3070 or more on your mortgage** and
- **how to determine what price to offer for any home** without relying on your real estate agent to make the decision for you.

**The Educated Home Buyer was the result of all my work -- over 35 pages of industry insider information that you won't find anywhere else. And because it's an e-book that's delivered to you automatically, I can offer you this valuable information myself at a reasonable price --and I don't have to deal with editors or publishers who would probably force me to take out some of the content because they're afraid of offending another industry (like the mortgage lending industry for example).**

## Don't take my word for it. Listen to what my customers say.

I too would like to thank you for the information you provided. It gave me the ammunition and the courage to confront my lender about the "junk fees" included in my good faith estimate and the result is that I have saved approximately \$1900.00 on my closing costs. *Sharon, Queens, New York*

"I purchased your e-book just before I met with the mortgage company for refinancing. I saved \$380 on closing costs due to your advice on what costs should be negotiable. I will be saving the book to give to my son and daughter-in-law who will soon be buying a home. Thank you!" **P Gamin Leslie, MI**

I just wanted to tell you what fantastic information you have been sending me. I attended a homebuyer education class, but this far outweighs the information I received for an 8 hour class! thanks again and keep up the great work! **A Barnard**

Thank You Sir for your help and information, We have found out our credit score and we at present have two lenders looking for us, also we are just waiting for the evaluation of the house. A mortgage company from OH has mention the figure of 80 % of value so we are on the road and thanks to you we know more of the right questions to ask. Thank You Again **Larry & Barbara Gullett, Ohio**

Thank you for your help.. ... I do wish that I had come across your site before I bought my current home - we would have saved a lot! *S. Diaz*

I recently purchased The Educated Home Buyer guide. I only wish I would have came across it about 2 weeks earlier! It had so much information and it was detailed and easy to understand! **H. Holmes, Connecticut**



## Warning: Do NOT buy a house until you understand all of these concepts:

**There is a lot of confusion surrounding buying a home today. I want to give you 6 things you absolutely, positively must know before you buy a house.**

**One:** you have to know how to negotiate with a lender. Most loan officers work on commission and the more they get you to pay in interest and closing costs - the more money they make. It's possible for the loan officer to make more in commission than the real estate agents.

**Two:** you must understand what each closing cost covers and what a reasonable \$\$ amount is for each cost. Not all overcharges by lenders and title companies are massive amounts of money - many borrowers are overcharged by only a few hundred dollars. But are you willing to pay one of these companies even \$50 more for a service than is fair?

**Three:** you need to know how to determine the market value of any house without your real estate agent's help. I absolutely recommend working with a real estate agent. A real estate agent can be a tremendous resource and in most cases costs the buyer nothing - but it's a mistake to rely on your agent to tell you what to offer for a home.

**Four:** you have to be aware of the hidden motivation your home inspector might have--motivation that will influence the results of your report. Why you shouldn't even consider using the home inspector recommended by your real estate agent.

**Five:** you must know exactly how a lender qualifies you for a mortgage loan. If you don't, you could end up with a higher interest rate than you deserve - or even have your loan application denied when it shouldn't have been.

**Six:** you have to understand which documents to review at closing and what to look for. Most home buyers that you read about who ended up paying more for a house than they should have or with much different mortgage loan terms than they thought they were getting have one thing in common - they didn't know which documents to pay close attention to at closing - and what parts of those documents are the most crucial. So it was easy for an unscrupulous lender or seller to take advantage of them.

**The Educated Home Buyer Guide teaches you all of these things and more----over 35 pages of information you can't find anywhere else!**

You get at least 10 times your money's worth!

Many people have emailed me to say that they've saved \$300, \$400 or more on their closing costs based on the information I provided----and by knowing how to determine

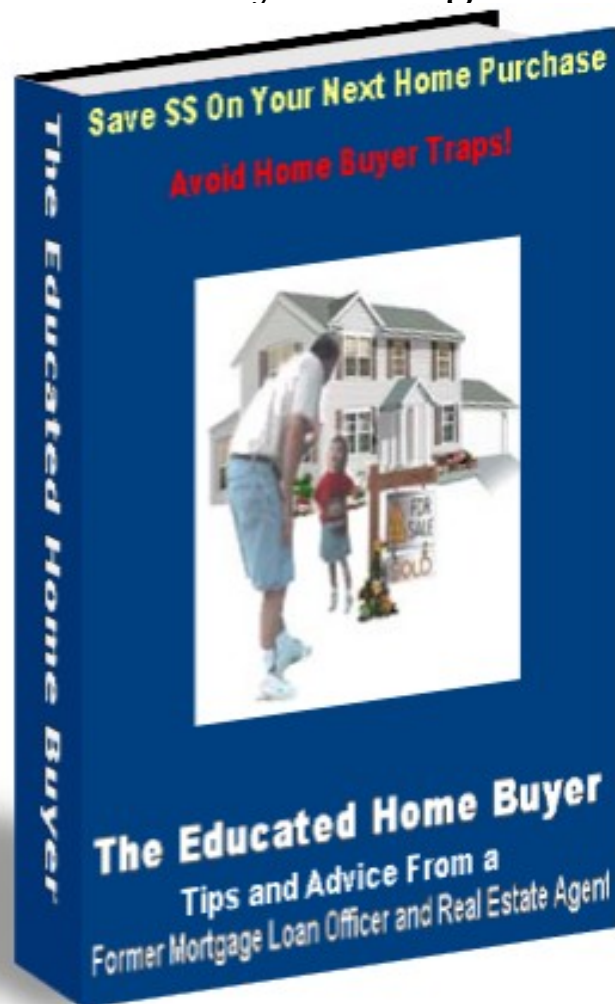

the value of any home, you could potentially save yourself from overpaying thousands for a house! You can download and start using my guide immediately - **and if you order today, you'll receive over \$175 worth of FREE bonuses.**

Since I know it's 100% to your benefit

to download and start using my guide today, I want to sweeten the pot and give you every possible reason to say order right now! If you respond immediately, you'll also receive the following **4 FREE BONUSES**:

**Free bonus # 1:** Order Now and you'll also receive "**House Construction Design Standards**". (a **\$19.95 value**) 37 pages of room by room residential design standards compiled by a designer/builder with over 40 years experience. Great reference guide to use in researching those things that "just didn't look right" in a house.

**Free bonus #2: Order Today and you'll also receive all the information and forms you need to take advantage of the Jeremiah Program.** The Jeremiah Program is a privately funded **down payment assistance program** whose purpose is to provide homebuyers with a monetary gift which doesn't have to be repaid---**and you don't necessarily have to be a first time buyer to take advantage of this program!**

**Free bonus #3: MY PERSONAL EMAIL ADDRESS.** Email me with your home buying questions at any time throughout the process. One online mortgage consultant currently **charges \$97 an hour** to answer your questions- you can ask me as many questions as you want as a FREE bonus!

**Free bonus #4:** You'll be placed on my personal email list ----and receive even more home buyer tips as I discover them from my industry contacts and research. Online information subscriptions can cost \$49, \$79, even \$100 or more per year----**this one comes FREE** with your home buyer's guide.

### In summary, here's what you get:

- You'll immediately receive instructions on how to download my **35+ page home buyer's guide** packed with industry insider information that is **100% guaranteed** to save you money on your next home purchase
- You'll receive **information and guidelines on the Jeremiah Down Payment Assistance Program**
- **"House Construction Design Standards"** (a \$19.95 value)
- **FREE access to ask me any home buying questions** you have (compare to \$97/hour for advice)
- **Follow up information by email** as it becomes available (at least a \$69 value)

**The Bottom Line: If you act now,  
You're getting more than \$200\*  
worth of information and advice  
for just \$19.95**

\* \$19.95 for my guide+ \$19.95 for "House Construction Design Standards"+ \$97 for mortgage consulting+ \$69 for online information subscriptions = \$205.90

## AND You can't lose with my 100% , ironclad, money back guarantee

Even though you're getting a tremendous value -- I'm so confident that you'll be as satisfied as all my other customers are with the guide and the bonuses that I'm willing to include a [no questions asked, no time limit, 100% money back guarantee](#).

Here's how it works. Order my guide today -- If you use just one of the techniques or pieces of information and don't feel that you've saved yourself at least \$100 (that's over 5x the purchase price) -- I'll refund your money, no questions asked. And this is a lifetime guarantee -- return the guide one day, one year or ten years after you purchased it if it doesn't save you money.

What I'm saying is, don't decide now if the guide is for you. The only sure way to decide is to get it and try it out.

- If it doesn't provide all of the information you need,
- if you don't save time, money and frustration on your next home purchase,
- if it doesn't help you,

you have nothing to worry about because you can get every dime of your money back under our no-loopholes guarantee.

So you have nothing to lose and thousands to save on your home purchase!

But don't delay - [I had to make special arrangements to offer "Home Construction Design Standards" and the down payment assistance program details as bonuses - and my right to offer these items as Free bonuses could be cancelled at any time by the other authors.](#)

There's also a limit to the number of emails I can answer - so at some point I'll reach my limit in terms of the number of emails that I can reasonably answer and will have to cancel this bonus---- you might not get direct access to ask me any of your home buying questions if you wait past today to order.....

## **The Educated Home Buyer Guide** Here's how to order right now!

- Make your payment using any major credit card
- You'll immediately be taken to a page where you can download your home buyer's guide--your bonuses will arrive via follow up emails
- Download your guide and view or print it within

minutes of your order (it's an Adobe file, most PCs come with Adobe Acrobat Reader, if yours didn't [click here to get Adobe Reader for Free](#))

[Click Here for Secure Credit Card Payment thru ClickBank](#)



[Click here for other payment options](#)

Good luck in your new home,

**Don Petrasek**

former mortgage loan officer and real estate agent

Copyright 2003 The Educated Home Buyer, Inc.



[Links](#)

[Home](#) | [Contact Us](#) | [Order Now](#)

[About Us](#) | [Loan Calculator](#) | [Building a Home](#) | [Closing Costs](#)

# JimSalmon.com

Professional Home Inspection Services

## Jim Salmon

585.589.5650

Listen to Jim live 6am  
Saturday mornings on



Home Repair Library



Find a Contractor



home inspection  
information



bios



Contact Us



home



## Welcome to JimSalmon.com

Our office number is 585-589-5650

Thank you for visiting JimSalmon.com! We are always updating the website with more home repair, home improvement, and do it yourself resources.

Also, just click [Here](#) to view our interesting articles or continue to scroll down this page for new information. Click on any of the icons along the top for more info.



Take Our Poll!



Books Recommended  
By Jim!



FREE Classifieds

If you are buying a new home make sure you have it inspected prior to closing, there is too much at stake not to know the condition of that home before you buy, check out Jim's [home inspection page](#)

**WHAM 1180**  
Real Estate Show

**John Carr's Roof  
Project**

Tune into the WHAM 1180 (AM radio) Home Repair Clinic on Saturday mornings 7:00am-9:30am. Join Jim Salmon and John Carr, with Mike Whittemore as your host, with home repair related questions and answers. Call in or just listen to the fun time they have. There's a chance you might even learn something from them! Or they from you!  
1-800-295-1180, 1-585-222-1180, or \*1180 (cell callers).

JimSalmon.com



**SURVEY**



WHAM Real  
Estate Show  
House Listings



**Featured Links-----Featured Links-----Featured Links-----Featured Links-----Featured Links-----Featured Links-----Featured Links-----Featured Links**

|                                           |                                           |                                            |
|-------------------------------------------|-------------------------------------------|--------------------------------------------|
| <a href="#">* Vinyl House Siding</a>      | <a href="#">* Find a Mortgage Broker</a>  | <a href="#">* Archway Home Plans</a>       |
| <a href="#">* Rent an Apartment</a>       | <a href="#">* Home Security Systems</a>   | <a href="#">* Find a Real Estate Agent</a> |
| <a href="#">* House Plans and Designs</a> | <a href="#">* Home Repair Quotes</a>      | <a href="#">* Defective Home Siding?</a>   |
| <a href="#">* Find a Contractor</a>       | <a href="#">* Home Siding Settlements</a> | <a href="#">* Your Link Here</a>           |

| JimSalmon.com Features                |                                                 | Latest Recalls                                                                      |
|---------------------------------------|-------------------------------------------------|-------------------------------------------------------------------------------------|
| <a href="#">* Keep Your Pets Safe</a> | <a href="#">* Need a Mortgage? Call Dennis!</a> | 8/31 - <a href="#">Nursing Pillows</a><br>9/2 - <a href="#">Maternity Pillows</a>   |
| <a href="#">* Nemmar.com</a>          | <a href="#">* Goo Gone</a>                      | 9/2 - <a href="#">Stroller Attachments</a><br>9/2 - <a href="#">SCUBA inflators</a> |
| <a href="#">* The Brush System</a>    | <a href="#">* Super Iron Out</a>                | 9/2 - <a href="#">IBM AC adapters</a>                                               |
| <a href="#">* ReHouse Auctions</a>    | <a href="#">* Your Link Here</a>                | 9/2 - <a href="#">Electric Scooters</a>                                             |

| Recent Updates to the Home Repair Clinic Library!                                                              |
|----------------------------------------------------------------------------------------------------------------|
| <a href="#">Save Energy and Money</a><br>How to Buy an Energy Efficient Home Appliance.                        |
| <a href="#">Scary Stories From the Attic</a><br>Check out this 3-part article on Attic Ventilation             |
| <a href="#">Home Prices Rise</a><br>Home Prices Expected to rise.                                              |
| <a href="#">Luxury and Exotic Cars for Rent</a><br>Luxury and Exotic Cars for Rent in Southern California.     |
| <a href="#">Home Tips, Home Improvement</a><br>Your one-stop resource for help with home improvement and More. |

**Home Page News**  
Gutter Stuff

Gutter Stuff was installed on my house today! Folks, you have to check this out. I will never have to clean my gutters again! For purchasing information visit Hal Brewster's website or call Hal Brewster Home Improvements at (585)235-4360.....[more](#)

[Contact Page](#) | [Join Email List](#) | [FREE Classifieds](#) | [Home Page](#) | [top](#)

Jim Salmon - © 2004

by [internet solutions](#)



The #1 Real Estate Directory - Offers links and information to real estate related sites.

[Submit a Site](#) | [Contacts](#)



**Get a Home Loan!** Find Lowest local interest rates from lenders in your area.

|                        |      |                           |      |      |         |               |          |                   |
|------------------------|------|---------------------------|------|------|---------|---------------|----------|-------------------|
| BUY                    | SELL | FINANCE                   | RENT | MOVE | IMPROVE | HOME & GARDEN | SERVICES | FOR PROFESSIONALS |
| COMMERCIAL REAL ESTATE |      | INTERNATIONAL REAL ESTATE |      |      |         |               |          |                   |

For a List of Foreclosures in Your Area [Try a Free Search!!](#)

Enter your area

Web reals.com POWERED BY

### Real Estate Foreclosures

- " [ForeclosureWorld](#)
- " [ForeclosureLeads](#)
- " [ForeclosureTown](#)
- " [ForeclosureNet](#)
- " [ForeclosureFreeSearch](#)
- " [RealtyTrac](#)
- " [BankHouses](#)

Explore by Categories [[Submit a Site](#)]



**Agents & Brokers**  
[Buyers](#)  
[Agent](#)  
[Business Broker](#)  
[Interview Agent](#)



**Finance & Mortgage**  
[Credit Report](#)  
[Commercial Lender](#)



**Apartments & Rentals**  
[Find Roommate](#)  
[Corporate Housing](#)



**Home & Garden**  
[Garden](#)  
[Home Decorating](#)



**Insurances**  
[Mortgage Insurance](#)  
[Life Insurance](#)  
[Home Warranty](#)



**Improve & Repair**  
[Builders](#)  
[Architects](#)  
[Contractors](#)  
[Supplies](#)

### Shop Online



[The Largest Selection of Real Estate Marketing Tools, Supplies, and Services](#)

[VA Loan - VA Mortgage](#)





**Moving**  
Auto  
Transport  
Supplies  
Storage  
Relocation  
Expert



**For Sale By**  
**Owner**  
Discount  
Brokers  
FSBO Kits  
Search  
Listing



**Commercial**  
**Real Estate**  
Developers  
Investment  
Office Space

Get a VA insured mortgage loan at the lowest possible rates.  
**GO>**



**Real**  
**Estate**  
**Services**  
Appraisals  
Consultants  
Inspections  
Pest  
Controls



**Foreclosure**  
**Central**  
Auctions  
Bank Owned



**Property**  
**Management**  
Career  
Training  
Tenant  
Screening

**Real Estate Cartoon**



Send your photo and get your caricature  
**GO>**



**New**  
**Homes**  
Planned  
Community  
Home  
Builders  
Senior  
Living



**International**  
**Real Estate**  
Canada Real  
Estate  
UK Real  
Estate  
Asia Real  
Estate



**Career**  
**Training**  
Appraisal  
Inspection  
Property  
management



**Property**  
**Listing**  
Luxury  
Homes  
Million  
Dollar  
Home



**Resort**  
**Online**  
Bed &  
Breakfast  
Time Share



**Golf & Land**  
Golf Resort  
Land  
Directory  
Agricultural



**Real**  
**Estate**  
**Legal**  
Escrow and  
Title  
Forms



**Real Estate**  
**Support**  
Supply Store  
Web Services



[Submit a Site](#) | [Company Info](#) | [Site Index](#) | [Contact Us](#) | [Link to Us](#)

[Terms of Use](#) and [Privacy Policy](#)

Information contained herein is deemed accurate and correct, but no warranty is implied or given.

Â© Reals.com 2004. All rights reserved.

A product of [Real Estate Advertise](#)

[Click here to Bookmark REALS.COM](#)

# TIMBERLINE GEODESICS

## Product Information

### Ease of Construction Without Skilled Labor or Heavy-lift Equipment

- All wooden components of a Timberline Dome are pre-cut and pre-drilled to exacting specifications, and color-coded to make it easy for unskilled people to assemble them with precision and confidence. Two people can complete the framework for even the largest dome in less than two days. The largest piece for a 45' dome is a 10 ft. long 2" x 6", which is easily handled by one person. Timberline Domes are completely free-standing during construction. No shoring up is needed. No special tools or expensive lift-equipment, like cranes or forklifts, are necessary to assemble a Timberline Dome.

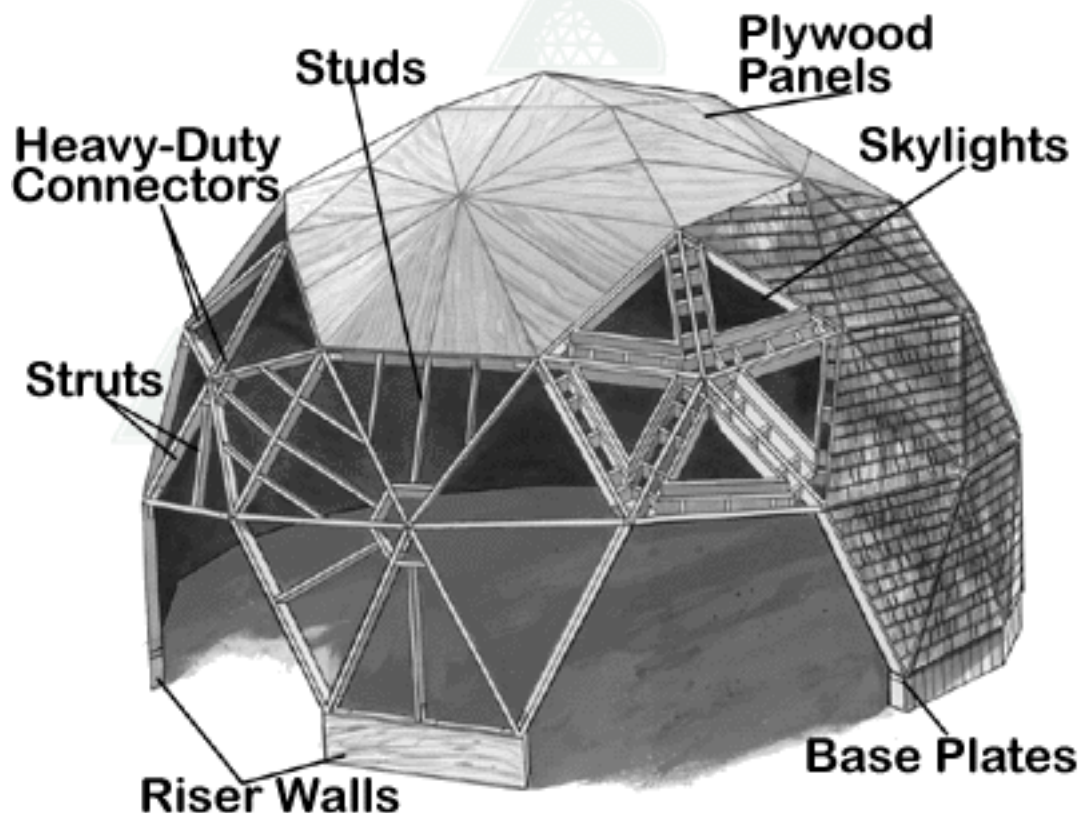

**Riser Walls** - Domes 24' to 35' in diameter are designed with riser walls to give greater height to the structures. Timberline also offers optional height riser walls for any size dome. Riser walls can be built up to 8' in height. Each riser wall section comes to you fully assembled. Select Structural 2" x 6" studs are nailed 16" on center between a rot resistant

**sill plate and a top plate. The outside is finished with a 1/2" CD exterior grade plywood. Hex bolts join each color-coded section to the next.**

**Struts** - All Timberline Struts are made from kiln-dried 2" x 6" Select Structural Hem Fir or Douglas Fir, which can withstand considerable compression and tension. Every strut is beveled on its outer edge to ensure that the plywood panels lie flat on the struts. We do not use automatic feeds or gang drills. All struts are individually cut and drilled at correct angles. In addition to purchasing lumber that is graded and rated for strength, we personally inspect each piece for knots, or warping. You get only top quality struts that are accurately pre-cut, pre-drilled, and color-coded.

**Heavy-Duty Connectors** - Each Connector in the Timberline Assembly System is fully engineered and fabricated with correct axial and radial angles to assure maximum strength, durability, precision and ease of assembly. The connectors are manufactured from schedule 40 steel pipe and 10-gauge hot-rolled steel. They are painted with industrial primer and then color-coded for easy identification. The wooden struts butt directly up to the central pipe, which virtually eliminates shear in bolts, and allows for strong compression loads.

**Ledger Hanger System** - The patented Timberline Ledger Hanger hardware uses the existing structural framework of a 5/8 sphere Timberline dome itself to form an auxiliary framework for a second floor.

**Studs** - Studs are fabricated from #2 or better Douglas Fir or Hem Fir. They are precision cut to be installed at 16" on center throughout the framework. The result is an enhanced framework that conforms with standard dimensions of conventional finishing materials.

**Plywood Panels** - The triangular plywood panels are made from 1/2" 5-ply Structural Grade #1 plywood, pre-cut and color coded.

**Skylights** - Dome symmetry permits the placement of skylights virtually anywhere in the structure. In addition to creating an attractive natural light ambience, a skylight pattern that follows the path of the sun provides passive solar heating, increasing your energy efficiency.

**Base Plates** - Precisely cut solid 4" x 6" pressure-treated beveled base plates are mounted to the foundation (or to the top plate of a riser wall) to achieve the correct angle to support the bottom struts of the dome structure.

**[How to reach us.](#)**

**To order our color catalog or video tape.**

| [Home](#) | [Product Information](#) | [Scrapbook](#) | [Build A Dome](#) | [Plans](#) | [FAQ](#) | [Additional Information](#) | [Web Video](#)



# TIMBERLINE GEODESICS

## Scrapbook



**Robert - Whitehouse, Ohio**



**Dave & Lynette - Julian, California**



[The Horton's Dome Home Web Page - Vermont](#)



Timberline in the Movies

[Timberline Goes Hollywood](#)



[Don & Edgar's Dome Home Web Page - New Jersey](#)



[Dan & Nancy's Dome Construction Web Page - Pennsylvania](#)



[Willem and Tracey - Down Under](#)



[Rich and Myrna - Whidbey Island, Washington](#)



[George and Sharon - from the Buffalo News](#)

[Home](#) | [Product Information](#) | [Scrapbook](#) | [Build A Dome](#) | [Plans](#) | [FAQ](#) | [Additional Information](#) | [Web Video](#)

# TIMBERLINE GEODESICS

## To Build A Dome

The only tools you will need are:

- Socket Wrenches
- Hammers
- Ladders
- Scaffolding (desirable)
- Nail Gun (desirable)



The structural framework of a Timberline Dome consists of 2" x 6" wooden struts and our unique heavy duty steel connector system. The color-coded struts are bolted to color-coded connectors using two wrenches. Once the free-standing framework is erected, T-blocking and color-coded wooden studs are nailed at 16" on center in every triangle. This facilitates installation of the plywood shell and the addition of standard size conventional finishing materials.



To complete the basic dome shell, pre-cut, color-coded triangular plywood panels are nailed to the framework. The color-coded parts are cut and drilled precisely. They are easy to identify, and they fit the way the instructions say they should. *We guarantee it.*

[Timberline Building Flowchart](#)

[How to reach us](#)



## [To order our color catalog or video tape](#)

| [Home](#) | [Product Information](#) | [Scrapbook](#) | [Build A Dome](#) | [Plans](#) | [FAQ](#) | [Additional Information](#) | [Web Video](#)



# TIMBERLINE GEODESICS

[Click here for](#)

*New Plans*



## Plans - BIRCH MODEL

The Birch plan is one of our most popular plans for the 35' dome. Totalling almost 2,000 square feet, the Birch features three bedrooms and two baths on two stories.

Downstairs shows an excellent use of extensions. The extensions are used for the two downstairs bedrooms as well as the large kitchen and dining area. This leaves the interior of the dome for the living room/family room. The effective use of skylights provides abundant natural lighting in all rooms.

To see interior views of a finished Birch Model click on the red numbers on the floor plans. The photographs are from a Birch Model in Arizona. This model used a Riser Wall of 1'2" instead of the 3' Riser Wall shown in the plans.

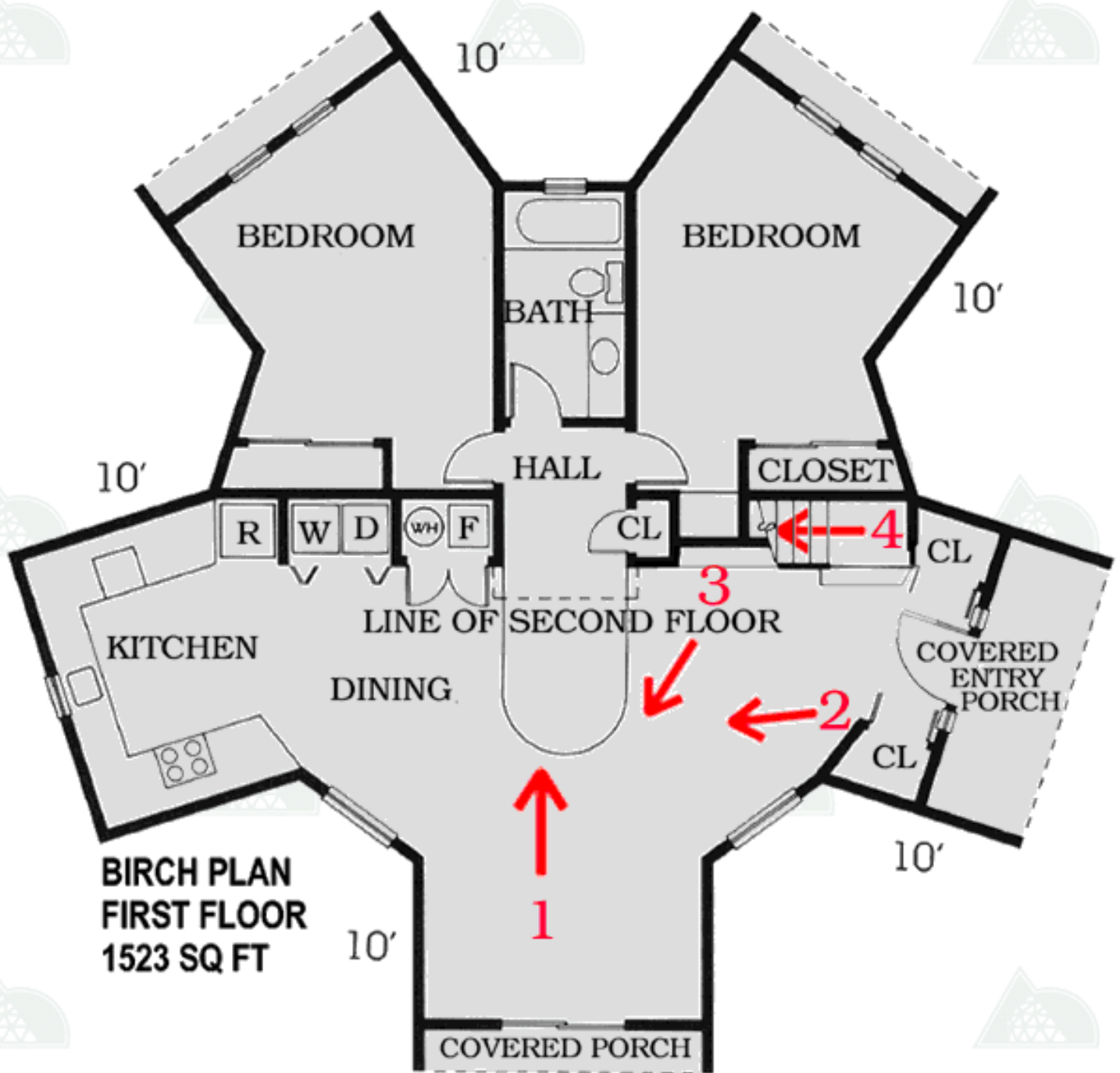

The upstairs is devoted to the Master Suite, with a large bedroom and spacious bathroom. The second floor balcony provides a dramatic view overlooking the first floor.

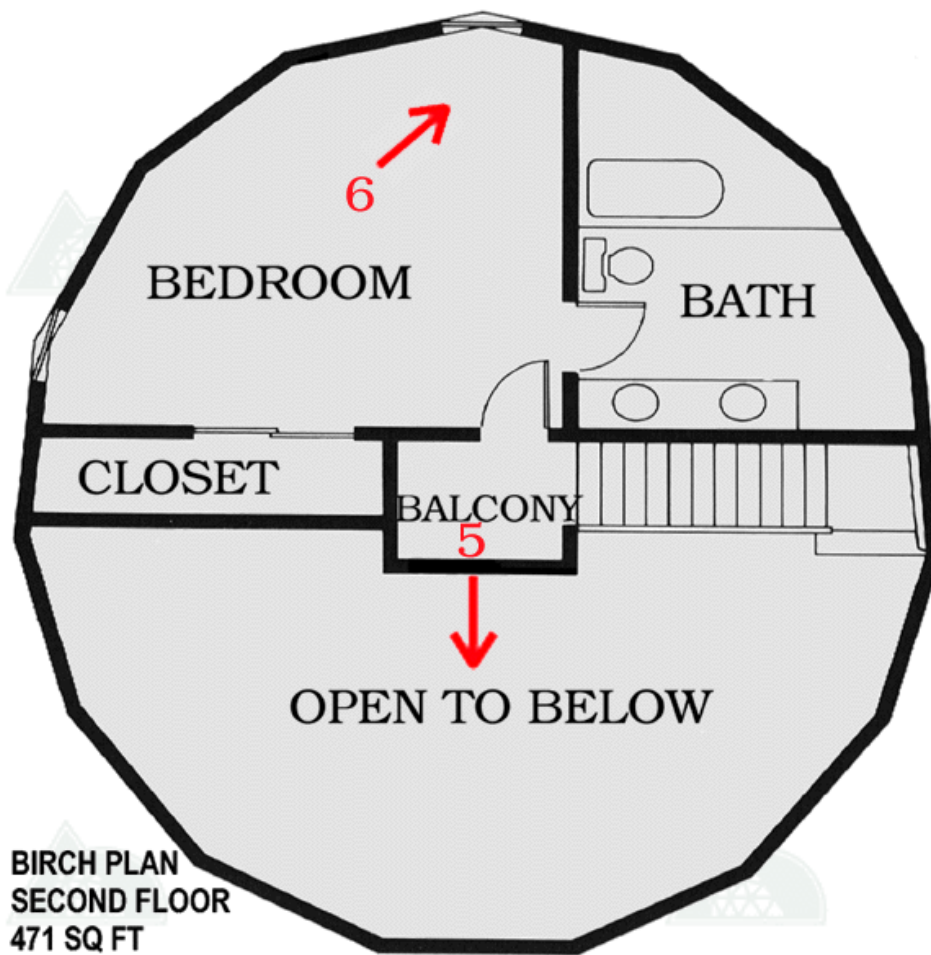

- **Model Name: Birch**
- **Dome Size: 35' Diameter, 5/8 Sphere**
- **Extensions: Five at 10'**
- **Ledger Hangers: Seven 4 x 10**
- **Interior Size:**
  - **First Floor: 1,523 sq. ft**
  - **Second Floor: 471 sq. ft.**
  - **Total: 1,994 sq. ft.**
- **Bedrooms: 3**
- **Bathrooms: 2**
- **Wood Burning Stove - Optional**

**Cost for Birch Dome Kit, Riser Walls, Extensions, Ledger Hangers and Ledgers - \$31,450**  
**Budget Figure for Skylights - \$4,000**

**Other dome home plans available from Timberline Geodesics include:**

|                   |                      |                |                      |
|-------------------|----------------------|----------------|----------------------|
| <b>Twin Pines</b> | <b>Giant Sequoia</b> | <b>Redwood</b> | <b>Towering Pine</b> |
|-------------------|----------------------|----------------|----------------------|

|                                                                                                                            |                                                                                               |                                                                                               |                                                                                               |
|----------------------------------------------------------------------------------------------------------------------------|-----------------------------------------------------------------------------------------------|-----------------------------------------------------------------------------------------------|-----------------------------------------------------------------------------------------------|
| 40 Ft. Diameter<br>5/8 Sphere &<br>35 Ft. Diameter<br>3/8 Sphere<br>3211 Total Sq. Ft.<br>3 Ft. Riser Wall<br>On Each Dome | 45 Ft. Diameter<br>5/8 Sphere<br>3076 Total Sq. Ft.<br>29 Ft. 10. High<br>3 Ft. Riser Wall    | 45 Ft. Diameter<br>5/8 Sphere<br>2877 Total Sq. Ft.<br>29 Ft. 10 In. High<br>3 Ft. Riser Wall | 45 Ft. Diameter<br>5/8 Sphere<br>2590 Total Sq. Ft.<br>29 Ft. 10 In. High<br>3 Ft. Riser Wall |
| <b>Whispering Pine</b>                                                                                                     | <b>Monterey Pine</b>                                                                          | <b>American Oak</b>                                                                           | <b>Aspen</b>                                                                                  |
| 45 Ft. Diameter<br>3/8 Sphere<br>1935 Total Sq. Ft.<br>21 Ft. 4 In. High<br>3 Ft. Riser Wall                               | 40 Ft. diameter<br>5/8 Sphere<br>2578 Total Sq. Ft.<br>26 Ft. 10 In. High<br>3 Ft. Riser Wall | 40 Ft. Diameter<br>5/8 Sphere<br>2476 Total Sq. Ft.<br>26 Ft. 10 In. High<br>3 Ft. Riser Wall | 40 Ft. Diameter<br>5/8 Sphere<br>2185 Total Sq. Ft.<br>26 Ft. 10 In. High<br>3 Ft. Riser Wall |
| <b>Cedar</b>                                                                                                               | <b>Cypress</b>                                                                                | <b>Maple</b>                                                                                  | <b>Hickory</b>                                                                                |
| 40 Ft. Diameter<br>5/8 Sphere<br>2203 Total Sq. Ft.<br>26 Ft. 10 In. High<br>3 Ft. Riser Wall                              | 40 Ft. Diameter<br>3/8 Sphere<br>2275 Total Sq. Ft.<br>19 Ft. 4 In. High<br>3 Ft. Riser Wall  | 40 Ft. Diameter<br>3/8 Sphere<br>1837 Total Sq. Ft.<br>19 Ft. 4 In. High<br>3 Ft. Riser Wall  | 35 Ft. Diameter<br>5/8 Sphere<br>1521 Total Sq. Ft.<br>23 Ft. 10 In. High<br>3 Ft. Riser Wall |
| <b>Spruce</b>                                                                                                              | <b>Willow</b>                                                                                 | <b>Apple</b>                                                                                  | <b>Cherry</b>                                                                                 |
| 35 Ft. Diameter<br>5/8 Sphere<br>1522 Total Sq. Ft.<br>23 Ft. 10 In. High<br>3 Ft. Riser Wall                              | 35 Ft. Diameter<br>3/8 Sphere<br>1075 Total Sq. Ft.<br>17 Ft. 4 In. High<br>3 Ft. Riser Wall  | 30 Ft. Diameter<br>5/8 Sphere<br>1179 Total Sq. Ft.<br>20 Ft. 11 In. High<br>3 Ft. Riser Wall | 30 Ft. Diameter<br>3/8 Sphere<br>883 Total Sq. Ft.<br>15 Ft. 3 In. High<br>3 Ft. Riser Wall   |
| <b>Three Car Garage</b>                                                                                                    | <b><u>Two Car Garage</u></b>                                                                  | <b><u>Double Mulberry</u></b>                                                                 | <b><u>Poplar</u></b>                                                                          |
| 35 Ft. Diameter<br>3/8 Sphere<br>1200 Total Sq. Ft.<br>5 Ft. Riser Wall<br>19 Ft. 7 In. High                               | 24 Ft. Diameter<br>3/8 Sphere<br>491 Total Sq. Ft.<br>8 Ft. Riser Wall<br>18 Ft. 1 In. High   | 45 Ft. Diameter<br>5/8 Sphere &<br>35 Ft. Diameter<br>5/8 Sphere<br>4636 Total Sq. Ft.        | 40 Ft. Diameter<br>5/8 Sphere<br>1979 Total Sq. Ft.<br>26 Ft. 10 In. High<br>3 Ft. Riser Wall |

**[Order our color catalog and video](#) today to see all of the Timberline Geodesics Dome Home floor plans.**

[| Home](#) | [| Product Information](#) | [| Scrapbook](#) | [| Build A Dome](#) | [| Plans](#) | [| FAQ](#) | [| Additional Information](#) | [| Web Video](#)

# TIMBERLINE GEODESICS

## Frequently Asked Questions

---

### Geodesic Structures

---

- [Who invented the geodesic structure and for what purpose?](#)
  - [Why do geodesic structures save on building materials?](#)
  - [Why do geodesic structures conserve energy for heating and cooling?](#)
  - [I have heard that geodesic structures are very strong, and can withstand earthquakes, tornadoes, and hurricanes... is this true?](#)
  - [Why are geodesic structures so strong?](#)
  - [What other advantages do geodesic structures offer over conventional structures?](#)
- 

### Pre-Planning

---

- [How much does it cost to complete a dome?](#)
  - [What does Timberline provide?](#)
  - [What do I get locally?](#)
  - [How much should I estimate for shipping costs?](#)
  - [Will I have problems with my building department?](#)
  - [At what point should I order Timberline blueprints?](#)
  - [What are the differences between the different types of kits and packages you offer?](#)
  - [What are the price ranges for the different types of Timberline kits and packages?](#)
  - [Can I visit a completed Timberline dome home?](#)
- 

### Architectural Options

---

- [What design advantages do Geodesic homes have?](#)
- [What kind of foundations can be used with the dome kits?](#)
- [What are extension kits? How can they be used?](#)
- [Can I join two domes or join a garage dome to a home? What is involved?](#)
- [What is a riser wall? What is its function?](#)
- [What is a cupola?](#)

- [What options do I have for windows?](#)
- [Can I put skylights wherever I wish?](#)
- [Tell me about Timberline skylight options.](#)
- [Is there a limit to the amount of skylights I can use?](#)
- [What is the difference between your 3/8 sphere domes and your 5/8 sphere domes?](#)
- [Tell me about your ledger system for a second floor.](#)
- [Can I have a loft or second floor in a 3/8 sphere dome?](#)
- [What is the smallest dome diameter you produce? What is the largest?](#)
- [I live in a cold climate, and I need a higher wind and snow load rating. Can I meet this requirement with a dome home?](#)
- [Tell me about custom plans.](#)

---

### Construction

---

- [How do I find a contractor who will work with geodesics?](#)
- [Can I put together the dome shell myself?](#)
- [How long will the dome shell take to put together?](#)
- [What equipment will I need?](#)

---

### Finishing

---

- [What kind of roofing does Timberline recommend?](#)
- [What kind of insulation is recommended?](#)
- [What about venting the insulation to prevent condensation?](#)
- [I live in a cold climate, and I need a high 'R' rating. Can I meet this requirement with a dome?](#)
- [What kinds of interior finishing materials can I use?](#)
- [What kinds of heating, cooling, and air ventilation systems can I use?](#)

---

### Geodesic Structures

---

## Who invented the geodesic structure and for what purpose?

**Buckminster Fuller, a philosopher, mathematician, engineer, historian and poet, invented the geodesic dome. One of Fuller's lifetime quests was to build designs to do more with fewer resources, foreseeing an eventual shortage in housing for humanity's growing population. He observed problems inherent in conventional construction techniques, as opposed to the ease of construction and indigenous**

**strength of natural structures. Interested in creating a structure analogous to nature's own designs, he started to experiment with spherical geometry in the late 1940's. He patented the geodesic dome in 1951. Today geodesic domes are recognized to be the most efficient building systems known.**

[Back to Top](#)

---

## **Why do geodesic structures save on building materials?**

**The primary factor affecting efficient use of materials and energy in a structure is its shape. Think of a soap bubble. A sphere represents the smallest amount of material surface area needed to enclose a given volume of space. A divided sphere becomes one of the most efficient shapes known to enclose a given floor area.**

[Back to Top](#)

---

## **Why do geodesic structures conserve energy for heating and cooling?**

**The answer again lies in the shape of the geodesic structure. The lower the total outside surface area (walls and ceilings) the greater the efficiency in energy use for heating and cooling. A dome has approximately one-third less surface area to the outside than a box-style structure. The amount surface area exposed to the elements has a much greater impact on energy efficiency than insulation values. Additionally, heat loss from the foundation of a home is generally more dependent on perimeter length than floor area. A dome, having a smaller perimeter/square footage ratio than a box-style home, will lose less heat from the foundation.**

**Efficient airflow inside that dome adds to the energy savings further; the curved surface of a dome provides a natural circulation of internal air. Outside the dome, the shape of the dome provides an aerodynamic effect; wind passes over the dome with less resistance. In comparison, a box-style structure provides a flat barrier to wind, creating positive wind pressure with air infiltration on one side, and suction, or negative wind pressure, with internal air exfiltration, on the opposite external surface.**

[Back to Top](#)

---



## **I have heard that geodesic structures are very strong, and can withstand earthquakes and severe storms such as tornadoes and hurricanes... is this true?**

Geodesic structures have shown themselves to endure through severe storms and earthquakes, due to the strength of their design. Geodesic domes have been used successfully for Antarctica radar towers with up to 200mph winds for over 25 years. Geodesic structures also increase options for placement on rugged, steep terrains.

Our domes use 2" x 6" struts to provide a very strong geodesic structure. Additionally, the Timberline Heavy Duty Connector System can be used with 2" x 8", 2" x 10", or 2" x 12" struts to increase strength, insulation capabilities, and snow and wind load capabilities.

[Back to Top](#)

---

## **Why are geodesic structures so strong?**

The nature of the spherical design provides strength because the stress is shared evenly by all the points of the structure. The dome shape allows environmental stress such as movement from an earthquake or wind or stress from snow loading to be evenly distributed throughout the structure. The geometry of the triangle offers additional strength to the dome shape.

[Back to Top](#)

---

## **What other advantages do geodesic structures offer over conventional structures?**

Interior advantages of the dome include greater freedom of floor plan design, cathedral ceilings, evenness of light, heat, and sound distribution. Domes display superior light characteristics as spherical shapes tend to amplify light while rectangular shapes tend to absorb light; in many cases it is actually brighter inside a dome without any interior lights turned on than it is outside. Acoustical advantages include more even sound distribution and approximately 30% less outside noise infiltration.

[Back to Top](#)

---

## **Pre-Planning**

---

## How much does it cost to complete a dome?

As much as we would like to be able to give an exact figure, we can't. There are too many variables in building a house, starting from the type of foundation (a full basement costs more than a concrete slab) to the type of finishes and fixtures. What we have determined is that as a rule of thumb, domes cost from 10% to 15% less than a comparable box type house. In addition, over 90% of our customers erect the dome shell themselves, which saves additional money. We have had customers do all the work themselves and shop carefully for materials and bring in a completed dome for \$60,000. Others have spent several hundred thousand dollars to finish theirs. Click [here](#) to download our latest newsletter with prices.

[Back to Top](#)

---

## What does Timberline provide?

We provide anything that is custom to the dome. This includes the [dome shell kit](#) (dome shell with plywood skin), dome extensions, triangular skylights, cupola kits and the specialized dome hardware such as the ledger hanger. We also provide blueprints for each specific design.

[Back to Top](#)

---

## What do I get locally?

You would purchase "off the shelf" material locally. This would include the roofing material, insulation, lumber for the interior, electrical, plumbing, doors, finishes and fixtures. Pretty much anything you can get at your local building supply store you would get locally. We have found that our customers can get these materials locally for less than they would pay us to bundle and ship. When we ship overseas we provide building materials necessary to complete the house.

[Back to Top](#)

---

## How much should I estimate for shipping costs?

Timberline uses common carriers to ship the dome to your building site. Depending on what you purchase, we use one of two shipping methods.

For Strut Framing Kit or Complete Kit customers we will typically contract with

**a company for a complete truck. The flat rate is by the mile, not weight, thereby allowing you to ship as much as possible without additional shipping cost. In addition, the kit is loaded at our factory and stays on the same truck all the way to your building site. This reduces additional handling and the chance for damage. The rate for this can range from \$1.05 to \$1.55 per mile.**

**If you order a Connector Value Package or additional skylights, we would use a LTL (Less Than Truck Load) carrier. Here the rate is determined by weight as well as the distance to the job site.**

**We ship throughout the United States and world wide. Call us for an exact shipping quotation to your destination.**

[Back to Top](#)

---

## **Will I have problems with my building department?**

**Our floor plans are drawn by licensed California architects and licensed California Structural Engineers. Our plans meet all of the Standard and Uniform Building Codes. In most cases, our blueprints alone are enough to obtain your building permit. Occasionally, you will need to get the plans reviewed by an architect or engineer in your state. A quick call to your local building department will get you your requirements. We can provide plans that are stamped by a licensed engineer in each state.**

[Back to Top](#)

---

## **At what point should I order Timberline blueprints?**

**Once you've received our floor plan portfolio, and have decided on a model. Floor plans will be an aid in getting estimates for contracting services and determining project costs, getting appraisals for financial institutions, and going through the building permit process. The price of floor plans is credited to the price of your dome kit package at the time of order. You may also print out our [Timberline Building Flowchart](#) to get a better understanding of the process.**

[Back to Top](#)

---

## **What are the differences between the different types of kits and packages you offer?**

We offer floor plan package kits for any of our standard floor plans, ranging from small homes up to larger two dome models. For those wishing to create custom plans, we offer all the kits and components singularly as well.

For people wishing to save additional money by purchasing and cutting some of their own lumber locally, we offer two levels of kits, our Strut Framing Kits and our Connector Value Packages. These kits would be priced individually and then added to other desired components for someone wishing to follow one of our standard floor plans. These kits can of course also be used with custom plans.

Complete dome shell kits include everything you need to construct the complete dome shell: detailed assembly instructions; pre-cut, pre-drilled, color-coded 2" x 6" struts, studs, T-blocking, triangular plywood panels, beveled base plates, factory assembled riser walls (not needed for all models); heavy duty connectors; 3 sets of floor plans; nuts and bolts. Our Strut Framing Kits include everything in the complete kit except the triangular plywood panels. Full instructions for cutting your own panels are included.

Our Connector Value Packages include the complete heavy duty steel connector system; nuts and bolts for the connectors; pre-cut pre-drilled color coded 2" x 6" struts; detailed lumber cutting plans and assembly instructions, and samples of studs and T-blocking. Floor plans are not included.

[Back to Top](#)

---

## **What are the price ranges for the different types of Timberline kits and packages?**

Our standard floor plan package kits range from approximately \$11,200 to \$63,200; these packages include a complete dome shell kit, a skylight allowance, and any associated riser walls, extensions kits, ledgers and ledger hardware needed to complete the particular floor plan. This range covers plans for garages, and garage/workshops, smaller homes, mid-size homes, on up to our larger two-dome models.

3/8 sphere domes kits range from approximately \$9,000 up to \$18,000 for Complete Dome Kits; from \$7,000 to \$14,500 for Strut Framing Kits; and from \$5,000 to \$8,300 for Connector Value Package kits.

5/8 sphere domes kits range from approximately \$12,600 up to \$21,600 for Complete Dome Kits; from \$9,900 to \$19,000 for Strut Framing Kits; and from \$5,900 to \$10,200 for Connector Value Package kits.

[Back to Top](#)

---

## **Can I visit a completed Timberline dome home?**

We have a contact list of Timberline home owners who would be happy to show you their homes, included as part of our planning package.

[Back to Top](#)

---

## **Architectural Options**

---

### **What design advantages do Geodesic homes have?**

The dome shell offers many exterior possibilities. Because of the distribution of stresses in the dome shell, up to 50% of the lowest ring of triangles can be removed. A Timberline kit offers five potential openings that can then be replaced by extensions to create specialized rooms. These openings, along with the upper portion of the dome shell being near a true round, make it possible to create ideal placements for solar and view advantage.

Interior advantages of the dome include greater freedom of floor plan design, cathedral ceilings, evenness of light, heat, and sound distribution. In addition, geodesic owners note a less-definable quality of "well-being" inside their dome homes.

[Back to Top](#)

---

### **What kind of foundations can be used with the dome kits?**

The type of foundation best suited for your home is determined by the terrain of the land, the type of soil, and local building codes. The foundation of a dome differs only in shape from that of a conventional house. We offer standard foundation plans for concrete slab, crawl space or full basement.

If you have a unique foundation need, such as the side of a steep hill, or a dome that will have some conventional building extensions, our structural engineers and architects can design a foundation that will work for you.

[Back to Top](#)

---

## **What are extension kits? How can they be used?**

Additional space can be added to the dome's main floors by extending outward from the dome. These extensions can be placed along any of the dome's five natural openings. Extensions can be used to adjoin domes, build entryways, solariums, dining rooms, covered porches, and the like, and to expand existing rooms. Timberline carries extension kits ranging from 4 feet to 16 feet for all of our standard dome sizes.

[Back to Top](#)

---

## **Can I join two domes or join a garage dome to a home? What is involved?**

Two domes or a garage and a dome can be joined using a Timberline extension kit.

[Back to Top](#)

---

## **What is a riser wall? What is its function?**

Dome riser walls are an architectural feature unique to domes. When used, they raise the height of the dome to achieve more usable area in the dome's loft and to increase the potential height for entryways. Riser walls generally range from 3 feet to a maximum of 8 feet high.

[Back to Top](#)

---

## **What is a cupola?**

A cupola is an easy-to-add dome top option that can enhance the natural light and ventilation in your dome. It offers the possibility of a small third floor retreat, with a 360 degree lookout view. You can use a ladder, conventional stairs, or a spiral staircase to gain access to the cupola room.

To add a cupola, we fit threaded pipes into special threaded connectors, raising the cupola portion of the roof up to three feet. The pipes form a near vertical plane at the top of the dome, allowing for the use of conventional windows.

[Back to Top](#)

---

## What options do I have for windows?

There are many choices in window design and selection available for a dome home.

The first option is skylights. Individually or clustered, skylights maximize the usable space in any panel. Triangular skylights maintain the graceful shape and highlight the unique architectural structure of a dome.

Standard, conventional windows can be used in a dome when they are framed upright in the lower sections of a dome, or in a dormer. Conventional windows are generally less expensive than skylights.

A third option are conventional shaped windows that are specially designed for use in a sloping roof. These can be readily adapted for use in a dome home. We are happy to recommend sources of specialty windows to meet your individual needs.

[Back to Top](#)

---

## Tell me about Timberline skylight options.

Timberline offers a full line of top-quality skylights specifically designed for use in our domes. All of our skylights are double-glazed (two bubbles, with an airspace in between, sealed in a two-part aluminum frame) for energy efficiency, and are weather and impact resistant. We offer 11 different triangular skylights along with hexagon and pentagon skylights. The skylights can be either fixed or operable.

[Back to Top](#)

---

## Can I put skylights wherever I wish?

Skylights are the easiest window option to install, as they do not require special construction of dormers. Skylights can be placed on any panel of the dome. Take advantage of special views, or maximize the use of passive solar energy by following the path of the sun.

[Back to Top](#)

---

## **Is there a limit to the amount of skylights I can use?**

Timberline domes are engineered to accommodate an unlimited number of skylights. Check your local building requirements for requirements on how much of your structure can be glazed and if there are resulting insulation requirements.

[Back to Top](#)

---

## **What is the difference between your 3/8 sphere domes and your 5/8 sphere domes?**

These fractions refer to the sphere division of the dome. A 3/8 sphere dome is 3/8 of a full sphere of the dome's diameter and a 5/8 sphere dome uses 5/8 of a full sphere of the dome's diameter. Consequently, a 3/8 sphere dome has a lower profile than a 5/8 sphere dome of the same diameter.

A 5/8 sphere dome easily accommodates a second floor or loft. Using our patented Ledger Hanger system, the ledgers for a second floor or loft can be suspended from the horizontal plane of the sphere, with no need for additional load bearing walls or supports.

[Back to Top](#)

---

## **Tell me about your ledger system for a second floor or loft.**

Our patented Ledger Hanger Hardware system is fully engineered and patented for use in any 5/8 sphere Timberline dome. The Ledger Hanger Hardware mounts into the existing dome connectors to make the addition of a self-supporting second floor quick and easy. The design actually enhances the strength of the dome structure, as well as saving space and lending flexibility to the floor plan design.

Depending on the desired height of first floor ceilings, second floor joists can either sit on top of ledger beams, or they can be mounted flush by using joist hangers. Ledgers can be left exposed to take advantage of the beauty of the wood-grained beams.

[Back to Top](#)

---



## **Can I have a loft or second floor in a 3/8 sphere dome?**

**Yes, you can have a loft or second floor in a 3/8 sphere dome, using load bearing walls.**

[Back to Top](#)

---

## **What is the smallest dome diameter you produce? What is the largest?**

**Our standard dome diameters are 24 ft., 30ft., 35 ft, 40 ft., and 45 ft., divided at either a 3/8 sphere or a 5/8 sphere. These sizes are used in our standard floor plans and are also available for use with custom floor plans.**

**On a case basis, we also have engineering to build as small as an 18ft diameter dome. For larger dome uses, we offer up to 100ft, in 3/8, 1/2 or 5/8 sphere divisions.**

[Back to Top](#)

---

## **I live in a cold climate, and I need a higher wind and snow load rating. Can I meet this requirement with a dome home?**

**Our standard dome shell uses 2" x 6" lumber. Our Timberline Heavy Duty Connector System can be used with 2" x 8", 2" x 10", or 2" x 12" lumber to increase snow and wind load capabilities. This also allows for more insulation and higher "R" values in extremely cold climates.**

[Back to Top](#)

---

## **Tell me about custom plans.**

**We work with a licensed architect who has spent many years designing domes. If you are interested in custom plans, send in your sketches along with \$25.00 and our architect will critique your ideas and give you a price to draw a set of plans. You will work directly with the architect on your plans. First, he will do a preliminary drawing from your sketches and his ideas. After you review that, the design will be further refined. When you agree on the design he will finish the set with foundation, framing, and roof plans. There will also be sections and elevations in addition to door and window schedules. The plans will be stamped**

by him with a California Architect stamp.

[Back to Top](#)

---

## Construction

---

### **How do I find a contractor who will work with geodesics?**

Any licensed general contractor should be able to do the work.

[Back to Top](#)

---

### **Can I put together the dome shell myself?**

Yes. All wooden components of a Timberline Dome are pre-cut and pre-drilled to exacting specifications, and color-coded to make it easy for unskilled people to assemble them with precision and confidence. The largest piece for a 45' diameter dome is a 10ft. long 2" x 6", which is easily handled by one person. Over 90% of our customers erect their Timberline dome shell themselves.

[Back to Top](#)

---

### **How long will the dome shell take to put together?**

Our largest standard dome (45 ft. diameter, 5/8 sphere) can be assembled by 3 people in 5 days.

[Back to Top](#)

---

### **What equipment will I need?**

The only tools you will need are socket wrenches, hammers, ladders, rolling scaffolding (desirable) and nail guns (desirable). Timberline Domes are completely free-standing during construction. No shoring up is needed. No special tools or expensive equipment, like cranes or forklifts, are necessary to assemble a Timberline Dome.

[Back to Top](#)

---

## Finishing

---

### What kind of roofing does Timberline recommend?

Asphalt shingles are the most common roofing material as it is easy to work with and very attractive. It comes in a variety of colors and textures and is affordable. Other options include wood shingles, metal shingles and spray on roofs.

[Back to Top](#)

---

### What kind of insulation is recommended?

Standard insulation material is used. The most common choices are fiberglass or rigid foam. Timberline's 2" x 6" framing members allow for 5 1/2" of insulation, sufficient for most climatic conditions. Other options include spray-in expanding foam which is very effective.

[Back to Top](#)

---

### What about venting the insulation to prevent condensation?

Condensation can form in a cavity when there is air in that cavity. Moisture enters on the air and if there is an air space the air must be circulated to prevent moisture from building up. That is why attics are vented in box type houses. However, if the cavity is filled with a material that displaces the air, condensation is not a problem. That is why vertical walls on box type houses are not vented. They are filled with insulation.

The same applies to our domes. The walls are 2" x 6" and are filled with insulation. By using an expanding spray in foam insulation, it seals up the dome so well that no interior vapor barrier is needed.

If you would like to have a shell larger than 2" x 6" and leave an airspace, we offer venting details by notching the studs to allow air flow.

[Back to Top](#)

---

## **I live in a cold climate, and I need a high 'R' rating. Can I meet this requirement with a dome?**

The Timberline Heavy Duty Connector System can be used with 2" x 8", 2" x 10", or 2" x 12" lumber to allow for more insulation and higher "R" values in extremely cold climates. This also increases snow and wind load capabilities.

[Back to Top](#)

---

## **What kinds of interior finishing materials can I use?**

You can use any standard interior finishing material such as drywall or wood paneling. Studs are 16" on center in each triangle, for easy drywall attachment.

[Back to Top](#)

---

## **What kinds of heating, cooling, and air ventilation systems can I use?**

Domes employ traditional heat and air conditioning, whether it be forced air, electric baseboard, or in-floor radiant heat. The plumbing, mechanical and electrical systems of a geodesic dome are no different than that of a conventional structure.

[Back to Top](#)

---

[Home](#) | [Product Information](#) | [Scrapbook](#) | [Build A Dome](#) | [Plans](#) | [FAQ](#) | [Additional Information](#) | [Web Video](#) |

**Copyright © 1999 [Timberline Manufacturing, Inc.]. All rights reserved.  
Revised: April 05, 2004 .**

# TIMBERLINE GEODESICS

## Additional Information

**Timberline Geodesics**  
**2015 Blake Street**  
**Berkeley, CA 94704**  
**1-800-DOME-HOME**  
**1-800-366-3466**  
**(510) 849-4481**  
**FAX (510) 849-3265**

*Or contact us at our E-Mail addresses:*

General questions:

[info@domehome.com](mailto:info@domehome.com)

Sales status or inquiries:

[sales@domehome.com](mailto:sales@domehome.com)

President Robert Singer:

[rsinger@domehome.com](mailto:rsinger@domehome.com)



QuickTime video: [Robert Singer](#) 663KB

## [Order Form for Catalog and Video](#)

[Home](#) | [Product Information](#) | [Scrapbook](#) | [Build A Dome](#) | [Plans](#) | [FAQ](#) | [Additional Information](#) | [Web Video](#)

# TIMBERLINE GEODESICS

## Web Video



Robert Singer  
QuickTime Movie  
663KB



Custom Plan Walk-Through  
QuickTime Movie  
900KB

To download a QuickTime plug-in, click [here](#).

[Order our color catalog or video](#) today to see all of the Timberline Geodesics Dome Home floor plans.

| [Home](#) | [Product Information](#) | [Scrapbook](#) | [Build A Dome](#) | [Plans](#) | [FAQ](#) | [Additional Information](#) | [Web Video](#)

# TIMBERLINE GEODESICS

## *New Plans*

We are now offering two new exciting home plans, the Double Mulberry and the Poplar. Click on the image for a close up view.

Double Mulberry

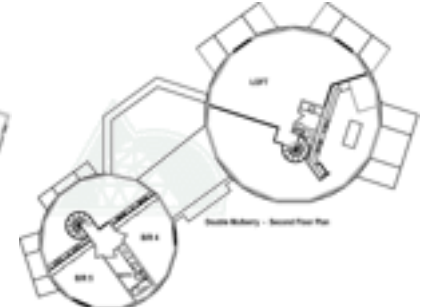

Poplar

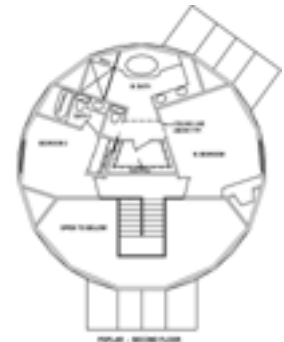

**Call 1-800-DOMEHOME (1-800-366-3466)  
To order your set of plans**

[RETURN TO PLANS PAGE](#)

| [Home](#) | [Product Information](#) | [Scrapbook](#) | [Build A Dome](#) | [Plans](#) | [FAQ](#) | [Additional Information](#) | [Web Video](#)

# TIMBERLINE GEODESICS

Planning Package & DVD

Planning Package & Video

Planning Package

Planning Package & DVD – Canada

Planning Package & Video – Canada

Planning Package – Canada

Planning Package & DVD – Overseas

Planning Package & Video – Overseas

Planning Package – Overseas



Show Order

Info

Privacy Policy

**Our color Planning Package includes the full color catalog, technical information, a portfolio of our exclusive Floor Plans, Assembly Manual and Product Catalog with prices and product descriptions.**

**Video: "Explore The Great Indoors"**  
The video is 25 minutes and shows a Timberline dome being assembled, highlights our product line and has a tour of finished dome as well. There is also a segment from the HGTV series Dream Builders highlighting Timberline domes.

**All orders are sent over a secure server.**

To contact Timberline Geodesics call  
1-800-DOME-HOME (1-800-366-3466) or  
1-510-849-4481, write to us at 2015 Blake Street,  
Berkeley, CA 94704

[Home](#) | [Product Information](#) | [Scrapbook](#) | [Build A Dome](#) | [Plans](#) | [FAQ](#) |  
[Additional Information](#) | [Web Video](#) |





---

## Dan & Nancy's dome home in eastern Pennsylvania.

---



We built a geodesic dome home using [Timberline Geodesic's](#) "Hickory" kit, with a few minor modifications.



Lilliput enjoys the sun.

*You can click on any photo you see to view a larger version of the picture.*

*Clicking on the golf-ball-looking thingie at the upper right on any page will get you back to this page.*

*Clicking on a **more** icon opens a window that will discuss in greater detail the topic under consideration.*

---

The site's organized along these sequential steps in building the house - excavation, foundation, first floor deck, kit construction, roofing, septic system, utilities, and finish work.

---

---

I'm working on a new [cost to build](#) page, which will give a cost breakdown for all the different elements of the project.

---

[Excavation](#) | [Foundation](#) | [First floor deck](#) | [Kit construction](#) | [Roof](#) | [Septic](#) | [Utilities](#) | [Finish](#) | [contact](#)

One of the tricky things is to get all the paperwork & contractors organized so things happen in the proper sequence. [more](#)

The easy (and more expensive) way to go about this is to simply hire a builder to take care of everything for you, or you can act as your own general contractor and hire all the workers yourself, or, if you're handy and have a LOT of free time, you can do all the work yourself. I opted to go the second route, and save only the dome construction and a few other easy tasks for myself. We were lucky in that we already knew, and trusted, just about everyone else we needed to finish the job.

We moved into the house in May, 2001, although there's still a little trim & spackle to finish up (it may remain unfinished for a little while...). My [music studio](#) downstairs is up and running, and we've started thinking about various other building projects. I miss building! Maybe an addition in the spring?



# TIMBERLINE GEODESICS

## To Build A Dome



[RETURN TO BUILD A DOME PAGE](#)

[Home](#) | [Product Information](#) | [Scrapbook](#) | [Build A Dome](#) | [Plans](#) | [FAQ](#) | [Additional Information](#) | [Web Video](#)

# TIMBERLINE GEODESICS

## To Build A Dome



[RETURN TO BUILD A DOME PAGE](#)

| [Home](#) | [Product Information](#) | [Scrapbook](#) | [Build A Dome](#) | [Plans](#) | [FAQ](#) | [Additional Information](#) | [Web Video](#)

# TIMBERLINE GEODESICS

## To Build A Dome



[RETURN TO BUILD A DOME PAGE](#)

| [Home](#) | [Product Information](#) | [Scrapbook](#) | [Build A Dome](#) | [Plans](#) | [FAQ](#) | [Additional Information](#) | [Web Video](#)

# TIMBERLINE GEODESICS

## To Build A Dome



[RETURN TO BUILD A DOME PAGE](#)

| [Home](#) | [Product Information](#) | [Scrapbook](#) | [Build A Dome](#) | [Plans](#) | [FAQ](#) | [Additional Information](#) | [Web Video](#)

# TIMBERLINE GEODESICS

## To Build A Dome



[RETURN TO BUILD A DOME PAGE](#)

[Home](#) | [Product Information](#) | [Scrapbook](#) | [Build A Dome](#) | [Plans](#) | [FAQ](#) | [Additional Information](#) | [Web Video](#)

# TIMBERLINE GEODESICS



[RETURN TO BUILD A DOME PAGE](#)

| [Home](#) | [Product Information](#) | [Scrapbook](#) | [Build A Dome](#) | [Plans](#) | [FAQ](#) | [Additional Information](#) | [Web Video](#)

# TIMBERLINE GEODESICS

## Timberline Geodesics Building Flow Chart

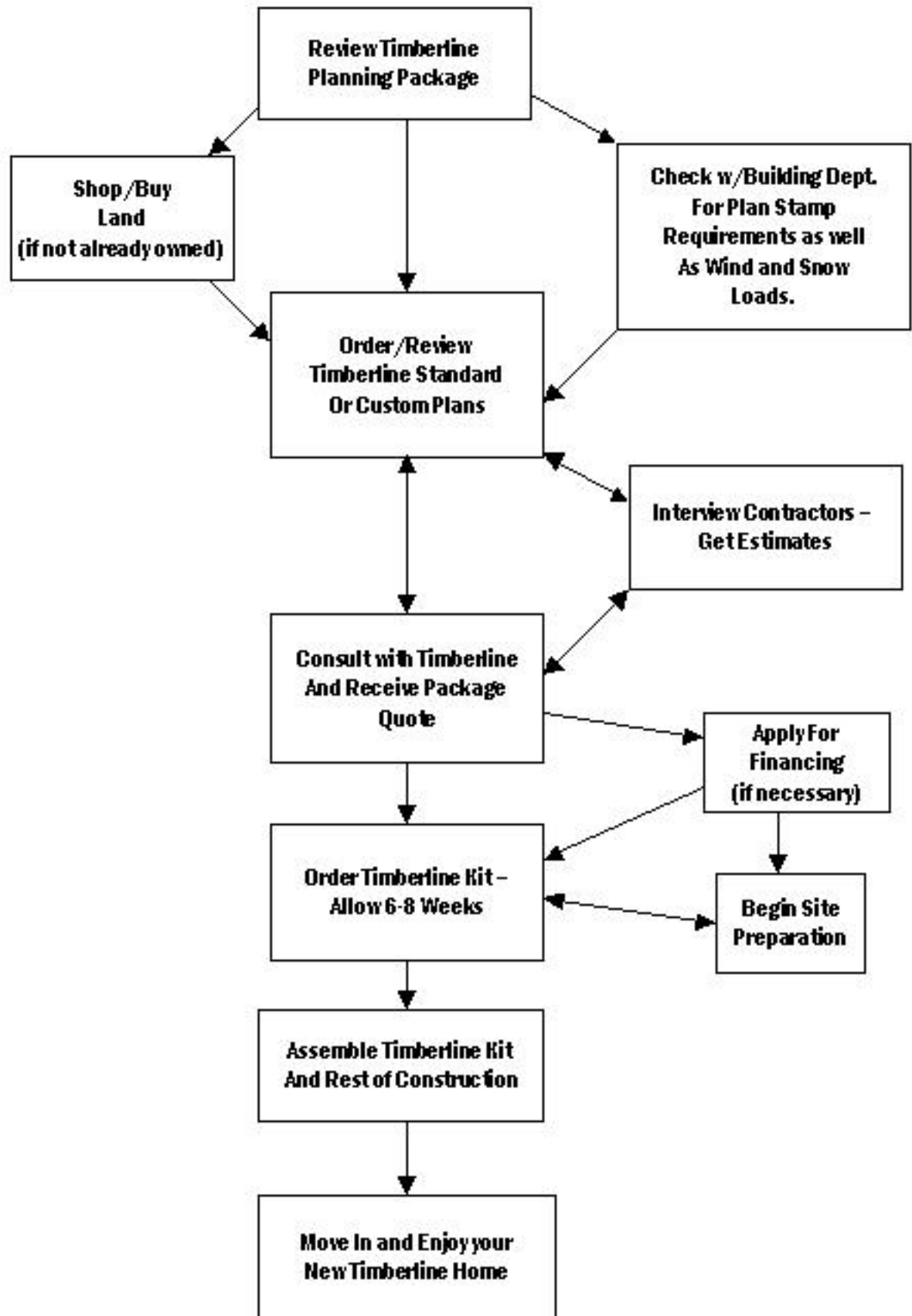



# Call Us At 1-800-DOME-HOME (1-800-366-3466) With Any Questions

[Home](#) | [Product Information](#) | [Scrapbook](#) | [Build A Dome](#) | [Plans](#) | [FAQ](#) | [Additional Information](#) | [Web Video](#)



# TIMBERLINE GEODESICS

 Product Information

 Scrapbook

 Build A Dome

 Plans

 FAQ

 Additional Information

 Web Videos

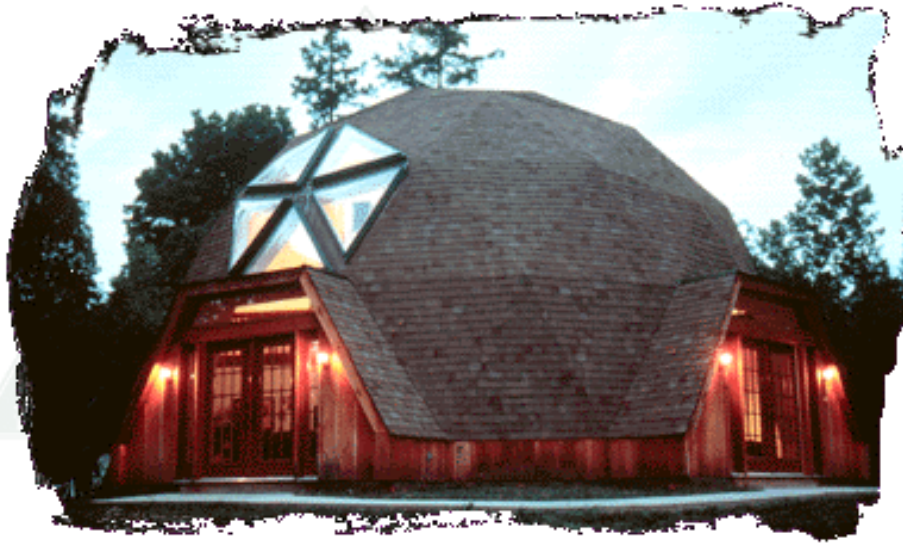

*On Line*

For more than 30 years, we've been dedicated to designing Timberline Geodesic Dome packages that make it easy, practical and affordable for people to construct their own homes.

*New Plans*  
*Click Here*

[To order our color catalog or video tape](#)



To contact Timberline Geodesics call 1-800-DOME-HOME (1-800-366-3466) or write to us at 2015 Blake Street, Berkeley, CA 94704

[Home](#) | [Product Information](#) | [Scrapbook](#) | [Build A Dome](#) | [Plans](#) | [FAQ](#) | [Additional Information](#) | [Web Video](#) |

Web page design and maintenance by [Media Masters](#)

© Copyright 2004. Timberline Manufacturing Inc. All rights reserved.  
Timberline Geodesics and the Timberline Logo are Registered Trademarks of Timberline Manufacturing Inc.

# TIMBERLINE GEODESICS

## Birch - Interior Photo #4

This view is from the first floor looking towards the stairs to the second floor.

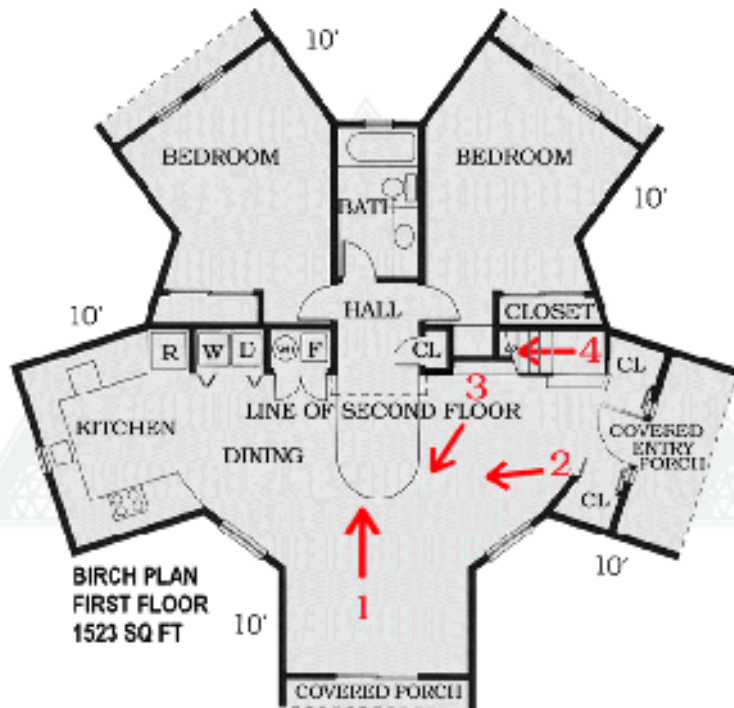

[RETURN TO PLANS PAGE](#)

[Home](#) | [Product Information](#) | [Scrapbook](#) | [Build A Dome](#) | [Plans](#) | [FAQ](#) | [Additional Information](#) | [Web Video](#)

# TIMBERLINE GEODESICS

## Birch - Interior Photo #3

This view is from the first floor looking towards the window .

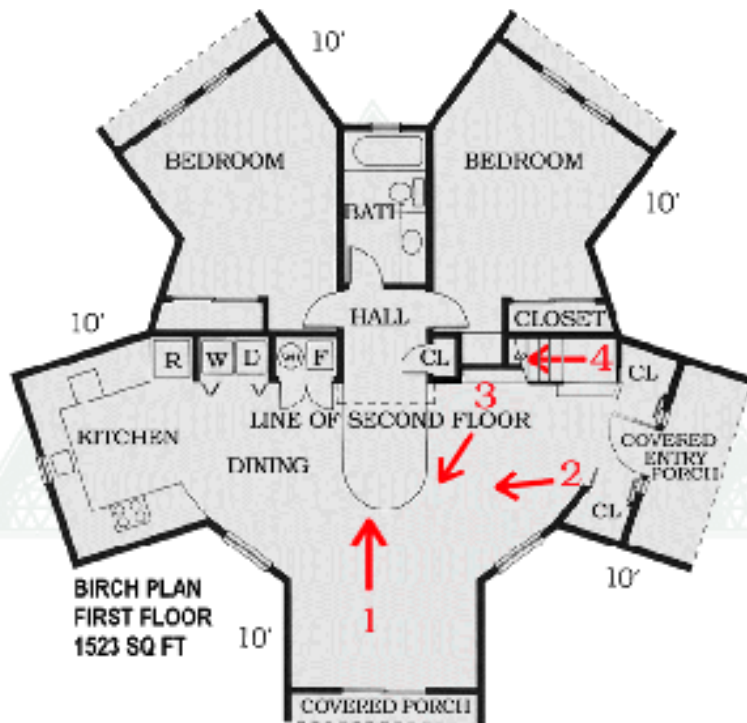

[RETURN TO PLANS PAGE](#)

| [Home](#) | [Product Information](#) | [Scrapbook](#) | [Build A Dome](#) | [Plans](#) | [FAQ](#) | [Additional Information](#) | [Web Video](#)

# TIMBERLINE GEODESICS

## Birch - Interior Photo #2

This view is from the first floor looking from the covered entry porch towards the dining area and kitchen.

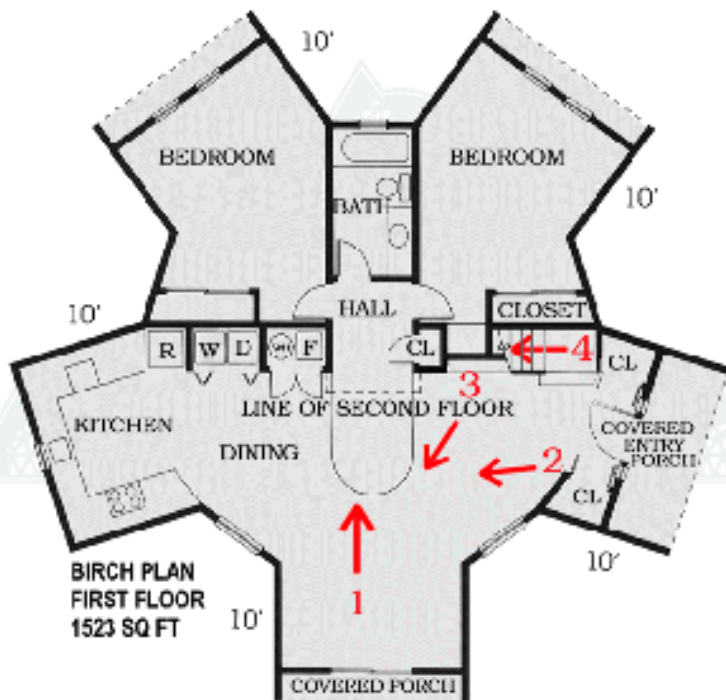

[RETURN TO PLANS PAGE](#)

[Home](#) | [Product Information](#) | [Scrapbook](#) | [Build A Dome](#) | [Plans](#) | [FAQ](#) | [Additional Information](#) | [Web Video](#)

# TIMBERLINE GEODESICS

## Birch - Interior Photo #1

This view is from the first floor looking from the covered porch towards the hall and second story.

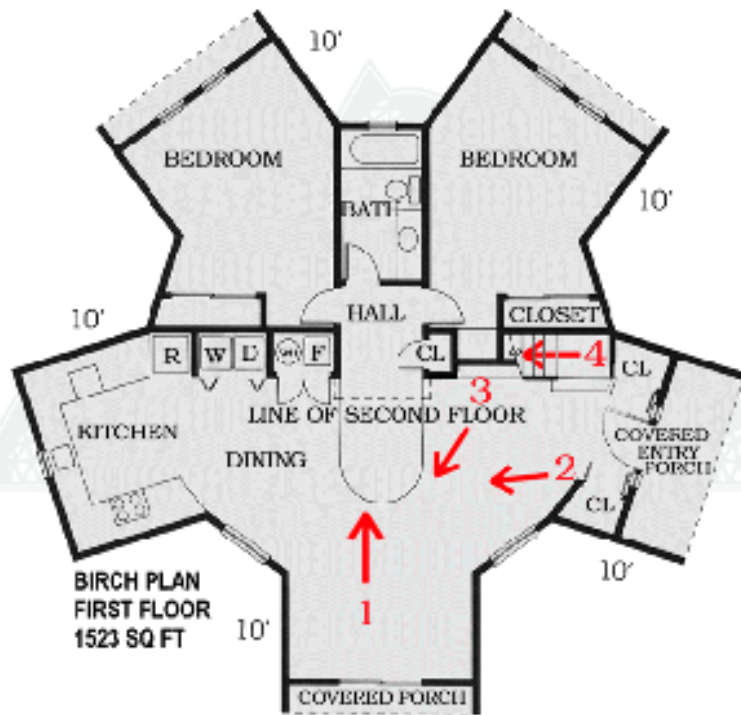

[RETURN TO PLANS PAGE](#)

[Home](#) | [Product Information](#) | [Scrapbook](#) | [Build A Dome](#) | [Plans](#) | [FAQ](#) | [Additional Information](#) | [Web Video](#)

# TIMBERLINE GEODESICS

## Birch - Interior Photo #5

This view is from the second floor looking towards the downstairs.

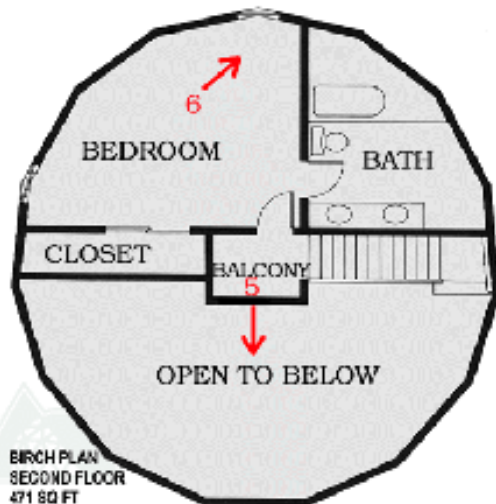

[RETURN TO PLANS PAGE](#)

[Home](#) | [Product Information](#) | [Scrapbook](#) | [Build A Dome](#) | [Plans](#) | [FAQ](#) | [Additional Information](#) | [Web Video](#)

# TIMBERLINE GEODESICS

## Birch - Interior Photo #6

This view is from the second floor Master Suite looking towards the window.

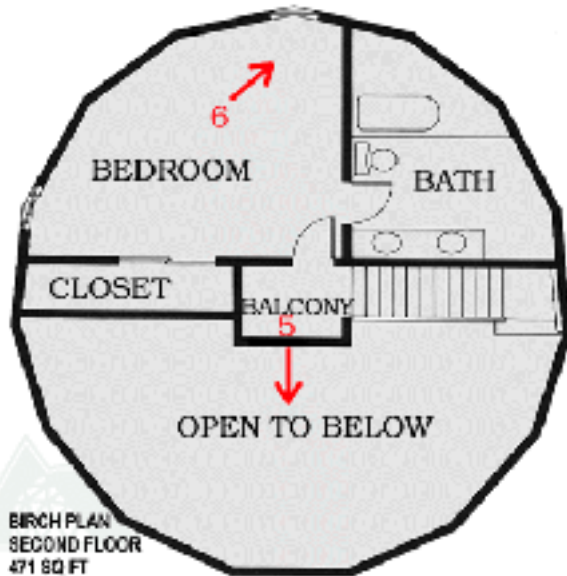

[RETURN TO PLANS PAGE](#)

| [Home](#) | [Product Information](#) | [Scrapbook](#) | [Build A Dome](#) | [Plans](#) | [FAQ](#) | [Additional Information](#) | [Web Video](#)



# TIMBERLINE GEODESICS

## NEW - Two Car Garage



**Our new Two Car Garage offers an affordable option for a separate garage for your dome home.**

[Home](#) | [Product Information](#) | [Scrapbook](#) | [Build A Dome](#) | [Plans](#) | [FAQ](#) | [Additional Information](#) | [Web Video](#)

# TIMBERLINE GEODESICS

## The 2004 [Timberline Express](#) Newsletter Is Here

Download it by clicking [here](#) and read about our *Great Sale Prices* plus:

- Our Biggest Discounts and Best Packages Ever!
- New Value Pricing Packages Offer More Options
- Great Sale Prices and Special Discounts on Cupolas and Garage Kits

You may also download our latest [Product Catalog](#) or view the [Building Flow Chart](#).

The file is in a pdf format and you will need a copy of the Adobe Acrobat Reader to read it and print it out. Download the Timberline Express above. If you need a copy of the Adobe Acrobat Reader, follow the link below to download.

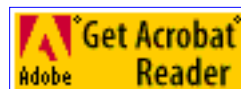

[Home](#) | [Product Information](#) | [Scrapbook](#) | [Build A Dome](#) | [Plans](#) | [FAQ](#) | [Additional Information](#) | [Web Video](#)

# TIMBERLINE GEODESICS

## *New Plans*

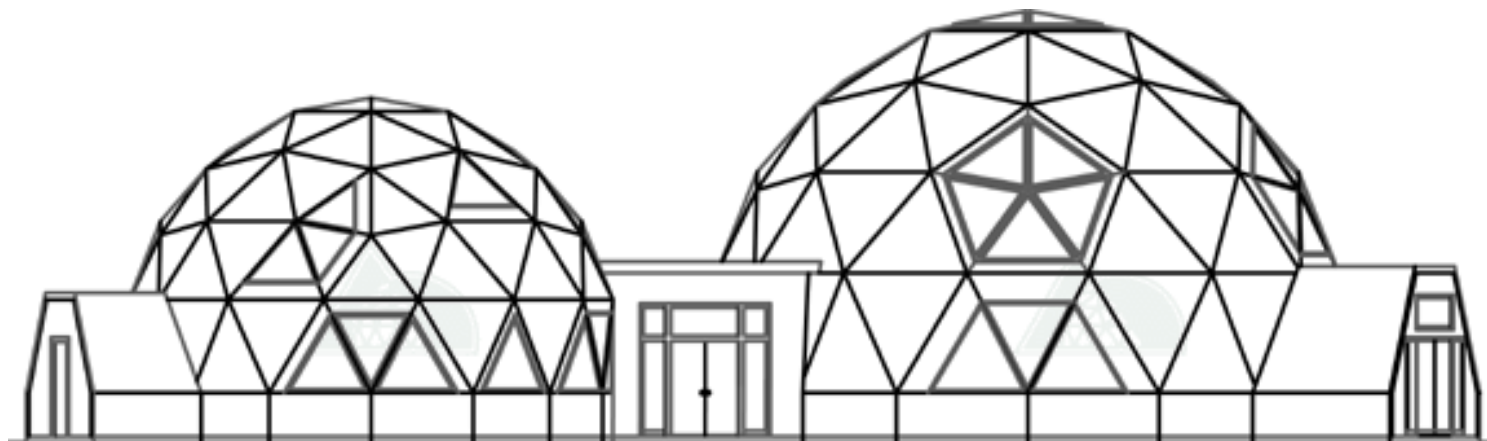

**DOUBLE MULBERRY - ENTRY ELEVATION**

45' 5/8 Sphere & 35' 5/8 Sphere

Extensions:

45' Dome - Two 8' Extensions & One 10' Extension

35' Dome - One 4' Extension & One 8' Extension

Total Square Feet: 4636

First Floor 3400

Second Floor 1236

**Call 1-800-DOMEHOME (1-800-366-3466)**

**To order your set of plans**

[RETURN TO NEW PLANS PAGE](#)

| [Home](#) | [Product Information](#) | [Scrapbook](#) | [Build A Dome](#) | [Plans](#) | [FAQ](#) | [Additional Information](#) | [Web Video](#)

# TIMBERLINE GEODESICS

## *New Plans*

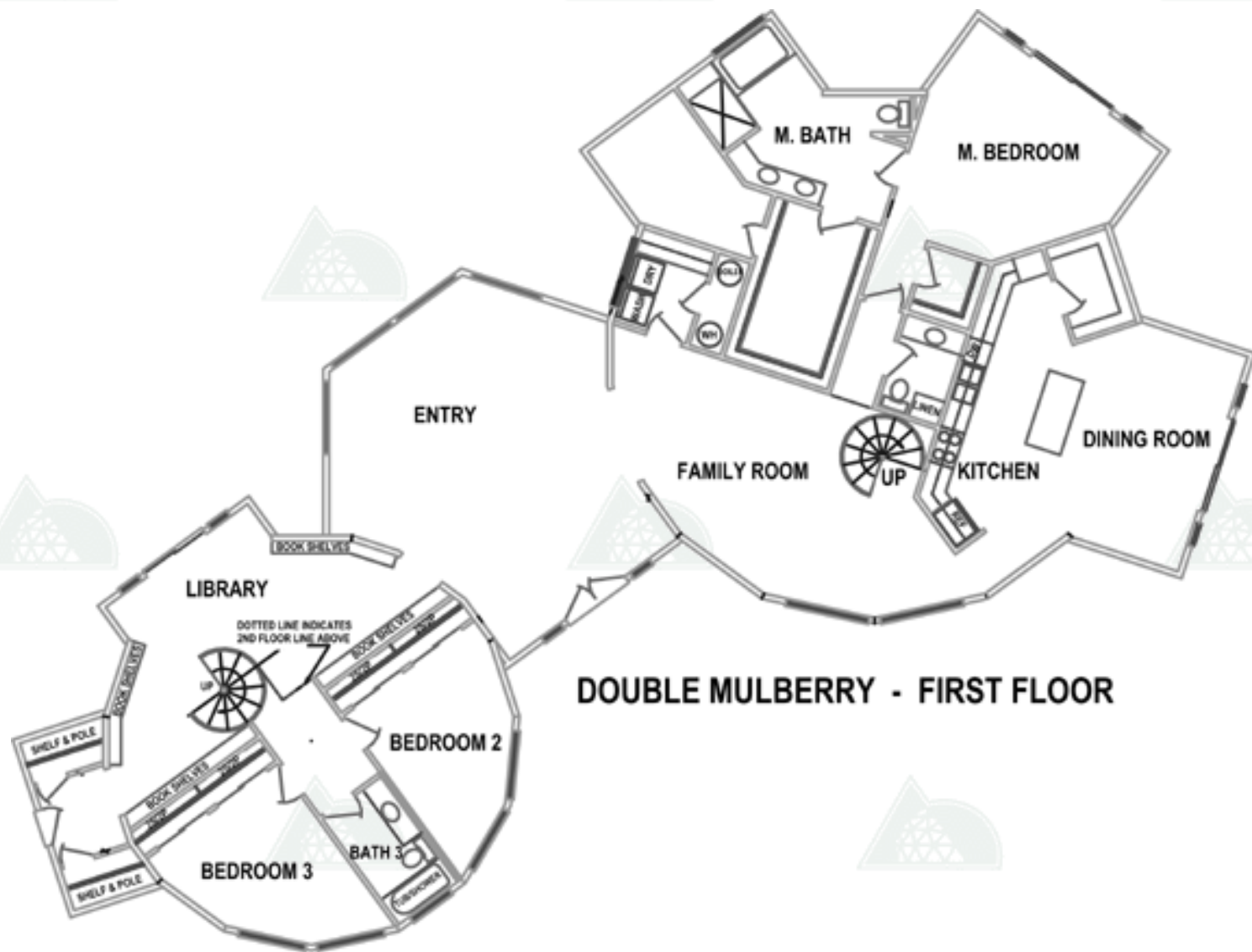

**DOUBLE MULBERRY - FIRST FLOOR**

**Call 1-800-DOMEHOME (1-800-366-3466)  
To order your set of plans**

[RETURN TO NEW PLANS PAGE](#)

| [Home](#) | [Product Information](#) | [Scrapbook](#) | [Build A Dome](#) | [Plans](#) | [FAQ](#) | [Additional Information](#) | [Web Video](#)

# TIMBERLINE GEODESICS

## *New Plans*

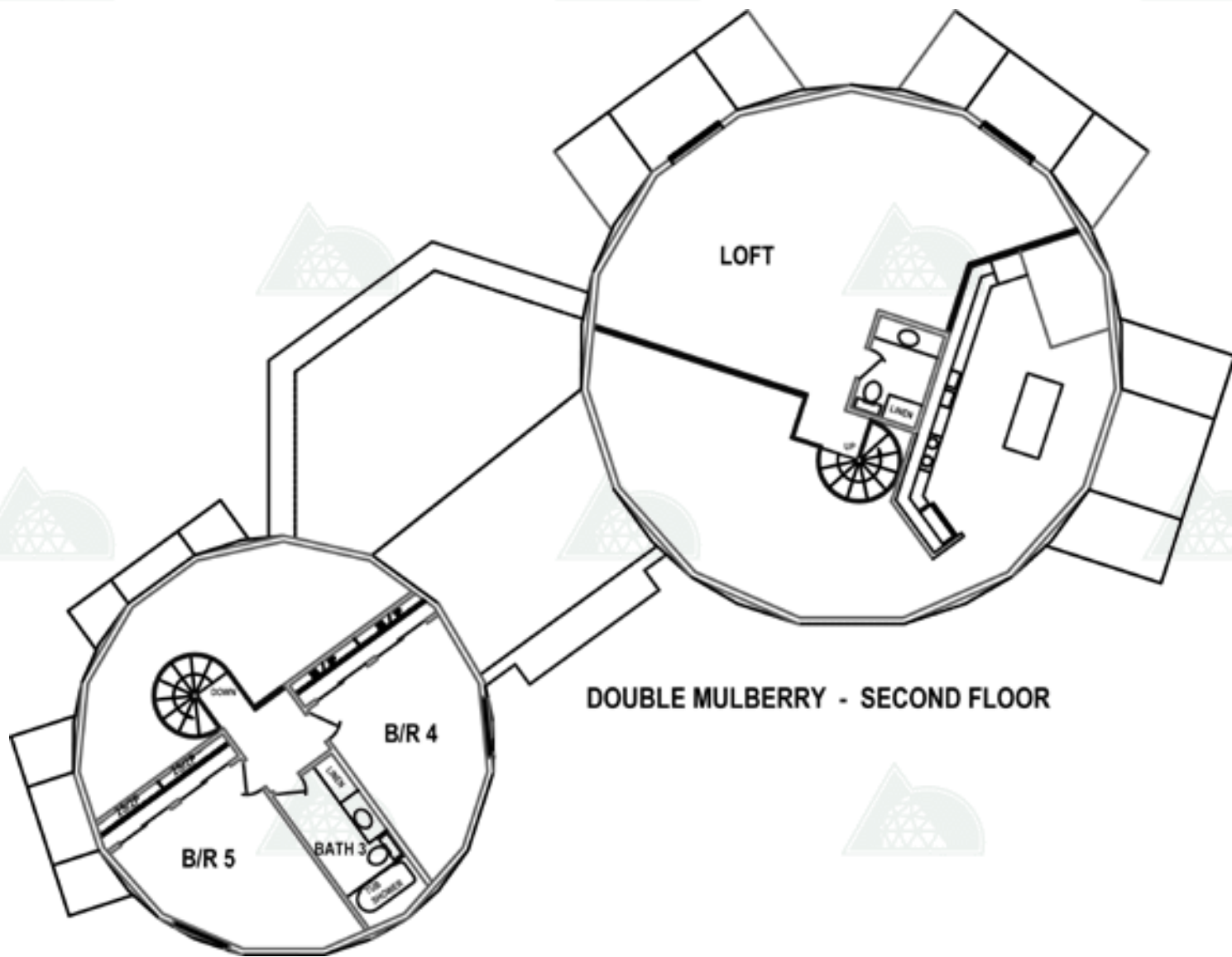

**Call 1-800-DOMEHOME (1-800-366-3466)**

**To order your set of plans**

[RETURN TO NEW PLANS PAGE](#)

[Home](#) | [Product Information](#) | [Scrapbook](#) | [Build A Dome](#) | [Plans](#) | [FAQ](#) | [Additional Information](#) | [Web Video](#)

# TIMBERLINE GEODESICS

## *New Plans*

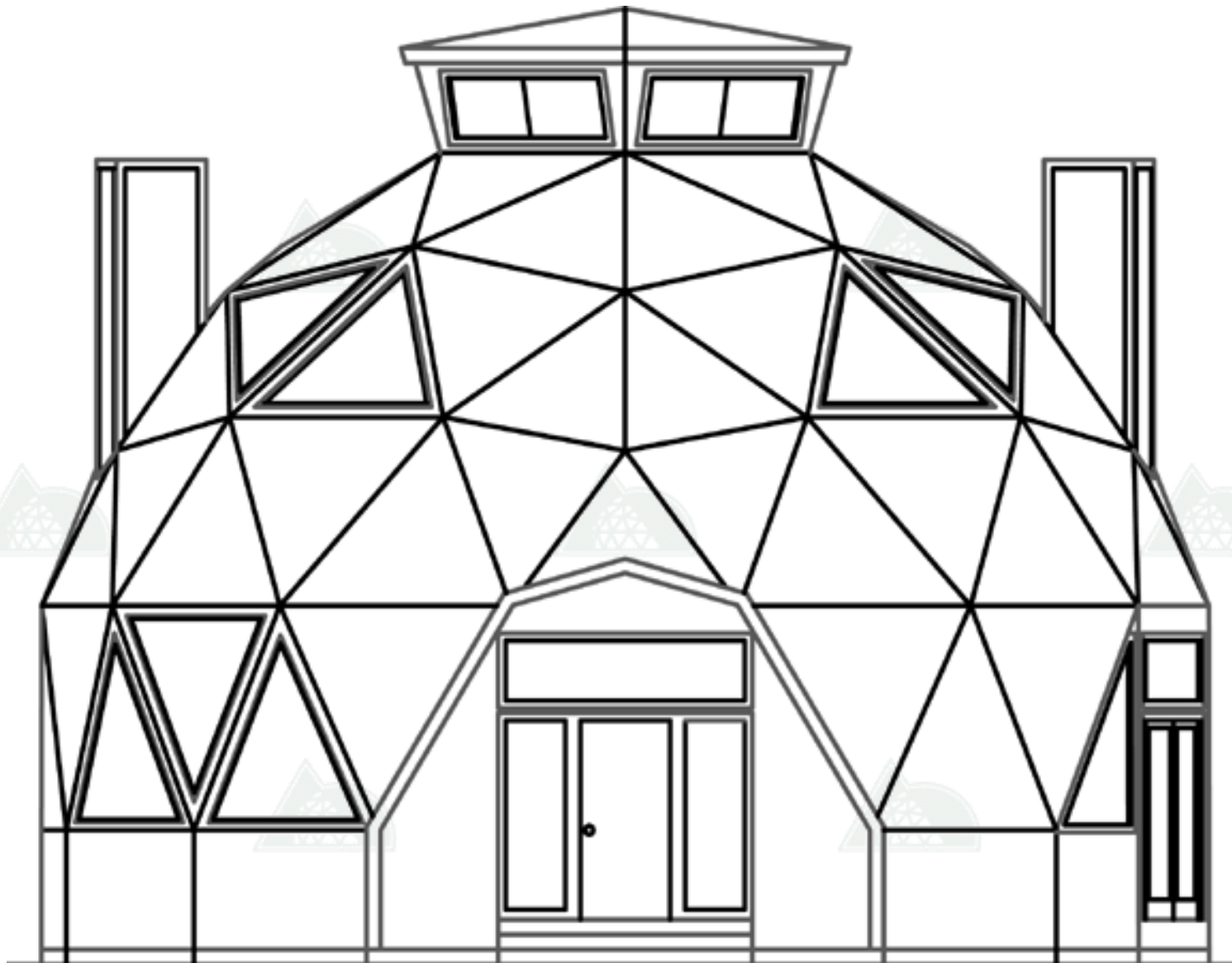

**POPLAR - ENTRY ELEVATION**

40' 5/8 Sphere

Extensions: One 8' Extension & One 12' Extension

Crawl Space Foundation

Total Square Ft: 1979

First Floor: 1365

Second Floor: 614

**Call 1-800-DOMEHOME (1-800-366-3466)**

**To order your set of plans**

[RETURN TO NEW PLANS PAGE](#)

| [Home](#) | [Product Information](#) | [Scrapbook](#) | [Build A Dome](#) | [Plans](#) | [FAQ](#) | [Additional Information](#) | [Web Video](#)



# TIMBERLINE GEODESICS

## *New Plans*

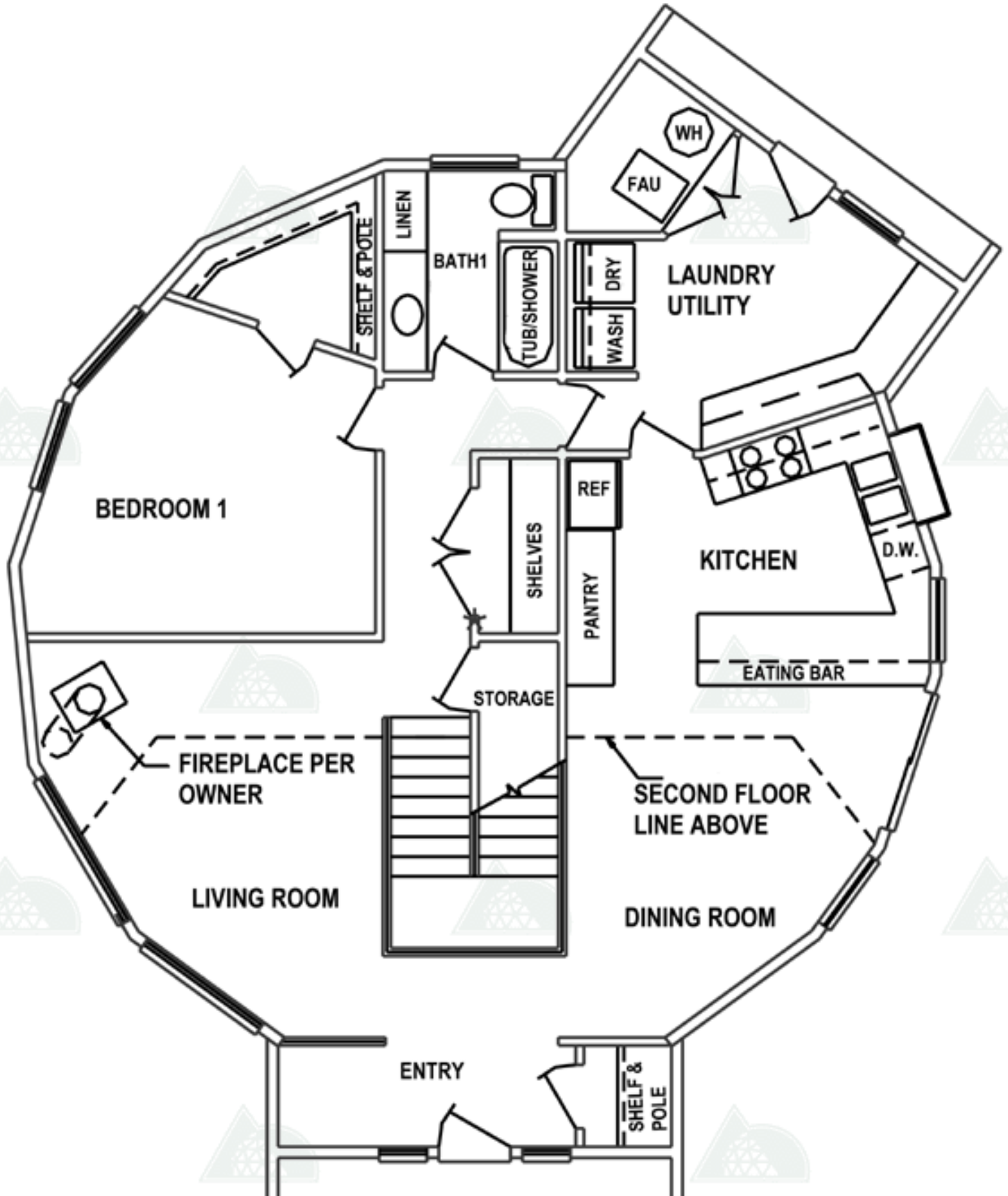





## POPLAR - FIRST FLOOR

**Call 1-800-DOMEHOME (1-800-366-3466)  
To order your set of plans**

[RETURN TO NEW PLANS PAGE](#)

| [Home](#) | [Product Information](#) | [Scrapbook](#) | [Build A Dome](#) | [Plans](#) | [FAQ](#) | [Additional Information](#) | [Web Video](#)

# TIMBERLINE GEODESICS

## *New Plans*

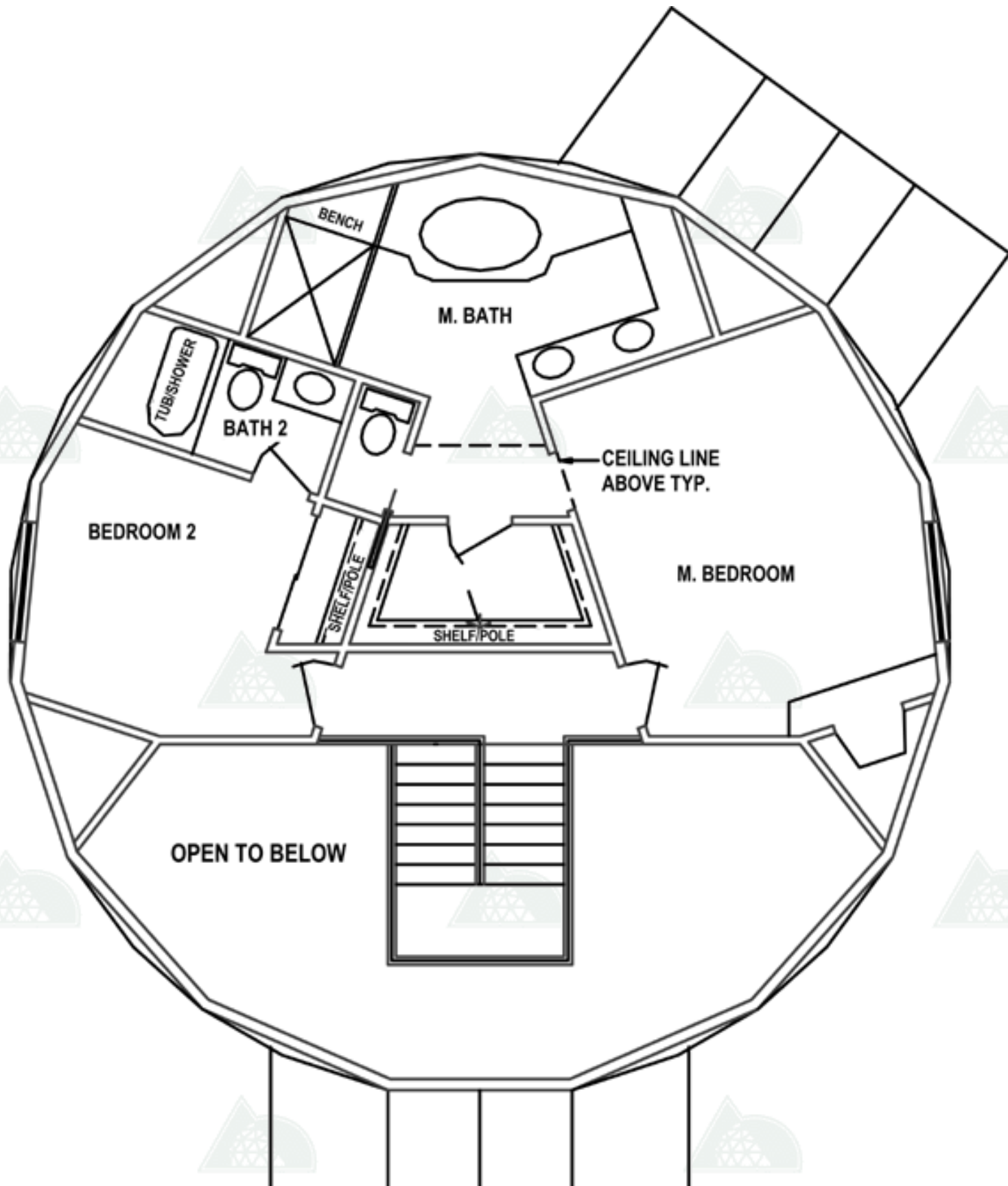



## POPLAR - SECOND FLOOR

**Call 1-800-DOMEHOME (1-800-366-3466)  
To order your set of plans**

[RETURN TO NEW PLANS PAGE](#)

| [Home](#) | [Product Information](#) | [Scrapbook](#) | [Build A Dome](#) | [Plans](#) | [FAQ](#) | [Additional Information](#) | [Web Video](#)

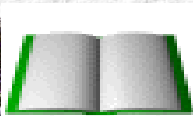

[Interior](#)

[Exterior](#)

[Residential](#)

[Promotional](#)

[Commercial](#)

[Financing](#)

[Home](#)

[statistics](#)

[Unique Uses](#)

[Services](#)

[Floor Plans](#)

[Shipping](#)

[Testimonials](#)



---

Welcome to the most complete collection of geodesic dome information on the internet today. From this site you can access information on residential, both single family and multi family, commercial, and institutional domes of varying sizes from 23' to 134' in diameter.

---

The geodesic dome has long been considered one of the finest construction developments of this century. Strong, efficient, yet attractive it has been the choice of thousands of builders worldwide. Whether near the arctic circle or in an urban neighborhood, its unique shape and its adaptability make it the only choice for the educated home builder!

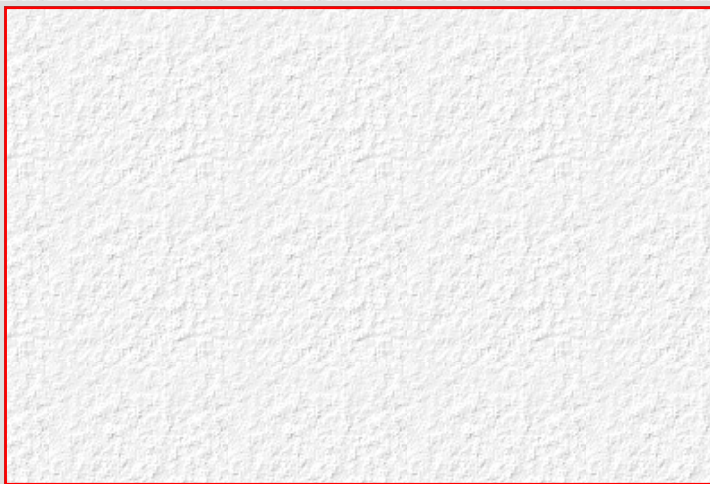

The geodesic dome as a residence affords you, the home owner, multiple options to create the exact exterior appearance that you desire. With a complete line of prefabricated exterior components, you have the ability to efficiently alter the appearance of your residence by adding a basement, riser wall, extension, dormer, or cupola.

**There is only one building available today to the average home owner that will allow the creation of interiors like this.**

**With the absence of need for interior support, these types of vaulted living/dining areas are easily created in every dome.**

---

**Within this site, we at Lydick's Domes Unlimited hope to convey one simple message--You really can have what you want. There is no other housing available today that gives you all of the options that a geodesic dome does.**

**The dome manufacturer that we have chosen, Oregon Dome Inc., is simply the finest manufacturer of dome components in the world today. They offer the most complete line of products and have the finest design services available.**

**We provide the best support team you could ever choose to work with. Couple that with the experience that we add, 17 yrs. of dome sales and service, and you have one big dynamic enterprise with the ability to provide you with services and products that cannot be matched anywhere!**

Please browse the remainder of our site by using the links in the table of contents.

If you have specific questions, or need [promotional materials](#), please feel free to E-mail Lydick's Domes Unlimited: [domeking@nauticom.net](mailto:domeking@nauticom.net) or call/fax us: (724) 353-0098.

**AOL.**  
**Find a Job**

Salaried  
Hourly  
Temporary

Welcome, Guest!

[Main](#) >> Hobbies & Interests



## Hobbies & Interests

Find homepages in Hobbies & Interests only.

### Explore Hobbies & Interests

- **AOL Journals: Hobbies & Interests**  
[Hobbies & Interests Journals](#), [Photo Journals](#), [Technology Journals](#)
- **Active Interests**  
[Boating & Sailing](#), [Bodybuilding](#), [Camping & Hiking](#), [Canoeing & Kayaking](#), [Dancing](#), [Gardening](#), [Martial Arts](#), [Other Active Interests](#), [Scuba Diving](#)
- **Collecting**  
[Beanbag Collectibles](#), [Dept 56](#), [Figurines](#), [Furniture & Antiques](#), [Literature & Books](#), [Model Trains](#), [Other Collectibles](#), [Pins & Buttons](#), [Sports Cards](#), [Stamps](#), [Toys](#)
- **Computers & Technology**  
[Animation & Video](#), [Computer Games](#), [Computers--Other](#), [Desktop Publishing](#), [Graphics](#), [Internet](#), [Macintosh](#), [Music & Sound](#), [My First Home Page](#), [PDA](#), [Windows](#)
- **Creative Pursuits**  
[Ceramics & Pottery](#), [Cooking & Baking](#), [Flower Arranging](#), [Making Music](#), [Masonry](#), [Metalworking](#), [Other Creative Pursuits](#), [Painting](#), [Photography](#), [Sculpture](#), [Textile & Needle Arts](#), [Woodworking](#), [Writing](#)
- **Specialty Interests**  
[Astrology](#), [Astronomy](#), [Aviation & Planes](#), [Cars & Trucks](#), [Couponing & Refunding](#), [Flea Markets/Yard Sales](#), [Ham Radio & Electronics](#), [Metal Detecting](#), [Motorcycles](#), [Other Specialty Interests](#), [Volunteering](#)

**[MUCHTRBLE2's PAGE](#)**

**[Josh & Becky](#)**

**[My First Home Page](#)**

**[West Hartford Girls Basketball League](#)**

**[GORETTI CLASS OF 1969 REUNION](#)**

**[In Memory of Our Dog, LilBit \(photo taken Summer of 2000, age 10\) who passed away June 30, 2004 at age 14 1/2. We will forever miss you.](#)**

About our Dog, LilBit. The sweetest Lhasa Apso ever born.

**[PAINTNPAUL](#)**

We are street-rod lovers. Hobbies include car shows, & ebay buying & selling of DOLLS!

**[Tiger Lily](#)**

**[Mr. Bowman's Classes at Rubidoux High School](#)**

Find Mr. Bowman's Algebra

**[Marilyn's Home Page](#)**

Join me in getting paid to surf, read E-Mail and giving your opinions!

**[The Poetry Garden of Vu Thi An and Friends](#)**

The Poetry Garden of Vu Thi An

**[Petrapusher1](#)**

**[SomberFrog](#)**

Don't Hate me because I'm a SSBBW!

**[Look into My Life ..... õ¿õ](#)**

**[GINODRUMS WEBSITE](#)**



drum lessons

[çÂ Poetry Links & Art Gallery](#)

çç§û;Î £ÓN«úüÇô £ÓN¼çÕ

[Billo Star online](#)

["Nemo" April 19th. "Once" July 7th. The time has come.](#)

[Trish](#)

[MERF's PICK's For Major League Baseball !!!](#)

[Patti](#)

[Andy'sPhotographyPrices](#)

[Homily Notes](#)

The page contains the basis for a homily/sermon that I deliver at a Catholic Sunday Mass. I usually post it on Sunday afternoon after I have preached.

[My Profile](#)

[Rob Metaz Home Page](#)

NJ GAY BOY

(1 - 25 of 500) [more](#) >>

Find homepages in My First Home Page only.

[Main](#) >> My First Home Page

Love@AOL I am a  seeking  Get started today >>

## My First Home Page

Find homepages in My First Home Page only.

Explore My First Home Page

**Show:** [All](#) | [Journals Only](#) | [Home Pages Only](#)

**Important:** AOL's Easy Designer uses Microsoft Virtual Machine (VM). Please make sure your operating system has VM and that it is enabled. For more information, go to [Easy Designer Help](#).

You also need to be using Windows 98, 2000 or XP with Internet Explorer 5.5+ or Netscape Navigator 6+ in order to access Easy Designer.

**Minimum system requirements to run The Tool:**

- Windows 95 or above (Unfortunately we do not yet support MacOS, Windows 3.1, Windows NT, or Windows CE).
- Internet Explorer 4.0+ or Netscape Navigator 4.06+, Windows AOL 4.0 or above.
- 16MB RAM (32MB or better strongly recommended)
- 14.4kbps or faster connection (28.8 or faster strongly recommended).
- 640x480, 256 colors or better screen (optimized for 800x600)
- 30MB or more free hard disk space.
- Pentium-class processor.

To download an update for your JVM, go to <http://www.microsoft.com/java> for Internet Explorer or <http://home.netscape.com/smartupdate> for Netscape Navigator.

[Main](#) >> Hobbies & Interests



## Hobbies & Interests

Find homepages in Hobbies & Interests only.

### Explore Hobbies & Interests

- **AOL Journals: Hobbies & Interests**  
[Hobbies & Interests Journals](#), [Photo Journals](#), [Technology Journals](#)
- **Active Interests**  
[Boating & Sailing](#), [Bodybuilding](#), [Camping & Hiking](#), [Canoeing & Kayaking](#), [Dancing](#), [Gardening](#), [Martial Arts](#), [Other Active Interests](#), [Scuba Diving](#)
- **Collecting**  
[Beanbag Collectibles](#), [Dept 56](#), [Figurines](#), [Furniture & Antiques](#), [Literature & Books](#), [Model Trains](#), [Other Collectibles](#), [Pins & Buttons](#), [Sports Cards](#), [Stamps](#), [Toys](#)
- **Computers & Technology**  
[Animation & Video](#), [Computer Games](#), [Computers--Other](#), [Desktop Publishing](#), [Graphics](#), [Internet](#), [Macintosh](#), [Music & Sound](#), [My First Home Page](#), [PDA](#), [Windows](#)
- **Creative Pursuits**  
[Ceramics & Pottery](#), [Cooking & Baking](#), [Flower Arranging](#), [Making Music](#), [Masonry](#), [Metalworking](#), [Other Creative Pursuits](#), [Painting](#), [Photography](#), [Sculpture](#), [Textile & Needle Arts](#), [Woodworking](#), [Writing](#)
- **Specialty Interests**  
[Astrology](#), [Astronomy](#), [Aviation & Planes](#), [Cars & Trucks](#), [Couponing & Refunding](#), [Flea Markets/Yard Sales](#), [Ham Radio & Electronics](#), [Metal Detecting](#), [Motorcycles](#), [Other Specialty Interests](#), [Volunteering](#)

**[MUCHTRBLE2's PAGE](#)**

**[Josh & Becky](#)**

**[My First Home Page](#)**

**[West Hartford Girls Basketball League](#)**

**[GORETTI CLASS OF 1969 REUNION](#)**

**[In Memory of Our Dog, LilBit \(photo taken Summer of 2000, age 10\) who passed away June 30, 2004 at age 14 1/2. We will forever miss you.](#)**

About our Dog, LilBit. The sweetest Lhasa Apso ever born.

**[PAINTNPAUL](#)**

We are street-rod lovers. Hobbies include car shows, & ebay buying & selling of DOLLS!

**[Tiger Lily](#)**

**[Mr. Bowman's Classes at Rubidoux High School](#)**

Find Mr. Bowman's Algebra

**[Marilyn's Home Page](#)**

Join me in getting paid to surf, read E-Mail and giving your opinions!

**[The Poetry Garden of Vu Thi An and Friends](#)**

The Poetry Garden of Vu Thi An

**[Petrapusher1](#)**

**[SomberFrog](#)**

Don't Hate me because I'm a SSBBW!

**[Look into My Life ..... õ¿õ](#)**

**[GINODRUMS WEBSITE](#)**

drum lessons

[çÂ Poetry Links & Art Gallery](#)

çç§û;Î £ÓN«úüÇô £ÓN¼çÕ

[Billo Star online](#)

["Nemo" April 19th. "Once" July 7th. The time has come.](#)

[Trish](#)

[MERF's PICK's For Major League Baseball !!!](#)

[Patti](#)

[Andy'sPhotographyPrices](#)

[Homily Notes](#)

The page contains the basis for a homily/sermon that I deliver at a Catholic Sunday Mass. I usually post it on Sunday afternoon after I have preached.

[My Profile](#)

[Rob Metaz Home Page](#)

NJ GAY BOY

(1 - 25 of 500) [more](#) >>

Find homepages in My First Home Page only.

[Main](#) >> My First Home Page

Love@AOL I am a  seeking  Get started today >>

## My First Home Page

Find homepages in My First Home Page only.

Explore My First Home Page

**Show:** [All](#) | [Journals Only](#) | [Home Pages Only](#)



[Shelters](#)

[Greenhouses](#)

[What's New?](#)

[Gillis Designs](#)

[Stories](#)

[Q's & A's](#)

## Shelters

**Shelter Systems** offers you a wide range of lightweight, portable, waterproof yurts, domes, tents, and shelters with a wide range of uses as family living spaces; guest rooms and temporary housing; studios; fair and exhibition pavilions; backpacking, camping, and guide tents; expedition, excavation, and research tents; ski huts; party and wedding pavilions; emergency shelters; survival structures; storage sheds; bicycle sheds; solariums; window awnings; jacuzzi covers; and more. Shelter Systems makes its structures with a superstrong, tough, UV-resistant, ripstop fabric and its own nonpuncturing tarp fastener, the Grip Clip.

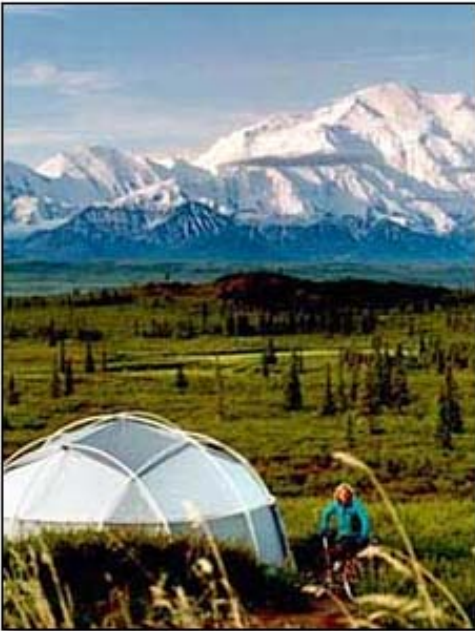

### Our Most Popular Geodesic Yurt and Dome Shelters:

[Yurts](#)

[Domes,](#)

[YurtsDomes](#) Note that our Yurts, Domes and YurtDomes are the same structures

[30' Diameter Yurt Dome™](#)

[The BubbleDome™](#)

---

### Other Structures:

[The CrystalCave™ Shelter](#)

[Bicycle Storage Shed](#)

[Solar Structures™](#)

[RoofShel™ Structures](#)

[Solariums](#)

[Window Shade Awnings](#)

[The ArchTent™](#)

[Wind Walls](#)

---

### Special Applications for Our Geodesic Yurts™:

[Emergency Disaster Relief Tents and Yurt Dome Shelters](#)

[Shelter Systems' Yurts, Domes and Tents at Burning Man](#)

[Swimming Pool Covers](#)

[Portable Classrooms](#)

[Outfitter and Guide Tents, Yurts and Domes](#)



[Party Tents, Yurts and Domes](#)

[Expedition Tents, Yurts and Domes](#)

[Wedding Tents](#)

[Archeology Excavation Shelter Tents](#)

[Watsu Covers](#)

[HalfDomes™ to Attach to Your House](#)

[Fish and Koi Pond Covers](#)

[Spa and Hot Tub Covers](#)

[Survival and Preparedness Yurt Dome, Portable Shelters and Tents](#)

[Shade Structures](#)

[StarDomes Telescope Observatories](#)

---

## Grip Clips:

[Grip Clips™](#) The Amazing Tarp Fastener

The Grip Clips™ [Home Page](#)

[Four-Hour Kayak Using Grip Clips!](#)

[The Grip Clip Tarp Tent Kit.](#) Tarp with Grip Clips & Instructions.

[Kid Tents and Huts](#) Made with Grip Clips

---

## Questions and Answers:

[Answers:](#) to a wide array of questions we've received about our Yurt Domes and Portable Shelters.

Questions? E-mail us at [shelter@best.com](mailto:shelter@best.com). Please feel free to call or write us anytime. Shelter Systems-OL, 224 West O'Connor St., Menlo Park, CA 94025. FAX 650-323-1220 Phone 650-323-6202.

[Shelters](#)

[Greenhouses](#)

[What's New?](#)

[Gillis Designs](#)

[Stories](#)

[Q's & A's](#)

Shelter Systems © 1996 - 2001 All Rights Reserved

[Shelter Systems' Home](#)



[Shelters](#)

[Greenhouses](#)

[What's New?](#)

[Gillis Designs](#)

[Stories](#)

[Q's & A's](#)

## Portable Greenhouses

Shelter Systems offers the gardener a wide variety of gardening greenhouses: GroDomes, GroRows, Row Covers, Bubble Domes, CrystalCaves, and Solariums. It's easy and quick to assemble our greenhouses (and to take them down later to store). They are lightweight and portable so it's easy to move them around your backyard.

[GroDomes: our Greenhouse line](#)

[The GroRow: Rowcover Greenhouse](#)

[The BubbleDome Greenhouse](#)

[The CrystalCave Tunnel Greenhouse](#)

[SolarShed: Compact Greenhouse](#)

[RoofShell Structures](#)

[Solariums](#)

[Fish and Koi Pond Covers](#)

[Gardening Manual](#)

[Grip Clips](#) The Amazing Tarp Fastener!

[Questions and Answers:](#) Answers to a wide array of questions we've received about our Yurt Domes and portable shelters.



### 30-DAY RISK-FREE TRIAL 1 1/2-YEAR GUARANTEE

Our guarantee is simple. **YOU MUST BE SATISFIED!** If for any reason you're not completely pleased with your purchase, return it in original, clean condition within 30 days of receipt for a full refund or exchange as you wish. All items in this catalog have a warranty against defects in materials and workmanship for **1 1/2 years**. Should any product prove defective we will repair or replace it at no cost to you. Special Orders are not returnable. Read [Snow and Wind Warnings](#).

[To order.](#) by Fax or Mail.

[Order online with our Secure Order Form!](#)

**For fast credit card orders call 650-323-6202**

Questions? E-mail us at [shelter@best.com](mailto:shelter@best.com). Please feel free to call or write us anytime. Shelter Systems-OL, 224 Walnut St., Menlo Park, CA 94025. FAX 650-323-1220 Phone 650-323-6202.

[Shelters](#)

[Greenhouses](#)

[What's New?](#)

[Gillis Designs](#)

[Stories](#)

[Q's & A's](#)

[Price List](#)

[Shelter Systems' Map of Site](#)

**Shelter Systems** © 1996 - 2001 All Rights Reserved

[Shelter Systems' Home](#)



Shelters

Greenhouses

What's New?

Gillis Designs

Stories

Q's & A's

## What's New

---

Shelter Systems' [Grip Clip Pro](#) patent has been allowed and will begin offering them to the public in about four weeks.



---

Our Burning Man [Index](#)

---

Tent Porch (section of 30'dome)



---

[ShelterKits](#)" Emergency Yurts and Dome Tents and Living

## Support Equipment

---

### Shelter Systems' New [ReliefTent](#)"



---

### [Tent Testimonials](#)



---

**The TV show 24 used our 30' Yurt, Dome in one of their set**



More [shows](#) using our domes, tents and yurts.

---

**Sierra Designs is now selling a new Shelter System's designed backpacking tent at REI**



---

**ShelterFirst™ Emergency and Disaster Relief Tent Shelter**



**Family Size High Strength Low Cost Portable Package Up In 15 Minutes!**

**Family Sized:** ShelterFirst emergency and disaster relief tent shelter has a roomy floor area of 255 square feet and covers 16' x 16' area with a height of 7'4". It has four doors for good ventilation. The door covers can be pulled out to create a porch over the door openings. The doors tie closed, there are no zippers to fumble with or break. The interior can be divided with fabric to create private areas. Since the covering is not punctured or cut in the manufacture of the tent it can not leak! Vents can be created where side walls hit the ground for extra ventilation in hot weather. The covering's white color reflects the sun's heat during the day and makes for a pleasingly bright interior during the night. ShelterFirst tents are light filled and well ventilated. The cover of the tent is easily cleaned with a damp cloth.

### [More about ShelterFirst Tents](#)

**ShelterFirst™ Tarp Tent Shelter Kit \$150 Shipping \$10**

Includes all Grip Clips™, Clip Cords and plans needed make your own First Shelter™ Tarp Tent Shelter  
You will need to provide a tarp at least 24' by 24' (smaller shelters can be made using smaller tarps) stakes (we offer [Stakes](#) also) and poles (poles can be of 1.5" PVC, 2" x 2" lumber, 1" bamboo or branches. Tools needed: Saw, marking pen and hammer.

---

## **Free Standing Box Tents™**



Strange but true; Free Standing Box Tents™ developed for use in studying gas exchange experiments between plants and there environment.

## Cutting Edge Tent Design

At Shelter Systems, we are always thinking about new designs and applications for portable structures and shelters. We'd like to share with you our new structures, domes and tents which Shelter Systems is offering and related design ideas and patents.



[New Tent Technology Products and Patents](#) Shelter Systems' has a number of new tent technology products and patents.

---

## Shelter System's domes were used in a Star Trek episode:



More [shows](#) using our domes, tents and yurts.

---

## Extra Strong 18' Yurt Dome

We have developed **Extra Strong 18' Yurt Dome** that has extra strong translucent skylight windows instead of the clear vinyl windows. These skylights let in more light than glass and can not crack or stretch like the clear vinyl. If you are interested in this version of the 18' Yurts and Domes let us know when you order that you would like the Special Extra Strong 18' Yurts or Domes.





**Extra Strong 18' Yurt and Dome**



**[Email Questions and Answers](#)**

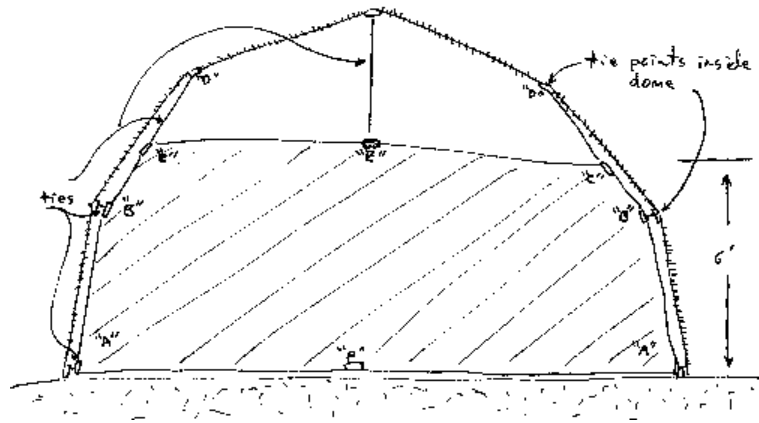

**Divide Your Yurt Dome into Rooms** Shelter Systems Yurts and Domes can be easily divided into rooms with fabric you provide or some of the same [woven ripstop material](#) that Shelter Systems' makes it Yurts and Domes out of.

Also see our online Manual for our Domes and Tents

---



**Over 80 of our domes** in 2001 were in use at [Burning Man](#). They endured [high winds](#) and [dust storms](#).

---

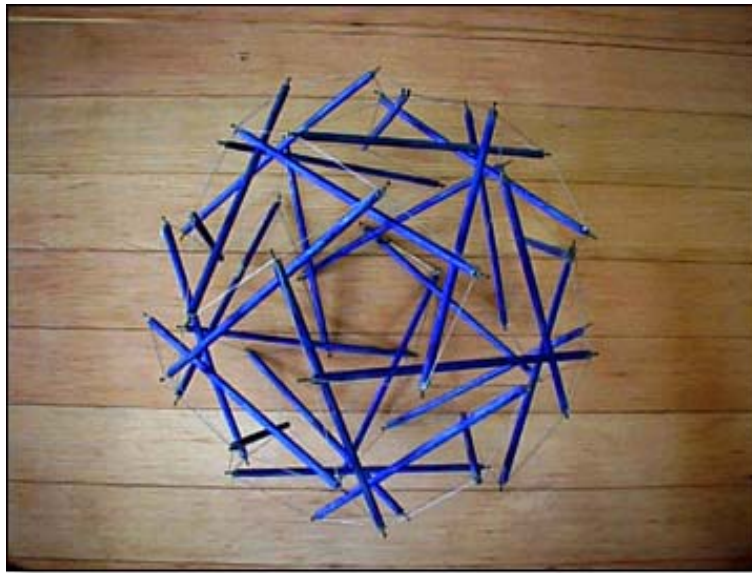

[Make your own tensegrity models.](#)



Above is an improved method of constructing [The 4 Hr Grip Clip Kayak](#)



**Attaching Micro Grip Clips to Ultra Light Weight Silicon Coated Nylon Tarps (Sil Cloth) to Make Tents:** Grip Clips will allow you to create tents out of 1.1 oz ultra light weight silicon coated nylon fabric without sewing or punching holes in the fabric and without tools. Thus you can make adjustments to your tarp tent in the field by moving the Grip Clips around just where you need them.

**Origami Dome Tent™:** An Amazing Folding Tensegrity dome shelter of rigid panels that folds flat when not needed! When made as a **Folding Tent** with poles on the edges it folds into a tight bundle. **Make one of cardboard.**

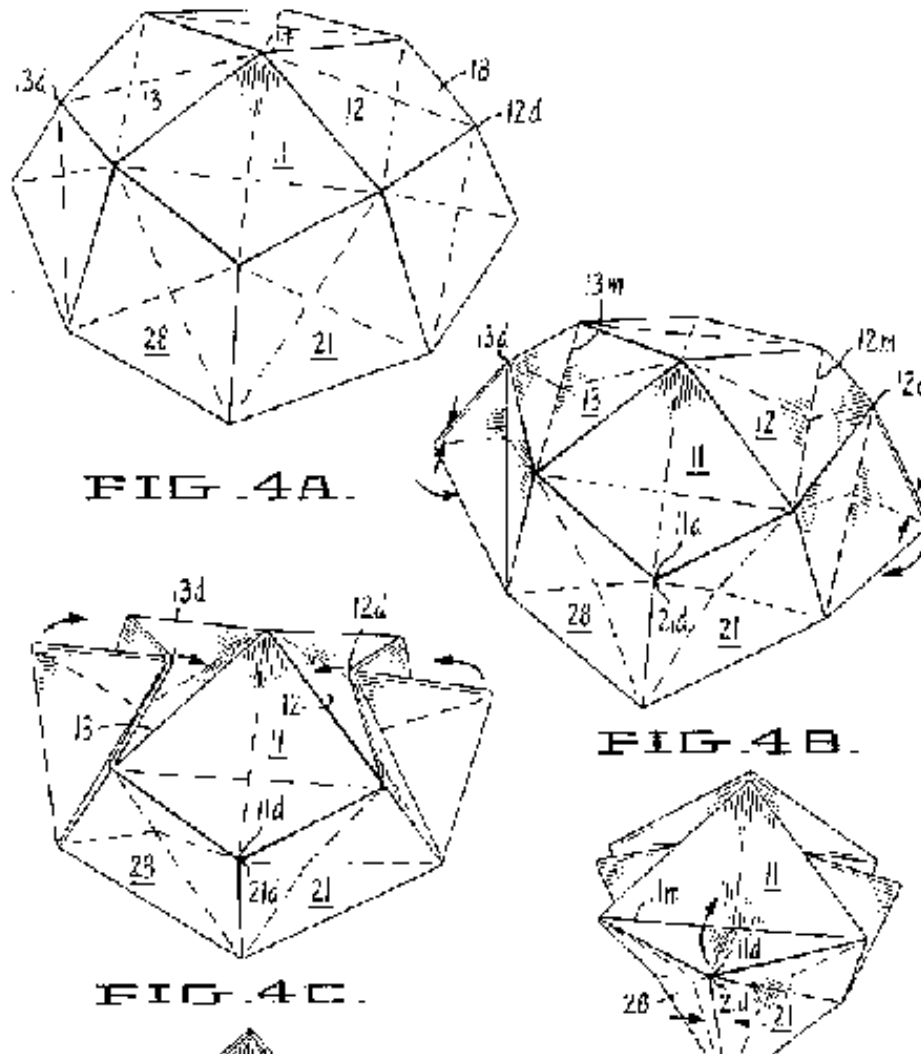

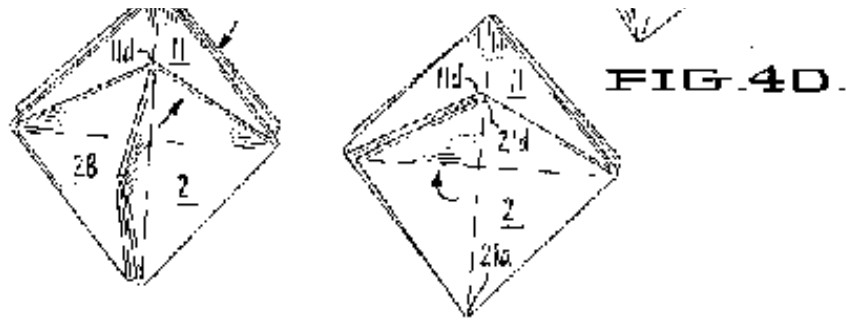

### Folding Geodesic Yurt Domes

**Flextent™** foldable tent structures. These structures are exceptionally strong and unfold in 5 minutes for a fast setup. They also have a steeply peaked roof that allows for snow to slide off easily.

#### Demo Domes:

We sometimes have a small number of "nearly new" domes that are discounted 10% to 20%. If you are interested, call us.

Questions? E-mail us at [shelter@best.com](mailto:shelter@best.com). Please feel free to call or write us anytime. Shelter Systems-OL, 224 Walnut St., Menlo Park, CA 94025. FAX 650-323-1220 Phone 650-323-6202.

Shelters

Greenhouses

What's New?

Gillis Designs

Stories

Q's & A's

Shelter Systems © 1996 - 2003 All Rights Reserved

[Shelter Systems' Home](#)





[Shelters](#)

[Greenhouses](#)

[What's New?](#)

[Gillis Designs](#)

[Stories](#)

[Q's & A's](#)

## Gillis Designs

Gillis Designs is the design branch of Shelter Systems which offers a wide range of portable and waterproof shelters, domes, tents, yurts, and greenhouses. We invite you to explore our past, present, and future award-winning structures, products, projects, designs and patents. Let us design a structure that fits you needs. Our consulting fee is \$1500 a day.

[Who We Are](#)

[Design Consulting Projects](#)

[Award-Winning Designs](#)

[Set and Production Design for Film](#)

[Other Shelter Systems' Patents](#)



[New Tent Technology Patents](#)

[Interestingly Shaped Shelter Systems' Tents](#)

[Make your own Model](#)

[Spheres](#)

[Custom Domes and Greenhouses](#)

[Tensegrity and Geodesic Structures](#)

Questions? E-mail us at [shelter@best.com](mailto:shelter@best.com). Please feel free to call or write us anytime. Shelter Systems-OL, 224 Walnut St., Menlo Park, CA 94025. FAX 650-323-1220 Phone 650-323-6202.

[Shelters](#)

[Greenhouses](#)

[What's New?](#)

[Gillis Designs](#)

[Stories](#)

[Q's & A's](#)

Shelter Systems © 1996 - 2003 All Rights Reserved

[Shelter Systems' Home](#)







[Shelters](#)

[Greenhouses](#)

[What's New?](#)

[Gillis Designs](#)

[Stories](#)

[Q's & A's](#)

## Who is Shelter Systems and Customers' Stories

Find out about **Shelter Systems** and its background and history, what our customers think of our portable, lightweight yurts, domes, tent structures and gardening greenhouses, and the many different ways--and places-- they use them.

[Who We Are](#)

[Tent Testimonials and Customer's Photos](#)

[Picture History of Shelter Systems Tent Structures](#)

[Shelter Systems Domes and Yurts Featured in Major Films and on Television!](#)

[Drawings of Earlier Shelter Sytems' Domes](#)

[Interesting Links](#)



Questions? E-mail us at [shelter@best.com](mailto:shelter@best.com). Please feel free to call or write us anytime. Shelter Systems-OL, 224 Walnut St., Menlo Park, CA 94025. FAX 650-323-1220 Phone 650-323-6202.

[Shelters](#)

[Greenhouses](#)

[What's New?](#)

[Gillis Designs](#)

[Stories](#)

[Q's & A's](#)

Shelter Systems © 1996 - 2003 All Rights Reserved

[Shelter Systems' Home](#)



[Shelters](#)

[Greenhouses](#)

[What's New?](#)

[Gillis Designs](#)

[Stories](#)

[Q's & A's](#)

## Questions & Answers about Our Yurt Domes and Tents

Here are our answers to the wide array of questions we've received about **Shelter Systems'** Domes, Yurts, Tents and portable shelters. Our answers come from long experience with dome tent dwellings and gardening in greenhouses.

[Common Questions and Answers About Our Yurts, Domes, Tents and Greenhouses](#)

[The Most Recent Email Questions Answered](#)

[Answers to Email Questions about our Yurts, Domes, and Tents](#)

[More Email Questions Answered](#)

[What is a Portable Yurt](#)

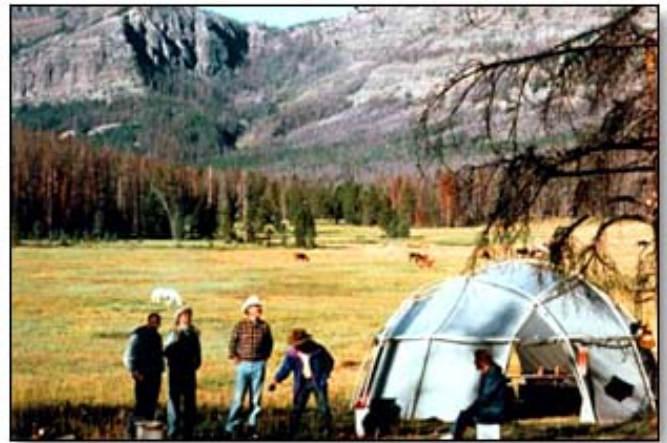

Questions? E-mail us at [shelter@best.com](mailto:shelter@best.com). Please feel free to call or write us anytime. Shelter Systems-OL, 224 Walnut St., Menlo Park, CA 94025. FAX 650-323-1220 Phone 650-323-6202.

[Shelters](#)

[Greenhouses](#)

[What's New?](#)

[Gillis Designs](#)

[Stories](#)

[Q's & A's](#)

Shelter Systems © 1996 - 2003 All Rights Reserved

[Shelter Systems' Home](#)



Shelters

Greenhouses

What's New?

Gillis Designs

Stories

Q's &amp; A's

## Wind and Snow Warning

Shelter Systems' Domes are stronger for their weight and cost than any other structure. Still they are light weight portable structures and as such are not designed to hold unusually strong wind, year round wind or much snow.

When possible, avoid exposed hilltops and narrow valleys where wind speed increases. Trees and brush between you and the wind help protect your shelter. If you do not have natural protection from the wind you can create a wind screen out of straw bales. Your dome could be destroyed in extreme weather and your life or safety could be at risk. In heavy snow or wind your dome could collapse, damaging what you have or compromising your shelter. Do not rely on your dome as your only shelter. Accumulated snow, must be melted or shaken off.



Fence



Just as you would not expect to be able to climb up on top of your dome and have it hold you, it will not support much snow. If you plan to use your dome in the snow you will need to knock off the snow periodically or melt it off with heat from within the dome. If the dome should collapse some poles may break (these are easy to repair or inexpensive to replace) with unusually little or no damage to the covering. However items stored inside could be damaged by the weight or melting of the snow.

The covering will have a shorter life in areas that have constant winds. The dome's covering can fail or the covering be ripped from the clips in extreme wind.

**Anchoring:** Your dome is no stronger than its anchors, so it is important to anchor it securely. Be sure to read your [Instruction Manual](#) section on anchoring carefully.

If your dome is free from its anchors it can tumble and blow away and possibly collide with and damage people or property. Do not let your dome get away from you anchor it well.

Even if you anchor your dome well, extreme wind can rip the guy line clips and poles off your dome and your dome will fail.

**WARNING:** Your Yurt Dome shelter could be destroyed in extreme weather and your life or safety could be at risk. In heavy snow or wind your Yurt Dome could collapse, damaging what you have or compromising your shelter. Do not rely on your Yurt Dome as your only shelter. Accumulated snow, must be melted or shaken off periodically. Do not set your Yurt Dome under a tree or branch that might fall on you. Keep all flames and heat away from your Yurt Dome's covering and objects in your yurt dome.

### 30-DAY RISK-FREE TRIAL 1 1/2-YEAR GUARANTEE

Our guarantee is simple. **YOU MUST BE SATISFIED!** If for any reason you're not completely pleased with your purchase, return it in original, clean condition within 30 days of receipt for a full refund or exchange as you wish. All items in this catalog have a warranty against defects in materials and workmanship for **1 1/2 years**. Should any product prove defective we will repair or replace it at no cost to you. Special Orders are not returnable. Read [Snow and Wind Warnings](#).

[To order.](#) by Fax or Mail.

[Order online with our Secure Order Form!](#)

**For fast credit card orders call 650-323-6202**

Questions? E-mail us at [shelter@best.com](mailto:shelter@best.com). Please feel free to call or write us anytime. Shelter Systems-OL, 224 Walnut St., Menlo Park, CA 94025. FAX 650-323-1220 Phone 650-323-6202.

[Shelters](#)

[Greenhouses](#)

[What's New?](#)

[Gillis Designs](#)

[Stories](#)

[Q's & A's](#)

[Price List](#)

[Shelter Systems' Map of Site](#)

**Shelter Systems** © 1996 - 2001 All Rights Reserved

[Shelter Systems' Home](#)



Shelters

Greenhouses

What's New?

Gillis Designs

Stories

Q's & A's

## How to Order from Shelter Systems

1) For fast credit card orders, call 650-323-6202 or [Order online with our Secure Order Form!](#)

2) Or you can fill out the form below. Print it and fax it to 650-323-1220.

3) Or you can use the form below. Print it and mail it to us with a check, money order, or your credit card # to: Shelter Systems-OL, 224 Walnut St., Menlo Park, CA 94025.

### SHIPPING

Add shipping for each dome to help cover postage, packing and insurance. For Alaska or Hawaii the shipping cost is four times the amount shown for each dome. We ship via United Parcel Service. If possible, please give a street address.

### GUARANTEE

Our guarantee is simple. **YOU MUST BE SATISFIED!** Everything in this catalog is offered for 30 days' free trial. If for any reason you're not completely pleased with your purchase, return it in original condition within 30 days of receipt for a full refund or exchange as you wish. All items in this catalog have a warranty against defects in materials and workmanship for one and one half years. Should any product prove defective we will repair or replace it at no cost to you. Special Orders are not returnable; since we do not offer them in our catalog, we would have trouble reselling them.

### SNOW AND EXTREME WIND CAUTION

**Your dome is a lightweight, portable structure and should not be relied on as your sole shelter in extreme weather. Your dome could be destroyed in extreme weather and your life or safety could be at risk.**

**In heavy snow your dome could collapse which could damage what you have in it or compromise your shelter. Do not rely on your dome as your only shelter where it snows.**

**Your dome will blow away if it is not anchored properly. Study the anchoring instructions carefully and apply all appropriate means to secure your dome to the earth. Rain will soften the ground and greatly reduce the holding power of the stakes. We provide good general purpose stakes, but they cannot cover all ground conditions. Wind will at times come up unexpectedly. Be prepared!**

**Remember that the dome is a lightweight, portable structure. Its strength comes from tension, not mass or rigid components. Exposed sites with unusually extreme winds are not recommended. It is apparent that you can not climb on top of the dome, nor can you expect it to support heavy snow loads. Accumulated snow must be melted or shaken off periodically.**

### HOW LONG DOES IT TAKE TO GET MY ORDER?

The fastest way to get your dome is to call or fax in a order with your credit card. The next fastest way to get your dome is to send in an order with a bank or postal money order. We want you to receive your purchases as soon as possible. We try to fill orders within 5 days of receipt. To speed delivery, please type or print in dark ink all necessary information on the order form.

### PAYMENT

We accept your personal check, certified check, money order, Master Card or Visa. Since it takes an average of 2 weeks for a personal check to clear your bank, money orders will result in faster service. Prices are subject to change.

ORDERED BY: Name and Address

Check      Money Order      Master Card      Visa      Date

Card Number

Signature      Expiration Date

Phone #

Please Send Me:

|       |      |      |       |
|-------|------|------|-------|
| Item# | Item | Qty: | Price |
| Item# | Item | Qty: | Price |
| Item# | Item | Qty: | Price |
| Item# | Item | Qty: | Price |
| Item# | Item | Qty: | Price |

Sub Total:

CA residents add 8% sales tax.....

Shipping: listed with each item. AK & HI shipping is four times amount shown...

Where did you hear about us?      TOTAL:

**30-DAY RISK-FREE TRIAL 1 1/2-YEAR GUARANTEE**

Our guarantee is simple. **YOU MUST BE SATISFIED!** If for any reason you're not completely pleased with your purchase, return it in original, clean condition within 30 days of receipt for a full refund or exchange as you wish. All items in this catalog have a warranty against defects in materials and workmanship for **1 1/2 years**. Should any product prove defective we will repair or replace it at no cost to you. Special Orders are not returnable. Read [Snow and Wind Warnings](#).

[To order](#) by Fax or Mail.

[Order online with our Secure Order Form!](#)

**For fast credit card orders call 650-323-6202**

Questions? E-mail us at [shelter@best.com](mailto:shelter@best.com). Please feel free to call or write us anytime. Shelter Systems-OL, 224 Walnut St., Menlo Park, CA 94025. FAX 650-323-1220 Phone 650-323-6202.



[Price List](#)

[Shelter Systems' Map of Site](#)

[Shelter Systems' Home](#)

### Shelter Systems Secure Order Form

Please check the items that you would like to order, copy in the appropriate prices and tally up your order below. If you need a calculator, [click here](#)! Please [email](#) us if you have questions!

|                                |                         |        |      |
|--------------------------------|-------------------------|--------|------|
| Name:                          |                         |        |      |
| Organization:                  |                         |        |      |
| Email:                         |                         |        |      |
| Street:                        |                         |        |      |
|                                |                         |        |      |
| City:                          |                         | State: | ZIP: |
| Phone:                         |                         |        |      |
| <b>Credit card information</b> |                         |        |      |
| Card type:                     |                         |        |      |
| Card number:                   | eg: 1234-5678-9012-0000 |        |      |
| Expiration:                    | eg: 09/98               |        |      |
| Cardholder name:               |                         |        |      |

### Products

|  | Please check the appropriate box or enter item below | Qty | Shipping | Price  |
|--|------------------------------------------------------|-----|----------|--------|
|  | Yurt Dome 30 Diameter 30'x11' High Weight 190 lb.    |     | \$160    | \$1900 |
|  | Yurt Dome 20 Diameter 20'x10' High Weight 70 lb.     |     | \$55     | \$860  |
|  | Yurt Dome 18 Diameter 18'x9' High Weight 60 lb.      |     | \$45     | \$720  |
|  | Yurt Dome Yurt 14 Diameter 14'x7' High Weight 40     |     | \$35     | \$620  |
|  | GroDome 30 Diameter 30'x11' High Weight 190 lb.      |     | \$160    | \$1900 |
|  | GroDome 20 Diameter 20'x10' High Weight 70 lb.       |     | \$55     | \$860  |
|  | GroDome 18 Diameter 18'x9' High Weight 60 lb.        |     | \$45     | \$720  |
|  | GroDome 14 Diameter 14'x7' High Weight 40 lb.        |     | \$35     | \$620  |



|  |                                                             |  |      |       |
|--|-------------------------------------------------------------|--|------|-------|
|  | GroDome 11 Diameter 11'x6'4"High Weight 20 lb.              |  | \$35 | \$580 |
|  | GroDome 8 Diameter 8'x7'4" High Weight 20 lb.               |  | \$35 | \$460 |
|  | Net Doors                                                   |  | \$2  | \$20  |
|  | BubbleDome 10: Diameter 9' Height 8.5'<br>White Translucent |  | \$40 | \$520 |
|  | Floor 30'                                                   |  | \$35 | \$270 |
|  | Floor 20'                                                   |  | \$20 | \$120 |
|  | Floor 18'                                                   |  | \$20 | \$95  |
|  | Floor 14'                                                   |  | \$15 | \$75  |
|  | Porch:                                                      |  | \$10 | \$68  |
|  | Light Fabric Grip Clip (1 3/8") (set of 4)                  |  | na   | \$8   |
|  | General Purpose Grip Clip (2 3/8") (set of 4)               |  | nc   | \$10  |
|  | SunShade 6' x12'                                            |  | \$10 | \$25  |
|  | SunShade 12' x24'                                           |  | \$15 | \$75  |
|  | Liner 20'                                                   |  | \$35 | \$650 |
|  | Liner 18'                                                   |  | \$35 | \$590 |
|  | Liner 14'                                                   |  | \$25 | \$490 |
|  | Other Item:                                                 |  |      |       |
|  | Other Item:                                                 |  |      |       |
|  | Other Item:                                                 |  |      |       |
|  | Other Item:                                                 |  |      |       |

|                                                                                                                                                                                                                      |             |  |  |  |
|----------------------------------------------------------------------------------------------------------------------------------------------------------------------------------------------------------------------|-------------|--|--|--|
|                                                                                                                                                                                                                      | Other Item: |  |  |  |
|                                                                                                                                                                                                                      | Other Item: |  |  |  |
| Product(s) Total: ( <b>Please note</b> that totals are not automatically calculated. It will be necessary for you to calculate the totals. If you do not, we will calculate them for you when we receive your order) |             |  |  |  |
| California Residents Please add 8 % sales tax (multiply above total by .08)                                                                                                                                          |             |  |  |  |
| Shipping & Handling (Please calculate)                                                                                                                                                                               |             |  |  |  |
| Total (items, shipping and tax):                                                                                                                                                                                     |             |  |  |  |

[Shelter Systems' Map of Site](#)

[Shelter Systems' Home](#)

**Shelter Systems** © 1996 - 2000 All Rights Reserved



Shelters

Greenhouses

What's New?

Gillis Designs

Stories

Q's &amp; A's

## Price List

This is the price list for **Shelter Systems'** yurts, domes, tents, other shelters, and accessories. **Note that this price sheet is Not complete.**

**Geodisic Yurt Dome™ 30** Diameter 30'x11' High Weight 190 lb. **\$1900** Shipping \$160

**Geodisic Yurt Dome 20** Diameter 20'x10' High Weight 70 lb. **\$860** Shipping \$55

**Geodisic Yurt Dome 18** Diameter 18'x9' High Weight 60 lb. **\$720** Shipping \$45

**Geodisic Yurt Dome 14** Diameter 14'x7' High Weight 40 lb. **\$620** Shipping \$40

**Geodisic Yurt Dome 11** Diameter 11'x6'4" High Weight 20 lb. **\$450** Shipping \$35

**Geodisic Yurt Dome 8** Diameter 8'x7'4" High Weight 20 lb. **\$360** Shipping \$35

**BubbleDome™ 10:** Diameter 9' Height 8.5' Weight 35 lb. **\$520** Shipping \$40

**BubbleDome 14:** Diameter 13' Height 11' Weight 50 lb. **\$840** Shipping \$55

**BubbleDome 18:** Diameter 15.5' Height 13' Weight 75 lb. **\$1020** Shipping \$65

**BubbleDome 20:** Diameter 17' Height 15' Weight 90 lb. **\$1290** Shipping \$70

Available in White Solar Dome or Translucent Gro-Dome covering.

**GroDome™ 30** Diameter 30'x11' High Weight 190 lb. **\$1900** Shipping \$160

**GroDome 20** Diameter 20'x10' High Weight 70 lb. **\$860** Shipping \$55

**GroDome 18** Diameter 18'x9' High Weight 60 lb. **\$720** Shipping \$45

**GroDome 14** Diameter 14'x7' High Weight 40 lb. **\$620** Shipping \$35

**GroDome 11** Diameter 11'x6'4" High Weight 20 lb. **\$450** Shipping \$35

**GroDome 8** Diameter 8'x7'4" High Weight 20 lb. **\$360** Shipping \$35

**Liner 30':** **\$1550** Shipping \$130

**Liner 20':** **\$650** Shipping \$35

**Liner 18':** **\$590** Shipping \$35

**Liner 14':** **\$490** Shipping \$25

**Liner 11':** **\$390** Shipping \$25

**StarCave™ 9:** 9'x9'x7' High, Weight: 40 lb.. **\$530** Ship \$45

**StarCave11:** 11'x11'x7' High, Weight: 51 lb.. **\$650** Ship \$55

**CrystalCave Shelter 9:** 9'x9'x7' High, Weight: 40 lb.. **\$550** Ship \$45

**CrystalCave Shelter 11:** 11'x11'x7' High, Weight: 51 lb.. **\$680** Ship \$55

Available in white, or silver/black. Be sure to tell us which covering you want.

**CrystalCave Greenhouse 9:** 9'x9'x7' High, Weight: 40 lb.. **\$550** Ship \$45

**CrystalCave Greenhouse11:** 11'x11'x7' High, Weight: 51 lb.. **\$680** Ship \$55

**Grip Clip Tarp™ 14' x 14'** **\$105.** Shipping \$20

**Grip Clip Tarp 20' x 20'** **\$160.** Shipping \$25

**Arch Tent™ 20' x 26'** Plans and Grip Clips **\$100.** Shipping \$5

**Light Fabric Grip Clip™ (1 3/8")** For thin nylon tarps and fabric. Set of 4: **\$8 Post Paid**

**Micro Grip Clip (1 1/8")** Set of 4 for **\$8 Post Paid**

**General Purpose Grip Clip (2 3/8")** For normal plastic tarps. Set of 4 **\$10 Post Paid**

**Heavy-Duty Grip Clip (3 5/8")** For extra strength or on large or thick tarps: Set of 2 **\$10 Post Paid**

**GroRow 7:** 3' x7' **\$68** Shipping \$20

**GroRow 10:** 3' x10' \$98 Shipping \$25

**HalfDome 14:** Diameter 14' Height 7' Weight 28 lb. \$400 Shipping \$35

**HalfDome 18:** Diameter 18' Height 9' Weight 45 lb. \$490 Shipping \$40

**HalfDome 20:** Diameter 20' Height 10' Weight 50 lb. \$550 Shipping \$45

Available in white, or silver/black. Be sure to tell us which covering you want.

**Net Doors:** \$20 Shipping \$2

**Floor 30':** \$270 Shipping \$35

**Floor 20':** \$120 Shipping \$20

**Floor 18':** \$95 Shipping \$20

**Floor 14':** \$75 Shipping \$15

**Floor 11':** \$45 Shipping \$15

**Porch:** \$68 Shipping \$10

**SunShade™ 6' x12':** \$25 Shipping \$10

**SunShade 8' x20':** \$70 Shipping \$15

**SpaShell™ 10'** \$185 Shipping \$25

**SpaTop™ 8' (Top of 10'er)** \$280 Shipping \$20

**SpaTop 12.5' (Top of 14'er)** \$345 Shipping \$25

**SpaTop 16' (Top of 18'er)** \$400 Shipping \$25

**SpaTop 18' (Top of 20'er)** \$495 Shipping \$35

Available in white or translucent. Be sure to tell us which covering you want.

**PorchShell™ 5' x 5'** \$68. Shipping: \$10

**Roof Shell 10'** \$185 Shipping \$22

**Roof Top™ 8' (Top of 10'er)** \$280 Shipping \$20

**Roof Top 12.5' (Top of 14'er)** \$345 Shipping \$25

**Roof Top 16' (Top of 18'er)** \$400 Shipping \$25

**Roof Top 18' (Top of 20'er)** \$495 Shipping \$35

**Roof Top 25' (Top of 30'er)** \$1400 Shipping \$110

Be sure to let us know if you want your RoofShell, PorchShell or RoofTop to be made of the White SolarDome, Translucent GroDome, or White and Black SunShade [coverings](#).

**Repair Kit:** \$45 Postpaid

**Poles:** \$3 Shipping \$10. Let us know the size dome they are for.

**Hubs:**\$20 Shipping \$10

**Connectors:** \$5 per pair. Shipping \$10. Let us know the size dome they are for.

**Stakes:** \$4. Shipping \$10

**Woven Ripstop Films:**\$8/yard. 6' wide. Translucent, White, White/ Black. Shipping \$10. Over 6 yards, call.

**Note that this price sheet is Not complete.**

### **30-DAY RISK-FREE TRIAL 1 1/2-YEAR GUARANTEE**

Our guarantee is simple. **YOU MUST BE SATISFIED!** Everything in this catalog is offered for 30 days' free trial. If for any reason you're not completely pleased with your purchase, return it in original condition within 30 days of receipt for a full refund or exchange as you wish. All items in this catalog have a warranty against defects in materials and workmanship for **1 1/2 years**. Should any product prove defective we will repair or replace it at no cost to you. Special Orders are not returnable.

[To order.](#) by Fax or Mail.

[Order online with our Secure Order Form!](#)

**For fast credit card orders call 650-323-6202**

Questions? E-mail us at [shelter@best.com](mailto:shelter@best.com). Please feel free to call or write us anytime. Shelter Systems-OL, 224 West O'Connor St., Menlo Park, CA 94025. FAX 650-323-1220 Phone 650-323-6202.

[Shelters](#)

[Greenhouses](#)

[What's New?](#)

[Gillis Designs](#)

[Stories](#)

[Q's & A's](#)

[Price List](#)

[Shelter Systems' Map of Site](#)

**Shelter Systems** © 1996 - 2001 All Rights Reserved

[Shelter Systems' Home](#)



[Shelters](#)

[Greenhouses](#)

[What's New?](#)

[Gillis Designs](#)

[Stories](#)

[Q's & A's](#)

# Shelter Systems' Web Site Map

## Table of Contents

This table of contents lists and links you to **Shelter Systems'** main pages and subpages about portable shelters, tents, yurts, and domes for temporary and longterm housing, emergency relief, camping, hiking, expeditions, archeological digs; our tarp fastener, the Grip Clip; many styles of greenhouses, solar and storage structures; our new products; award-winning and new designs by Robert Gillis; customers' email questions and answers about Shelter Systems' products; and more.

### [Shelter Systems' Home](#)

### [Price List](#)

### [Shelters](#)

- [Shelter Systems' Instruction Manual](#)
- [Yurts and Domes](#)
- [30' Diameter Yurt Domes](#)
- [The Bubble Dome](#)
- [The CrystalCave Shelter](#)
- [Emergency Shelter Systems](#)
- [The Grip Clip Tarp Kit](#)
- [ArchDome](#)
- [Grip Clips](#)
- [Archeology Excavation Shelter Tents](#)
- [Accessories](#)
- [Setting Up a Shelter Systems Dome](#)
- [Sizes](#)

### [Greenhouses](#)

- [GroDomes](#)
- [The GroRow](#)
- [The BubbleDome](#)
- [The CrystalCave Tunnel Greenhouse](#)
- [Solar Shed Affordable Compact Greenhouse](#)
- [Solar Structures](#)
- [Solariums](#)
- [RoofShell Structures](#)
- [Custom Domes and Greenhouses](#)
- [Grip Clips](#)
- [Accessories](#)

- [Setting Up a Shelter Systems Dome](#)
- [Animation of Setting Up a Greenhouse](#)
- [Sizes](#)
- [Shelter Systems Instruction Manual](#)
- [Gardening Manual](#)

### **Grip Clips**

- [Grip Clips](#)
- [Grip Clip Header Card](#)
- [Grip Clip's Own Web Page!](#)
- [The Grip Clip Tarp Tent Kit](#)
- [Four-Hour Kayak Using Grip Clips!](#)
- [Attaching Grip Clips](#)

### **What's New?**

- [Wind Walls Tent Structures](#)
- [SolarShed](#)
- [BicycleShed](#)
- [SolarStructures](#)
- [Solariums](#)
- [Spa and Jacuzzi Covers](#)
- [StarDomes](#)
- [ShelterShade Awnings](#)
- [RoofShell Structures](#)
- [HalfDomes](#)

### **Gillis Designs**

- [Award-Winning Designs](#)
- [Future Products...](#)
- [Design Projects](#)
- [Custom Domes and Greenhouses](#)
- [Other Shelter Systems Patents](#)
- [Tensegrity and Geodesic Structures](#)
- [Interestingly Shaped Shelter Systems Tents](#)
- [Make your own Model](#)
- [Shelter Systems Design Consulting Projects](#)

### **Stories**

- [Who We Are](#)
- [Award-Winning Designs](#)
- [Picture History of Shelter Systems](#)
- [Shelter Systems Featured in Major Films and on Television!](#)
- [Drawings of Shelter Systems' Domes](#)
- [Answers to Email Questions](#)
- [Common Questions and Answers About Our Domes](#)

- [Portable Yurts](#)

## [Common Questions and Answers About Our Domes](#)

## [Links](#)

## [Shelter Systems' Home](#)

Questions? E-mail us at [shelter@best.com](mailto:shelter@best.com). Please feel free to call or write us anytime. Shelter Systems-OL, 224 Walnut St., Menlo Park, CA 94025. FAX 650-323-1220 Phone 650-323-6202.

[Shelters](#)

[Greenhouses](#)

[What's New?](#)

[Gillis Designs](#)

[Stories](#)

[Q's & A's](#)

**Shelter Systems** © 1996 - 2003 All Rights Reserved

[Shelter Systems' Home](#)



Yurts, Domes, Portable Geodesic Greenhouses, Emergency Disaster Relief Shelters, Tents, Portable Classrooms, Cabin Tents, Hot Tub and Spa Covers, Pool Covers, Guest Houses, Ski Huts, Base Camps, Youth Camps, Eco tourism Cabins, Camping Tents, Mobile Offices, Shade and Solar Structures...

[Shelters](#)[Greenhouses](#)[What's New?](#)[Gillis Designs](#)[Stories](#)[Q's & A's](#)

## Portable Geodesic Yurts

**Shelter Systems Geodesic Yurts** are our most popular portable [Geotensic™](#) shelters. Known for their lightweight construction and strength as well as for the large amount of light they let in, they are made with a strong, tear-resistant fabric and non-puncturing tarp fasteners. They are truly portable and guaranteed to be leak proof. These Yurts have served as family living spaces, camping tents, emergency shelters, studios, playrooms, retreats, fair pavilions, expedition tents, research tents, and more. Note that on this site we use the terms domes and yurts interchangeably.

### Easy Set Up

Our 14', 18' and 20' Yurts can be set up by one person [in 30 minutes](#) without tools. Insert the interchangeable poles into factory-attached connectors spaced evenly over the cover. The poles bend slightly when inserted, tightening the cover into a wind- and waterproof shelter. The cover is freestanding requiring no guy lines and can be moved into the desired position or location without disassembly. The Yurt can be taken down in 5 minutes: just remove the poles and roll up the covering.

### Sturdy Design

Yurts are stronger than any other structure made of the same materials. Because of its curved shape with no corners, there are no weak points. Our patented structure is drum tight, waterproof and wind-resistant.

Shelter Systems' Yurt have the poles on the outside with the covering [suspended](#) under the frame via Shelter Systems' own Grip Clip tarp fasteners. The frame and the covering are not in direct contact. The important benefits from this design are that the covering is under constant, even tension so that the tent will not flap or shred in the wind. The poles cannot rub against the covering, thereby wearing holes in it. Water and leaf debris do not get caught in dips between the poles since the covering is tightly suspended under the poles. The poles and covering are not touching, so there is no temperature buildup to degrade the fabric at contact points.



The [shingled](#) panels of our Yurts overlap each other by 6", making the structure stronger and completely leak proof. The shingling also allows the structure to breathe. The buildup of moisture is driven out through the overlapped panels by vapor pressure and does not condense inside the tent.

Shelter Systems' patented [Grip Clips™](#) tarp fasteners join the Yurt's cover to the frame. Grip Clips also fasten the shingled panels together, providing greater strength than sewn seams or any type of grommet because they do not puncture the cover, which would allow rain to



enter. In addition, the Grip Clip grips a large surface area of the material which prevents the wind from tearing the tent.

### Durable Materials

Shelter Systems' Yurts are made wholly of Shelter Systems' super strong, tear-proof, [woven rip stop film](#) which will not rot or mildew. The covering effectively excludes rain, dampness, wind, cold, leaves and other debris. The completely waterproof covering and the shingling's breathability make a rain fly unnecessary. The covering is manufactured in three layers which are heat bonded together. It is UV-stabilized to withstand up to 3 years of full sun exposure. The white color of the covering defuses the sun and provides 40% shade.

The frames are constructed of strong, long lasting, resilient, UV-stabilized, Class 200, 1 1/4"-diameter (3.5 cm.) PVC tubing.

### Light and Fresh Air

Shelter Systems' Portable Geodesic Yurts are light filled and well ventilated. The translucent white covering creates a bright interior, transmitting 60% of the light. Our Standard Yurts come with four clear vinyl windows above the doors. The Extra Strong Yurts come with a translucent windows that let through more light than glass but are frosted so you can not see clearly through them. The Extra Strong windows do not get brittle in the cold or limp in high temperatures. Shelter Systems' Yurts have four flap doors evenly spaced around the shelter for good cross ventilation and light. The door coverings close automatically so you can go in or out quickly. There are no zippers to fumble with or break.

Since the panels of our Yurts are shingled, overhead ventilation is easily attained by inserting "[ventilation tubes](#)" between several panels (two vent tubes are included with each shelter). When the vent tube is removed, the panels snap shut and are watertight. For maximum ventilation the walls themselves can be rolled up, transforming the domes into an [opened-arch form](#) (see 30 Yurt at right in its open-arch form).



Shelter Systems' Yurts are winter ready. They do not require a fly or liner for winter use. They are completely water tight and will not leak. Yet because of their [shingled construction](#) moist air is driven out through the shingling by vapor pressure. Shelter Systems' Yurts being dome shaped have a minimal surface area for their volume and are thus easy to keep warm with a stove ([installation instructions](#) are included with each tent).



The dome shape has other comfort features: The interior can be divided into "rooms." The tent has more volume than a flat-sided one and therefore feels, and is, more spacious. The shape is more heat efficient because less fuel is needed to heat it plus the heat circulates more evenly. The cover of our Yurts are easily cleaned with a damp cloth.

### A Shelter System

Shelter Systems' Geodesic Yurts come complete with poles, 12" long high quality Durapeg stakes, guy lines for extreme wind settings, ventilation tubes, spare parts (Grips Clips and pole connectors) and a [Shelter Systems' Instruction Manual](#) that details floors, site selection, anchoring, cooling, winterizing,

and stove installation. Our covers are ideally suited for most climates; however, they can be further adapted for use in extreme climates. For the extreme cold, where fuel is in short supply, we offer a full liner. For extreme heat, we offer net doors and a sunshade which blocks one hundred per cent of the sunlight.

[Accessories](#) include: Floors, Net Doors, Sunshades, Liners, Porches and more.

### Shipping and Storage

All Shelter Systems' Geodesic Yurts are shipped by UPS and pack up into [compact packages](#) that one person can handle take as baggage on a plane, transport in a car or store in a small space.

[Geodesic Yurt 30](#) Diameter 30' x 11' High, 706 sq', Weight 190 lb. **\$1900** Shipping \$160

[Geodesic Yurt 20](#) Diameter 20' x 10' High, 314 sq', Weight 70 lb. **\$860** Shipping \$55

[Extra Strong Yurt 20](#) Diameter 20' x 10' High, 314 sq', Weight 70 lb. **\$860** Shipping \$55

[Geodesic Yurt 18](#) Diameter 18' x 9' High, 254 sq', Weight 60 lb. **\$720** Shipping \$45

[Extra Strong Yurt 18](#) Diameter 18' x 9' High, 254 sq', Weight 60 lb. **\$720** Shipping \$45

**Geodesic Yurt 14** Diameter 14' x 7' High, 154 sq', Weight 40 lb. **\$620** Shipping \$40

[Extra Strong Yurt 14](#) Diameter 14' x 7' High, 154 sq', Weight 40 lb. **\$620** Shipping \$40

**Geodesic Yurt 11** Diameter 11'x6'4" High, 95 sq', Weight 20 lb. **\$450** Shipping \$35

**Geodesic Yurt 8** Diameter 8'x7'4" High, 50 sq', Weight 20 lb. **\$360** Shipping \$35

### Size Photo Index

The 14' is the photo above with the woman sitting in the door way.

The 18' can be seen on the [shelter page](#) and the set up page.

The 20' photos are the two photos with flags at the top of this page.

The 30' is photographed above with the truck, below with three people and on its [own page](#).

Note that the 11' Yurt and 8' Yurt are constructed using a different geometric shape that has less panels and only one door. You can see the shape of the 11' Yurt near the bottom of the [Archeology](#) page and the 8' Yurt shape at the bottom of the [GroDome](#) page (Note that this 8'er would be made out of white not clear). The 14, 18, or 20' Yurts each have four doors. The 8 Yurt and 11 Yurt do not have any windows.

Note that you get a lot more volume for your money as you goup in diameter. When you step inside the 18' Yurt after being in the 14' Yurt, the 18' er feels twice as big. Like wise the 20' Yurt feels twice the size of the 18' Yurt. This is because the extra feet in diameter extends out in all directions (including up) creating a large increase in volume. Since the surface area of the covering does not increase as rapidly as the volume, the larger domes are less expensive for the space you get. Our [drawings](#) effectively illustrate the different sizes we offer.



[Happy Customers:](#) Tell about their experiences with Shelter Systems' domes. Photo rich.

### 30-DAY RISK-FREE TRIAL 1 1/2-YEAR GUARANTEE

Our guarantee is simple. **YOU MUST BE SATISFIED!** If for any reason you're not completely pleased with your purchase, return it in original, clean condition within 30 days of receipt for a full refund or exchange as you wish. All items in this catalog have a warranty against defects in materials and workmanship for **1 1/2 years**. Should any product prove defective we will repair or replace it at no cost to you. Special Orders are not returnable. Read [Snow and Wind Warnings](#).

[To order.](#) by Fax or Mail.

[Order online with our Secure Order Form!](#)

**For fast credit card orders call 650-323-6202**

Questions? E-mail us at [shelter@best.com](mailto:shelter@best.com). Please feel free to call or write us anytime. Shelter Systems-OL, 224 Walnut St., Menlo Park, CA 94025. FAX 650-323-1220 Phone 650-323-6202.

Shelters

Greenhouses

What's New?

Gillis Designs

Stories

Q's & A's

[Price List](#)

[Shelter Systems' Map of Site](#)

Shelter Systems © 1996 - 2003 All Rights Reserved

[Shelter Systems' Home](#)



Yurts, Domes, Portable Geodesic Greenhouses, Emergency Disaster Relief Shelters, Tents, Portable Classrooms, Cabin Tents, Hot Tub and Spa Covers, Pool Covers, Guest Houses, Ski Huts, Base Camps, Youth Camps, Eco tourism Cabins, Camping Tents, Mobile Offices, Shade and Solar Structures...

[Shelters](#)
[Greenhouses](#)
[What's New?](#)
[Gillis Designs](#)
[Stories](#)
[Q's & A's](#)

## Portable Geodesic Domes

**Shelter Systems Geodesic Domes** are our most popular portable [Geotensic™](#) shelters. Known for their lightweight construction and strength as well as for the large amount of light they let in, they are made with a strong, tear-resistant fabric and non-puncturing tarp fasteners. They are truly portable and guaranteed to be leak proof. These Domes have served as family living spaces, camping tents, emergency shelters, studios, playrooms, retreats, fair pavilions, expedition tents, research tents, and more. Note that on this site we use the terms domes and yurts interchangeably.

### Easy Set Up

Our 14', 18' and 20' Domes can be set up by one person [in 30 minutes](#) without tools. Insert the interchangeable poles into factory-attached connectors spaced evenly over the cover. The poles bend slightly when inserted, tightening the cover into a wind- and waterproof shelter. The cover is freestanding requiring no guy lines and can be moved into the desired position or location without disassembly. The Dome can be taken down in 5 minutes: just remove the poles and roll up the covering.

### Sturdy Design

Domes are stronger than any other structure made of the same materials. Because of its curved shape with no corners, there are no weak points. Our patented structure is drum tight, waterproof and wind-resistant.



Shelter Systems' Dome structures have the poles on the outside with the covering [suspended](#) under the frame via Shelter Systems' own Grip Clip tarp fasteners. The frame and the covering are not in direct contact. The important benefits from this design are that the covering is under constant, even tension so that the tent will not flap or shred in the wind. The poles cannot rub against the covering, thereby wearing holes in it. Water and leaf debris do not get caught in dips between the poles since the covering is tightly suspended under the poles. The poles and covering are not touching, so there is no temperature buildup to degrade the fabric at contact points.



The [shingled](#) panels of our Domes overlap each other by 6", making the structure stronger and completely leak proof. The shingling also allows the structure to breathe. The buildup of moisture is driven out through the overlapped panels by vapor pressure and does not condense inside the tent.

Shelter Systems' patented [Grip Clips™](#) tarp fasteners join the Dome's cover to the frame. Grip Clips also fasten the shingled panels together, providing greater strength than sewn seams or any type of grommet because they do not puncture the cover, which would allow rain to enter. In addition, the Grip Clip grips a large surface area of the material which prevents the wind from tearing the tent.



### Durable Materials

Shelter Systems' Domes are made wholly of Shelter Systems' super strong, tear-proof, [woven rip stop film](#) which will not rot or mildew. The covering effectively excludes rain, dampness, wind, cold, leaves and other debris. The completely waterproof covering and the shingling's breathability make a rain fly unnecessary. The covering is manufactured in three layers which are heat bonded together. It is UV-stabilized to withstand up to 3 years of full sun exposure. The white color of the covering defuses the sun and provides 40% shade.

The frames are constructed of strong, long lasting, resilient, UV-stabilized, Class 200, 1 1/4"-diameter (3.5 cm.) PVC tubing.

### Light and Fresh Air

Shelter Systems' Portable Geodesic Domes are light filled and well ventilated. The translucent white covering creates a bright interior, transmitting 60% of the light. Our Standard Domes come with four clear vinyl windows above the doors. The Extra Strong Domes come with a translucent windows that let through more light than glass but are frosted so you can not see clearly through them. The Extra Strong windows are do not get brittle in the cold or limp in high temperatures. Shelter Systems' Domes have four flap doors evenly spaced around the shelter for good cross ventilation and light. The door coverings close automatically so you can go in or out quickly. There are no zippers to fumble with or break.

Since the panels of our Domes are shingled, overhead ventilation is easily attained by inserting "[ventilation tubes](#)" between several panels (two vent tubes are included with each shelter). When the vent tube is removed, the panels snap shut and are watertight. For maximum ventilation the walls themselves can be rolled up, transforming the domes into an [opened-arch form](#) (see 30 Dome at right in its open-arch form).



Shelter Systems' Domes are winter ready. They do not require a fly or liner for winter use. They are completely water tight and will not leak. Yet because our their [shingled construction](#) moist air is driven out through the shingling by vapor pressure. Shelter Systems' Domes being dome shaped have a minimal surface area for their volume and are thus easy to keep warm with a stove ([installation instructions](#) are included with each tent).



The dome shape has other comfort features: The interior can be divided into "rooms." The tent has more volume than a flat-sided one and therefore feels, and is, more spacious. The shape is more heat efficient because less fuel is needed to heat it plus the heat circulates more evenly. The cover of the Domes are easily cleaned with a damp cloth.

### A Shelter System

Shelter Systems' Geodesic Domes come complete with poles, 12" long high quality Durapeg stakes, guy lines for extreme wind settings, ventilation tubes, spare parts (Grips Clips and pole connectors) and a [Shelter Systems' Instruction Manual](#) that details floors, site selection, anchoring, cooling, winterizing, and stove installation. Our covers are ideally suited for most climates; however, they can be further adapted for use in extreme climates. For the extreme cold, where fuel is in short supply, we offer a full liner. For extreme heat, we offer net doors and a sunshade which blocks one hundred per cent of the sunlight.

[Accessories](#) include: Floors, Net Doors, Sunshades, Liners, Porches and more.

### Shipping and Storage

All Shelter Systems' Geodesic Domes are shipped by UPS and pack up into [compact packages](#) that one person can handle take as baggage on a plane, transport in a car or store in a small space.

[Geodesic Dome 30](#) Diameter 30 'x 11' High, 706 sq', Weight 190 lb. **\$1900** Shipping \$160

[Geodesic Dome 20](#) Diameter 20' x 10' High, 314 sq', Weight 70 lb. **\$860** Shipping \$55

[Extra Strong Dome 20](#) Diameter 20' x 10' High, 314 sq', Weight 70 lb. **\$860** Shipping \$55

[Geodesic Dome 18](#) Diameter 18' x 9' High, 254 sq',Weight 60 lb. **\$720** Shipping \$45

[Extra Strong Dome 18](#) Diameter 18' x 9' High, 254 sq',Weight 60 lb. **\$720** Shipping \$45

[Geodesic Dome 14](#) Diameter 14 'x 7' High, 154 sq', Weight 40 lb. **\$620** Shipping \$40

**[Extra Strong Dome14](#)** Diameter 14 'x 7' High, 154 sq', Weight 40 lb. **\$620** Shipping \$40

**Geodesic Dome 11** Diameter 11'x6'4" High, 95 sq', Weight 20 lb. **\$450** Shipping \$35

**Geodesic Dome 8** Diameter 8'x7'4" High, 50 sq', Weight 20 lb. **\$360** Shipping \$35

The Yurt 11 and 8 are Special Orders and are Not Returnable.

### Size Photo Index

The 14' is the photo above with the woman sitting in the door way.

The 18' can be seen on the [shelter page](#) and the set up page.

The 20' photos are the two photos with flags at the top of this page.

The 30' is photographed above with the truck, below with three people and on its [own page](#).

Note that the 11' Yurt and 8' Yurt are constructed using a different geometric shape that has less panels and only one door. You can see the shape of the 11' Yurt near the bottom of the [Archeology](#) page and the 8' Yurt shape at the bottom of the [GroDome](#) page (Note that this 8'er would be made out of white not clear). The 14, 18, or 20' Yurts each have four doors. The 8 Yurt and 11 Yurt do not have any windows.

Note that you get a lot more volume for your money as you go up in diameter. When you step inside the 18' Dome after being in the 14' Dome, the 18' er feels twice as big. Like wise the 20' Dome feels twice the size of the 18' Dome. This is because the extra feet in diameter extends out in all directions (including up) creating a large increase in volume. Since the surface area of the covering does not increase as rapidly as the volume, the larger domes are less expensive for the space you get. Our [drawings](#) effectively illustrate the different sizes we offer.



**[Happy Customers:](#)** Tell about their experiences with Shelter Systems' domes. Photo rich.

### 30-DAY RISK-FREE TRIAL 1 1/2-YEAR GUARANTEE

Our guarantee is simple. **YOU MUST BE SATISFIED!** If for any reason you're not completely pleased with your purchase, return it in original, clean condition within 30 days of receipt for a full refund or exchange as you wish. All items in this catalog have a warranty against defects in materials and workmanship for **1 1/2 years**. Should any product prove defective we will repair or replace it at no cost to you. Special Orders are not returnable. Read [Snow and Wind Warnings](#).

[To order.](#) by Fax or Mail.

**[Order online with our Secure Order Form!](#)**

**For fast credit card orders call 650-323-6202**

Questions? E-mail us at [shelter@best.com](mailto:shelter@best.com). Please feel free to call or write us anytime. Shelter Systems-OL, 224 Walnut St., Menlo Park, CA 94025. FAX 650-323-1220 Phone 650-323-6202.

[Shelters](#)

[Greenhouses](#)

[What's New?](#)

[Gillis Designs](#)

[Stories](#)

[Q's & A's](#)

[Price List](#)

[Shelter Systems' Map of Site](#)

Shelter Systems © 1996 - 2003 All Rights Reserved

[Shelter Systems' Home](#)





Yurts, Domes, Portable Geodesic Greenhouses, Emergency Disaster Relief Shelters, Tents, Portable Classrooms, Cabin Tents, Hot Tub and Spa Covers, Pool Covers, Guest Houses, Ski Huts, Base Camps, Youth Camps, Eco tourism Cabins, Camping Tents, Mobile Offices, Shade and Solar Structures...

[Shelters](#)[Greenhouses](#)[What's New?](#)[Gillis Designs](#)[Stories](#)[Q's & A's](#)

## Portable Geodesic Yurt Domes™

**Shelter Systems Geodesic Yurt Domes™** are our most popular portable [Geotensic™](#) shelters. Known for their lightweight construction and strength as well as for the large amount of light they let in, they are made with a strong, tear-resistant fabric and non-puncturing tarp fasteners. They are truly portable and guaranteed to be leak proof. These Yurt Dome shelters have served as family living spaces, camping tents, emergency shelters, studios, playrooms, retreats, fair pavilions, expedition tents, research tents, and more.

### Easy Set Up

The 14', 18' and 20' Yurt Domes can be set up by one person [in 30 minutes](#) without tools. Insert the interchangeable poles into factory-attached connectors spaced evenly over the cover. The poles bend slightly when inserted, tightening the cover into a wind- and waterproof shelter. The cover is freestanding requiring no guy lines and can be moved into the desired position or location without disassembly. The Yurt Dome can be taken down in 5 minutes: just remove the poles and roll up the covering.

### Sturdy Design

Yurt Domes™ are stronger than any other structure made of the same materials. Because of its curved shape with no corners, there are no weak points. Our patented structure is drum tight, waterproof and wind-resistant.



Shelter Systems' Yurt Dome structures have the poles on the outside with the covering [suspended](#) under the frame via Shelter Systems' own Grip Clip tarp fasteners. The frame and the covering are not in direct contact. The important benefits from this design are that the covering is under constant, even tension so that the tent will not flap or shred in the wind. The poles cannot rub against the covering, thereby wearing holes in it. Water and leaf debris do not get caught in dips between the poles since the covering is tightly suspended under the poles. The poles and covering are not touching, so there is no temperature buildup to degrade the fabric at contact points.



The [shingled](#) panels of our Yurt Domes overlap each other by 6", making the structure stronger and completely leak proof. The shingling also allows the structure to breathe. The buildup of moisture is driven out through the overlapped panels by vapor pressure and does not condense inside the tent.

Shelter Systems' patented [Grip Clips™](#) tarp fasteners join the dome's cover to the frame. Grip Clips also fasten the shingled panels together, providing greater strength than sewn seams or any type of grommet because they do not puncture the cover, which would allow rain to enter. In addition, the Grip Clip grips a large surface area of the material which prevents the wind from tearing the tent.



### Durable Materials

Shelter Systems' yurt Domes are made wholly of Shelter Systems' super strong, tear-proof, [woven rip stop film](#) which will not rot or mildew. The covering effectively excludes rain, dampness, wind, cold, leaves and other debris. The completely waterproof covering and the shingling's breathability make a rain fly unnecessary. The covering is manufactured in three layers which are heat bonded together. It is UV-stabilized to withstand up to 3 years of full sun exposure. The white color of the covering defuses the sun and provides 40% shade.

The frames are constructed of strong, long lasting, resilient, UV-stabilized, Class 200, 1 1/4"-diameter (3.5 cm.) PVC tubing.

### Light and Fresh Air

Shelter Systems' Portable Geodesic Yurt Dome shelters are light filled and well ventilated. The translucent covering creates a bright interior, transmitting 60% of the light. Yurt Domes come with four clear vinyl windows above the doors. Shelter Systems' Yurt Domes have four flap doors evenly spaced around the dome for good cross ventilation and light. The door coverings close automatically so you can go in or out quickly. There are no zippers to fumble with or break.

Since the panels of our Yurt Domes are shingled, overhead ventilation is easily attained by inserting "[ventilation tubes](#)" between several panels (two vent tubes are included with each dome). When the vent tube is removed, the panels snap shut and are watertight. For maximum ventilation the walls themselves can be rolled up, transforming the domes into an [opened-arch form](#) (see 30 Yurt Dome at right in its open-arch form).



Shelter Systems' Yurt Domes are winter ready. They do not require a fly or liner for winter use. They are completely water tight and will not leak. Yet because our their [shingled construction](#) moist air is driven out through the shingling by vapor pressure. Shelter Systems' Yurt Domes being dome shaped have a minimal surface area for their volume and are thus easy to keep warm with a stove ([installation instructions](#) are included with each tent).



The dome shape has other comfort features: The interior can be divided into "rooms." The tent has more volume than a flat-sided one and therefore feels, and is, more spacious. The shape is more heat efficient because less fuel is needed to heat it plus the heat circulates more evenly. The cover of the dome is easily cleaned with a damp cloth.

### A Shelter System

Shelter Systems' Geodesic Yurt Domes come complete with poles, 12" long quality Durapeg stakes, guy lines for extreme wind settings, ventilation tubes, spare parts (Grips Clips and pole connectors) and a [Shelter Systems' Instruction Manual](#) that details floors, site selection, anchoring, cooling, winterizing, and stove installation. Our covers are ideally suited for most climates; however, they can be further adapted for use in extreme climates. For the extreme cold, where fuel is in short supply, we offer a full liner. For extreme heat, we offer net doors and a sunshade which blocks one hundred per cent of the sunlight.

[Accessories](#) include: Floors, Net Doors, Sunshades, Liners, Porches and more.

### Shipping and Storage

All Shelter Systems' Geodesic Yurt Dome Shelters are shipped by UPS and pack up into [compact packages](#) that one person can handle take as baggage on a plane, transport in a car or store in a small space.

- [Geodesic Yurt Dome™ 30](#) Diameter 30' x 11' High, 706 sq', Weight 190 lb. **\$1900** Shipping \$160
- [Geodesic Yurt Dome™ 20](#) Diameter 20' x 10' High, 314 sq', Weight 70 lb. **\$860** Shipping \$55
- [Extra Strong Yurt Dome™ 20](#) Diameter 20' x 10' High, 314 sq', Weight 70 lb. **\$860** Shipping \$55
- [Geodesic Yurt Dome™ 18](#) Diameter 18' x 9' High, 254 sq',Weight 60 lb. **\$720** Shipping \$45
- [Extra Strong Yurt Dome™ 18](#) Diameter 18' x 9' High, 254 sq',Weight 60 lb. **\$720** Shipping \$45
- [Geodesic Yurt Dome™ 14](#) Diameter 14' x 7' High, 154 sq', Weight 40 lb. **\$620** Shipping \$40
- [Extra Strong Yurt Dome™14](#) Diameter 14' x 7' High, 154 sq', Weight 40 lb. **\$620** Shipping \$40
- [Geodesic Yurt Dome™ 11](#) Diameter 11'x6'4" High, 95 sq', Weight 20 lb. **\$450** Shipping \$35
- [Geodesic Yurt Dome™ 8](#) Diameter 8'x7'4" High, 50 sq', Weight 20 lb. **\$360** Shipping \$35

The Yurt 11 and 8 are Special Orders and are Not Returnable.

### Size Photo Index

The 14' is the photo above with the woman sitting in the door way.

The 18' can be seen on the [shelter page](#) and the set up page.

The 20' photos are the two photos with flags at the top of this page.

The 30' is photographed above with the truck, below with three people and on its [own page](#).

Note that the 11' Yurt and 8' Yurt are constructed using a different geometric shape that has less panels and only one door. You can see the shape of the 11' Yurt near the bottom of the [Archeology](#) page and the 8' Yurt shape at the bottom of the [GroDome](#) page (Note that this 8'er would be made out of white not clear). The 14, 18, or 20' Yurts each have four doors. The 8 Yurt and 11 Yurt do not have any windows.

Note that you get a lot more volume for your money as you go up in diameter. When you step inside the 18' yurt after being in the 14' yurt, the 18' er feels twice as big. The 20' yurt feels twice the size of the 18' yurt. This is because the extra feet in diameter extends out in all directions (including up) creating a large increase in volume. Since the surface area of the covering does not increase as rapidly as the volume, the larger domes are less expensive for the space you get. Our [drawings](#) effectively illustrate the different sizes we offer.



[Happy Customers:](#) Tell about their experiences with Shelter Systems' domes. Photo rich.

### 30-DAY RISK-FREE TRIAL 1 1/2-YEAR GUARANTEE

Our guarantee is simple. **YOU MUST BE SATISFIED!** If for any reason you're not completely pleased with your purchase, return it in original, clean condition within 30 days of receipt for a full refund or exchange as you wish. All items in this catalog have a warranty against defects in materials and workmanship for **1 1/2 years**. Should any product prove defective we will repair or replace it at no cost to you. Special Orders are not returnable. Read [Snow and Wind Warnings](#).

[To order.](#) by Fax or Mail.

[Order online with our Secure Order Form!](#)

**For fast credit card orders call 650-323-6202**

Questions? E-mail us at [shelter@best.com](mailto:shelter@best.com). Please feel free to call or write us anytime. Shelter Systems-OL, 224 Walnut St., Menlo Park, CA 94025. FAX 650-323-1220 Phone 650-323-6202.

[Shelters](#)

[Greenhouses](#)

[What's New?](#)

[Gillis Designs](#)

[Stories](#)

[Q's & A's](#)

[Price List](#)

[Shelter Systems' Map of Site](#)

Shelter Systems © 1996 - 2003 All Rights Reserved

[Shelter Systems' Home](#)



Shelters

Greenhouses

What's New?

Gillis Designs

Stories

Q's & A's

## Shelter Systems' 30' Yurt and Dome™

Shelter Systems produces a 30'-diameter Yurt and Dome. These large structures can be used for adventure and research expeditions and archaeological digs around the world; trade fairs and exhibitions; weddings, parties and other large social gatherings; retreats; emergency relief shelters; and more. The 30'-diameter Yurt and Dome is very versatile!



**Shelter Systems 30' (9 m) 11' tall Yurt and Dome™: \$1900 Shipping \$160**

**The 30' Yurt and Dome™** is made wholly of a white Shelter Systems' covering, a superstrong [woven ripstop film](#). We also make the 30' out of our translucent Greenhouse covering. All fabrics we use have been treated with ultraviolet inhibitors which protect against sun exposure, are watertight, and will not rot or mildew.

The frame is constructed of strong, long-lasting PVC tubing. Patented Grip Clips™ join the Yurt's cover to the frame. Grip Clips provide greater strength than sewn seams or any type of grommet, because they do not puncture the cover. Each panel of the dome is [shingled](#) over the next so that the dome breathes yet is completely waterproof!



**30' being carried**

**The 30' Yurt and Dome** has eight doors. The door coverings close automatically so you can go in or out quickly. There are no

## Large Diameter Yurt, Dome Structures

zippers to fumble with or break. The optional clear vinyl windows (photo at right) are above the doors. For maximum ventilation the walls themselves can be rolled up (photo at right). There is always plenty of light and fresh air in the 30' Yurt, Dome. Photo at right shows placement of windows. Doors are below the windows.



### Easy Set-Up

Your 30' Yurt and Dome goes up in one hour without tools. You simply insert interchangeable poles into connectors spaced evenly over the cover. The poles bend slightly when inserted, which tightens the cover into a wind- and waterproof dynamic shelter. Because of its large size and weight, the 30' requires two strong persons working together to put it up. Since the dome is freestanding, you can turn or move the dome into desired position after it is up. When your Dome is not being used, you can take out the poles, roll it up, and store it.



**Setting up the 30'er takes 2 people about 1 hour.**

### A Shelter System

The 30' Yurt and Dome comes complete with stakes, guy lines, vent tubes, spare parts and an [Instruction Manual](#) that details floors, site selection, anchoring, cooling, winterizing, and stove installation.



**Inside the 30' Yurt and Dome**  
Customized with Black diamonds.

### Accessories:

**Floor \$270** Cut to shape, with Grip Clips and cord to tie to the inside of the dome. Shipping and Handling \$35.

**Clear Vinyl Windows \$25 each.** Up to 8 windows can be added to your dome. They go in the triangular panels above the doors. This must be done at our factory.

**SunShade 8' x 20' \$70** An Extra Large SunShade with Heavy-Duty Grip Clips and attachment cords will help keep your dome cool if you cannot set it up in the shade. Shipping and Handling \$15.

**Full Liner \$1550** Ties inside the to create an insulating air space. Shipping and Handling \$130.

**Other Accessories** To make your dome even more comfortable.



**30' Yurt and Dome packed up. Weight: Poles:120 lbs. Cover: 70 lbs. Total: 190 lbs.**

**Yurt and Dome 30' (9 m) diameter 11' tall: \$1900 Shipping \$160**



**Special Orders Yurt and Dome™ 31.5' diameter Hemisphere 16' tall: \$2800 Shipping \$320**



**Special Order Yurt and Dome 30' diameter Bubble Dome 20' tall: \$3700 Shipping \$520**

### **30-DAY RISK-FREE TRIAL 1 1/2-YEAR GUARANTEE**

Our guarantee is simple. **YOU MUST BE SATISFIED!** Everything in this catalog is offered for 30 days' free trial. If for any reason you're not completely pleased with your purchase, return it in original condition within 30 days of receipt for a full refund or exchange as you wish. All items in this catalog have a warranty against defects in materials and workmanship for **1 1/2 years**. Should any product prove defective we will repair or replace it at no cost to you. Special Orders are not returnable.

[To order.](#) by Fax or Mail.

[Order online with our Secure Order Form!](#)

**For fast credit card orders call 650-323-6202**

Questions? E-mail us at [shelter@best.com](mailto:shelter@best.com). Please feel free to call or write us anytime. Shelter Systems-OL, 224 Walnut., Menlo Park, CA 94025. FAX 650-323-1220 Phone 650-323-6202.

[Shelters](#)

[Greenhouses](#)

[What's New?](#)

[Gillis Designs](#)

[Stories](#)

[Q's & A's](#)

[Price List](#)

[Shelter Systems' Map of Site](#)

Shelter Systems © 1996 - 2003 All Rights Reserved

[Shelter Systems' Home](#)

[Shelters](#)[Greenhouses](#)[What's New?](#)[Gillis Designs](#)[Stories](#)[Q's & A's](#)

## The BubbleDome™ Yurt Dome

The **BubbleDome™** line was developed to provide maximum interior space with a minimum footprint. We have taken our standard Solar and GroDomes and added an additional band of poles and covering to the bottom, which creates more height. The walls actually come in a little at the bottom, like a bubble, so the diameter at the ground is about a foot less than the widest part of the dome. Note that the BubbleDomes have only one door. We have also removed one pole section to allow for a tall door so that you can walk in without bending. The BubbleDome has a unique and friendly look that you will be proud to use.



**BubbleDome™ 10' as a Greenhouse**





**Inside The 10' BubbleDome™ Greenhouse**



The 10' Bubble Dome set up as an [Open-Arched](#) Yurt Dome™ at a Trade Show.



**The BubbleDome™ 20**



**Looking up at the window in the BubbleDome™ 20.**



**The BubbleDome™ 20 Packed up.**

- BubbleDome 10:** Diameter 9' Height 8.5' Weight 35 lb. **\$520** Shipping \$35
- BubbleDome 14:** Diameter 12' Height 11' Weight 50 lb. **\$840** Shipping \$55
- BubbleDome 18:** Diameter 15.5' Height 13' Weight 75 lb. **\$1020** Shipping \$65
- BubbleDome 20:** Diameter 17' Height 15' Weight 90 lb. **\$1290** Shipping \$70
- BubbleDome 31:** Diameter 31.5' Height 16' Weight 230 lb. **\$2800** Shipping by truck
- Extra BubbleDome 30:** Diameter 30' Height 20' Weight 270 lb. **\$3700** Shipping by truck

**The Bubble Dome 14, 18, 20, 30 and 31 are Special Orders.**

[Happy Customers:](#) Tell about their experiences with Shelter Systems' domes. Photo rich.

Be sure to let us know if you want your dome to be made of the White SolarDome or Translucent GroDome covering.

### **30-DAY RISK-FREE TRIAL 1 1/2-YEAR GUARANTEE**

Our guarantee is simple. **YOU MUST BE SATISFIED!** If for any reason you're not completely pleased with your purchase, return it in original, clean condition within 30 days of receipt for a full refund or exchange as you wish. All items in this catalog have a warranty against defects in materials and workmanship for **1 1/2 years**. Should any product prove defective we will repair or replace it at no cost to you. Special Orders are not returnable. Read [Snow and Wind Warnings](#).

[To order](#), by Fax or Mail.

[Order online with our Secure Order Form!](#)

**For fast credit card orders call 650-323-6202**

Questions? E-mail us at [shelter@best.com](mailto:shelter@best.com). Please feel free to call or write us anytime. Shelter Systems-OL, 224 Walnut St., Menlo Park, CA 94025. FAX 650-323-1220 Phone 650-323-6202.

[Shelters](#)

[Greenhouses](#)

[What's New?](#)

[Gillis Designs](#)

[Stories](#)

[Q's & A's](#)

[Price List](#)

[Shelter Systems' Map of Site](#)

**Shelter Systems** © 1996 - 2003 All Rights Reserved

[Shelter Systems' Home](#)

[Shelters](#)[Greenhouses](#)[What's New?](#)[Gillis Designs](#)[Stories](#)[Q's & A's](#)

## Tunnel Shelters

The tunnel-shaped **CrystalCave™** shelter was designed for those who wish to cover a rectangular space. Both sizes of the sturdy yet lightweight CrystalCave have been used by imaginative customers for a variety of outdoor uses, for instance, as carports and workshops! CrystalCaves can be placed end to end to produce a longer enclosure. The CrystalCave is freestanding and portable. It's covered with a strong, waterproof ripstop film. CrystalCaves have been used as emergency relief shelters in Guatemala by the United States Government.

### Easy Set Up

Your CrystalCave™ arrives with all hubs and clips attached. Just slip the interchangeable poles into the hubs and in 40 minutes your CrystalCave is complete. It's very easy. Once up, you may lift or turn your CrystalCave into position. If your CrystalCave needs to be transported or stored, it can be disassembled in 5 minutes by removing the poles and rolling it into a compact bundle. You can dramatically extend the sun life of your CrystalCave by storing it when not in use.

### Sturdy Design

The strong woven, laminated [ripstop film](#) used in all our structures has been treated with ultraviolet inhibitors to insure extra long life. (The translucent film used in our [CrystalCave Greenhouse](#)



transmits 90% of visible light. ) Unique to Shelter Systems' structures are the molded [clips](#) at each hub. They are made of an extremely durable plastic. The importance of these components lies in the fact that they grip the film without puncturing it - there are no weak points to tear out in Shelter Systems structures.

### Proven Performance

The tension achieved by the network of hubs and poles keeps the film stretched tight in the wind, preventing tear through wind vibration. The CrystalCave's doors (one at each end) have been designed to bypass the need for zippers. We use hook closures. Zippers are notorious for breaking after a short working life. Our experience has shown that, without them, our doors can't malfunction! An added benefit: there is no sill of material spanning the entrance at ground level. This means that when the doors are open, you have complete access for rolling wheeled carts in and out.



**CrystalCave™ being used on an archeological dig.**

### **Complete Shelter System**

The CrystalCave comes complete with clips and connectors attached to covering, poles, stakes, and instruction manual.



**A CrystalCave™ used as a workshop.**

**CrystalCave™ Shelter 9:** 9'x9'x7' High, Weight: 40 lb. **\$550** Ship \$45  
**CrystalCave™ Shelter 11:** 11'x11'x7' High, Weight: 51 lb. **\$680** Ship \$55

Crystal Caves are by special order only.  
Available in translucent, white, or white/black. Be sure to tell us which covering you want.

### **1 1/2-YEAR GUARANTEE**

All items in this catalog have a warranty against defects in materials and workmanship for **1 1/2 years**. Should any product prove defective we will repair or replace it at no cost to you. Special Orders are not returnable; since we do not offer them in our catalog and we would have trouble reselling them.

[To order.](#) by Fax or Mail.

[Order online with our Secure Order Form!](#)

**For fast credit card orders call 650-323-6202**

Questions? E-mail us at [shelter@best.com](mailto:shelter@best.com). Please feel free to call or write us anytime. Shelter Systems-OL, 224 Walnut St., Menlo Park, CA 94025. FAX 650-323-1220 Phone 650-323-6202.

[Shelters](#)

[Greenhouses](#)

[What's New?](#)

[Gillis Designs](#)

[Stories](#)

[Q's & A's](#)

[Price List](#)

[Shelter Systems' Map of Site](#)

**Shelter Systems** © 1996 - 2001 All Rights Reserved

[Shelter Systems' Home](#)



Shelters

Greenhouses

What's New?

Gillis Designs

Stories

Q's & A's

## BikeShed™ Bicycle Shed

Shelter Systems' **BikeShed™** bicycle shed will keep your bikes dry and clean in all types of weather. The BikeShed bicycle shed sets up in 15 minutes and stores up to three bicycles at a time. If the weather is not too windy, you can leave one door end open so you can roll in your bikes easily. You can bolt a large "eye" bolt to your wall to lock your bikes to. In windy wet weather you can hook the door closed. The BikeShed is free standing and lightweight which means you can easily move it around. Clips with cords are provided so you can attach your BikeShed to your fence or wall. The BikeShed can also be used as a greenhouse to start seedlings or to overwinter plants, store tools, or as a shed to dry firewood, etc.



### Sturdy Design

The Bike Shed's covering is a superstrong, woven, translucent [ripstop film](#). It is treated with ultraviolet inhibitors, which protect it against sun exposure. The covering will not rot or mildew. The Bike Shed's frame is constructed of strong, long-lasting PVC tubing. Patented Grip Clips join the Bike Shed's cover to the frame. Grip Clips provide greater strength than sewn seams or any type of grommet, because they do not puncture the cover. The Bike Shed is [shingled](#) over the two doors, so that the shed breathes yet is completely leakproof!



### **Up In 15 Minutes!**

You will be pleased with how easily your Bike Shed goes up in 15 minutes without tools. You simply insert interchangeable poles into connectors spaced evenly over the cover. The poles bend slightly when inserted, which tightens the cover into a wind- and waterproof dynamic shelter. Turn or move the shed into desired position. If your Bike Shed is not being used, just take out the poles, roll up the dome, and store it in a closet or on a shelf.

### **A Shelter System**

Each Bike Shed comes complete with two doors, stakes, and a detailed [Bike Shed Instruction Manual](#).

**BikeShed™ Bicycle Shelter 3'x5.5'x6' Tall \$185 Shipping \$20**

**30-DAY RISK-FREE TRIAL 1 1/2-YEAR GUARANTEE**



Our guarantee is simple. **YOU MUST BE SATISFIED!** If for any reason you're not completely pleased with your purchase, return it in original, clean condition within 30 days of receipt for a full refund or exchange as you wish. All items in this catalog have a warranty against defects in materials and workmanship for **1 1/2 years**. Should any product prove defective we will repair or replace it at no cost to you. Special Orders are not returnable. Read [Snow and Wind Warnings](#).

[To order](#), by Fax or Mail.

[Order online with our Secure Order Form!](#)

**For fast credit card orders call 650-323-6202**

Questions? E-mail us at [shelter@best.com](mailto:shelter@best.com). Please feel free to call or write us anytime. Shelter Systems-OL, 224 Walnut St., Menlo Park, CA 94025. FAX 650-323-1220 Phone 650-323-6202.

[Shelters](#)

[Greenhouses](#)

[What's New?](#)

[Gillis Designs](#)

[Stories](#)

[Q's & A's](#)

[Price List](#)

[Shelter Systems' Map of Site](#)

**Shelter Systems** © 1996 - 2001 All Rights Reserved

[Shelter Systems' Home](#)



Shelters

Greenhouses

What's New?

Gillis Designs

Stories

Q's & A's

## Solar Structures™

**Shelter Systems'** portable, lightweight Solar Structures are covered with our [Translucent Greenhouse Covering](#) and can be used to capture and hold solar energy. Our Solar Structures come in many shapes and sizes. A [Half Dome](#) attaches to a house to catch and hold the sun's warmth. If the HalfDome encloses a window or door, these can be opened during the day to allow collected heat to enter the house. A long [GroRow](#) can be used to collect solar heat by attaching it to a wall of a house or the ground.



An 11' [GroRow](#) with Greenhouse Covering



[RoofShells™](#) can be inverted and used as solar collectors.

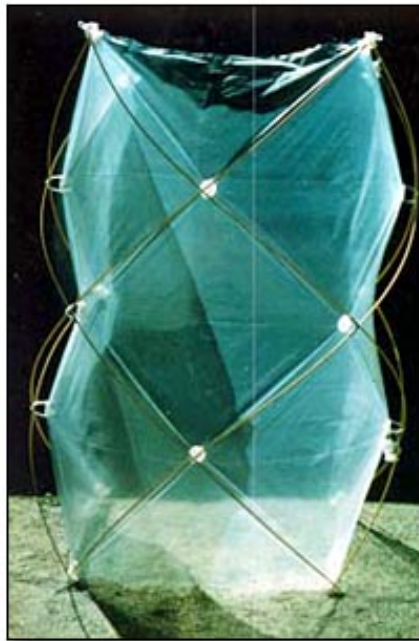

Shelter Systems can make **SolarTubes**. Used primarily as a thermal chimney to vent hot air from the building attached to it. Also used to create a suction to pull in and circulate warm air in a house from an attached solar collector.



Our [Solariums](#) are made with a lightweight construction. They let more light through than glass. Our Solariums have been used to expand family living spaces, to create studios, playrooms, retreats, sun rooms, attached greenhouses, and more.

See also [Special Shapes](#) , [Solariums](#) and [Custom Domes and Greenhouses](#).

Custom Domes where the covering or shape has been custom-made for you are not returnable since we might have trouble reselling these.

### **30-DAY RISK-FREE TRIAL 1 1/2-YEAR GUARANTEE**

Our guarantee is simple. **YOU MUST BE SATISFIED!** If for any reason you're not completely pleased with your purchase, return it in original, clean condition within 30 days of receipt for a full refund or exchange as you wish. All items in this catalog have a warranty against defects in materials and workmanship for **1 1/2 years**. Should any product prove defective we will repair or replace it at no cost to you. Special Orders are not returnable. Read [Snow and Wind Warnings](#).

[To order](#). by Fax or Mail.

[Order online with our Secure Order Form!](#)

**For fast credit card orders call 650-323-6202**

Questions? E-mail us at [shelter@best.com](mailto:shelter@best.com). Please feel free to call or write us anytime. Shelter Systems-OL, 224 Walnut St., Menlo Park, CA 94025. FAX 650-323-1220 Phone 650-323-6202.

[Shelters](#)

[Greenhouses](#)

[What's New?](#)

[Gillis Designs](#)

[Stories](#)

[Q's & A's](#)

[Price List](#)

[Shelter Systems' Map of Site](#)

**Shelter Systems** © 1996 - 2001 All Rights Reserved

[Shelter Systems' Home](#)



Shelters

Greenhouses

What's New?

Gillis Designs

Stories

Q's & A's

## Shelter Systems' Portable Roof Shell™ Structures

Shelter Systems' **Portable Roof Shell™ Structures** are thin sections of spheres or tunnels made from a lightweight, strong, waterproof, ripstop film which is either white, translucent or black/white. They are useful for making jacuzzi covers by simply setting them over your spa; rain and sun porches by tying them to buildings, poles or trees with our attached clips; portable greenhouses by setting them on the ground or over a hole you've dug and can then walk into (ventilation can be provided by propping up one end); quick sheds by setting them on 8' 4x4's sunk in the ground with plywood walls attached; and other low-arched roofs.



Shelter Systems' Roof Shell Structures are curved outward, which makes them stiff, strong and light.



**The 6-sided 10' Roof Shell™ above is 10' across.**



**The arched Porch Shell™ 5' X 5'.**



**Roof Top™ 16' (Translucent Top of 18'er).**

When made of our translucent greenhouse material, Shelter Systems' Roof Shell Structures make low-arched portable greenhouses.



Above are two photos showing a Shelter Systems' Roof Top™ used as a [Spa Cover™](#).

**Porch Shell™ 5' x 5' \$68.** Shipping: \$10

**Roof Shell™ 10' \$185** Shipping \$22

**Roof Top™ 8' (Top of 10'er) \$280** Shipping \$20

**Roof Top™ 12.5' (Top of 14'er) \$345** Shipping \$25

**Roof Top™ 16' (Top of 18'er) \$400** Shipping \$25

**Roof Top™ 18' (Top of 20'er) \$495** Shipping \$35

**Roof Top™ 25' (Top of 30'er) \$1400** Shipping \$110

Be sure to let us know if you want your Roof Shell, Porch Shell or Roof Top to be made of the White SolarDome, Translucent GroDome, or White and Black SunShade™ [coverings](#).

**Roof Shells™ and Roof Tops™ are Special Orders**

To see the [Roof Shell™ Manual](#).

### **30-DAY RISK-FREE TRIAL 1 1/2-YEAR GUARANTEE**

Our guarantee is simple. **YOU MUST BE SATISFIED!** If for any reason you're not completely pleased with your purchase, return it in original, clean condition within 30 days of receipt for a full refund or exchange as you wish. All items in this catalog have a warranty against defects in materials and workmanship for **1 1/2 years**. Should any product prove defective we will repair or replace it at no cost to you. Special Orders are not returnable. Read [Snow and Wind Warnings](#).

[To order](#). by Fax or Mail.

[Order online with our Secure Order Form!](#)

**For fast credit card orders call 650-323-6202**

Questions? E-mail us at [shelter@best.com](mailto:shelter@best.com). Please feel free to call or write us anytime. Shelter Systems-OL, 224 Walnut St., Menlo Park, CA 94025. FAX 650-323-1220 Phone 650-323-6202.

[Shelters](#)

[Greenhouses](#)

[What's New?](#)

[Gillis Designs](#)

[Stories](#)

[Q's & A's](#)

[Price List](#)

[Shelter Systems' Map of Site](#)

Shelter Systems © 1996 - 2003 All Rights Reserved





[Shelters](#)
[Greenhouses](#)
[What's New?](#)
[Gillis Designs](#)
[Stories](#)
[Q's & A's](#)

## Solariums and Sun Rooms

**Shelter Systems'** Solarium sun rooms, attached to a house, will catch and hold the sun's warmth. If the Solarium encloses a window or door, these can be opened during the day to allow collected heat to enter the house.

Our Solarium sun rooms are known for their lightweight construction as well as for the large amount of light they let in, more than glass. These Solariums have served to expand family living spaces, to create studios, playrooms, retreats, sun rooms, attached greenhouses, and more.



### Sturdy Design

The Solarium is made wholly of a White or Translucent superstrong, [woven ripstop film](#). All fabrics we use have been treated with ultraviolet inhibitors which protect against sun exposure, are watertight, and will not rot or mildew.

The frame of the Solarium is constructed of strong, long-lasting PVC tubing. Patented Grip Clips™ join the Solarium's cover to the frame. Grip Clips™ provide greater strength than sewn seams or any type of grommet, because they do not puncture the cover. Each panel of our Solarium is [shingled](#) over the next so that they breathe, yet are completely leakproof!

### Light and Fresh Air

The Solarium 14, 18, and 20 have two flap doors; one to each side. The door coverings close automatically so you can go in or out quickly. There are no zippers to fumble with or break. Clear vinyl windows above the doors let you see out.

### Easy Set-Up [Setting up a Shelter Systems' dome](#)

You will be pleased with how easily your Solarium sets up in 30 minutes without tools. You simply insert interchangeable poles into connectors spaced evenly over the cover. The poles bend slightly when inserted, which tightens the cover into a wind- and waterproof dynamic shelter. Turn or move the dome into desired position. When your Solarium is not being used, just take out the poles, roll up the dome, and store it in a closet. Storage, when not in use, will extend the life of the covering.

### Attaching the Solarium

The Solarium is attached to your house by means of a 6" skirt of the superstrong film. This 6" skirt extends along the entire edge which attaches to your house. Since the type of house siding you have determines how you attach the Solarium to your house, we do not include nails, screws or other hardware for attachment. We provide a [manual](#) telling you how to put up your Solarium, with suggestions on how to attach it to various types of houses. It takes about 30 minutes to attach the Solarium.

### A Shelter System

The Solarium come complete with stakes, guy lines, vent tubes, spare parts and an [instruction booklet](#) that details floors, anchoring, how to attach the Solariums to your house cooling, winterizing, and stove installation.

You get a lot more volume as you go up in diameter. When you step inside the 18' after just being in the 14', the 18' feels twice as big. The 20' feels twice the [size](#) of the 18'. This is because the extra feet in diameter extends out in all directions creating a large increase in volume. Since the surface area of the covering does not increase as rapidly as the volume, the larger Solariums are less expensive for the amount of space you get.

### All Solariums are Special Orders

**Solarium 14:** Diameter 14' Height 7' Weight 28 lb. **\$400** Shipping \$35

**Solarium 18:** Diameter 18' Height 9' Weight 45 lb. **\$490** Shipping \$40

**Solarium 20:** Diameter 20' Height 10' Weight 50 lb. **\$550** Shipping \$45

See also [HalfDomes](#) , [Solar Structures](#) and [Custom Domes and Greenhouses](#)

Be sure to let us know if you want your Solarium to be made of the White Solar Dome or the Translucent GroDome covering.

### 30-DAY RISK-FREE TRIAL 1 1/2-YEAR GUARANTEE

Our guarantee is simple. **YOU MUST BE SATISFIED!** If for any reason you're not completely pleased with your purchase, return it in original, clean condition within 30 days of receipt for a full refund or exchange as you wish. All items in this catalog have a warranty against defects in materials and workmanship for **1 1/2 years**. Should any product prove defective we will repair or replace it at no cost to you. Special Orders are not returnable. Read [Snow and Wind Warnings](#).

[To order.](#) by Fax or Mail.

[Order online with our Secure Order Form!](#)

**For fast credit card orders call 650-323-6202**

Questions? E-mail us at [shelter@best.com](mailto:shelter@best.com). Please feel free to call or write us anytime. Shelter Systems-OL, 224 Walnut St., Menlo Park, CA 94025. FAX 650-323-1220 Phone 650-323-6202.

[Shelters](#)

[Greenhouses](#)

[What's New?](#)

[Gillis Designs](#)

[Stories](#)

[Q's & A's](#)

[Price List](#)

[Shelter Systems' Map of Site](#)

Shelter Systems © 1996 - 2001 All Rights Reserved

[Shelter Systems' Home](#)



Shelters

Greenhouses

What's New?

Gillis Designs

Stories

Q's &amp; A's

## ShelterShade™ Awnings

Shelter Systems' **ShelterShade™ Awnings** can keep your ouse cooler in the summer, save you up to 30 percent on air conditioning costs, and protect furnishings and draperies from fading. ShelterShades are easy to attach to your windows with provided eye screws. The size of the shade is adjusted to your windows by cutting the shade material before attaching the Grip Clips.



**ShelterShades™** Parts needed 6' by 6' White-and-Black shade covering, 4 Grip Clips, 6 Cords, 3 PVC 1" - 5.5' poles, 4 eye screws, cords. See [Accessories](#).

First attach Grip Clips to the corners of shade covering so that the ring part of the clip is on the white side of the shade and so the clips are spaced right for your window and the PCV pole to tension the shade.

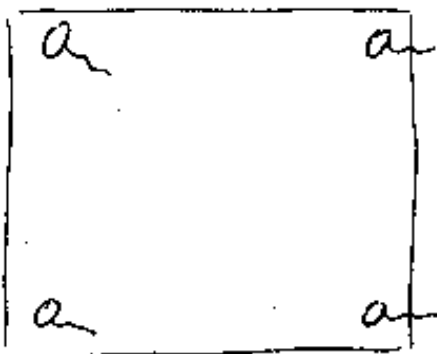

Next attach the ends of two poles to each of two of the clips with the cord provided. One of the poles must span the two clips the other two poles will extend out from the clips.

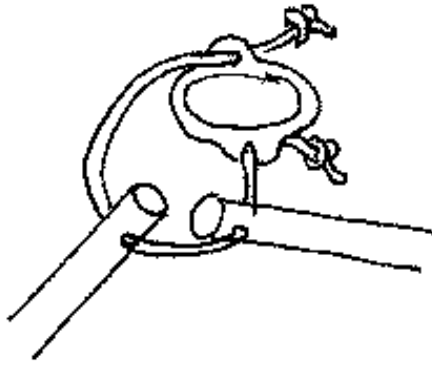

Now attach hold fasts to your window frame above your window to tie your shade and below your window to tie the lower poles.

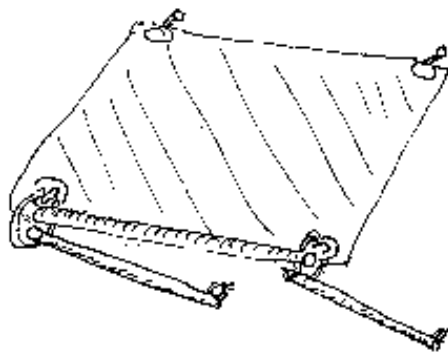

**Note:** We provide "eye" screws which work for most wood as hold fasts, you may need to buy other types of hold fasts from your hardware store to attach your shade to your window frame or house; you should make sure that whatever means you use that it will not damage your house and will remain secure even in strong wind.

We recommend that you take your shade down for the winter to avoid snow damage.

Questions? E-mail us at [shelter@best.com](mailto:shelter@best.com). Please feel free to call or write us anytime. Shelter Systems-OL, 224 Walnut St., Menlo Park, CA 94025. FAX 650-323-1220 Phone 650-323-6202.

Shelters

Greenhouses

What's New?

Gillis Designs

Stories

Q's & A's

Shelter Systems © 1996 - 2001 All Rights Reserved

[Shelter Systems' Home](#)



Shelters

Greenhouses

What's New?

Gillis Designs

Stories

Q's & A's

Shelter Systems' **Arch Tent™** Kit makes a great rain or sun shelter. It covers 20' x26' of ground and since it is open all around, it allows for excellent ventilation. We love the **Arch Tent** and have used it at parties to create shade and rain protection for guests and to provide a festive focal point. See [Small Arch Tent](#)



**Plans including tarp fasteners \$100 Shipping \$5**



**Plans including tarp fasteners \$100 Shipping \$5**

Plans give dimensions, all Heavy Duty Grip Clips needed and instructions. **Plans are not returnable.**

**Additional materials needed:** about \$80: tarp, 3/8" cord, PVC pipe.

[See other Plans.](#)

Questions? E-mail us at [shelter@best.com](mailto:shelter@best.com). Please feel free to call or write us anytime. Shelter Systems-OL, 224 Walnut St., Menlo Park, CA 94025. FAX 650-323-1220 Phone 650-323-6202.

Shelters

Greenhouses

What's New?

Gillis Designs

Stories

Q's & A's

Shelter Systems © 1996 - 2001 All Rights Reserved

[Shelter Systems' Home](#)

[Shelters](#)[Greenhouses](#)[What's New?](#)[Gillis Designs](#)[Stories](#)[Q's & A's](#)

## Tent Structures that Block the Wind

Shelter Systems' **Wind Wall**™ wind barriers are 5'-high sections of tent structures that block and stop the wind. The "Arch" Wind Wall™ wind barriers and "Open Circle" Wind Wall wind barriers are vertical sections of Shelter Systems' GroRows and Crystal Caves. The "Arch" is a partial circle, and the ends of the "Open Circle" are close together.

The "Circle" and "Half Circle" Wind Wall™ wind barriers are the horizontal lower wall sections of our domes and they lean inward a bit. The "Circle" is an entire horizontal slice. The "Half Circle" is half of a horizontal slice--like cutting a pie in halves. All four wind wall barriers are available in different lengths and/or sections of circles. They are arched and freestanding. You can put them up in about 15 minutes. Stakes are provided for securing them to the ground. See set up [Instructions](#).



**Arch Wind Wall™ wind barrier 5' high, 6' length (above) \$68 Shipping \$15**

**Arch Wind Wall 5' high, 9' length \$90 Shipping \$30**

**Arch Wind Wall 5' high, 17' length \$150 Shipping \$30**

**Open Circle Wind Wall 5' high, 9' diameter \$160 Shipping \$35**

**Open Circle Wind Wall 5' high, 11' diameter \$250 Shipping \$35**



**Circle Wind Wall 5' high, 30' diameter (above) \$550 Shipping \$60**

**Circle Wind Wall 5' high, 20' diameter \$450 Shipping \$35**

**Circle Wind Wall 5' high, 18' diameter \$360 Shipping \$35**

**Circle Wind Wall 4.5' high, 14' diameter \$280 Shipping \$30**

**Circle Wind Wall 4' high, 10' diameter \$220 Shipping \$25**

**Half Circle Wind Wall 5' high, 30' across \$240 Shipping \$60**

**Half Circle Wind Wall 5' high, 20' across \$230 Shipping \$30**

**Half Circle Wind Wall 5' high, 18' across \$190 Shipping \$25**

**Half Circle Wind Wall 4.5' high, 14' across \$180 Shipping \$22**

Be sure to let us know whether you want your Wind Wall to be made of the White Yurt Dome covering, the Translucent Greenhouse covering, or the White/Black sun block covering.

**All Wind Walls are by special order only.**

**1 1/2-YEAR GUARANTEE**

All items in this catalog have a warranty against defects in materials and workmanship for **1 1/2 years**. Should any product prove defective we will repair or replace it at no cost to you. Special Orders are not returnable; since we do not offer them in our catalog and we would have trouble reselling them.

[To order.](#) by Fax or Mail.

[Order online with our Secure Order Form!](#)

**For fast credit card orders call 650-323-6202**

Questions? E-mail us at [shelter@best.com](mailto:shelter@best.com). Please feel free to call or write us anytime. Shelter Systems-OL, 224 Walnut St., Menlo Park, CA 94025. FAX 650-323-1220 Phone 650-323-6202.

Shelters

Greenhouses

What's New?

Gillis Designs

Stories

Q's & A's

[Price List](#)

[Shelter Systems' Map of Site](#)

**Shelter Systems © 1996 - 2001 All Rights Reserved**

[Shelter Systems' Home](#)





## **Emergency and Disaster Relief Portable Geodesic Yurt and Dome Tent Shelters, Quonset Shaped Tent Shelters, Shelter Frames, and Grip Clips™ Tarp Fasteners**

**Durable, watertight, wind-resistant, pleasant to live in, easily to set up, and affordable.**

---

### **Shelter Systems' Emergency and Disaster Relief Portable Geodesic Yurt and Dome Tent Shelters**

Have been sheltering families for extended periods of time in all climates for over 20 years. Shelter Systems' Emergency Disaster Relief Tents are made of a strong, tear-resistant fabric and non-puncturing tarp fasteners. Shelter Systems' Relief Tents offer the best value because they are durable, watertight, wind-resistant, pleasant to live in, easily to set up, and affordable.



### **[Emergency and Disaster Relief Portable Geodesic Yurt Dome™ Tent Shelters](#)**

---

**18 foot (5.4 meter) Emergency Relief Tent Shelters** Quantities of 1000 \$300.00 each



**The 30' (9 m) Emergency Disaster Relief Tents make excellent community focal points for "villages" of smaller shelters.** Meeting rooms, logistics, hospitals, chapels, storage, wherhouses, schools, and more.

Quantities of 20 **\$800.00 each**

---

[See More Photos of Shelter Systems' Relief Tents in use](#)

---

## **Shelter Systems' Newest ReliefTent "**



- Completely waterproof (no sewing - can not leak).
- Bath tub floor (floor extends up side wall inside of tent 4").
- 17' diameter 8 sided circular bath tub floor (230 square foot floor).
- 7.5' tall (lots of stand able space).
- Affordable. Low cost parts, extremely simple production (12 Clips; no sewing; two PVC poles).
- Light, compact packaged product (12" x 12" x 44 " box 26 lbs) Low cost shipping. Extremely portable.

- Strong in wind (streamline shape shed wind well - drum tight).
  - Sheds snow well (steep walls shed snow well).
  - Two walk in doors (can be fixed with netting and to auto close) Doors hook closed and have Velcro.
  - Excellent ventilation (two doors extending to peak and upper vent) Upper vent closes with Velcro.
  - Simple set up (stake out - insert two poles).
  - No guy lines (tent is self guying).
  - Available with winterizing liner and stove and stove jack.
  - Tent can be disassembled by user and the parts can be reassembled with out tools into other shelters or sheds.
  - PVC poles can be used for plumbing after shelter is no longer needed.
- 

## **ShelterFirst™ Tarp Tent Emergency and Disaster Relief Shelters**



[ShelterFirst™ Emergency and Disaster Relief Tent Shelters](#)

---

## **Emergency and Disaster Relief Portable Tunnel or Quonset Shaped Tent Shelters**



### [Emergency and Disaster Relief Portable Tunnel or Quonset Shaped Tent Shelters](#)

## **Shelter Systems' Emergency and Disaster Relief Shelter Frames**

Our Frame Kits are designed to utilize an approximate 24' by 24' sheet of OFDA plastic sheeting although it is compatible to use with other sizes and types of covering materials. The PVC frame is intended to be configured in a specific domed shape that couples with Shelter Systems non puncturing Grip Clips to covering in a strength enhancing manor to create the maximum strength for the materials used. The frame and instructions also suggest many other possible configurations that the end user might find more appropriate to their needs. When the shelter frame is no longer needed, each section of the PVC frame is easily joined to its self to create a continuous water tight conducting pipe line that can be used for drinking water or irrigation. Shelter Systems holds a patent on the Grip Clips and has pending patent applications on the frame and other tarp pole fasteners.



### [Shelter Systems' Emergency and Disaster Relief Shelter Frames](#)

## Emergency and Disaster Relief Tarp Tent Shelter Grip Clips™ Fasteners

Attach quickly and easily to tarps or any fabric without tools. They can be used to join two tarps or to shape a tarp into a shelter or to a desired function by gathering up a fold. It also provides a secure anchor for staking or attaching poles or guy lines.



[Emergency and Disaster Relief Tarp Tent Shelter Grip Clips™ Fasteners](#)

### **Caring Best For Those Most In Need.**

Questions? E-mail us at [shelter@best.com](mailto:shelter@best.com). Please feel free to call or write us anytime. Shelter Systems-OL, 224 West O'Connor St., Menlo Park, CA 94025. FAX 650-323-1220 Phone 650-323-6202.

**Shelter Systems** © 1996 - 2004 All Rights Reserved

[Shelter Systems' Home](#)



[Shelters](#)

[Greenhouses](#)

[What's New?](#)

[Gillis Designs](#)

[Stories](#)

[Q's & A's](#)

## Wind, Weather and Shelter at Burning Man

Shelter Systems has provided 100's of Yurts, Domes and Tents for people at Burning Man for over 7 years. Our tents, domes and yurts have proven they stand with the best against the rigors of the playa. Our strongest domes are our [18 and 30'ers](#). We do recommend you study all the information that we provide concerning anchoring and burning man in general. Please read through our online [Manual](#). Wind conditions at the playa can be extreme and we do not recommend our shelters for use in [extreme winds](#). However as stated above our domes have thus far held up well to the weather at the playa but they could fail if you have not [secured your dome properly](#) or if the winds reach excessive speeds or if the winds continue with out letting up or if a wind propelled object was to crash into your shelter. If you have any doubt about your yurt seek shelter in your car till the wind storm passes.

[Wind, Weather, and shelter at Burning Man](#)

[Wind Warnings](#)

[Dealing with Strong Winds](#)

[Dust at Burning Man,](#)

[Playa View at Burning Man](#)

[Shelter Systems' Yurt Domes at Burning Man](#)

[Shelter Systems Online](#)

[ShelterKits: Living Support Kits](#)

[Shelter Systems' Trip to Burning Man 2000](#)

[Shelter Systems' Trip to Burning Man 2001](#)

[Fun at BM](#)

See parts of the following for questions and answers on using our yurts, domes and tents at Burning Man:

Answers to Email Questions: <http://www.shelter-systems.com/email.html>

More Email Questions: <http://www.shelter-systems.com/email-additional.html>

Still more Email Questions <http://www.shelter-systems.com/email-stillmore.html>

Questions? E-mail us at [shelter@best.com](mailto:shelter@best.com). Please feel free to call or write us anytime. Shelter Systems-OL, 224 Walnut St., Menlo Park, CA 94025. FAX 650-323-1220 Phone 650-323-6202.

[Shelters](#)

[Greenhouses](#)

[What's New?](#)

[Gillis Designs](#)

[Stories](#)

[Q's & A's](#)

[Shelter Systems' Home](#)



Shelters

Greenhouses

What's New?

Gillis Designs

Stories

Q's & A's

## Shelter Systems' Watsu and Swimming Pool Covers

**Shelter Systems'** Portable Watsu and Swimming Pool Covers have been used to protect pools from winter weather and leaves and at the same time allow 90% of the sun light (more than glass) to reach the water to warm it up. Easy no tool set up in under 30 minutes. Shelter Systems' Watsu and Swimming Pool Covers offer the best value because they are strong, durable, watertight, wind-resistant, aesthetically pleasing, easily set up, and affordable. Note that our covers do not prevent children from gaining access to your pool and that you should plan on other equipment to protect against access and drowning hazards.



**30' Swimming Pool Cover**

Shelter Systems' Watsu and Swimming Pool Cover structures have the poles on the outside with the covering suspended under the frame via Shelter Systems' own Grip Clip tarp fasteners. The important benefits from this design are that the covering is under constant, even tension so that the tent will not flap in the wind, which would otherwise shred it. The poles cannot rub against the covering, thereby wearing holes in it. Water and leaf debris do not get caught in dips between the poles since the covering is tightly suspended under the poles. Also, since the poles and covering are not touching, there is no temperature buildup to degrade the fabric at contact points.

The [shingled](#) panels of our Watsu and Swimming Pool Covers overlap each other by 6", making the structure stronger and completely leak proof. The shingling also allows the structure to breathe. The buildup of moisture is driven out through the overlapped panels by vapor pressure and does not condense inside the tent.

Shelter Systems' patented [Grip Clips™](#) tarp fasteners join the dome's cover to the frame. Grip Clips also fasten the shingled panels together, providing greater strength than sewn seams or any type of grommet because they do not puncture the cover, which would allow rain to enter. In addition, the Grip Clip grips a large surface area of the material which prevents the wind from tearing the tent.

### **Durable Materials**

Shelter Systems' Portable Watsu and Swimming Pool Covers are made wholly of a super strong, tear-proof, [woven rip stop film](#)



which will not rot or mildew. The covering effectively excludes rain, dampness, wind, cold, and leaves and other debris. The completely waterproof covering and the shingling's breathability make a rain fly unnecessary. The covering is manufactured in three layers which are heat bonded together. It is UV-stabilized to withstand over 3 years of full sun exposure. The frosted color of the covering defuses the sun and provides over 90% of the light to your pool and will warm it substantially and help to hold the heat in by creating an enclosed space.

The frames are constructed of strong, long lasting, resilient, UV-stabilized, Class 200, 1 1/4"-diameter (3.5 cm.) PVC tubing.



**Swimming Pool Cover 20'**

### **Affordable**

Our waterproof design doesn't require a rain fly and the particular Yurt Dome shapes we use, utilizes material efficiently, so Shelter Systems' Watsu and Swimming pool covers use less material. The high performance covering is affordable. Because of the design and our tarp fasteners, our swimming pool covers are labor efficient to build. These factors make for reliable and affordable Portable Watsu and Swimming Pool Covers.

### **Controllable Space**

Shelter Systems' Portable Watsu and Swimming Pool Covers are light filled and well ventilated. The translucent covering creates a bright interior, transmitting 90% of the light (more than glass) making for a warm and bright interior. Shelter Systems' swimming Pool Cover has four flap doors evenly spaced around the dome for good cross ventilation when needed. The door coverings close automatically so you can go in or out quickly. There are no zippers to fumble with or break.

Shelter Systems' Watsu and Swimming Pool Covers are winter ready. They do not require a fly or liner for winter use. They are completely water tight and will not leak. Yet because of their [shingled construction](#) moist air is driven out through the shingling by vapor pressure. Shelter Systems' Watsu and Swimming Pool Covers being dome shaped have a minimal surface area for their volume and are thus easy to keep warm with a stove ([installation instructions](#) are included).

Since the panels of our domes are shingled, [overhead ventilation](#) is easily attained by inserting a lightweight object (e.g., an empty soda can) between several panels (two "vent tubes" are included with each dome). When the can is removed, the panels snap shut and are watertight. For maximum ventilation the walls themselves can be rolled up, transforming the dome into an [Opened-Arch Form](#).

The dome shape has other comfort features: The tent has more volume than a flat-sided one and therefore feels, and is, more spacious. The shape is more heat efficient because less fuel is needed to heat it plus the heat circulates more evenly. The cover of the dome is easily cleaned with a damp cloth.



### **Comparing Different Domes**

Our [drawings](#) effectively illustrate the different sizes we offer. Since the surface area of the covering does not increase as rapidly as the volume, the larger domes are less expensive for the usable space inside.

The different domes have different numbers of doors. The 14', 18', and 20' Swimming Pool Covers each have four flap doors evenly spaced around the dome for good cross ventilation. The 30' Swimming Pool Cover has eight doors.

Shelter Systems' Swimming Pool Covers perform excellently in strong wind due to their many, evenly spaced anchor points, the fact that the covering is drum tight and that they are shaped to shed the wind. The 14', 18', and 20' Swimming Pool Covers each have 12 anchor points. The 30'er has 20 anchor points.

### **Easy Access**

Watsu and Swimming Pool Covers are free standing and light weight. If you desire you can unhook the cover from the ground and pick it up and move the whole cover to the side so you can access the whole fish or Koi pond.

### **Complete and Adaptable**

Shelter Systems' Watsu and Swimming Pool Covers come complete with poles, 12" long quality Durapeg stakes, guy lines for extreme wind settings, ventilation tubes, spare parts (Grips Clips and pole connectors) and a [Shelter Systems' Instruction Manual](#) that site selection, anchoring, cooling, winterizing, and stove installation. Our covers are ideally suited for most climates; however, they can be further adapted for use in extreme climates. For the extreme cold, where fuel is in short supply, we offer a full liner. For extreme heat, we offer net doors and a sunshade which blocks one hundred per cent of the sunlight. Other [accessories](#) are available.

### **Easy Set Up**

The 18' Watsu and Swimming Pool Covers can be set up by one person [in 30 minutes](#) without tools. Insert the interchangeable poles into factory-attached connectors spaced evenly over the cover. The poles bend slightly when inserted, tightening the cover into a wind- and waterproof shelter. The cover is freestanding requiring no guy lines and can be moved into the desired position or location without taking it down. The Watsu and Pool Covers can be taken down in 5 minutes: just remove the poles and roll up the covering.

### **Storage**

All Shelter Systems' Watsu and Swimming Pool Covers are shipped by UPS and pack up into [compact packages](#) that one person can move around or store.

**Warning:** Our covers do not prevent children from gaining access to your pool and that you should plan on other equipment to protect against access and drowning hazards.

**Watsu and Swimming Pool Cover Dome 30** Diameter 30' x 11' High, 706 sq', Weight 190 lb. **\$1900** Shipping \$160

**Watsu and Swimming Pool Cover Dome 20** Diameter 20' x 10' High, 314 sq', Weight 70 lb. **\$860** Shipping \$55

**Watsu and Swimming Pool Cover Dome 18** Diameter 18' x 9' High, 254 sq', Weight 60 lb. **\$720** Shipping \$45

**Watsu and Swimming Pool Cover Dome 14** Diameter 14' x 7' High, 154 sq', Weight 40 lb. **\$620** Shipping \$40



### Special Order Lap Pool Covers

**Warning:** Our covers do not prevent children from gaining access to your pool and that you should plan on other equipment to protect against access and drowning hazards.

**CrystalCave™ Lap Pool Cover 9:** 9'x9'x7' High **\$550** Shipping \$45  
For each additional 4.5' of added length add: **\$350** Shipping add \$35

**CrystalCave™ Lap Pool Cover 11:** 11'x11'x7' High **\$680** Ship \$55  
For each additional 5.5' of added length add: **\$400** Shipping add \$45

### 30-DAY RISK-FREE TRIAL 1 1/2-YEAR GUARANTEE

Our guarantee is simple. **YOU MUST BE SATISFIED!** If for any reason you're not completely pleased with your purchase, return it in original, clean condition within 30 days of receipt for a full refund or exchange as you wish. All items in this catalog have a warranty against defects in materials and workmanship for **1 1/2 years**. Should any product prove defective we will repair or replace it at no cost to you. Special Orders are not returnable. Read [Snow and Wind Warnings](#).

[To order.](#) By Fax or Mail.

[Order online with our Secure Order Form!](#)

**For fast credit card orders call 650-323-6202**

Questions? E-mail us at [shelter@best.com](mailto:shelter@best.com). Please feel free to call or write us anytime. Shelter Systems-OL, 224 West O'Connor St., Menlo Park, CA 94025. FAX 650-323-1220 Phone 650-323-6202.

[Shelters](#)

[Greenhouses](#)

[What's New?](#)

[Gillis Designs](#)

[Stories](#)

[Q's & A's](#)

[Price List](#)

[Shelter Systems' Map of Site](#)

Shelter Systems © 1996 - 2001 All Rights Reserved

[Shelter Systems' Home](#)



Shelters

Greenhouses

What's New?

Gillis Designs

Stories

Q's &amp; A's

## Portable Outdoor Classrooms

**Shelter Systems'** Portable Outdoor Classroom Yurt Dome Tents have been helping teachers around the world by providing dry bright classrooms that could be put up in minutes. Shelter Systems' Portable Outdoor Classrooms offer the best value because they are strong, durable, watertight, wind-resistant, pleasant to be in, easily set up, and affordable.



### The 18' Portable Classroom

Shelter Systems' Portable Classrooms are dome-shaped [Geotensic™](#) shelter structures. A dome is stronger than any other shape of the same volume. Because of its curved shape with no corners, there are no weak points. Our patented structure is drum tight, waterproof and wind-resistant.

Known for their lightweight construction as well as for the large amount of light they let in, they are made with a strong, tear-resistant fabric and non-puncturing tarp fasteners. They are truly portable and guaranteed to be leakproof.



### 30' Portable Outdoor Classroom

Shelter Systems' portable classroom structures have the poles on the outside with the covering suspended under the frame via Shelter Systems' own Grip Clip tarp fasteners. The frame and the covering are not in direct contact. The important benefits from this design are that the covering is under constant, even tension so that the tent will not flap in the wind, which would otherwise shred it. The poles cannot rub against the covering, thereby wearing holes in it. Also, since the poles and covering are not touching, there is no temperature buildup to degrade the fabric at contact points.

The [shingled](#) panels of our Portable Classroom tents overlap each other by 6", making the structure stronger and completely

leakproof. The shingling also allows the structure to breathe. The buildup of moisture is driven out through the overlapped panels by vapor pressure and does not condense inside the tent.

Shelter Systems' patented [Grip Clips](#) tarp fasteners join the dome's cover to the frame. Grip Clips also fasten the shingled panels together, providing greater strength than sewn seams or any type of grommet because they do not puncture the cover, which would allow rain to enter. In addition, the Grip Clip grips a large surface area of the material which prevents the wind from tearing the tent.



**18' Portable Outdoor Classroom**

### **Durable Materials**

Shelter Systems' Portable Classroom Yurt Dome Tents are made wholly of a super strong, tear-proof, [woven rip stop film](#) which will not rot or mildew. The covering effectively excludes rain, dampness, wind, cold, and sun. The completely waterproof covering and the shingling's breathability make a rain fly unnecessary. The covering is manufactured in three layers which are heat bonded together. It is UV-stabilized to withstand up to 3 years of full sun exposure. The white color of the covering reflects the heat of the sun and provides 40% shade.



The frames are constructed of strong, long lasting, resilient, UV-stabilized, Class 200, 1 1/4"-diameter (3.5 cm.) PVC tubing.

### Affordable

Our waterproof design doesn't require a rain fly and the particular dome shapes we use utilizes material efficiently, so Shelter Systems' tents use less material. The high performance covering is affordable. Because of the design and our tarp fasteners, our



tents are labor efficient to build. These factors make for reliable and affordable Portable Classrooms.

### Comfortable Living Space

Shelter Systems' Portable Classroom Tents are light filled and well ventilated. The white covering creates a pleasingly bright interior. Shelter Systems' 18' Portable Classroom Tent has four flap doors evenly spaced around the dome for good cross ventilation and light. The door coverings close automatically so you can go in or out quickly. There are no zippers to fumble with or break. Over each door is a translucent skylight window which allows 90% of the sunlight

(more than glass) to pass through it while preserving the privacy of the people within.

Shelter Systems' Portable Classroom Shelters are winter ready tents. They do not require a fly or liner for winter use. They are completely water tight and will not leak. Yet because of their [shingled construction](#) moist air is driven out through the shingling by vapor pressure. Shelter Systems' Portable Classroom Shelters being dome shaped have a minimal surface area for their volume and are thus easy to keep warm with a stove ([installation instructions](#) are included with each tent).

Since the panels of our domes are shingled, [overhead ventilation](#) is easily attained by inserting a lightweight object (eg, an empty soda can) between several panels (two "vent tubes" are included with each dome). When the can is removed, the panels snap shut and are watertight. For maximum ventilation the walls themselves can be rolled up, transforming the dome into an [Opened-Arch Form](#).

The dome shape has other comfort features: The interior can be divided into "rooms." The tent has more volume than a flat-sided one and therefore feels, and is, more spacious. The shape is more heat efficient because less fuel is needed to heat it plus the heat circulates more evenly. The cover of the dome is easily cleaned with a damp cloth.



### Comparing Different Domes

## Portable Classrooms

The 18' is our most popular dome. It's 254 square feet and is the size of a small room. We also have 14', 20', and 30' Portable Outdoor Classrooms. As the tents get larger, there is a greater increase in volume in relation to the increase in diameter. So the 18' Portable Outdoor Classroom feels twice as big as the 14'er! This is because the size in diameter extends out in all directions, creating a large increase in volume. Our [drawings](#) effectively illustrate this. Since the surface area of the covering does not increase as rapidly as the volume, the larger domes are less expensive for the usable space inside.

The different domes have different numbers of doors. The 14', 18', and 20' Portable Outdoor Classrooms each have four flap doors evenly spaced around the dome for good cross ventilation. The 30' Portable Outdoor Classroom has eight doors.

Shelter Systems' Portable Classroom Yurt Dome Tents perform excellently in strong wind due in part to their many, evenly spaced anchor points. The 14', 18', and 20' Portable Outdoor Classrooms each have 12 anchor points. The 30'er has 20 anchor points.

### Complete and Adaptable

Shelter Systems' Portable Outdoor Classroom Yurt Dome Tents come complete with poles, 12" long quality Durapeg stakes, guy lines for extreme wind settings, ventilation tubes, spare parts (Grips Clips and pole connectors) and a [Shelter Systems' Instruction Manual](#) that details floors, site selection, anchoring, cooling, winterizing, and stove installation. Our tents are ideally suited for most climates; however, they can be further adapted for use in extreme climates. For the extreme cold, where fuel is in short supply, we offer a full liner. For extreme heat, we offer net doors and a sunshade which blocks one hundred per cent of the sunlight. Other [accessories](#) available are rain porches, floors, etc.

### Easy Set Up

The 18' Portable Classroom Yurt Dome Tent can be set up by one person [in 30 minutes](#) without tools. Insert the interchangeable poles into factory-attached connectors spaced evenly over the cover. The poles bend slightly when inserted, tightening the cover into a wind- and waterproof shelter. The tent is freestanding requiring no guy lines and can be moved into the desired position or location without taking it down. The Shelter Portable Classroom can be taken down in 5 minutes: just remove the poles and roll up the covering.

### Storage

All Shelter Systems' Portable Outdoor Classrooms are shipped by UPS and pack up into [compact packages](#) that one person can move around or store.





**[Portable Classroom Yurt, Dome 30](#)** Diameter 30'x11' High, 706 sq', Weight 190lb. **\$1900** Shipping \$160

**[Portable Classroom Yurt, Dome 20](#)** Diameter 20'x10' High, 314 sq', Weight 70 lb. **\$860** Shipping \$55

**[Portable Classroom Yurt, Dome 18](#)** Diameter 18'x9' High, 254 sq', Weight 60 lb. **\$720** Shipping \$45

**[Portable Classroom Yurt, Dome 14](#)** Diameter 14'x7' High, 154 sq', Weight 40 lb. **\$620** Shipping \$40

You get a lot more volume for your money as you go up in diameter. When you step inside the 18' yurt after being in the 14' yurt, the 18' er feels twice as big. The 20' yurt feels twice the size of the 18' yurt. This is because the extra feet in diameter extends out in all directions (including up) creating a large increase in volume. Since the surface area of the covering does not increase as rapidly as the volume, the larger domes are less expensive for the space you get.

### **30-DAY RISK-FREE TRIAL 1 1/2-YEAR GUARANTEE**

Our guarantee is simple. **YOU MUST BE SATISFIED!** If for any reason you're not completely pleased with your purchase, return it in original, clean condition within 30 days of receipt for a full refund or exchange as you wish. All items in this catalog have a warranty against defects in materials and workmanship for **1 1/2 years**. Should any product prove defective we will repair or replace it at no cost to you. Special Orders are not returnable. Read [Snow and Wind Warnings](#).

[To order.](#) by Fax or Mail.

**[Order online with our Secure Order Form!](#)**

**For fast credit card orders call 650-323-6202**

Questions? E-mail us at [shelter@best.com](mailto:shelter@best.com). Please feel free to call or write us anytime. Shelter Systems-OL, 224 Walnut St., Menlo Park, CA 94025. FAX 650-323-1220 Phone 650-323-6202.

[Shelters](#)

[Greenhouses](#)

[What's New?](#)

[Gillis Designs](#)

[Stories](#)

[Q's & A's](#)

[Price List](#)

[Shelter Systems' Map of Site](#)

Shelter Systems © 1996 - 2003 All Rights Reserved

[Shelter Systems' Home](#)





Shelters

Greenhouses

What's New?

Gillis Designs

Stories

Q's & A's

## Outfitter and Guide Tents, Yurts, and Domes

Shelter Systems' Tents, Yurts, and Domes are ideally suited for outfitters and guides. They are lighter, stronger and roomier than the wall tents that outfitters and guides traditionally choose when heading into the back country. Our Outfitter and Guide Tents, Yurts and Domes are spacious enough for group dining, sleeping quarters and make weathering a storm a pleasure.



Images of Shelter Systems' **Outfitter and Guide Tents, Yurts and Domes** in use as outfitter and guide tents around the world.



"Just wanted to let you know that we purchased two of your domes to use as dining tents on our treks in Bhutan. They were a HUGE hit with our clients and our local trek staff as well. The trekkers came to call the 20' dome the "Taj Mahal" and enjoyed luxuriating in the roomy interior. We did have one gusty day that lifted the dome off the ground (our staff hadn't tied the guy lines tightly enough) but other than that, they held up extremely well. If you are interested in any photos, we hope to have some up on our site in the next few weeks. Look at our site and go to the Bhutan section (go to Asia first, then to Bhutan). All the

best! Brent Olson Geographic Expeditions"

### Sturdy Design

**Shelter Systems' Outfitter and Guide Tents, Yurts and Domes** are made wholly of a superstrong [woven ripstop film](#) which is watertight and will not rot or mildew. By using a combination of materials we provide shelters that will make your clients feel at home.

The frames are constructed of strong, long-lasting Class 200 PVC tubing. Shelter Systems' own patented Grip Clips join the dome's cover to the frame. Grip Clips provide greater strength than sewn seams or any type of grommet because they do not puncture the cover. Each panel of **Shelter Systems' Outfitter and Guide Tents, Yurts and Domes** are [shingled](#) over the next so that the domes breathe yet are completely leakproof!

### Light and Fresh Air

**Shelter Systems' Outfitter and Guide Tents, Yurts and Domes:** 14' (4.2m), 18' (5.4m), and 20' (6m) each have four flap doors evenly spaced around the dome. The door coverings close automatically so you can go in or out quickly. There are no zippers to fumble with or break. For maximum ventilation the walls themselves can be rolled up. There is always plenty of light and fresh air in the **Shelter Systems' Outfitter and Guide Tents, Yurts and Domes**.



### Easy Set Up

You will be pleased with how easily our **Outfitter and Guide Tents, Yurts and Domes** go up in 30 minutes without tools. You simply insert interchangeable poles into factory-attached connectors spaced evenly over the cover. The poles bend slightly when inserted, which tightens the cover into a wind- and waterproof dynamic shelter. Turn or move the dome into desired position. It's easy to take the dome down also; just remove the poles and roll up the dome.

### A Shelter System

**Shelter Systems' Outfitter and Guide Tents, Yurts and Domes** come complete with stakes, guy lines, vent tubes, spare parts and an instruction booklet that details floors, site selection, anchoring, cooling, winterizing, and stove installation.

[Setting up a Shelter Systems' Dome.](#)

[Shelter Systems' Instruction Manual.](#) Set- up, storage, repairs, wood stoves, etc ...

[Accessories.](#) Floors, net doors, porches and liners to make your shelter more comfortable.

[Sizes.](#) A drawing comparing the sizes of some of our domes.

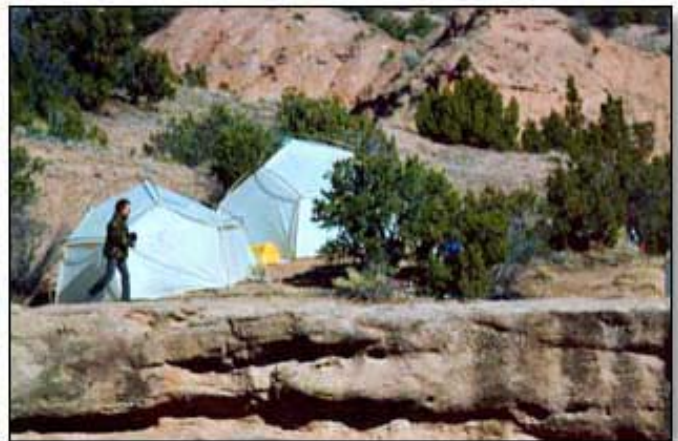

You get a lot more volume as a shelter's diameter increases. When you step inside the 18' after being in the 14' m, the 18' feels twice as big. The 20' feels twice the size of the 18'. This is because the size in diameter extends out in all directions (including up), creating a large increase in volume. Since the surface area of the covering does not increase as rapidly as the volume, the larger domes are less expensive.

**[Outfitter and Guide Yurt Dome™ Tent 30](#)** Diameter 30'x11' High Weight 190lb. **\$1900** Shipping \$160

**[Outfitter and Guide Yurt Dome™ Tent 20](#)** Diameter 20'x10' High Weight 70 lb. **\$860** Shipping \$55

**[Outfitter and Guide Yurt Dome™ Tent 18](#)** Diameter 18'x9' High Weight 60 lb. **\$720** Shipping \$45

**[Outfitter and Guide Yurt Dome™ Tent 14](#)** Diameter 14'x7' High Weight 40 lb. **\$620** Shipping \$40

**[Outfitter and Guide Yurt Dome™ Tent 11](#)** Diameter 11'x6'4" High Weight 20 lb. **\$580** Shipping \$35

**[Outfitter and Guide Yurt Dome™ Tent 8](#)** Diameter 8'x7'4" High Weight 20 lb. **\$460** Shipping \$30

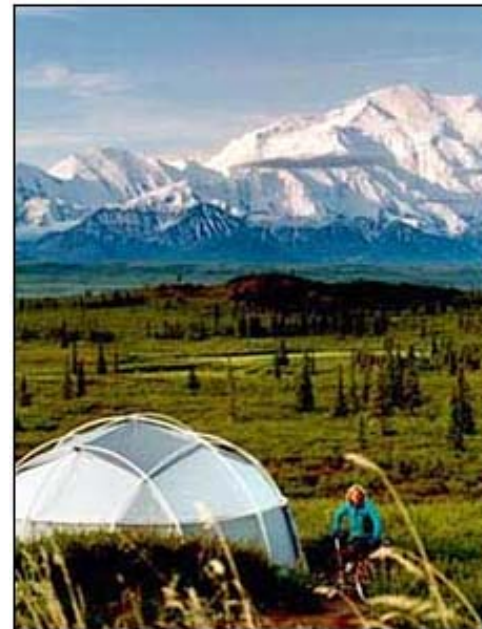

### **30-DAY RISK-FREE TRIAL 1 1/2-YEAR GUARANTEE**

Our guarantee is simple. **YOU MUST BE SATISFIED!** If for any reason you're not completely pleased with your purchase, return it in original, clean condition within 30 days of receipt for a full refund or exchange as you wish. All items in this catalog have a warranty against defects in materials and workmanship for **1 1/2 years**. Should any product prove defective we will repair or replace it at no cost to you. Special Orders are not returnable. Read [Snow and Wind Warnings](#).

[To order](#). by Fax or Mail.

[Order online with our Secure Order Form!](#)

**For fast credit card orders call 650-323-6202**

Questions? E-mail us at [shelter@best.com](mailto:shelter@best.com). Please feel free to call or write us anytime. Shelter Systems-OL, 224 Walnut St., Menlo Park, CA 94025. FAX 650-323-1220 Phone 650-323-6202.

[Shelters](#)

[Greenhouses](#)

[What's New?](#)

[Gillis Designs](#)

[Stories](#)

[Q's & A's](#)

[Price List](#)

[Shelter Systems' Map of Site](#)

Shelter Systems © 1996 - 2001 All Rights Reserved

[Shelter Systems' Home](#)



Shelters

Greenhouses

What's New?

Gillis Designs

Stories

Q's & A's

## Party Tents, Yurts and Domes

Shelter Systems' Tents, Yurts, and Domes have been used for parties, weddings and other celebrations since we began making them over 20 years ago. Their spaciousness, ease of set-up and portability are all factors making them excellent for party tents. The unusual shapes of **Shelter Systems' Party Tents, Yurts and Domes** are exceptionally pleasing to look at and functional.



**The 30' Party Yurt Dome**

### Sturdy Design

**Shelter Systems' Party Tents, Yurts and Domes** are made wholly of a superstrong [woven ripstop film](#) which is watertight and will not rot or mildew.



The frames are constructed of strong, long-lasting Class 200 PVC tubing. Shelter Systems' own patented Grip Clips join the dome's cover to the frame. Grip Clips provide greater strength than sewn seams or any type of grommet because they do not puncture the cover. Each panel of Shelter Systems' **Party Tents, Yurts, and Domes** is [shingled](#) over the next so that the domes breathe yet are completely leakproof!



**Inside Shelter Systems' 30' Party Yurt Dome**

**Light and Fresh Air**

**Shelter Systems' Party Tents, Yurts, and Domes:** 14', 18', and 20' each have four flap doors evenly spaced around the dome. The door coverings close automatically so you can go in or out quickly. There are no zippers to fumble with or break. For maximum ventilation the walls themselves [can be rolled up](#). There is always plenty of light and fresh air in **Shelter Systems'**

**Party Tents, Yurts, and Domes.**



**Easy Set-Up**

You will be pleased with how easily **Shelter Systems' Party Tents, Yurts, and Domes** go up in 30 minutes without tools. You simply insert interchangeable poles into factory-attached connectors spaced evenly over the cover. The poles bend slightly when inserted, which tightens the cover into a wind- and waterproof dynamic shelter. Turn or move the dome into desired position. When the party's over, the dome can be easily taken down; just remove the poles, roll up the dome, and store it.

**Shelter Systems' Party Tents, Yurts, and Domes** come complete with stakes, guy lines, vent tubes, spare parts and an instruction booklet that details floors, site selection, anchoring, cooling, winterizing, and stove installation.



**[ArchTent™ 20' x 26'](#)**

[Setting up a Shelter Systems' Dome.](#)

[Shelter Systems' Instruction Manual.](#) Set-up, storage, repairs, wood stoves, etc.



[Accessories.](#) Floors, net doors, porches, liners and much more to make your shelter more comfortable.

[Sizes.](#) A drawing comparing the sizes of some of our domes.

### The 18' Party Tents, Yurts, and Domes

[Party Yurt Dome™ Tent30](#) Diameter 30'x11' High Weight 190lb.

\$1900 Shipping \$160

[Party Yurt Dome™ Tent 20](#) Diameter 20'x10' High Weight 70 lb. **\$860** Shipping \$55

[Party Yurt Dome™ Tent 18](#) Diameter 18'x9' High Weight 60 lb. **\$720** Shipping \$45

[Party Yurt Dome™ Tent 14](#) Diameter 14'x7' High Weight 40 lb. **\$620** Shipping \$40

[Party Yurt Dome™ Tent 11](#) Diameter 11'x6'4" High Weight 20 lb. **\$580** Shipping \$35

[Party Yurt Dome™ Tent 8](#) Diameter 8'x7'4" High Weight 20 lb. **\$460** Shipping \$35

### 30-DAY RISK-FREE TRIAL 1 1/2-YEAR GUARANTEE

Our guarantee is simple. **YOU MUST BE SATISFIED!** If for any reason you're not completely pleased with your purchase, return it in original, clean condition within 30 days of receipt for a full refund or exchange as you wish. All items in this catalog have a warranty against defects in materials and workmanship for **1 1/2 years**. Should any product prove defective we will repair or replace it at no cost to you. Special Orders are not returnable. Read [Snow and Wind Warnings](#).

[To order.](#) by Fax or Mail.

[Order online with our Secure Order Form!](#)

**For fast credit card orders call 650-323-6202**

Questions? E-mail us at [shelter@best.com](mailto:shelter@best.com). Please feel free to call or write us anytime. Shelter Systems-OL, 224 Walnut St., Menlo Park, CA 94025. FAX 650-323-1220 Phone 650-323-6202.

Shelters

Greenhouses

What's New?

Gillis Designs

Stories

Q's & A's

[Price List](#)

[Shelter Systems' Map of Site](#)

Shelter Systems © 1996 - 2001 All Rights Reserved

[Shelter Systems' Home](#)



Shelters

Greenhouses

What's New?

Gillis Designs

Stories

Q's & A's

## Expedition Tents, and Yurt Domes™

Shelter Systems has been making Expedition Tents, and Geodesic Yurt Domes™ for groups exploring the world for over 20 years. We manufacture a wide range of sizes and styles to fit the needs of the adventurous. Our Expedition Tents, and Yurt Domes™ are spacious enough for your whole group to meet in. Backpacking tents are fine for sleeping but for gatherings such as group dining, logistics planning, and progress reviews, a larger Shelter System's dome is perfect.



Images of Shelter Systems' **Expedition Tents, Yurts, and Domes** in use as group tents around the world.



**Sturdy Design**

**Shelter Systems' Expedition Tents, Yurts, and Domes** are made wholly of a superstrong, [woven ripstop film](#) which is watertight and will not rot or mildew. By using a combination of materials we provide shelters that will make your expedition feel at home.





### ArchTen™t

The frames are constructed of strong, long-lasting Class 200 PVC tubing. Shelter Systems' own patented Grip Clips join the dome's cover to the frame. Grip Clips provide greater strength than sewn seams or any type of grommet because they do not puncture the cover. Each panel of **Shelter Systems' Expedition Tents, Yurts, and Domes** are [shingled](#) over the next so that the domes breathe yet are completely leakproof!



**18' Shelter Systems' Expedition Tents, Yurts, and Domes. Ten or more persons can be sheltered in each.**

### **Light and Fresh Air**

**Shelter Systems' 'Expedition Tents, Yurts, and Domes:** 14' (4.2m), 18' (5.4m), and 20' (6m) each have four flap doors evenly spaced around the dome. The door coverings close automatically so you can go in or out quickly. There are no zippers to fumble with or break. For maximum ventilation the walls themselves can be rolled up. There is always plenty of light and fresh air in the **Shelter Systems' Expedition Tents, Yurts, and Domes.**



### **Easy Set Up**

You will be pleased with how easily our **Shelter Systems' Expedition Tents, Yurts, and Domes** go up in 30 minutes without tools. You simply insert interchangeable poles into factory-attached connectors spaced evenly over the cover. The poles bend slightly when inserted, which tightens the cover into a wind- and waterproof dynamic shelter. Turn or move the dome into desired position. After the emergency needs pass, the dome can be easily taken down: just remove the poles, roll up the dome, and store it.

### **A Shelter System**

**Shelter Systems' Expedition Tents, Yurts, and Domes** come complete with stakes, guy lines, vent tubes, spare parts and an

instruction booklet that details floors, site selection, anchoring, cooling, winterizing, and stove installation.

[Setting up a Shelter Systems' Dome.](#)

[Shelter Systems' Instruction Manual.](#) Set- up, storage, repairs, wood stoves, etc ...

[Accessories.](#) Floors, net doors, porches and liners to make your shelter more comfortable.

[Sizes.](#) A drawing comparing the sizes of some of our domes.



You get a lot more volume as a shelter's diameter increases. When you step inside the 18' after being in the 14' m, the 18' feels twice as big. The 20' feels twice the size of the 18'. This is because the size in diameter extends out in all directions (including up), creating a large increase in volume. Since the surface area of the covering does not increase as rapidly as the volume, the larger domes are less expensive.

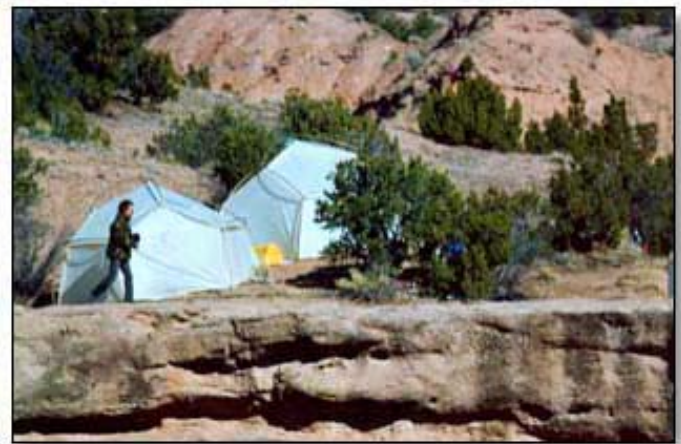

[Expedition Yurt Dome Tent 30](#) Diameter 30'x11' High Weight 190lb. \$1900 Shipping \$160

[Expedition Yurt Dome Tent 20](#) Diameter 20'x10' High Weight 70 lb. \$860 Shipping \$55

[Expedition Yurt Dome Tent 18](#) Diameter 18'x9' High Weight 60 lb. \$720 Shipping \$40

[Expedition Yurt Dome Tent 14](#) Diameter 14'x7' High Weight 40 lb. \$620 Shipping \$35

### 30-DAY RISK-FREE TRIAL 1 1/2-YEAR GUARANTEE

Our guarantee is simple. **YOU MUST BE SATISFIED!** If for any reason you're not completely pleased with your purchase, return it in original, clean condition within 30 days of receipt for a full refund or exchange as you wish. All items in this catalog have a warranty against defects in materials and workmanship for **1 1/2 years**.

Should any product prove defective we will repair or replace it at no cost to you.

Special Orders are not returnable. Read [Snow and Wind Warnings](#).

[To order.](#) by Fax or Mail.

[Order online with our Secure Order Form!](#)

**For fast credit card orders call 650-323-6202**

Questions? E-mail us at [shelter@best.com](mailto:shelter@best.com). Please feel free to call or write us anytime. Shelter Systems-OL, 224 Walnut St., Menlo Park, CA 94025. FAX 650-323-1220 Phone 650-323-6202.

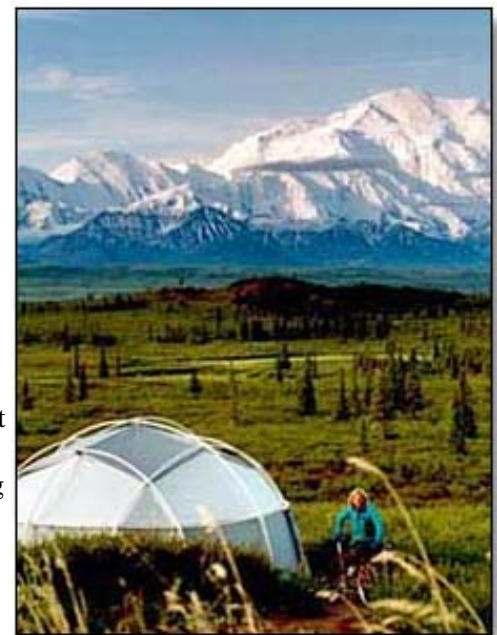

Shelters

Greenhouses

What's New?

Gillis Designs

Stories

Q's & A's

[Price List](#)

[Shelter Systems' Map of Site](#)

**Shelter Systems** © 1996 - 2003 All Rights Reserved

[Shelter Systems' Home](#)



Shelters

Greenhouses

What's New?

Gillis Designs

Stories

Q's & A's

## Shelter Systems' Yurt Dome Wedding Tents

**Shelter Systems'** Wedding Tents are a beautiful alternative to the traditional box style wedding tents. Shelter Systems' Wedding tents will protect you and your guests from unexpected bad weather. Easy no tool set up in under 30 minutes. Shelter Systems' Wedding Tents offer the best value because they are strong, durable, watertight, wind-resistant, aesthetically pleasing, easily set up, and affordable.



**30' Portable Fish and Koi Pond Covers**

Shelter Systems' Wedding Tents have their poles on the outside with the covering suspended under the frame via Shelter Systems' own Grip Clip tarp fasteners. The important benefits from this design are that the covering is under constant, even tension so that the tent will not flap in the wind, which would otherwise shred it. The poles cannot rub against the covering, thereby wearing holes in it. Water and leaf debris do not get caught in dips between the poles since the covering is tightly suspended under the poles. Also, since the poles and covering are not touching, there is no temperature buildup to degrade the fabric at contact points.

The [shingled](#) panels of our Wedding Tents overlap each other by 6", making the structure stronger and completely leak proof. The shingling also allows the structure to breathe. The buildup of moisture is driven out through the overlapped panels by vapor pressure and does not condense inside the tent.

Shelter Systems' patented [Grip Clips™](#) tarp fasteners join the dome's cover to the frame. Grip Clips also fasten the shingled panels together, providing greater strength than sewn seams or any type of grommet because they do not puncture the cover, which would allow rain to enter. In addition, the Grip Clip grips a large surface area of the material which prevents the wind from tearing the tent.

### **Durable Materials**

Shelter Systems' Wedding Tents are made wholly of a super strong, tear-proof, [woven rip stop film](#) which will not rot or mildew. The covering effectively excludes rain, dampness, wind, cold, and leaves and other debris. The completely waterproof covering and the shingling's breathability make a rain fly unnecessary. The covering is manufactured in three layers which are heat bonded together. It is UV-stabilized to withstand over 3 years of full sun exposure. The White color of the covering defuses

the sun and provides over 60% of the light to the interior.

The frames are constructed of strong, long lasting, resilient, UV-stabilized, Class 200, 1 1/4"-diameter (3.5 cm.) PVC tubing.

### **Affordable**

Our waterproof design doesn't require a rain fly and the particular Yurt Dome shapes we use, utilizes material efficiently, so Shelter Systems' pond covers use less material. The high performance covering is affordable. Because of the design and our tarp fasteners, our tents are labor efficient to build. These factors make for reliable and affordable Portable Pond Covers.

### **Controllable Space**

Shelter Systems' Wedding Tents are light filled and well ventilated. The translucent covering creates a bright interior, transmitting 60% of the light plants and fish of all kinds love and flourish in. Shelter Systems' Wedding Tents has four to eight flap doors evenly spaced around the dome for good cross ventilation and light. The door coverings close automatically so you can go in or out quickly. There are no zippers to fumble with or break.

Shelter Systems' Wedding Tents are winter ready. They do not require a fly or liner for winter use. They are completely water tight and will not leak. Yet because our their [shingled construction](#) moist air is driven out through the shingling by vapor pressure. Shelter Systems' Wedding Tents being dome shaped have a minimal surface area for their volume and are thus easy to keep warm with a stove ([installation instructions](#) are included with each tent).

Since the panels of our domes are shingled, [overhead ventilation](#) is easily attained by inserting a lightweight object (e.g., an empty soda can) between several panels (two "vent tubes" are included with each dome). When the vent tube is removed, the panels snap shut and are watertight. For maximum ventilation the walls themselves can be rolled up, transforming the dome into an [Opened-Arch Form](#).

The dome shape has other comfort features: The interior can be divided into "rooms." The tent has more volume than a flat-sided one and therefore feels, and is, more spacious. The shape is more heat efficient because less fuel is needed to heat it plus the heat circulates more evenly. The cover of the dome is easily cleaned with a damp cloth.



### **Comparing Different Domes**

Our [drawings](#) effectively illustrate the different sizes we offer. Since the surface area of the covering does not increase as rapidly as the volume, the larger domes are less expensive for the usable space inside.

The different domes have different numbers of doors. The 14', 18', and 20' Wedding Tents each have four flap doors evenly spaced around the dome for good cross ventilation. The 30' Wedding Tent has eight doors.

Shelter Systems' Wedding Tents perform excellently in strong wind due to their many, evenly space anchor points, the fact that the covering is drum tight and that they are shaped to shed the wind. The 14', 18', and 20' Wedding Tents each 12 anchor points. The 30'er has 20 anchor points.

### **Easy Access**

Shelter Systems' Wedding Tents are free standing and light weight. If you desire you can unhook the cover from the ground and with a few people pick it up and move the whole Wedding Tent.

### **Complete and Adaptable**

Shelter Systems' Wedding Tents come complete with poles, 12" long quality Durapeg stakes, guy lines for extreme wind settings, ventilation tubes, spare parts (Grips Clips and pole connectors) and a [Shelter Systems' Instruction Manual](#) that site selection, anchoring, cooling, winterizing, and stove installation. Our covers are ideally suited for most climates; however, they can be further adapted for use in extreme climates. For the extreme cold, where fuel is in short supply, we offer a full liner. For extreme heat, we offer net doors and a sunshade which blocks one hundred per cent of the sunlight. Other [accessories](#) are available.

### **Easy Set Up**

The 18' Wedding Tents can be set up by one person [in 30 minutes](#) without tools. Insert the interchangeable poles into factory-attached connectors spaced evenly over the cover. The poles bend slightly when inserted, tightening the cover into a wind- and waterproof shelter. The cover is freestanding requiring no guy lines and can be moved into the desired position or location without taking it down. The Pond Covers can be taken down in 5 minutes: just remove the poles and roll up the covering.

### Storage

All Shelter Systems' Wedding Tents are shipped by UPS and pack up into [compact packages](#) that one person can move around or store.

**Wedding Tent Dome 30** Diameter 30' x 11' High, 706 sq', Weight 190 lb. **\$1900** Shipping \$160

**Wedding Tent Dome 20** Diameter 20' x 10' High, 314 sq', Weight 70 lb. **\$860** Shipping \$55

**Wedding Tent Dome 18** Diameter 18' x 9' High, 254 sq', Weight 60 lb. **\$720** Shipping \$45

**Wedding Tent Dome 14** Diameter 14' x 7' High, 154 sq', Weight 40 lb. **\$620** Shipping \$40

### 30-DAY RISK-FREE TRIAL 1 1/2-YEAR GUARANTEE

Our guarantee is simple. **YOU MUST BE SATISFIED!** If for any reason you're not completely pleased with your purchase, return it in original, clean condition within 30 days of receipt for a full refund or exchange as you wish. All items in this catalog have a warranty against defects in materials and workmanship for **1 1/2 years**. Should any product prove defective we will repair or replace it at no cost to you. Special Orders are not returnable. Read [Snow and Wind Warnings](#).

[To order.](#) By Fax or Mail.

[Order online with our Secure Order Form!](#)

**For fast credit card orders call 650-323-6202**

Questions? E-mail us at [shelter@best.com](mailto:shelter@best.com). Please feel free to call or write us anytime. Shelter Systems-OL, 224 West O'Connor St., Menlo Park, CA 94025. FAX 650-323-1220 Phone 650-323-6202.

[Shelters](#)

[Greenhouses](#)

[What's New?](#)

[Gillis Designs](#)

[Stories](#)

[Q's & A's](#)

[Price List](#)

[Shelter Systems' Map of Site](#)

Shelter Systems © 1996 - 2001 All Rights Reserved

[Shelter Systems' Home](#)

[Shelters](#)[Greenhouses](#)[What's New?](#)[Gillis Designs](#)[Stories](#)[Q's & A's](#)

## Archeological Excavation Shelters™, Tents, Yurt Domes™

Shelter Systems provides portable, affordable and environmentally friendly shelters for archeological excavations and digs. **Shelter Systems'** waterproof Tents, Domes and Yurts have been sheltering people around the world for over 20 years. We manufacture a wide range of Tensegrity and Geodesic structures, from Portable Yurts to Solar Greenhouses.



### Sturdy Design

Shelter Systems' Archeology Excavation Shelters, Tents, Domes and Yurts are made wholly of a superstrong, [woven ripstop film](#) which is watertight and will not rot or mildew. By using a combination of materials we provide a shelter constructed partly of a sunblock covering to provide shade and partly of a translucent white covering to provide a bright interior.

The frames are constructed of strong, long-lasting Class 200 PVC tubing. Shelter Systems' own patented Grip Clips join the dome's cover to the frame. Grip Clips provide greater strength than sewn seams or any type of grommet, because they do not puncture the cover. Each panel of our Archeology Excavation Shelters, Tents, Domes and Yurts are [shingled](#) over the next so that the domes breathe, yet are completely leakproof!



**A Group of our 18' (5.6 m) Domes**

### **Light and Fresh Air**

Each of our 14' (4.2m), 18' (5.4m), and 20' (6m) shelters have four flap doors evenly spaced around the dome. The 8' (2.4m) and 11' (3.3m) have one door. The door coverings close automatically so you can go in or out quickly. There are no zippers to fumble with or break. For maximum ventilation the walls themselves can be rolled up. There is always plenty of light and fresh air in the Shelter Systems' Archeology Excavation Shelters, Tents, Domes and Yurts.



*"Here is a photograph of our [Crystal Cave™](#) being used in the excavation of the Dowell Site in January 1989. This structure made doing Archeology in the winter not only feasible but even pleasant. It is easy to assemble and easy to move." - Robert Lafferty, Mid-Continental Research Assoc., AR*

### **Easy Set-Up [Setting up a Shelter Systems' Shelter.](#)**

You will be pleased with how easily your Shelter Systems' Archeology Excavation Shelters, Tents, and Domes go up in 30 minutes without tools. You simply insert interchangeable poles into factory-attached connectors spaced evenly over the cover. The poles bend slightly when inserted, which tightens the cover into a wind- and waterproof dynamic shelter. Turn or move the dome into desired position. After the emergency needs pass, the dome can be easily taken down; just remove the poles, roll up the dome, and store it. Storage will extend the life of the shelter.



### A Shelter System

Shelter Systems' Archeology Excavation Shelters, Tents, Domes and Tarps come complete with stakes, guy lines, vent tubes, spare parts and an instruction booklet that details floors, site selection, anchoring, cooling, winterizing, and stove installation.

[Setting up a Shelter Systems' Dome.](#)

[Shelter Systems' Instruction Manual.](#) Set up, storage, repairs, wood stoves etc ...

[Accessories.](#) Floors, net doors, porches and liners to make your shelter more comfortable.

[Sizes:](#) A drawing comparing the sizes of some of our domes.

### The 11' Archeology Excavation Shelter™

Note that the Archeology Excavation Shelter 11' and 8' are constructed using a different geometry that has less panels and only one door (see the AES 11' ) photo above and the shape GroDome 8 on the [GroDome](#) page. The 14, 18, or 20 'ers each have four doors.

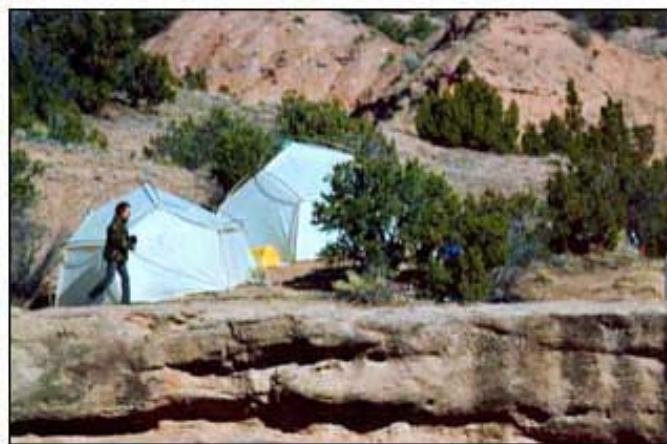

*"We have enjoyed the shelter of your 30' yurt over our excavation site for 5 months now, and are very pleased with it. It casts a perfect, flat light for excavation and photography, and saves us the headaches of covering and recovering the excavation on a daily basis. The excavation site is in southeastern Utah, an early Puebloan pit house dating to the late 700s A.D." Winston Hurst*

You get a lot more volume for your money as you go up in diameter. When you step inside the 18' Archeology Excavation Shelter after being in the 14', the 18' feels twice as big. The 20' Archeology Excavation Shelter feels twice the size of the 18'. This is because the extra feet in diameter extends out in all directions (including up) creating a large increase in volume. Since the surface area of the covering does not increase as rapidly as the volume, the larger domes are less expensive for the space you get.



**The 30' (9 m) Archeology Excavation Shelter™ Tent. Four people can pick this dome up and move it to a new site without taking it down.**

[Archeology Excavation Shelter™ Tent 30](#) Diameter 30'x11' High Weight 190lb. **\$1900** Shipping \$160

[Archeology Excavation Shelter™ Tent 20](#) Diameter 20'x10' High Weight 70 lb. **\$860** Shipping \$55

[Archeology Excavation Shelter™ Tent 18](#) Diameter 18'x9' High Weight 60 lb. **\$720** Shipping \$45

[Archeology Excavation Shelter™ Tent 14](#) Diameter 14'x7' High Weight 40 lb. **\$620** Shipping \$35

[Archeology Excavation Shelter™ Tent 11](#) Diameter 11'x6'4" High Weight 20 lb. **\$580** Shipping \$30

[Archeology Excavation Shelter™ Tent 8](#) Diameter 8'x7'4" High Weight 20 lb. **\$460** Shipping \$30

[Archeology Excavation CrystalCave™ Tent 9](#): 9'x9'x7' High, Weight: 40 lb. **\$520** Ship \$45

[Archeology Excavation CrystalCave™ Tent 11](#): 11'x11'x7' High, Weight: 51 lb. **\$650** Ship \$55

### **30-DAY RISK-FREE TRIAL 1 1/2-YEAR GUARANTEE**

Our guarantee is simple. **YOU MUST BE SATISFIED!** If for any reason you're not completely pleased with your purchase, return it in original, clean condition within 30 days of receipt for a full refund or exchange as you wish. All items in this catalog have a warranty against defects in materials and workmanship for **1 1/2 years**. Should any product prove defective we will repair or replace it at no cost to you. Special Orders are not returnable. Read [Snow and Wind Warnings](#).

[To order](#). by Fax or Mail.

[Order online with our Secure Order Form!](#)

**For fast credit card orders call 650-323-6202**

Questions? E-mail us at [shelter@best.com](mailto:shelter@best.com). Please feel free to call or write us anytime. Shelter Systems-OL, 224 Walnut St., Menlo Park, CA 94025. FAX 650-323-1220 Phone 650-323-6202.

Shelters

Greenhouses

What's New?

Gillis Designs

Stories

Q's & A's

[Price List](#)

[Shelter Systems' Map of Site](#)

Shelter Systems © 1996 - 2003 All Rights Reserved

[Shelter Systems' Home](#)

[Shelters](#)
[Greenhouses](#)
[What's New?](#)
[Gillis Designs](#)
[Stories](#)
[Q's & A's](#)

## Half Domes™

Selected sizes (14, 18, 20, and 30) of Shelter Systems' SolarDomes™, Yurt Domes™, LightHouses™ and GroDome™s can be sliced vertically by us to produce HalfDomes and other sections to create special structures for you. HalfDomes created from our domes, tents, and greenhouses have been used as [Solariums](#), puppet theaters, and attached greenhouses.

We can also make [Special Shapes](#) and Custom Domes for you. Let us know what you need and we can quote you a price.



**20' HalfDom™e of white out and black inside. Used as a puppet theater.**

### All HalfDomes are Special Orders

**HalfDome™ 14:** Diameter 14' Height 7' Weight 28 lb. **\$400** Shipping \$35

**HalfDome™ 18:** Diameter 18' Height 9' Weight 45 lb. **\$490** Shipping \$40

**HalfDome™ 20:** Diameter 20' Height 10' Weight 50 lb. **\$550** Shipping \$45

See also [Special Shapes](#) , [Solariums](#) , [SolarStructures](#) and [Custom Domes and Greenhouses](#).

Be sure to let us know if you want your dome to be made of the White SolarDome or Translucent GroDome covering.

Custom Domes (where the covering or shape has been custom-made for you) are not returnable.

### 30-DAY RISK-FREE TRIAL 1 1/2-YEAR GUARANTEE

Our guarantee is simple. **YOU MUST BE SATISFIED!** If for any reason you're not completely pleased with your purchase, return it in original, clean condition within 30 days of receipt for a full refund or exchange as you wish. All items in this catalog have a warranty against defects in materials and workmanship for **1 1/2 years**. Should any product prove defective we will repair or replace it at no cost to you. Special Orders are not returnable. Read [Snow and Wind Warnings](#).

[To order.](#) by Fax or Mail.

**[Order online with our Secure Order Form!](#)**

**For fast credit card orders call 650-323-6202**

Questions? E-mail us at [shelter@best.com](mailto:shelter@best.com). Please feel free to call or write us anytime. Shelter Systems-OL, 224 Walnut St., Menlo Park, CA 94025. FAX 650-323-1220 Phone 650-323-6202.

[Shelters](#)

[Greenhouses](#)

[What's New?](#)

[Gillis Designs](#)

[Stories](#)

[Q's & A's](#)

[Price List](#)

[Shelter Systems' Map of Site](#)

**Shelter Systems** © 1996 - 2001 All Rights Reserved

[Shelter Systems' Home](#)



Shelters

Greenhouses

What's New?

Gillis Designs

Stories

Q's & A's

## Shelter Systems' Portable Fish and Koi Pond Covers

**Shelter Systems'** Portable Fish Koi Pond Covers have been used to protect ponds from winter weather and leaves and at the same time allow 90% of the sun light (more than glass) to reach the water. Easy no tool set up in under 30 minutes. Shelter Systems' Portable Fish and Koi Pond Covers offer the best value because they are strong, durable, watertight, wind-resistant, aesthetically pleasing, easily set up, and affordable.



**30' Portable Fish and Koi Pond Covers**

Shelter Systems' Pond Fish and Koi Cover structures have the poles on the outside with the covering suspended under the frame via Shelter Systems' own Grip Clip tarp fasteners. The important benefits from this design are that the covering is under constant, even tension so that the tent will not flap in the wind, which would otherwise shred it. The poles cannot rub against the covering, thereby wearing holes in it. Water and leaf debris do not get caught in dips between the poles since the covering is tightly suspended under the poles. Also, since the poles and covering are not touching, there is no temperature buildup to degrade the fabric at contact points.

The [shingled](#) panels of our Portable Fish and Koi Pond Covers overlap each other by 6", making the structure stronger and completely leak proof. The shingling also allows the structure to breathe. The buildup of moisture is driven out through the overlapped panels by vapor pressure and does not condense inside the tent.

Shelter Systems' patented [Grip Clips™](#) tarp fasteners join the dome's cover to the frame. Grip Clips also fasten the shingled panels together, providing greater strength than sewn seams or any type of grommet because they do not puncture the cover, which would allow rain to enter. In addition, the Grip Clip grips a large surface area of the material which prevents the wind from tearing the tent.

### **Durable Materials**

Shelter Systems' Portable Fish and Koi Pond Covers are made wholly of a super strong, tear-proof, [woven rip stop film](#) which will not rot or mildew. The covering effectively excludes rain, dampness, wind, cold, and leaves and other debris. The completely waterproof covering and the shingling's breathability make a rain fly unnecessary. The covering is manufactured in three layers which are heat bonded together. It is UV-stabilized to withstand over 3 years of full sun exposure. The frosted color

Portable Fish and Koi Pond Covers to protect your fish, and water plants from winter weather and leaves

of the covering defuses the sun and provides over 90% of the light to your pond.

The frames are constructed of strong, long lasting, resilient, UV-stabilized, Class 200, 1 1/4"-diameter (3.5 cm.) PVC tubing.



**Fish and Koi Pond Cover Dome 20'**

### **Affordable**

Our waterproof design doesn't require a rain fly and the particular Yurt Dome shapes we use, utilizes material efficiently, so Shelter Systems' pond covers use less material. The high performance covering is affordable. Because of the design and our tarp fasteners, our tents are labor efficient to build. These factors make for reliable and affordable Portable Pond Covers.

### **Controllable Space**

Shelter Systems' Portable Fish and Koi Pond Covers are light filled and well ventilated. The translucent covering creates a bright interior, transmitting 90% of the light (more than glass) plants and fish of all kinds love and flourish in. Shelter Systems' Pond Covers has four flap doors evenly spaced around the dome for good cross ventilation and light. The door coverings close automatically so you can go in or out quickly. There are no zippers to fumble with or break.

Shelter Systems' Portable Fish and Koi Pond Covers are winter ready. They do not require a fly or liner for winter use. They are completely water tight and will not leak. Yet because of their [shingled construction](#) moist air is driven out through the shingling by vapor pressure. Shelter Systems' Portable Pond Covers being dome shaped have a minimal surface area for their volume and are thus easy to keep warm with a stove ([installation instructions](#) are included with each tent).

Since the panels of our domes are shingled, [overhead ventilation](#) is easily attained by inserting a lightweight object (e.g., an empty soda can) between several panels (two "vent tubes" are included with each dome). When the can is removed, the panels snap shut and are watertight. For maximum ventilation the walls themselves can be rolled up, transforming the dome into an [Opened-Arch Form](#).

The dome shape has other comfort features: The interior can be divided into "rooms." The tent has more volume than a flat-sided one and therefore feels, and is, more spacious. The shape is more heat efficient because less fuel is needed to heat it plus the heat circulates more evenly. The cover of the dome is easily cleaned with a damp cloth.



### **Comparing Different Domes**

Our [drawings](#) effectively illustrate the different sizes we offer. Since the surface area of the covering does not increase as rapidly as the volume, the larger domes are less expensive for the usable space inside.

The different domes have different numbers of doors. The 14', 18', and 20' Portable Fish and Koi Pond Covers each have four flap doors evenly spaced around the dome for good cross ventilation. The 30' Portable Pond Cover has eight doors.

Shelter Systems' Portable Fish and Koi Pond Covers perform excellently in strong wind due to their many, evenly spaced anchor points, the fact that the covering is drum tight and that they are shaped to shed the wind. The 14', 18', and 20' Portable Pond Covers each 12 anchor points. The 30'er has 20 anchor points.



**Fish and Koi Pond Cover Top 12'**

### **Easy Access**

Shelter Systems' Fish and Koi Pond Cover Tops have a ring of poles at their base so that you can lift and prop up the cover for easy access to your pond so you can clean filters if needed. They are free standing and light weight. If you desire you can unhook the cover from the ground and pick it up and move the whole cover to the side so you can access the whole fish or Koi pond.

### **Complete and Adaptable**

Shelter Systems' Fish and Koi Pond Covers come complete with poles, 12" long quality Durapeg stakes, guy lines for extreme wind settings, ventilation tubes, spare parts (Grips Clips and pole connectors) and a [Shelter Systems' Instruction Manual](#) that site selection, anchoring, cooling, winterizing, and stove installation. Our covers are ideally suited for most climates; however, they can be further adapted for use in extreme climates. For the extreme cold, where fuel is in short supply, we offer a full liner. For extreme heat, we offer net doors and a sunshade which blocks one hundred per cent of the sunlight. Other [accessories](#) are available.

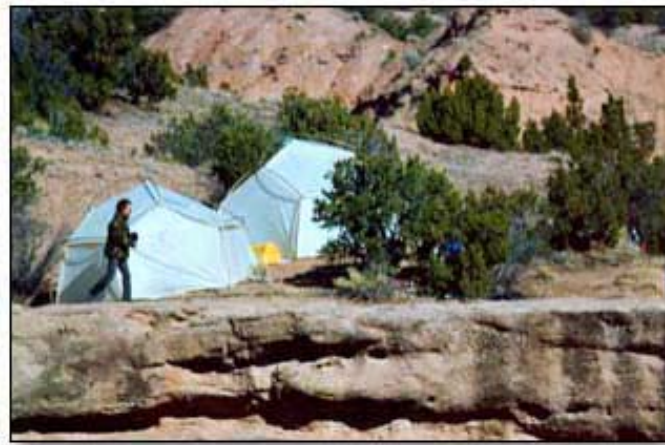

**Fish and Koi Pond Cover Dome 11'**

### **Easy Set Up**

The 18' Fish and Koi Pond Cover can be set up by one person [in 30 minutes](#) without tools. Insert the interchangeable poles into factory-attached connectors spaced evenly over the cover. The poles bend slightly when inserted, tightening the cover into a wind- and waterproof shelter. The cover is freestanding requiring no guy lines and can be moved into the desired position or location without taking it down. The Pond Covers can be taken down in 5 minutes: just remove the poles and roll up the covering.

### **Storage**

All Shelter Systems' Fish and Coy Pond Covers are shipped by UPS and pack up into [compact packages](#) that one person can move around or store.

- Fish and Koi Pond Cover Dome 30** Diameter 30' x 11' High, 706 sq', Weight 190 lb. **\$1900** Shipping \$160
- Fish and Koi Pond Cover Dome 20** Diameter 20' x 10' High, 314 sq', Weight 70 lb. **\$860** Shipping \$55
- Fish and Koi Pond Cover Dome 18** Diameter 18' x 9' High, 254 sq', Weight 60 lb. **\$720** Shipping \$45
- Fish and Koi Pond Cover Dome 14** Diameter 14' x 7' High, 154 sq', Weight 40 lb. **\$620** Shipping \$40

**Fish and Koi Pond Cover Dome 11** Diameter 11'x6'4" High, 95 sq', Weight 20 lb. **\$450** Shipping \$35

**Fish and Koi Pond Cover Top 25'** **\$1400** Shipping \$110

**Fish and Koi Pond Cover Top 18'** **\$495** Shipping \$35

**Fish and Koi Pond Cover Top 16'** **\$400** Shipping \$25

**Fish and Koi Pond Cover Top 12'** **\$345** Shipping \$25

**Fish and Koi Pond Cover Top 8'** **\$280** Shipping \$20

**Fish and Koi Pond Cover Shell 10'** **\$185** Shipping \$22

Note that the Cover Tops and the Cover Shells are Special Orders and are not refundable

### **30-DAY RISK-FREE TRIAL 1 1/2-YEAR GUARANTEE**

Our guarantee is simple. **YOU MUST BE SATISFIED!** If for any reason you're not completely pleased with your purchase, return it in original, clean condition within 30 days of receipt for a full refund or exchange as you wish. All items in this catalog have a warranty against defects in materials and workmanship for **1 1/2 years**. Should any product prove defective we will repair or replace it at no cost to you. Special Orders are not returnable. Read [Snow and Wind Warnings](#).

[To order.](#) By Fax or Mail.

[Order online with our Secure Order Form!](#)

**For fast credit card orders call 650-323-6202**

Questions? E-mail us at [shelter@best.com](mailto:shelter@best.com). Please feel free to call or write us anytime. Shelter Systems-OL, 224 West O'Connor St., Menlo Park, CA 94025. FAX 650-323-1220 Phone 650-323-6202.

Shelters

Greenhouses

What's New?

Gillis Designs

Stories

Q's & A's

[Price List](#)

[Shelter Systems' Map of Site](#)

Shelter Systems © 1996 - 2001 All Rights Reserved

[Shelter Systems' Home](#)





Shelters

Greenhouses

What's New?

Gillis Designs

Stories

Q's & A's

## Pool, Watsu, Spa and Hot Tub Covers

Shelter Systems' Pool, Watsu, Spa and Hot Tub Covers are lightweight and easy and quick to put up. They will protect your spa from leaves and dirt and help hold in the heat. They come standard in our white woven ripstop [covering](#). Even our largest Spa and Hot Tub Cover can be put up in under 30 minutes.

We offer three types of Pool, Watsu, Spa and Hot Tub Covers: The Pool, Watsu, Spa and Hot Tub Shell and the Pool, Watsu, Spa and Hot Tub Top. All are made with the same high-quality materials. The Spa and Hot Tub Shell has a flatter curve and is about 1 1/2' high. The Pool, Watsu, Spa and Hot Tub Tops are between 2 1/2' and 6' high. The Pool, Watsu, Spa and Hot Tub Domes have different heights depending on their diameter. All Grip Clip fasteners and connectors are factory attached. To set up, you simply insert the equal-length PVC poles we provide into the connectors and it's up!

Shelter Systems' Pool, Watsu, Spa and Hot Tub Covers can also be used as low-arched portable greenhouses when made of our translucent greenhouse material.



**Shelter Systems' Pool, Watsu, Spa and Hot Tub Covers are curved outward, which makes them stiff, strong and light.**



**The White Pool, Watsu, Spa and Hot Tub Shell™ above is 10' across.**



**Translucent Pool, Watsu, Spa and Hot Tub Top™ 16' (Top of 18'er)**



**Pool, Watsu, Spa and Hot Tub Top™ 12.5' (Top of 14'er)**



**A translucent 20' Pool, Watsu, Spa and Hot Tub Dome**

- Pool, Watsu, Spa and Hot Tub Shell 10' \$185 Shipping \$22**
- Pool, Watsu, Spa and Hot Tub Top 8' (Top of 10'er) \$280 Shipping \$20**
- Pool, Watsu, Spa and Hot Tub Top 12.5' (Top of 14'er) \$345 Shipping \$25**
- Pool, Watsu, Spa and Hot Tub Top 16' (Top of 18'er) \$400 Shipping \$25**
- Pool, Watsu, Spa and Hot Tub Top 18' (Top of 20'er) \$495 Shipping \$35**
- Pool, Watsu, Spa and Hot Tub Top 25' (Top of 30'er) \$1400 Shipping \$110**

Be sure to let us know whether you want white solar covering or the translucent greenhouse covering.



**A white 30' Pool, Watsu, Spa and Hot Tub Dome**

- Pool, Watsu, Spa and Hot Tub Dome Diameter 8'x7'4" High, 50 sq', Weight 20 lb. \$360 Shipping \$35**
- Pool, Watsu, Spa and Hot Tub Dome Diameter 11'x6'4" High, 95 sq', Weight 20 lb. \$450 Shipping \$35**
- Pool, Watsu, Spa and Hot Tub Dome Diameter 14'x7' High, 154 sq', Weight 40 lb. \$620 Shipping \$40**
- Pool, Watsu, Spa and Hot Tub Dome Diameter 18'x9' High, 254 sq', Weight 60 lb. \$720 Shipping \$45**
- Pool, Watsu, Spa and Hot Tub Dome Diameter 20'x10' High, 314 sq', Weight 70 lb. \$860 Shipping \$55**
- Pool, Watsu, Spa and Hot Tub Dome Diameter 30'x11' High, 706 sq', Weight 190lb. \$1900 Shipping \$160**

Be sure to let us know whether you want white solar covering or the translucent greenhouse covering..

**30-DAY RISK-FREE TRIAL 1 1/2-YEAR GUARANTEE**

Our guarantee is simple. **YOU MUST BE SATISFIED!** If for any reason you're not completely pleased with your purchase, return it in original, clean condition within 30 days of receipt for a full refund or exchange as you wish. All items in this catalog have a warranty against defects in materials and workmanship for **1 1/2 years**. Should any product prove defective we will

repair or replace it at no cost to you. Special Orders are not returnable. Read [Snow and Wind Warnings](#).

[To order](#), by Fax or Mail.

[Order online with our Secure Order Form!](#)

**For fast credit card orders call 650-323-6202**

Questions? E-mail us at [shelter@best.com](mailto:shelter@best.com). Please feel free to call or write us anytime. Shelter Systems-OL, 224 Walnut St., Menlo Park, CA 94025. FAX 650-323-1220 Phone 650-323-6202.

[Shelters](#)

[Greenhouses](#)

[What's New?](#)

[Gillis Designs](#)

[Stories](#)

[Q's & A's](#)

[Price List](#)

[Shelter Systems' Map of Site](#)

**Shelter Systems** © 1996 - 2003 All Rights Reserved

[Shelter Systems' Home](#)

[Shelters](#)[Greenhouses](#)[What's New?](#)[Gillis Designs](#)[Stories](#)[Q's & A's](#)

## Survival and Preparedness Yurt Dome™ Shelters and Tents

Shelter Systems has been making shelters for people around the world for over 20 years. Secure shelter is one of our most basic needs. With the growing global concerns, Shelter Systems provides you with a durable and portable shelter. Shelter Systems' Survival and Preparedness Yurt Dome Shelters and Tents are based on our proven structural designs and excellent materials.

### Sturdy Design

Shelter Systems' Survival and Preparedness Yurt Dome Shelters and Tents are made wholly of a superstrong, [woven ripstop film](#) which is watertight and will not rot or mildew. By using a combination of materials we produce a shelter whose top is constructed of a sun-blocking cover to provide shade and whose sidewalls are made of translucent white material to provide a bright interior.

The frames are constructed of strong, long lasting Class 200 PVC tubing. Shelter Systems' own patented indestructible Grip Clips join the dome's cover to the frame. Grip Clips provide greater strength than sewn seams or any type of grommet, because they do not puncture the cover. Each panel of our Survival and Preparedness Yurt Dome Shelters and Tents are [shingled](#) over the next, so that the domes breathe yet are completely leakproof!

### 18' Survival and Preparedness Dome Shelters

#### Light and Fresh Air

Shelter Systems' 14', 18', and 20' Survival and Preparedness Yurt Dome Shelters and Tents each have four flap doors evenly spaced around the dome. The 8' (2.4m) and 11' (3.3m) have one door. The door coverings close automatically so you can go in or out quickly. There are no zippers to fumble with or break. For maximum ventilation the walls themselves can be



[rolled up](#). There is always plenty of light and fresh air in the Shelter Systems' Survival and Preparedness Yurt Dome Shelters and Tents.

#### Easy Set Up

You will be pleased with how easily our Shelter Systems' Survival and Preparedness Shelters [go up in 30 minutes](#) without tools. You simply insert interchangeable poles into factory-attached connectors spaced evenly over the cover. The poles bend slightly when inserted, which tightens the cover into a wind- and waterproof dynamic shelter. Turn or move the dome into desired position. After the emergency needs

pass, the Shelter Domes can be easily taken down. Just remove the poles, roll up the dome, and store it.

#### A Shelter System

Shelter Systems' Survival and Preparedness Yurt Dome Shelters and Tents come complete with stakes, guy lines, vent tubes,

spare parts and a [Shelter Systems' Instruction Manual](#) that details floors, site selection, anchoring, cooling, winterizing, and stove installation.

[Accessories.](#) Floors, net doors, porches and liners to make your shelter more comfortable.

[Sizes:](#) A drawing comparing the sizes of some of our domes.

### The 11' Survival and Preparedness Shelters

Note that the 8' and 11' Survival Yurt Dome Shelters and Tents are constructed using a different geometry that has less panels and only one door; see photo above. The 14', 18', 20', and 30' each have four doors. You get a lot more volume as you go up in diameter. When you step inside the 18' after just being in the 14', the 18' feels twice as big. The 20' feels twice the size of the 18'. This is because the size in diameter extends out in all directions creating a large increase in volume. Since the surface area of the covering does not increase as rapidly as the volume, the larger domes are less expensive.



**Different size domes can be clustered around each other.**



**The 30' (9 m) Survival and Preparedness Yurt Dome™ Shelters would be an excellent community focal point for "villages" of smaller domes.**

## Prices:

**Survival and Preparedness Yurt Dome Portable Shelters and Tents 30' Diameter 30'x11' High Weight 190lb. \$1900**  
Shipping \$160

**Survival and Preparedness Yurt Dome Portable Shelters and Tents 20' Diameter 20'x10' High Weight 70 lb. \$860** Shipping \$55

**Survival and Preparedness Yurt Dome Portable Shelters and Tents 18'** Diameter 18'x9' High Weight 60 lb. **\$720** Shipping \$45

**Survival and Preparedness Yurt Dome Portable Shelters and Tents 14'** Diameter 14'x7' High Weight 40 lb. **\$620** Shipping \$35

**30-DAY RISK-FREE TRIAL 1 1/2-YEAR GUARANTEE**

Our guarantee is simple. **YOU MUST BE SATISFIED!** If for any reason you're not completely pleased with your purchase, return it in original, clean condition within 30 days of receipt for a full refund or exchange as you wish. All items in this catalog have a warranty against defects in materials and workmanship for **1 1/2 years**. Should any product prove defective we will repair or replace it at no cost to you. Special Orders are not returnable. Read [Snow and Wind Warnings](#).

[To order](#), by Fax or Mail.

[Order online with our Secure Order Form!](#)

**For fast credit card orders call 650-323-6202**

Questions? E-mail us at [shelter@best.com](mailto:shelter@best.com). Please feel free to call or write us anytime. Shelter Systems-OL, 224 Walnut St., Menlo Park, CA 94025. FAX 650-323-1220 Phone 650-323-6202.

[Shelters](#)

[Greenhouses](#)

[What's New?](#)

[Gillis Designs](#)

[Stories](#)

[Q's & A's](#)

[Price List](#)

[Shelter Systems' Map of Site](#)

Shelter Systems © 1996 - 2001 All Rights Reserved

[Shelter Systems' Home](#)

[Shelters](#)[Greenhouses](#)[What's New?](#)[Gillis Designs](#)[Stories](#)[Q's & A's](#)

## Shade Structures™

Shelter Systems' structures can be made for use as **ShadeStructures™**. Simply request that we use our silver and black [Shade material](#), which is silver outside to reflect light and the sun and black inside to block light and sun. You should consider letting some of the covering be white to let light in. To increase ventilation consider using the domes in the [Arch Form](#) or one of [CrystalCaves](#) with both ends open. We can also make our tarp tents of the Shade material. Even our [Porch](#) can be made using the Shade material. If you need shade only part of the time, consider one or more of our 6' x 12' [SunShades](#), which you can attach to your dome where you need it.



Here is a [HalfDome™](#) constructed of our Shade Covering.



A [CrystalCave™](#) with Shade Covering





[ShadeAwnings™](#)

See also [Special Shapes](#) and [Custom Domes and Greenhouses](#).

Questions? E-mail us at [shelter@best.com](mailto:shelter@best.com). Please feel free to call or write us anytime. Shelter Systems-OL, 224 West O'Connor St., Menlo Park, CA 94025. FAX 650-323-1220 Phone 650-323-6202.

[Shelters](#)

[Greenhouses](#)

[What's New?](#)

[Gillis Designs](#)

[Stories](#)

[Q's & A's](#)

**Shelter Systems** © 1996 - 2001 All Rights Reserved

[Shelter Systems' Home](#)



Shelters

Greenhouses

What's New?

Gillis Designs

Stories

Q's &amp; A's

# Portable Telescope and Observatory StarDomes™ Astronomical Domes

**Shelter Systems'** lightweight, portable telescope and observatory **StarDomes™** astronomical domes are designed to protect astronomers and their telescopes from light, wind and dew. The StarDomes telescope and observatory domes are freestanding and can be turned or moved easily. They are constructed with our [white/black](#), light-blocking covering. This woven, ripstop covering will exclude all light from the interior of the observatory dome except for the opening for your telescope.

Two window flaps with velcro closures are provided for your telescope. The window openings are not cut by us nor are the window flaps installed. This way you can put them where you need them. We provide you with velcro that is backed with sticky tape and two 3' x 3' window coverings of the White/Black so you can place the windows where you want them. Large sections of the roof can be remove. In fact the whole top if needed. However it is more practical to remove just a panel (area between poles) in that a cover is more easily made to cover it when needed. The dome is freestanding and can be moved or rotated about your telescope, wind permitting.

## The Telescope and Observatory StarDome™ 18' Astronomical Dome



### Sturdy Design

The StarDome telescope and observatory dome is made wholly of a White and Black, superstrong, [woven ripstop film](#) treated with ultraviolet inhibitors which protect against sun exposure. The covering is watertight and will not rot or mildew.

The frames of the StarDomes telescope and observatory domes are constructed of strong, long-lasting PVC tubing. Patented Grip Clips™ join the dome's cover to the frame. Grip Clips™ provide greater strength than sewn seams or any type of grommet, because they do not puncture the cover. Each panel of the domes is [shingled](#) over the next so that the domes breathe yet are completely leakproof!

### Construction

The StarDome 14, 18, and 20 domes have four flap doors evenly spaced around the dome. The StarDome 8 and 11 domes have one door. The door coverings close automatically so you can go in or out quickly. There are no zippers to fumble with or break.



### **The StarDome™ 8 Telescope and Observatory Dome**

#### **All StarDomes™ are Special Orders**

**StarDome™ 20 Telescope and Observatory Dome** Diameter 20'x10' High. Weight 70 lb. **\$910** Shipping \$55

**StarDome™ 18 Telescope and Observatory Dome** Diameter 18'x9' High. Weight 60 lb. **\$770** Shipping \$45

**StarDome™ 14 Telescope and Observatory Dome** Diameter 14'x7' High. Weight 40 lb. **\$670** Shipping \$35

**StarDome™ 11 Telescope and Observatory Dome** Diameter 11'x6'4" High. Weight 20 lb. **\$530** Shipping \$35

**StarDome™ 8 Telescope and Observatory Dome** Diameter 8'x7'4" High. Weight 20 lb. **\$410** Shipping \$35

Note that the SD11 and SD8 domes are constructed using a different geometry that has less panels. They are not spherical and have only one door. If you like the spherical shape but need a small diameter dome, check out the [StarBubble™ 10](#). If you want four doors, choose the 14, 18, or 20'ers. You get a lot more volume as you go up in diameter. When you step inside the 18'er after just being in the 14'er, the 18 feels twice as big. The 20 feels twice the size of the 18. This is because the extra feet in diameter extends out in all directions, creating a large increase in volume. Since the surface area of the covering does not increase as rapidly as the volume, the larger domes are less expensive for the space you get.

#### **A Shelter System**

The StarDome telescope and observatory domes comes complete with stakes, guy lines, vent tubes, spare parts and a [Shelter Systems Instruction Manual](#) that details floors, site selection, anchoring, and winterizing.

[Setting up a Shelter Systems' Dome.](#)

[Accessories:](#) To make your observatory dome more comfortable. Floors, liners and more.

[Sizes:](#) A drawing comparing the sizes of 8'er, 11'er, 14'er, 18'er, and 20'er.

[StarCave](#) A tunnel-like observatory structure

[StarBubble™](#) These observatories are a taller form of our Star Domes™.

### **1 1/2-YEAR GUARANTEE**

All items in this catalog have a warranty against defects in materials and workmanship for **1 1/2 years**. Should any product prove defective we will repair or replace it at no cost to you. Special Orders are not returnable; since we do not offer them in our catalog and we would have trouble reselling them.

[To order.](#) by Fax or Mail.

[Order online with our Secure Order Form!](#)

**For fast credit card orders call 650-323-6202**

Questions? E-mail us at [shelter@best.com](mailto:shelter@best.com). Please feel free to call or write us anytime. Shelter Systems-OL, 224 Walnut St., Menlo Park, CA 94025. FAX 650-323-1220 Phone 650-323-6202.

[Shelters](#)

[Greenhouses](#)

[What's New?](#)

[Gillis Designs](#)

[Stories](#)

[Q's & A's](#)

[Price List](#)

[Shelter Systems' Map of Site](#)

**Shelter Systems** © 1996 - 2001 All Rights Reserved

[Shelter Systems' Home](#)

[Shelters](#)[Greenhouses](#)[What's New?](#)[Gillis Designs](#)[Stories](#)[Q's & A's](#)

## Tarp Fasteners: Grip Clip™

The Critical Key to our tent, dome, and greenhouse structures is our non-puncturing tarp fastener, the **Grip Clip™**, which allows us to "shingle" and shape a variety of tarp and fabric materials together into functional shelters. [Shingling](#) is achieved by layering the tarp panels over each other as you would shingle a roof of a house and then "clipping" them together. This creates a waterproof covering. Attached, the Grip Clips also serve as anchoring points for poles and stakes.

You can apply the Grip Clip easily to a tarp by hand and you can also use it to join two tarps together or to shape a tarp to fit a desired function by gathering up a fold. They also provides a secure anchor for staking or attaching poles or guy lines. You will find endless uses for them at home, in the garden, while camping, and at construction sites.

**Note: In all shelters that Shelter Systems offers, the Grip Clips are attached by us at our factory. To set up a shelter you have only to add the poles and it is up in minutes.**



Easy Assembly    150 lb. side pull    200 lb. 2-tarp hang test    Will not "pop off"

Non-Puncturing    Pull any direction.    Join two tarps    Repair torn tarps.

### Thousands of Uses

With Grip Clips tarp fasteners you can transform tarps and fabric into hundreds of useful items: tents, bike and storage sheds, car covers, lumber coverings, hammocks, car seat covers, a cover for a leaky roof, kayaks, firewood coverings, rain flies over tents, motorcycle covers, kites, truck bed covering, gardening row covers, leaf bags, compost bin, survival shelter, canopies, window awning, wading pool, windscreens, greenhouses....

And you can use Grip Clips tarp fasteners in hundreds of situations: mending tarps, joining two tarps, fixing "blown" grommets, hanging curtains, attaching keys to a briefcase, a backpack, or to clothing, hanging dish towels and wash clothes, hanging shower curtains, tying down tents and flies, securing sheets, hanging mosquito netting over your bed, securing a tablecloth on a picnic table....The possibilities are [endless!](#)

### The Design

The Grip Clip tarp fastener is specially designed to lock on to tarps and fabrics, without puncturing them. The Grip Clip tarp fastener will withstand a 150-to-200 lb. pull without coming off or tearing the tarp at the point of attachment. We achieve this through the following design features. The tarp passes over and under multiple sections of the tarp fastener. Thus the tarp is in contact with a large surface area of the fastener. By spreading out the force exerted on the tarp and increasing the friction

between it and the fastener, the tarp is prevented from slipping or tearing. The two pieces of the Grip Clip tarp fastener lock together (somewhat like a button in a button hole), engaging the tarp between them, so that the two pieces cannot come apart accidentally.



### Construction

The Grip Clip tarp and fabric fastener is made of a UV-stabilized (for longer sun resistance), extremely tough and durable co-polymer. The tarp fastener's color is white to reflect the sun's heat and light which will prevent the sun from degrading the tarp at points of attachment.

The 11" cord provided with each Grip Clip is a super nylon with a weight-bearing strength of 550 pounds.

### The Revolution

The Grip Clip tarp and fabric fastener will revolutionize the way you think of tarps. No more grommets ripping out and your expensive tarp, ruined, flapping in the wind. You will find that you can--on the spot--join and shape tarps to create watertight covers without resorting to sewing (time consuming and leaks at the seams), tape (messy and peels off) or other tarp fasteners (which pop off).

| <b>Light Fabric Grip Clip</b>                                                                                                                                                                                                             | <b>General Purpose Grip Clip</b>                                                                                                                                                                                                            | <b>Heavy-Duty Grip Clip</b>                                                                                                                                                                               |
|-------------------------------------------------------------------------------------------------------------------------------------------------------------------------------------------------------------------------------------------|---------------------------------------------------------------------------------------------------------------------------------------------------------------------------------------------------------------------------------------------|-----------------------------------------------------------------------------------------------------------------------------------------------------------------------------------------------------------|
|                                                                                                                                                         |                                                                                                                                                           |                                                                                                                       |
| <p>Light Fabric Grip Clip (1 3/8") is tough and small. Use for thin nylon tarps and fabric. <b>Set of 4 LF Grip Clips for \$8.</b> Set of 20 LF Grip Clips for \$25. <b>Set of 4 Micro Grip Clip (1 1/8") for \$10.</b> Free Shipping</p> | <p>General Purpose (2 3/8") Grip Clip is versatile and strong. Use in every day situations, normal tarps plastic coverings, and the woven films that we sell. <b>Set of 4 GP Grip Clips for \$10.</b> Set of 20 for \$40. Free Shipping</p> | <p>Heavy-Duty (3 5/8") Grip Clip is rugged and tough. Use in severe weather, for extra strength or on large or thick tarps: <b>Set of 2 HD Grip Clips for \$10;</b> Set of 10 for \$30. Free Shipping</p> |

See how LFGC's and MGC's are used with [Ultra-Light Weight 1.1oz Nylon](#)

#### **Grip Clip Bulk Pricing** without cord:

LF 100 for \$100, GP 100 for \$150, HD 100 for \$250. Shipping \$10.

Call in Your Bulk Orders: 650-323-6202



**Assortment:** one of each size Grip Clips \$15

Weight of Light Fabric Grip Clips without cord is 6 grams, .2 oz; General Purpose 14 grams, .5 oz; Heavy-Duty 28 grams, 1 oz.

**Nylon Cord comes with each Grip Clip.**

## **Grip Clips™ will help you create what you need."**

**What you can make with Grip Clips is limitless! "**

[Attaching](#) Grip Clips: Photos show the Magic!

The Grip Clips' Own [Web Site](#): Thousands of Uses!

[Four-Hour Kayak](#) Using Grip Clips!

The Grip Clip [Tarp Tent Kit](#). Tarp with Grip Clips & Instructions.

The Grip Clip [Header Card](#): Attached to Grip Clips in Stores

### **30-DAY RISK-FREE TRIAL 1 1/2-YEAR GUARANTEE**

Our guarantee is simple. **YOU MUST BE SATISFIED!** If for any reason you're not completely pleased with your purchase, return it in original, clean condition within 30 days of receipt for a full refund or exchange as you wish. All items in this catalog have a warranty against defects in materials and workmanship for **1 1/2 years**. Should any product prove defective we will repair or replace it at no cost to you. Special Orders are not returnable. Read [Snow and Wind Warnings](#).

[To order](#). by Fax or Mail.

[Order online with our Secure Order Form!](#)

**For fast credit card orders call 650-323-6202**

Questions? E-mail us at [shelter@best.com](mailto:shelter@best.com). Please feel free to call or write us anytime. Shelter Systems-OL, 224 Walnut St., Menlo Park, CA 94025. FAX 650-323-1220 Phone 650-323-6202.

Shelters

Greenhouses

What's New?

Gillis Designs

Stories

Q's & A's

[Price List](#)

[Shelter Systems' Map of Site](#)

**Shelter Systems** © 1996 - 2003 All Rights Reserved







## The Amazing Tarp and Fabric Fasteners: Grip Clips <sup>tm</sup>

[Home](#) [Gardening](#) [House & Yard](#) [Camping](#)  
[Automotive](#) [Sporting](#) [Products & Ordering](#) [Links](#)

### The Strongest, Most Versatile Tarp Fastener Ever! <sup>tm</sup>

The **Grip Clip** <sup>tm</sup> tarp and fabric fastener attaches quickly and easily to a tarp or any fabric without tools. It can be used to join two tarps or to shape a tarp to fit a desired function by gathering up a fold. It also provides a secure anchor for staking or attaching poles or guy lines. You will find endless uses for them at home, in the garden, at construction sites, and while camping, boating, snowmobiling, hunting, fishing, and more.



#### Thousands of Uses

With Grip Clips tarp fasteners you can transform tarps and fabric into hundreds of useful items: [tents](#), [bike](#) and [storage sheds](#), [car covers](#), lumber coverings, [hammocks](#), [car seat covers](#), a cover for a [leaky roof](#), [kayaks](#), [firewood coverings](#), rain flies over tents, [motorcycle covers](#), kites, [truck bed covering](#), gardening row covers, [leaf bags](#), compost bin, [survival shelter](#), canopies, [window awning](#), [wading pool](#), windscreens, [greenhouses](#)....

And you can use Grip Clips tarp fasteners in hundreds of situations: [mending](#) tarps, [joining](#) two tarps, fixing "[blown](#)" [grommets](#), hanging [curtains](#), attaching keys to a [briefcase](#), a [backpack](#), or to [clothing](#), hanging [dish towels](#) and [wash clothes](#), hanging [shower curtains](#), [tying down](#) tents and flies, securing [sheets](#), hanging [mosquito netting](#) over your bed, securing a [tablecloth](#) on a picnic table....The possibilities are endless!

# Almost indestructible and at times indispensable!™

- Easy Assembly
- Will Not Puncture Tarps
- 150 lb. Side Pull
- 200 lb. 2-Tarp Hang Test
- Join Two Tarps
- Will Not "Pop Off"
- Pull From Any Direction
- Repair Torn Tarps

## Questions and Answers

### **The Design**

The Grip Clip tarp fastener is specially designed to lock on to tarps and fabrics, without puncturing them. The Grip Clip tarp fastener will withstand a 150-to-200 lb. pull without coming off or tearing the tarp at the point of attachment. We achieve this through the following design features. The tarp passes over and under multiple sections of the tarp fastener. Thus the tarp is in contact with a large surface area of the fastener. By spreading out the force exerted on the tarp and increasing the friction between it and the fastener, the tarp is prevented from slipping or tearing. The two pieces of the Grip Clip tarp fastener lock together (somewhat like a button in a button hole), engaging the tarp between them, so that the two pieces cannot come apart accidentally.

### **Construction**

The Grip Clip tarp and fabric fastener is made of a UV-stabilized (for longer sun resistance), extremely tough and durable co-polymer. The tarp fastener's color is white to reflect the sun's heat and light which will prevent the sun from degrading the tarp at points of attachment. The 11" cord provided with each Grip Clip is a super nylon with a weight-bearing strength of 550 pounds.

### **The Revolution**

The Grip Clip tarp and fabric fastener will revolutionize the way you think of tarps. No more grommets ripping out and your expensive tarp, ruined, flapping in the wind. You will find that you can--on the spot--join and shape tarps to create watertight covers without resorting to sewing (time consuming and leaks at the seams), tape (messy and peels off) or other tarp fasteners (which pop off).

See how the [competition compares](#) to The Grip Clip.

[Order online with our Secure Order Form!](#)

**30-DAY RISK-FREE TRIAL 1 1/2-YEAR GUARANTEE**

Questions? call (650) 323-6202,  
or email: [shelter@best.com](mailto:shelter@best.com)

[Home](#) [Gardening](#) [House & Yard](#) [Camping](#)  
[Automotive](#) [Sporting](#) [Products & Ordering](#) [Who We Are](#) [Links](#)

[Shelter Systems](#) © 1998 - 2002 All Rights Reserved



Shelters

Greenhouses

What's New?

Gillis Designs

Stories

Q's & A's

## Four-Hour Grip Clip Kayak!

You can build a kayak of green willow shoots, a blue tarp and Shelter Systems' [Grip Clips](#) in just four hours!



Completed frame side view.



The amount of willow used to make the kayak. If you plan to build this kayak consider building a [model \(click here to see the modle we made first\)](#).



Some of the willow is twisted into ribs. Some into stringers. The largest two ribs are 16" by 27". The stringers are overlapped 2' 3" (this makes the stringers stronger in the middle where they need it the most).

[NEXT 4 PHOTOS](#)

Questions? E-mail us at [shelter@best.com](mailto:shelter@best.com). Please feel free to call or write us anytime. Shelter Systems-OL, 224 Walnut St., Menlo Park, CA 94025. FAX 650-323-1220 Phone 650-323-6202.

[Shelters](#)

[Greenhouses](#)

[What's New?](#)

[Gillis Designs](#)

[Stories](#)

[Q's & A's](#)

Shelter Systems © 1996 - 2001 All Rights Reserved

[Shelter Systems' Home](#)



[Shelters](#)[Greenhouses](#)[What's New?](#)[Gillis Designs](#)[Stories](#)[Q's & A's](#)

## Grip Clip™ Tarp Tents™

**The Grip Clip™ Tarp Tents™** are lightweight and compact. They make great additions to our domes or can be used alone for emergency shelters, fair pavilions, expedition tents, research tents, and more. Campers, and Outfitters will find them particularly valuable. It is easy to change the shape of your **Grip Clip Tarp Tents** to suit your needs; all of the following styles and more can be made in minutes. Because of their openness they are easy to get in and out of, and can cover eating areas.



**The One-Pole Grip Clip TarpTent™**

**The Grip Clip Tarp Tents™** are made of blue [woven ripstop film](#), which is watertight and will not rot or mildew. They are intended that the user provide poles often found on site. Two or more **Grip Clip Tarp Tents** can be joined to create a larger [shingled](#) tent so that one half is over the next so that the combined tent is completely leak proof!

### Easy Set Up

You will be pleased with how easily your **Grip Clip Tarp Tent** can be assembled in 30 minutes without tools. You simply [attach Grip Clips](#) add cord and stake out the cover. The poles are tied to some of the **Grip Clip**. When staked out your **Grip Clip Tarp Tent** tightens into a wind and waterproof dynamic shelter.

### A Shelter System

**The Grip Clip Tarp Tents** come complete with cover Grip Clips, [stakes](#), guy lines, and an instruction booklet that details floors, site selection, and anchoring.

[Shelter Systems Instruction Manual](#). Setup, storage, repairs, wood stoves etc. ...



**The Two-Pole Grip Clip TarpTent™**



**The Four-Pole Grip Clip TarpTent™**



**The Two-Pole Closed-Back Grip Clip TarpTent™**

**Grip Clip Tarp 11' x 15' \$105. 5.3 lb. Shipping \$20**

**Grip Clip Tarp 15' x 23' \$160. 10 lb. Shipping \$35**



**30-DAY RISK-FREE TRIAL. 1 1/2-YEAR GUARANTEE**

## **Grip Clips will help you create what you need.**

What you can make with [Grip Clips](#) is limitless!™

[Grip Clip Pricing](#)

[Grip Clip Header Card](#)

[Emergency Shelter Systems](#)

[Four Hour Kayak Using Grip Clips!](#)

[Attaching Grip Clips Photos](#) show how to

[How to order.](#) Call , Fax or Send.

**30-DAY RISK-FREE TRIAL 1 1/2-YEAR GUARANTEE**

Our guarantee is simple. **YOU MUST BE SATISFIED!** If for any reason you're not completely pleased with your purchase, return it in original, clean condition within 30 days of receipt for a full refund or exchange as you wish. All items in this catalog have a warranty against defects in materials and workmanship for **1 1/2 years**. Should any product prove defective we will repair or replace it at no cost to you. Special Orders are not returnable. Read [Snow and Wind Warnings](#).

[To order.](#) by Fax or Mail.

[Order online with our Secure Order Form!](#)

**For fast credit card orders call 650-323-6202**

Questions? E-mail us at [shelter@best.com](mailto:shelter@best.com). Please feel free to call or write us anytime. Shelter Systems-OL, 224 Walnut St., Menlo Park, CA 94025. FAX 650-323-1220 Phone 650-323-6202.

[Shelters](#)

[Greenhouses](#)

[What's New?](#)

[Gillis Designs](#)

[Stories](#)

[Q's & A's](#)

[Price List](#)

[Shelter Systems' Map of Site](#)

**Shelter Systems** © 1996 - 2001 All Rights Reserved

[Shelter Systems' Home](#)



Shelters

Greenhouses

What's New?

Gillis Designs

Stories

Q's & A's

## Kid Tents and Huts

Kids can make their own tents and huts with woven film, tarps, sheets, string and Grip Clips™.



This is a "shelter" that my friend and I made out of Grip Clips™, tarps, and string. We fastened two pieces of string to two trees that were directly across from each-other. Then we fastened the pieces of string to two ends of a tarp using Grip Clips. Then we fastened another tarp to the first tarp on one side, and then we fastened another tarp to the other side of the first one. Then we attached string to the second and third tarp on each end. Then we tied each string to two other trees. Then we took a half of a tarp and fastened it to the open side of the "shelter" which would serve as a doorway. Then we took another half of a tarp and fastened it to the top to serve as a roof. The "shelter" is about 5' x 6'. We plan to sleep out in a similar shelter this summer.

**Adam Zwicker (age 11)**

**[Grip Clips™ Tarp Fasteners](#)** That which holds it all together.

**Price:** 4 Clips for \$10 (includes Shipping). 11" of nylon cord comes with each Grip Clip.



### **30-DAY RISK-FREE TRIAL 1 1/2-YEAR GUARANTEE**

Our guarantee is simple. **YOU MUST BE SATISFIED!** If for any reason you're not completely pleased with your purchase, return it in original, clean condition within 30 days of receipt for a full refund or exchange as you wish. All items in this catalog have a warranty against defects in materials and workmanship for **1 1/2 years**. Should any product prove defective we will repair or replace it at no cost to you. Special Orders are not returnable. Read [Snow and Wind Warnings](#).

[To order](#), by Fax or Mail.

[Order online with our Secure Order Form!](#)

**For fast credit card orders call 650-323-6202**

Questions? E-mail us at [shelter@best.com](mailto:shelter@best.com). Please feel free to call or write us anytime. Shelter Systems-OL, 224 Walnut St., Menlo Park, CA 94025. FAX 650-323-1220 Phone 650-323-6202.

[Shelters](#)

[Greenhouses](#)

[What's New?](#)

[Gillis Designs](#)

[Stories](#)

[Q's & A's](#)

[Price List](#)

[Shelter Systems' Map of Site](#)

Shelter Systems © 1996 - 2001 All Rights Reserved

[Shelter Systems' Home](#)

[Shelters](#)[Greenhouses](#)[What's New?](#)[Gillis Designs](#)[Stories](#)[Q's & A's](#)

## Who We Are

**Shelter Systems** is an independently owned business dedicated to creating environmentally sound, low impact shelters tents and greenhouses. We manufacture a wide range of Tensegrity and Geodesic structures. Our portable shelters have protected people around the world for over 20 years by providing [shelter](#) in all types of conditions. Our [greenhouse](#) line has resulted from the blending of business with lifestyle.



**[Bob Gillis](#)**, owner of Shelter Systems and inventor of the Grip Clip tarp and tent fastener, has a long history of design in the tent industry, licensing tents to The North Face, Sierra Designs, Mountain Hardware, Marmot, and others. He has been granted 18 U.S. patents, from structural concepts to the molded clips used in the construction of Shelter Systems' dome, yurt, tent and greenhouse structures.

Bob revolutionized the tent industry in 1976 by designing the first geodesic backpacking tent, The [Oval Intention](#), using [tensegrity](#) design principles. Almost all of the backpacking tents using flexed poles that you see on the market are covered by Bob Gillis' patents.

**Jeffrey Devitt** has been Production Manager for Shelter Systems for over ten years. He is an avid outdoorsman and his attention to detail is unmatched.



**[Jorma Rodieck](#)** creates the web pages for Shelter Systems and Grip Clips. Jorma has lived in Santa Cruz, CA, for the last eight years, where he surfs and SCUBA dives in his free time. You can see some more of Jorma's work at <http://www.jorma.com>.

Questions? E-mail us at [shelter@best.com](mailto:shelter@best.com). Please feel free to call or write us anytime. Shelter Systems-OL, 224 Walnut St., Menlo Park, CA 94025. FAX 650-323-1220 Phone 650-323-6202.

Shelters

Greenhouses

What's New?

Gillis Designs

Stories

Q's & A's

**Shelter Systems** © 1996 - 2003 All Rights Reserved

[Shelter Systems' Home](#)



Shelters

Greenhouses

What's New?

Gillis Designs

Stories

Q's & A's

## Design Projects

**Shelter Systems** has consulted on many shelter and structure design projects: Everest Base Camp, Emergency Relief Shelter, Folding Shelter designed for the Army, F22 Tent.



**Our Domes have been to Everest Base Camp many times over the years.**



**Dymax Emergency Relief Shelter.**



**Dymax Emergency Relief Shelter boxed up.**

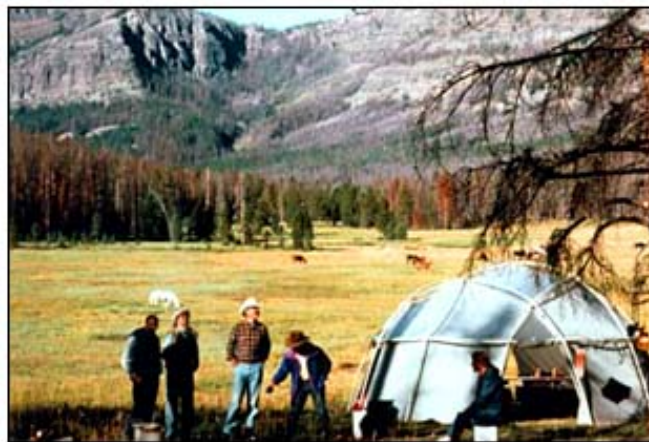

**Horse-Packable Shelter.**



**SuperStrong Folding Shelter designed for the U.S. Army.**

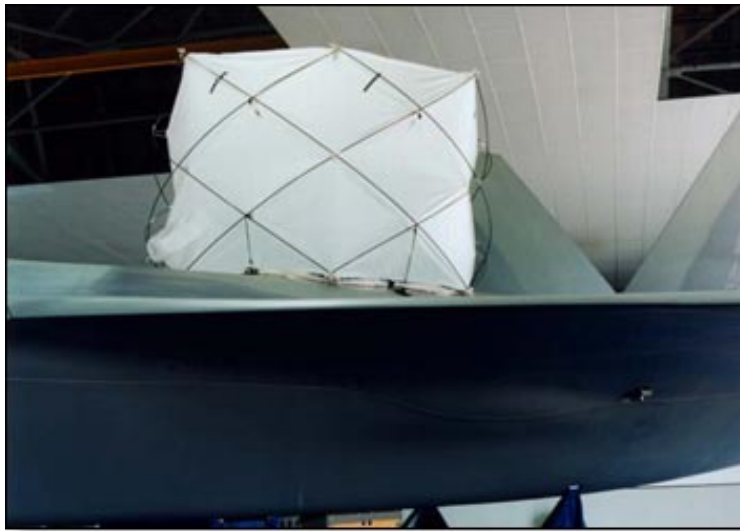

**Special Cylindrical Tent for working on panels of the F22.**

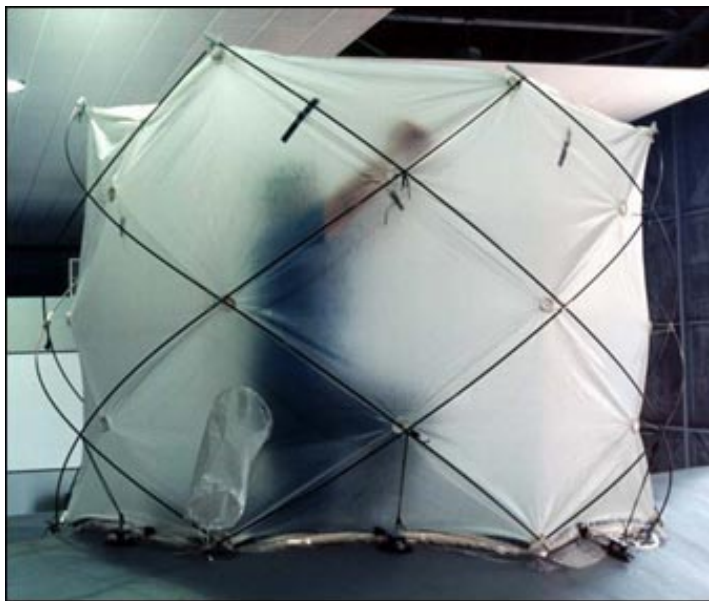

**The F22 Tent showing the ventilation port.**

Questions? E-mail us at [shelter@best.com](mailto:shelter@best.com). Please feel free to call or write us anytime. Shelter Systems-OL, 224 Walnut St., Menlo Park, CA 94025. FAX 650-323-1220 Phone 650-323-6202.

[Shelters](#)

[Greenhouses](#)

[What's New?](#)

[Gillis Designs](#)

[Stories](#)

[Q's & A's](#)

**Shelter Systems** © 1996 - 2001 All Rights Reserved

[Shelter Systems' Home](#)





Shelters

Greenhouses

What's New?

Gillis Designs

Stories

Q's & A's

## Award-Winning Designs

Shelter Systems has created award-winning tent designs: the Oval Intention and the Orbit Tent.

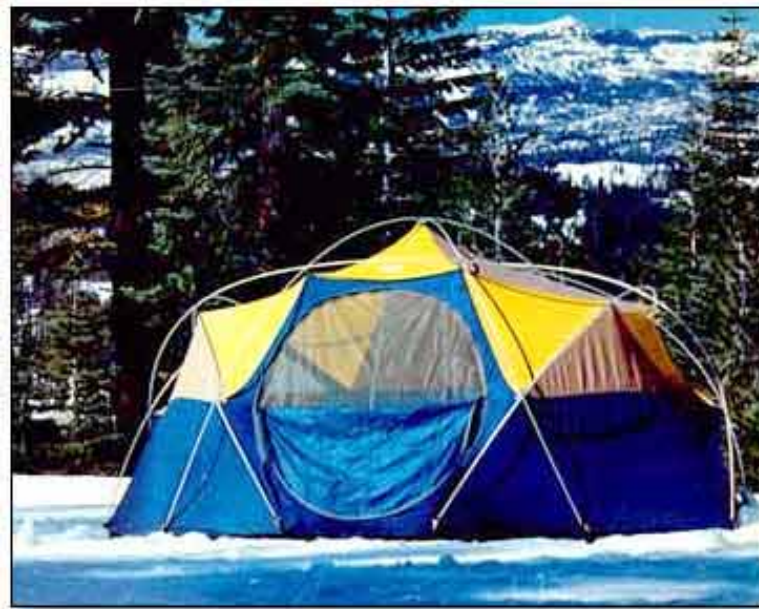

### Oval Intention

Produced under license by The North Face. "The Tent that pioneered the Geodesic Revolution"  
"The first geodesic backpacking tent ever made." See first prototype in Shelter Systems' [History](#)



### The Orbit Tent

Winner of the Product Design Awards in Backpacker Magazine.

"The Orbit was the only tent that we could put up without knowing anything."

Questions? E-mail us at [shelter@best.com](mailto:shelter@best.com). Please feel free to call or write us anytime. Shelter Systems-OL, 224 Walnut St., Menlo Park, CA 94025. FAX 650-323-1220 Phone 650-323-6202.

Shelters

Greenhouses

What's New?

Gillis Designs

Stories

Q's & A's

**Shelter Systems** © 1996 - 2001 All Rights Reserved

[Shelter Systems' Home](#)



Shelters

Greenhouses

What's New?

Gillis Designs

Stories

Q's & A's

## Set and Geometric Prop Production Design for TV, Movies, Music Videos and Plays Using Domes, Tunnels and other Shapes

Many of **Shelter Systems'** structures can be used as is for sets or props for TV, movies, music videos and plays. We have already made domes for various sets, including [Earth 2](#), [Flubber](#), [Contact](#), [Earth: Final Conflict](#) and others. We can also make shapes to order for your set design project. Let us know what you need and we will quote you a price.

Look through the following to get an idea of some of the shapes we can make.









[Click here to see more shapes](#)

**Let us help you create what you need.**

Questions? E-mail us at [shelter@best.com](mailto:shelter@best.com). Please feel free to call or write us anytime. Shelter Systems-OL, 224 West O'Connor St., Menlo Park, CA 94025. FAX 650-323-1220 Phone 650-323-6202.

[Shelters](#)

[Greenhouses](#)

[What's New?](#)

[Gillis Designs](#)

[Stories](#)

[Q's & A's](#)

**Shelter Systems © 1996 - 2001 All Rights Reserved**

[Shelter Systems' Home](#)



Shelters

Greenhouses

What's New?

Gillis Designs

Stories

Q's &amp; A's

## Additional Shelter Systems' Patents

In addition to the tent, dome and greenhouse structures which Shelter Systems markets, we hold patents on a variety of other items, from folding rocking chairs and optical toys to children's climbing gyms.

**Origami Dome™ Tent:** An Amazing Folding Tensegrity dome shelter of rigid panels dome shelter that folds flat when not needed! When made as a [Folding Tent](#) with poles on the edges it folds into a tight bundle. [Make one of cardboard.](#) These patent drawings show how the Origami Dome™ Tent folds flat.

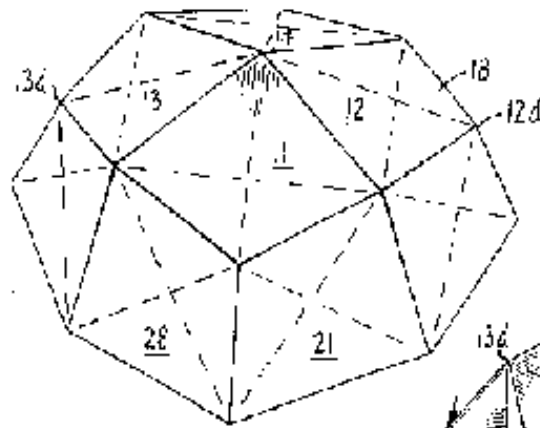

FIG. 4A.

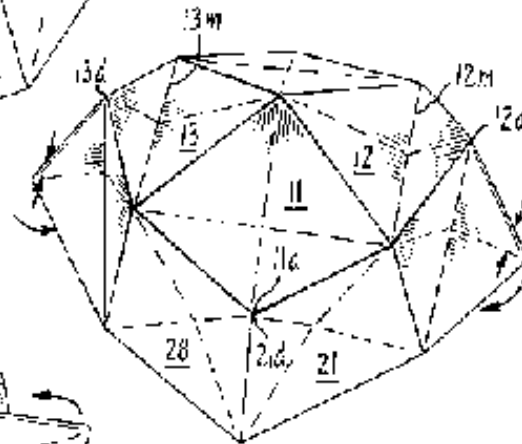

FIG. 4B.

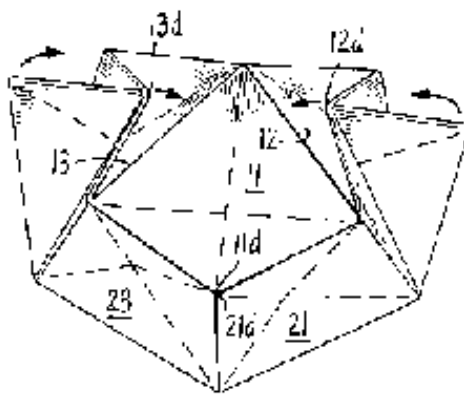

FIG. 4C.

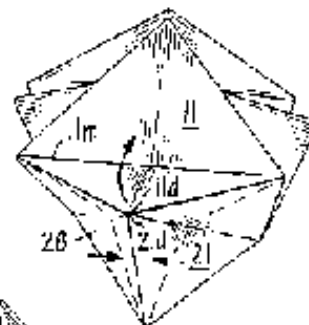
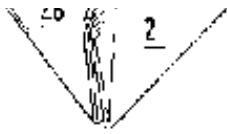

FIG. 4D.





**The Monkey Maze™**





**The Puzzle Rocker tm**



**The Puzzle**

---



**The Kalidosky turns light into patterns and colors.**

Questions? E-mail us at [shelter@best.com](mailto:shelter@best.com). Please feel free to call or write us anytime. Shelter Systems-OL, 224 Walnut St., Menlo Park, CA 94025. FAX 650-323-1220 Phone 650-323-6202.

Shelters

Greenhouses

What's New?

Gillis Designs

Stories

Q's & A's

**Shelter Systems** © 1996 - 2001 All Rights Reserved

[Shelter Systems' Home](#)



[Shelters](#)

[Greenhouses](#)

[What's New?](#)

[Gillis Designs](#)

[Stories](#)

[Q's & A's](#)

# Tent Tech <sup>TM</sup> New Tent Technology Available for Licensing

---

[First Shelter <sup>TM</sup> Tarp Tent Shelter](#)

---

[Diamond Dome <sup>TM</sup>](#)

---

[Hold Fast <sup>TM</sup> Tarp Fastener](#)

---

[Shelter Frame <sup>TM</sup>](#)

---

[Lever Pole Arch <sup>TM</sup>](#)

## ABSTRACT OF THE DISCLOSURE

A segmented, articulated pole member structure is constructed of pivotally interconnected, pole segments. The pole segments are arranged in an offsetting fashion such that in their disassembled state they may be folded into a compact bundle for storage. In the assembled state, adjacent pole segments are retained under tension in fixed angular position relative to each other by a pivoting connection and an engagement loop or similar structure. Applications for the pole member structure include the construction of flexible structures such as tents and shelters, and support frames for mounting, supporting, or suspending articles in a desired shape.



[More about Lever Pole Arch systems](#)

---

## [Tent Loc™ Clip](#)

### **ABSTRACT OF THE DISCLOSURE**

A clip is disclosed for securing an object such as a tent fabric to an elongate support such as a pole or cable in a manner does not slide along the support but that can be easily engaged and disengaged. The clip includes a hook and a cam-shaped clamp that is manually rotated between an open position in which the cam surface of the clamp is retracted sufficiently to allow easy insertion of the pole or cable, and a clamping position in which the cam surface presses the pole or cable against the interior of the hook.



**Slip on, twist the key and ...The Tent Loc Locked On!**

[More about Tent Locs™](#)

## Rope Loc™ and Cable Loc™ Clip for Rope or Cable

### ABSTRACT OF THE DISCLOSURE

A clip is disclosed for securing an object such as a tent fabric to an elongate support such as a pole or cable in a manner does not slide along the support but that can be easily engaged and disengaged. The clip includes a hook and a cam-shaped clamp that is manually rotated between an open position in which the cam surface of the clamp is retracted sufficiently to allow easy insertion of the pole or cable, and a clamping position in which the cam surface presses the pole or cable against the interior of the hook.



**Rope and Cable Locks allow you to attach almost anything to a rope or cable in seconds!**

[More about Rope Loc™ and Cable Locs™](#)

---

## Web Tent™



Shelter System's patent on the Web Tent™ structure has just been allowed by the patent office. Oriented fibers in the white bands stabilizes and strengthens the pole structure.

### ABSTRACT OF THE DISCLOSURE

A Web Ten™ structure is described having one or more deformable, resilient poles and one or more tension webs associated therewith and coupled thereto to maintain the pole(s) in a selected shape under tension and to impart strength and rigidity to the structure. A flexible membrane may also be provided to define a sheltered space. Also disclosed is a method for making such a structure.

What is needed therefor and what has been invented is a flexible structure that exhibits improved rigidity and strength over prior art structures, and that overcomes the foregoing deficiencies associated with the prior art. More particularly, what is needed and what has been invented is a flexible structure comprising at least one deformable resilient pole with a tension web assembly coupled thereto in order to maintain the pole in a selected, e.g., a generally arcuate, shape under tension. The tension web assembly maintains the pole in its desired shape under tension and provides improved rigidity and strength when the structure is subjected to external load forces such as snow, wind, rain, etc. An underlying membrane may be coupled to the tension web assembly to provide a highly stable, rigid, and strong shelter structure, for example a tent.

[More about Web Tents™](#)

---

## [Tent Pole Clip™ and Kite Clips™ Pole Connector for Flexible Structures](#)



Tent pole clips allow you to attach aluminum, fiberglass, graphite, wooden and bamboo poles and wands to tent coverings, fabrics, flags, sails and kites.

### **ABSTRACT OF THE DISCLOSURE**

A connector connects the end segments of one or more poles and a flexible membrane to form a tent, canopy, kite or other flexible shelter or non-shelter structure. The connector has a first and a second body section that are adapted to mate via loosely coupled threads in one adaptation. A portion of a flexible membrane is retained between the two body sections. The first body section has an open end and is adapted to engage an end segment of a pole. The second body section is adapted to be fitted with a ring, hook, or other structure to which a guy wire, rope, or other pole may be connected

[More about Pole Clips™ and Kite Clips™](#)

---

Questions? E-mail us at [shelter@best.com](mailto:shelter@best.com). Please feel free to call or write us anytime. Shelter Systems-OL, 224 Walnut St., Menlo Park, CA 94025. FAX 650-323-1220 Phone 650-323-6202.

Shelters

Greenhouses

What's New?

Gillis Designs

Stories

Q's & A's

Shelter Systems © 1996 - 2001 All Rights Reserved

[Shelter Systems' Home](#)

[Shelters](#)[Greenhouses](#)[What's New?](#)[Gillis Designs](#)[Stories](#)[Q's & A's](#)

## Special Shapes

Many interesting, specialized shapes and structures can be made with the same lightweight, strong, ripstop [material](#) that **Shelter Systems** uses to make our standard domes, tents, yurts, and greenhouses. Some of these shapes have been used in movies, as solar collectors and for other special needs. If you have the need for a special shape, call us; we may be able to make it for you.



**Sphere shape used in movie "Flubber"**

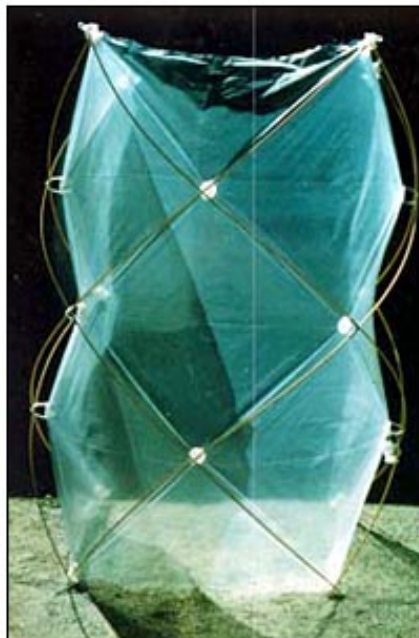

**Tube Shape**





**HexPent Dome Shape (not offered at this time)**  
See our 20' [Yurt Dome™](#) in the [Open Arch™](#) form.



**Full Sphere** made from joining two 10' [BubbleDomes™](#) being used in a recycling program.  
We can make full spheres up to 20' in diameter in white, black, silver or blue.



[ArchedPanels™](#)



[RoofTop™](#)



Also look at [Custom Domes](#), [30' Yurt Domes™](#) and [Half Domes™](#).

Custom Domes, where the covering or shape has been made especially for you, are not returnable.

Questions? E-mail us at [shelter@best.com](mailto:shelter@best.com). Please feel free to call or write us anytime. Shelter Systems-OL, 224 West O'Connor St., Menlo Park, CA 94025. FAX 650-323-1220 Phone 650-323-6202.

[Shelters](#)

[Greenhouses](#)

[What's New?](#)

[Gillis Designs](#)

[Stories](#)

[Q's & A's](#)

Shelter Systems © 1996 - 2001 All Rights Reserved

[Shelter Systems' Home](#)



Shelters

Greenhouses

What's New?

Gillis Designs

Stories

Q's &amp; A's

## Make Your Own Dome Models

### Fold a Tent "

One of the best ways to get an idea of what your Shelter Systems' dome will be like is to make a model of it. A model will allow you to hold and turn the structure in your hands. You will be able to see it in 3D. You can cut out a photo of yourself to scale and "get" inside the dome. Show and share. Models are fun!

A license is granted to the viewer of this page to make the copies of this page that are needed to create two cardboard models of each of the structures below. No other license is either granted or implied.

This Model is easy to make. First, print out four copies of this page on card stock. Then cut them out and, using a ballpoint pen, score the interior lines. Fold and tape (use 3M's Mystic tape on the inside) the interior cuts of each of the four. Last, tape the four assembled units together.

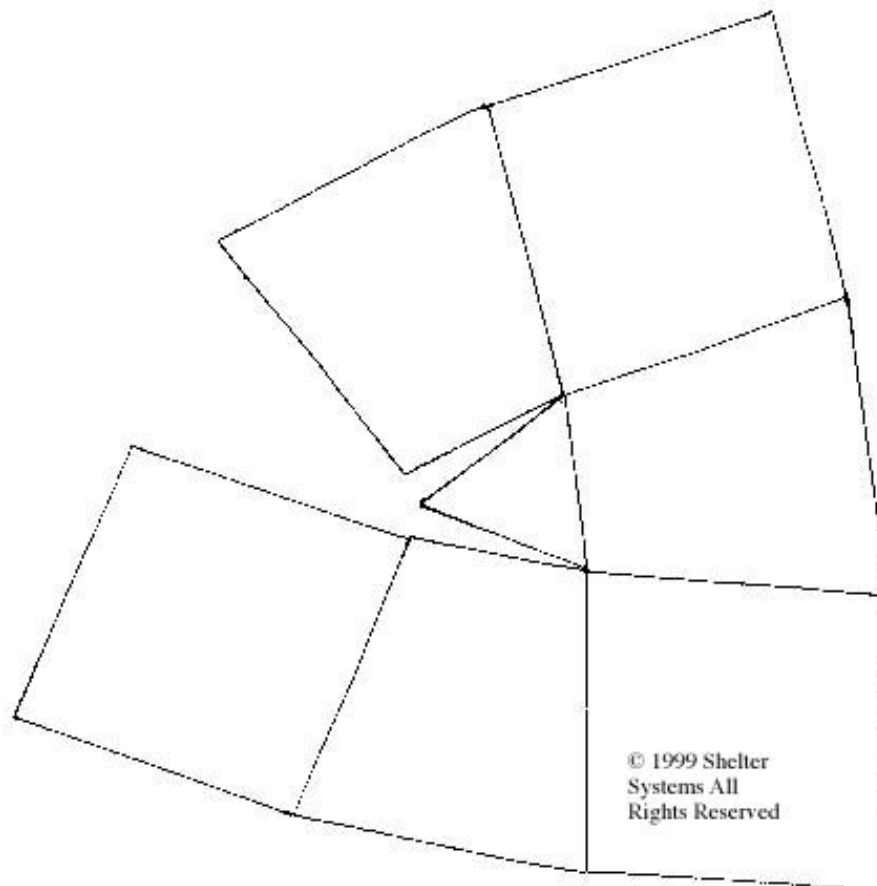

**Pattern for a Model for 14, 18, 20'ers and for all Bubble Domes™**

You can compare two different sized domes more easily by making one model of each dome. You can print the pattern to the scale of two different sized domes by using a scaling program such as Photoshop, a copy machine, or your "Page Setup" before printing. Assembled, these models will help you to appreciate the large increase in volume that occurs when the diameter goes

up in size.



You can remove an arch of panels to get an idea of how your dome will work in its [Arch Dome™](#) form. Make two domes and join them together to create a full sphere. Can you figure out how to make the BubbleDomes?

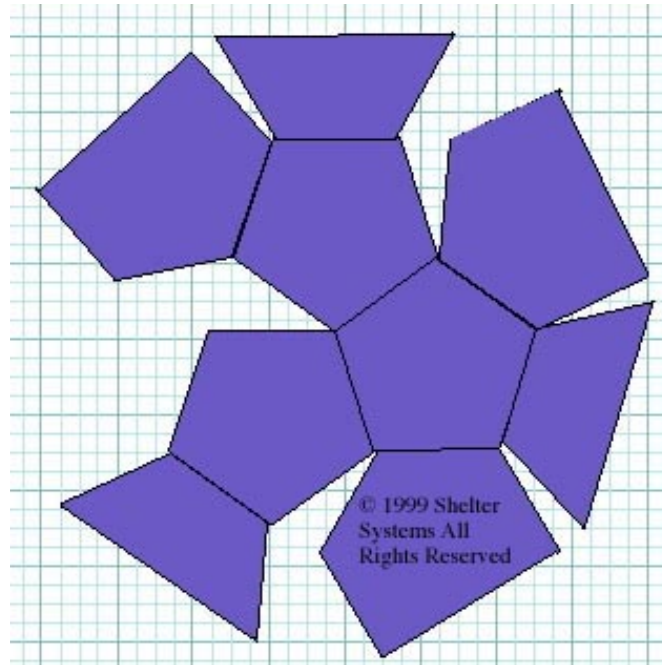

**Pattern for Model of 8 and 11 ' Yurt, Domes™ and Shelters**

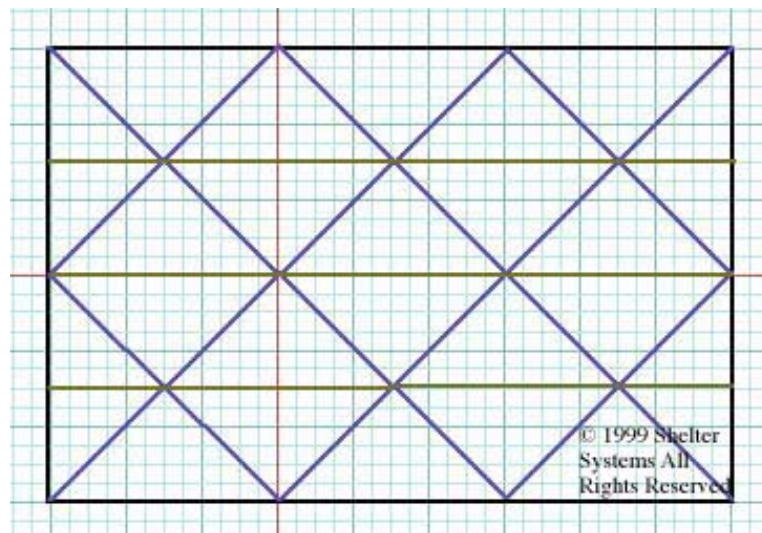

**Pattern for Crystal Cave™ 9 & 11**

Print and cut out pattern. Fold downward on the blue lines and upward on the green. Then bend the model into shape.

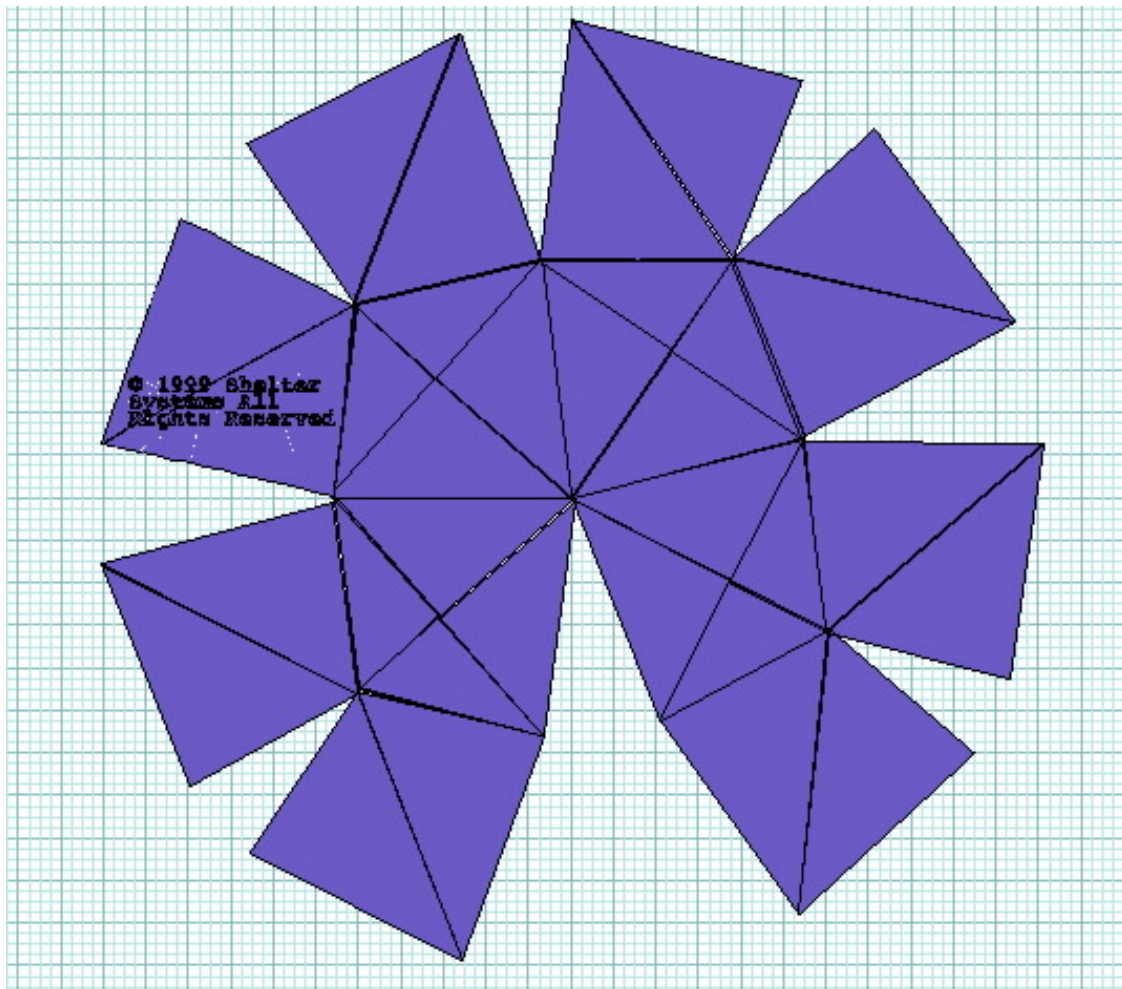

**Origami Dome™ FoldingTent**

This is a model of our Amazing Folding Dome shelter of rigid panels that folds flat when not needed! It can also be made as a [Folding Tent](#) with poles on the edges that folds into a tight bundle. Make one of cardboard. To make the model, print the above on card stock, cut and fold on lines and tape together. See how it folds up. [Origami Tensegrity Dome™ Tent](#).

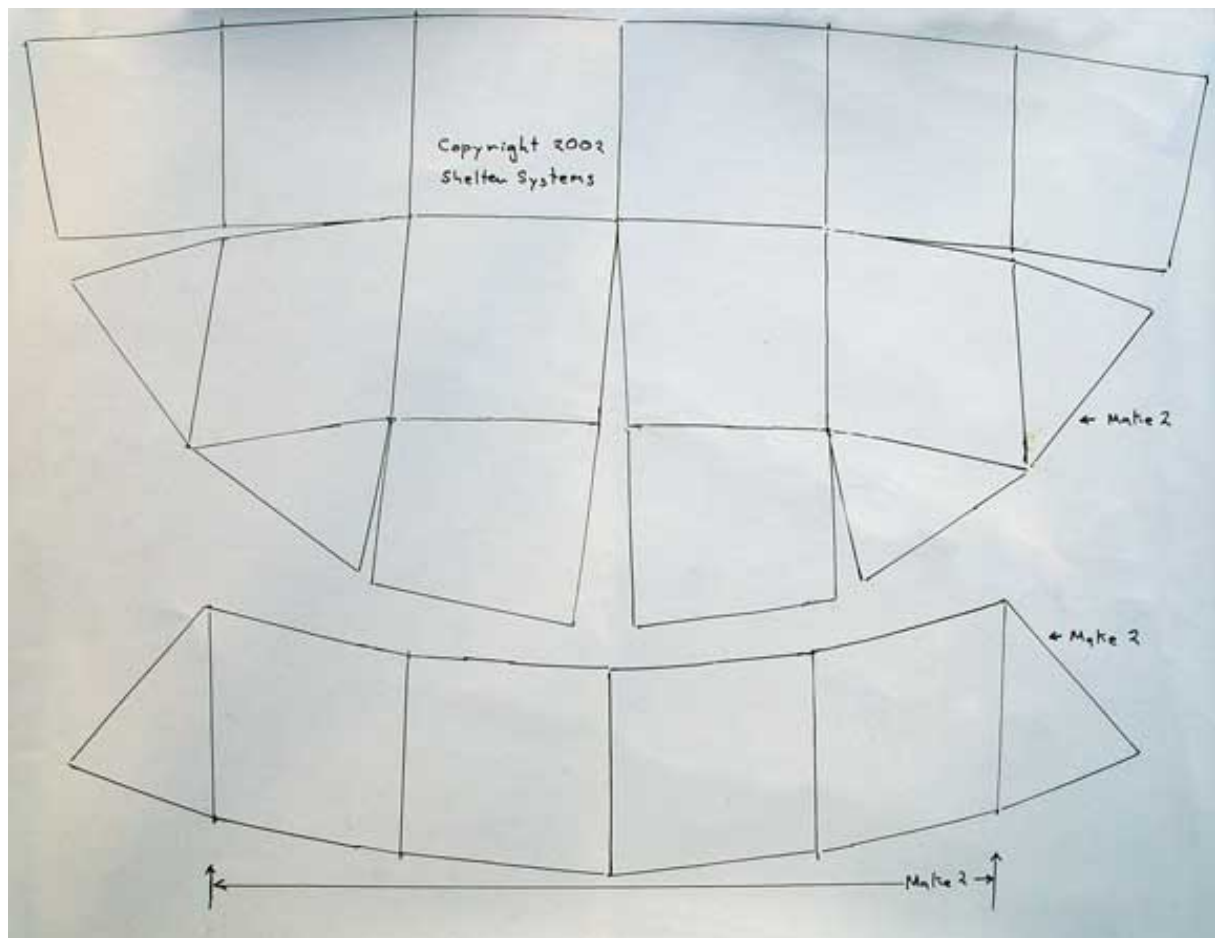

### The 30' Yurt and Dome model

Cut two of each of the three panels shown above. Tape the two larger ones together and then tape the 4 others to form a ring around the first two. The second one shown below shows the top of the yurt and dome set on vertical walls.



Permission is granted to electronically copy, print and make two hard copies of each of the above models, no larger than 1.5' in diameter. No other license is either granted or implied.

Other models: [Kayak model](#).

## Still more [models](#)

Questions? E-mail us at [shelter@best.com](mailto:shelter@best.com). Please feel free to call or write us anytime. Shelter Systems-OL, 224 Walnut St., Menlo Park, CA 94025. FAX 650-323-1220 Phone 650-323-6202.

[Shelters](#)

[Greenhouses](#)

[What's New?](#)

[Gillis Designs](#)

[Stories](#)

[Q's & A's](#)

**Shelter Systems** © 1996 - 2003 All Rights Reserved

[Shelter Systems' Home](#)



Shelters

Greenhouses

What's New?

Gillis Designs

Stories

Q's & A's

## Spheres

### Shelter Systems' Domes as Spheres



**A ten foot sphere used as part of a recycling program.**



**An eight foot sphere uses as a set in the movie Flubber.**

#### **30-DAY RISK-FREE TRIAL 1 1/2-YEAR GUARANTEE**

Our guarantee is simple. **YOU MUST BE SATISFIED!** If for any reason you're not completely pleased with your purchase, return it in original, clean condition within 30 days of receipt for a full refund or exchange as you wish. All items in this catalog have a warranty against defects in materials and workmanship for **1 1/2 years**. Should any product prove defective we will repair or replace it at no cost to you. Special Orders are not returnable. Read [Snow and Wind Warnings](#).

[To order](#). by Fax or Mail.



[Order online with our Secure Order Form!](#)

**For fast credit card orders call 650-323-6202**

Questions? E-mail us at [shelter@best.com](mailto:shelter@best.com). Please feel free to call or write us anytime. Shelter Systems-OL, 224 Walnut St., Menlo Park, CA 94025. FAX 650-323-1220 Phone 650-323-6202.

[Shelters](#)

[Greenhouses](#)

[What's New?](#)

[Gillis Designs](#)

[Stories](#)

[Q's & A's](#)

[Price List](#)

[Shelter Systems' Map of Site](#)

**Shelter Systems** © 1996 - 2001 All Rights Reserved

[Shelter Systems' Home](#)



Shelters

Greenhouses

What's New?

Gillis Designs

Stories

Q's & A's

## Custom Domes, Yurts, and Greenhouses

Shelter Systems will customize its domes, yurts, tents, greenhouses, and other shelters for your special shelter and gardening needs.



**2/3 of a CrystalCave™ used as a shed.**



**A long CrystalCave™ over a pool.**



**Extra large GroRow™.**



**Arched Panels**



We can make [RoofShells](#), [PorchShells](#) or [RoofTops](#) of other sizes as special orders.

If you have the need for a custom shape, call us. We may be able to make it for you.

Custom Domes (where the covering or shape has been custom-made for you) are not returnable.

See also [Special Shapes](#) , [Large Structures](#) and [Half Domes](#).

Questions? E-mail us at [shelter@best.com](mailto:shelter@best.com). Please feel free to call or write us anytime. Shelter Systems-OL, 224 Walnut St.,

Shelters

Greenhouses

What's New?

Gillis Designs

Stories

Q's & A's

**Shelter Systems** © 1996 - 2001 All Rights Reserved

[Shelter Systems' Home](#)



Shelters

Greenhouses

What's New?

Gillis Designs

Stories

Q's &amp; A's

## Tensegrity and Geodesic Yurts™ , Domes, and Tent Structures

Shelter Systems' patented Geotensic™ structures use both tensegrity and geodesic design principles. The advantages of Geotensic™ structures are high strength-to-weight ratio and simplicity that is gained when tensegrity and geodesic construction are combined. (Look at our [History](#) page and also our [Shapes](#) page.) Shelter Systems structures are tensegrity structures because the poles are not attached to each other except by the tension of the covering (ie, the poles would not stand without the covering). They are geodesic structures because the poles follow the shortest line on a sphere. Geotensic™ structures make possible the greatest strength to weight possible in a self supporting shelter.



Robert Gillis was studying tensegrity and geodesics while living in a large suspended tent. It became clear to him that there was a practical way to apply tensegrity to structure. The patented Geotensic™ tent structure above evolved from this insight. This Geotensic™ structure evolved from earlier tensegrity models ([make your own](#)) like those below.

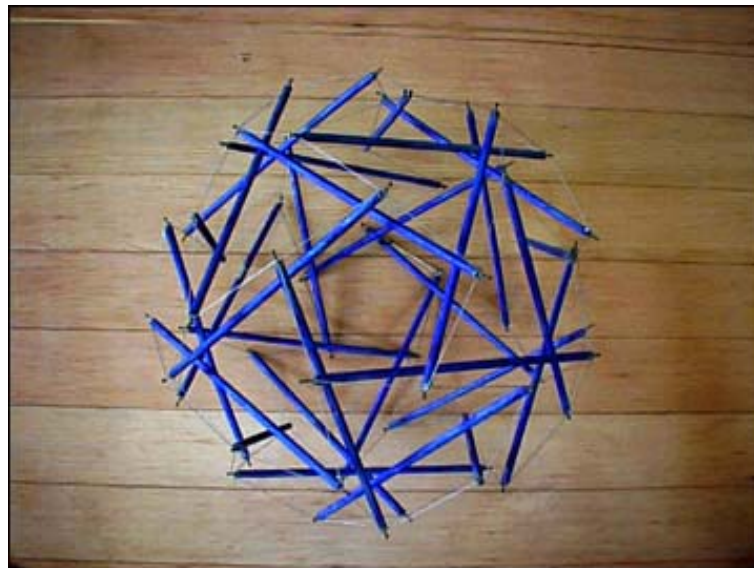

A ziz-zag tensegrity.

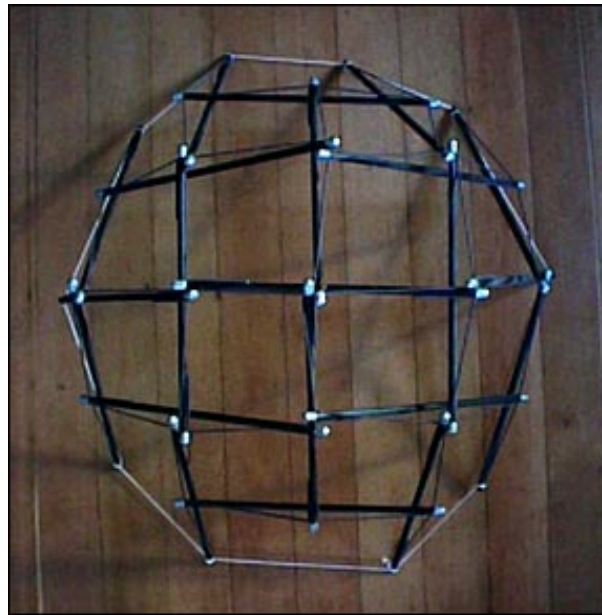

**A basket weave tensegrity.**

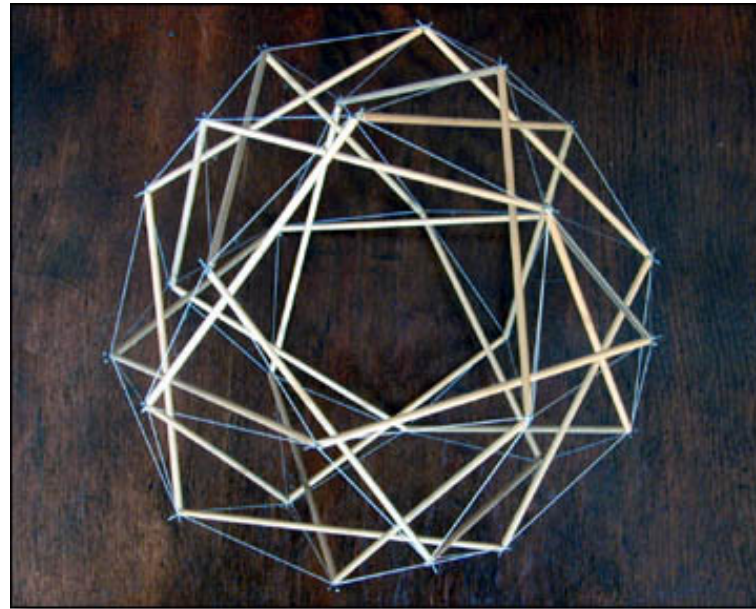

**A basket weave tensegrity model [that you can make](#).**

The tension network was removed from outside of the structure and transferred to the inside where the covering became the tension network. Thus was born Geotensic™ tent structures.



A further simplification was to make the bands of poles bend into an arch by using flexible poles. This greatly simplified earlier tensegrity structures by eliminating all the complicated cords. The covering has predetermined attachment points, serving as a pattern for easy assembly. In this Geotensic™ structure the covering does not make contact with the poles.

Questions? E-mail us at [shelter@best.com](mailto:shelter@best.com). Please feel free to call or write us anytime. Shelter Systems-OL, 224 Walnut St., Menlo Park, CA 94025. FAX 650-323-1220 Phone 650-323-6202.

[Shelters](#)

[Greenhouses](#)

[What's New?](#)

[Gillis Designs](#)

[Stories](#)

[Q's & A's](#)

**Shelter Systems © 1996 - 2001 All Rights Reserved**

[Shelter Systems' Home](#)

[Shelters](#)
[Greenhouses](#)
[What's New?](#)
[Gillis Designs](#)
[Stories](#)
[Q's & A's](#)

# Yurt, Dome and Tent Testimonials and Customer's Photos

More Testimonials at "[Stories](#)" and "[Q's & A's](#)"

August 13 - 04

Last year we bought one of your 14' domes and used it for our chili-cook-off store. It went over real well; we had it painted like the surface of the moon. During the competition we experienced a short Texas summer rain where it dumped over 5 inches of rain in a little over 2 hours. The dome handled the wind and rain superbly and as a result we were one of the few teams that stayed in place and finished the competition. I'm sending you a couple of pictures per your request. Thanks,

Bob...



Re:  
10' Bubble Dome Questions

Date: August 1, 2004

Robert

Thanks for your help on the phone! You had good answers for all my questions/issues...). I have attached a picture of the bubble dome mounted on a backyard deck at my home, which backs up to a golf course. I live in Friendswood, Texas, which is about halfway between Houston and Galveston. This leaves me a decently dark suburban sky for astronomy work. My home-built 17.5" Newtonian telescope now lives under the bubble.

Al Kelly

Al

You mentioned using 8 "d pull rings" (I think you called them this) to hold down the dome to your deck?



Bob,



They are called "flush ring pulls", basically a flush-mounted, flip-up handle, manufactured by National (part no. N203-752). They can be found often in the cabinet hardware section of hardware stores. Sure, you can use the photo

---

August 1, 2004

Robert,

At your request, I am attaching two pic's from the float trip on the Middle Fork of the Salmon. This trip was July 13 to July 20, 2004. Pic 163 was taken at Rock Island camp and 141 was taken at Marble Creek camp with Marble Creek Rapid in the background. We enjoyed the use of the dome as it rained on several occasions on this trip. We spent 8 days, 7 nights on the Middle Fork this trip. We have enjoyed the yurt on the Middle Fork Salmon River and the Grande Ronde River in Oregon. We also used it for a backyard graduation party for our granddaughter.



Dan Hinman

---

On Jul 27, 2004 Subject: Arctic Yurt



Bob Gillis,

Please find attached a couple of photos of the 14' Yurt that we recently purchased from you and used as our base tent for our Arctic exploration program. The tent worked very well in this environment, 20 km south of the Coronation Gulf. Without trees to support any structure, the free standing yurt worked very well for us, even in the strong 40 mph winds we occasionally had.

The only negative to the structure was that it is not completely sealed, so the mosquitoes were a problem inside the tent. Good product, thanks.

Geoffrey Goodall  
Global Geological Services Inc.

Gegffrey

Thanks for the great photos. Would it be alright to put them on our site to share them with others?

For windy and buggy areas like you were in, use sticky back Velcro strips on your doors that we offer on the [Accessory](http://shelter-systems.com/accessories.html) page [shelter-systems.com/accessories.html](http://shelter-systems.com/accessories.html) or you can get locally to hold the doors tightly closed.

I noticed that some of your top poles are bowing outward excessively. This can be corrected if it bothers you by trimming off 1/8" to 1/4" from each pole. The overall effect is to take some tension off the poles; the covering will then not tend to bend them as much. Do not trim off too much. If it does not bother you then don't bother as it will have little effect on the strength of the dome.

Bob Gillis

---

June 23, 2004



Bob,

The tent worked out great!  
We had up to 50 audience members in the tent and it did not feel cramped.

Attached are some photos. Unfortunately, for a series of reasons, we did not get a photo of the show with audience. I'll try, if we remount the show.

Raymond

Cleveland Public Theater

---

Observation of the transit of Venus: Tuesday, June 8, 5:35 AM – 7:30 AM

On June 8, 2004, an extremely rare celestial event will unfold before the eyes of geographically and meteorologically fortunate viewers: the passage of Venus between the Sun and the Earth, causing the fiery methane-enveloped planet to appear as an undulating silhouette with an aqua-green halo, floating upon the face of the Sun. The phenomenon is known as the Transit of Venus and occurred last in 1882.



In order to distill all of the subtle nuances of the Transit, artists Evelina Domnitch and Dmitry Gelfand are creating a Machina Helioscopica, a telescope with a compound lens attached, allowing the telescopic image to be projected on a screen without the use of any recording media or electronic amplification. A coelostat will follow the Sun's trajectory and send its reflected image from a rotating mirror to the telescope.



### June 7, 2004 Studio Yurts and Domes

The yurts that make up Dawntree Studio are approaching their second summer now. Still look good. Still dry and tight. Get a bit warm in the afternoons- so we make sculpture mornings and evenings and do our gardening and nap afternoons.



The lighting is excellent - better than outdoors. At night I bounce the



floods off the skin. The reflection provides a very even, yet bright light to work by.



-Henry Mitchell  
Greenville SC

I made a 20' long, 10' wide, 7.5' tall Quanset Hut, using about 60 of your **Heavy Duty Grip Clips**. It's pretty tight.

The clips work great. Here is a pic, before I installed the door panels.

I am building a second one to tie both together, with a shade structure, and when I place doors I will send another pic.

Mark



Mr. Gillis,

You wanted details (This is sort of a hodge podge of my posts to the backpacker.com forum.):

I made a **silnylon tarp no sewing...just grip clips**. They are adjustable, do not pierce or damage the material and are no slip.

My 5.5 x 11 tarp with grip clips and lines weighs 8 oz, stake (msr groundhogs) add 1-1.5 oz

and NO SEWING

I got my fabric from outdoor wilderness fabrics owf. Mine is white/clear and i can see the stars through it at night, but it is opaque in sunlight

NO SEWING...ADJUSTABLE (Custom) PITCH...EIGHT OZ.s INCL. LINES and STAKES. And mine cost me about 25 bucks.

Take One (1) bolt of silnylon from [www.owfinc.com](http://www.owfinc.com) (2nds at 3-4 bucks a yd, 5.5 ft wide bolt)

And (8) mini gripclips: <http://www.shelter-systems.com/grip-clips.html>



And I use moss (or msr) groundhog stakes.

1. Cut the bolt to desired length...Mine is 5.5 ft by 11 ft (5.5 is again the width of the bolt).

2. Use grip clips to secure lines to stakes and hiking poles or trees. (I also use doubled plastic grocery bags filled with dirt or rocks or buried as cheap, dependable sand and snow anchors. Just attach line to the handles for a solid guy out.) For larger applications, use grip clips to join two lengths together to make a 2 man, 10 ft wide tarp (overlap seam for weather

tightness).

3. And you are tarping. I often set the lines, poles and guys for a 9 foot length and drape the extra two feet down and stake it to shelter the "head" end. Again the grip clips let me secure the head end stake on the draped over material wherever it works best for a taut pitch.

I rig my tarp using a thermolite bivy (20 bucks, 6 oz) as a ground cloth/splash guard. When it gets windy/rainy I open it and

attach to inside roof of tarp w/ grip clips like an inward facing envelope. Keeps me dry in the worst spray.

I have used this system on Lake Superior shore in rain and dry, and dozens of other less weather prone places. Its a lightweight, lazy man's, cheap cheap CHEAP way to go.

Grip clips from [www.sheltersystems.com](http://www.sheltersystems.com) mean no sewing and perfect taut pitches no matter how poorly placed your anchors or guy points. The work anywhere on the fabric, making a non destructive, non slip guy point. I set the guy points FIRST, THEN I adjust the grip clips to fit, and taut line hitches on each grip clip make a tight pitch in almost any situation. (Bonus: the INSIDE on each clip is good hang point for clothesline, loft, or flashlight.)

P.S. 1.1 oz silnylon with the grip clips requires childrens party balloons (\$1.00 for 20) as "gaskets". Cut off head (dome) of balloon and insert between grip clip head and cloth. TOTALLY prevents slippage on the slick cloth.

---

Mister Gillis, the grip clips make my tarp work all the time, no matter how bad the guy out options. They also are best for extra guys on my other tents and my Batray when i need to batten down. Thanks for a great product.

Yours,  
Tiger Shah

On Mar 19, 2004, at 11:09 AM, Tiger wrote:

You have the best product out there for joining lines to fabric, and fabric to fabric, thats out there... I will try to find some pics.

Must tell you though, its just a sheet of silnylon, and does not LOOK especially impressive, with my junk all spread out under the tarp.

:)

---

Hi Robert. Some of these photos were sent to us from the gallery which sponsored the show. **Cathy's piece** is in several of the shots. I will get back to you regarding the use of the photos once I talk to the photographer. We are driving down this weekend (800 miles) to dismantle the piece and bring it home. I will attempt to answer some of your questions. The ICE FOLLIES was a curated art exhibit in which 7 artists from Ontario were invited to create their personal conception of ice fishing. The event received wide media attention including national radio and television coverage as well as a special on Canada's version of PBS. On opening day, hundreds of people ventured out onto the lake to partake of the adventure. And it was an adventure considering the fact that the day before, nearly three inches of rain fell and the frozen lake turned to pure slush. Cathy's piece used, of course, your bubble dome as the basic skeletal structure. She covered the dome with a variety of fabrics including, dyed cheese cloth, bubble wrap, synthetic sausage casings, and various linens. The one interior shot shows some of the workings of the fabric but it doesn't tell the whole story since the art works were by consensus, works in progress and a touring international show is being seriously considered. The fish seen in some of the photos are plasma cut aluminum, rolled and spot welded, creating a dramatic and majestic effect.



Cathy didn't cut an opening in the roof (not yet). Her intent to use underwater cameras and sculptural pieces was in part thwarted by the weather, difficulties in providing electricity to such a remote location, and of course security concerns. The option is still open in the future. We are considering bringing some form of the piece with us when we travel to Newfoundland this summer for an artist's residency. I will send further photos and hopefully permission to use them as you see fit once I get permission. Any of my photos are at your disposal. (The first two sets which I sent were taken by me but the outcome was somewhat disappointing because it was such a

dismal day.) Will write again once we return. Zen.

Once we get to Lake Nipissing we will be able to offer a more effective testimonial regarding the practicality and (hopefully) durability of the dome. The particular area is part of a wind and snow belt so the structure certainly was put through many trials.

From what we have been told, it has survived unscathed. I did tie it down at 32 different locations, so that must have helped. In any case, I will contact you upon our return and will send additional photos. Bye for now. Zen.

Dr. John Arnone in **Desert Research Institute** in Nevada built such a chamber by modifying your yurt (picture attached).

"The chamber is a modified version of a commercially available 4.2 m diameter dome-shaped yurt tent manufactured by Shelter Systems Inc. (Menlo Park, CA, USA; Fig. 1a). After modifications (see below) the dome covered an inside ground area of 12.25 m<sup>2</sup>, with a height of 2.0 m, a volume of 16.4 m<sup>3</sup>, and a weight of 30 kg. The semi-transparent (moderately translucent:

<http://shelter-systems.com/dome-coverings.html>)

woven ripstop polyethylene (PE) skin of the dome is held taut by nylon grip clips that are attached at 15 points to an external frame constructed of 3 cm diameter (OD) PVC pipe. The dome skin is actually made of eight large individual pieces of PE that create a shingled effect, with upper panels overlapping lower panels by about 10 cm. Because of the tautness of the skin, there are no apparent gaps between upper and lower shingles. However, we glued the upper and lower shingles together with silicon cement. The frame is made up of a total of 48 individual tent tubes (twelve 65 cm tubes and thirty-six 107 cm tubes) which enable the dome to be dismantled like a camping tent and stored in two duffel bags; one for the tubes and one for the skin.

We have modified the dome in several ways. We constructed and added a 12-sided tubular base made of twelve 98 cm long×6.5 cm diameter schedule 40 PVC irrigation pipe joined together with twelve 7.6-cm-diameter PVC pipe angles. We drilled one 3 cm diameter vertical hole in each base joint to each receive one of the 12 vertical PVC tent poles that would otherwise be staked to the ground if the dome were used as a shelter. We also shortened these 12 bottommost

vertical tent poles by 10 cm to ensure that a sufficient length of PE skin material remained along the bottom perimeter of the dome to be wrapped three-quarters of the way around the PVC base tube (Fig. 1) when the vertical tubes are in place inside the 12 holes. To attach the bottom of the PE skin to the PVC base, and to anchor the vertical tubes in the base, we used adhesive-backed Velcro strips with one side of the Velcro attached to the PE film and the other to the PVC base tube."

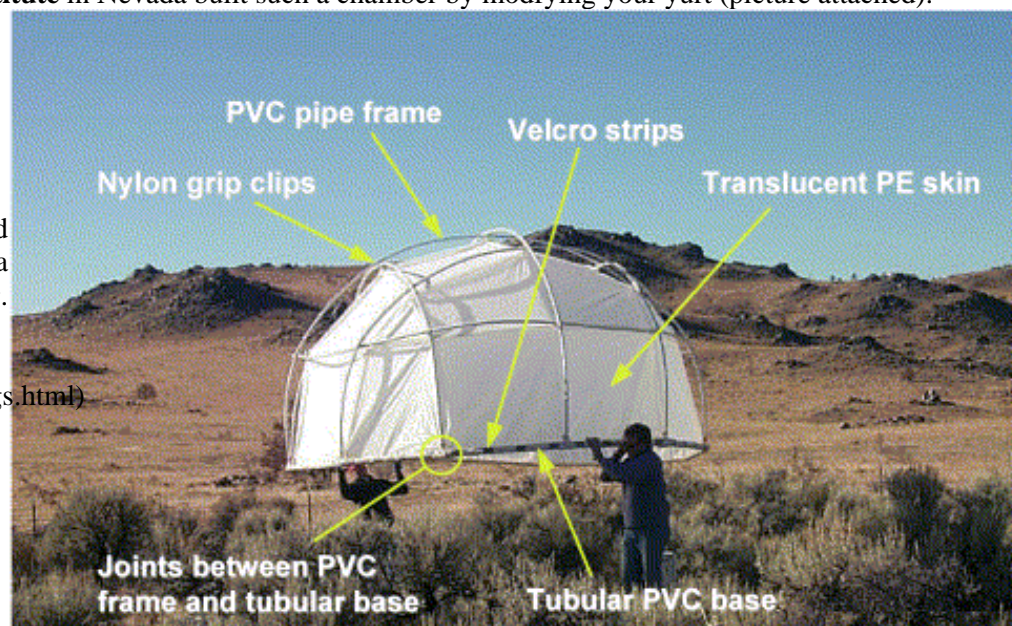

(a)

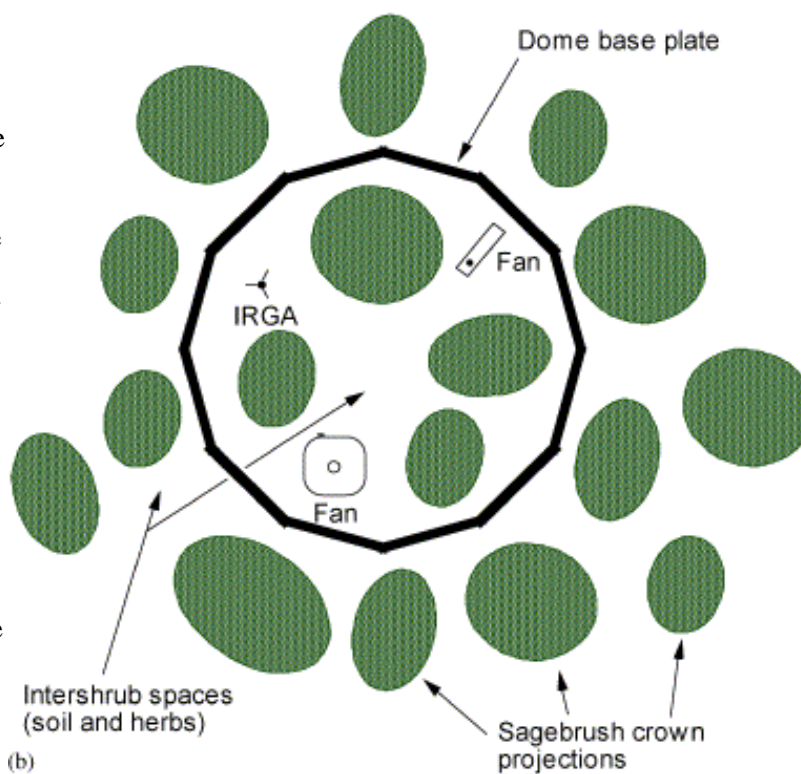

(b)

Dear Shelter Systems,

We purchased your 14' dome to use as a **main base camp tent** in a research expedition to Breidamerkurjokull Glacier, Iceland. Despite strong North Atlantic winds, the tent proved sturdy and reliable. We will be taking it on our second expedition there this

spring.



I've included some pics from Iceland you may want to use on your site.

Ian

<<...>> <<...>> <<...>> <<...>>

Ian Howat

Dept. of Earth Sciences

---



Hey -

I laid down a few tarps for the floor which have made a big difference with the bugs. We had just mowed the grass when I first put it down, which I think is what caused the bug issues to begin with. Getting lots of comments from folks here who see the dome... everyone really likes it. I plan on keeping it up until late October or so (when it starts getting cold and nasty up here), then take it down for the winter. This place is pretty dark and grey in the winter, so I would not plan on spending much time up here anyway. Pretty easy to store away for the winter in the garage, then bring back out again in next Spring.

I will be picking up a bed netting to resolve the mosquito issue. They are not too bad, but a bit annoying when you are trying to sleep. Will get the basic type of bug netting that fits over a bed.... that should fix that. I would like to get the floor option you sell ... the tarps work ok, but it would be nice to do it right and not have any seams with the ducktape - as I have used several smaller tarps and taped them together.

Jorma, Washington State

A rug would also work to cover the tape seam that joins your taprs.

---

**We have enjoyed the shelter of your 30' yurt over our excavation site for 5 months now, and are very pleased with it. It casts**

a perfect, flat light for excavation and photography, and saves us the headaches of covering and recovering the excavation on a daily basis.



We have had some problems in severe weather, when strong, sustained winds were combined with heavy rain. The wind yanked at the plastic guy stakes, which were allowed movement by the rain saturated ground, and snapped off below ground level. That caused loss of tension on the dome, and rain puddled in some of the panels, causing the top of the dome to collapse inward. Several of the connectors broke out on the ends where the cords tie, One near the top of the dome. We made a temporary repair by poking holes in the fabric and passing a cord through them to pull it snug to the connector, but that is about to rip out. These problems are not unanticipated, and are consistent with your warnings about weather conditions etc. It's a large dome that can catch the wind like a big sail, and we're using it in an unprotected location. I've actually been amazed at how well it has stood up against the wind, which have on occasion exceeded 50 mph for sustained periods. It takes vigilance, of course, and constant attention to venting and guy ropes, to allow wind to pass through instead of just piling and bellying against it, and to control airfoil.



We will be taking the shelter down within the next two weeks for maintenance and storage over the winter (we're at 6000 feet, and get more snow than I want to subject the yurt to). I have just submitted an order for some parts needed for maintenance, including two sets of the clips. I also requested a length of that incredible cordage, which I cannot come close to matching in the local hardware store, but which is not listed on your order form. Please let me know what the total will be before shipping.

A question: pieces of the covering fabric are very strongly bonded together in some places. Is that done with a glue, or with heat? We have some minor rifts in some of the panels that need to be mended. Is there a glue or a technique that you can recommend, as to how to go about that? And a related question: what is that incredible fabric? That stuff is truly amazing.



I will attach a photo or two for your collection.

Thanks.

Winston Hurst

Dear Winston Hurst

Sounds like you put the Yurt to the test and I am glad to hear it worked well for you.

Not sure what you mean in your question about the fabric being "bonded" as there is no heat welding or glue used. All the panles are cut and then Grip Clipped together. If you need to make small patches or repairs use 100% silicon glue. For patches just cut a piece from the packing cover or the skirt of your Yurt.

The Shelter Systems' Covering we use is made of a woven multi laninate film and I agree is truly amazing stuff.

Thanks for the photos of your use of the Yurt.

Bob Gillis

---



**Sculpture studio** } night and day.

---



Customer Photo

---

I tried my new 20 foot dome this weekend. It can be backpacked in 3 loads. I simply duct tape the dome package to an old backpack frame. The instructions were a little hard to follow, but I can excuse that since the **dome was totally leakproof in 8 hours of rain**. The way the floor is oversized keeps it bone dry even with water running under it! I also like the way the shape of the dome tends to hold it down in the wind. Those windows are really really neat too. It is ingenious how the panels all overlap and seal tightly when stressed by the PVC. I know it sounds crazy to use a 20 foot dome for backpacking by myself but I love it. It is like being inside a house. Congratulations on a great product and thanks!

Bill NC

---

Attached are a couple of photos of the Hyde Park **Archaeological Excavations Shelters** as promised.

Dirk Marcucci, RPA



Photo of 30'dome used in a **Sierra Mist commercial**

### Animal Shelter

Bob,

As I mentioned, this was taken last winter. In addition to the baby in the doorway, there are two more alpacas and 10 bales of hay and supplies inside. 18 feet seems to be a perfect fit for 4 alpacas, in case anyone wants to know.

Will send a picture I took of all three domes. Nice talking with you.

K



---

### Burning Man

Dear Shelter-Systems,

I recently purchased a 30 foot Yurt dome from you to take to Burning Man 2001. I am writing to tell you how much I



enjoyed the dome and what

a great job it did. We attached some PVC and lights to make the dome look like a big face with spikey hair(it is actually a boognish, the logo for the band Ween). We were so pleased with it and everyone told us how happy it looked. I just want to thank you for making such a wonderful product. Here is a link to our website with pictures of the dome and our wedding in the dome (just married Sept. 2, 2001, BM'01 Temple of Boognish)! Feel free to post the night picture on your website if you want. The boognish looked great from far away!

Once again we thank you for your business.

Sincerely,

Justin and Sarah McCaleb (was Sarah Mims when I purchased it!)

---

### Burning Man

Bob -

The following are some fun pictures using your dome camping at Pismo Beach. We had a lot of fun. The dome really saved what would have otherwise been a disastrous trip. And the funny part is that neither of us had ever put one up before - and in the wind no less - and I had just received my dome 2 days earlier.

The trip was supposed to be a "test run" for the dome. I'd say it passed with flying colors. One of our campers, Chris Hennes, was so impressed that he just ordered another 20 footer from you for his Burning Man installation.

Andrew Michalik



Dear Shelter Systems

Here are some photos of the Tarp Shelter we created using your **Grip Clips**.

Rich



The Grip Clip worked great to hang a light from the center of the tarp



As you can see the shelter we created was quite large. Thanks for the great tarp fasteners.

---

### Life in Yurt Domes

Bob, We completed 3 1/2 months in the Yurt you supplied us.

We solved the heat problem with a kerosene heater (the quiet kind) which also gave us a good night light. The yurt looked like a glowing dome in the dark. We kept two vents open the whole winter. Temperatures in the 20's to the warm 60's were encountered.

We never had to worry about leaks, even in somewhat windy conditions, from rain or snow (we were snowed in one day).

The airiness of the structure made it very comfortable. We had some regrets when we moved into our house, which is so air tight that my wife, especially, always keeps the doors open "TO GET MORE AIR".

My wife and I were Camp Hosts for 3 months. I commuted to Boeing and helped her with the state park duties in the evening.

Our children

13, 10, 7, 6 years studied math, reading, science, biology, and for physical fitness and fun they hiked and observed nature from the sea shore to the forest hideaway.

Camano Island State Park and South Whidbey Island State Park were wonderful places to observe the day to day changes of nature, season and weather from. We are even more aware of the necessity of preserved areas now that we have lived in them for a short time.

The people who do the day to day work of preserving deserve our respect and support.

We are using the yurt for a temporary storage area while I build the various cabinets and book shelves needed in our new house.

Thanks again for a structure that allowed us to be successful

Harley and Vicki Clark  
w/ Sophia, Gabriel, Michael and Nicholas

---

### **Love Dome**

Hi Shelter Systems,

We have a 18' yurt dome --- (Bev Feldman, La Canada, CA) -- we've turned it into a outdoor sleeping room on these hot Southern California summer nights. We've decorated it quite wonderfully (if I say so myself --- "The Mists of Avalon" meets "Cirque du soleil".) Last week we were interviewed by TIME magazine on un-spoiling the kids of the 90's, and there was a big photo shoot at our place (we are involved in voluntary simplicity and have a visually interesting place). The photographer just LOVED the dome and what we had done with it, and so it was used in a couple of the shots. This piece was supposed to be a story and run this week, but the NYC types liked it so much they're running it as a cover story sometime over the summer. So you might want to keep your eye open for that story and see if you lucked out with the dome getting some free international PR...

I'm also writing a story to be submitted to the LA TIMES about our experiences of turning the yurt into something magical and taking refuge from the heat. If that goes, I'll point you to it.

Needless to say, we really love our dome.

Bev Feldman  
La Canada, CA

---

### **Archaeology Shelters**



ARCHAEOLOGY RESEARCH& HISTORIC PRESERVATION

June 21, 2001

Dear Shelter Systems :

As per your request, I am sending you a photo of your shelters in use by CHRS, Inc. The 30 foot dome is in the foreground and the 20 foot dome is in the back to the left. We are currently using them during our archaeological excavations in Monroe County, Pennsylvania and look forward to using them for years to come.

Take Care,

Christina Civello Lab Director CHRS, Inc.Hi!

---

### **"Comments" Burning Man**

Dear Shelter Systems,

I was thinking about **Burning Man 2001** planning today and visited your web site to see what was new. Andy Nourse and I were glad to see that you had gone out to check how Shelter Systems domes did on the playa in 2000 -- and glad to see our own (DSCN0495.jpg) among those you photographed.

Our Shelter Systems dome did well. For the first few days it was pegged only at the base by a ring of foot-long steel stakes. The reflective shade tarp kept the dome comfortable and we put short lengths of plastic pipe between the fabric panels to increase air flow.

One morning Radio Free Burning Man warned that 70mph gusts were expected in the afternoon. We decided to stay close to camp just in case. As the wind picked, we recalled we hadn't guyed the dome down per the instructions. Andy quickly drove several three-foot rebar in the ground, guyed the dome and came back inside.

It was awesome and a little nerve-wracking. But the dome did not flap itself to bits nor did the PVC fold. After a while the wind diminished.

Emerging from our dome, we were even more startled. A few other tents and shade structures in the vicinity had collapsed, flattened or simply vanished. In the distance we could see a metal-frame geodesic structure that had buckled.

Anyway, your 20-foot dome passed the Playa Test in 2000.

Cheers,

Patty A. Hardy

**Note:** that this structure uses a woven porous greenhouse sunshade cover the pores let out the heat, Not, a sheet of black plastic which would cause the poles to over heat and bend out of shape.

Dear Patty

Thanks for the great report. We also were impressed with how well the domes did.

There are real dangers involved with these high winds and we all should take all precautions needed to avoid harm including taking the dome down before the winds get too strong and or getting into a vehicle to weather the storm safely.

Hope to see you on the Playa this year.

Bob Gillis

Understood. At some point it's definitely the better part of valour to take down the dome, guy down down the 4WD and climb in...

See you on the Playa.

Patty A. Hardy

---

### "Comments" Life in Yurts

It was over 5 years ago when Gordon brought the dome into our yard. The wind once blew it over the fence. We put it under the tree to secure it. A never ending parade of people stayed in it. We never had a night when some one was not in it. The tree protected it from the sun. One time a yoga stayed in it and he said there was too much sexual energy in it. Lots of couples stayed in. We had another dome for a while. We used it for a meditation dome. The one dome we used for people who would come through and then leave. The other we use to put people up for extended periods of time. The domes have been used a lot. We let people use the dome when they had no other place. One woman wrote us a letter to us to tell us about how beautiful it was living in the dome. It helped a



lot of people over the years. The dome now is used as a permanent residence. Here is a photo of me in front of it.

Nath



---

### 10 Year Old Shelter Systems' Greenhouse

Good Morning,

I purchased a greenhouse from your company more than 10 years ago. The greenhouse is still being used and the plastic covering is still good. I have an eight foot diameter greenhouse. I think it was the middle of 2 or 4 sizes that you had at the time. I am interested in purchasing the same size or the next size larger. I never thought it would last so long and work so well, and the best part is that I can put it together myself. I usually take the greenhouse down at the end of June and sometimes put it back up in the fall and use it again till December. Thanks for a great product!

Sincerely, Caron Chapman

---

### "Comments" Yurt Dome Use in HI

Dear Bob,

Aloha from Maui!

Maxiii P~~ lay Lt&  
Honolua Division

As the manager of an 8,661 acre watershed/wilderness preserve, my field crew and I regularly spend 2-3 days a week throughout the year in remote camps that require tough and reliable equipment that can survive near-constant use in a subtropical environment. Over the years, we have refined our equipment list, but we still keep an eye out for quality gear that can improve our work conditions in the field,

Since November of 1990, we have been relying upon two of your Shelter Systems domes (18' & 14') to keep us and our gear dry during our regular, overnight+ field trips in the rugged, West Maui Mountains. Set-up with just two people is a breeze in all but the worst winds. Ventilation is great and the headroom (all three of us around Cor so) has your competition (what competition?) beat "headsdown." I'll never go back to those cramped, hot, aluminum-poled, geodesic domes again!

Not even the U.S. Army approved (your tax dollars hard at work!) \$1900 MOBIFLEX dome (seen blowing away in the desert in the movie, STAR GATE) could handle the extreme wind and rain conditions that your Shelter Systems Lighthouse domes have readily withstood.

Please feel free to use the enclosed shots of your Shelter Systems' domes in action as you see fit.

Mahalo (Thank You) from Maui,

Randy Bartlett

---

### Warming Hut

Dear Mark

Thank you for the details on your experiences with our dome. It may inspire others. You can tie off your clothesline to the holes inside the clips as this would provide an hold fast with out going through the flaps. I was wondering if you might send us a photo that we could include with your commits?

A few notes about our geo dome. Red Top Meadows is a school / treatment center for emotionally /behaviorally challenged teenage boys. We bought the



geo dome with the idea of having a semi portable **warming hut** for our winter wilderness camping program. The idea was to have a structure that could be set up on snow, with a roll out astro turf floor and install an outfitters stove. The entire unit could be broken down and transported with snowmobiles pulling haul sleds. This satisfied our need for portable as well as the forest services need to minimize our impact by setting up on snow and not establishing a camp. This was an experiment of sorts. I had done a fair amount of research for shelters and this was the lightest, cheapest, most portable and aesthetically pleasing thing I found. Strength was the question mark. Our program is located at close to 7000 ft in the Snake River Mountains of western Wyoming. We usually have over 400 inches of snow fall each year and it is not unusual for temps to go well below 0 . The dome past its first tests but we learned nothing the easy way. Here is a few notes that may help the next who try what we are trying. First off it needed a name. We took one look at it and everyone thought we would start with the Hindinburg because it looked like it would sail in a big wind and go up in flames. both were wrong but the name stuck.

-- We set it up in the yard for a week to watch it and see how it handled the elements. I got the call one morning saying the burg had collapsed. This was after it had accumulated 5-7 inches of wet heavy snow. One staff got in the middle, shoveled off the fabric, popped a few poles back in place and the burg self inflated so to speak (popped back up). Damage was one broken pole and one damaged hub.

-- If the dome is cold shaking lightly and gentle poking from inside will shed most snow easily. shake at the window triangles works best.

-- We used 10" square plywood with perlon rope to make deadmans for anchoring in the snow. One for each pvc touching the ground.

-- We bought used astro turf for 60cents a sq. ft from a company in Texas and cut it to fit then cut it again for hauling. Heavy but it worked. Were looking into other alternatives.

-- Putting the stove pipe through the door works but the door is 62"x 62" so one piece of plywood does not do it. We used a piece 48" x 62" and then rolled down the door flap and tied it off. We then used a piece of fire wrap insulation to protect the pvc and the door fabric doing a drape and weave kinda thing. Worked well.

-- We had an elbow out of the stove then a straight section inside and another straight piece outside, then an elbow going up. We stabilized the unit by sinking a ten foot piece of conduit into the snow pack and using hose clamps ( get the size right first) and bailing wire to secure it. The mesh spark arrestor needs cleaning every two days or get a dunce cap style top to the stove pipe.

-- The area around the stove needs to be insulated or else the snow will melt out and the stove will drop, screwing up all your rigging.

-- The dome heats up quickly to be very warm and cools down even faster when the stove goes out. condensation was pretty heavy and froze on the inside wall but knocked off and dried out quickly in the morning sun.

-- We used parachute cord for clothes line for drying socks etc... We reached through the fabric flaps and tied it off to the hubs. This seemed most secure.

-- The doors were hard to keep sealed even with bigger clamps once the fabric was cold and iced up a bit the clamps just want to pumpkin seed off.

-- The dome did well in some pretty good stiff wind gusts and held 3-4



inches of light snow with out a problem. If the dome collapses the legs are what take the weight. We are going to try 450 psi / pvc pipe for the leg sections.

-- The material is incredibly strong. We tested a scrap piece with a hole in it. We could not get it to tear any further and we tried. I also tried burning it to see what would happen. It melts but does not burn.

-- Replacing a hub was easy. I'm not looking forward to a grip clip replacement. Should practice before its necessary. The local hardware store had all the PVC I needed but none in the lighter 200 psi stock. Also, 10 footers come with a flared end so there is some waste when it comes to cutting spare parts

-- Were looking forward to what we can use the Hindinburg for next. It is a beautiful structure that gives off good vibes. Hope these notes help some one -- Cheers -- Mark Ames -- Red Top

---

## "Comments"

Bob,

Here is an image as we walk it to its place in the snow. We set it up where it was warm and then carried it one mile. Andre



---

## "Comments"

Just wanted to let you know that we purchased two of your domes to use as dining tents on our treks in Bhutan. They were a HUGE hit with our clients and our local trek staff as well. The trekkers came to call the 20' dome the "Taj Mahal" and enjoyed luxuriating in the roomy interior. We did have one gusty day that lifted the dome off the ground (our staff hadn't tied the guy lines tightly enough) but other than that, they held up extremely well. If you are interested in any photos, we hope to have some up on our site in the next few weeks. Look at our site and go to the Bhutan section (go to Asia first, then to Bhutan). All the best! Brent Olson Geographic Expeditions

Henderson

### **30-DAY RISK-FREE TRIAL 1 1/2-YEAR GUARANTEE**

Our guarantee is simple. **YOU MUST BE SATISFIED!** If for any reason you're not completely pleased with your purchase, return it in original, clean condition within 30 days of receipt for a full refund or exchange as you wish. All items in this catalog have a warranty against defects in materials and workmanship for **1 1/2 years**. Should any product prove defective we will repair or replace it at no cost to you. Special Orders are not returnable. Read [Snow and Wind Warnings](#).

[To order](#) by Fax or Mail.

[Order online with our Secure Order Form!](#)

**For fast credit card orders call 650-323-6202**

Questions? E-mail us at [shelter@best.com](mailto:shelter@best.com). Please feel free to call or write us anytime. Shelter Systems-OL, 224 Walnut St., Menlo Park, CA 94025. FAX 650-323-1220 Phone 650-323-6202.

[Shelters](#)

[Greenhouses](#)

[What's New?](#)

[Gillis Designs](#)

[Stories](#)

[Q's & A's](#)

[Price List](#)

[Shelter Systems' Map of Site](#)

**Shelter Systems** © 1996 - 2003 All Rights Reserved

[Shelter Systems' Home](#)



Shelters

Greenhouses

What's New?

Gillis Designs

Stories

Q's & A's

## A Picture History of Shelter Systems

This photo history of Shelter Systems' early tent and dome structures includes "The Oval Intention" designed by Robert Gillis, [tensegrity](#) domes, and greenhouses.



An early Shelter Systems' Tensegrity Dome



The first Oval Intention by Robert Gillis, later to be made by [The North Face](#). This structure started the geodesic backpacking tent revolution.



**Earlier dome being used as a warming hut.**



**Lineup of earlier Shelter Systems Tents.**



**Hex Pent Dome Shape. (Not offered at this time.  
See our 20' [Solar Dome](#) in the [Arch Dome](#) form.)**



**Lighter-than-air dome.**



**An early 30'-diameter dome structure.**



**An early greenhouse.**

Questions? E-mail us at [shelter@best.com](mailto:shelter@best.com). Please feel free to call or write us anytime. Shelter Systems-OL, 224 Walnut St., Menlo Park, CA 94025. FAX 650-323-1220 Phone 650-323-6202.

Shelters

Greenhouses

What's New?

Gillis Designs

Stories

Q's & A's

[Shelter Systems' Home](#)



Shelters

Greenhouses

What's New?

Gillis Designs

Stories

Q's & A's

## Shelter Systems in Film and TV!

Shelter Systems' domes, yurts and tents have been used during the filming of and on the set of television shows and movies.

---

### The TV show 24 used our 30' Yurt, Dome in one of their set



### Shelter System's domes were used in a Star Trek episode:



## From the set of "Earth 2"



From the set of "Earth 2" with Solar-Dome 18 and Solar-Dome 20.



"Earth 2" with 18' Solar Dome in background.



"Earth 2" with Solar Dome 8 and 20.





**Cast of "Earth 2."**



**"Earth 2" set with domes.**



**Shooting "Earth 2"**

## Flubber



Dome used in Walt Disney's "Flubber" starring Robin Williams.

---

## Contact

Shelter Systems' domes were also used in Warner Brothers' "Contact" starring Jodi Foster.



"Earth: Final Conflict"



Questions? E-mail us at [shelter@best.com](mailto:shelter@best.com). Please feel free to call or write us anytime. Shelter Systems-OL, 224 Walnut St., Menlo Park, CA 94025. FAX 650-323-1220 Phone 650-323-6202.

Shelters

Greenhouses

What's New?

Gillis Designs

Stories

Q's & A's

**Shelter Systems** © 1996 - 2003 All Rights Reserved

[Shelter Systems' Home](#)



Shelters

Greenhouses

What's New?

Gillis Designs

Stories

Q's & A's

## Drawings of Shelter Systems' Domes

Here are some drawings of Shelter Systems' domes from the 1970s and 1980s.

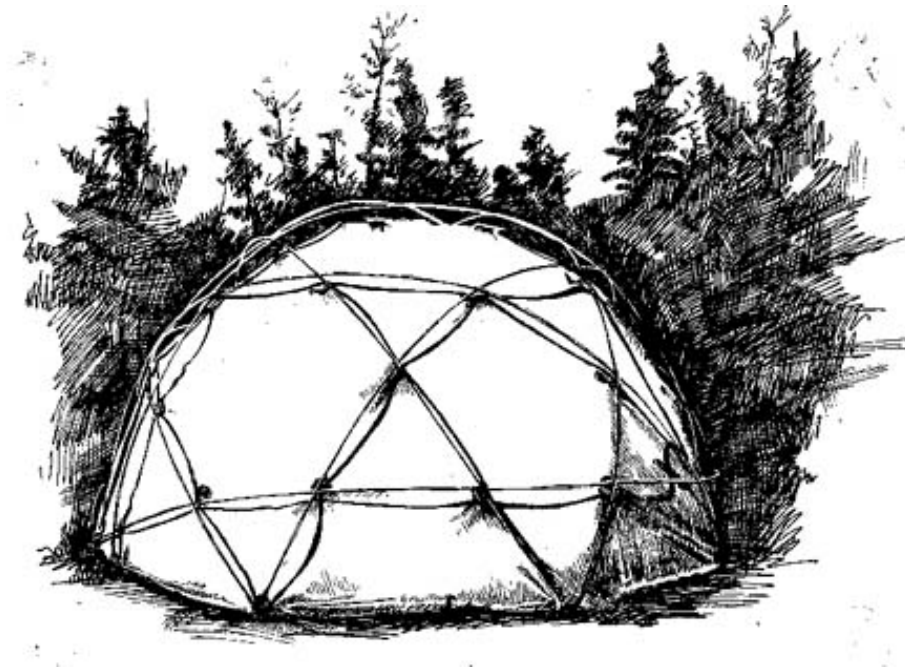
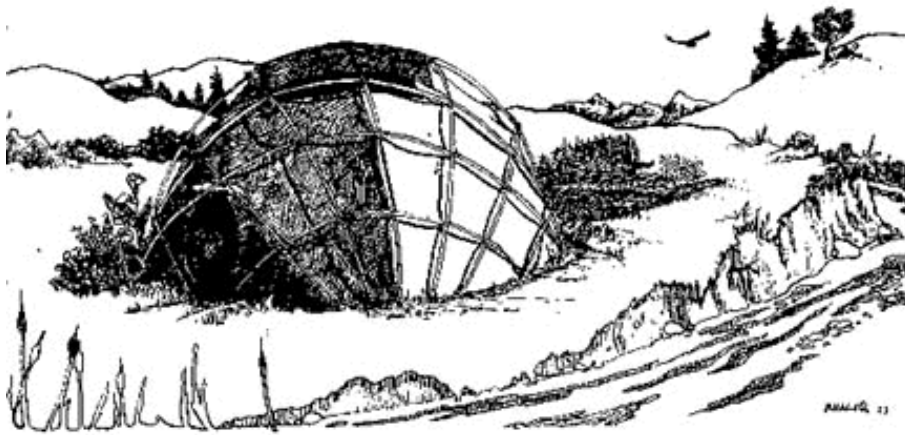

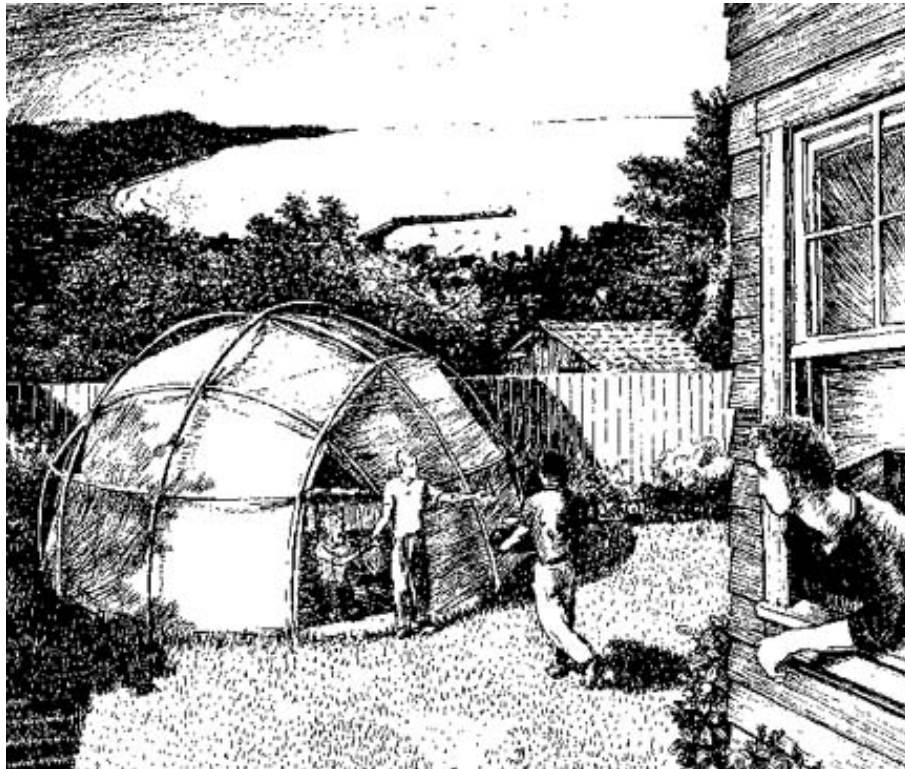
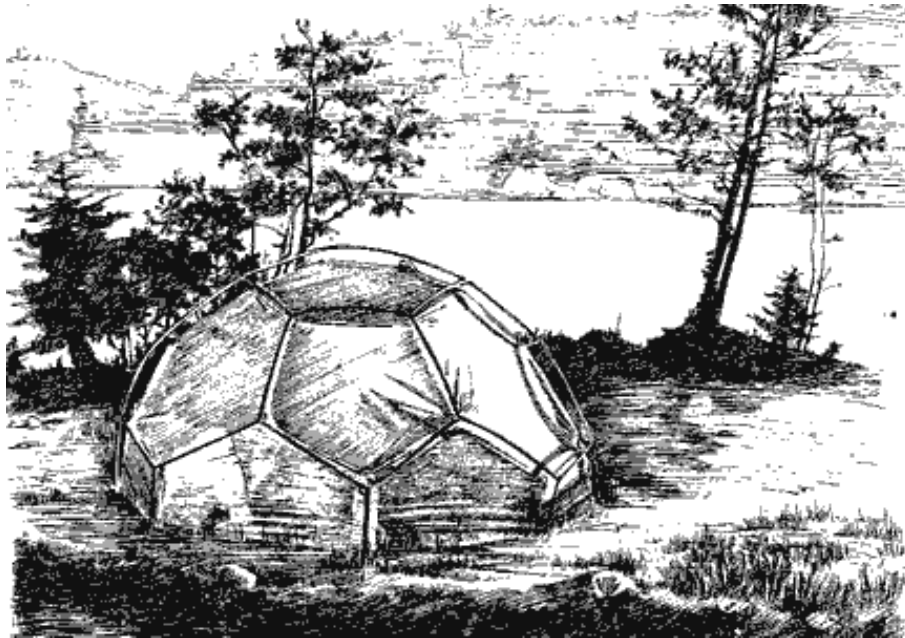

Questions? E-mail us at [shelter@best.com](mailto:shelter@best.com). Please feel free to call or write us anytime. Shelter Systems-OL, 224 Walnut St., Menlo Park, CA 94025. FAX 650-323-1220 Phone 650-323-6202.

Shelters

Greenhouses

What's New?

Gillis Designs

Stories

Q's & A's

Shelter Systems © 1996 - 2001 All Rights Reserved

[Shelter Systems' Home](#)



[Shelters](#)

[Greenhouses](#)

[What's New?](#)

[Gillis Designs](#)

[Stories](#)

[Q's & A's](#)

## Links

This is a list of links to web sites which have the same subject matter (structures) or the same environmentally friendly philosophy as **Shelter Systems** or which we've found to be helpful or just plain interesting! These links are not endorsements of any products or services in such sites, and no information in such sites has been endorsed or approved by Shelter Systems.

### **Solar**

[Real Goods](#)

### **Structures**

[Dante Bini](#)

[Kenneth Snelson's tensegrity sculptures](#)

### **Geometry**

[The Geometry Junk Yard](#)

[Polyhedreality](#)

[Mech Eng Dep Stanford](#)

[Design Stanford](#)

### **Boats**

[Messing About In Boats](#)

[Kayaks](#)

### **Knots**

[Knots on the Web](#)

### **Fun**

[Chess](#)

[Origami](#)

[Fun Bikes](#)

[More Bikes](#)

### **Interesting**

[Hubble](#)

[Photographs of Our Fascinating Universe](#)

[Science Friday](#)

[Primitive Ways](#)

[Geographic Nameserver](#)

[World Population](#)

### **Outdoor Adventures**

[Boojum Expeditions](#)

[Geographic Expeditions](#)

### **Web Site Help**

[Jorma](#)

### **Patents**

[Patent Research](#)

**Please suggest other links; contact us at [shelter@best.com](mailto:shelter@best.com).**

Questions? E-mail us at [shelter@best.com](mailto:shelter@best.com). Please feel free to call or write us anytime. Shelter Systems-OL, 224 Walnut St., Menlo Park, CA 94025. FAX 650-323-1220 Phone 650-323-6202.

[Shelters](#)

[Greenhouses](#)

[What's New?](#)

[Gillis Designs](#)

[Stories](#)

[Q's & A's](#)

**Shelter Systems © 1996 - 2003 All Rights Reserved**

[Shelter Systems' Home](#)



Shelters

Greenhouses

What's New?

Gillis Designs

Stories

Q's & A's

## Questions & Answers about Our Yurt Domes and Tents

Here are our answers to the wide array of questions we've received about **Shelter Systems'** Domes, Yurts, Tents and portable shelters. Our answers come from long experience with dome tent dwellings and gardening greenhouses.

Also look at [Answers to Email Questions](#) .

### **Will the Yurt Dome keep us dry through the heavy and almost continual rain in Olympia, Washington?**

Yes. Our designs have progressed through sewn seams to a completely reliable shingling system. The panels are shingled, one over the top of the other. The rain runs right off. No sewn seams means that there are no needle holes to try to seal - no holes to leak.



### **What about condensation?**

Many people have experienced condensed moisture on the walls in small tents. All our domes are large enough to have adequate air circulation so you won't have wet walls. The shingled construction breathes without leaking, allowing damp air to escape. A liner will further protect against the possibility of damp walls, as will any kind of dry heat.

### **Can I keep warm in the Yurt Dome?**

Yes. Domes are known for good circulation of heat because the walls and ceiling curve around. Choose a heat source to suit your circumstances such as a wood stove, propane or electric heater. You can situate your dome so it has solar exposure in the cooler seasons. The Yurt Dome lends itself well to solar heating because the translucent skylight panels are situated at angles around the ceiling. The lower opaque walls slow down radiant heat loss.

### **How can I keep cool in my dome?**

The key is shade. Best is to put your dome under a tree so that when the sun is high in the summer your dome will be shaded. In the winter, when the sun is lower in the sky, it can warm up your dome. If you do not have access to a tree you can shade your dome with one or more of the Sun Shades we make. You can also use greenhouse shade cloth, which you can buy from your garden supply store. A porch built over your dome works very well.



### **Can I put in a wood stove?**

Yes. One way is to roll up one of your doors, put a sheet of plywood a few inches wider and taller than the door opening in its place. Position it like a "shingle" for rain run off and cut a hole for your stovepipe. Hardware stores sell regular stovepipe fittings that are used for running the pipe through any wall. Another way is to cut a hole in the wall of your dome 4" larger in diameter than your stove pipe. The stove will draw air through the hole cooling the pipe.

### **What about Bugs?**

With the netting doors, most flying insects stay out! Yea! Our floors are tied in at intervals with an overlap of the wall material discouraging critters



entrance. Our customers come from many different climates and no one has reported this as a problem.

### **How do vent tubes work?**

Our vent tubes are short sections of 2" diameter PVC which, when placed between any of the shingled panels on your dome, spread and hold the shingling open. This allows warm and/or moist air to flow out of the vent tube without disrupting the rain shedding function of the shingling! When a vent tube is removed the seam snaps shut.

### **How does the doors work?**

The doors are basically flaps that overlap the door opening. A pole is included that serves as a weight on the lower edge of the door. The door is then secured at one lower corner. To open you grab the other edge and swing the door open walk in and allow the weight of the pole to swing the door closed behind you. In wind you should hook the free corner of the door to the dome.

### **Can net doors be added later?**

Net doors can be added at any time. The advantage of ordering your tent with net doors is they come already installed. If you order them later, they come with "grip clips" and instructions so you can install them yourself.

### **Is there any way to hang a curtain in my dome to divide it into two or more spaces?**

Where ever poles cross on the outside of your dome there is a clip attached to the covering under that crossing. Inside your dome at that clip attachment is the male part of the clip. Each such clip part has two holes in it to attach a cord or hook. You can hang up to 20 pounds on each clip. You can create many separate spaces inside your dome!

### **What is the porch material?**

The porch covering is made out of our translucent greenhouse woven ripstop plastic material for maximum light transmission. However if you wish you can special order the porch in white for less light or black and silver for a shade porch.

### **Would you explain the differences between the Yurt Dome, and GroDome?**

The fabric used to make theses domes is the only difference. The Yurt Dome is made of a white woven ripstop covering with 4 clear vinyl windows. The Gro-Dome is made entirely of our translucent greenhouse material.

### **Which dome lasts longer?**

We have carefully chosen materials for their durability in the sun and have not noticed a difference in lifespan between domes.

### **Would you please describe the translucent Gro-Dome covering in more detail?**

The translucent greenhouse material is like frosted glass. You cannot see clearly through it. It lets a very large amount of light through. More than enough light to support rapid growth of any plant. Its frosted nature is also ideal for growing plants, in that the sun rays are defused and do not burn your plants the way direct light can. Also see the [Accessories](#) page.

### **What do you mean by "woven rip-stop film?"**

Shelter Systems coverings are made by taking a special plastic copolymer that is stretching it till it becomes stiff. At this point, the material is at its maximum tensile (pull) strength. It is then sliced into thin strips and woven into a fabric., and then laminated on both sides. This gives it its amazing tear resistance. You can poke a hole in it with a screw driver, but you cannot tear it no matter how hard you try.

### **How is the white rip-stop film different from the translucent rip-stop film?**

The only difference is that it is white in color and lets through less light. You might ask why choose one over the other. Choose translucent if you want or need more light. Choose white if you want a white interior and exterior.

White is a pleasing color to be or work in, which is why we make all our shelter liners of white. Gro-Dome liners are of the translucent so that you can grow plants in them.

### **Could you make part or all of a dome of the white and black?**

Yes, but for most uses it would be dark and dreary inside. However, we can make you a dome with some white and black to create some shade. A white and black porch makes for more shade, also.

### **Can you make a dome of cotton canvas?**

No. We have tried. Cotton does not work on our structures, because it stretches and contracts wildly and unevenly when it is dry or damp. Some tents can use cotton where the structure is not dependent on the stability of the covering. With Shelter Systems structures the covering supports the poles as much as the poles support the covering. This makes it essential that the covering is stable and strong.



### **If my dome gets a hole or tear in it, how do I repair it?**

The materials Shelter Systems tents are made out of are very tough. It is quite hard to poke a hole in them; let alone tear them. However, if you do get a hole, the best way to repair it is with a dab of silicone rubber. This is the clear kind in a tube that you can buy from your local hardware store for caulking bath tubs. It dries clear and bonds to all materials we use in our domes and holds up in the sun. Do not use tape, except in an emergency, since the tape does not hold up in the sun, makes a mess when it comes off and looks bad. To repair a tear, use a scrap of the covering material that your dome came wrapped in or cut a small piece from the skirt of your dome, and "glue" it over the tear with silicone rubber. We make a repair kit designed for our structures that includes the best kind of silicone rubber and a generous amount of patch material of polyester canvas, clear vinyl, white, translucent, silver and black, and blue that we use in our structures.

### **How does Shelter Systems' yurt domes compare with 2"x4" yurts and teepees?**

There is a huge difference in basic structure of Shelter Systems compared to the 2"x4" yurts and teepees. The main difference is how the poles interplay with the covering. 2' x 4" yurts and teepees have a pole system you set up and a covering that is pulled over it. With Shelter Systems structures, the covering supports the poles as well as the poles support the covering. When you put up a Shelter Systems, you attach the poles to the covering one at a time. This tensions the covering and the poles at the same time. If you were to remove the covering, the poles would not stand. With most other structures this is not the case, because the poles stand on there own. This interplay between the poles and the covering with Shelter Systems structures makes for a very strong and elastic structure with minimum weight. It also makes for a shelter that is easy to put up. 2" x 4" yurts and teepees use a heavy pole structure and drape the covering over it. Through their sheer mass of poles they can support more snow than Shelter Systems structures. However, for their weight they are weaker structures.

### **Can I put the dome on a deck?**

Yes. If you go with a deck there are several things to keep in mind. You will still need plastic sheeting secured under the entire deck as a vapor barrier. Also, the skirt of your dome must hang down around the edge of the deck so water will run off and away. On existing decks that are larger than the dome's diameter, a sub-floor can be raised a few inches high inside the dome to achieve this effect. Lastly, you will have to insulate your deck if you are in a cold climate.

### **Can I set the dome up on the ground and stay warm and dry?**

Yes. Being on the ground is warmer than being on a deck unless the deck is heavily insulated. This is because of the cool air flowing under your floor. Earth floors are incredibly inexpensive compared to building a deck, they save trees, and are easier to construct! To prepare a site, you will want to make a level area with a ditch dug around the uphill side of the dome for drainage. On a flat site you must build up an area raised above the surrounding ground to insure that water will flow away from your living space.

### **Is the material you use on the Yurt Domes biodegradable?**

No. In order for these materials to serve you as walls, they are not biodegradable, simply because to biodegradable means to rot! When our polyester canvas and plastic sheetings eventually break down from the effects of sunlight, the molecules released are simple, nontoxic compounds. We are dedicated to low impact housing and have compared our materials with wood finishes, plywood resins, paint, lumber, and tar paper used in other housing, and we feel satisfied that our domes are the most ecologically efficient.

### **How long do the coverings last?**

Two to eight years of year round use. The amount of direct sunlight that hits your shelter is the life-reducing factor. We guarantee all materials for one and one-half years, based on manufacturers' tests conducted in Arizona and Florida. Most locations in the U.S. have fewer sun hours than these places. Tree shade, clouds and intermittent use naturally prolong the life of

your dome. Domes have been reported to have lasted more than 8 years in optimum conditions. Replacement covers and parts are available from us.

### **Can I use a Shelter Systems dome in the snow?**

During snowfalls you must keep a heat source going inside to keep the snow melting off the top, or periodically shake the dome so there is never too much snow on top. If a large quantity of snow falls in a short amount of time, an unattended dome will collapse. People in these conditions have had two or three poles break; these are inexpensive to repair or replace. **WARNING:** Your Yurt Dome shelter could be destroyed in extreme weather and your life or safety could be at risk. In heavy snow or wind your yurt could collapse, damaging what you have or compromising your shelter. Do not rely on your yurt dome as your only shelter. Accumulated snow, must be melted or shaken off periodically. Do not set your yurt dome under a tree or branch that might fall on you. Keep all flames and heat away from your yurt dome's covering and objects in your yurt dome.

### **Could I live in a Shelter Systems greenhouse all year round?**

Sure. Some people opt for the totally light interior that our greenhouses provide. The dimensions of the 18' Yurt Dome and the Gro Domes are the same and they are equally watertight. All accessories and options are appropriate for either one. The solar influx is greater in the Gro Domes, so if situated in the sun they will heat up a little quicker in all seasons.

### **Is there a showroom near me where I can see the domes?**

Shelter Systems is almost entirely mail order. It is expensive to have a show room and we pass the savings on to you. We understand that with a purchase of this size you want to feel secure. That is why we offer a 30-day money-back guarantee. Order a Shelter Systems dome and check it out for yourself. If it is not what you expected, simply return it to us in new condition and we will gladly refund your money.



### **Is there someone in my area who has bought a dome where I could go to see it?**

No. To protect our customers' privacy, we do not give out this information.

### **How hot do these domes get inside on a sunny day (avg. temp 70 to 80)?**

Your dome will be the coolest if you place it in the shade. This can be a safe tree, or you can make a shade roof, or you could buy and use our "Sunshade" or you can buy 90% shade cloth from your local lumber, gardening or hardware store to cover your dome. Tents have no mass to block the sun so your dome will approach the outside temperature and if in the full sun it will be hotter than the outside temperature.

### **I read that you occasionally sell good quality demos of selected sizes at a 10% discount. Are these fully**

### **guaranteed?**

Yes, these are covered by our standard guarantee.

### **What do you mean Shingled?**

Shingling is accomplished by layering the tarp panels over each other as you would shingle a roof of a house and then "clip" them together. This creates a waterproof covering. The points where the Grip Clips are attached also serve as anchoring points for poles and stakes. This is we do here at Shelter Systems. All seams are under tension by the poles. This keeps the "seams" closed.

### **Tell me more about the doors.**

The doors are basically flaps that overlap the door opening. A pole is included that serves as a weight on the lower edge of the door. The door is then secured at one lower corner. To open you grab the other edge and swing the door open, walk in, let go of the door, this allows the weight of the pole to swing the door closed behind you. In wind you should hook the free corner of the door to the dome. Often people use only one door and keep the others closed except when extra ventilation is desired.

### **We live in HI and wonder if there is a way to keep centipedes out of the dome?**

One way to seal your floor against centipedes in HI is to "glue" your floor to your dome's wall with Silicone Rubber. Get it in the large tube with a caulking gun.

### **How wind proof are the domes, and how are they anchored to the ground.**

They do well in any but the extreme winds. They are anchored with 16 - 12" Dura Peg stakes.

**Can your greenhouse domes support a certain amount of snow?**

Our domes support only a little snow however if your plan to use it as a greenhouse in the winter then you will need to heat and light it. This will melt the snow as it falls. You can also take the dome down during the winter and use it in the spring and fall to extend your seasons. This is often the best since you save on heating and lighting.

**Do you have any demo tents in clean condition for sale.**

Some times; they are discounted 10%. They will have a small amount of dirt where the dome touched the ground and have normally only been up for a few days.

**How much would it cost to individually ship an 18' tent to Australia insured? Time to arrive?**

About \$200 We ship UPS Air; which would get it to you in about 4 to 6 days.

**Is it possible to get a phone installed in my dome?**

Yes, have the phone installed in your name at a friends house near by and then run your own line to your dome.

**I understand you guys built the domes for the scifi series Earth 2?! Did you work with the cast or prop people?**

We worked with the prop people in trying to find the right dome. They bought the domes. I did go out and visit the site outside of Santa Fe; it was quite interesting with all the high teck props etc.

**Can you provide additional info about keeping rain water from coming in through the floor or sides? Is it always necessary to "trench" around the dome even when is is on level ground ? Thanks.**

The floor fits inside the tent and goes up against the walls. The rain flows down the walls and onto the ground the floor stay dry. If the soil is level and drains well, like sand, no trench is needed. If the soil does not drain well and forms puddles build up a mound to set the dome so that water can flow away from the dome. Also look at the [Shelter Systems Manual](#).

**How do your domes hold up under snow?**

Like most tents they hold only a little snow; thus you must knock snow of with a broom or heat the dome to cause the snow to melt of. If your dome is crushed by snow, usually little damage is done to the dome (a few pole braking) but your stuff inside could get damaged.

**Do people use Shelter Systems domes in the winter?**

Yes, people have spent winter in our domes, but you should realize that Shelter Systems' dome are tents and not a rigid structure. You should not rely on our domes soles for your shelter needs since if the structure should fail in extreme weather your life could be in danger. Always have a backup shelter capable of withstanding extreme weather that you could easy reach in case needed.

**Can I use a Solar-Dome or Bubble-Dome as a portable/semi-permanent backyard astronomical observatory.**

Yes, we have sold quite a few for this purpose. Most choose the Bubble-Dome and install a velcored opening at the top of the dome for their telescope to poke out of. The dome-observatory acts primarily as wind break and dew protector.

**Is it possible to "secure" a dome, and if so, how do you do it?**

Nothing is secure but a lot can be dome to protect your possessions. A locked and alarmed steel chest that is bolted to a heavy block of cement. With a sign on it saying that there is no money or gems inside. You can get alarms in mostly hardware stores that run on batteries and are self contained that go off if anyone is moving near by, yet give you 20 seconds to walk in and turn it off if you know what to do.

**Do you have any feedback on how the building code people feel about someone living in one of your domes as their only domicile on a parcel (say 5 acres, like I have)? What about the sanitation is an issue.**

It all depends on county you are in and how the people living next door to you feel. Often a "tent" is not controlled by code. Out houses are usually acceptable.

**One of the panels on my dome was damaged; can I replace it myself?**

Yes. You can order the replacement panel from us for \$40. Let us know the size and style of your dome and which panel needs replaced. After you get the panel. Align replacement panel over top of damaged one so that it matches. Remove the clip from one corner of damaged panel. This is easiest to do if you first take your dome down. However, it is possible to do it with the dome up if you first remove all the poles around the clip you need to remove. If you have trouble removing clips, heat clips and dome with boiling hot water; be careful not to burn your self. With care, pull the corner of the damaged panel out from the others, taking care not to disturb the orientation or layering of the dome's panels. It is important to remember exactly where and how the damaged panel went. Insert the corner of the replacement panel exactly where the damaged one was, in the same layering and orientation. Replace the clip. Next, proceed to each of the remaining corners of the panel one at a time, doing each

as the first. When you are done the replacement panel should be shingled as it was before and not twisted at any of its corners. Rain test the panel with a hose by squirting water up on the top of the dome allowing the water to run over the replaced panel.

**Also look at [Answers to Email Questions](#) .**

Questions? E-mail us at [shelter@best.com](mailto:shelter@best.com). Please feel free to call or write us anytime. Shelter Systems-OL, 224 Walnut St., Menlo Park, CA 94025. FAX 650-323-1220 Phone 650-323-6202.

[Shelters](#)

[Greenhouses](#)

[What's New?](#)

[Gillis Designs](#)

[Stories](#)

[Q's & A's](#)

**Shelter Systems** © 1996 - 2001 All Rights Reserved

[Shelter Systems' Home](#)



Shelters

Greenhouses

What's New?

Gillis Designs

Stories

Q's & A's

## Recent Email Questions and Answers

---

Bob

I have been using your Heavy Duty and General Grip Clip Tarp Fasteners to join and connect tarps together to cover a 30' dome frame I make and to connect four tunnel structures to the dome. I plan on taking it to burning man. The Grip Clips work great and have held the tarps together and to the frame of the dome during two big wind storms we have had here. I recently cut my thumb and can still clip multiple layers together with only one and half hands. They are a tremendous product.

Bill

---

August 11, 2004

Please send the whole package of Grip Clips together (when the **GripClipPro** will be available) to the address You have on my first order.

By the way: I am a sound engineer, working on the set for documentaries here in Switzerland. And Your Clips are perfect for me to **fix sound-absorbing fabric to walls**, through rooms or also outside between trees or lightstands. Speeds up fortification a lot!

---

On Aug 11, 2004

im building a sof kayak using your plans and grip clips and want to use willow fro my ribs i was wondering how hard it is to get it to shape and if you have a technique you can share

Willow will bend to that shape when green easily.

---

On Aug 4, 2004, at 11:29 AM, Eric Bucks wrote:

I'm wondering whether you will be offering the option of purchasing **plans** for either the New ReliefTent or the Diamond Dome?

We will when we can get to it.

I have some **Grip Clips**. Love 'em. I've used them for tarp shelters while camping, but I've used them more frequently for in the back seat of the car. I use them to string a sheet up between two seatbelts, using the sheet as a seat cover for our dog, who loves to travel but sheds quite a bit.

Thanks,

-Eric

---

On Aug 7, 2004

Hi - I ordered a set of the black light fabric grip clips. I also requested if you could include 2 extra nylon cords, each 24 inches long. I'd like to attach a Grip Clip on each end of the nylon cord, to make 2 double garters for **sheet fasteners** (rather than anchor them to the frame as your website shows, I want to wrap them around the mattress corner under the mattress). Please let me know if there will be a charge for the 2 extra cords. Thank you most kindly, Suzanne

Great idea. \$1 for the extra cord.

---

On Aug 6, 2004

Dear Shelter Systems,

Your product is amazing!!! I love your site and can't wait to own one of your domes. We are moving in the near future and are in need of temporary storage space. My hope is that the dome becomes an **alternate studio space** -- I'm intrigued by the quality of bright ambient light your dome creates.

They make get studio spaces. Your right the light is superb.

My questions have to do with removing sections of the dome structure. I want to make a patio or "pit area" with low walls of straw bales or concrete blocks that could support your 18' dome.

This can and has been done.

Included is a sketch of my idea (see attached). My plan is to trace the dome, cutting away sod to outline its shape. I want to build the walls with two entrances opposite each other. I'd then attach the dome, placing the dome doorways over the openings in the walls.

I have read your decking construction page, and while I can't think of a way to create a lowered ledge for the structure to rest upon, I'm considering sloping the top of the wall to avoid moisture from entering the dome. Perhaps the extra 6" of dome material, draped over the wall, would suffice. I intend to install pegs on the exterior wall to secure the dome in lieu of ground stakes. To extend the length of the door panels I could make a cloth section with a weighted bottom and attach it with velcro. I could then remove them when we used the dome for camping.

Questions: Is it just one tube/pipe that spans the lower part of the doorway and would it be okay to remove them in the two doorways opposite each other and not jeopardize the structural integrity of the dome?

This should be OK assuming you would be attaching the dome to your sod or bale wall.

Another question: If there's a fire platform in the middle of the pit area, and we rig a lightweight chimney to vent out the top of the dome, do you think might work? I know your Q & A page warns against open fires like those in tipis -- but what there was a generous hood a few feet above the fire with a chimney leading out the top?

If this is done right it should work. You would have to use isolated pipe and fittings to attach the pipe to the top of the dome so as to prevent melting the covering. You would also want to take care against water leaking around your pipe but I think this could be done.

Thanks in advance for your consideration regarding this matter. If you have any tips or thoughts on attaching a dome to a low wall, I would appreciate that too.

Jimmy

---

Yours Light Fabric Grip Clips are the perfect solution for **joining two 5x8 Integral Designs poncho tarps** and lift up sides.

Joe Young CA

---

On Jul 19, 2004

Dear Shelter Systems,

Have been looking at your wonderful web site and am interested in purchasing one of the **dome yurts for Burning Man** this year. I was thinking of a 11" dome, as I only require this for sleeping 1-2 people. However, I would like the following advice:

1. Please advise whether you think a 11" yurt is suitable for BM conditions?

The smallest dome we recommend for Burning Man is 14'.

2. Please advise what kind of shade structure you can supply with this size of yurt and how much it would cost?

Recommend two of our 6 by 12 sun shads or commercial shade cloth which you can get at building supply.

3. Please advise on type of mosquito netting for this yurt size and cost? And how to install?

You will not need any net doors for Burning Man. If you still want net doors they are \$25 each. The 14' has 4 doors.

4. Please advise on best floor type and how to fasten and cost?

We recommend a blue plastic tarp for a floor. You can get this at a building supply store.

5. Please explain more about ventilation tubes and what is already supplied? Do I need more?

Two are supplied and you can make more out of empty cans (see <http://www.shelter-systems.com/shingling.html>).

6. Is the fabric used a frosted white for privacy? Or can you supply other colours that would be more appropriate?

They are only available in white. It is like white paper as to the light.

7. Please advise whether I would require rebars for the guy lines?

Not with the 14'er. Be sure to read our wind warnings on the site and in the manual (Instruction Manual: <http://www.shelter-systems.com/lighthouse-manual.html> ).

8. You say that the 11" yurt has 1 door. What kind of flexibility does this door have, can you close it and secure it properly?

Having only one door is part of the reason we do not recommend this dome for Burning Man.

9. Will the yurt be warm enough for the colder evenings?

You will need to have a sleeping bag.

10. Can you ship to an address in San Francisco and how long would this take?

Yes, about a week.

11. Please can you also advise with the same questions above for a 14" dome, and provide total cost?

$\$620 + 40 \text{ shipping} + 49.6 = 707$

12. I do not live in US, and was wondering if shipping to UK would be much more expensive. Also would you be able to ship dome to UK by mid Aug?

We are about 3 weeks to shipping right now.

Please advise cost? (Can provide a US address if this is better option).

Shipping to UK is about \$250

I have been telling other friends coming to BM about your structure, and hope to put some more business your way.

Your swift response would be most welcome, as I am aware that BM is not far off.

Thank you for your help and advise.

Regards,

Jake Yearsley

---

On Jun 19, 2004

I am interested in possibly using your 30' dome for



**temp living** in Arizona at 5700 ft.

If you plan on using the dome in the winter be sure to read our snow and wind warnings.

Could one use conventional rolled insulation on the inside rather than rigid to save costs?

Yes, but batting insulation is more difficult to hold together and to support.

Also could one protect the dome material with an outside covering fastened to the poles such as conventional pvc?

Yes, but applying an outer covering is tricky since the poles are curved and the covering would need joined together and then there is the problem of holding the covering to the poles against the wind.

Thanks, you have a wonderful product.  
Eric

---

On Jun 10, 2004

**how does one keep the yurt dome from becoming an oven at burning man?**

thank you!

marcy

ps - was thinking about getting the 14 or 18 ft.

Use two of our Sun Shades (Accessories: <http://www.shelter-systems.com/accessories.html> ) and keep your 4 doors open.

---

On Jun 5, 2004,

Hello, I am considering ordering either the 20' or 30' dome for **Burning Man**. As you probably know, it is very windy and dusty in the Nevada desert. How do your domes attach or fit onto the ground if a floor is not used?

There is a skirt around the base of the yurt dome. This skirt can be buried or weighted down on the inside of the dome if you have enough stuff to do that. There are twelve stake loops around the edge of the dome. The yurt comes with guy-lines and stakes enough for the stake loops and the guy-lines. See **Dealing with Strong Winds**: <http://www.shelter-systems.com/wind-tents.html> and Instruction Manual: <http://www.shelter-systems.com/lighthouse-manual.html>

Will **dust** blow in under it?

You can not keep out all the dust but most, yes. Dust even gets into the RVs

**Are the domes waterproof?**

Yes, completely.

Once ordered, how long for normal (not rush) delivery take?

We are 2 week behind in shipping now. It takes 5 working days to get to the east coast.

Can you give me the inside dimension of the spaces between the PVC tubing (the spaces created by the overlapping tubes) for both the 20' and 30' if different?

This is about 5 foot for both.

I am asking because we are thinking about having some decoration made to be strung in the spaces. Thanks alot for your help. Your structures look great. Truly, Lori

---

On Jun 5, 2004

About 3 years ago I searched the internet for a family sized tent (8

children) that was not only big enough, but more importantly, truly waterproof. After lots of searching, we bought an 18' Dome. We have **camped** with it in Texas, Florida, and Wisconsin. We have used it as a **base camp for Paleontology digs** in Florida and Colorado. We have also used it as **temporary storage and a Garage Sale shelter**.

Sounds like you got a lot of use out of the yurt dome. What sort of digs were you on?

We were glad that we had purchased a **floor** from you. Here is how we use the floor. First we erect and stake down the dome. Then we spread the round floor tarp out inside the tent so that it overlaps up the wall all the way around about a foot. Then I take 8 foot pvc poles and connectors hooked together and feed the resulting long pole into the dome at one of the doors. I tension it all the way around the inside of the floor perimeter making a big ring pushing outward on the exterior poles. This creates a tight seal at the walls and keeps the floor stretched and secure.

This is an interesting approach to securing the floor. How high up is the pole on the wall? Does it get in the way of coming in the door at all?

**The Dome has NEVER leaked.** We have also found it to be spacious enough inside to never feel really hot or stuffy. Our Dome came with two screened doors that help with ventilation.. We often use two pvc poles to hold two of the door flaps open to create small sun flaps allowing cross ventilation.

Putting up the dome is quite easy, once you get the hang of having one person to bend the poles while the other puts it in the connector. My wife and 13 year old son have put up the 18' Dome by themselves.

The only real **design complaint** we have is the doors seem unfinished. We use binder clips to secure them, but it lacks the feel of a completed product. Do you know of anyone who has modified the doors to be more useable? Maybe a module with a zippered door?

Do you use a door pole at the bottom of your door? We now include some sticky back velcro that can be used to seal the door in windy conditions. We have found zippers to snag, jam, fail, cause leakage where they are sewn to the covering; and not the least is the time and difficulty in getting in and out of the yurt dome with zippers. When you are living in a tent you and your family go in and out lots and speed and ease of entrance and exit are important. This is why I asked if you use a door pole. Hook one side of the door and then with the pole attached you can grab the other side of the door and swing it open. Enter and then the door will close itself. True if it is windy you will then need to secure the door with the hook at the bottom. Perhaps some sticky back velcro would be useful for you also.

Over time, we have kinked a few poles, broken one Grip-clip and broken a pair of dome connectors. We also had a small hole poked in the roof that we repaired with duct tape. These were all easily repaired.

Yesterday, a **wind storm took our Dome** (being used for a Garage Sale shelter, and not well staked) for quite a ride through the yard and down the river. Amazingly, it survived in tact. However, the two top panels are each torn where they connect to the Grip Clips. Upon closer inspection, it seems that most of the panels look stressed at the points where they connect to the connectors and look like they might tear soon as well. I wonder if it is just getting old.

It does sound like your covering is beginning to wear out but you may still get a bit more life out of it.

What will it **cost to get replacements** for both of the top two panels? What will a whole new shell cost?

Replacement panels are \$45 each. New cover is \$648.

Thank you Wayne for the interesting and use full feed back.

On Jun 6, 2004

**Floor on sand.** It's a permanent site and I can add some rock underneath and some earth to the sand, it seems quite flat and stable, I need a floor of some type but if you recommend a tarp do the instructions on the best way to affix it? Thanks Kirkland

Seems like you got it figured out. No need for a tarp unless the ground dampness seems to be a problem; I would then lay down a tarp and fold it under itself so that it fits inside the dome and goes up against the walls on the inside of the dome about 4". You can then fix it in place by weighting it down with what you plan to put in the dome and or tie it to the ground level dome clips with Grip Clips attached to your floor at these points. Sometime you only need two Grip Clips at the door opening that you use to enter and exit the dome (this is where the floor gets the most scuffing and is most likely to move around).

---

On Jun 6, 2004,

Hello Bob, We've talked several times in the past, but you have many customers. Can you please send me a few jpg's and instructions on "**how-to**" **cut in windows and door netting** with the grip clips I've bought. I hope to cut down on the mistakes. They will be on my 24' 3V shingled dome tent placed on the river when the flood waters go down in Iowa!!! Any help will be greatly appreciated. Thanks in advance, Steve



There are many ways to do this. The main thing to keep in mind is shingle the windows and netting just as you do to the panels on your dome covering. I do not have photos showing this but it is not difficult. Set up your covering and pull it tight. Mark and cut a hole in one of the panels. Cut your window or netting so it is at least 2" wider and 2 feet taller than the hole is after it is cut. With Grip Clips tie in window or netting inside above the hole and outside below.

---

On Jun 3, 2004

Hi,

There are certain spray-on **UV blocking products** available, I believe acrylic based, that provide effective renewable UV protection. Have you considered using or testing such a product?

Any paint with pigment will block some or all UV. There are also clear UV blocks such as "303"

– my vagueness in my first e-mail was quite deliberate. Do the UV blocks such as "303" work on your fabric?

From all I know 303 works on our fabric. Indeed it should work on all plastics and fabrics. I have not tested it myself. The fabric we use has substantial UV inhibitors in it that

---

On May 31, 2004

Hi

I am contemplating a 14' **Dome for use at outdoor/indoor Fairs**, etc.. Many of which are held in asphalt paved parking lots or indoor gym-type floors. I noticed "stakes" being used. Are they mandatory?

No, you can hold it down with many large water containers.

They look plastic, can metal (for asphalt) be substituted?

Yes.

I have a second important question. My usage would require my **projecting video image within**. In a perfect world I would love a "paradox" functionality. Would the covering facilitate my projecting image directly on "inside" walls of dome rather than a screen in normal sunshine (daylight), but be translucent enough to have the image seen from the outside in the evenings after sunset.

Yes. I believe this would work. At least we have sold them for this use. You may want to shade the dome in the day so that the images you project would not get washed out.

This would have great "attention getting" value in a trade show/fair setting. If the dome covering material is more than a one piece item, I imagine two types in combination would be useable. I could move the projection to different "panels" for day &

evening application.

I do not think this would be necessary; but we could make the dome 1/2 white and 1/2 white in black out. But you most likely would still need to shade the dome to cut down on the glare. Most projectors are not bright enough to project well in a bright room.

Peter

---

On May 31, 2004

**Subject: tensegrity design for HS engineering class**

Bob,

I work at the Museum of Science, Boston, where we're developing a high school engineering class for 9th and 10th graders that will start being taught in around ten schools this September, and will hopefully expand beyond that.

One of the topics we're covering is construction, which includes tension and compression. Since we're making this a very hands-on course, I thought it would be cool to introduce students to Bucky Fuller's ideas by having them design tents based on his (and Ken Snelson's) ideas. When I searched Google for "tensegrity tents," your wonderful designs came up.

If you have time, I'd love to talk to you about your tents, and any suggestions or references you might have for making tensegrity design accessible for high school students.

Thanks a lot. I'm really looking forward to talking to you.

Sincerely,

Joel

Bob,

What do you think about giving students Grip Clips for prototyping their tents for this engineering class? That might be easier for students to prototype with than using rocks and string (we can teach them that method too).

I think this is a good idea.

If we were going to use 4mm polyethylene sheeting (what's it called? Visqueen?) and maybe PVC pipe as the basis of our tent "kit," which clips would be good? General purpose?

Yes.

How many would be good to have available for use in each tent? 4? 8?

If possible, I would make available a large bin of them. They are reusable. Will they get to keep their tents? (if so then you may want to limit the number you give, since you will not get them back, to say 10 or 12.) The more you give them the more options they have for creative construction.

And do you have bulk discounts?

100 for \$150

I'll order some after you tell me which ones would be best for this project.

Thanks,

Joel

---

On May 27, 2004

Hi,

I'm preparing to purchase one of your 18' yurts and I have a few questions:

1. Is the only difference between a regular and an "**Extra Strong**" yurt the window material?

They are the same except for the window material. The cost is the same.

2. I'm not clear **exactly where the windows are**. Are they low enough that someone could look in or are they higher such that one might see the stars through them?

They are the triangular shaped panels above the doors. They are at about head height when standing. So yes you could look in or out. However the Extra Strong dome has translucent windows that you can not see clearly through.

3. We will probably be camping in a fairly open field maybe with one side getting some shade from nearby forest. Would you recommend two 6x12' sun shades, one 8x20, or something else for an 18' yurt?

I would recommend two 6' by 12' **Sun Shades**.

4. **When using velcro** to attach the floor to the walls do you recommend a continuous strip all the way around or smaller strips spaced out? If the latter how much velcro would be necessary? How much would be necessary to attach four doors and one net door?

Generally it is not necessary to attach Velcro to the doors unless you have a lot of wind. And velcro is not necessary for your floor unless you are very worried about bugs. The truth is that bugs partially a few ants can always find a way in, even in a wooden house. I would start by using none and then add small bits, perhaps 4" sections, here and there if you feel you need to. Velcro has its own problems: it takes effort to hook and unhook it; the hook part can get caught in long hair or sweaters; and it can peel off if it is the wrong kind or was attached to a damp or dirty covering or the adhesive was not allowed to "cure". On the other hand it is quick to apply and does the trick of holding against wind and can be hooked and unhooked when desired.

5. Are four door poles provided?

Yes.

6. When opening up the yurt to an **Open Arched** form is the arch centered around one of the doors or is it between two doors?

The Open Arch encompasses two doors. That is to say two adjacent doors become part of the arch.

If centered, would a net door impede the process in any way?

Net doors do not effect the Arch.

7. What would be the expected delivery time for an 18' yurt?

We are quite busy at this time of year and are about two weeks to shipping.

--Mike

Sincerely,

Robert Gillis

---

On May 25, 2004

hi shelter folks:

these domes look really cool!

I've recently bought some land in rural vermont and I'm looking for a temporary structure so I can live on the land for a while before I begin to build on it. I'm writing to ask your advice about managing to **put up one of your shelters on a very rocky uneven newly cleared area of the land**. are bigger domes more difficult to deal with under these circumstances?

No, so long as you do not have trees inside where the dome is to be. You can set the dome on a slope and it is quite flexible as to fitting over rocks etc.

should I consider building a platform for the dome instead of trying to deal with the lumps and bumps and hills and dales?

I would try with out deck at least at first. You could even set up a small deck inside the dome to get around some rocks. Big decks can be a lot of work and expense.

I like the idea of being on the actual ground much better. one idea is to make a good thick layer of wood chips to even up a base for the dome. does that seem like a good idea to you?

Not sure about wood chips. Would not they rot?

the lower parts of the site are wet and boggy just now and will be every time it rains, so that's not gonna work well, I'm sure.

the higher parts of the site seem to be actual rock (not just stony, I mean, but actual bedrock). given that, is there some way to secure the dome to the ground?

Sure, tie it to rocks and trees.

sorry for all these newbie questions, but I am new, so there it is!

thanks,

eve

---

On May 24, 2004

I am interested in knowing if these **portable structures could be used in the tropics?** Where you need plenty of ventilation and protection against the rain and hot sun.

Jon Reder

Yes, The 14, 18 and 20 are standard with 4 doors and upper vents. The 30'ers are standard with 8 doors and upper vents. We also make sun shades for them. They are totally water tight. You may also be interested in our net doors and netting with velcro for upper vents. Accessories: <http://www.shelter-systems.com/accessories.html>

Bob Gillis

---

On May 17, 2004

Re: dome and yurt structure tent for burning man festival

Great. Thank you for getting back to me on this.

It is nice to know you have experience with Burning Man.

**How well does a 30 footer stand up in the wind at BM?**

They have done extremely well in the past 4 years. As far as I know not one has been damaged.

Do you make one bigger than 30ft?

No.

Also how are big are the stakes you use?

We provide 24 - 12" "I beam" ABS stakes with the dome. With stake cords provided these can be driven below the surface of the playa. This technique has worked for some. Others have created re-bar stakes (see Dealing with Strong Winds: <http://www.shelter-systems.com/wind-tents.html>).

Also see: <http://www.shelter-systems.com/burningman-.html>

---

Hi Again,

Any way of **shipping these domes to us in UK cheaper?**

If you have a friend in the US we can ship to him for our standard shipping and he could then carry (if he is coming to visit you) the packages as baggage or ship to you any way you want (some times US mail is cheaper - but slow and not as secure).

---

The old dome lasted for 8 years of extreme UV exposure up here at 9000 feet (that's what eventually did it in), snow, hail, and wind gusts up to 45 miles per hour. The design is very sound and provides for an exceptionally efficient use of interior space. We have been very pleased.

---

Hi,

Thanks for this info - when you say **ship within 2 weeks does this mean** I'll receive them within 2 weeks?

Approximately - ship date depends on what orders we are working on and what stock we have at the time of your order. Right now we are about 8 working days away from shipping your order (if you want us to go ahead with it). Shipping time is 3 to 4 days.

Also, with whom do you ship

UPS Air. They are reasonably priced, fast and insured.

- can you give me an idea of taxes + duties which will need to be paid?

This varies county to country. Call a local carrier in your area and give him the cost of the tents not including shipping.

Thanks

Raz

---

On May 6, 2004, at 9:28 AM, Kerry Edson

The **GroDome Greenhouse 18** is a replacement for our older model which had given eight years of life here at 9000 feet in the Colorado mountains. The old greenhouse would easily get up to 90 degrees on a 65 degree day.

---

On Apr 29, 2004,

Dear Shelter Systems,

We would like to order a star bubble but we would first like to know exactly how light tight it is and also if it can be set up on a concrete floor? Might you have a free standing version?

Thanks in advance,

Dmitry

The covering is drum tight. The panels that it is made of are shingled. It can be set up on concrete so long as it is held down from the wind; you can set eyebolts into the cement or hold it down by tying it to large containers of water. It is freestanding.

---

On Apr 29, 2004

Hi,

I represent a burning man camp and I'm responsible for creating the dome cover.

We have a **dome that is built from steel conduit** - here are the specs.

[www.desertdomes.com/dome3calc.html](http://www.desertdomes.com/dome3calc.html)

it is a 3V 5/8ths dome with an 11.875 foot radius. You can use the calculator to get the dimensions and see the dome plans.

the assembly diagram is at [www.desertdomes.com/pics/dome/3vdiagram2.gif](http://www.desertdomes.com/pics/dome/3vdiagram2.gif)

We would like our cover to be pink, provide substantial shade (80-90% blockage) be breathable and mostly waterproof.

We only use a white material that creates 40% shade and suggest that this be shingled to make it breathable. Suggest this covering be hung under your poles and use of a sun shade cover over the frame. You can spray paint the white pink.

I was thinking something along the lines of using the black/silver

material with each panel covered with pink sailcloth with occasional "vents" of 90% shade weave that gardeners use. I think 5 vents will be plenty.

We also want to be able to roll the cover up around the bottom edge to the second row of struts. We like the open-ness it creates.

This would not be a problem.

Our "door" consists of removing one strut in the lowest circle to create a four sided parallelogram. It's awkward to describe it. It's much easier when you see a drawing.

Not a problem.

Are you able to make something like this? Could you send me an estimate. I'm sorry I don't have the exact math figures, I've never done anything like this before.

If you use our material and Grip Clips you should be able to "clip" the covering together without sewing.

I'm not sure how much material we would need, if we need special sewing equipment, the best method for putting it all together, etc.

The cover will not be tensile, the dome cover should go over the skeleton like a skin.

Please email me a quote if you are able to do something like this. Or perhaps you'd have some advice on how to proceed.

The clips are 20 for \$40. The covering is \$8 per yard it is 6' wide.

Let me know if I can help.

-Thom Fowler

---

On Apr 30, 2004

dear dome folks, **Dome on posts**

I am looking for a temporary dome structure that I can put up from time to time in my backyard for parties and dance gatherings. I like the looks of your 30' yurt dome. Is there any way that it could be erected on top of, say, 8'-tall posts so that the sides of the structure were open? I think that would make a great garden pavilion. It might look something like...

<image.tiff>

Yes, this is possible. The posts will need to be secured to the ground and stabilized and strong enough to handle all encountered winds. You could set the posts in the ground our cement. Best support would use 20 equally space posts.

---

On Apr 30, 2004

Hi,

I'll be ordering a 14ft dome soon for **BM** and would like to get your opinion on sun shades. Do the shades work well in high wind? If so, do they offer much benefit in the desert? I was considering two 6'x12' SunShades; would this cover the 14ft well enough?

Thank you very much; I look forward to ordering soon.

Mike

You would be very glad to have the sun shades. Two 6 by 12 would be best. You could also use 90% shade cloth which you can get at your hardware store or home depo. It is a black woven plastic with lots of small holes in it.



April 1, 2004 9:04:23 PM PST

The latest on the studio yurts in Greenville SC: High winds today. While we were away, one of the **Grip Clips broke**. The skin panels did not tear. The anchors held. The Frame hung together, and the structure stood, even with the resulting opening in one side.

None of the contents were damaged, and it took about ten minutes to replace the damaged clip. I would have thought the clips were the strongest part of the system. Even so, the yurt survived, essentially intact. I'm impressed.

-Henry Mitchell

Thanks for the update. Could be the clip was defective. Send me your address and I will send you a replacement clips.

---

On Apr 8, 2004, at 8:34 PM

Received replacement clip. Thanks. Sending the broken clip for you to look at. I notice the clip you sent is larger than the ones holding my domes together. Is the larger size standard now.

The 14, 18, and 20 foot domes are still made with the General Purpose **Grip Clips but for spairs** we give the Heavy Duty as the larger size makes it easier for user to install.

---

You have the best product (Grip Clips) out there for joining lines to fabric, and fabric to fabric, that's out there... I will try to find some pics.

---

We have one of your 18' Greenhouses that has been up for **5 years and it is still standing strong**. No rips, no tarps and it does not leak.

We use it day to day to store our Macadamia nuts and grow some greens.

I just wanted to tell you that it has brought a lot of pleasure to me.

---

On Mar 22, 2004,

Dear Sir,

I'm thinking of using your **10' bubble dome to house a telescope**.

I have a 3m (9'10") circular concrete base. Either the dome could be entirely removed before an observing session, but this makes me wonder how you attach it to the ground.

You could set eye bolts in your base and then using small carabiners clip the domes 12 anchor cords to the eyebolts.

Or perhaps it might be possible to have a larger door that extends right to the top and a little beyond.

This would difficult since the strength of the dome comes from its even tension. The tension broken by this large opening would be a strength and stability problem.

It might then be possible to make the dome rotate on casters for 360 degree views. Or perhaps the open arched combined with a rotating base would work.

This should work.

Please let me know your thoughts on the practicality of these ideas and whether you have any customers with experience of using your dome for a telescope housing.

What would the shipping cost to the South of France be?

About \$120.

Best wishes  
Rob Lucas

---

On Mar 22, 2004

Dear Sirs,  
After seeing your web site on the www, I was intrigued about the lightweight roofing materials you can supply.

I'm working on a housing project for Africa.  
Each dwelling shall be 6.5m x 6.0m exterior wall sizes, and 2.4m high.  
The wall shall be made out of recycled materials, but shall be extremely strong.

Please provide more **info on your walls.**

The walls are 250mm thick.

1. Can you supply a translucent, lightweight roof to fit on top of the walls?

Possibly. Would you be able to make your walls into a 6 or 12 sided? Would not you want part of the roof to be opaque to block the heat of the sun?

2. If yes to Q1, what will be the approx weight, in kgs and fixing details?

About 15 to 20 kgs They can simply be tied from pole ends to anchors fixed in your walls. How smooth are your walls (would they abrade the roof)?

3. Approx cost per roof, we can supply sufficient materials to build approx 3 houses per day.

The prototype could be expensive depending on the wall shape and size. In 100's about \$110 manufactured in USA. If manufacturing locally then cost should be about \$60

4. Answer to Q3 should be for 1, 10 and then 100 complete roofs, so we can budget and cost effectively in our financial model.

5. Will this type of roof be in a number of pieces, the fewer the better, as local unskilled labour shall be assembling.

Would be easy to put together by unskilled labor in about 45 min.

The professional team shall be present to erect the first few, thus enabling the locals to carry out the rest.

6. Approx all up costs inclusive of shipping to South Africa and Europe.

Difficult to determine at this stage of our interaction.

We have backing from a number of European Union Ministers, who have shown a great interest in the project,

but we need to tie down this last loose end.

If you have a picture or sketch of something similar, then this would help.

Many thanks,

Glen Tully M.Sc- From Essex in the United Kingdom.

This roof is on it side: <http://www.shelter-systems.com/roof-shell.html> My suggestion would be to make one big enough for your walls.

Sincerely,

Robert Gillis

---

My wife is terribly paranoid about raccoons or other wildlife being able to get in the shelter. Is there any way that you know of to secure a floor to the bottom edge of the cover so I can alleviate her fears?

The **floor can be attached to the walls** of the Yurt with sticky back Velcro. The doors can also be sealed this way. As you know Raccoons are smart, strong and curious. The best way to keep them out is not to have food where they can smell it.

Any insight you can offer is greatly appreciated.

Darren Clark

---

On Mar 22, 2004, at 1:12 AM, Vivien Mousdell wrote:

Can your **domes be set up in interior spaces** besides outside -

Yes they are free standing and do not need to be anchored to the ground to hold their shape only to prevent the wind from blowing them away.

interested in  
using one for a puppetry/story telling space, projecting shadows & lights  
etc. onto the walls.

Yes, we have sold dome for this use in the past. I would think they would be excellent for this use. Adults and children find themselves drawn to them out of curiosity.

Which of your shapes would you recommend for maximum  
effect - uninterrupted image etc.

A large dome 20 or 30 would be most dramatic. You could set the dome up in the Open Arch form ( Open-Arched:  
<http://www.shelter-systems.com/arch-domes.html> ) if you wanted or enclosed. The white covering acts nicely as a projection  
screen (you can see the images and shadows inside and out).

Is there a supplier of your tents in  
Britain,

No.

otherwise how much would it cost to ship say a 20ft dome?

About \$180. We ship UPS air.

Thanks Vivien

---

On Mar 19, 2004

We are looking for an efficient and portable way to create a **sweat lodge structure**. I have been reading about the structures that you create and have two questions:

1. would the steam and heat of a sweat lodge adversely affect your materials?
2. would the structure of your dome withstand a layer of blankets etc. to create a darkened space in which to perform the sweat lodge?

Thank-you in advance for your time and response.

Pam Garrett  
Madison, Wisconsin

I do not know the answers to your questions personally but I have sold domes to be used for sweat lodges and therefore assume they work for this use. The heat should not harm the covering or clips. My concern would be the heat softening the poles and causing them to bend. This occurs at about 190 degrees F. If the blankets were applied on the covering under the poles then this should insulate the poles from the heat at least to some degree. If you go ahead with your project be sure to let me know so I can advise others.

---

ROBERT,

In response to my question of whether it was **safe to leave the dome up while we are away: safe for me meant the elements**. Can the dome sustain wind, rain and snow or do you advise dismantling the dome each time we leave.

Tell me more about your weather. How exposed to winds are you. If your dome was compromised by extreme wind it or your belongings could be damaged. I would not leave it up without attention if you expect it to snow. Snow can stick to it and be quite heavy. This may cause it to collapse potentially damaging belongings inside. The covering of the dome usually is not harmed. Four or so poles may break (these are easy to repair or replace as they are standard PVC).

A lot depends on how bad your weather is and what you are protecting inside. Read our warnings on snow and wind: Snow and Wind Warnings: <http://www.shelter-systems.com/warning.html>

Also, If you plan on visiting only every few months as you said in your last email, I would be concerned about dampness potentially causing mildew to things you have inside. If you have it in part sun may help keep the air dry inside. The thing, is that the air inside your dome will overtime assume the dampness of the air outside unless it gets dried out by the sun or a heat source such as a stove.

Tell me more about your weather.

---

On Mar 14, 2004, at 2:57 PM, Judith Mathews wrote:

Dear Dome Folk:

My Burning Man group is considering purchasing a 20' dome for the playa. As far as we can tell, the dome would work well in the **extreme conditions** on the Black Rock. Any special tips or considerations we should be aware of?

Look at: Dealing with Strong Winds: <http://www.shelter-systems.com/wind-tents.htm> and Instruction Manual: <http://www.shelter-systems.com/lighthouse-manual.html>

Is there a way to paint the fabric without compromising it?

You can paint it any way you want. It will not harm the material.

Thanks for whatever help you can offer.

Judith

---

### **Cat enclosure?**

On Mar 14, 2004, at 9:16 PM, Suz wrote:

Hello,

I need to start off saying that I am a huge fan of your company and structures. I've had one of your 18 foot domes for several years and it has been oh, so reliable and durable through extreme weather conditions: the raging black rock desert, Colorado Rocky Mountains, downpours in Michigan . . .

So, I thought I would run a question past you since the structure I am looking for does not exist (as far as I know) on the scale and affordability that I am looking for.

I am looking for a small geodesic dome where the covering material is like a screen, or chickenwire (a material that you can see through that will allow bugs, rain ect. . to come through. I am hoping to attach it against my home (either on one side or a corner).

The smallest dome we make is 10' diameter and 5' high. We can make this as a half dome (so it would go out from your home only 5') and we may be able to make it of fiberglass screen netting. I would be a special order and would be some what expensive because of this

Regardless of your response, I appreciate your ingenuity. I see something new every time I delve into your web site. I saw that cool little rocker for the first time. Are you selling those?

Not at this time. But we could make you a pattern so you could make or have one made for you.

Thank you for the quality of your products!

Suzanne St. Martin

---

On Mar 14, 2004, at 9:10 AM

To whom it may concern,

I own property, 40 acres, with no structure and am very close to ordering one of your geodesic domes.

I noticed on your web-sight some colored domes but I did not see a listing for them. I am interested in the white and blue geodesic dome, either 18' or 20'. Can I **specify the colors** when I order?

We only offer white at this time. White is the best "color" to live in. White will not negatively effect your vision. You can paint the domes if you want. Test the paint as to its' holding power. Spray paint is often better in that it does not as readily peel.

Thanks,  
Cris Pulos

---

On Feb 21, 2004, at 4:39 PM, Gerry Halter wrote:

Hello,

I am interested in your line of shelters. Some basic questions.

I will be using this for **retreat shelter In the desert** of West Texas. In summer it gets over 100 degrees. How does your roof top sun shade fit onto the dome?

The Roof Top Sun Shade is a separate structure and is not intended to be attached on top of a dome but can be attached to and create a shaded porch next to the dome. However:

Our Sun Shades can be pulled over the pole structure white out to reflect the sun, black in to block it. There is a generous air space under the shad to allow hot air to escape.

I would get enough shades to cover most of the top of your dome yet position the shades so as to create a gap up near the top to let hot air out. If the air out side the dome is 100 the air inside the dome will be at least r each100 unless you air condition the dome (there is no way to escape this) but at least you can be in the shade.

---

Dear Shelter Systems Folks,

**I need to choose between a BubbleDome 20 and an 18' greenhouse dome.** I am not sure how to compute the difference in available growing space/standing space/ability to ventilate.

Is it possible to have more than one door on a BubbleDome?

It is possible to make a low door opposite the tall door. Two tall doors are not recommended as they would weaken the structure (but is possible if you are not subject to wind).

You provide on your website size and volume/standable distance and standable area, and door size comparisons for your

domes/yurts but not for the BubbleDomes. Are you able to provide Bubble Dome data via email, please so as to make comparisons between Bubble Dome and yurt.

The main thing to keep in mind is that the BubbleDome is much taller and at the same time smaller in diameter. This makes it weaker in the wind since a bigger wind area and smaller base. For most applications the yurt is best unless you need the height.

I recomend the standard dome. Stronger, more space for the money, and four doors.

Thank you for any help you can offer,

Sincerely,  
Eve Trook

---

I'm interested in getting a StarBubble 10...

**I want to use it as a projection dome for a planetarium;** my company develops planetarium shows, and this will be our test site. At the center we'll have a LCD video projector with a fisheye lens, which will project onto the surface of the dome.

I'll be wanting the black/white material, but the black will be outside

No problem there. There is a 10% special order charge to make it if the white/black material. It is not fire retarded.

-- to reject all exterior light -- and the white will be on the inside, as the projection surface. No windows, naturally. How opaque is the black side (I'm after a totally opaque shell)?

Quite.

Will I need to get a sunshade to lay over the top?

I do not think so but there may be a few pinholes of light you could mask with tape.

Actually, my biggest concern is probably one you ordinarily don't run into. My ideal is a perfectly smooth and seamless, perfectly spherical inside surface. I know with the fabric construction and standard seams with shingling and overlap and those GripClips, this ideal is going to be hard to achieve. I'm guessing that the seams can be "finished" somewhat using sticky-back Velcro on them all, and trimming excess.

Or maybe just trimming close?

The "holes" of the GripClips will likely have to be filled in or covered with white tape or something so they'll be flush with the dome surface. And I'm hoping the stretching of the fabric will actually conform more to a rounded spherical surface than the flat squares I taped together out of cardboard using your model (thanks for that!)

It will not. But it may be that the clips or the lack of it not being spherical will no matter that much. ?

Is the PVC piping available in black?

No. But you could paint them. Test the paint first.

And how long would it take to get one, once the order is placed?

It would ship in about a week or so.

Thanks!

Mark

---

**I'm curious if you have tested these in high wind or polar environments?** We are always looking for shelters that are lightweight, strong and waterproof for applications worldwide. Can you provide any additional information?

Thanks,  
Jay

We do not have a lot of experience in polar environments. We use PVC for poles which shows stiffening in the very cold. We would recommend when setting up to keep the poles in a sleeping bag with hot water bottle and removing poles one at a time

when setting up. The 18' and 30' are our stronger structures and they do well in strong winds. An additional set of poles can be added for more wind strength but we still do not recommend them for extreme winds or constant strong winds..

---

Thank you so much for my 14 foot greenhouse. I never thought it would be so easy to assemble. It is a true work of art in my back yard. Keep up the good work. Thanks, Steve Farrell

---

Hello, I found your site to be very informative, however, I have questions, I may have overlooked these in your site, if so please excuse me.

**I am interested in GroDome 20.** I live in Arkansas and weather in the winter months can go as low as 10 degrees. I am wanting a greenhouse to use thru the **winter to house my ferns and plants**, until the weather is warmer usually in late April.

Questions:

1. Would the GroDome 20 be suitable for my area as described above, if I use a heater in the colder months?

Yes, if you would heat it enough to melt snow off; read snow warnings.

2. It sounds as if the dome is enclosed enough to prevent wind from coming inside ?

Yes; be sure to read our wind warnings.

3. I want to use the earth for the floor, so how is it secured down?

It includes 16 1' long stakes.

4. Can the doors be secured to prevent wind from coming in them?

Yes, if you are in a windy area consider using some sticky velcro to increase door closure security.

5. Is ample sunlight allowed in during winter months? depending on my position of course.

Yes. You will need to match the length of light that the plants need however. For example tomatoes require a long day of light so you would have to light it into the night to match the length of day that your plants need to thrive.

6. Shading would not be necessary for ferns and house type plants, correct?

You will need to match the light to what your plants require. Most house plants do not like full sun.

7. I read somewhere, something about using a liner? Would this be necessary for heat?

You can heat it easily with out a liner but the liner will save fuel and make the heat more even inside.

Sincerely,

Robert Gillis

---

Hello,

Interested in 30'foot Yurt Dome, but have questions

Your 30' Yurt Dome is great! An organization I belong to is planning on a gathering of men for August of 2005. We are planning on 80 men to attend...and we are looking for a gathering place...so, your 30' Yurt Dome seems to offer us the best space...what do you think? any other suggestions?

Mark

I think you would love it. Where is your gathering?

We have reserved a site at an Environmental Learning facility in Sandstone, MN...about 70 miles north of Mpls/St. Paul....

So, you think 80 men can fit sitting in a three-quarter circle?

thanks for your quick response...

Yes, I think so, but make sure your self by drawing a circle that is 30' by using a cord 15' long; have a friend hold it to the ground and then holding the other end and pulling it tight walk around your friend and mark a circle using stones or a marker. Then have your friend sit down and mark where he sits. Have him move etc...

---

Why would I buy a tent which did **not include a floor**??! maybe in the future you could just sell the roof and then package the walls separately. or even the poles separately or both then you could offer a truly unic product THE TENT THAT IS IT'S SELF SOLD SEPARATLY!! I think it would work. Kidding aside what's up with that???

We do offer the floor as an accessory: Accessories <http://www.shelter-systems.com/accessories.html> Some people want to put their Yurt Dome on a deck in which case a floor is not needed. Some people want to set up their Yurt Dome directly on the ground with out the floor. Others would rather buy the shelter with out the floor and lay a tarp or plastic down with carpet on top and save over the cost of our floor (the floor is a lot of material can add quite a bit to the cost of the Yurt Dome).

Just so you know, we sell most of our tent shelters with out the poles to those who ask and have access to class 200 PVC, since this save the user some in cost of the pole set and the cost of shipping them. We also offer some of our products as kits and plans. Different people have different needs, abilities, and resources. We offer a choice hoping to help were we can.

---

Hi,

From your website:

"Shelter Systems' Yurt Domes have four flap doors evenly spaced around the dome for good cross ventilation and light. The door coverings close automatically so you can go in or out quickly." I'm confused, what **holds the doors together**?

A pole can be added to the lower edge of each door to hold the door tight and make it easier to use. The door pole goes over the plugs attached to the corners of each door. One side of the door can be left hooked closed all the time if you do not need the extra ventilation. This is

particularly nice if you're using a door pole, since it allows the door to swing open and shut easily. In strong winds, hook both sides closed. Binder clips are provided with your dome to secure the doors in wind or when a tight seal is desired. They also work well on net doors. They

hold best if you overlap the door and side wall materials a little as you clip them together. If you want more binder clips, you can get them at a stationery store. To prop your door open, tuck the tip of the door pole under an adjacent horizontal pole. Of course, if you aren't using a door pole, just roll the door panel up and tuck it over the pole above the door.

How are they closed?

The weight of the pole pulls the door closed.

Can they just blow open?

If it is windy use the hook at the door bottom to hook and hold it closed.

Do they swing in or out?

Out.



I'm interested in a 20'er for family camping on the Oregon coast.

Thanks,

Dave

---

Kap Young here,

We have recieved yurt dome and sun shades. I am a contractor and have been doing hard physical work all my life and trying to put up the yurt dome was a work out. Do you have any **new and improved directions** for the yurt dome?

Dear Kap Young

The 30'er. is a beast but does get easier each time you put it up. Have you looked at the online instructions yet? They are more recent. Manual:

<http://www.shelter-systems.com/lighthouse-manual.html>

You know some tricks for tub bending?

Try inserting the upper end of the pole first then the lower. One technique I sometimes use is to insert one leg between the dome and the pole to use my body to help bend the pole. Another is to use the lower connectors as a lever to pry the pole into it. Sometimes I have my help pull out on the middle of the pole to bend it (being careful not to pull so hard that the pole kinks) while I pull on the connector that the other end of the pole is to go into to stretch the dome's covering underneath the pole.

Two people can put it up in two hours you say.

As hard as it is, I have put up a 30'er my self in about 1 hr. I weigh 135 lb and yes it was a work outand I knew what I was doing. Make sure you have at least 2 strong people to help you.

Does the dome itself stretch and go together easier the second time?

Yes, the dome does stretch out and the poles take a slight bend; both help quite a bit to make it easier to put up the next time. Also you get more experienced as to how to bend and insert the poles.

Please call or write if you still have trouble.

---

I am considering purchasing an 18' Yurtdome for use as **portable temporary housing**. I appreciate the amount of information provided on your website, but still have a few questions.

1. The 18' dome comes with four doors, how are these configured? 2 side by side on opposite ends? Evenly spaced? However I want?

Spaced evenly.

2. I will definitely want net doors, how do these function with the standard doors? 1 outswing/1 inswing?

They are situated inside the standard door. They work the same as the standard door; compleat with clips with hooks and pole plugs so they can be hooked closed and a door pole can be attached to it's base plugs to allow it to swing open and close automatically.

3. I am also very interested in the net walls shown in the instruction manual. What are the costs associated with this option, does it limit the number of doors and does it weaken the integrity of the dome.

We no longer make net walls as they weaken the structure too much.

4. I am leaning towards the Lighthouse Dome. Are there limitations for the options listed above with either the Solar Dome or the Lighthouse Dome?

At this point we make the Yurt Domes which incorporate the better parts of the LightHouse and Solar Dome.

Scott Illinois

---

I tried my new 20 foot dome this weekend. It can be backpacked in 3 loads. I simply duct tape the dome package to an old backpack frame. The instructions were a little hard to follow, but I can excuse that since the **dome was totally leakproof in 8 hours of rain**. The way the floor is oversized keeps it bone dry even with water running under it! I also like the way the shape of the dome tends to hold it down in the wind. Those windows are really really neat too. It is ingenious how the panels all overlap and seal tightly when stressed by the PVC. I know it sounds crazy to use a 20 foot dome for backpacking by myself but I love it. It is like being inside a house. Congratulations on a great product and thanks!

Bill NC

---

While searching for a **Party tent** to purchase, I ran across your sight. I am excited about the possibility of purchasing your 30' dome yurt. In your opinion, would the 30' dome be a good structure for an outdoor party?

We have sold many for this use.

How many people / tables would it hold?

Quite a few. Mark a 30' circle in a parking lot using a 15' cord and small rocks to get an idea. Have some one hold the cord and you walk around with the other end of the cord marking a circle. Then set up some tables or have friends stand inside to get an idea how big it is.

The photo at the right shows the 30' Yurt Dome being used in a **commercial for Sierra Mist** being shot on a glacier in Alaska.



---

Re: **Gro-Dome greenhouses** - questions:

1. What type of base is used?

It sits directly on the ground. Since none of the materials can rot it does not require a foundation to protect it from the ground. This also allows you to plant directly in the ground. It is free standing and comes with ground stakes.

2. I see nothing about r factor - here in Virginia the winters can get down to 10 deg F.

We make full liners (Accessories  
<http://www.shelter-systems.com/accessories.html> )  
which create an isolating air space.

How does one heat such a greenhouse,

You can use any type of stove or heater.

and is it efficient?

Yes. A dome has minimal surface area for the volume which makes it easy to heat.

3. Have you ever considered using a fine mesh screen to offer an insect-free eating area, or aviary?

Mesh does not work well since the structure needs unidirectional tensile stability (fabric with out a bias).

---

**Regarding ventilation and insects,** I'm still not clear how to prevent flies from entering the dome when the ventilation system is being used. If the doors are netted, OK, but what will prevent insects from entering via the vent tubes?

What we recommend is to use sticky back Velcro to attach a strip of netting approximately 18" by 5' to the inside of the upper shingle of tent fabric where you plan to place your Vent Tube. Do this so that the netting hangs down on the outside of the Yurt Dome's cover. Then when you insert the Vent Tube the netting will cover the opening and protect the interior from insects. If and when the bugs are not a problem you can un-Velcro the net and store it. If wind is a problem use sticky back Velcro to attach the hanging part of the net to the lower shingle.

---

### **Leakage Question.**

Is it true that if you touch a tent (from the inside) while it is raining, that it will begin to leak from that spot?  
Russell

Tents used to be made of breathable uncoated cotton which would leak at the point of contact. The tents we make breathe through the shingling and the covering is totally water proof and will not leak.

---

### **Animal Shelter**

Bob,

As I mentioned, this was taken last winter. In addition to the baby in the doorway, there are two more alpacas and 10 bales of hay and supplies inside.

18 feet seems to be a perfect fit for 4 alpacas, in case anyone wants to know.

Will send a picture I took of all three domes. Nice talking with you.

K



### **Mildew Question**

I think I would like one the 20 ft models. It would be a dwelling that is used only on weekend retreats. I don't think I would leave it up in the winter because of snow load and not being up there to keep the snow off of it. Could it be set up as a getaway shelter that I could have let's say a bed and sofa set up in and feel safe the water and mildew will stay out.

Yes, the structure is rain proof. If it gets sun, the sun will drive out the dampness and help control mildew. Heat is needed to dry the air every so often or else mildew can develop.

Anything else that I should have with it that would help me with my needs.

You will want to have a water proof floor to keep the dampness of the ground from entering your space.

---

### **Wedding Tent Questions**

Dear BevMoor

You asked some questions about using our domes as wedding tents.

We are having a wedding for 100 people in August here at our (sloped) yard. We are in S/E Pennsylvania. We have several flat areas and wonder if one of your products would be good as a shelter in case of rain.

They are completely water tight. I believe you would be pleased with how well they work and look.

How long would it take to set up?

The 30'er would take two strong people 1 hr. If you have more people to help it would go faster.

Could we use a ceiling fan or electric lights (the string kind) in it?

Yes. At each of the pole crossing there is a clip, inside the dome, with holes for attaching items. There is a limit to how much weight they can hold. I am not sure how heavy your fan is. If you are buying one I would buy a light one and tie the box up first before opening - if it is too heavy you can return it). If it is too heavy it will pull the clip inward but should not hurt the dome.

What about tables and chairs - we don't plan to get a floor, just set it on the lawn.

That should be fine if they do not sink into the lawn. Try it first. If they sink you might consider attaching small squares say 2" by 2" of plywood to the legs to help prevent them from sinking. Also, I would put a tarp down on top of the grass when the dome is not being used to help the dampness of the damp grass from condensing on the inside walls of the dome.

Do you have any demos that might suit our needs?

We only have a Bubble Dome 10 and a YD 14 demo right now.

Thanks for your help. I am excited about the possibility of using this type of structure, rather than a traditional 'wedding tent.'

We have sold many of our domes as wedding tents and think you would be pleased with them.

---

## **Burning Man**

Dear Shelter-Systems,

I recently purchased a 30 foot Yurt dome from you to take to Burning Man 2001. I am writing to tell you how much I enjoyed the dome and what a great job it did. We attached some PVC and lights to make the dome look like a big face with spikey hair(it is actually a boognish, the logo for the band Ween). We were so pleased with it and everyone told us how happy it looked. I just want to thank you for making such a wonderful

product. Here is a link to our website with pictures of the dome and our wedding in the dome (just married Sept. 2, 2001, BM'01 Temple of Boognish)! Feel free to post the night picture on your website if you want. The boognish looked great from far away!



Once again we thank you for your business.

Sincerely,

Justin and Sarah McCaleb (was Sarah Mims when I purchased it!)

---

## **Life in Yurt Domes**

Bob, We completed 3 1/2 months in the Yurt you supplied us.

We solved the heat problem with a kerosene heater (the quiet kind) which also gave us a good night light. The yurt looked like a glowing dome in the dark. We kept two vents open the whole winter. Temperatures in the 20's to the warm 60's were encountered.

We never had to worry about leaks, even in somewhat windy conditions, from rain or snow (we were snowed in one day).

The airiness of the structure made it very comfortable. We had some regrets when we moved into our house, which is so air tight that my wife, especially, always keeps the doors open "TO GET MORE AIR".

My wife and I were Camp Hosts for 3 months. I commuted to Boeing and helped her with the state park duties in the evening.

Our children

13, 10, 7, 6 years studied math, reading, science, biology, and for physical fitness and fun they hiked and observed nature from

the sea shore to the forest hideaway.

Camano Island State Park and South Whidbey Island State Park were wonderful places to observe the day to day changes of nature, season and weather from. We are even more aware of the necessity of preserved areas now that we have lived in them for a short time.

The people who do the day to day work of preserving deserve our respect and support.

We are using the yurt for a temporary storage area while I build the various cabinets and book shelves needed in our new house.

Thanks again for a structure that allowed us to be successful

Harley and Vicki Clark  
w/ Sophia, Gabriel, Michael and Nicholas

---

## Grip Clips

I want to make some awnings for my Mom. While looking for instructions on the net I found your website. Do you have the instructions for the awning pictured along with how many of the Grip Clips are necessary to complete the project?

Look at: <http://www.shelter-systems.com/awning-plans.html>

You will need 4 Grip Clips per <http://www.shelter-systems.com/accessories.html>

Also do you sell the awning material?

Chose the white/black covering <http://www.shelter-systems.com/accessories.html>

Use PVC for poles which you can find at your hardware store.

Diana Dietz

---

## Treatment for Covering

>4. Is there any recommended periodic maintenance or **treatment** (other  
>than water  
>rinsing) for the cover material to extend life: protect, preserve, etc.

"303" may extend the life. <http://www.thinkjeep.com/manufacturers/303/>

---

## Kits

Good day!

- I have been fascinated this morning reviewing your web site and products.

- Having at least 15 large tarps around, I am wondering if it is possible to just buy the structural components (Schedule 40 PVC?) and **craft my own things** such as hunting blinds, uniquely shaped storage shed, travel trailer cover, etc?

Sure.

- Do you sell just the PVC lengths separately?

These are best bought locally.

And of course, Grip Clips...

Thank you! John Cowan

---

## Burning Man

Hi there,

I'm gearing up to purchase one of your 18' domes + flooring for **Burning Man** and other uses this summer. Here are a few questions I have:

1a) I'm thinking it would be a good idea to use the black & white material on 1/2 the dome, white on the other half. Then I'd use additional b&w material, split down the center and hanging down from the top, as a way to shade 1/2 of the dome when I want to sleep or rest during the day.

I'd end up with two large pieces of material that could be bound to the sides of the dome by several cords or cloth ropes of some sort when I wanted full use of the dome, but then dropped down and loosely tied together when I wanted privacy and shade.

Do you think this could work?

Yes.

If so, how much material and other accessories do you recommend for this project?

The material is 6' wide. You would have to come up with how much you need. You could buy the dome and then take measurements. Grip Clips may come in handy.

1b) Also: could you provide this material to me custom fit for the dome? i.e. two large 1/4 oval pieces that hang from the center down, so as to be split in the middle, black facing one 1/2 of the dome and white the other? If so, what would be your price for this?

You would have to sew or Grip Clip your self. See: <http://www.shelter-systems.com/lighthouse-manual.html>

1c) Would this also be a method to help keep the dome cooler? Though I like the idea of tarp coverings, I'm concerned they'd blow away in severe winds. This 1/2 and 1/2 idea seems like it might make a good alternative. Your thoughts?

I think...Since the white and black shade cloth we offer absorbs some of the sun's heat it is best to keep the shade cloth above the poles of the dome; this way air can flow under the shade and remove the heat the shade will absorb. You can take it down in strong wind to keep it from flapping.

On the other side your idea sounds interesting and therefore you should try it and let us all know if it works

2) Given I'm going to Burning Man and the possibility of severe wind storms and damage to the dome...

How much extra PVC and other materials would be useful to bring along as a safety precaution, in order to repair the possible damage from a wind storm? I'd like to hope this would happen no more than a single time during the week, if at all. But I'd like to be prepared. Your recommendations?

The domes did well last year but you should make no assumptions. Read all we have on wind and take every care.

I would take a lot of Grip Clips and 5 or more yards of covering and perhaps 5 poles, although the poles are easy to repair with

10" sections of wooden dowels inside, also. If these are materials are not needed for repair they could be used to make porches, other shelter, for trade, shade or art.

Have fun; be safe.

---

### "Comments"

I would like to take this time to tell you that I do love this well thought out shelter. When one is inside and looking up and around it is evident the thought, time, and trial that went into making this beautiful piece of architecture. I'm telling all my friends-kudos to you all.

Jeff

---

### Burning Man

Hey-

I saw your **Burning Man** photos and I was wondering how the larger yurt domes (18', 20', 30') held up over the week. Did the high winds do them in? Cause a lot of tears?

Mikel Hubbard

Most of our domes at Burning Man were 18', 20' and 30'. I went out after each storm riding my bike far and wide looking for damage and found none. This does not mean that there was none, since I believe there were in excess of 60 of our domes at Burning Man last year and I did not visit each one. I did hear back from one person that they broke a pole. None of this is to make you think that that our dome will not go down if the wind is strong enough so take all the precautions necessary including what we recommend. I must say however I was quite impressed with how strong the winds were and how well our domes did.

---

### 10 Year Old Shelter Systems' Greenhouse

Good Morning,

I purchased a greenhouse from your company more than 10 years ago. The greenhouse is still being used and the plastic covering is still good. I have an eight foot diameter greenhouse. I think it was the middle of 2 or 4 sizes that you had at the time. I am interested in purchasing the same size or the next size larger. I never thought it would last so long and work so well, and the best part is that I can put it together myself. I usually take the greenhouse down at the end of June and sometimes put it back up in the fall and use it again till December. Thanks for a great product!

Sincerely, Caron Chapman

---

### How to Divide a Yurt Dome

Can I **divide** a 18' or 20' dome in quarters?

Yes see: <http://www.shelter-systems.com/divide.html>

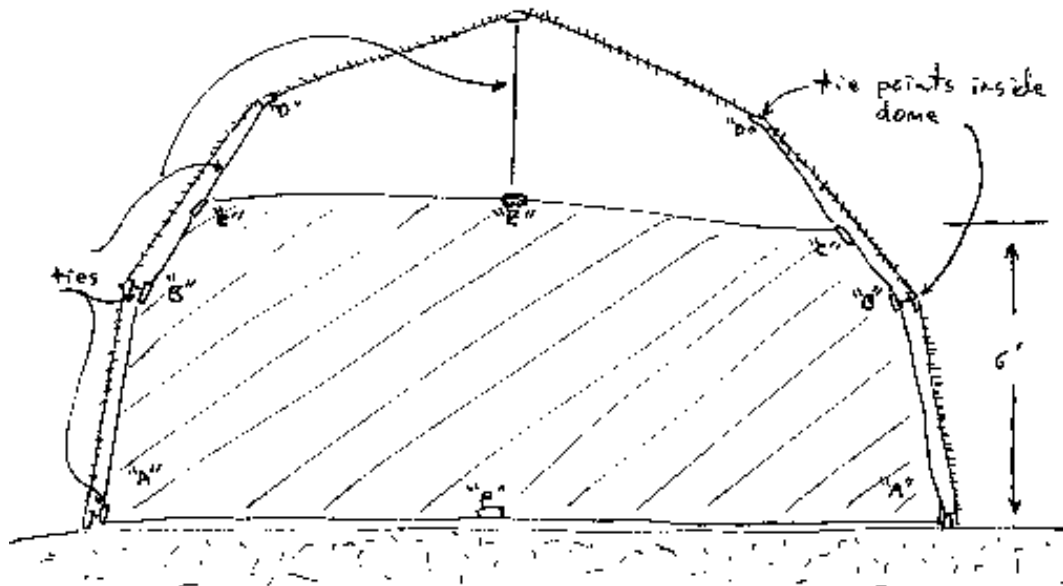

---

One of my doors is loose can I adjust the clips to tighten them?

Yes you can move the Grip Clips to adjust the tension on the door.

---

i built a deck, mounted the dome, and we have moved in. we love it...  
i need a sunshade, should i get the big shade? maybe the big one for the top, and a small one which we could move around as the sun changes?  
please advise.  
ps did i say we love it?

See the link: <http://www.shelter-systems.com/accessories.html>

---

### Warming Hut

Dear Mark

Thank you for the details on your experiences with our dome. It may inspire others. You can tie off your clothesline to the holes inside the clips as this would provide an hold fast with out going through the flaps. I was wondering if you might send us a photo that we could include with your commits?

A few notes about our geo dome. Red Top Meadows is a school / treatment center for emotionally /behaviorally challenged teenage boys. We bought the geo dome with the idea of having a semi portable **warming hut** for our winter wilderness camping program. The idea was to have a structure that could be set up on snow, with a roll out astro turf floor and install an outfitters stove. The entire unit could be broken down and transported with snowmobiles pulling haul sleds. This satisfied our need for portable as well as the forest services need to minimize our impact by setting up on snow and not establishing a camp. This was an experiment of sorts. I had done a fair amount of research for shelters and this was the lightest, cheapest, most portable and aesthetically pleasing thing I found. Strength was the question mark. Our program is located at close to 7000 ft in the Snake River Mountains of western Wyoming. We usually have over 400 inches of snow fall each year and it is not unusual for temps to go well below 0 . The dome past its first tests but we learned nothing the easy way. Here is a few notes that may help the next who try what we are trying. First off it needed a name. We took one look at it and everyone thought we would start with the Hindinburg because it looked like it would sail in a big wind and go up in flames. both were wrong but the name stuck.



-- We set it up in the yard for a week to watch it and see how it handled the elements. I got the call one morning saying the burg had collapsed. This was after it had accumulated 5-7 inches of wet heavy snow. One staff got in the middle, shoveled off the fabric, popped a few poles back in place and the burg self inflated so to speak (popped back up). Damage was one broken pole and one damaged hub.

-- If the dome is cold shaking lightly and gentle poking from inside will shed most snow easily. shake at the window triangles works best.

-- We used 10" square plywood with perlon rope to make deadmans for anchoring in the snow. One for each pvc touching the ground.

-- We bought used astro turf for 60cents a sq. ft from a company in Texas and cut it to fit then cut it again for hauling. Heavy but it worked. Were looking into other alternatives.

-- Putting the stove pipe through the door works but the door is 62"x 62" so one piece of plywood does not do it. We used a piece 48" x 62" and then rolled down the door flap and tied it off. We then used a piece of fire wrap insulation to protect the pvc and the door fabric doing a drape and weave kinda thing. Worked well.

-- We had an elbow out of the stove then a straight section inside and another straight piece outside, then an elbow going up. We stabilized the unit by sinking a ten foot piece of conduit into the snow pack and using hose clamps ( get the size right first) and bailing wire to secure it. The mesh spark arrestor needs cleaning every two days or get a dunce cap style top to the stove pipe.

-- The area around the stove needs to be insulated or else the snow will melt out and the stove will drop, screwing up all your rigging.

-- The dome heats up quickly to be very warm and cools down even faster when the stove goes out. condensation was pretty heavy and froze on the inside wall but knocked off and dried out quickly in the morning sun.

-- We used parachute cord for clothes line for drying socks etc... We reached through the fabric flaps and tied it off to the hubs. This seemed most secure.

-- The doors were hard to keep sealed even with bigger clamps once the fabric was cold and iced up a bit the clamps just want to pumpkin seed off.

-- The dome did well in some pretty good stiff wind gusts and held 3-4 inches of light snow with out a problem. If the dome collapses the legs are what take the weight. We are going to try 450 psi / pvc pipe for the leg sections.

-- The material is incredibly strong. We tested a scrap piece with a hole in it. We could not get it to tear any further and we tried. I also tried burning it to see what would happen. It melts but does not burn.

-- Replacing a hub was easy. I'm not looking forward to a grip clip replacement. Should practice before its necessary. The local hardware store had all the PVC I needed but none in the lighter 200 psi stock. Also, 10 footers come with a flared end so there is some waste when it comes to cutting spare parts

-- Were looking forward to what we can use the Hindinburg for next. It is a beautiful structure that gives off good vibes. Hope these notes help some one -- Cheers -- Mark Ames -- Red Top

---

## Repair Question

Hi there...

I bought a 20' dome from you last summer. It's great. I'm very happy with the purchase...but have a repair question:

I erected the dome on a windy day, and a large gust came through before it was guyed. The dome held up well, but the grip clip at the lower corner of one door was pulled out, leaving a round hole about 2" across. How should/can I repair this?

Thanks for your help.

Josh

Small cuts and holes in the covering can be sealed with silicone rubber and a patch cut from the wrapping that the dome came from. If a clip has pulled through leaving a hole then the whole panel should be replaced or a patch of the wrapping sewn over the hole and sealed with silicone rubber. The reason for this is that tension is greatest at clip attachment points. A quick fix can be made by simply moving the clip over two or so inches. This of course does nothing about the hole but will give a new attachment point for the clip and could get you by for a while. If more than one pole meets at the clip some of the poles may need to be shorten or lengthen.

---

### **Materials: PVC**

Hi I am interested in the geodesic yurt dome. I wanted to know firstly, i heard that PVC is very toxic and bad for the environment is this so? also will there be toxins produced in the living space by all of that heated plastic. I may want to live full time in one of these things and have concerns. Thanks alot  
Brett

I am not an expert on PVC toxins but what little I know PVC is toxic when burned. As far as I know there is no toxicity do to outgassing inside the dome. Our Extra Strong version does not have vinyl windows and the PVC poles are only on the outside.

---

### **General**

Hello, my name is Ko and I'm currently thinking of purchasing 20ft dome. But before I make a decision, I need to be clarified with some of the question that I have right now.

Is this dome could be set up without the ladder or any sort? The dome seems to be really tall.

Yes; See <http://www.shelter-systems.com/upin30min.html>

Is this dome have warranty or guarranty of anysort, if it colapsed and brokeed because of weather or accident?

Our guarantee is simple. **YOU MUST BE SATISFIED!** Everything in this catalog is offered for 30 days' free trial. If for any reason you're not completely pleased with your purchase, return it in original condition within 30 days of receipt for a full refund or exchange as you wish. All items in this catalog have a warranty against defects in materials and workmanship for 1 1/2 years. Should any product prove defective we will repair or replace it at no cost to you. Special Orders are not returnable.

### **SNOW AND EXTREME WIND CAUTION**

Your dome is a lightweight, portable structure and should not be relied on as your sole shelter in extreme weather. Your dome could be destroyed in extreme weather and your life or safety could be at risk.

In heavy snow your dome could collapse which could damage what you have in it or compromise your shelter. Do not rely on your dome as your only shelter where it snows.

Your dome will blow away if it is not anchored properly. Study the anchoring instructions carefully and apply all appropriate means to secure your dome to the earth. Rain will soften the ground and greatly reduce the holding power of the stakes. We provide good general purpose stakes, but they cannot cover all ground conditions. Wind will at times come up unexpectedly. Be prepared!

Remember that the dome is a lightweight, portable structure. Its strength comes from tension, not mass or rigid components. Exposed sites with unusually extreme winds are not recommended. It is apparent that you can not climb on top of the dome, nor can you expect it to support heavy snow loads.

Accumulated snow must be melted or shaken off periodically.

How many people could comfortably sleep in 20ft dome?

see: <http://www.shelter-systems.com/sizes.html>

thank you for taking time to answer these questions.

ko

---

## "Climate"

Hello-

I was wondering if you know about Astro-Foil Reflective Insulation?

Is it usable in your domes?

thanks,  
cindy baxter

Yes. You would need to attach it inside the dome. There a number of ways. Get it as wide as you can. If you have a liner for your dome put it between your liner and the dome. This is best dome by first removing the liner. Use the special foil backed tape to create panels of the insulation that match in size and shape to the domes panels. Attach Grip Clips to the foil and tie the clip at the top of the dome. Then tie clips at the next lower dome clips. Work your way to the ground. You might also try to safety pin the foil to the layering seams of the dome that extend inside the dome at the seams. Reattach the liner if you have one.

---

## "Sizes" Jacuzzi Cover

Interested in a small dome just big enough to cover a 8' X 8' jacuzzi which I have in the corner of my small patio. Do you have anything that might work.

Cannot stake down dome because the Jacuzzi is on concrete.

Perhaps you could tie it to your fence or you can use sand bags or concrete "eye" bolts to hold it down.

Dome should be rather vertical because Jacuzzi is located in the corner of the patio and there is a fence on two sides of the jacuzzi. In other words, there is little room to have the dome slope. Any info is appreciated. Thanks.

You might get our Crystal Cave 9 to work for you. <http://www.shelter-systems.com/tunnle-shelters.html>

---

## "Sizes" Portable Classroom

Dear Shelter Systems,

I am looking for a shelter that is portable, brightly lit on the interior, well ventilated and easily assembled. I am applying for a \$1,000 grant in order to purchase such a shelter, but I had almost given up the hope of finding something suitable when I discovered your webstie.

Can you tell me how many people can be seated comfortable in your Geodisic Yurt Dome 20 Diameter 20'x10' High? Generally I expect to have 6 - 10 students using spinning wheels plus myself. Occasionally I would like to be able to seat 20 people for a lecture. Is this possible in this size?

Given the constraints of the grant money do you have any other recommendations in choosing one of the shelters that you produce.

Thank you very much, Phylleri

I believe our 20' Yurt Dome would work well for your class room. They have been used as classrooms in the past and I believe there would be enough room for your group. You can mark a circle on the ground with a 10' cord and small stones by having some one hold the cord to the ground and then you walk in around keeping the cord tight and mark off a 20' diameter circle with the small stones. Then set up one or more of your wheels or chairs to see how they fit.

---

## "Comments"

Bob,

Here is an image as we walk it to its place in the snow. We set it up where it was warm and then carried it one mile. Andre



---

Hello,

**My wife and I do eco-building during the summer, and are thinking of buying one of your 18' yurts from friends, who write:**

"We lived in it from July-October '99, and May-November in '00. It held up amazingly well through extremely windy thunderstorms (it was VERY fun to lie in bed and watch the lightening!). And where we had it placed last summer worked out really well - there was a fair amount of tree cover (essential). "

Some questions to you as manufacturer. First, your web page mentioned a two to eight year life expectancy for the tent material:  
**What would symptoms of decay look like?**

The covering will with enough sun delaminate and tare in your hands.

The tent was used in northeastern Missouri, and has seen at least two summers, and perhaps at least one winter in the weather. How long is it likely to hold up, probably?

Two to eight years is about right.

**How much would a replacement shell cost?**

Less 10%

Also, our fourteen year old daughter is joining us this summer for the first time, but we don't really want to go wild and over spend on her accomodations as she may back out soon after we begin. What's your most affordable small space/ display model?

We have a used 20'er for less 10%

It looked like your spaces might well be pleasant enough to sweeten the deal for her, would love to find one for her. Thanks for your help!

Roger

---

## "Comments" "Burning Man"

**I did not remember if I sent you a photo of our dome at BM 2K.**

**Here it is.**

**I hope to be acquiring a 30 footer this year. Any deals for a second dome buyer?**

Leslie

---

## "Miscellaneous" "Kayak" Grip Clips

Hello, I am about to begin experimenting with skin (poly tarp) kayak design/construction. I am intrigued with your grip clip. I very much enjoyed the skin kayak that you demonstrated so well pictorially. It got my creative juices flowing. Thanks! I will be doing something similar, except that I plan to use pvc pipe instead of willow boughs. I am interested in more information about your covering materials as a possible candidate for a second generation skin after the cheap poly-tarp that I can buy locally.



**What are the weight/ thickness of your covering materials, and their strength compared to poly-tarp bought at the lunberyard?**

It is thicker, stronger and last much longer in the sun.

**Do your PVC poles offer any greater strength than water pipe pvc that would be bought at the local hardware store. Sincerely, Joe**

We use scq. 200. I am not sure what the store offers but most PVC is about the same strength.

---

## "Purchasing"

**Your stuff looks great. I will probably order soon. Do you keep most domes shown here in stock?**

We try to keep some of everyting in stock. We almost always have quite a few 18,' 20,' and 30' Yurt Domes on hand.

---

## "Comments"

Every year my family gets together for Idependence Day. This year I am more excited than ever. I am looking forward to ordering and experiencing either the 20'er or the 20' bubble. I can't wait to experience being able to walk into a shelter instead of crawling into a tent. As far as I am concerned, your product rates just Above Motor Homes. They can be more comfortable, and

the use a lot less fuel to transport. I may start a trend, but that's okay, we buy new tents about every two years. It will be nice to have something that will actually last for a while. Thank you for such a wonderful product. I can tell I will enjoy it, just from studying the diagrams on your site.

---

## "Comments"

I am a teacher, your site was published in a technical (teacher) magazine. I am taking in consideration to imply your ideas (shelters) in to a design assignment for the students aging form 11 to 15. Your site is nice and organized. I specially enjoyed the cardbordfolding prints. M. van der Lecq

---

## "General"

**If you have a printed catalog or other printed information, please send to me**

Thank you for your interest in our yurt domes and tents! We do not offer a hard copy catalog at this time. Please enjoy our extensive online catalog: <http://www.shelter-systems.com> We update it frequently with news and new products. Permission is granted to electronically copy and to print in hard copy portions of this Web site for the sole purpose of placing an order or using this site as a shopping resource. If you have any questions, please do not hesitate to ask.

---

## "Sizes"

**Weight of Half circles & circle wind walls?**

Is there a place at your site that gives the weight of your half circles and Circle wind walls.

No.

**I would like to use them at the Beach. I'm interested in the Circle wind wall 4.5' x 14'**

About 10 lbs

**Diameter & the Half circle 5' x 18'**

About 14 lbs

**& 30'  
across.**

About 25 lbs

Thank You,  
Bill

---

## "Comments"

NEAT! Ever since I was a kid I wanted to live in a geodesic dome!

---

## "Comments"

Bob, We pitched camp Thursday, when we got the dome. It went together easily in about 45 minutes.

When we arrived the Park Ranger had cut a 3/8" plywood circle (20' dia.) wrapped with a tarp over a 5/8" and under gravel base.

We chose not to say anything in regard to the differences between the recommended installation because we did not want to seem ungrateful, but Friday night it rained pretty heavily and by the next morning water was puddling under the floor and

seeping through the floor.

After evaluating the situation we found the plywood to be dry with water on the tarp. Some edges of the plywood/tarp did extend beyond the edges of the dome.

Sunday afternoon we spent an hour removing the tarp from the edges of the plywood sections and making sure that the tent flaps extended beyond the plywood. That night it rained and it seems so far that has solved the problem.

I would much prefer a dirt floor, but because of the gravel we will probably keep the plywood for now.

We are very satisfied with the dryness of the dome and its ventilation.

I and the family like it.

Harley

---

## "Climate"

**Note when putting up your dome in the cold:** The poles of the dome are made of PVC, a thermo plastic, which gets stiffer with the cold. In putting up the dome the poles are bent and inserted into connectors. It is preferable that the domes be set up during the day when the air temperature is warmer. Poles may be kept warm by wrapping them in a blanket with several large bottles of boiling hot water. Once the poles are warm remove and insert them one at a time from the blanket. If the domes are set up in the extreme cold with out warming the poles some may brake. This should not be a problem however since we include 4 extra poles with each dome.

---

## "Burning Man"

**I am looking for a dome that I can use to camp in the Black Rock Desert in Northern Nevada. I was there last September and winds can blow as high as 50+ mph. You mention that your domes will not handle extream. What method would you employ to strengthen them, and what is it about your domes that makes them unstable in high winds?**

**The dome will be for use at Burning Man, a festival on the dry lake bed outside of Gerlach, Nevada. Last year we witnessed some very very high winds and somehow our square structures with guy wires and tethers and stakes and such managed to make it. I can't imagine a dome being of lesser structural integrity than a box.**

**But your products look economical and beautiful. I think Bucky would be quite proud of your company. I look forward to your resonse.**

Sincerely,

Look at <http://www.shelter-systems.com/yurt-domes-burning-man.html>

and <http://www.shelter-systems.com/wind-tents.html>

Here is a q & a from our <http://www.shelter-systems.com/email-stillmore.html>

I am interested in purchasing a large yurt dome for the 2001 Burning Man Festival. I was wondering if you had any occurrences of domes falling down due to the wind of the 2000 BM. I remember seeing a few of your domes, and as I remember, they fared very well in the 60+ mph wind that we experienced.

I did not hear of any of our domes failing at Burning Man last year. We were there for the wind and we plan on adding to our site a whole section on dealing with wind at burning man in a month or two. So stay tuned

Also, I was wondering if you have a catalog that you can send to me. I was hoping to show it to other members of our group that are going so I can get some money out of them as well.

Our current catalog is compleatly web based at this point. I will send you an old catalog; note that it does not have all our products and you will have to rely on the web for current pricing.

We bought a \$400 tent last year and staked it down with rebar, and had some of the poles break, as well as some of the anchor rings. As you can imagine, it was quite disappointing. We also had our shade structure go down on Thursday of the event, which was not quite a surprise, but the wind actually bent 2 of the metal poles that came with the shade.

## "Uses"

**I am interested in using one of your shelters (probably the Crystal Cave shelter) to provide temporary, portable housing to my small flock of sheep. Do you know of other people who use your shelters in this way? Are there immediate concerns that you would have, as a manufacturer of using your product in this way?**

**Thanks.**

People have used our Shelters for lamas, ponies and chickens. Seems like they would work well for sheep also.

---

## "Comments"

fascinating products. I initially stumbled across your do it yourself **kayak**, but being in a hurry, I just bookmarked it for later study. it's been a while, but I sure was surprised when i investigated the whole site.

---

## "Uses"

Here are some simple shelters that were made with Grip Clips and tarps: <http://www.shelter-systems.com/tarp-kit.html> . Grip Clips add quality to a tarp shelter that can not be obtained with the old rock and cord technique.

Grip Clips provide the means to turn tarps into functional shelters. They allow you to quickly join the tarp to itself or other tarps so you can create a protected space. They grip a large area of the tarp to provide great strength for ground anchors and support for pole attachments inside and outside the shelter. They hardly pucker the tarp where they attach making for less leakage at overlapping seams and more strength. For a minimum expense, Grip Clips greatly increases the quality of the tarp shelter.

---

## "Comments"

VERY impressive. I think I've found a great alternative to the run of the mill greenhouse structure!

---

## "Miscellaneous" Kayak (Grip Clips)

Hello,

**I am a varsity scout leader for a group of 8 boys. I have been looking for a project that would both teach and inspire the boys....your 4 hour kayak just may do the trick. There are just a few questions I have regarding the supplies I will need.**

**I live in the Pacific Northwest (Medford, Oregon) and wonder where I would find the willow needed to build the kayak. As you might tell, I know nothing about plants and trees but am willing to learn!**

See : <http://www.gripclips.com/primitiveways/plants3.html/pages/Willow.htm>

**Secondly, is there a season to obtain this willow**

No.

**and do you need to soak,**



No, but you should finish the boat before the willow dries out as it will get stiff and be hard to bend.

**then dry before covering?**

No, since it is the shape of the frame that gives it strength.

**I like the 4 hour kayak because it is inexpensive and fun. Should you have other unique items to build I would be very interested.**

Take a look at our <http://www.primitiveways.com/> Site. Lots of fun to be made.

Let me know what you think.

Sincerely,

Rob

---

## "Comments"

I have looked at everything out there, including yurts, Teepees, and canvas structures, especially Pacificdomes, and yours are the most elegant and simple, not to mention the most economical. It is a brilliant design, that appeals to my need for simplicity, much as a parasail or hanglider might appeal to a pilot. Thoreau would have loved it, and I know that Ghandi would have bought several. I suspect that I will try the 20 footer. Be in touch. Glenn

---

## "Uses"

**Dear Sirs: I am a physician serving with a medical mission group in Ecuador. We are interested in your product for medical and surgical caravans that we run. The environment we encounter ranges from 15,000 feet in the Andes to tropical coastal areas. Have you had any experience with medical usage?**

Some of our tents have been used as portable medical rooms.

**What would your suggestions be as to size?**

I would think the 20' dome would work well for you but a lot depends on how big a space you need and how much you can carry.

**The Yurt Domes are white and let through 60% of the light so the inside is wonderful to work in in day or night (a small light lights up the whole Yurt Dome**

**Thanks for your help, Doug**

---

## "Climate"

**How can I make my dome last longer in the sun.**

You can shade the covering. You can paint it. You can store it when not in use. You can use "303 UV Protectant" (this is a clear space age UV protectant ant you can cover your dome with) (You can do a serch on the web for it)

---

## "Grip Clips"

**Do you have any suggestions for temporarily covering an old barn's roof. As inexpensively as possible as we will be reroofing it in the next year or so. As you might expect, its a pretty good sized roof - each side 40x60 approx. Thanks**

Yes. You can use our Grip Clips to join and hang a liner tarp inside the barn to create a protected space. We have done this and it works well and is low cost. If you want more details call. Based in Hereford, Grest Britain i am currentley compleating my final major written dissertation as part of my university degree course in 3D design. What on? Geodesic domes, Buckminster

Fuller, lowcost, low impact, temporary shelter, and the case for greater use of the geodesic dome, for portable shelter. Suddenly I find your company and go mad .

---

## "Comments"

**Thanks for your quick service! Received dome, Monday and erected 30 minutes later.**

**Hardest part of it, was unwrapping it, to lay it out.**

**We think we'll be very happy with it, will recommend to friends, and consider more domes in the future!**

**Thanks, sincerely, Michael & Mary**

---

Questions? E-mail us at [shelter@best.com](mailto:shelter@best.com). Please feel free to call or write us anytime. Shelter Systems-OL, 224 West O'Connor St., Menlo Park, CA 94025. FAX 650-323-1220 Phone 650-323-6202.

[Shelters](#)

[Greenhouses](#)

[What's New?](#)

[Gillis Designs](#)

[Stories](#)

[Q's & A's](#)

Shelter Systems © 1996 - 2001 All Rights Reserved

[Shelter Systems' Home](#)

[Shelters](#)[Greenhouses](#)[What's New?](#)[Gillis Designs](#)[Stories](#)[Q's & A's](#)

## Answers to Email Questions about Shelter Systems' Tents, Domes and Yurts.

Here is a collection of email questions from our customers about Shelter Systems' products--tents, domes, yurts, greenhouses, fabrics and coverings, poles, Grip Clip tarp fasteners--and our responses to those questions. We believe you'll find them informative and interesting!

The categories are [Accessories](#), [Anchoring](#), [Climate](#), [General](#), [Miscellaneous](#), [Greenhouses](#), [Parts & Components](#), [Purchasing](#), [Sizes](#), and [Uses](#). We list the subject of each question-and-answer, in quotation marks, at the top of each entry. Some questions fall into several categories and are listed more than once.

### "Accessories: [Porches](#)"

**Can a cover be made over the top of the door so it can be opened without the rain coming in or be able to take rain gear off before going in?**

Our porch is a 5 1/2'x5 1/2' arched square. Porches can be attached in minutes to any of our domes. With a porch you can keep your door open in a warm rain. It gives you space to take off your raincoat or boots before going in. Wet gear can be hung underneath it. The porch covering is made out of our [translucent greenhouse woven ripstop film](#) for maximum light transmission. If you wish, you can special order the porch in white for less light or in white-with-black for a shade porch.

### "Accessories: [Liners](#)"

**Do you think it's possible to live year-round in Maine in a dome with a liner and heat?**

With a full liner and a stove, the dome would be comfortable in sub-zero temperatures. A liner reduces heat loss from radiation, conduction and convection, and creates an insulating dead air space of 2"-3". It also prevents condensation which may occur in very cold situations. The full liner is constructed of a white fire-retardant ripstop film with clear vinyl windows for a wonderfully bright and warm space. (We also make liners out of the translucent greenhouse covering for our greenhouses.) To install, you tie it in place at each intersection point on the dome, pulling it tight. Installation is simple and takes about one hour. You can order a liner with your dome and install it right away, or decide to add one later. If you plan on spending a winter in your dome, a liner will produce a more evenly heated space and you will use less fuel. We make liners for our 11', 14', 18', 20', and 30' domes.

In addition to a liner, you would have to have a stove and melt the snow off. In heavy snow your dome could collapse, damaging the contents, or compromising your shelter, or even putting your life or safety at risk. Do not rely on your dome as your only shelter where it snows. A backup emergency shelter might be a shed, trailer, a nearby neighbor's house, or a snow cave.

A log cabin might be simpler.

**Would a parachute function as a suitable liner?**

No. A parachute would not fit tight inside the dome or create the unnecessary dead air space.

---

## "Accessories: [SunShades](#)"

**When would I need a sunshade? Would the sun shade greatly extend the life of a solar dome in the strong southern Arizona sunlight?**

If you are unable to put your dome under a tree or if you need shade only part of the time, consider one or more of our 6' x 12' SunShades, which you can attach to the outside of your dome with [Grip Clips tarp fasteners](#) where you need it. You would need two SunShades to completely shade the SolarDome 14 and three to completely shade the SolarDomes 18 and 20. You can also buy 90% shade cloth from the hardware or building supply store.

Our SunShade is mostly to keep the yurt dome cooler; it would extend the life of that part of the dome that it covered.

---

## "Anchoring: the [HalfDome](#)"

**How do you attach the half dome to a wall?**

Your HalfDome is no stronger than its anchors, so anchor it securely. We suggest three methods for attaching the HalfDome to a wall or fence.

The simplest method is to tie the cords, which are attached to the Grip Clips, to the appropriate fastener (ie, cement bolts, screw eyes) which you have fastened to your wall. The second method is more water-, wind-, and heat-loss resistant: Hold the HalfDome's 3" skirting against the wall, place 1/4" slats on top of the skirting, and attach the skirting+slat to the wall with the appropriate fastener. The third and most secure method is to attach the HalfDome with both the cords and the skirting.

---

## "Anchoring: Wind"

**Do you know what wind speeds the [Crystal Cave](#) is capable of withstanding without failing?**

This is a difficult question to answer because the wind in a given storm also contains gusts, so a storm might have 30 mph winds with gusts up to 70 mph. All our structures are drum tight and will handle strong wind. Although we have not conducted wind tunnel tests, several customers have reported our domes handling winds of 30 and 40 mph with no problems. However, we do not recommend them for regions or exposed sites known for unusually extreme wind, such as hurricane-force wind.

A critical factor in withstanding strong winds is anchoring. Your dome will blow away if it is not anchored properly. Study the [anchoring and guying instructions](#) carefully and apply all appropriate means to secure your dome to the earth. Rain will soften the ground and greatly reduce the holding power of the stakes. We provide good general purpose stakes, but they cannot cover all ground conditions. Wind will at times come up unexpectedly. Be prepared!

The dome is a lightweight, portable structure. Its strength comes from tension, not from mass or rigid components.

Note: Because of its continuous curved shape, the SolarDome sheds the wind better than the Crystal Cave.

---

## "Climate: Light"

**Can these structures be ordered with a few windows put in?**

The 14, 18, and 20 domes are standard with 4 clear [vinyl](#) windows above the doors. There are no other panels suitably small enough to allow us to install any additional windows. It would compromise the strength of the structure if we substituted vinyl for the much stronger woven [film](#) in the larger panels.

The panel size in the 8 and 11 is too large to permit any windows in them.

We can install up to 8 windows in the 30'er; you decide how many you'd like.

---

## "Climate: Heat I"

**Having wind flowing through the structure is a necessity, otherwise we will end up in an oven. Can we raise one of the sides of the [Crystal Cave](#) up from the ground to get airflow from one side as well as through the doors?**

Yes. You would need to prop the side up with secure poles. You can also improve the ventilation by inserting a lightweight object (such as an empty soda can) or a ventilation tube (two are provided with each dome) between the [overlapping panels](#). In addition, you can cover part of the cave with a [sun shade](#) to help stop heat from re-radiating into the CC's interior.

---

## "Climate: Heat II"

**Do you sell portable, heavy-duty, heat-reflective canopy system kits?**

Shelter Systems' structures can be made for use as ShadeStructures. Simply request that we use our [white and black shade](#) material. You should consider letting some of the covering be white to let in light. To increase ventilation, consider using the domes in the [Arch Form](#) or one of [CrystalCaves](#) with both ends open. Even our [porch](#) can be made using the shade material.

If you need shade only part of the time, consider one or more of our 6' x 12' [SunShades](#), which you can attach to the outside of your dome with [Grip Clips tarp fasteners](#) where you need it. You would need two SunShades to completely shade the SolarDome 14 and three to completely shade the SolarDomes 18 and 20. You can also buy 90% shade cloth from the hardware or building supply store.

---

## "Climate: Snow I"

**Will the domes take much snow? I have a business in the mountains. How do the 30-footers hold up to snow loads?**

Remember that the dome is a lightweight structure. Its strength comes from tension, not mass or rigid components. It is apparent that you could not climb on top of the dome, nor can you expect it to support heavy snow loads.

Accumulated snow must be melted or shaken off periodically. During snowfalls you must keep a heat source going inside the dome to keep the snow melting off the top or periodically sweep the snow off or shake the dome, so there is never too much snow on top. If a large quantity of snow falls in a short amount of time, an unattended dome will collapse. People in these conditions have had two or three poles break; these are inexpensive to repair or replace.

---

## "Climate: Snow II"

**We run a boarding kennel for dogs and are looking for some way to cover the areas where we exercise the dogs so that we can continue to use them in inclement weather. We do live in an area that gets a substantial amount of snow in the winter.**

You would have to remove the snow (melting it off as it accumulates is the easiest but this means you would have to heat it).

---

## "Climate: Cold I"

**Can they be heated? If so, what is best method?**

Yes. You can use all types of heaters: electric, propane gas, natural gas, kerosene, or wood.

The electric heater is inexpensive to buy, easy to install, clean burning, and uses expensive electricity.

Propane heater is relatively inexpensive and uses portable, bottled gas. A natural gas heater is nearly identical. A kerosene heater burns liquid kerosene with an odor which is objectional to some people. Propane, natural gas, and kerosene heaters are made in unvented or vented styles. The latter allows the combustion products (primarily, water vapor and carbon dioxide--not deadly carbon monoxide) to exit the dome through a small diameter pipe. In the unvented style, those gases are released into the dome, which is not a health problem. Additionally, much of water vapor is driven out by water pressure between the [overlapping panels](#). In especially rainy regions, it might be better to have a vented heater because all the water vapor created would exit.

A wood stove must be vented because one of wood's combustion products is carbon monoxide.

All heaters must sit on fireproof mat and must be 24" away from dome's covering or poles and from any combustibles. If you have a vented heater, you must install the vent pipe by rolling up a door, installing a plywood sheet with insulated pipe fittings, etc. (See the [Instruction Manual](#) for details.)

**Do you provide fire-retardant material specific for stove cutouts?**

No. You can buy standard fire-resistant stove pipe fittings at a hardware store.

---

**"Climate: Cold II"**

**Is it possible to insulate one of your domes, and what would you recommend?**

We make a full [liner](#) which creates an insulating dead-air space. You can also insert rigid foam insulation between the liner and the dome.

---

**"Climate: Cold III"**

**Is it possible to install a wood-burning stove in the middle of the shelter? Can it be sewn into the very top of the dome without compromising the strength of the shell?**

Yes, you can cut a hole near the top and you can sew to the covering; you should not cut any closer to a pole than 1' (to protect the dome from the heat and to maintain its structural strength) and the pipe should be cool enough not to melt the pole or covering. You would have to install this yourself.

See our online [instruction manual](#) for details on how to install a wood-burning stove.

**What is the maximum height that the chimney can safely go through the door? What is the height of the door?**

About 5', but you should not have the pipe so close to the pole as to melt it.

---

**"Climate: Cold IV"**

**Will condensation form on the fabric used in your shelters?**

Condensation will form on any surface that is colder than the air that contacts it if the air has a lot of moisture in it. There are four advantages that our shelters have concerning condensation. One, the volume is large; this dilutes the moisture in the air, reducing condensation. Two, the [shingling](#) used in the dome allows them to breath. Three, with the dome heated, condensation occurs only far down on the walls, if at all, thus making it difficult to contact this condensation. Four, any condensation that does occur runs down the lower wall onto the ground outside, not onto the floor. The floor is not sewn to the wall. Instead, where the floor meets the wall, the floor continues up the wall about another 6" and is clipped to and tied up against it. To further keep water out of the dome, there is about a 6" skirt at the bottom of the wall which directs rain and water away from the dome.

---

**"Climate: Cold V"**

**Will your PVC pipe frame resist cracking in cold temperatures of -10/-20 below?**

Yes. This does not mean the poles will not crack. If you jump on them, hit them against a rock, they will crack-- even at room temperature.

---

## "Climate: Rain I"

### **Do these shelters need a rain fly? How do they perform in a downpour?**

They do not need a rain fly because of the shingling. [Shingling](#) is accomplished by layering the tarp panels over each other as you would shingle a roof of a house and then "clip" them together. This creates a totally waterproof covering. The points where the [Grip Clips](#) are attached also serve as anchoring points for poles and stakes. This is we do here at Shelter Systems. Each panel overlaps the other by 3" making total overlap of 6". All seams are under tension by the poles. This keeps the "seams" closed yet allows the structure to breath. They perform excellently in a downpour. People have lived--dryly--for years in our domes in Washington State's rain forest on the Olympic Peninsula .

---

## "Climate: Rain II"

### **Which is more waterproof: The [Lighthouse](#) yurt or [Solardome](#)? And which is more mildew resistant?**

They are both equal in degree of being waterproof and mildew resistant.

---

## "Climate: Wind I"

### **Do you know what wind speeds your dome is capable of withstanding without failing?**

This is a difficult question to answer because the wind in a given storm also contains gusts, so a storm might have 30 mph winds with gusts up to 70 mph. All our structures are drum tight and will handle strong wind. Although we have not conducted wind tunnel tests, several customers have reported our domes handling winds of 30 and 40 mph with no problems. However, we do not recommend them for regions or exposed sites known for unusually extreme wind, such as hurricane-force wind.

A critical factor in withstanding strong winds is anchoring. Your dome will blow away if it is not anchored properly. There are 12 stake points and four guylines. Study the anchoring instructions carefully and apply all appropriate means to secure your dome to the earth. Rain will soften the ground and greatly reduce the holding power of the stakes. We provide 16- 12" good general purpose stakes, but they cannot cover all ground conditions. Wind will at times come up unexpectedly. Be prepared! See our [Instruction Manual](#) for details.

In additional to anchoring, there are more steps you can take to protect your dome from strong winds: site the dome on the leeward side of any bushes and trees, install snow fencing, or build a regular wooden fence or one made of straw bales.

The dome is a lightweight, portable structure. Its strength comes from tension, not from mass or rigid components.

Note: Because of its continuous curved shape, the dome sheds the wind better than the Crystal Cave.

---

## "Climate: Wind II"

### **Do the Grip Clips on your dome stand up to high desert winds and rain or do they break under constant high wind?**

They do very well. The clips will not break. We know people who have taken our domes to Burning Man, in Nevada, for years with no problems.

---

## "Climate: Wind III"

### **We'll be at Burning Man this summer. We're getting word that the winds this year have been truly epic -- the last storm had a gust that registered 100 mph! Any suggestions about what to do if a big wind storm comes up?**

The best thing to do would be to "drop" the dome. If you should get a storm with extreme winds, consider removing the lower 12 poles, leaving the dome anchored. Then run strings back and forth across the dome, going from stake to stake to keep the wind from lifting up on the covering. If the dome still appears to be buffeted excessively by the wind, remove the remaining poles and lash the covering to the ground again by running strings back and forth from the anchors. When the storm passes, put the dome back up.

---

## "Climate: Cloudy weather"

**Will the dome capture and store solar energy even on cloudy days?**

Yes. Of course, not as much as on sunny days.

---

## "General"

**TENTS are one of the products you sell but you have NO information in your website about tents - where is the info about tents?**

All of our domes and yurts are tents. You can find more information about tents at our Grip Clip [Tarp Tent](#) web site.

---

## "General" Burning Man, Included Parts

**What parts are included with your tents?"**

**I need this tent for camping at Burning Man. What does the tent come with? What else will I need?**

Our tents come complete with poles, stakes, guylines, [ventilation tubes](#), spare parts and a Shelter Systems' [Instruction Manual](#) that details floors, site selection, anchoring, cooling, winterizing, and stove installation--everything you'll need, except a floor. You can use a large tarp or we make you a [floor](#) that is cut to fit with clips to tie it in. (For more info on floors, see the "Parts & Components: Floors" question.)

---

## "General: SolarDome vs. Survival tent"

**What is the difference between the [SolarDomes](#) and the [Survival](#) domes?**

There is no difference. Our SolarDome is a strong, versatile tent which has many possible uses.

---

## "General: Setting the dome on a wooden platform"

**I intend to put my SolarDome 14 on a wooden platform. How large does it need to be, at a minimum? How do I attach the dome to such a platform?**

The platform should be 14' in diameter. It is best to put the dome up first and then cut the deck to fit so that water will not enter the dome. Use "eye" bolts to attach the dome to the platform. You can get these at a hardware store. See our online [instruction manual](#) for details.

---

## "General: Plumbing"

**Have you had any experience or ideas about plumbing?**

Plumbing is a long story. The simplest method, of course, is not to have any. You get more complicated from there...

Plumbing deals with two matters: water and sewage. Water is used for drinking, washing dishes and clothes, and bathing.

Disclaimer: the following information and ideas are provided in an attempt to be helpful to users of our domes, but we do not intend nor imply that you must or should implement any of these ideas. In addition, depending on where your dome is located, some of these ideas may be prohibited by local ordinances. Please be sure to check.

GETTING THE WATER:

1) Carry water in jugs to your dome.

2) Connect a hose to a neighbor's water line for pay. The water pipe carrying the water from your neighbor's must be made of a material which won't contaminate drinking water. Check with a plumbing or hardware store. Also, if there will be constant water pressure in the hose, check which fittings can handle the pressure. Storage containers come in various capacities. The large ones



are available at plumbing supplies stores.

### 3) Collect rain water:

In a tarp--using [Grip Clips tarp fasteners](#) to suspend 4 corners of the tarp--one corner a bit lower and over a barrel.

Off the dome--by attaching and hanging a gutter, made from a long, 10"-wide strip or strips of plastic tarp, to the bottom of the overlapping 6" skirt that hangs down and ends right below the horizontal pole. (Look at the first photo of the [SolarDome](#) page to understand more clearly where this is.) Fold the strip of tarp so it's still the same length but only half as wide. Hold the 2 open edges of the gutter on either side of the bottom of the skirt and fasten the 3 layers (gutter-skirt-gutter) together with safety pins, placing pins about every 2'. (Safety pin holes in the skirt of an [overlapping panel](#) will not affect the watertightness of the dome.) Let one end of the gutter hang down and drain into a barrel.

You may want to filter the water for leaves, dirt, and insect particles, using a sand filter or straining it through a clean cloth. Depending upon the water's purity, you may need to purify water to be used for drinking and washing dishes: 1) Boil it for 5 minutes. 2) Use chlorine tablets. 3) Use 2% USP iodine solution: 2 drops per quart if clear and 10 drops per quart if cloudy. Wait 30 minutes. 4) Use "household chlorine bleach (5.25% sodium hypochlorite solution). Do NOT use solutions in which there are active ingredients other than hypochlorite. Use the following proportions: Clear Water: 2 drops for one quart; 8 drops for one gallon ; 1/2 teaspoon for 5 gallons. Cloudy Water: 4 drops for one quart; 16 drops for one gallon; 1 teaspoon for 5 gallons. Mix water and hypochlorite thoroughly by stirring or shaking in a container. Let stand for 30 minutes. A slight chlorine odor should be detectable. If not, repeat the dosage and let stand for an additional 15 minutes." (1999 Pacific Bell Directory. For Palo Alto, Redwood City & Menlo Park. page B6). Contact a city or county agency to find out where to have your water tested.

4) Collect water from streams, creeks, ponds, lakes or springs. If a spring is uphill from the dome, pipe it directly to your dome or collect it in containers. Depending upon the water's purity, you may need to purify water to be used for drinking and washing dishes.

5) Collect snow and melt it slowly indoors or over a fire. To protect your pot, put some water in the pot before you put the snow-filled pot over the fire. Depending upon your water's purity, you may need to purify water to be used for drinking and washing dishes.

### 6) Drill a well.

Note: I have used all these methods, except for drilling a well.

## USING THE WATER:

### Heating water:

- 1) Heat it on a stove in a pot.
- 2) Heat it in a solar water heater (such as hanging 3-gallon bag). Check solar energy companies' websites.
- 3) Use a wood-fueled water heater, marketed online through solar energy companies.
- 4) Use a propane-fueled water heater.
- 5) Use a water heater which attaches to a wood-burning stove, marketed online through solar energy companies.

### Washing dishes:

- 1) Use a pot or bowl and then toss the used wash water. Soapy water doesn't hurt plants or animals. However, it will harm life in streams; soap is a nutrient for algae which will "bloom" and can eventually crowd out and kill fish.
- 2) Buy a sink with a drain, from a building supply or hardware store. Build a wooden box to hold the sink at desired height and after washing, direct the used water where you want it with a hose, flexible black plumbing pipe, or PVC.

### Rigging up a shower:

You'll need some water pressure. You can achieve this by either using a hanging solar bag or positioning a water storage tank uphill from shower, with a water heater in-between. Build an enclosure for privacy. You can let the water drain away.

### Washing clothes:

- 1) Use a large container or a sink, as for dishwashing. Buy a wash board at a hardware store. Dry clothes on a clothes line or inside dome in wet weather.
- 2) Use a neighbor's wash facilities for pay.
- 3) Go to a laundromat.
- 4) Buy a stainless steel, hand-powered washing machine. Wringer attachments are available.
- 5) Buy an efficient electric washing machine which can be powered with solar energy, marketed online through solar energy companies.

### Outhouse function:

- 1) Use a neighbor's facilities for pay.

- 2) Dig a one-use-only pit privy. Dig a 6"-deep hole with a shovel, use it, and then fill it with dirt. Each time. For rural use only.
- 3) Dig a hole, which is 3' in diameter and 3-5' deep, and cover it with a piece of plywood with 12"-diameter hole cut in it. Make a cover for the hole. Keep toilet paper stored nearby under a can. For privacy, build a fence or enclosure, with or without a roof. After using it, put a shovelful of dirt or lime in to minimize odor. When full, cover with about 1' of dirt.
- 4) Buy a chemical toilet (used in airplanes, RVs and houseboats), which allows you to have an inside toilet. When the container is full, you have to take the container somewhere to be emptied. Purchase from RV supply or boating stores.

#### FREEZING CONDITIONS:

Be sure to take the necessary precautions to prevent the freezing and/or bursting of your plumbing. These could be insulting your plumbing, heating it, or burying it below the permafrost.

You may want to purchase a SolarDome 8' to cover your outhouse.

---

## "General: 18' Yurt Dome"

**I'm interested in your 18' Yurt Dome. I plan to use it to live in from late May until October this year. I will be in central Utah. Some considerations: may not be able to set up under a shady tree, will have to move periodically, have several dogs, may be hot at times if I'm not up in the mountains (Manti-LaSal National Forest), one person living in it.**

**Would the Yurt Dome suit my needs? What accessories would you recommend? How large is the yurt when packed?**

I think the Yurt Dome would suit your needs well in central Utah.

If you are unable to set the dome under a tree, you may want to consider our [shade cloth](#) (SunShade). The dome goes up in 30 minutes and down in 5, so moving periodically is no problem. Having several dogs in the dome should be no problem. Tents can get hot. However, there are four doors for ventilation.

The 18' Yurt Dome, when packed, is the size of two large duffel bags, each weighing 30 pounds.

---

## "General: Can domes be linked ?"

**To what extent can shelters be linked together? For example, can a 20 or 30 foot Yurt Dome be joined to a smaller diameter dome or to a [Crystal Cave](#)?**

The domes can be linked door to door by installing a U-shaped "wraparound" made of the woven ripstop fabric to enclose, join, and seal the two touching doorways. On the inside of each doorway are 4 Grip Clips, 2 at the top corners and 2 at the bottom, for a total of 8 inside both doorways. You hang the U-shaped enclosure from these 8 Grip Clips.

To join two doorways having the same dimensions:

Make the "wraparound" by cutting some 24"-wide fabric the length of the two sides plus the top of a doorway plus an additional 4"--this extra is for attaching 8 additional Grip Clips and forming 2 gutters to drain any rain away from the joined doorway. (See [Accessories](#) to buy the additional fabric and Grip Clips needed for this.) Determine the midpoint of the strip you've cut and mark it--the midpoint will enclose the center of the top of the doorway. Hold the center of the strip up to the center of the doorway and mark on the strip where the 4 Grip Clips at the top corners of the 2 doorways touch the strip. Attach 4 Grip Clips to the strip at these 4 places and enclose the 2 doorways with the "wraparound" and using the cord supplied with the additional Grip Clips, fasten the 4 Grip Clips on the "wraparound" to the 2 Grip Clips at the top of each side of the doorway. Lastly, attach 4 Grip Clips near the ends of the strip so you can fasten them to the 4 Grip Clips at the bottom corners of the doorway.

To join two doorways having different dimensions:

Cut the "wraparound" 6' wide to allow yourself plenty of material to work with. Cut away the excess when you've finished. Proceed as above.

This enclosure is watertight. Any rain collects in the "wraparound," which acts like a gutter, and drains onto the ground, not into the doorway or your dome.

Both doors, which we install at the top of each doorway, will be enclosed in the "wraparound." If you still want to have a door covering between the attached domes, you can hang some material or a blanket in the doorway when desired.

The Crystal Caves are more difficult to link since their openings are so large, but a smaller door could be cut in their ends and then joined as above.

---

## "General: Stoves"

### Can you put a gas stove for cooking in a yurt?

Yes, you could hook up to a natural gas line or use bottled propane gas.

### Do you provide fire-retardant, heat-resistant material specific for stove cutouts?

No. We suggest you roll up one of your 4 doors and shingle in a section of plywood slightly larger than the door opening. Then use standard fire-resistant stove pipe fittings.

---

## "General: Cutting additional openings in the dome"

### If I cut windows for my telescope, how would this affect the strength of the structure? If I install additional windows, will the dome be more difficult to assemble?

Yes, you can cut an additional window for your telescope. You should cut between the poles on the dome's covering and not directly under them. If you do cut near a pole, I would leave at least a 1'-wide strip of fabric under the pole. It is true that the dome will be slightly weaker by cutting the covering. Understand that the more openings you cut and the larger they are, the weaker the structure will become. It should only be slightly more difficult to assemble.

It is possible to install a wood-burning stove in the middle of the dome by cutting a hole near the top. In this case, you leave a 2'-wide strip of fabric under the pole, to protect it from the heat.

---

## "Greenhouses": CrystalCave 11 vs. GroDome 14"

I am interested in buying one of two models of greenhouses you offer:

[Crystal Cave 11'](#) \$450 + \$45 s&h

[GroDome 14'](#) \$520 + \$30 s&h

### Are the frames' poles the same diameter?

The CC 11 uses 1" and the GD 14 uses 3/4". Both frames are constructed of strong, long lasting, resilient, UV-stabilized, Class 200 PVC tubing.

### Is the covering the same material and thickness?

Yes. The strong, woven, laminated [ripstop film](#) used in all our structures has been treated with ultraviolet inhibitors to insure extra long life. The translucent covering used in this greenhouse transmits 90% of visible light. (Most plants require at least 65% for optimum growth). The sunlight is diffused so your plants will never get burned the way they can under glass or clear vinyl.

### Which do you recommend as a better and sturdier greenhouse design?

The GD 14 is stronger; it sheds the wind better because the poles wrap in all directions. Personally, I like the dome's shape better also.

---

## "Greenhouses: GroDome 8 vs. GroDome 11"

I'm interested in a greenhouse. I like the GroDome 11 better than the GroDome 8, but I'm concerned it might not be high enough. I am confused by the measurements. I do not want anything too big but I want to be able to stand with enough head room.

We have a web page full of drawings which [compare the different-sized](#) domes. We think you'll find it very helpful.

---

## "Greenhouses: GroDomes"

I am considering purchasing one of your GroDomes. Could tell me the size of the one that appears in the photo on the [GroDome](#) information page on your website? It's the photo with the woman standing in front of the dome wearing kneepads. This will help me determine what size I need. Thanks!

That is our 20' GroDome.

---

## "Greenhouses: [GroRows](#)"

I recently purchased a Gro-row 7. I am impressed with the quality and ease of assembly. I wish that there were flaps which could be used to close the openings.

Flaps do make it warmer inside but can cause overheating if not watched quite closely. The smaller the space, the closer and the quicker the heat accumulates next to the plants. It is safer to have the ends open then to cook your plants--which I have done.

---

## "Greenhouses: winter use"

I am looking in the direction of a greenhouse of sorts for winter gardening in upstate New York--cold wind, sleet, snow, etc.

The most practical use of a greenhouse is to extend the growing seasons in the spring and fall. Although it is certainly possible to use a greenhouse in upstate New York, it would be expensive because you would have to heat and light it sufficiently to enable your plants to grow. (Installing a translucent [liner](#) in your greenhouse would reduce your fuel costs.) In addition, you must melt or sweep the snow off the greenhouse, because it's a lightweight structure. Otherwise, the greenhouse could collapse. The domes will handle strong, but not extreme, winds.

An alternative to having a full-height greenhouse is to dig a hole or trench below the permafrost level and set a [GroRow](#) or a [RoofShell](#) on the perimeter of the hole. The hole or trench must be big enough to let sufficient light in. You could grow winter crops, such as cabbage, lettuce, greens, peas, in this way.

---

## "Greenhouses: translucent greenhouse film"

Will your translucent film provide the same amount of light to plants in a greenhouse as clear poly film?

Yes. Our light-diffusing (and therefore non-burning) translucent film lets 90% of the available light through, which is more than glass lets through.

Can I expect similar plant growth in my greenhouse using your film?

Yes. It is designed for greenhouse use.

---

## "Greenhouses: Greenhouse frames"

Do you ever just sell the frames, for plants to grow on?

The frames as we make them for the domes will not stand without the covering. But we would be willing to make a special frame that would stand for you. Pricing would be 25% of the cost of the dome.

---

## "Greenhouses: Help for a beginning gardener"

This is the first time I have ever tried to handle a garden and/or a greenhouse. I need help in starting seeds, how to organize a veggie garden and so forth. Can you please help me?

Check out our [Greenhouse Gardening Manual](#).

---

## "Miscellaneous: Oval Intention"

**I have the opportunity to purchase a 15-year-old [Oval Intention](#) made by North Face. If you have any comments re this tent, I would love to hear them. It appears from the picture that the tent may be difficult to erect. Do you know what North Face's warranty policy is re this tent?**

This is a beautiful, strong tent. Bob Gillis of Shelter Systems designed this tent in 1976 and subsequently licensed The North Face to produce it. Like all of Shelter Systems' designs, for the weight of the materials used, this tent approaches the maximum strength. This allows for a minimum amount of materials to be used: economical, weight-saving, minimal use of the world's resources.

To put up poles, follow the seams.

Please direct your question to the NF in Berkeley, CA regarding their warranty policy.

**Can you tell me the dimensions of the Oval Intention by The North Face? Height and floor dimensions?**

I don't know the exact dimensions, but the NF does.

---

## "Parts & Components: Fabric durability I"

**How long will the dome fabric, or covering, last?**

About 3 years of full sun. All our coverings incorporate UV sunscreen inhibitors to help block damage from the sun and give the coverings a longer useful life.

Shelter Systems' covering is made by taking a special plastic copolymer and stretching it until it becomes stiff. At this point, the material is at its maximum tensile (pull) strength. It is then sliced into thin strips and woven into a fabric. This gives it amazing tear resistance. The fabric is then laminated on both sides with some sheets of the same stretch-strengthened material and is thereby stabilized and super strengthened. You cannot tear it. Our coverings come in three "[colors](#):" Translucent, White, and Shade covering (Silver outside to reflect light and the sun and Black inside to block light and sun).

---

## "Parts & Components: Fabric durability II"

**I will be using this shelter outside of Alamosa, Colorado at an elevation of 7500 feet. That area gets 350 days of sunshine per year, so the ultraviolet factor is a big one. How does this fabric hold up under that type of elevation and sunshine? (I notice that you've tested in Florida and Arizona.)**

I am not certain how long the covering will last in your sun conditions. My guess is approximately 2 years of full use. If you store the dome when not needed, you will extend the covering's life. As one goes up in elevation, the intensity of the sun increases.

---

## "Parts & Components: Fabric durability III"

**I am a little concerned that the stray cats in our neighborhood will reek havoc on the material. Can it be cat proofed? Or should it hold up well to the cats?**

The material we use for the covering of our yurt domes and greenhouses is very strong and should not be damaged by cats.

---

## "Parts & Components: Fabric brittleness in cold"

**Can these be used in cold weather, or does the fabric get brittle? We are interested in having an emergency shelter available at a reasonable cost. Your price is reasonable, but how about durability in midwest climate?**

The [fabric](#) that most of the dome is constructed of does not get brittle in the cold. However, the clear vinyl windows can become brittle in extreme cold. If you plan to use the dome in extreme cold, we recommend that you order it with translucent windows made of our woven ripstop greenhouse film, rather than with clear vinyl windows. The translucent greenhouse film lets through more light than glass, but images cannot be seen clearly through it. It's like looking through wax paper. Looking through the

vinyl windows is like looking through glass.

---

## **"Parts & Components: Fabric width, length and price"**

**Is the white woven ripstop material that sells for \$8.00/Yd available in a 36' width by 50' length? If not, what width and length is available?**

Our three [fabrics](#) (translucent, white, and shade) are available in 6' width, in any length, for \$8/yard. We can sew into wider widths yourself on your home sewing machine. For under 20' in length, shipping and handling are \$10; for over 20', shipping costs increase.

---

## **"Parts & Components: Painting the fabric"**

**I noticed a [camouflage tent](#) designed for military use and wondered if I could purchase one. Visibility of a huge dome from the valley might cause an "impact to the natural beauty" type complaint from the people living on the grid below.**

Sorry, we do not offer a dome in the camouflage covering. You can paint our domes with spray paint, however. Test the paint first, because paints vary a lot.

---

## **"Parts & Components: Sewing the covering"**

**I have two sky lights inside my home that I need to sew/create a drape to block out the sun and heat. Would your black liner be a material that I could sew on the back of designer fabric? I would only need about 3-4 sq yards. Can I order in quantities that small? Note that to make my liner drapes, I have to be able to sew on a sewing machine.**

Yes, our white and black shade covering would work. And it will block 100% of the light. It's 6' wide. You can order any length you need. You can sew our coverings on a home sewing machine.

---

## **"Parts & Components: fabric sun filtration"**

**I am a home gardener in north central KS. I am planning on building a wood framed greenhouse (10' X 20'). I am pricing covering materials. Filtration is my main concern.**

Our translucent covering lets through 90% of the sunlight (more than glass). Unlike glass, the translucent covering diffuses the sunlight so that it won't burn the plants inside the greenhouse. Our white covering lets through 60% of the sunlight.

---

## **"Parts & Components: translucent greenhouse fil**

**Will your translucent film provide the same amount of light to plants in a greenhouse as clear poly film?**

Yes. Our light-diffusing (and therefore non-burning) translucent film lets 90% of the available light through.

**Can I expect similar plant growth in my greenhouse using your film?**

Yes. It is designed for greenhouse use.

---

## **"Parts & Components: Fabric sun blocking"**

**Do any of your coverings block 100% of the light?**

Yes, our [White and Black covering](#) blocks 100% of the light .

---

## "Parts & Components: Fabric samples"

I'm considering buying one of your solar domes. I'd like to get fabric samples of the woven, ripstop film and the polyester canvas.

We are sending you the samples you asked for.

---

## "Parts & Components: Fabric replacement on dome"

If the shelter covering needs to be replaced, but the pole frame is in good condition, how much does only the fabric cost? Connectors only?

We sell replacement dome covers with Grip Clips and connectors attached for 80% of the cost of the dome. We don't sell covers by themselves because attaching the Grip Clips and connectors is complicated.

---

## "Parts & Components: Creating a big tarp with fabric and Grip Clips"

I'm interested in using your coverings and [Grip Clip tarp fasteners](#) on a construction site. My thoughts are to use your clips with some poles and guy lines to hold in position. Ideally it should be about 50 X 100'. Is this practical?

Our woven fabric, which is 6' wide, can be sewn into tarps, but we recommend you buy one readymade. Or you can [join tarps together](#) (or our fabric) with our Grip Clips to create a larger size. The wind loading on a 50x100' tarp would be high.

With poles, guylines and Grip Clip tarp fasteners you can create good protection for a building under construction. Grip Clips are versatile: you can create the size and shape of covering you need for a particular job, then disassemble the covering, and use it on the next job.

---

## "Parts & Components: Making sails from our fabric"

I'm interested in purchasing some of the [woven ripstop fabric](#) used for greenhouse coverings and tarps. The intended purpose is to make sails for sailboats. I refurbish old boats for teens and scout troops but sail fabrics have historically been cost prohibitive for the program and do not hold up well under the vigorous use (abuse) of these energetic sailors. In what quantities would I have to purchase the clear woven poly fabric, and in what standard widths does it come? Are sample swatches available?

We don't have experience using our fabric for sails. However, we believe the fabric has the right properties to make a good sail: It's stable on the bias (it doesn't stretch) and has a stiffness (a "stiff hand") which is ideal for sails (it won't get baggy). It can be sewn. You could attach it to the mast by sewing a sleeve or with [Grip Clips tarp fasteners](#). You could attach it to the boom with a Grip Clip. It is 6' wide, available in any length, costing \$5 a yard + shipping. We can send you a sample.

---

## "Parts & Components: Doors & dome security"

How are the doors secured?

With hooks.

Any locking device?

No.

---

## "Parts & Components: Net doors "

How is bug netting attached to doors?

If you ordered net doors with your original order, they are already installed and function just like your fabric doors. If you got them from us later, you can install them yourself.

To install a net door, you tie the upper two corners of the net door to the two dome clips on the upper inside corners of the doorframe. There are holes on the interior of the clips on your dome for this purpose. Thread the string through one of these holes on each of the 2 clips. Pull the string up as short as you can get it and tie.

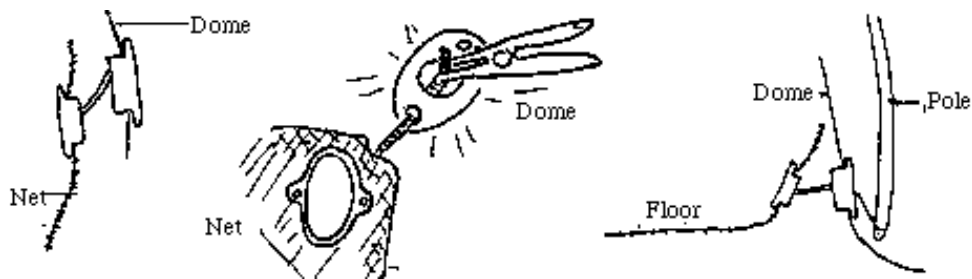

---

## "Parts & Components: Floors I"

**Do any of these domes have floors like some tents? I don't mean a wood floor, but a fabric floor or bottom.**

Our domes do not come with floors. However, some type of ground cover is necessary to keep dampness from coming up into your space. Either you can use your own tarp or we make you a [floor](#) that is cut to fit your dome. Shelter Systems' floors are made of a blue, tough, waterproof, fire-resistant, ripstop material. If you decide to make your own floor, you can purchase [Grip Clip tarp fasteners](#) from us for attaching the floor to the dome. It is often not necessary to attach the floor to the wall because objects on the floor may be adequate to prevent the floor from shifting around.

There is a good reason that our floors are not sewn in. We have eliminated a critical area for leaks: seams at ground level. To further keep water out of the dome, there is an approximate 6" skirt all around the bottom of the wall which directs rain and water away from the dome.

Another reason not to sew the floor to the wall is any condensation that might occur runs down the lower wall onto the ground outside, not onto your floor. This is because at the place where the floor meets the wall, the floor continues up the wall about another 6" and is then clipped to and tied up against it with our Grip Clip tarp fasteners. (For more info on condensation, see the condensation question in the "Climate: cold" section above.)

Another benefit of a separate floor is that when your dome is stored, the floor can be rolled up separately so it will not dirty your walls.

Our [Instruction Manual](#) provides information and suggestions on siting your dome for good drainage, installing our floor in the dome, building decks, etc.

---

## "Parts & Components: Floors II"

**Can you put in a wooden floor so that you are up off the ground?**

Yes, you can build a wooden deck for your dome. See our [Instruction Manual](#) for details.

Most of us have lived our lives in a house, so living on the ground does not come intuitively to us. We think living on an earthen floor would be wet, cold, and damp. However, if you choose your site carefully and prepare the earthen floor properly, the earthen floor will be drier, warmer and always much cheaper than building a wooden deck. It requires time and effort to build a deck and make it function properly, so that rainwater doesn't flow into the dome, so it's attached properly to its foundation, and so it's adequately insulated against cold. You need to have carpenter skills, aptitude, ambition, and/or a good book on building decks. Of course, a deck would be a better floor in some situations, such as on a very steep slope or on boulders or volcanic rock you can't easily move, or if you want to elevate the dome.

---

## "Parts & Components: Dome frames"

**Do you ever just sell the frames?**

The frame as we make them for the dome will not stand without the covering. It's nearly impossible to assemble. But we would be willing to make a special frame that would stand for you. Pricing would be 30% of the cost of the dome.

---



## "Parts & Components: Poles"

**Is it possible to use bamboo or wood poles instead of PVC pipe?**

Yes, if they are bent to the same degree as the dome is curved. You can do this with green bamboo branches or pre-bent branches.

---

## "Parts & Components: Poles"

**Will your PVC pipe frame resist cracking in cold temperatures of -10/-20 below?**

Yes. This does not mean the poles will not crack. If you jump on them, hit them against a rock, drive over them, they will crack-- even at room temperature. A broken pole is easy to replace. Or to repair, by inserting a section of a branch between the two pieces of the pole.

---

## "Parts & Components: Privacy"

**When you are inside the shelter at night and you have lights on, can people on the outside see your silhouette? If so, what do you recommend to prevent this?**

Depends on the lighting. You could hang drapes inside or you could order the dome with walls made of our white/black/white covering. This is white on both the inside and outside with black in the middle.

---

## "Parts & Components: non-stooping entrance"

**I am interested in the dome you display as a "Golf in the Rain" [HexPent dome](#). Your web page says that it is not available at this time, but makes a reference to your SolarDome 20. I looked at that, but can't tell if it's about the same size.**

**I'd like a structure that people could walk in (to find some shade or to get out of a light rain) without having to stoop much. The "Golf" dome looks perfect for that! Are you planning on selling it in the future, or is it a "display only" or discontinued item?**

We're not planning on marketing the HexPent dome in the near future. Take a look at our [20' SolarDome](#), which is the size of the HexPent dome. Transformed into the [Arch Dome](#), it has a 7'5" high opening.

Arch Dome

Full size 14', 18', or 20' domes can be transformed into Arch Domes by you at no cost. Instructions that come with your dome tell you how to turn your dome into a Arch Dome. It takes only about 15 minutes and can be undone when you want your full dome back. The Arch Dome is great on a hot day or in a hot climate since the large arched opening provides for unsurpassed ventilation. It is excellent for using your dome as a display show space at a fair or other social occasion. The large opening is inviting and friendly.

---

## "Parts & Components: Dome weight"

**I am very interested in using one of your Domes in the Islands of the Pacific. I would need the lightest you have as we will be traveling at times several miles inland on foot. We will be using this Dome as a temporary meeting place for a group of 20 people. Then using it as sleeping quarters.**

We would recommend the 20-foot SolarDome. It weighs 70 pounds total, divided equally between two packages. The dome makes a beautiful meeting place.

---

## "Parts & Components: Grip Clips"

**We run a boarding kennel for dogs and are looking for some way to cover the areas where we exercise the dogs so that we can continue to use them in inclement weather. We do live in an area that gets a substantial amount of snow in the winter.**

You would have to remove the snow either manually or by melting it off as it accumulates. The latter method is the easiest but this means you would have to heat it. An alternative (and the most sensible) method of covering the run would be to attach poles or 2x4's to the fence on one side extending above the fence top to create high anchor points and then attach a tarp or tarps with [Grip Clip tarp fasteners](#) over the entire run. You can also use Grip Clips to [join smaller tarps together](#).

---

## **"Purchasing: availability and shipping"**

**I would like to know if all the models are available and how long the delivery time will be.**

We keep the basic SolarDomes, LightHouses, and GroDomes in stock. Orders are filled in the order in which they are received. Orders are usually shipped via UPS within one week of receipt. Delivery time is about 2 days within California, 4 days to Colorado, and 6 days to the East Coast.

---

## **"Purchasing: Saving on shipping costs"**

**If we order one, can we come to Menlo Park to pick it up and save on shipping?**

Sure, if you let me know in advance; we make them in Santa Cruz.

---

## **"Purchasing: commissions"**

**I am in the position to recommend your company to a group of people starting a new community.**

**Since my funds are limited to purchase your tents...do you give a commission (toward tent purchase) for those people I recommend that purchase from you?**

We do not offer commissions, sorry, but do appreciate your support.

---

## **"Purchasing: discount"**

**If I buy four or five of your shelters, is there a possibility for a discount?**

We don't offer such a discount.

---

## **"Purchasing: educational discounts"**

**Do you offer any educational discounts?**

We do not offer educational discounts.

---

## **"Purchasing: Grip Clip discounts"**

**Do you quantity discount your grip clips? If I were to buy enough, would there be a price break?**

The price is \$10 for 4 Grip Clips; see our [online catalog](#). We do have a price see this same link.

---

## **"Purchasing: Used/Demo Domes"**

**Do you have any used domes available at cheaper prices?**

Sometimes we have a small number of "nearly new" domes that are discounted 10% to 20%. Sometimes we also have a number of slightly dirty, but new, Grip Clips available at half price. If you are interested, call us.

---

## "Purchasing: Rentals"

**Do you ever do rentals of your products?**

We don't rent any of our products.

---

## "Purchasing: show room"

**Do you have any structures on site? I'm in the Sacramento area and can easily get to the San Francisco Bay Area. Would it be possible to set up a scheduled visit to personally view your product? It's harder than you might think to envision stuff on the Web.**

We don't have a show room which is a cost savings to all. We do offer a 30 day money-back guarantee. Or if you'd like, we could meet at my office in Menlo Park and talk in person.

---

## "Purchasing: visiting our other customers"

**Do you have any customers in the Seattle WA area so that I can look at your product?**

I cannot give out customers' names, sorry.

---

## "Purchasing: Sales in foreign countries"

**Do you have a supplier in Australia?**

No, sorry. All sales are direct from us in California. We can ship to you for about \$200.

---

## "Purchasing: Grip Clip dealers in Australia"

**Where can I buy grip clips in Australia?**

We do not have any dealers there yet. We can send them to you via UPS.

---

## "Purchasing: replacement parts"

**Can replacement parts, such as the covering and Grip Clips, be ordered?**

Yes, you can order [replacement parts](#): poles, hubs, connectors, 12" stakes, extra fabric, Grip Clips. You can also order accessories: sticky-backed velcro to attach almost anything to your dome, liners for both shelters and greenhouses, net doors, porches.

---

## "Purchasing: Replacing the covering"

**Can replacement film be purchased for the gro-domes should the original be damaged while the frame is still viable?**

Yes; replacement covers are 80% of the cost for a new dome.

---

## "Purchasing: customized, special orders"

**I would like get a [BubbleDome](#) 20', half white, half clear with an entrance on each side. Any problem?**

Yes, we can make 1/2 white and 1/2 translucent (this is not clear but like wax paper in the light it lets through). It does have 4 clear windows above the doors.

This would be a customized, special order and therefore not returnable, since it would be difficult to resell.

## "Sizes: What's your largest structure?"

**I have a pool which, with 3 ft. walkway, is about 30ft. X 50ft. I need a roof to keep leaves from the oak overhead from falling in the water. Can you help?**

Sorry, we can't help you at this time. The largest size [dome](#) we make is 30 feet in diameter. The widest [CrystalCave](#) we can make is 11' wide. We can make it in any length in increments of 5.5'.

---

## "Sizes: How many people can sleep in a dome?"

**I need a clearer idea of how large your domes are. How many people can sleep in them? It's hard to tell from the pictures.**

The 18'er can sleep 10. Check out our page which [compares the number of people it sleeps](#), square footage, relative volume, footprint, etc. of our different sizes of shelters and greenhouses. Another method of getting a clearer understanding of dome size is to mark a circle on the ground the diameter of the tent you're considering and see how many people and/or furniture can fit in it.

---

## "Sizes: GroDome 8 vs. GroDome 11"

**I'm interested in a greenhouse. I like the GroDome 11 better than the GroDome 8, but I'm concerned it might not be high enough. I am confused by the measurements. I do not want anything too big but I want to be able to stand with enough head room.**

We have a web page full of drawings which [compare the different-sized](#) domes. We think you'll find it very helpful.

---

## "Sizes: Mess tent for 15"

**I run an adventure company specializing in mountain climbing and trekking. We are looking for a sturdy, lightweight Mess Tent/ Porter shelter, big enough to sit 12 to 15 people with a table in the middle.**

Look at our [20' SolarDome](#).

---

## "Sizes: 91"x61" spa cover"

**I have a rectangular, 91" x 61" outdoor spa, that is built like a small pool (concrete tile lip around the perimeter). I need a cover. What options do you have for me for that size?**

Any of our domes over 8' would cover your spa.

---

## "Sizes: 2-person tent"

**I am looking for an easy tent set-up that I can put in my car and easily erect in friend's backyard, forest, etc, to sleep in, no more than 2 persons. Is the 8' model the best choice?**

I would recommend the [SolarDome 14](#). Easy to fit in your car but roomy and has 4 doors. The 14' has 4 doors and windows which allows good cross-ventilation. The 8' and 11' have 1 door and no windows. They are more boxy than the 14' and therefore less aesthetic, in my opinion. The 8' works well as a greenhouse and for storage. For camping, it will hold one person comfortably. You can stand up in it.

---

## "Sizes: 13 x 13 x 17 deck"

**Hello, can you give me an idea for a cover for my deck that measures 13 feet 5-inches x 13 feet x 17 feet? (I have a hot tub on my deck and would like to protect it from the wind.)**

You could fit our 14' [SolarDome](#)--it can be deformed somewhat--on your deck.

---

## "Sizes: LightHouse 14"

**What is side wall height on 14' Lighthouse?**

About 4.5'.

**Will I be able to fit 4 cots, a 40"x40" table, a 2'x5' table and a small wood stove inside a 14' Lighthouse with room to still walk around?**

Draw a circle on the ground and see if you can fit what you need in it. I would think the 18'er would work better.

---

## "Sizes: SolarDome 20 vs. HexPent dome"

**I am interested in the dome you display as a "Golf in the Rain" [HexPent dome](#). Your web page says that it is not available at this time, but makes a reference to your SolarDome 20. I looked at that, but can't tell if it's about the same size.**

**I'd like a structure that people could walk in (to find some shade or to get out of a light rain) without having to stoop much. The "Golf" dome looks perfect for that! Are you planning on selling it in the future?**

We're not planning on marketing the HexPent dome in the near future. Take a look at our [Arch Dome](#) in a [20' SolarDome](#) size, which is the size of the HexPent dome. Transformed into the Arch Dome, it has a 7'5" opening.

Arch Dome

Full size 14', 18', or 20' domes can be transformed into Arch Domes by you at no cost. Instructions that come with your dome tell you how to turn your dome into a Arch Dome. It takes only about 15 minutes and can be undone when you want your full dome back. The Arch Dome is great on a hot day or in a hot climate since the large arched opening provides for unsurpassed ventilation. It is excellent for using your dome as a display show space at a fair or other social occasion. The large opening is inviting and friendly.

---

## "Sizes: Party tent"

**We have a 20'x20' parking area where we have placed a 20'x20' frame tent for parties. I am looking into purchasing a structure, and your 18' RoofShell seems like a possibility. How tall is the 18' RoofShell? Can someone 6' tall walk under it without having to bend over? Specifics as to dimensions are appreciated!**

Our 18' [RoofShell](#) is 4' high in the center and is meant to be used as a roof on poles set in the ground or on another structure. You could use our 20' [SolarDome](#) which is 10' tall in the center.

**Do you have poles that will sit on a hard surface? If so, how high are they? Our current system is square, and stakes just off the 20x20 area support the tent.**

No, we don't. One type of support you can make is to hold the legs of the support with sand bags and guy out the RoofShell.

---

## "Sizes: SolarDome 20 holds 25 people"

**I need a tent with enough room to hold 25 people, all either sitting in a circle or up dancing in a circle ...with good ventilation....for day use and rainproof.**

The [SolarDome 20](#) will hold 25 people, sitting or dancing. Set it up in the [Open Arched](#) Form with the other two doors open.

The [SolarDome 30](#) will hold 25 people dancing with abandon. Again, set it up in the Open Arch.

---

## "Sizes: Taking the dome on an airplane"

I plan to take a SolarDome 20 to Australia for traveling about. How large is it, packed up? Would it be considered oversized baggage on an airline?

The SD 20 comes in two packages, one 64"x12"x12" and the other 36"x18"x18". It would not be considered oversized. You can check it as baggage.

Find the package size, package weight and door size of different domes on our [comparison](#) page.

---

## "Sizes: GroDomes"

I am considering purchasing one of your GroDomes. Could tell me the size of the one that appears in the photo on the [GroDome](#) information page on your website? It's the photo with the woman standing in front of the dome wearing kneepads. This will help me determine what size I need. Thanks!

That is our 20' GroDome.

---

## "Sizes: Earth 2 domes"

I am a big *Earth 2* fan. What type of tents were used in the production of that show?

They used our 18' and 20' SolarDomes.

---

## "Sizes: 30' Yurt Dome I-seminar facility"

I am interested in purchasing a geodesic dome for use as an "outdoor" seminar facility. I need a structure with an area of 200 sq. meters. The structure will serve basically as a shade tent: the material covering the unit needs to be highly reflective.

Would our [9m \(30'\) dome](#) with [White and Black covering](#) work for you?

---

## "Sizes: 30' Yurt Dome II-revival tent"

The Christians in Jamaica are in need of a revival tent that can hold 500-800 people.

Our [30' Yurt Dome](#) would hold 100-150 people, seated. If you transformed it into an [Arch Dome](#), it would be open on one side and you could extend the seating back further.

---

## "Uses: Beach cabana"

Does your company manufacture small beach cabanas to block out sun or sand on windy days. It's almost like a half of a tent. Totally closed on one side and wide open on the other.

Look at our [half domes](#). We can make these out of our white and black sunshade covering which blocks 100% of UV protective. An even smaller cabana would be our [10' Bubble Dome](#) set up as an [Arch Dome](#).

---

## "Uses: Car shelter"

I am looking for a canopy or shelter for parking my car. Do you make anything that would serve as a small shelter for a car?

Look at our [ArchDomes](#) and our [CrystalCaves](#).

---

## "Uses: Construction"

**I'm interested in using your coverings and grip clips on a construction site. My thoughts are to use your clips with some poles and guy lines to hold it in position. Ideally it should be about 50 X 100'. Is this practical?**

Our woven fabric, which is 6' wide, can be sewn into tarps, but we recommend you buy one readymade. Or you can [join tarps together](#) (or our fabric) with our [Grip Clip tarp fasteners](#) to create a larger size. The wind loading on a 50x100' tarp would be high.

With poles, guylines and Grip Clip tarp fasteners you can create good protection for a building under construction. Grip Clips are versatile: you can create the size and shape of covering you need for a particular job, then disassemble the covering, and use it on the next job.

---

## "Uses: dog exercise run"

**We run a boarding kennel for dogs and are looking for some way to cover the areas where we exercise the dogs so that we can continue to use them in inclement weather. We get a substantial amount of snow in the winter.**

You would have to remove the snow either manually or by melting it off as it accumulates. The latter method is the easiest but this means you would have to heat it. An alternative (and the most sensible) method of covering the run would be to attach poles or 2x4's to the fence on one side extending above the fence top to create high anchor points and then attach a tarp or tarps with [Grip Clip tarp fasteners](#) over the entire run. You can also use Grip Clips to [join smaller tarps together](#).

---

## "Uses: Dog house"

**I want to make a dog house dome. Maximum size: 5 1/2' in diameter.**

Look at our [GroRow 10](#). Transformed into the taller, wider size (4' tall, 5'6" wide, 5'6" long), it would work fine as a dog house. Use your own stakes to anchor it or buy some [stakes](#) from us.

---

## "Uses: Emergency shelter"

**Can these be used in cold weather, or does the fabric get brittle? We are interested in having an emergency shelter available at a reasonable cost. Your price is reasonable, but how about durability in midwest climate?**

The [fabric](#) that most of the dome is constructed of does not get brittle in the cold. However, the clear vinyl windows can become brittle in extreme cold. If you plan to use the dome in extreme cold, we recommend that you order it with translucent windows made of our woven ripstop greenhouse film, rather than with clear vinyl windows. The translucent greenhouse film lets through more light than glass, but images cannot be seen clearly through it. It's like looking through wax paper. Looking through the vinyl windows is like looking through glass.

---

## "Uses: Fishpond cover"

**I have a 16' diameter fishpond. I have one very curious Maine Coon Cat who is uninterested in this fishpond in the temperate months, but once the vegetation around it dies back for the winter, he desires to be in it! Our Maine Coon weighs 28 lbs, so whatever covering is incorporated needs to be ripstop, at least! I think if it has a decent height, he will move onto other things. We also have large dogs, so whatever structure we anchor over the fishpond must be tall enough to discourage them from walking onto it too.**

**I need something that will encompass 20' in diameter with at least a height of 4-5 feet. If you have something available asap, I would appreciate knowing...my cat would like to go back outside!**

Take a look at our 18-foot SpaTop, \$425 + Shipping \$35. You can find this information on our web page, "[Spa and Jacuzzi Covers](#)."

---

## "Uses: Ice fishing"

**I'm thinking of using a dome for ice-fishing.**

Most people order the 10' [Bubble Dome](#) for ice-fishing, but the 8' and 11' [Solar](#) or [GroDomes](#) would work also.

---

## "Uses: Lawn mower cover"

**I have a 16.5 hp riding lawn mower with bagger that I would like to protect from the weather. Anything?**

Perhaps our [CrystalCave 9](#) would work. It's 9' x 9' x 7' high. Or the [GroRow 7](#), which is 3' wide x 7' long x 20" high. Or make a snug-fitting cover from a tarp, secured with [Grip Clip tarp fasteners](#).

---

## "Uses: Orchid shelf covering for cold weather"

**I have a collection of orchids in my screen room in northern Florida. I would like a suitable covering to put over my shelving during the colder days. I have covered the plants with fabric material to keep the wind from damaging them, but feel a solar covering would be better.**

Our translucent greenhouse fabric is a superstrong, woven, translucent, [greenhouse ripstop film](#). It lets 90% of the light through--more than glass does. It diffuses the light so the light won't burn the plants and was designed for greenhouse and solar use. It is treated with ultraviolet inhibitors, which protect it against sun exposure. The covering will not rot or mildew.

---

## "Uses: Party tent"

**We have a 20'x20' parking area where we have placed a 20'x20' frame tent for parties. I am looking into purchasing a structure, and your 18' RoofShell seems like a possibility. How tall is the 18' RoofShell? Can someone 6' tall walk under it without having to bend over? Specifics as to dimensions are appreciated!**

Our 18' [RoofShell](#) is 4' high in the center and is meant to be used as a roof on poles set in the ground or on another structure. You could use our 20' [SolarDome](#) which is 10' tall in the center.

**Do you have poles that will sit on a hard surface? If so, how high are they? Our current system is square, and stakes just off the 20x20 area support the tent.**

No, we don't. One type of support you can make is to hold the legs of the support with sand bags and guy out the RoofShell.

---

## "Uses: Pool cover"

**I'm looking for a covering for my circular pool~25'--your 30 footer is nice but much taller than I need.**

[Our Spa Top 25'](#) is 6' high.

---

## "Uses: Privacy screen"

**I live in the city and have a rooftop garden. My problem is I live near an "L" train and I'd like more privacy from the passing passengers. I'm looking for a material that does not block light but blocks vision and at the same time offers some protection from wind. My idea is to stretch the material in approximately 6' x 8' panels to form a fence.**

I think our [translucent greenhouse covering](#) would work for you. It's like looking through wax paper. It lets through 90% of the available light but you can't see images.

Shelter Systems greenhouse covering is made by taking a special plastic copolymer and stretching it until it becomes stiff. At this point, the material is at its maximum tensile (pull) strength. It is then sliced into thin strips and woven into a fabric. This gives it amazing tear resistance. The fabric is then laminated on both sides with some sheets of the same stretch-strengthened material and is thereby stabilized and super strengthened. You cannot tear it. Shelter Systems coverings incorporate UV sun screen inhibitors to help block damage from the sun and give the covering a longer useful life.



It comes 6' wide, in any length, and costs \$5 per yard. We can sew or heat-seal wider widths for an additional \$1 per yard of sewing or \$3 per yard of seaming. For an order under 20', add \$10 for shipping and handling. For over 20', shipping costs increase.

You could attach the covering to some poles using [Grip Clips tarp fasteners](#).

---

## "Uses: Revival meeting tent"

**The Christians in Jamaica are in need of a revival tent that can hold 500-800 people.**

Our [30' Yurt Dome](#) would hold 100-150 people, seated. If you transformed it into an [Arch Dome](#), it would be open on one side and you extend the seating back further.

---

## "Uses: Sails"

**I'm interested in the [woven ripstop fabric](#) used for greenhouse coverings and tarps. The intended purpose is to make sails for sailboats. I refurbish old boats for scout troops but sail fabrics have historically been cost prohibitive and do not hold up well under the vigorous use (abuse) of these energetic sailors. In what quantities would I have to purchase the clear woven poly fabric, and in what standard widths does it come? Are sample swatches available?**

We don't have experience using our fabric for sails. However, we believe the fabric has the right properties to make a good sail: It's stable on the bias (it doesn't stretch) and has a stiffness (a "stiff hand") which is ideal for sails (it won't get baggy). It can be sewn. You could attach it to the mast by sewing a sleeve or with [Grip Clips tarp fasteners](#). You could attach it to the boom with a Grip Clip. It is 6' wide, available in any length, costing 85 a yard + shipping. We can send you a sample.

---

## "Uses: Seminar facility"

**I am interested in purchasing a geodesic dome for use as an "outdoor" seminar facility. I need a structure with an area of 200 sq. meters. The structure will serve basically as a shade tent: the material covering the unit needs to be highly reflective.**

Would our [9m \(30'\) dome](#) with [Silver and Black covering](#) work for you?

---

## "Uses: Spa cover I"

**I have a rectangular, 91" x 61" outdoor spa, that is built like a small pool (concrete tile lip around the perimeter). I need a cover. What options do you have for me for that size?**

Any of our domes over 8' would cover your spa.

---

## "Uses: Spa and deck cover II"

**Hello, can you give me an idea for a cover for my deck that measures 13 feet 5-inches x 13 feet x 17 feet? (I have a hot tub on my deck and would like it to be protected from the wind.)**

You could fit our 14' [SolarDome](#) (it can be deformed somewhat) on your deck.

---

## "Uses: Sweat lodge"

**I am interested in using one of your domes to construct a "sweat lodge" that is portable and can be moved...it would need to be big enough to fit 12-15 people sitting in a circle. Would you use a different heat resistant covering?**

I would think the [14' SolarDome](#) would be the best size. You would want to make a blanket liner and hook in inside to hold in

the heat and protect the dome from the heat. You could use [Grip Clips to fasten](#) enough blankets together to make the liner or you could sew them. You would need about 33 Grip Clips to attach the blanket liner to the inside of the dome.

---

## "Use: Swimming pool house"

**Could one of your domes be used to cover an in ground pool? What temperature would be achieved without heat on a sunny day with a temperature of about 40 degrees F?**

Yes it could. My guess would be about 80 degrees. The [GroDomes](#) are great collectors of solar heat. The translucent covering lets in 90% of the available light, more than glass. How warm it gets in the GroDome depends on the amount of sunlight, the clarity of the air, and the amount of wind. In addition to collecting solar heat, the dome shields the pool's surface from cooling winds and also reduces evaporation from the pool, which would otherwise cool the water. An additional benefit is you don't have to clean your pool as much because the dome keeps leaves and dirt from getting in. People with rectangular or square pools get GroDomes and those with lap pools buy [Crystal Caves](#). We can custom-make you [a longer CrystalCave](#).

**Would the dome be able to support snow?**

No, you would have to keep the snow melted off. However, if you are heating the water, most likely the air temperature above the water will cause the snow melt to slide off. If that isn't adequate to melt the snow, you could also heat the inside, but only when it is snowing to keep your fuel bills as low as possible..

---

## "Uses: Telescope shelter"

**I live in the rain forest of British Columbia and am looking for a shelter which will protect the telescope and me from the elements. We have torrential downpours, even in the summer, and quite high winds so have you a shelter that will anchor securely and yet be able to turn on a track, as the only place that I can set up the dome is on my deck. The ideal diameter at the base would be 9ft and a height of 8ft in the middle. Hoping that you can come up with some solution to my problem--my telescope is an 8" Schmidt- Casgrain,fully computerized.**

Look at our [10' StarBubble Dome](#). If you were to build a secure turnable track, you could then attach the dome to it.

---

## "Uses: Long-term temporary shelter"

**Which shelter would you best recommend for long-term temporary shelter for a family of six?**

For a family of six, a minimum of three 18' or 20' [SolarDomes](#) would be a comfortable space: one for a common room and two for bedrooms. The 18' is 254 square feet and the 20' is 314 square feet.

---

## "Uses: Toy display"

**I'm looking for a small dome that I can set up inside shopping malls and at State Fairs to demonstrate the unique flying ability of a new toy pet that I am marketing. I want it to be clear (see-through) to attract the attention of people outside it, but high enough to allow kids and adults to interact with the pets, without risking UFO pet escapes.**

Look at our [BubbleDome](#) 10 and 14.

---

## "Uses: Big 'turtle'"

**I am looking to simulate a big 'turtle' in a temporary dome structure. Ideally put up in 6-8 hrs, or less. Could graphics be applied? Could it have several doors for egress? 35-40 ft unit.**

Look at our [30'er](#). Sets up in one hr. with 2 persons. You can paint the dome. It has 8 doors.

---

## "Uses: Wind barrier"

**I am looking for a wind barrier for a back yard for sun bathing. I want something with no roof, with sides only. Do you have anything with one side or more that I can block the wind with, and take down after use?**

Our [Wind Walls](#) are tent structures that block and stop the wind. The "Arch" Wind Wall Tents are sections of our GroRows and Crystal Caves. You can put them up in about 15 minutes. Stakes are provided for securing them to the ground.

Or you could make a wind barrier by attaching some material (tarp, etc. or one of [our fabrics](#)) to some poles using [Grip Clips tarp fasteners](#).

---

Also look at: [Additional Email Questions Answered](#)

Questions? E-mail us at [shelter@best.com](mailto:shelter@best.com). Please feel free to call or write us anytime. Shelter Systems-OL, 224 Walnut St., Menlo Park, CA 94025. FAX 650-323-1220 Phone 650-323-6202.

[Shelters](#)

[Greenhouses](#)

[What's New?](#)

[Gillis Designs](#)

[Stories](#)

[Q's & A's](#)

Shelter Systems © 1996 - 2003 All Rights Reserved

[Shelter Systems' Home](#)



Shelters

Greenhouses

What's New?

Gillis Designs

Stories

Q's & A's

## Additional Email Questions Answered

---

The categories are **Accessories, Anchoring, Climate, General, Miscellaneous, Parts & Components, Purchasing, Sizes, and Uses**. We list the subject of each question-and-answer, in quotation marks, at the top of each entry. Some questions fall into several categories and are listed more than once.

---

### "Parts & Components"

**Can you section the domes poles to make a smaller package.**

We have produced an 18' Yurt Dome for a group of Yellowstone packers (photo attached) with sectioned poles so they could fit the poles into there pack horse packs. We sectioned the poles and added a "bell" to half of the sections so they could quickly be pushed together when they assembled the tent (see attached photos). They were pleased with the way it worked out for them. This will add some cost to manufacturing.

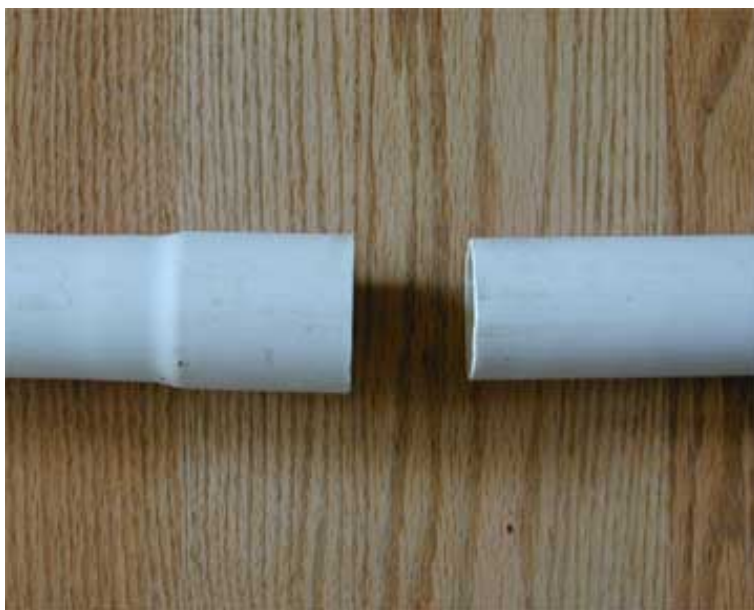

### "Burning Man Festival"

**I am interested in purchasing a large yurt dome for the 2001 Burning Man Festival. I was wondering if you had any occurrences of domes falling down due to the wind of the 2000 BM. I remember seeing a few of your domes, and as I remember, they fared very well in the 60+ mph wind that we experienced.**

I did not hear of any of our domes failing at Burning Man last year. We were there for the wind and we plan on adding to our

site a whole section on dealing with wind at burning man in a month or two. So stay tuned.

**Also, I was wondering if you have a catalog that you can send to me. I was hoping to show it to other members of our group that are going so I can get some money out of them as well.**

Our current catalog is compleatly web based at this point. I will send you an old catalog; note that it does not have all our products and you will have to rely on the web for current pricing.

**We bought a \$400 tent last year and staked it down with rebar, and had some of the poles break, as well as some of the anchor rings. As you can imagine, it was quite disappointing. We also had our shade structure go down on Thursday of the event, which was not quite a surprise, but the wind actually bent 2 of the metal poles that came with the shade.**

---

## **"Comments" "Greenhouses"**

VERY impressive. I think I've found a great alternative to the run of the mill greenhouse structure!

---

## **"Climate"**

**Hi, we're interested in two separate shelters--one thirty foot and one twenty foot. Our questions: how comfortable would they be without liners in 20 degree weather (we're in Mendocino at 2,200 feet)?**

Liners are nice and worth the price but you can keep warm with out them.

**Is there a humidity difference? (one is by a creek and one is higher, on a dryer meadow).**

No.

**How does the liner work with windows and doors**

The liners have the same windows and doors as your dome.

**(esp. if you use insulation between)?**

You would not add insolation were there are windows.

**If we used a wood stove, how much gain in temperature would the liner give us?**

I do not know what the exact degree of gain would be but I would guess at 1/3 to 1/2 increase.

**How much light does the liner cut out?**

The liners cut the light in about half. There is still a lot of light

**Can you get a porch for the 30 ft?**

Yes, it is the same porch.

**I assume you can for the 20 foot.**

Yes.

**Since we're right here, can we pick up them up at your factory and save shipping and handling?**

No; having people come to pick up slows production to much; but if you are very close by we can ship for 1/2 price.

**Also, can we see one set up? (I gather you don't have a showroom, but I'm wondering if in fact you do have one set up.)**

No.

**How long does it take after one orders to receive it?**

We have 20s and 30s in stock.Say about 4 to 5 days.

---

## Climate"

**I AM INTERESTED IN YOUR 20 FOOT. WILL THE COLD MAKE THE PVC .HOW WELL WILL IT TAKE SNOW**

It will not hold much snow with out heat to melt it off. Extreme cold will stiffen the PVC poles some but the dome is till use able (do you plan to put it up and down a lot in the cold? If so I would order it with out the vinyl windows as they are stiff in the extreme cold.

---

## "Comments"

**It was a pleasure to hear from you some few weeks ago. I promised to sent you some pictures and feed back about the tents, I am sorry for the delay but do not worry because you must feel proud to manufacture such high quality product. The people who are really using the tents likes so much. I have seem the tents around the all country and all the people are very satisfied with the tent's us**

---

## "Uses"

**Can you please tell me the difference between your " Survival and Preparedness Yurt Dome Portable Shelters and Tents" and your other lines? - or is it (are they) really just one of your regular lines under an au courant name?! Looks good - I'm interested - under any name! Thanks. Ken**

Mostly their are differt names for the same structure. Sometimes they different in what the covering is made out of.

---

## "Miscellaneous"

**Hi**

**I have a boat which is 42 feet long, 14 feet wide. When on the ground for Winter Storage it is about 18 feet to the highest point from the ground.**

**I generally build a ridge pole running the length of the boat out of 2X4's using 2X4's for legs about every 10 feet. This ridge pole is about 6 feet off the deck and a tarp is draped over it covering the boat for the Winter. Due to wind and snow loads the tarps generally last one or two seasons.**

**I am wondering if you make a structure that would enclose the boat either from the ground or from the deck up and if the costs would be worthwhile in the long run.**

**Thanks  
Pete**

Hi Pete

We do not make a structure the size you need but from you letter I can make some suggestions that may increase the life of your tarp substantially. First suspend the tarp under your 2x4 frame using our Heavy Duty Grip Clips. This will prevent the tarp from rubbing and wearing on the frame when it moves in the wind. It will also prevent heat build up where the tarp traps the sun's heat between the tarp and the 2x4s. This heat accelerates the rotting of the tarp at these points. Try to buy a tarp that is UV stabilized for a long sun life. Next make sure the tarp is pulled and kept tight using enough Grip Clips to pull it tight; check it out in high wind and tighten it if necessary. A lose tarp flaps in the wind and the flapping causes the tarp to degrade and fail. When your tarp does wear out the Grip Clips can be removed and appalled to a new tarp.

## "Miscellaneous"

your more than welcome to add my name to your list. I've been researching Aleut Kayaks and Inuit Style kayaks, and maybe i would like to use your [4 hr Kayak](#) method and then make one out of skin.....peace

> >dear sir:

> >thank you for the sharing such an ingenious and practical kayak, with  
> >the total cost of 22 dollars and the little girl lifting it over her  
> >head! it's amazing what one can accomplish with the basic tools and  
> >resources in our environment. i had to laugh at myself, i spent 800  
> >dollars on a second-hand kayak and it weighs 60 lbs(i dare not to  
> >attempt to lift my kayak by myself, i need assistance to carry to the  
> >water each time),.....your idea is very practical and economical....hats  
> >off to you! p.s...you can guarantee I'll book mark your website.

---

## "Miscellaneous" "Kayak"

**Subject: Stick Kayak;** Hi. My name is Andy, from Boy Scout Troop 67. Last week at summer camp, we had to build our own boat/canoe/kayak and race it. We jumped on the Internet and found your plans. We had the most impressive boat out there! (We placed first too!) I just wanted to thank you for putting this design out on the Internet! -ANDY

---

## "Miscellaneous"

I am fascinated by your products... Did you design the "oval interntion" tent. Used to have one and was great. Hope your business is going well. L.C.

Yes.

---

## "Miscellaneous"

I would like some details on the 4.5' high 14' across wind wall.  
I want to use it on a Beach for sun in the winter and also a wind break. How heavy is it

About 15 lbs.

**and is the material clear for sun penetration.**

We make Wind Walls of of the White Yurt Dome covering, the Translucent Greenhouse covering, or the White/Black sun block covering.

All Wind Walls are by special order only.

**How is the structure held up?**

The top poles form a ring which is held up by the upright poles. Stakes are included and guy lines.

---

## "Miscellaneous"

**Can you use grip clips with tyvek to make a light weight tent? If so what size of clip would you use?**

**Robinson**

Because Tyvek is stiff and yet thin both the Light Fabric and the General Purpose will work. The GP will allow you to join more layers but is heavier than the LF. I would try to use the LF.

---

## "General"

**Hi,  
Thanks for the information,  
Do you have wood stove vents for any of your shelters?  
Don**

We do not supply stove vents but suggest that the user roll up a door (there are 4 and shingle in a section of plywood and then use regular stove pipe fittings.

<http://www.shelter-systems.com/lighthouse-manual.html>

---

## "General"

**Hi Bob  
I have sent Japan your website and They have informed me that they are interested in  
air inflated tents. Now I have check the web site myself and I have not seen any on the page.  
Do you manufacture and Air Inflated Tents??**

regards

shin

No. Air inflation is not reliable with out a reliable means of inflation. It is interesting Shelter Systems Geotensic Structures behave like inflatables in that they are resilient and can spring back if hit by an extreme load.

---

## "Miscellaneous"

**I noticed the black/white tent material you had on your web page and I was looking for a 76"x42" strip of material that would block 100% of vis and UV light for a dark room. Is this something you might be able to help with?**

**Thanks!  
-Elliott**

Although our black/white blocks 100% of light I am not sure if it would be suitable for dark room use. There may be an occasional pin hole. Perhaps you could block any pin hole leaks with back tape of a dab of paint..

---

## "Uses"



### **Will this work?**

What do mean will it work? If you mean will it hold the sign above the dome: I'm not sure. The sign looks big. How heavy is it. Wind on the sign may be a problem also. It would be best to find this out experimentally. I would make the sign as light as possible, attach it to the dome at pole intersections at the top of the small triangles (the dome is strongest at these points) and have flaps in in the sign to let strong wind blow through or make the sign of a mesh that allows the wind to flow through it. With a light wind porous sign it should work.



---

### **"Purchasing"**

**I was sent your site by a friend and am very interested in your products. Do you have a distributor who is in Australia?**

**Diana**

No.

**Can we get these here?**

Yes we ship UPS Air out of country.

---

### **"Sizes"**

**What is the weight of the 20' diameter yurt?**

**Thanks**

**Tom**

70 lbs divided into two 35 lb packages, one for the poles one for the covering.

---

### **"Comments"**

Just wanted to let you know that we purchased two of your domes to use as dining tents on our treks in Bhutan. They were a HUGE hit with our clients and our local trek staff as well. The trekkers came to call the 20' dome the "Taj Mahal" and enjoyed luxuriating in the roomy interior. We did have one gusty day that lifted the dome off the ground (our staff hadn't tied the guy lines tightly enough) but other than that, they held up extremely well. If you are interested in any photos, we hope to have some up on our site in the next few weeks. Look at our site and go to the Bhutan section (go to Asia first, then to Bhutan). All the best! Brent Olson Geographic Expeditions

Dear Henderson

---

### **"Uses"**

**Has there been any comment on whether the 30 foot domes are attractive for weddings? What kind of wedding party would they best suit?**

They have been used in weddings. I suggest that weather permitting that you have it set up in the Open Arch form

(<http://www.shelter-systems.com/arch-domes.html> ).

**Can two 30 foot shelters zip together to form a larger auditorium and where most people are still able to see each other.**

Two set up in the Open Arch form can be joined at the arches.

**Also may the tent poles be purchased separately from the tent and fittings? I live in Auckland, New Zealand, 3000 miles east of Australia. Rather than freight them from the US it might be easier to get the poles here.**

You can save 10% off the price of the dome and of course the cost of shipping the poles if you provide your own poles.

---

## "Uses"

**Hi -- I'm looking to have a sweat house ceremony in the next few weeks and was wondering if you thought one of your yurts might be an option for that kind of an endeavor and if so which one. Does the material stand up to high internal temperatures (130-140 degrees F) and high humidity?**

Yes.

**Does the structure stand on its own without the material if we opted to use another material for the sweat lodge ceremony,**

No.

---

## "Greenhouses"

**Hi**

**My name is Michelle and I am VERY interested in buying one of your greenhouses. It is the best deal and quality I have seen since I began my search for a greenhouse. My specifications are that I live in a rented space therefore it can not be permanent and I think is zone 8 here in Seattle. My deck is around 400 square feet and I am interested in using 1/2 or 1/4 of it for a greenhouse. I have many tropicals and frost tender plants inside that I would like to grow in the greenhouse along with spring germination of seeds. I guess my questions would be how low of temperature does the greenhouse get at night,**

It can approach the outside temp if there is no sun for days.

**should I use an alternative heat source,**

Yes if you need to. The only way to tell is watch it or use a thermostat.

**and how small is it to store in the summer when I want all my plants outside???**

Tie all pack up small. Two duffel bag size.

**I am interested in the GroRow, GroDome and lighthouse. I also rent a 200 square foot garden plot in another location and the GroRow would work there also. What would be the beneficients of having the Grodome or lighthouse instead??**

You can not grow in the lighthouse.

---

## "Uses"

Hello,

**I would like to build a 20 foot round straw bale house on some desert property that I have and have been thinking about a custom-domed roof for it.**

**I need ultraviolet , and water-proof protection for long-term use. Do you have these materials, and can you give me an estimate on price? I would also like to know if you have any ideas for attaching the roof to the straw bales.**

**Please let me know. Thank you very much.**

**Sincerely,**

**Dale**

Sounds like a great idea. Our 30' roof shell would work, being about 23' in diam. Our covering will last about 3+ years or much more if you shade it. You could attach it by running a cord from the clips (there are 20 base clips in the 30'er) down the bales and staking it to the ground or the bales.

Let me know if we can help.

---

## "Comments"

This system is thrilling, my head swims with the possibilities thanks

---

## "Miscellaneous"

**Would you please send me a catalog.**

We have had a small color catalog in the past but in order to produce a catalog that would have any where near what we show online it would be cost prohibitive, we therefore encourage you to rely on our web catalog. We also put our complete manual online for you to look at.: <http://www.shelter-systems.com/lighthouse-manual.html>

---

**Dear Shelter Systems Folks,**

**I have a couple of questions about the 30 ft solar dome yurt. How many doors does it have?**

Eight.

**is it possible to get more windows with net screening in addition to net doors installed?**

No.

---

## "General"

**I wish I was in a position to purchase one of your beautiful dome kits however our budget wont allow that. We will be moving to the Philippines in the future and plan on making a dome using bamboo.**

**We were wondering if possibly your firm might be able to provide us with hubs or connectors that might be suitable for this type of application.**

**Thank you,**

**Ron**

**ps your website is really great!!!**

The connectors with out the covering will not stand. You could buy the tent with connectors and then use bamboo poles.

---

## "Greenhouses"

**I'm very interested in your 14 ft. greenhouse. Can you tell me more about the skin it's made of and how much light transmission it admits?**

Over 90%. It lets through more than glass.

I'm concerned about heating it on cold nights, too, since it's so high. What about ventilation on hot days?

Since the panels of our domes are shingled, overhead ventilation is easily attained by inserting a lightweight object (eg, an empty plastic flower pot) between several panels (two "vent tubes" are included with each dome). When the can is removed, the panels snap shut and are watertight. For maximum ventilation the walls themselves can be rolled up, transforming the dome into an Opened-Arch Form.

Can one or more of the panels be rolled up when it's hot? Thanks for any information. Can I get a catalog? Please rush. I need to buy soon.

We do not offer a hard copy catalog at this time. Please look at our online catalog: <http://www.shelter-systems.com> If you have any questions, please do not hesitate to ask.

---

## "Comments"

**An informative and well constructed website. Appreciate the carefully presented information and pictures. Your questions and answer component is very helpful. As an emergency response planner and facilitator, I will share the details of your products with my colleagues.**

---

## "Uses"

**Dear Shelter Systems, I am interested in purchasing, or having made, a tent. I plan to use it for a project I am working on, as a "Reading Tent." I am hoping to start a "Reading Road Show," I'd like a tent large enough to hold 25 or 30 kids.**

Great idea. I would recommend the 20'er.

**I wonder if it could be made with pockets inside, and then if it would be strong enough for those pockets to hold books.**

This would be easy for you to do.

**I would like it to have an awning over the entrance if possible.**

Look at our porches.

**I'd like it to be red and black in color and festive in design.**

We have white and white/black, no red. You could paint some of it or cover some of it with red cloth. You could also attach flags to make it festive.

**I also envision it to have a window, large enough to serve as a puppet theater on the inside, also with an awning or some type of shelter around it on the outside for the puppeteers.**

Perhaps a 14' SolarDome with it set up in the open arched form.

---

## "Burning Man"

**I am trying to find out if your 30' Yurt Dome shelter could be adapted for use at the Burning Man festival in Black Rock Desert, NV.**

**Conditions at the festival are extremely hot and sunny, with no available shade, but also fairly windy. Even with the sun**

**shade, would we be able to keep the dome shady in 120 degree blistering sunshine?**

With enough sun shades; I would get at least 3.

**I know that your website says an all-black dome would be too gloomy, but what about a completely checker boarded black and white dome?**

That would be interesting.

**Do you think that would provide some shade, but still have enough light to use the dome for other purposes?**

Yes. I would still get a couple of sun shades.

**We were planning on keeping two large doors open for cross-ventilation, and it is okay if the dome is the same temperature as outside, but shade is very important. Do you know if anyone has used this dome at Burning Man before?**

We had sold three 30'ers for Burning Man last year.

---

## "Greenhouses"

hello i am wanting to have a greenhouse nothing too fancy but kinda like what you have to offer....i have one question though...what keeps the plants warm at night ? do you have to put a heater in there ? i understand during the day the sun hits the plastic and generates heat then but what about night ?? it still gets down to 40 here in southern indiana where i live....i appreciate your ideas.  
thank you,

Its called the greenhouse effect: the sun shines through the covering and heat up the ground and what ever else is inside it. Then at night the heat is slowly reradiated from the ground into the air of the greenhouse. This is what makes it work at night. You can increase the heat retention by adding jugs of water to your greenhouse.

---

## "General"

I would like to know if any of your tensegrity-tents are any in production or are for sale?

send your reply to;

Most of our tents are a hybrid of tensegrity and geodesics. They are a type of tensegrity. The poles will not send with out the covering.

---

## "Burning Man" & "Anchoring"

i read all your replies to wind questions & am seriously considering the option of purchasing a dome for **Burningman**--- although i want to know what is the worse case scenario in extreme winds...

It is best to take the dome down in heavy wind or at least the bottom 12 poles and then re-secure the dome.

if i used concrete stakes for the guy lines and dome anchors, i'm pretty sure it wouldn't blow away--- But what are the chances of the dome ripping in heavy gusts??? Is it more likely that the PVC will bend & buckle first (i've seen that happen on home-made domes)????

A few poles will brake and the covering could get torn in extreme winds.

Also, after Burningman, is simply hosing off the dome the best way to clean it???

I would put it up on a clean site and hose it off. Be sure to let it dry before you put it away or any little speck of dirt will mildew

and your dome will smell the next time you put it up.

---

## "Burning Man" & "Anchoring"

BUT -- the reason I'm writing is that I saw at least two other of your domes that looked to be the same size that were STILL INTACT at the end of the event (and there's a rave on the **BMAN** web site about a 20' dome which survived) ... which makes me think that we're doing something wrong with staking or guying. (The failure seemed to occur primarily at the point where the small bungies attached the female PVC pieces to the structure.)

I'd really appreciate your thoughts.

One thing we noticed at Burning Man was the wearing out of base clip cords where people were staking their dome with re-bar. This happens because of the wind pushing and pulling on the dome, causing the cord to rub up and down on the ruff re-bar (like a saw blade) there by cutting through the cords. The way around this is to tie the base clip cords to the re-bar with sections of 3/8" or thicker cord. (The clip cords are only 1/8" and are designed for the plastic (not ruff) stakes we provide)

---

## "General"

white fabric: uvB=0% transmission  
uvA=0% transmission  
visible light transmission 25%

greenhouse fabric: uvB=59% transmission  
uvA=68% transmission  
visible light transmission=84%

---

## "General"

Our tents have done well in 30 mph winds. However winds can be considered moderate or strong but then gust in the extreme. Anchoring is important.

---

## "Miscellaneous" "Kayak"

4 hr Kayak

To make a stronger boat you can cover the frame with heavy coated nylon or vinyl. You can also make the frame of thicker wood. Silicone rubber can be used to seal the gathering at the stern and bow by applying a generous amount between the layers before securing (this is not necessary unless you plan for the seam to be under water). This boat is intended for flat water use and not for use in white water. One reason for this is if the boat was crushed against a rock, the frame could collapse or brake pinning you in the boat and preventing you from swimming to safety and possibly drowning you. Wear a life jacket at all time.

---

## "General"

Hi, I am very interested in purchasing one of your 14 ft. domes. I would like to know if I can order everything except the pvc poles. I have some bamboo that I would like to use. Please inform me if I can order all except the poles.

Yes. For less 10%.

You should know that you will have to bend the bamboo so it should be 3/4" to 1" green or if you use seasoned bamboo it will have to 1/2" so it will bend and then you will want to put smaller diameter connectors on the dome (or have us do it for you) so that the 1/2" will fit the covering. Call if you this is not clear.

---

## "Grip Clips;

Hello,

I think your grip clip product may be the kind of thing I'm looking for, but I'd like to ask you a few questions about my specific application. I am a graduate student in the School of Natural Resources at the University of Vermont, working on a scientific research project in which I am manipulating nutrient inputs to seedlings in pots, through fertilization to the roots. (I'll study resultant physiological responses.) Because of the nutrient treatments, I need to protect the seedlings from rainfall, but they need to be exposed to more or less normal light and temperature regimes. We have some steel cables suspended already, left over from a previous project (imagine three top corner ridges of a long tent). I'd like to suspend some heavy-duty clear plastic (like greenhouse film) below the cables. It would normally hang to one side, so that it can be drawn across (like pulling across a shower curtain-tent) so we can protect the seedlings quickly when it starts to rain. I'd also attach the bottom edges to low wires so that the sides wouldn't blow around in the wind. I'm having a difficult time describing this without a picture, but hopefully you have some idea of what I mean. Obviously I couldn't use regular grommets, at least along the top ridge, because they'd leak badly.

So, my questions are:

1) Do you think your clips would perform well as the hangers to suspend the plastic sheet below the wires?

Yes.

2) How sturdy are the little hangers to which the clips are attached? Are they wire or plastic? I'm sure I'd have to use a different piece that actually slides across the wire, but I'm wondering whether your clip connectors/hangers would stand up to the tension this would create.

They should.

3) Do you think these connectors would stand up to the tension stresses that would result from both wind and rain in this situation?

Yes; you would need to use enough of them to support your cover (how big is it?)

4) Do they perform well when they are \*not\* under tension (like when my cover is pulled back for sunny days)?

Yes; once you put them on they stay on unless you take them off.

5) What size clip would you recommend?

Most likely the General Purpose; this depends on the spacings of your covering and what type of film you use.

6) If I ordered a lot (like 30 or 50) could I get a volume discount?

Yes

How long would it take to get them?

A few days at the most.

## "Comments"

An informative and well constructed website. Appreciate the carefully presented information and pictures. Your questions and answer component is very helpful. As an emergency response planner and facilitator, I will share the details of your products with my colleagues.

---

## "General"

One side of the door can be left hooked closed all the time if you do not need the extra ventilation. This is particularly nice if you're using a door pole, since it allows the door to swing open and shut easily. In strong winds, hook both sides closed. Binder clips are provided with your dome to secure the doors in wind or when a tight seal is desired. They also work well on net doors. They hold best if you overlap the door and side wall materials a little as you clip them together. If you want more binder clips, you can get them at a stationery store. To prop your door open, tuck the tip of the door pole under an adjacent horizontal pole. Of course, if you aren't using a door pole, just roll the door panel up and tuck it over the pole above the door.

Burningman read all your replies to wind questions & am seriously considering the option of purchasing a dome for Burning man--- although i want to know what is the worse case scenario in extreme winds...

It is best to take the dome down in heavy wind or at least the bottom 12 poles and then re-secure the dome.

if i used concrete stakes for the guy lines and dome anchors, I'm pretty sure it wouldn't blow away--- But what are the chances of the dome ripping in heavy gusts??? Is it more likely that the PVC will bend & buckle first (I've seen that happen on home-made domes)????

A few poles will brake and the covering could get torn in extreme winds.

Also, after Burning man, is simply hosing off the dome the best way to clean it???

I would put it up on a clean site and hose it off. Be sure to let it dry before you put it away or any little speck of dirt will mildew and your dome will smell the next time you put it up.

---

## "Miscellaneous"

Hello- I'm looking for window awnings for my 100" wide (south-facing, miserable) windows. Do you sell something that big? I couldn't tell from your website. Thanks in advance. Linda Miller

We sell kits for smaller window shades and materials (a white and black (total sun block) shade woven film that is 6' wide \$5 per yard) and Grip Clips (set of 4 for \$10) <http://www.shelter-systems.com/accessories.html> which allows you to attach poles to the cover and attach the cover to your house. You could then make your own shade.

---

## "Climate"

If the warranty is just less than 2 yrs. What would you say the life expectancy of one of your domes  
Thanks

It depends on the location the elevation and amount of sun. They can last up to 10 years in the shade. and less then 2.5 yearson at 10,000' in Arizona.

---

## "Burning Man" & "Climate"

Hi Nate

i read all your replies to wind questions & am seriously considering the option of purchasing a dome for Burning man--- although i want to know



what is the worse case scenario in extreme winds...

It is best to take the dome down in heavy wind or at least the bottom 12 poles and then re-secure the dome.

if i used concrete stakes for the guy lines and dome anchors, I'm pretty sure it wouldn't blow away--- But what are the chances of the dome ripping in heavy gusts??? Is it more likely that the PVC will bend & buckle first (I've seen that happen on home-made domes)????

A few poles will brake and the covering could get torn in extreme winds.

Also, after Burning man, is simply hosing off the dome the best way to clean it???

I would put it up on a clean site and hose it off. Be sure to let it dry before you put it away or any little speck of dirt will mildew and your dome will smell the next time you put it up.

---

## "General"

Did you receive my online order for a 8 ' a week or two ago?

Thanks

Bill

Yes, Thank you.

You can call 813-457-1153 to find out about the status of your order.

Your order will be filled in the order it was received. Most orders are shipped out within a week. We ship UPS ground. We try to keep all items in stock. If an item is not in stock it may take a week or two weeks to make it, depending on other pending orders. It takes about 3 shipping days for orders in California and 6 shipping days for orders on the East Coast. If you do not receive your purchase within three weeks, please call Redwood Devitt, Production Manager, at shipping and receiving 831-457-1153 so we can track your order for you (leave a message if you do not reach him).

Let us know how your order works for you. We want you to be satisfied with your purchase. Please don't hesitate to call us.

If you need to return a dome for repair or a refund, please make sure that it is clean and dry. If need be, hang the dome from its top clip in a room with a high ceiling to completely dry it out. Include a copy of your invoice and ship UPS to 24 Granger Lane, Santa Cruz CA 94060. To receive a full refund, return your dome in its original condition within thirty days of receipt. Special Orders are not returnable; since we do not offer them in our catalog and we would have trouble reselling them.

---

## "General"

Hi Guys

Your products look like they will meet my requirements. Since your products our based on overlapping shingles do you have any suggestions for dealing with bugs like mosquitoes and black flies. I was thinking of covering the entire structure with no-see-um screen mesh.

The shingling is under significant stress by the poles which causes the 3" overlap to be pulled bug tight at least for insects the size of mosquitoes and black flies.

---

## "Miscellaneous"

Hello- I'm looking for window awnings for my 100" wide (south-facing, miserable) windows. Do you sell something that big? I couldn't tell from your website. Thanks in advance. Linda Miller

We sell kits for smaller window shades and materials (a white and black (total sun block) shade woven film that is 6' wide \$5 per yard) and Grip Clips (set of 4 for \$10) <http://www.shelter-systems.com/accessories.html> which allows you to attach poles to the cover and attach the cover to your house. You could then make your own shade.

---

Its called the greenhouse effect: the sun shines through the covering and heat up the ground and what ever else is inside it. Then at night the heat is slowly reradiated from the ground into the air of the greenhouse. This is what makes it work at night. You can increase the heat retention by adding jugs of water to your greenhouse.

hello i am wanting to have a greenhouse nothing too fancy but kinda like what you have to offer....i have one question though...what keeps the plants warm at night ? do you have to put a heater in there ? i understand during the day the sun hits the plastic and generates heat then but what about night ?? it still gets down to 40 here in southern indiana where i live....i appreciate your ideas.  
thankyou,

---

## "General"

**I would like to know if any of your tensegrity-tents are any in production or are for sale?**

Most of our tents are a hybrid of tensegrity and geodesics. They are a type of tensegrity. The poles will not send with out the covering.

---

## "Miscellaneous" "Kayak"

**I was wandering how stable the kayaks that you built are? are they stable enough to go down rivers with?**

Yes, it is quite stable; but a mono hull kayak has advantages over an interal fraim kayak like the 4 hr kayak. If you hit a rock hard the kayaks ribs could brake and pin you in so that you would drown. We recomend that you do **not** go down a rive in a 4 hr kayak.

---

## "Burning Man" & "Climate"

i read all your replies to wind questions & am seriously considering the option of purchasing a dome for **Burningman**--- although i want to know what is the worse case scenario in extreme winds...

It is best to take the dome down in heavy wind or at least the bottom 12 poles and then re-secure the dome.

if i used concrete stakes for the guy lines and dome anchors,  
I'm pretty sure it wouldn't blow away--- But what are the chances of the dome ripping in heavy gusts??? Is it more likely that the PVC will bend & buckle first (i've seen that happen on home-made domes)????

A few poles will brake and the covering could get torn in extreme winds.

Also, after Burningman, is simply hosing off the dome the best way to clean it???

I would put it up on a clean site and hose it off. Be sure to let it dry before you put it away or any little speck of dirt will mildew and your dome will smell the next time you put it up.

---

## "Purchasing"

As I understand the information, your return policy and 1.5 year warranty do not apply to the Bubble Domes. Am I correct?

They are covered by the 1.5 year warranty but are not returnable since they are a special order; except the 10'er.

## "Sizes" & "General"

Questions about the Solar Dome:

One of the tables indicate that the height of the opening for the 20' is 7'5" for the open arch situation. Yet the photographs suggest that there is a pole running across the opening at about 5'5".

That measurement is for the "open arch" form of the dome: <http://www.shelter-systems.com/arch-domes.html>

What is the highest opening possible with a 20' Solar Dome?

7'5"

How are the net walls intended to be used? They replace two sidewalls in the 14 and 18'ers.

Are they for the open arch?

No.

Do they offer a fairly unobstructed view?

Yes.

How do the net doors differ from the net wall?

The net doors are under the doors. You can up to 4 per dome and 8 on the 30'er.

How much light does the liner block?

40%

Is it possible for one person with patience to setup a 20' dome?

Yes.

---

## "Miscellaneous" & "Uses"

I am looking for a shelter that could house a 22 foot diameter balloon. The trick is providing an entrance/exit system for the balloon while it is inflated. If you do not already have a design that could accommodate this, would such a design be possible with your technol

The 30'er made in a full sphere (<http://www.shelter-systems.com/spheres.html>) with an open arch (<http://www.shelter-systems.com/arch-domes.html>) would work I think. You would have to support the sphere with 4x4 posts set in the ground.

---

## "Greenhouses"

On the translucent, how long does it last for covering a fraim green house purpose, and how much per foot or yard? Thank you .

It should last at least 3 years in most conditions. You should shade it with a strip of wood where it contacts a wooden frame. It is \$5 yd. It is 6' wide.

---

## "Comments"

The first catalog of yours I still have in my file goes back to 1988 I'm really glad to find the website. Richard

---

## "Miscellaneous"

3/7/00 Hello,

I work for Columbia University, and we are looking to find some sort of portable structure for our softball field to house our scoring and public address table. It needs to have an opening in front to view the game and be able to put an eight foot table with chairs facing the field. We would put it behind the backstop fence.

Looking through your inventory, it looks as if your Crystal cave may work well. I have two questions:

1. Does the Crystal cave let in light?

It is very cold on the field and sunlight is important for the workers. Plus, they will need light to see what they are doing.

Order it with the translucent cover.

2. Can a door be installed in the back side? We would need one side completely open to view the field, and since that would be against a fence, would need to enter from the rear.

There is a door in the back

You should also consider the "Open Arch" <http://www.shelter-systems.com/arch-domes.html> forms of out SolarDomes or GroDomes say the 18'ers. Looks more like a softball.

---

## "General"

Can a **riser wall** built of wood be made for the 30 and 20? How would the dome be attached?

One of the problems here would be to seal the bottom good to keep out the many centipedes we are blessed with here.

Dear Ed,

Yes, a riser wall built of wood can be made for the 30 and 20. It could be attached with "eye" bolts where each of the poles normally comes down to the ground. There are 20 poles on a 30' and 12 poles on a 20'.

---

## "Miscellaneous"

I would really like to know how to duplicate that [tensegrity model](#) pictured on your site (the one made from the blue rods and wire). Last night I made myself thirty identical rods, found some string and tried assemble the thing from the picture. I tried for hours with no success whatsoever.

Use rubber bands first, then put on string. The rubber bands balance each other. If you have trouble, call.

---

## "Climate"

found: via the burningman.com site

imp: i thought the SOLAR tent **produces solar energy. does it?** If its not, the name seems like a misnomer to me -- that is the type of tent i'm looking for.

The Yurt Dome covering does catch 60% of the suns energy and it reflects 40%.

---

## "Climate"

Do any of your shelters lend themselves to a **full-time living situation**? I have been considering buying a yurt. I also live in Canada - cold in the winter.

Thank you,  
Ron

Yes, but do read our warnings that are in our online manual.

Your yurt dome could be destroyed in extreme weather and your life or safety could be at risk. In heavy snow or wind your yurt could collapse, damaging what you have or compromising your shelter. Do not rely on your yurt dome as your only shelter. Accumulated snow, must be melted or shaken off periodically. Do not set your yurt dome under a tree or branch that might fall on you. Keep all flames and heat away from your yurt dome's covering and objects in your yurt dome.

i would like to know more about permanent structures. I would love to get one of these and just live in the woods. if you have any info on permant stuff please email me

What do you mean by permanent.?We make light weight shelters that last from 2 to 10 years depending on the setting.

---

## "Sizes"

im puzzled why there are not any domes for round swimming pools i have a 21' round and would like to see a 25' dome in production that would leave a way to attache the dome down to the deck. i could see using the 30' on 27' pool. there are many **pools in the 15'-to the 24' range**. thanks gary.

The reason we up from 20' to 30' has to do with the efficient use of materials. A 25' dome would cost as almost as much as a 30'er to make.

---

## "Climate" & "Miscellaneous"

I will be photographing wildlife in south Texas for six months starting January 1st. Most of my work will involve spending long hours in brutally hot photo blinds. **Would your Half Dome with its reflective roof when placed over my photo blind keep me any cooler than a typical free standing shelter.**

I would not need one as large as the 14 footer. My photo blind is about four feet wide. Would a shelter eight feet wide give me enough air space between me and the shelter to help relieve me of some of the heat? What is the typical temperature difference between the ambient air and air under the shelter. Thanks

The 14' half dome of silver and black should help a great deal. It would provide total shade for your smaller unit. Still, you should realize that the air temp. under the half dome will approach the air temp outside. It is the shade that should protect your smaller unit from heating up more than the air temp.

---

## "Sizes"

I am in need of a dome of substantial size. What is the **largest dome** your company can build? Is it **possible to connect you domes together** to gain more height and circumference.

30' in diameter. **It is not practical to connect them.**

---

## "Uses"

can i HAVE AN OPEN FIRE IN YOUR YURTS?

No. You need to provide a way for the smoke to get out.

Will the heat that rises melt the structure or covering?

It may depending on the size of the fire. We do not recommend an open fire inside.

---

## "Uses"

I'm shopping for a shelter for my yard in which I can build a sailing catamaran. I need something close to 30'w by 45-48' long. Do you have anything like that in your line?

The best we could do is our 30' dome. You could have some of you boat sticking out and covered at one end. **It would be a wonderful workshop.**

---

## "General"

1a. Is it best to get the netting installed all the way around?

It weakens the dome to put netting all the way around. Best is to get four doors with netting.

1. Can I purchase extra material from you and **run a wall part way across the center of the dome? I would like to make it two rooms by** hanging a partial wall, to still allow ventilation and passage between the rooms.

Yes you can.

2. Is the floor installed here or at your factory? I want to put the floor tarp under a plywood floor, for moisture control.

You install the floor.

---

## "Climate"

I read in your question section that over and over you say not to rely on the structure as a main source of shelter.

and if you **built a roof structure over it to combat the snow** issue, do you think that it would work?

That should keep the snow off. [[is this feasible?]]

---

## "Uses"

Would like to **cover a 24' round above-ground pool** with a translucent **roof top mounted on 4"x4" or 4"x6" posts.**

Can you make a 25' or 26' translucent roof top ?

Will it be able to handle northern Ohio snow ?

What would the cost be ?

Thank you for your time and help.

Thanks for your interest in our Rooftops. We do make a 25'er: RoofTop 25' (Top of 30'er) \$1200 Shipping \$110. You would

need to melt or shake the snow off. Heating the pool may do this.

---

## "Accessories"

You mention that I can sew wider widths of film. Could I do this on my own sewing machine? If so, **what type of thread** would I need?

Yes. Use heavy duty cotton covered polyester.

---

## "Grip Clips;

**how much of load** the **heavy-duty grip clip is rated for** vs. the **general-purpose** grip clip (I plan to use it with at most two layers of woven ripstop film). If I use a general-purpose clip and it fails (weather too severe), how would it fail?

The difference is in how much material they grip. The HD grips about twice as much as the GP. So when your tarp is loaded, the HD will be less likely to rip out the tarp. It is the tarp the usually fails not the clip. I would recommend the HD where you can only grip at a few places on a large tarp.

---

## "Sizes"

18' bubbledome is better suited for my needs than 20' GroDome. Couple of questions concerning the bubbledome:

availability?

which floor is applicable?

is there a net door and a liner available?

since it has only one door, can a side be rolled up? and if so, is there a net wall available?

The **BubbleDomes are special order items** and are non refundable; since we get few orders except for the 10'er. It would take about one to two weeks to ship.

You would need to use a 18' floor. The floor on the 18' BubbleDome comes in at the base to about 16'.

---

## "Miscellaneous"

I need a collapsible tube approximately 6-8 feet in diameter made of some type of tent material. The tube should be 12 feet long. Can you help?

I thought you were looking for a tent pole, but I see you are looking for a tent tube. We can make our GroRow into a tube. Call and lets talk.

---

## "Miscellaneous"

My primary concern is the **durability of your product**. I work in a high performance nylon fabrication facility and I have not had the best luck with **ripstop nylon**. Why did you choose this material instead of a higher performance product such as Kevlar or a course deiner nylon.

The covering we use is **not nylon but a woven ripstop film** which is very strong. It is a high grade version of the "blue tarps" you see.

I am very interested in the construction of your poles as well. Is the **PVC** tubing really **strong enough to last for three years**?

Yes.

## "Uses"

I am looking for a dome to put over my hot tub. The tub is 5 ft. in diameter and about 3ft. high. Would the 8 ft. gro-dome be a good choice? J.

---

## "Comments"

Yes I think it would work. The best and most affordable dome system I've ever seen. I'm sure I'll be purchasing one in the not so distant future. Warmest regards from beautiful downtown Gloucester, Massachusetts.

---

## "Greenhouses"

I am thinking of **putting a greenhouse on a balcony** on the second floor of my home. The balcony is 11'6" x 3' 6". The roof begins 7' 4" from the bottom of the decking.

What would the weight of the greenhouse be? What would the cost of a greenhouse this size be? How difficult would it be to assemble 3 stories up?

The best we could fit with you is our SolarShed.

**I think the SolarShed might work out perfect. Just a couple of questions:**

1) Could I attach 2 sheds together? Since they are 5.5' long, two would perfectly fit on the balcony.

Yes you can.

2) How is the shed attached to the wall - I want to make sure that no bugs can get in the shed.

You can use eye bolts, wood slats and or other means. Bugs are hard to keep out of any enclosure.

3) The picture on the web site shows a door inside the shed. This is exactly what I want to do (the door would be the door to the balcony). But how is this possible if the shed is only 6' tall?

The door you see is only 5' high.

**So I think I have my structure choice** - 1/2 of a Crystal Cave 9. Now can I do that? Next could I lengthen it to 11' long? If that seems like a possible choice, then all I have to figure out is the covering.

The best we can do is to make you 3/2 of a Crystal Cave because of the connectors. It can also only be extended by 1/2 its length to 13.5'.

---

## "Grip Clips;

I am interested in building approximately a 32, or 40, geodesic dome to be used for a shop. I will need to have a 10, wide x 10, tall garage door and 1 personnel door. I have a large supply of lumber. My question is **does your company sell just the hardware for domes?**

We do sell Grip Clips and our Covering material which might be of use to you.

If you built a fraim you could then use Grip Clips to hang a cover under it.

---



## "Comments"

What a great website! I have been fascinated with round structures for many years. So far I only have a dome tent, but I will try to order a 20 ft Solar Dome from you this year. Then I can figure ways to get more permanent and costly round living structures in my life if I need them. Did you know that the word 'mortgage' comes from French meaning deathwish? Ciao for now.

---

## "Uses"

As to whether a dome would be **suitable as a doctor's office**: it would certainly work. We would recommend a liner for winter. The snow would have to be removed--knocked off with a broom or melted with an electric, propane, or wood heater. Our domes have been used therapeutic massage studios.

---

## "Uses"

Tonya Payne from Brisbane, Queensland in Australia and I am currently trying to track down a tent that would be **suitable for the bulk storage of fertilizer or sulphur**. Do you have any models that would be suitable for this purpose and if so do you have a distributor in Australia?

Tonya,

We believe our shelters would work fine for fertilizer or sulphur storage. We don't believe there would be any chemical reactions between fertilizer chemicals and the dome materials, which are quite inert. The 18, 20' or 30' SolarDome would be suitable.

---

## "Greenhouses"

What is the **purpose of a liner in the greenhouses**? In an area with some snow, are the liners necessary?

A liner will keep the greenhouse warmer in the winter. Whether a liner is necessary, depends on the particular weather in a particular winter.

---

## "Uses"

Hi I'm a **roofing company looking for a dome to place on a roof top so our crew could work through this winter**.

Our largest dome, the 30 foot, is about 11 feet high at the top. You could also use a smaller dome which you moved around. You would have to make sure you secured the dome so that it did not move in the wind

Another possibility is using tarps, together with the our Grip Clip tarp fasteners, to cover the roof when you are not working on it.

---

## "Miscellaneous"

Do you have any suggestions on building a small dome as a science project?  
Do you have any such small model kits? Kindly let me know.

We have a web page dealing with making paper models of geodesic domes which may be useful to you:  
<http://www.shelter-systems/modle.html>. We don't have any specific suggestions for building a small dome as a science project. We do have a page which shows the size-volume comparisons of different-sized domes (<http://www.shelter-systems/sizes.html>) and one on tensegrity and geodesic design in tent structures (<http://www.shelter-systems/tensegrity.html>).

---

## "Sizes"

I'm looking to put together a gathering of 30 - 40 people. What type and size dome would you recommend that would comfortably hold that amount of people? And **does the floor rip easy -- like if people were dancing** and walking around on it?

I would recommend the 30' Yurt Dome. The floor does not rip easy and would handle dancing and walking fine

---

## "Sizes"

I'll be needing shelter during the summer in the Central Cascades in Washington. The only catch is that I'll have to hike it in, about 4 miles or so. **What's the largest tent that a person can reasonably carry?** (I have some strong people in my party, but I don't want to cripple them either.

The 18'er comes in two 30 lb. packages.

---

## "Miscellaneous"

Has anyone ever investigated the dynamics of **building a central fire tipi style in a dome shape with central vent hole?**

We have tried that. It did not work well. You need a tall, chimney-like structure to create an up-draft to vent the smoke adequately.

---

## "Miscellaneous" "Kayak"

Reading about your woven rip-stop material I was interested in finding out more about it. **I am planning a project for a "Skin-on-frame" Kayak**, and I have been trying to determine what material to use as the skin.

I would be interested in finding out more about this material, whether you retail it by the yard or could direct me to a manufacturer or retailer, so that I could obtain spec.s or a sample or both.

Jon,  
**I don't think this material would work too well for a kayak** because, although the material is extremely rip-stop, it can be punctured or abraded. Therefore, you couldn't drag the kayak across rocks.

I made a kayak, using a regular blue tarp, green willow shoots and our Grip Clip tarp fasteners, in four hours. You might want to check out our website with many photos of the kayak construction at [www.gripclip.com/kayakassem.html](http://www.gripclip.com/kayakassem.html).

---

## "Sizes"

We would like to put a year around Yurk (**18' or 20'**) on our property near Bowman Lake (CA) at 6000' elevation. Will it handle the snow load? **What do you recommend?**

The 18' dome is stronger than the 20'. Their poles are the same diameter, but the 18' dome's poles are shorter and therefore the smaller dome is stronger.

---

## "Uses"

I intend to set up a **"web lounge" with three computers in Virginia**. The desk are plain, a top and four legs. I want the dome to be white. I want it so that you can stand up without hitting your head, with one window near the entrance. I must use a tent, so please do not waste my time telling me it is impractical, give me the specs. I intend to wrap the computers and hardware with my own materials during storms and intend to have a portable heater and dehumidifier. Please suggest an appropriate size for this

mini weblounge. Also, tell me the cost and figure in the shipping, I want to ship the tent to:

Please send me your specs for your suggestion so that when I make the purchase I can tell you what I want. [in Virginia]

I suggest the 18 foot Yurt Dome. It is 9' tall. Shipping \$40.

---

## "Climate"

regarding your **30' dome yurt**, have you done any wind/storm testing? what are the specs. I live in the **Colorado Rockies** and am looking at yurts for my mountain property. We get 60+ mile an hour winds in the late fall, and snow to 4-6 feet in the highlands. Due to dome construction I'm sure your yurts are quite sturdy, but would they withstand an entire Colorado winter without repair, etc. Also, how is the best way to heat your yurt? I didnt see any plans for a out vent for a stove? many thanks

I do not recomend our 30'er for you; 60+ winds are too much.

---

## "Uses"

Hi -- I'm looking to have a sweat house ceremony in the next few weeks and was wondering if you thought one of your yurts might be an option for that kind of an endeavor and if so which one. **Does the material stand up to high internal temperatures (130-140 degrees F) and high humidity?**

Yes.

Does the **structure stand on its own without the material if we opted to use another material** for the sweat lodge ceremony,

No.

then strip the material off the structure and put up the original material and then use the yurt as it was originally designed.

---

## "Uses"

The **14 footer** does not seem to have much head clearance in the picture on the website, although it states that it is 7 feet tall. **How much walk-around space would there be for a 5 foot ten inch man?**

It is 7' tall in the center. You would not have much walk around room; perhaps an 8' circle. How about the 18'er?

Keeping it small in Montana might be a good idea. I would love the room of the 20, but fear that it could not be heated well.

Glenn

---

## "Climate"

Ihave a 20' Solar Dome. I am going to erect it on a raised, oversized platform. I am in **Ecuador**, just east of the Andes. In this region, we get alot of brief, intermittent rains and quite a bit of heat in between. I am **building the platform** in a very shady grove **and am building a raised, inner floor** for it. It was suggested in your questions and answers that **a plastic vapor barrier be affixed to the entire underside of the platform. I'm not seeing this as making sense** because of the height of the platform

(five feet) and the raised, inner floor. All the local houses are of this "platform style" and dry quite readily due to the height of the platform.

It would only make sense if you wished to exclude the moisture in the air. It sounds like your climate is dry enough so you do not need the vapor barrier.

A friend of mine used the same type of dome in the mountains of souther Ecuador and had alot of **problems with rain blowing in through the closed doors**. In our area there is not so much wind, but I will be **wanting to keep all four doors open even when it rains**. What do you suggest in this case, to keep the rain out.

I suggest you attach a small tarp porch over the door openings with small tarps (Grip Clips may help you do this). Attach the tarp to the clips above the door and to the pole running horizontally to each side of the door. The tarp should be wide enough to protect the open door from rain. Tie the other corners of the tarp out and away from the dome to create a open porch. You could alternatively use our porches.

---

## "Uses"

Dear Sir,

I hope this email finds you well. I live in the U.S. Virgin Islands, on the island of St Thomas. I have designed and built a high performance 18" Newtonian telescope which I use to do public and private Astronomy Presentations. I am very interested in your 18' Star Bubble. Please email me a photograph of this particular unit, so that I can see if it will work for my purposes. I am particularly concerned about **how I can rotate the dome (Star Bubble) in order to access different areas of the sky**. Please send me any information you have that might be useful in this regard, as well as any other information you may have. Thank you for your assistance.

Sincerely,

Kary Williams President Star Charters Astronomy Adventures

Here is an image of a 20' Bubble. The 18' Star Bubble is the very similar but is make of our light blocking covering. The structure is free standing and can be attached to coster wheels.

---

## "Uses"

I live in an old stone house on 5 acres in the middle of 500 acres of brush and citrus groves in north San Diego County. I'm thinking that building a dome would be easier than fixing the old house. I have perused with great interest the sturctures on your web site, wondering if I should put up a 20' solar dome this summer to see how I like it, then building a somewhat larger permanent dome.

I visited a smallish dome in an avocado grove about 25 years ago. It was very open with lots of skylights and was lovely. It seems that people try to make these domes into regular houses with corners, sheetrock interiors, and small room spaces. I would like the interior very open with lots of skylights. My place is on a hill with lovely views. I'm not much worried about building codes or what the neighbors would think, because it's VERY isolated here.

So my questions is this: **If you were going to put up a permanent residence dome, who would you hire or what company would you use? Or do you do this?**

My other question is esthetic: Do you think living for the summer in a dome covered mostly with vinyl will be a good test?

Just do it yourself with the help of a couple of friends. Our domes are not made of vinyl; but yes a great idea.

---

## "Greenhouses"

interested in buying one of your greenhouses. It is the best deal and quality I have seen since I began my search for a greenhouse. My specifications are that I live in a rented space therefore it can not be permanent and I think is zone 8 here in Seattle. My deck is around 400 square feet and I am interested in using 1/2 or 1/4 of it for a greenhouse. I have many tropicals and frost tender plants inside that I would like to grow in the greenhouse along with spring germination of seeds. I guess my questions would be **how low of temperature does the greenhouse get at nig**

It can approach the outside temp if there is no sun for days.

**should I use an alternative heat source,**

Yes if you need to. The only way to tell is watch it or use a thermostat.

and **how small is it to store** in the summer when I want all my plants outside???

They all pack up small. Two duffel bag size.

I am interested in the GroRow, GroDome and lighthouse. I also rent a 200 square foot garden plot in another location and the GroRow would work there also. **What would be the benefients of having the Grodome or lighthouse instead??**

You can not grow in the lighthouse.

---

## "Uses"

I would like to build a **20 foot round straw bale house** on some desert property that I have and have been thinking about a **custom-domed roof** for it.

I need ultraviolet , and water-proof protection for long-term use. Do you have these materials, and can you give me an estimate on price? I would also like to know if you have any ideas for attaching the roof to the straw bales. Sincerely,  
Dale Barger ,Savannah, GA

Sounds like a great idea. Our 30'roof shell would work, being about 23' in diam. Our covering will last about 3+ years or much more if you shade it. You could attach it by running a cord from the clips (there are 20 base clips in the 30'er) down the bales and staking it to the ground or the bales. .

---

## "Sizes"

Could you tell me about Yurt Dome 11 and 14? **what size are the doors on the 11**

5'wide and 4.5' high

**and the 14?**

4.2' by 4.2'

---

## "Greenhouses"

**I like the shape of your crystal cave, and greenhouse,  
Can these be made with 50% shade cloth instead of material or plastic?**

No, the structures need the stability of the woven film for strength. However you can cut many large holes in the woven film between the poles and then cover the structure with the shade cloth.

My climate is not conducive to plastic, and **I need the ventilation that the**

**shade cloth allows.**

I would be interested in talking with you, I am looking for a product that I can adapt to a traveling Butterfly exhibit. This would need to be portable, and easy up and down.

Something that will withstand putting up and down on a weekly basis.

I would also need to be sure that it can be closed on all sides to prevent the Butterflies from escape!

We could **make you a special structure where in the shade cloth was sewn into the panels.**

I need the rectangular style, and I would like to be able to make it longer than the styles you show. I would like to go up to 30 feet long, and still keep the height around 7 feet! Is it possible to have something such as this?

We could go the length 33' and the height 7' but the width would have to be 9' or 11'.

We also have a 30' dome.

---

## "Purchasing"

Shipping to Greece is about \$150 for the 18' domes.

---

## "Greenhouses"

I would like to know if you have **shelving that fits into your greenhouses** to hold flats, or if you have designs for them.

We do not offer shelving but **do describe how you can make your own in our online gardening manual:**

<http://www.shelter-systems/gardening-manual.html>

---

## "Uses"

I'm looking to **enclose a small hot tub**. I live in NJ so it gets cold. I'd like to conserve electricity by keeping the air warm. Also, I'd like to have enough room for people to party inside by the tub. The tub itself is about 5 ft. in diameter. I have plenty of room in the yard. I'd like to put lots of plants around, also...

Thanks, Jim Cheadle

Look at our BubbleDome 10. or our GroDome 14.

---

[Still more Email Questions Answered](#)

Questions? E-mail us at [shelter@best.com](mailto:shelter@best.com). Please feel free to call or write us anytime. Shelter Systems-OL, 224 Walnut St., Menlo Park, CA 94025. FAX 650-323-1220 Phone 650-323-6202.

Shelters

Greenhouses

What's New?

Gillis Designs

Stories

Q's & A's

Shelter Systems © 1996 - 2003 All Rights Reserved

[Shelter Systems' Home](#)



Shelters

Greenhouses

What's New?

Gillis Designs

Stories

Q's & A's

## Instruction Manual - Manual De Instrucción

This Instruction Manual explains in detail how to erect all sizes of Shelter Systems' domes and structures, including selecting a site, assembling the dome, preparing the flooring, anchoring the dome, controlling the dome's environment, storage repair and accessories. We suggest you briefly preview the manual before you begin to assemble your dome. Note: "dome," "yurt," "yurt dome," "tent," and "greenhouse" are used interchangeably throughout this manual.

© 1996 - 2001 Shelter Systems All Rights Reserved

**Parts List:** Yurt-Dome's™ Canopy, Yurt-Dome's™ Poles, Stakes, Strings for stakes, Manual, Vent tubes, Binder clips for doors, Guy lines and Spare parts.



**Site Selection:** Carefully select a site for your yurt. A good site can make the difference between a wonderful stay or a miserable one. Take time to look around for the best drainage, wind protection, sun and shade exposure, and a level and smooth surface. Do not set your yurt under a tree or branch that might fall on you.

**Wind and Snow Warning:** Your dome is a lightweight structure, therefore extreme wind sites are not recommended. When possible, avoid exposed hilltops and narrow valleys where wind speed increases. Trees and brush between you and the wind help protect your shelter. Your dome could be destroyed in extreme weather and your life or safety could be at risk. In heavy snow or wind your dome could collapse, damaging what you have or compromising your shelter. Do not rely on your dome as your only shelter. Accumulated snow, must be melted or shaken off.



Fence



**An Earthen Floor** takes less time, energy, and money than a deck. When properly mounded and ditched, an earth floor will remain dry in the worst rains. Also an earth floor does not require insulation since no cold air can come from under the dome.

Most of us have lived our lives in a house, so living on the ground does not come intuitively to us. We think living on an earthen floor would be wet, cold, and damp. However, if you choose your site carefully and prepare the earthen floor properly, the earthen floor will be drier, warmer and always much cheaper than building a wooden deck. It requires time and effort to build a deck and make it function properly, so that rainwater doesn't flow into the dome, so it's attached properly to its foundation, and

so it's adequately insulated against cold. You need to have carpenter skills, aptitude, ambition, and/or a good book on building decks. Of course, a deck would be a better floor in some situations, such as on a very steep slope or on boulders or volcanic rock you can't easily move, or if you want to elevate the dome.

**Drainage and Leveling:** Ideal drainage occurs when rainwater can flow down and away from a raised site such as a hill top. All rain will then flow away from your yurt. If your site is in a meadow or a place that does not drain well; create small mound of earth for your yurt to sit on that is about 1' high. Slope the mound so that rain will run away from the edge of your yurt. If your site has a slope to it, create a level space big enough for your yurt. Mark a circle on the site with your shovel by digging a shallow trench. Then mark a line that divides the circle in an up hill half and a down hill half. Now move the soil that is uphill to the downhill side of your line so as to create a level spot for your yurt. Dig a 6" ditch on the uphill side so the rain can drain into it, around your floor and on down the hillside. Remove roots, lumps and rocks from where your yurt will sit. After you have walked on your floor for about three days, fold your floor in half exposing the earth under it. Take a shovel and carefully remove bumps and put the dirt in the low spots. Fold the floor back and do the other half. Do this again in about 2 weeks. This procedure will produce an earth floor that is level and comfortable.

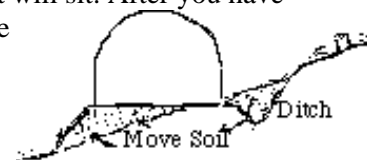

**Floor Covering:** Always install a waterproof floor covering in your dome to keep the dampness of the earth from entering your living space and condensing on your walls. Shelter Systems sells a circular, high grade waterproof floor, made from our woven film, to fit your dome with Grip Clips to attach it to your domes' wall. Plastic tarps can also be obtained from a hardware or sporting goods store and you can purchase Grip Clips from Shelter Systems. Spread the floor out evenly inside the dome. The edge of the floor should go up several inches against the inside walls. If you wish to tie in your floor, attach clips a few inches in from the edge of the floor. Thread string through one hole on the underside of each floor clip. Then thread it through one hole on the inside of a corresponding dome clip. This is easier if you use a tool like a crochet hook or a needle nose pliers to grip and pull it through. Pull tight and tie.

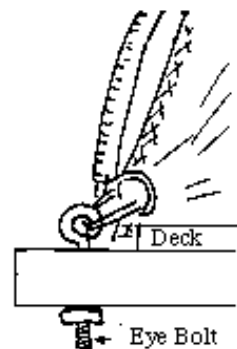

Sticky back Velcro can be used to create a tighter seal of the floor to the wall. Make sure the floor and tent covering are clean and dry before applying the Velcro. The one way to attach the Velcro to your net doors is to first secure the floor to the walls of your tent as described above. Use a marking pen to mark where the edges of the floor contacts the sides of the tent. Move the floor to get it out of your way. Now measure and cut a length of "hook" Velcro long enough to secure one of the floor's edges. Remove the protective strip from the sticky back and apply this Velcro to the underside of the mark you have made on the side of the dome. Repeat for other sides of the floor. Take lengths of "loop" Velcro and Velcro them to the "hook" Velcro that you have already attached to the sides of your tent. Remove the protective strips from these. Now carefully lift and hook your floor to the sides of the dome. Press the floor to the exposed sticky of the Velcro. Rub well to secure the bonding of the glue to the floor and the sides of your Yurt Dome.

Rugs can be placed on top of your waterproof floor.

**Decks:** There are many ways to build wooden decks. If you are not comfortable with construction, consider getting help. Some provision needs to be made to prevent rain from following the wood decking into the living space. We suggest you start by making your deck one foot bigger than your dome's diameter. Then set up the dome on your deck and position it how you want it. Trace around the perimeter of your dome onto the deck. Remove the dome and cut the decking along the line you marked, but not through the joists that are under the decking. Because poles of the repositioned dome will not align exactly with the protruding joists, you will need to cut some 2"x 6" supports for the poles to sit on.

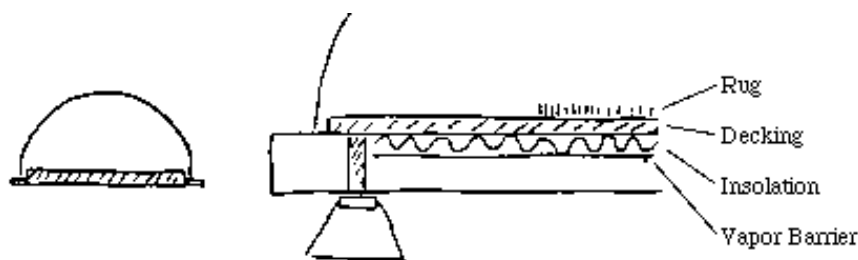
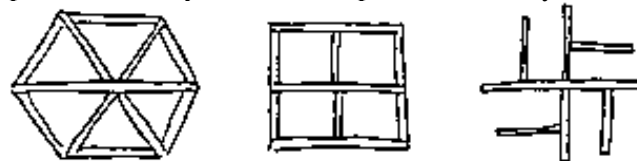

(Measure the distance between each pair of joists under the cut deck.) Now secure the measured sections to the joists. Place the dome back on the deck and anchor your dome with "eye" bolts to the 2"x 6" sections. Now, rain running off the dome will run onto the 2"x 6"s that you have attached under your deck and not onto the deck and into your dome.

Here is an example of a way to construct a deck for a 20' dome built of 2"x 6" Douglas fir and plywood. It has 12 equal sides.



The spacing for the joists is 2'. Use joist hangers. Support underneath with 4"x4"s toe-nailed into foundation piers placed under each joist's ends and several under the central joists. Extend the dome's skirt (with plywood or plastic) to the ground to block cold air from coming up under the dome. More on deck building see below.

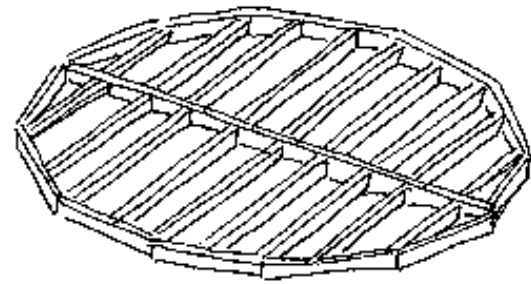

**Assembling Your Dome™: Wear eye protection and gloves for safety.** Have a friend help you the first time you set up your dome. Spread the dome on top of the floor so the dome's connectors are visible and the top of the dome (marked with a strip of fabric). Taking one pole at a time, insert into the connector at the top of the dome. Insert the other end of the pole into a connector outward from the center of the dome. Insert the next three long poles from the center outward. You should now have formed an X at the top of the dome and there should only be a little slack in the covering under the poles.

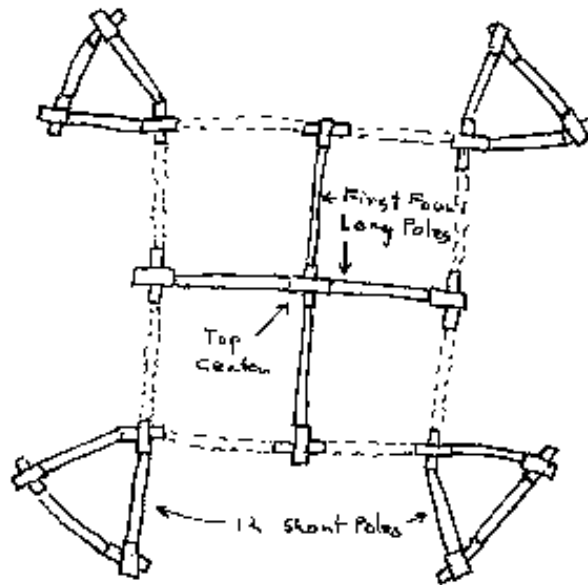

Continue to bending and inserting long poles working from the top down. As more poles are added, the canopy will become tighter requiring that you bend the poles and pull on the connectors to fit the poles in place. All poles cross making an X at the connectors.

Insert the 12 short poles around the 4 triangular "window" panels. (The 30 foot dome has 8 short poles that are just above the corner of the doors.) If you have trouble inserting any of the short poles, remove the long poles adjacent to the window panels and then insert the short poles first.

To get a pole to arch, fit one end of it on to a connector, then grab the pole in the center and pull outward from the dome. Simultaneously push the other end of the pole inward. At the same time, put this end in the next connector.

#### Tricks for tube bending:

The 18 and 30 foot Yurt Domes are the most difficult to put up. Make sure you have two strong people working on it. If you have trouble bending the poles try one or more of the following:

See attached photo; also try inserting the upper end of the pole first then the lower. One technique is to insert a leg between the dome and the pole to use the body to help bend the pole. Another is to use the lower connectors as a lever to pry the pole into it. Try having your help pull out on the middle of the pole to bend it (being careful not to pull so hard that the pole kinks) while you pull on the connector, that the other end of the pole is to go into, to stretch the dome's covering underneath the pole.



**Note when putting up your dome in the cold:** The poles of the dome are made of PVC, a thermo plastic, which gets stiffer with the cold. In putting up the dome the poles are bent and inserted into connectors. It is preferable that the domes be set up during the day when the air temperature is warmer. Poles may be kept warm by wrapping them in a blanket with several large bottles of boiling hot water. Once the poles are warm remove and insert them one at a time from the blanket. If the domes are set up in the extreme cold with out warming the poles some may break. This should not be a problem however since we include 4

extra poles with each dome.

The 8' and 11' Domes (photo below) have a different shape and "Y" connectors.

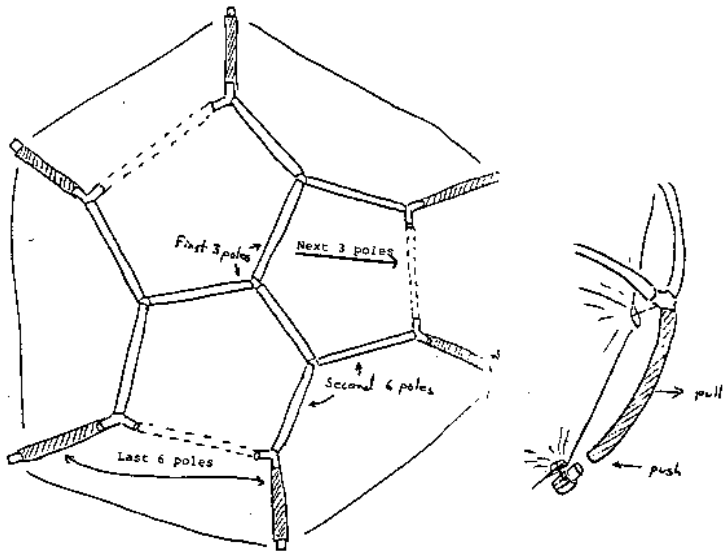

After all poles are in, turn your dome so the doors face the direction you want. Hook all the doors closed. (Leave them closed until the dome is anchored.) Your dome knows how to hold itself in a nice circle for staking out the bottom if the doors are closed.

The BubbleDomes™ are taller than our other domes and they are standard with one tall door.



The 30' Yurt Domes™ are set up as the other domes but require more strength to lift the dome when adding poles. Notice also that the 8 short poles go just above the 8 door openings.



**Doors:** The fabric strips across the threshold of the doors hold the door openings in their proper spacing. This strip can be cut after staking if it proves to be in the way. However, try to avoid cutting it since the dome's base will spring out without the strip, and if you move your yurt you will need to reestablish this spacing by moving the stakes towards each other so that your door flaps will overlap your door openings. If your door openings are adjusted to the correct width, the doors should seal without a gap when closed.

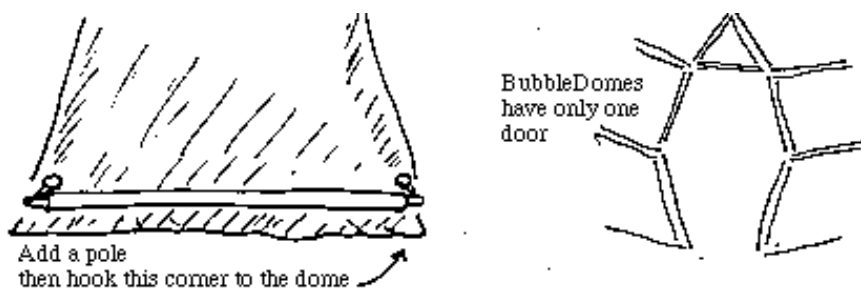

A pole can be added to the lower edge of each door to hold the door tight and make it easier to use. The door pole goes over the plugs attached to the corners of each door. One side of the door can be left hooked closed all the time if you do not need the extra ventilation. This is particularly nice if you're using a door pole, since it allows the door to swing open and shut easily. In strong winds, hook both sides closed. Binder clips are provided with your dome to secure the doors in wind or when a tight seal is desired. They also work well on net doors. They hold best if you overlap the door and side wall materials a little as you clip them together. If you want more binder clips, you can get them at a stationery store. To prop your door open, tuck the tip of the door pole under an adjacent horizontal pole. Of course, if you aren't using a door pole, just roll the door panel up and tuck it over the pole above the door.

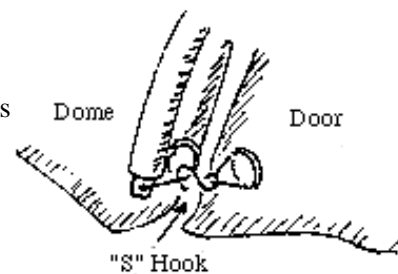

**Sticky back Velcro** can be used to create a tighter seal between the door of your yurt, dome and the wall or net door and wall or to hold the shingling of your dome tight. Make sure the door and wall are clean and dry before applying the Velcro. The one way to attach the Velcro to your doors is to first secure the door closed with the bottom clip hooks. Use a marking pen to mark where the edges of the door cover or netting contacts the sides of the tent. Lift up the door and get it out of your way. Now measure and cut a length of "hook" Velcro long enough to secure one of the door's edges. You do not need to cover the whole length of the door as this may make it difficult to open or close the door. Remove the protective strip from the sticky back and apply this Velcro to the inside of the mark you have made on the side of the dome. Repeat for other side. Take two lengths of "loop" Velcro and Velcro them to the "hook" Velcro that you have already attached to the sides of your tent. Remove the protective strips from these. Now carefully lower and hook your door on the base of the dome. Press the netting or door to the exposed sticky of the Velcro. Rub well to secure the bonding of the glue to the door and the sides of your Yurt Dome. Try not to stress the Velcro glue bond till it is set as it can take up to 25 hours to reach its maximum holding power. Be sure to attach the "hook" part of the Velcro to the wall of the dome, yurt as this way when you go in and out the hooks will not tend to get caught on your hair or clothing. You can purchase additional Velcro from your fabric or hardware store or you can order more from us.

**Anchoring:** Wear gloves and eye protection. Your dome is no stronger than its anchors, so it is important to anchor it securely. We have provided you with short cords so you can drive your stakes deep. Tie them to the base of the attached Grip Clip™ strings around the perimeter of your dome. You now have a long loop to pull out and drive your stake through. To assure the dome's edge is an even tight circle, place stakes lightly at every other pole base. Then go around pulling, tightening and adjusting the circle, driving the stakes deep after adjustment. Add the remaining stakes. If the stakes we have provided go into

the ground easily, then this type of soil requires longer stakes. Make stakes from 2"x 2" lumber with a hole 2" from the top. Logs or sandbags filled with sand or gravel work and can be buried for extra security in soils too loose for your stakes to work.

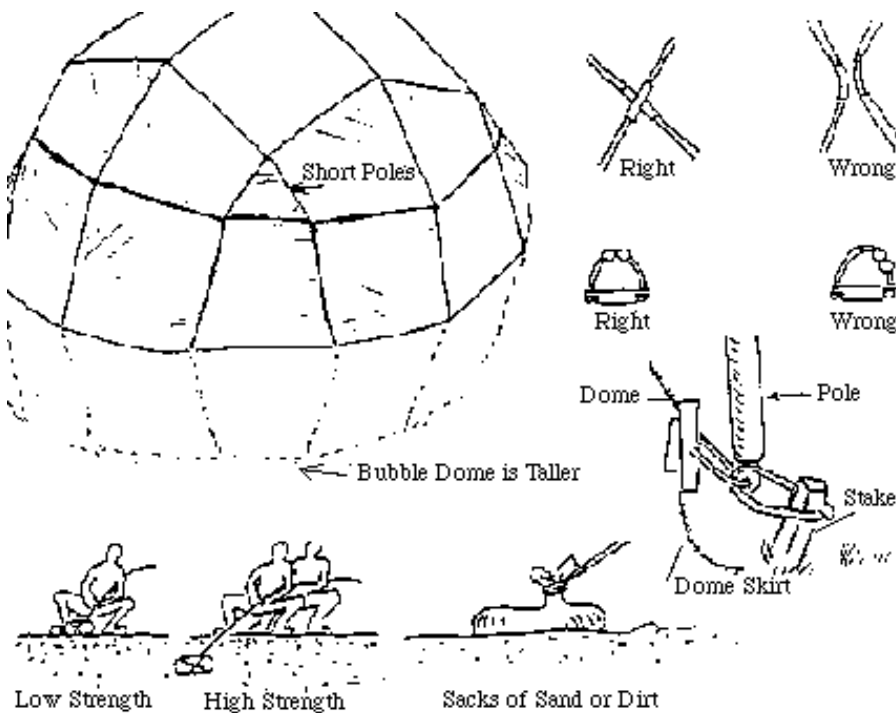

Check your stakes frequently (since ground conditions can change when wet) by pulling on them. You should just barely be able to pull them out. To anchor to a deck, use eye bolts attached to the 2"x 6"s set below the level of the deck.

The best is to avoid the wind by choosing wind protected places to pitch your tent. Of course this cannot always be done. If high wind comes up take your tent down before the wind gets too strong. Next best is to protect your tent from the wind with wind blocks such as snow fencing, bales of hay, buildings, cars, etc. Next make sure you secure your tent to the ground in a way that it will not come loose. Wind over time will cause your tent to move up and down and side to side therefore your ground stakes need to be **checked frequently to see if they are working loose**. **Check to see that the cords you run from your tent to the stakes does not become frayed by this friction.** If you use re-bar as stakes make sure the ends of the re-bar are covered with bottles or preferably bent into a "U" shape so you will not cut your foot or leg on the exposed bar.

#### **Anchoring into rocky ground:**

Wear gloves and eye protection. With a one foot section of re bar or a 10" or 12" "spike" (large nail) and a heavy headed hammer pound the re-bar or nail into the ground where you want to place your stake. Before the re-bar is buried loosen it with the hammer by hitting the re-bar on the side that is above the ground. Pull the re-bar out and now pound in your stake.

#### **Making your own re-bar stakes.**

You can make re-bar stakes by bending lengths of re bar into a U shape at the top of the stake. Slip over each end of a 2' lengths of re- bar 3 or 4' sections of steel pipe and then by holding on to the ends of the pipes bend the bar.





**Avoid rebar friction**

Strong wind pushing and pulling on the dome, will cause the stake cord to rub up and down on the ruff re-bar (like a saw blade) there by cutting through the cord. The way around this is to **tie the base clip cords to the re-bar with sections of 3/8" or thicker cord.** (The clip cords that we provide with our domes are only 1/8" and are designed for the plastic stakes not re-bar.

**Guying:** In wind, always set 4 to 12 guy lines. Run a line from the clip cords (if you tie to poles the wind will pull out the poles) to trees, stakes, large rocks or buried objects in the soil. In high winds check guys and anchors frequently, adding more if necessary.

Even if you anchor your dome well, extreme wind can rip the guy line clips off your cover and poles off your dome and your dome will fail.

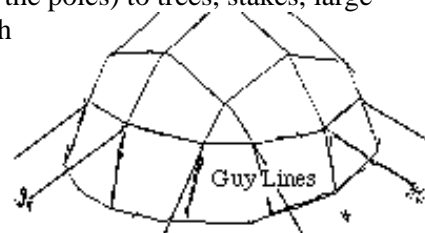

**Consider incorporating a strong bungee cord into your guy lines.** By "strong" we mean a bungee that you can just barely stretch when you pull on it with both hands if you can not find ones that strong then tie a weaker one

into a loop or joining one or more together. Tie one end each guy line to a bungee and then tie the other end of the bungee to a secure stake.

If you expect a storm with strong winds, consider removing the lower 12 poles, leaving the dome anchored. Then run strings back and forth across the dome, going from stake to stake to keep the wind from lifting up on the covering. If the dome still appears to be buffeted excessively by the wind, remove the remaining poles and lash the covering to the ground again by running strings back and forth from the anchors. When the storm passes, put the dome back up.

## Wind and Snow Warning

Shelter Systems' Domes are stronger for their weight and cost than any other structure. Still they are light weight portable structures and as such are not designed to hold unusually strong wind, year round wind or much snow.

When possible, avoid exposed hilltops and narrow valleys where wind speed increases. Trees and brush between you and the wind help protect your shelter. If you do not have natural protection from the wind you can create a wind screen out of straw bales. Your dome could be destroyed in extreme weather and your life or safety could be at risk. In heavy snow or wind your dome could collapse, damaging what you have or compromising your shelter. Do not rely on your dome as your only shelter. Accumulated snow, must be melted or shaken off.

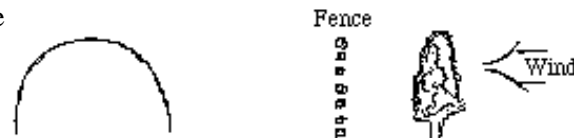

Just as you would not expect to be able to climb up on top of your dome and have it hold you, it will not support much snow. If you plan to use your dome in the snow you will need to knock off the snow periodically or melt it off with heat from within the dome. If the dome should collapse some poles may break (these are easy to repair or inexpensive to replace) with unusually little or no damage to the covering. However items stored inside could be damaged by the weight or melting of the snow.

The covering will have a shorten life in areas that have constant winds. The dome's covering can fail or the covering be ripped from the clips in extreme wind.

If your dome is free from its anchors it can tumble and blow away and possibly collide with and damage people or property. Do not let your dome get away from you anchor it well.

Even if you anchor your dome well, extreme wind can rip the guy line clips and poles off your dome and your dome will fail.

**WARNING:** Your Yurt Dome shelter could be destroyed in extreme weather and your life or safety could be at risk. In heavy snow or wind your Yurt Dome could collapse, damaging what you have or compromising your shelter. Do not rely on your Yurt

Dome as your only shelter. Accumulated snow, must be melted or shaken off periodically. Do not set your Your Dome under a tree or branch that might fall on you. Keep all flames and heat away from your Yurt Dome's covering and objects in your yurt dome.

**Net Doors (Optional):** If you ordered net doors with your original order, they are already installed and function just like your fabric doors. If you got them from us later, you can install them yourself. You will tie the upper two corners to the dome clips over the door. There are holes on the interior of the clips on your dome for this purpose. Thread the string through one of these holes on each of the clips. Pull the string up as short as you can get it and tie.

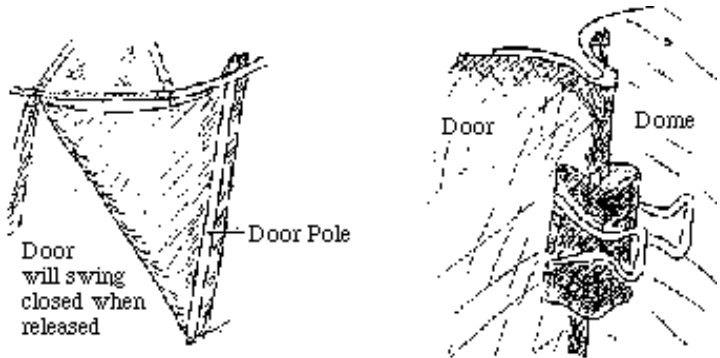

The door poles that came with your dome can be switched back and forth from the fabric doors to the netting doors in seconds when needed. For a full net opening, transfer both ends of the pole to the plugs on the net door and roll your fabric door out of the way. To ensure that there are no vertical gaps where the bugs can fly in, make sure your door opening is adjusted properly. Moving the stakes toward each other 3" or so will help the doors fit right. You want the door opening narrow enough so that the netting will fit with excess along the edges to seal out the bugs. Secure the net to the side of your door opening with binder clips

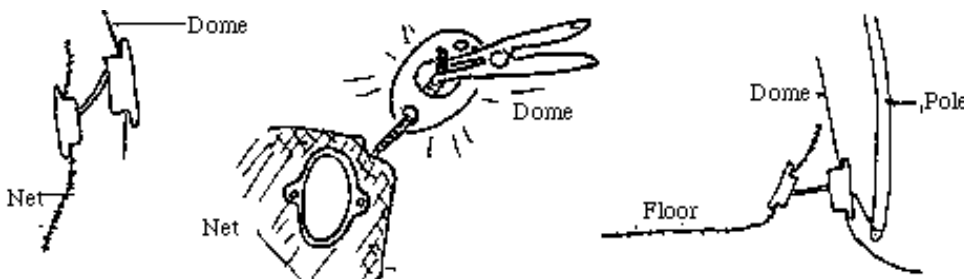

An alternative to binder clips is sticky back Velcro. Make sure the netting and tent covering are clean and dry before applying the Velcro. The one way to attach the Velcro to your net doors is to first secure the net closed with the bottom clip hooks. Use a marking pen to mark where the edges of the netting contacts the sides of the tent. Lift up

the net and get it out of your way. Now measure and cut a length of "hook" Velcro long enough to secure one of the door's edges. Remove the protective strip from the sticky back and apply this Velcro to the inside of the mark you have made on the side of the dome. Repeat for other side. Take two lengths of "loop" Velcro and Velcro them to the "hook" Velcro that you have already attached to the sides of your tent. Remove the protective strips from these. Now carefully lower and hook your net door to the base of the dome. Press the netting to the exposed sticky of the Velcro. Rub well to secure the bonding of the glue to the netting and the sides of your Yurt Dome.

**Keeping Cool:** Try to set your dome up under the shade of a tree, however; do not set it under a tree or branch that might fall. If no tree is available, use one or more of Shelter Systems' SunShades (see below) or 90% shade cloth. Do not use black plastic because it will heat up in the sun enough to cause the poles underneath it to soften and bend. Be sure the sunshade (see below) is on tight. In hot weather keep all your doors open, preferably without the netting (if bugs are tolerable), since the net slows the air flow. Turn the dome so the doors face towards the prevailing breezes. This structure is shingled; panels overlap like roof tiles.

**Vent Tubes:** For excellent upper ventilation invert the Vent Tubes (see photo at right) provided and or other light objects, like empty soda cans in between the overlaps. The fabric will grip them and hold them. Air can move in and out. The more you open up your dome to air flow, the cooler it will be. Start by putting them in the seams dividing the panels of the ceiling and the upper wall panels. This will let the hot air out of your dome and allow cool air to replace it. You can secure the vent tubes against the wind with a binder clip.

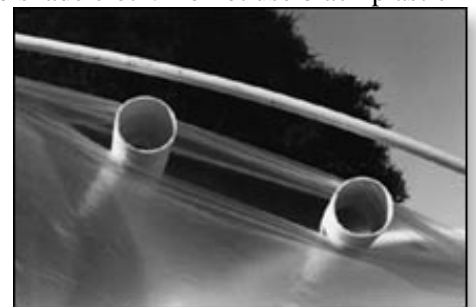

If insects are a problem use sticky back Velcro to attach a strip of netting approximately 18" by 5' to the inside of the upper shingle of tent fabric where you plan to place your Vent Tube. Do this so that the netting hangs down on the outside of the Yurt Dome's cover. Then when you insert the Vent Tube the netting will cover the opening and protect the interior from insects. If

and when the bugs are not a problem you can un-Velcro the net and store it. In windy conditions you can use sticky back Velcro to attach the hanging part of the net to the lower shingle. Make sure the netting a tent covering is clean and dry before applying the Velcro.

If your dome is still hot, a large cooling opening can be created by removing the poles under one of the pole arches on the side of your yurt dome and then tying up the canopy to the arch. You will first need to undo one Grip Clip from the strip at the base of the door, then apply the Grip Clip back on to the dome. Run the strings from the inside of the dome, where there are holes on the inside of the clips, to the outside clip strings. This should drastically increase ventilation, but it will also weaken the dome in the wind. This opens your interior space to the outdoors, greatly helping to keep your dome cool. It also makes a wonderful display space for public events.)

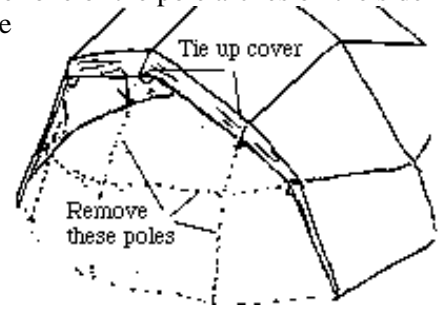

To open the arch on the Bubble Dome: The Bubble Dome has only one door there for you will need to remove two clips to simulate another door along the arch away from the existing door and then reattach them with their connectors to the dome's side (this is so that the arch pole can be reinserted). Now the covering under the arch is free to be rolled and tied up.

### Instructions for Attaching Grip Clips to Sun Shades

Parts: Sun Shade cover, 4 Grip Clips, 4 - 12' cords.

Attach one cord to ring part of 4 Grip Clips. Using the Clipping Instructions at the end of your manual attach one clip to each of the corners of your Sun Shade. Clips should be about 3" from the edge.

Follow the instructions below for attaching Sun Shades

**SunShade** (Optional): Shelter Systems offers silver/black sunshades. The white on the outside reflects the heat of the sun while the black on the inside blocks the sun and provides shade. The spacing between the SunShade and the dome allows air to flow and dissipate heat that is absorbed by the SunShade. The Sun Shade comes with 4 General Purpose Grip Clips attached at the corners, and attachment cords. To

attach Sunshade, first tie the cord from one corner of the Sunshade to your dome. Then walk around the dome, pulling the shade over the dome. Take care that the white side is out. Tie this corner down. Tie the other two corners of the shade to the dome. It is important for the sunshade to be kept tight, because you need that cooling airspace between it and the dome itself. If



over heating is likely a problem consider two or more SunShades. Arrange your Sun Shades such that they do not overlap each other completely. The airspace under the shades and the gaps between the shades will allow heat to be dissipated and escape rather than be reradiated back into your dome.

**Net Walls** (Optional): The net wall must be installed by Shelter Systems. If you ordered a net wall, you will have been given three extra long poles for it. Locate the wall panels where there is netting on the inside of your yurt. There are three clips on the wall panels of the yurt where you will need to untie a string that is holding the panels down. At three points on the two wall panels where the poles hold the awning up, you will find clips with plugs that slip inside the ends of the poles. Stand your awning up with the poles and guy them out with the guy lines provided. Tie a guy line to each clip string at one end, and to a stake at the other. Guy out the middle pole first, tying the guy line to both clip strings (since two clips come together at this point). Now have a seat and enjoy the breeze!

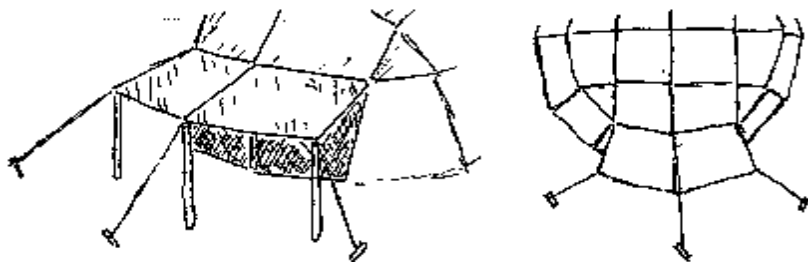

**Staying Warm:** Remove the sunshade to let in the sun's warmth, if you have one. Use a propane, electric radiant heater or wood stove to heat your dome. Take precautions to keep all heat sources from your tent walls. A full interior wall liner with windows is available from Shelter Systems, which will dramatically increase the warmth of your dome. A liner reduces heat loss from radiation, conduction and convection, and creates an insulating dead air space of 2"-3". It also helps prevent condensation which may occur in very cold situations. One option you could consider in more permanent situations is the use of rigid foam insulation between the layers. This is acquired at a building supply store. You simply cut it into the same geometric shapes as your dome's panels and insert it panel by panel as the liner is tied in. Although this is not necessary in order to be comfortable in your dome, you will use less fuel and will experience more even temperature.

**Stove Installation:** Place your stove a safe distance from the tent wall on a certified fireproof mat or bricks. When deciding what height to have your stove pipe going through the wall, keep in mind all stovepipes must be at least 18 inches from all tent poles. This means your horizontal stove pipe must be low enough, as well as long enough to keep the vertical sections of pipe a safe distance from the poles; otherwise they will melt. Here are two ways of preparing your dome for stovepipe installation. One is to simply run the chimney through a mound of earth which is approximately 10" higher than the stovepipe and is positioned in the doorway. (The door is lowered on top the mound of earth.) The second technique uses a plywood panel. To do this, roll up one of the doors and tie it so it stays safely out of the way. Cut a piece of plywood that is the same shape as the door opening, but slightly bigger for a tight fit, and drill a small hole in the upper two corners. Shingle this in place by propping it into the door opening with the top edge inside the dome and the bottom edge outside the dome. Tie the upper two corners to the nearest interior clips. **Keep all flames and heat away from your dome's covering and other objects in your dome.** If possible have your stove pipe come out the back of your stove and pass through the plywood wall. If your stove pipe exits your stove at the top then place an elbow as close to your stove as possible.

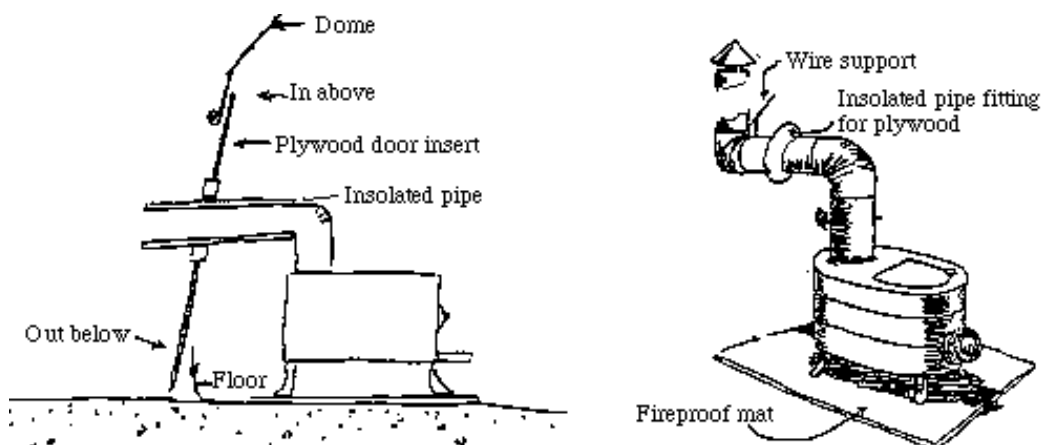

Attach a horizontal section of pipe to this elbow and pass this pipe through the wall such that it will slant slightly down towards the outside. This will keep rain from following the pipe and dripping inside your dome. We recommend using insulated stovepipe throughout. Place an elbow on the outside. Attach a vertical pipe on the outside pipe and a spark arrester cap on top. Use steel wire to support and stabilize the pipe outside the dome. Loop it around the elbow so it lifts and supports the weight of the horizontal pipe. Another wire will be needed around the vertical pipe to keep it upright and stable in the wind. Tie the other ends of the wires to the dome and or attach them to wooden poles driven into the ground. The wires should be tight enough to lift the horizontal pipe so that it is centered through the hole in the wall and not touching the fabric. Local codes may require other installation procedures.

**Liner (Optional):** The interior wall liner is installed after your dome is set up. Unroll the liner inside the dome. Locate the liner's center clip that is marked with a ribbon. Tie the string of this center clip to the top center ceiling clip of your dome. This is done by threading the string into one of the two holes and pulling the string back through the big center opening in the domes inner clip. This is easier if you use a tool like a crochet hook or a needle nose pliers to grip and pull it through.





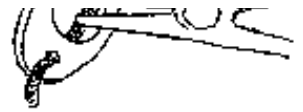

Pull the string as tight as you can without deforming the dome's outer cover. Then knot. Turn the liner until the doors of the dome match up with the doors of the liner. Now proceed to work down from the top. Be careful not to miss any clips since it is hard to reach them later on. The lower clips at the liner's edge can be moved up before tying if necessary to get the liner nice and tight. Simply unclip them and clip them back on a little higher on the material, adjusting the tension.

**Dividing your dome** Shelter System's Yurt Domes can be easily divided into rooms with fabric you provide or some of the same [woven ripstop material](#) that Shelter Systems' makes its Yurt Domes out of.

First, get enough fabric. If you plan to divide your dome in half get or sew a 6' wide piece with a length equal to the diameter of your Yurt Dome. If you plan to divide your dome in quarters then get two pieces this size. Purchase 7 [Grip Clips](#) to attach your fabric if you are dividing your dome in half. Purchase 14 [Grip Clips](#) to attach your fabric if you are dividing your dome in quarters.

Fold the divider in half length wise and make a small mark at the fold on the edge. If you are dividing your dome in quarters lay out both dividers on top of each fold in half and make a small mark the top and bottom edge at the fold. Open out the divider(s). If dividing your dome in half attach one clip at the edge mark "E". If dividing in quarters then attach a clip at "E" and "F" clipping the two dividers together at the center fold.

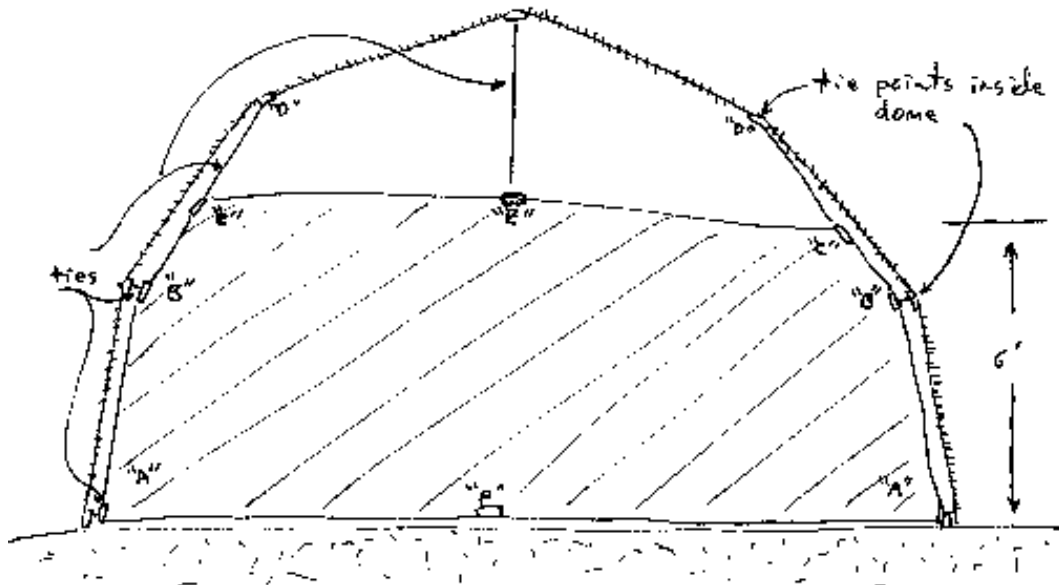

Next attach a clip point to point "A" on the divider and tie it to the dome's ground clip which is equal distance between two adjacent doors. Stretch divider across dome and attach a clip at the other point "A" on the divider so that when the divider is tensioned and tied to the dome's ground clip it will stretch tight across the floor of the dome. Have two people hold up and tension the divider so points "B" can be marked, clipped and tied. Run a cord up clip "E" and tie it to the top of the dome to support the middle of the divider. Have two people hold up and tension the divider so points "C" can be marked, clipped and tied to the dome at points "D". Move the clips on the divider if needed so that the divider is tensioned evenly.

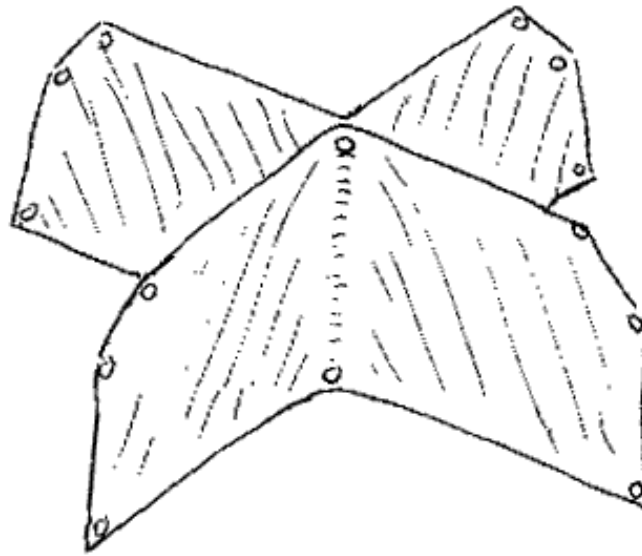

If you are dividing your dome into quarters the first tension and tie your four way divider so as to divide the dome in half then pull out and tension and tie the quarter sections.

### **Instructions for Attaching a Door to Door Connection Strip**

Parts: Strip 3' by 16' for 18' dome or yurt, 8 Grip Clips, 8 clip cords,

This strip when attached properly will join two dome doors tightly and create a gutter between them that redirects water to the base outside the domes.

On a windless day set up two domes next to each other such that two doors are facing each other. Roll up and tuck the two door coverings over the poles at the top of the doors. Move the domes together so that the base of the door openings touch each other. Follow carefully the instructions in you manual to secure your dome to the ground using all means necessary.

- 1) Knot end of each cord. Feed the un-knotted end of the cords through the concave side of each the "button" ends of the clips. Using the Clipping Instructions at the end of your manual attach two clips to the center end of the connection strip about 8" from the end, such that these clips are about 4" from each other.
- 2) Enter one of the domes and lay out your connection strip under the two door openings so that the button clip cords are to one side and centered in the door ways. The cords should be facing up and close to one of the sides of the openings.
- 3) Slip and tie tight one of the connector clip cords through the clip hole at the base and inside the door closet to that clip. Repeat this with the other button clip cords inside the other dome. You will now have join these two domes together with the connector strip.
- 4) Keeping the connector strip centered and tight apply two clips to the connector strip so that the button cord is on the same side of the strip as the first two clips and such that when these two clips are tied to the inside upper clips of the two, they pull the connector strip tight and centered. You may need to remove and reposition these two clips to get the connector strip tight, centered and even.
- 5) Next proceed to do the same for the next two door way clips. Keep the strip centered and tight.
- 6) Finally, secure the remaining two base clips. The connection strip should now be secured tight to the walls inside both domes creating an air closure and water tight connection.
- 7) You may carefully trim excess material from the strip.
- 8) If your soil does not drain well then make a ditch around your dome to direct water away from the domes.
- 9) If you need to make more connection strips you can remove the one you have fitted and use it as a pattern to make other strips.

**Vestibule** [Attaching a Water Tight Vestibule](#) or Porch to Your Yurt Dome™ Making a porch from a tarp.

**Porch (Optional):** If you ordered a porch along with your dome, you'll find the two porch support poles taped together. The

support poles are the same length as the dome poles but have a hole drilled in each end. Find also 16 poles that are a smaller diameter and shorter than your dome's poles. Spread your porch cover out on the ground so the connectors are facing up. Begin inserting poles into the connectors.

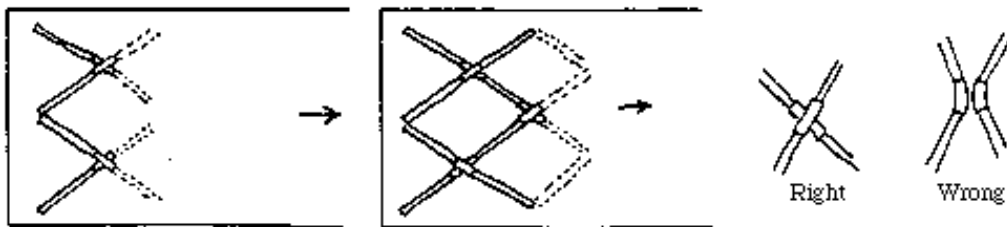

Start from one edge, working your way toward the opposite edge. As more poles are added the material will tighten, requiring that you bend the poles and pull the connectors on the ends of the poles. At each intersection your poles must form a cross. When under tension the porch wants to form an arch. If you pull on the sides of your porch, you will see that it can "pop" back and forth from a long, narrow tunnel shape to an arch that covers an approximately square area. It is in this square position that it will fit your doorway as a porch roof.

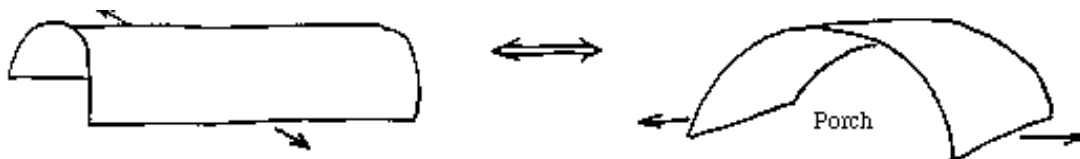

Tie the corners of the porch to the long poles that extend horizontally on either side of the triangular window over your door.

Tie to the clip strings on the porch rather than to the porch poles on the for maximum security in the wind. Now tie the two long poles with holes in there ends to the clip strings on the front of the porch and to stakes at their bottom.

**Storage:** Brush off all the dirt that you can. Make sure the dome is completely dry. If you have to take the dome down wet, plan to hang it indoors from the top clip until it's dry before packing. Remove stakes, vent tubes and poles. The liner may stay attached. We've found the following folding technique to be the easiest. Lay the dome on its own floor. Put one stake in the ground, to use as an anchor during folding. Hook the clip string at the very top center of the dome to the stake. Pull all the dome's edges so that it fans out and lies flat, one half on top of the other half. Then pleat-fold it so that the canopy forms a narrow triangle 4' wide at the base. Try to get each fold as flat as possible. Slip the tip of the triangle off the stake now and begin rolling it tightly down toward the wide end until you've got a nice bundle. Clean and dry both sides of the floor. After the floor is dry, fold it into a 4' wide strip. Lay the tent roll and other small parts at one end and roll the whole thing up tightly. Wrap your dome in the material you received it in and use strings to hold the roll tight.

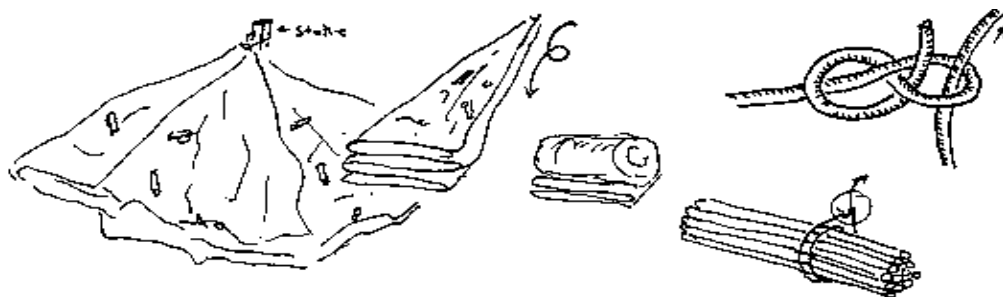
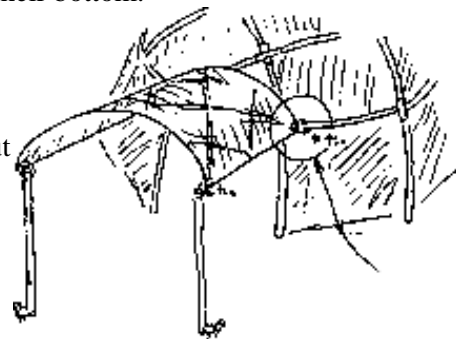

Now tie the poles into a bundle. To get it nice and tight, wrap string twice around the bundle of poles and use a packer's knot. This is a kind of slip knot that holds tight.

### Deck Building:

We include the following ideas on deck building only as such. Always consult with an experienced carpenter so that your deck will turn out right and be safe.

These plans are for a 20' Dome. If your Dome is larger or smaller adjust the measurements and the size of the wood you use. It is assumed that your land slopes slightly. If our land is flat it will be even easier to build a deck.

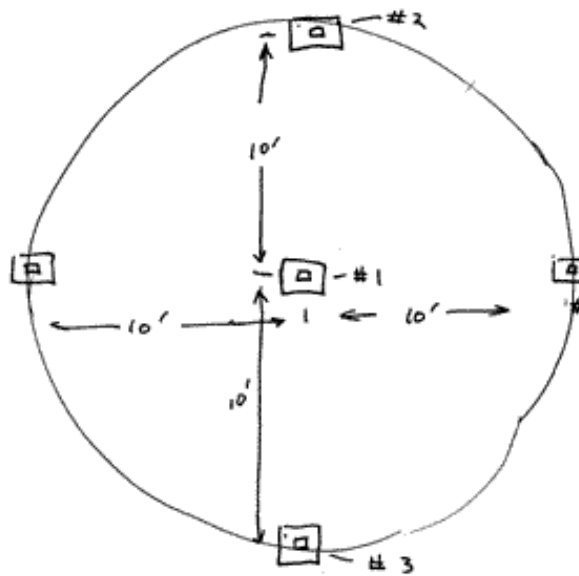

Set your first pier block at the approximate center of where you want your dome to be.

10 feet up the hill from #1 set your #2 pier block. Using a string or tape run a straight line from #2 through the center of #1 and 10 feet more to set #3. 90 degrees to this line set piers #4 and #5.

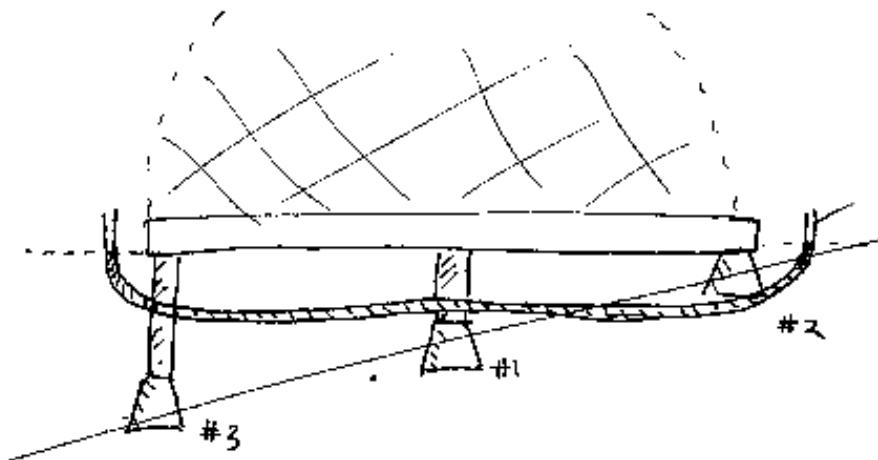

Use a clear 1/2" vinyl tube 25' long as a level (fill the tube with water 6" from each end - hold one end beside and above the #2 and the other end beside and above the #3 - the water in the tube will make the level) pull a string tight to mark this line and the 4" by 4" attached to #1 and #3

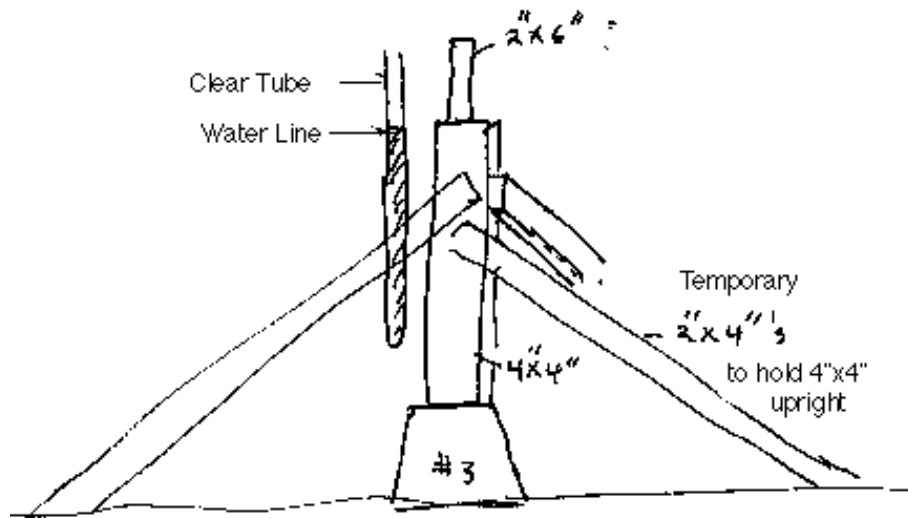

Using steel brackets attach the a 4" x 4" to the #3 pier block. Support the 4" x 4" with at least 3 temporary 2" x 2" to hold it vertical (use a level or plumb line to make it vertical).

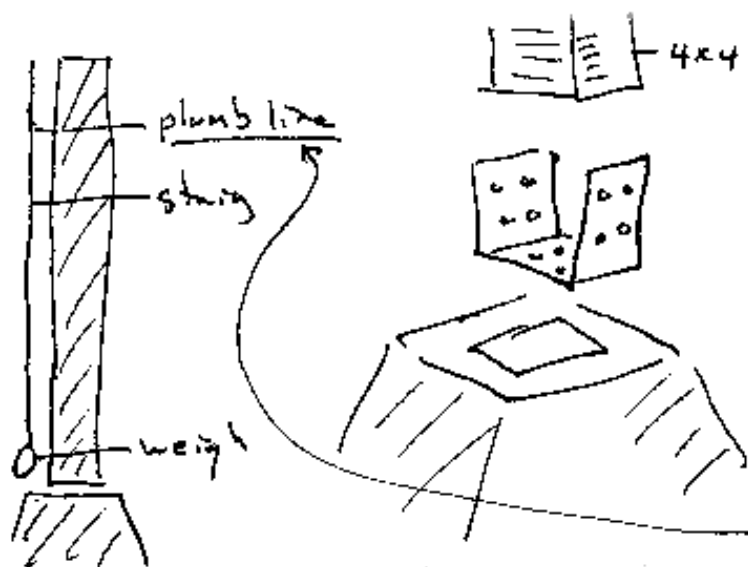

Now attach a 20' 2" x 6" using steel brackets to the #2 and #3 blocks. Add two 10 foot 2" x 6" again using the leveling tube and the plumb line.

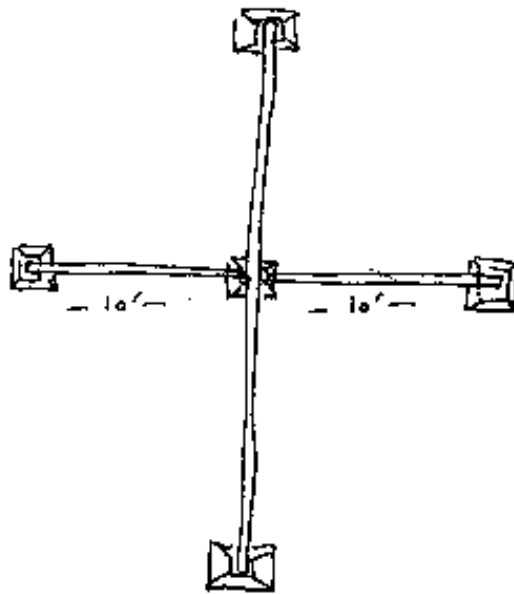

Add four more pier blocks "W, X, Y, Z" Place the other pier blocks by adding a 10' long string at #1 and using your tape measure to mark off 2' 4' 6' and 8'. Use your tube level and plum line to secure the 4"x 4"s. Then attach your 2" x 6"s.

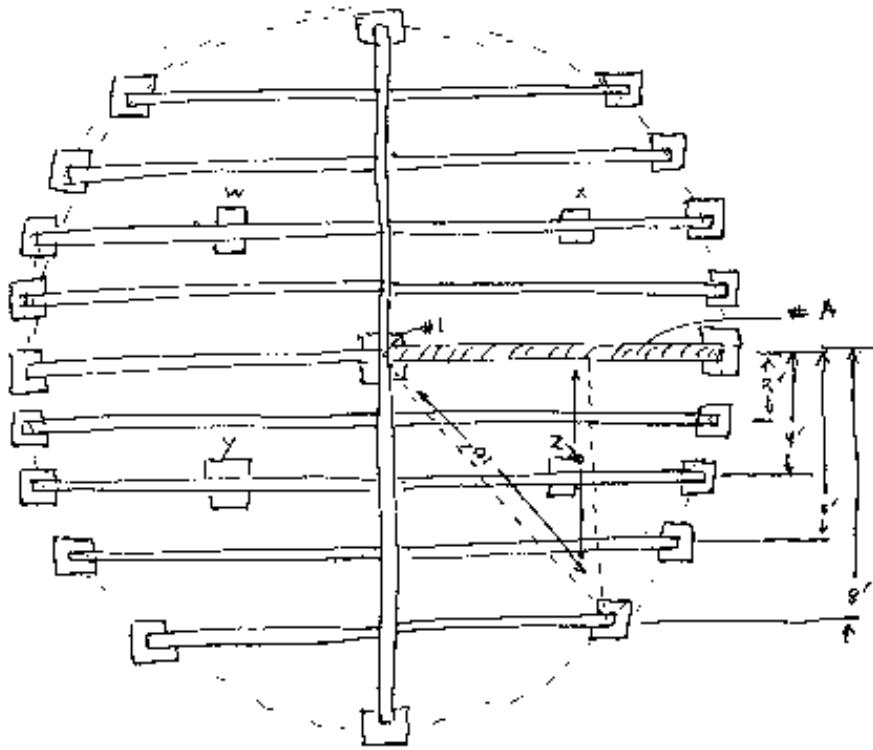

Brace at least every other 4" x 4".

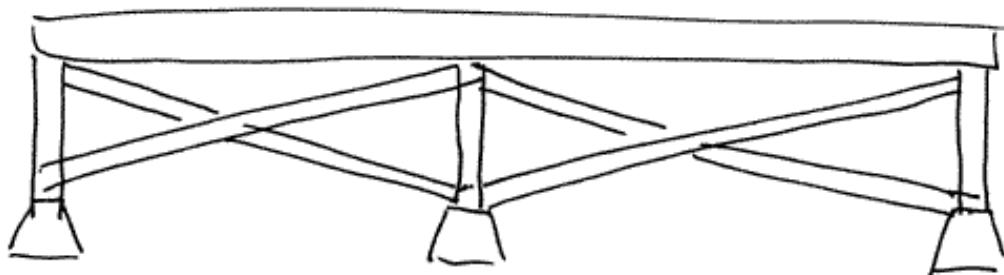

Proceed to add the other pair of blocks and 2" x 6"s use in joist hangers. Nail in 2" x 4"s, again using joist hangers, to support the middle of the 4' x 8' plywood. Nail or screw on 3/4" plywood.

Let the plywood over hang the outer edge of the joists by about 6".

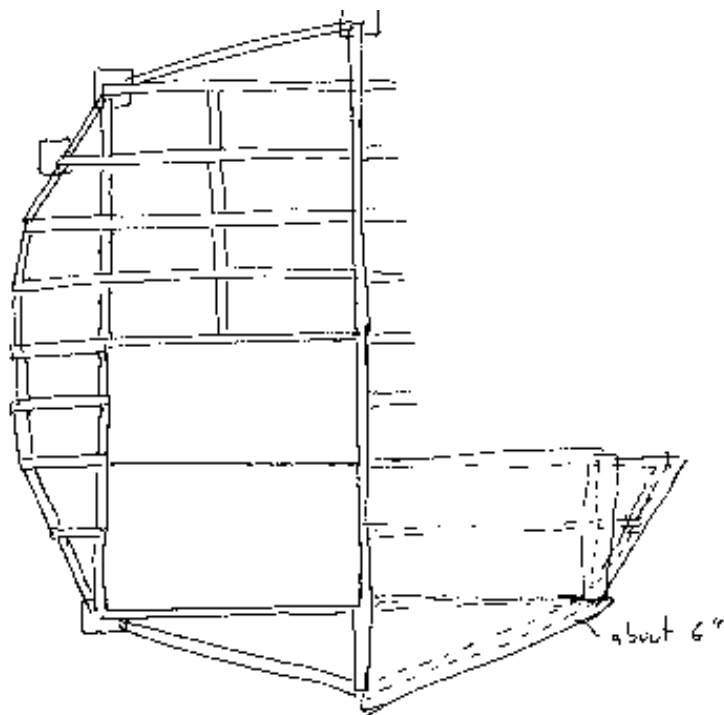

Set your dome on the plywood.

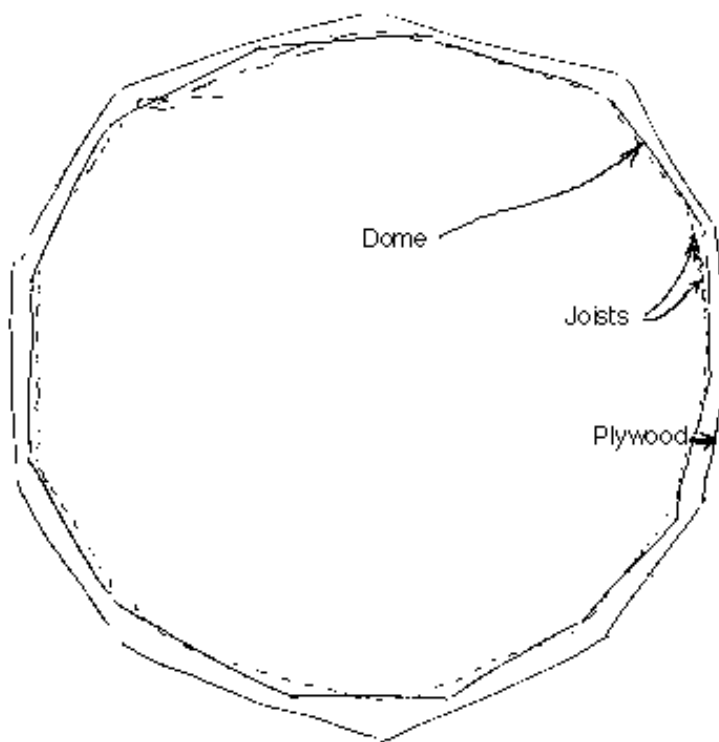

Turn the dome how you want it attach it temporally at the pole end with nails to pull the dome edge tight.

With a pencil make a line on the inside of the dome to follow the edge of the dome.

Remove the dome. Using a saw cut the decking to the line.

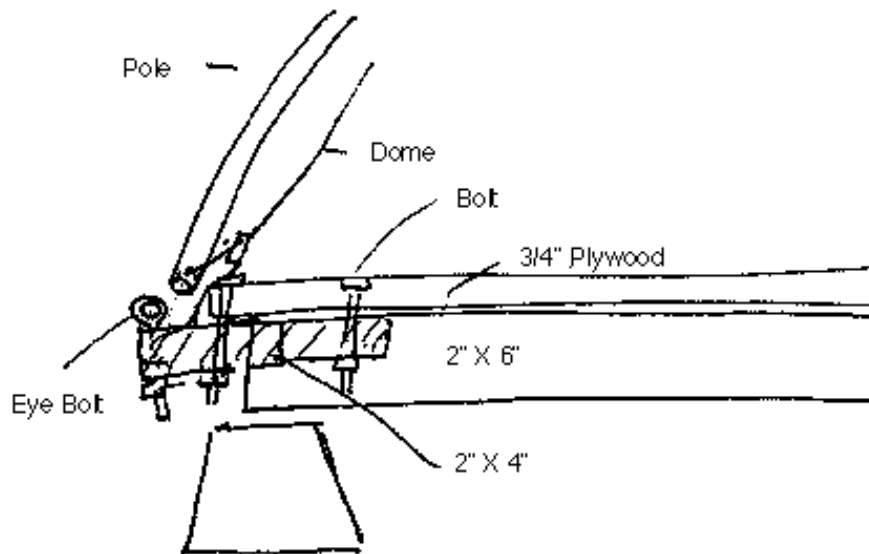

Bolt sections 2"x 4" to the plywood so that they extend beyond the plywood to support the domes pole ends. Tie the clip cords at the pole ends to eye bolts in these 2" x 4"s.

**Repairs:** Your yurt is designed to be durable and problem free. However, some of our customers use their structures for so many years that eventually they need some maintenance. A broken pole can be repaired with a wooden insert such as a piece of broom handle or a straight stick. Poles can usually be obtained from a building supply or plumbing store. Ask for class 200, class #125 or schedule 40 will also work. Poles may also be ordered from Shelter Systems (send length and size).

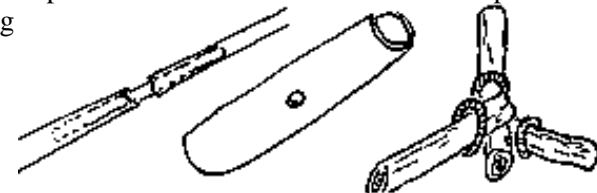

**Broken connectors** can be replaced with class 200 PVC (1-1/4" for the 20' and 18' domes and 1" for the 8', 10', 11', and 14' domes). The simplest way to repair a hole or cut in the covering is to cut a patch from the material the dome came wrapped in. Use 100% silicon rubber to glue your patch on the outside of the tear. If the tear is small you may be able to plug it up with a blob of silicon rubber alone.

**If a clip is torn free** of the covering or if a tear is immediately adjacent to a clip you can patch the tear with a patch cut from the skirt of your dome or the wrapping material that your yurt came in. Use a patch about 12" square, if this is sufficient to completely encompass the torn section with at least a 2" overlap on good sound material. This will allow you to spread the stress that the Grip Clip generates over a large # of stitches. Make your stitches about 1/8" long using doubled cotton covered polyester button thread. You do not have to remove the torn section of the covering. Preferably, but not absolutely necessary, glue the patch in place first with 100% Silicon Rubber bathroom caulk first, as this will make the sewing somewhat easier and provide a better seal. You will then have to wait while the glue sets which takes about 12 hrs. Make sure the covering is clean and dry before gluing. Press the glued patch between two heavy flat objects such as large books or flat rocks. After you set up the shelter you can apply Silicon Rubber to the now stressed seams to seal them and along the edge of the patch if you did not already glue the patch.

Alternatively you can replace a whole panel if a tear is immediately adjacent to a clip. Order the same panel from Shelter Systems. 1) Arrange the replacement panel over top of the damaged panel so that it is in the same orientation. 2) Remove only one clip from your dome being careful not to disrupt the layering sequence of the panels on your dome. 3) Take your time to carefully slide out the corner of your damaged panel and insert your replacement panel into the same layering sequence as that of the damaged panel. 4) Now with all layers in the same order and orientation as before; gather these tightly around the male clip and slip over the female clip as described below. When many layers are involved as is the case with the corners of the windows, attaching the female clip can be difficult; practicing on scraps and making the layers warm with the sun or heat lamp (be careful not to melt the covering by getting it to hot) can help. If your dome is flattened by snow, carefully remove the snow without tearing its covering. You may find it will pop back up or that you have to remove some of the poles and set up again. Replace any broken poles.

Attaching Grip Clips™: 1. Knot cord through Ring part.





2. Wrap material over Smaller Button part with its flared side facing up as shown.



3. Slip Button through Ring.



4. Turn the Ring so that the Button seats snugly into the locked position.

5 Removal of a clip is just the reverse procedure.

**WARNING:** Your Yurt Dome shelter could be destroyed in extreme weather and your life or safety could be at risk. In heavy snow or wind your yurt could collapse, damaging what you have or compromising your shelter. Do not rely on your yurt dome as your only shelter. Accumulated snow, must be melted or shaken off periodically. Do not set your yurt dome under a tree or branch that might fall on you. Keep all flames and heat away from your yurt dome's covering and objects in your yurt dome.

Patented and others pending. 650-323-6202 [www.shelter-systems.com](http://www.shelter-systems.com) Questions? [shelter@best.com](mailto:shelter@best.com).

### 30-DAY RISK-FREE TRIAL 1 1/2-YEAR GUARANTEE

Our guarantee is simple. **YOU MUST BE SATISFIED!** If for any reason you're not completely pleased with your purchase, return it in original, clean condition within 30 days of receipt for a full refund or exchange as you wish. All items in this catalog

have a warranty against defects in materials and workmanship for **1 1/2 years**. Should any product prove defective we will repair or replace it at no cost to you. Special Orders are not returnable. Read [Snow and Wind Warnings](#).

[To order](#) by Fax or Mail.

[Order online with our Secure Order Form!](#)

**For fast credit card orders call 650-323-6202**

Questions? E-mail us at [shelter@best.com](mailto:shelter@best.com). Please feel free to call or write us anytime. Shelter Systems-OL, 224 Walnut St., Menlo Park, CA 94025. FAX 650-323-1220 Phone 650-323-6202.

[Shelters](#)

[Greenhouses](#)

[What's New?](#)

[Gillis Designs](#)

[Stories](#)

[Q's & A's](#)

[Price List](#)

[Shelter Systems' Map of Site](#)

**Shelter Systems** © 1996 - 2003 All Rights Reserved

[Shelter Systems' Home](#)



[Shelters](#)[Greenhouses](#)[What's New?](#)[Gillis Designs](#)[Stories](#)[Q's & A's](#)

## Emergency Relief Shelters

### Shelter Systems' Emergency Disaster Relief Tent Shelters.

**Shelter Systems'** Portable Yurt Dome™ tents have been [sheltering people](#) for extended periods of time in all climates for over 20 years. Shelter Systems' Emergency Disaster Relief Tents offer the best value because they are strong, durable, watertight, wind-resistant, pleasant to live in, easily set up, and affordable.



**Venezuela Flood Shelter Relief** [More Photos](#)

#### **Sturdy Design**

Shelter Systems' Relief Tents are dome shaped patented [Geotensic™](#) structures. Geotensic™ structures are stronger than any other structure of the same volume and weight. Because of their curved shape with no corners, there are no weak points. Shelter Systems' Relief Tents are drum tight, completely waterproof and wind-resistant.

Shelter Systems' tent structures have the poles on the outside with the covering suspended under the frame via Shelter Systems' own Grip Clip tarp fasteners. The frame and the covering are not in direct contact. The important benefits from this design are that the covering is under constant, even tension so that the tent will not flap in the wind. The poles cannot rub against the covering. This prevents wind flap shredding and pole friction wearing. Also, since the poles and covering are not touching, there is no temperature buildup to degrade the fabric at contact points.

The [shingled](#) panels of our Relief tents overlap each other by 6", making the structure stronger and completely leak proof. The shingling also allows the structure to breathe. The buildup of moisture is driven out through the overlapped panels by vapor pressure and does not condense inside the tent.

Shelter Systems' patented [Grip Clips](#) tarp fasteners join the dome's cover to the frame. Grip Clips also fasten the shingled panels together, providing greater strength than sewn seams or any type of grommet because they do not puncture the cover. The Grip Clips grip a large area of fabric spreading wind loads and preventing tearing.



**The 18' (5.4 m) in a village setting. Eight to ten people can be sheltered in each dome**

### **Durable Materials**

Shelter Systems' Emergency and Disaster Relief Yurt Dome Tents are made wholly of a superstrong, tear-proof, [woven ripstop film](#) which will not rot or mildew. The covering effectively excludes rain, dampness, wind, cold, and sun. The completely waterproof covering and the shingled breathability make a rain fly unnecessary. The covering is UV-stabilized to withstand up to 3 years of full sun exposure. The white color of the covering reflects the heat of the sun and provides 40% shade.

The frames are constructed of strong, long lasting, resilient, UV-stabilized, Class 200, 1 1/4"-diameter (3.5 cm.) PVC tubing.

### **Affordable**

Our waterproof design does not require a rain fly and the particular geometric shape utilizes material efficiently. The high performance covering is affordable. Because of the design and our tarp fasteners, our tents are labor efficient to build. These factors make for reliable and affordable Emergency and Disaster Relief Shelters.

### **Comfortable Living Space**

Shelter Systems' Relief Tents are light filled and well ventilated. The white covering creates a pleasingly bright interior. Shelter Systems' 5.4 meter Emergency Relief Tent has four flap doors evenly spaced around the dome for good cross ventilation and light. The door coverings close automatically so you can go in or out quickly. There are no zippers to fumble with or break. Over each door is a translucent skylight window which allows 90% of the sunlight to pass through it while preserving the privacy of the people within.

Shelter Systems' Emergency Relief Shelters are winter-ready tents. They do not require a fly or liner (for extreme cold we do offer a [liner](#)). They are completely water tight and will not leak. The [shingled construction](#) allows moist air to be driven out through the by vapor pressure. Shelter Systems' Relief Shelters have a minimal surface area for their volume and are thus easy to keep warm with a stove ([installation instructions](#) are included with each tent).

[Overhead ventilation](#) is easily attained by inserting a lightweight object (eg, an empty can) between panels. This ventilation is shingled and sheds rain. When the can is removed, the panels snap shut. For maximum ventilation the walls themselves can be [rolled up](#).

The dome shape has other comfort features: The interior can be divided into "rooms." The tent has more volume than a flat-sided one and therefore feels, and is, more spacious. The shape is more heat efficient requiring less fuel to heat it. Air circulates more evenly in the dome shape than any other shape. The cover of the dome is easily cleaned with a damp cloth.

### **Comparing Different Domes**

The 5.4 has 254 square feet and sleeps eight to ten people. The 9 meter dome has 706 square feet and can sleep 30 to 40 people. As the tents get larger, there is a greater increase in volume in relation to the increase in diameter. This is because the size in diameter extends out in all directions, creating a large increase in volume. Our [drawings](#) effectively illustrate this. Since the surface area of the covering does not increase as rapidly as the volume, the larger domes are less expensive for the usable space inside.

The different domes have different numbers of doors. The 5.4 meter Emergency and Disaster Relief Yurt Dome Tents has four flap doors evenly spaced around the dome for good cross ventilation. The 9 meter shelter has eight doors.



Shelter Systems' Emergency and Disaster Relief Yurt Dome Tents perform excellently in strong wind due in part to their many,

evenly space anchor points. The 5.4 meter Disaster Relief Yurt Dome Tents each have 12 anchor points. The 9 meter has 20 anchor points.

### Complete and Adaptable

Shelter Systems' Emergency and Disaster Relief Yurt Dome Tents come complete with poles, 12" high quality Durapeg stakes, guy lines for extreme wind settings, ventilation tubes, spare parts (Grips Clips and pole connectors) and a [Shelter Systems' Instruction Manual](#) that details floors, site selection, anchoring, cooling, winterizing, and stove installation.

Our tents are ideally suited for most climates; however, they can be further adapted for use in extreme climates. For the extreme cold, where fuel is in short supply, we offer a full liner. For extreme heat, we offer net doors and a sunshade which blocks one hundred per cent of the sunlight. Other [accessories](#) available include rain porches and floors.

### Easy Set Up

The 5.4 meter Emergency and Disaster Relief Yurt Dome Tent can be set up by one person [in 30 minutes](#) without tools. Insert the interchangeable poles into factory-attached connectors spaced evenly over the cover. The poles bend slightly when inserted, tightening the cover into a wind- and waterproof shelter. The tent is freestanding requiring no guy lines and can be moved into the desired position or location without taking it down. The 5.4 meter Relief Tent can be taken down in 5 minutes.



**[The 30' \(9 m\) Emergency Disaster Relief Tent](#) makes an excellent community focal point for "villages" of smaller domes. \$1900 Shipping \$160 Weight:190 lbs (86 kg)**

### Available

Availability of shelters is critically important in emergency situations. Please call about availability. We can produce 40 to 80 Emergency Relief Shelters per day and we will expand our production capabilities to fill any order.

### Price and Payment

Payment is by advanced wire transfer or irrevocable letter of credit CIA. CIF pricing is available upon request

#### **14 foot (4.2 meter) Emergency Relief Shelters**

Quantities of 1000 \$280.00 each

#### **18 foot (5.4 meter) Emergency Relief Shelters**

Quantities of 1000 \$380.00 each

#### **30 foot (9 meter) Emergency Disaster Relief Tent** Quantities of 100 \$1500

each

### Shipping

FOB Georgia, USA. Poles and covering are packaged separately. Shipping by Sea takes about three weeks (250 of the 5.4 m Emergency Relief Shelters fit in a 8' x 8' x 40' shipping container). Shipping by Air about 2 - 4 days. Samples shipped UPS or Fed Ex.

### Dimensions

For one 18 foot (5.4 meter) Emergency Relief Shelters

Poles - 57" x 10" x 10" @ 39 lbs.

Tent covering- 42" x 16" x 16" @ 31 lbs.



**For orders call 650-323-6202**

Questions? E-mail us at [shelter@best.com](mailto:shelter@best.com). Please feel free to call or write us anytime. Shelter Systems-OL, 224 West O'Connor St., Menlo Park, CA 94025. FAX 650-323-1220 Phone 650-323-6202.

Shelters

Greenhouses

What's New?

Gillis Designs

Stories

Q's & A's

**Shelter Systems** © 1996 - 2001 All Rights Reserved

[Shelter Systems' Home](#)

[Shelters](#)[Greenhouses](#)[What's New?](#)[Gillis Designs](#)[Stories](#)[Q's & A's](#)

## Open-Arched Yurt Dome™

### Transform your Yurt Dome into an Open-Arched Yurt Dome™

Shelter Systems' full size 14', 18', 20', and 30' yurts can be transformed into Open-Arched Yurt Domes by you at no cost. The Open-Arched Yurt Dome is great on a hot day or in a hot climate since the large arched opening provides for unsurpassed ventilation. Instructions that come with your yurt tell you how to turn your yurt into a Open-Arched Yurt Dome. It takes only about 15 minutes and can be undone when you want your full dome back. The Open-Arched Yurt Dome is also excellent to use at a trade show, fair or other social occasion, because the large opening is inviting and friendly.



Simply remove the poles from one side of our 14', 18', 20', and 30' yurts, roll the covering up, tie it out of the way, thereby creating a large opening on that side. This arched opening makes for great ventilation and an inviting opening where your dome is used in a public situation. By opening the side of your dome, you create a large pleasing cave-like shelter. You can also place this opening up against the side of your house or other building to link the two together.



The 10' [Bubble Dome™](#) set up as an Open-Arched Yurt Dome at a Trade Show.





The [30' Yurt Dome™](#) set up as an Open-Arched Yurt Dome™.

**Comparing the Width and Height of 14', 18', 20', and 30' Open-Arched Domes**

| Dome Size | Width of Opening | Height of Opening |
|-----------|------------------|-------------------|
| 14' dome  | 11' 6 "          | 5' 6"             |
| 18' dome  | 14' 6"           | 7'                |
| 20' dome  | 16' 6"           | 7' 5"             |
| 30' dome  | 23' 5"           | 7' 4"             |

**30-DAY RISK-FREE TRIAL 1 1/2-YEAR GUARANTEE**

Our guarantee is simple. **YOU MUST BE SATISFIED!** If for any reason you're not completely pleased with your purchase, return it in original, clean condition within 30 days of receipt for a full refund or exchange as you wish. All items in this catalog have a warranty against defects in materials and workmanship for **1 1/2 years**. Should any product prove defective we will repair or replace it at no cost to you. Special Orders are not returnable. Read [Snow and Wind Warnings](#).

[To order](#), by Fax or Mail.

[Order online with our Secure Order Form!](#)

**For fast credit card orders call 650-323-6202**

Questions? E-mail us at [shelter@best.com](mailto:shelter@best.com). Please feel free to call or write us anytime. Shelter Systems-OL, 224 Walnut St., Menlo Park, CA 94025. FAX 650-323-1220 Phone 650-323-6202.

[Shelters](#)

[Greenhouses](#)

[What's New?](#)

[Gillis Designs](#)

[Stories](#)

[Q's & A's](#)

[Price List](#)

[Shelter Systems' Map of Site](#)

Shelter Systems © 1996 - 2001 All Rights Reserved

[Shelter Systems' Home](#)

[Shelters](#)[Greenhouses](#)[What's New?](#)[Gillis Designs](#)[Stories](#)[Q's & A's](#)

## Accessories

Shelter Systems offers many additional accessories for its domes, tents, yurts, and greenhouses. These accessories include mosquito net doors and walls, floors, liners, porches, sunshades, stakes, PVC poles, tarp fasteners (Grip Clips), woven ripstop films, canvas, and vinyl.

### Net Doors

Under certain circumstances you may want mosquito net doors in addition to your fabric ones. These are easily installed and are generous enough in width and length to keep the bugs out without the need for breakable zippers. It even keeps out no-see-ums, those micro-gnats you can't see. Opening two to four doors across from each other results in pleasant cross ventilation. The 14', 18', and 20' Yurt Domes can have as many as four net doors. The 30' Yurt Dome can have eight. They must be installed by us before you get your dome.

**Price:** \$25 each. Shipping: \$2

### Sticky Back Velcro

An alternative to binder clips to hold your net door tight is Sticky Back Velcro; it also works well to secure regular doors against high wind, floors tight to side walls, and to create a net closure for upper Vent Tube openings. See [Instruction Manual](#) under net doors, floors, and Vent Tubes for details on how to install Velcro.

**Price:** Six yards of both "hook" and "loop" Velcro \$25 (includes Shipping)

### Netting

Make your own net doors with Grip Clips (see below). Make net covers for your upper vents with Velcro (see above).

**Price:** Four yards of Netting \$40 (includes Shipping)

### Floor

Some type of ground cover is necessary to keep dampness from coming up into your space. Shelter Systems' floors are made of a blue, tough, fire-resistant ripstop material. There is a good reason that our floors are not sewn in. We have eliminated a critical area for leaks: seams at ground level. Additionally, if you plan on storing your dome, the dirty floor can be rolled up separately so it will not smudge your walls. 12 Light Fabric Grip Clip tarp fasteners are provided to secure the floor. If you decide to use a tarp for a floor consider getting some Grip Clip tarp fasteners (see below) to attach your floor to your Yurt Dome's wall.

**Prices:** 30'-\$270, Shipping: \$35; 20'-\$120, Shipping: \$20; 18'-\$95, Shipping: \$20; 14'-\$75, Shipping: \$15; 11'-\$45, Shipping: \$15;



### Porch

Our porch is a 5 1/2'x5 1/2' arched square. Porches can be attached in minutes to any of our domes. With a porch you can keep your door open in a warm rain. It gives you space to take off your raincoat or boots before going in. Wet gear can be hung underneath it. The porch covering is made out of our translucent greenhouse woven ripstop film for maximum light transmission. However if you wish, you can special order the porch in white for



less light or in white with black for a shade porch. An excellent addition to your Dome.

**Price:** \$68. Shipping: \$15

### **SunShade 6'x12'**

Where shade can not be found consider getting one or more of our white/black sunshades. The white on the outside reflects the heat of the sun while the black on the inside blocks the sun and provides shade. The spacing between the Sunshade and the dome allows air to flow and dissipate heat that is absorbed by the Sunshade. The 6' by 12' Sun Shade comes with 4 General Purpose Grip Clips attached at the corners, plus attachment cords. It is generally better to have multiple small Sunshades on our 14, 18 and 20 foot domes and yurts as these fit the curve of the domed shape better than the larger Sunshades and provide space between them to heated air to escape.

**Price:** \$25. Shipping: \$10



### **Sunshade 8'x20'**

An extra large Sunshade, with 4 Heavy Duty Grip Clips attached at corners plus attachment cords, will help keep your dome cool if you cannot set it up in the shade. These are more usefull on our 30' yurts and domes.

**Price:** \$70. Shipping: \$15

If over heating is likely a problem consider two or more SunShades. Arrange your Sun Shades such that they do not overlap each other completely. The airspace under the shades and the gaps between the shades will allow heat to be dissipated and escape rather than be radiated back into your dome.

### **Grip Clip™ Tarp Fasteners**

That which holds it all together, Grip Clip™ tarp fasteners were designed to make our Yurt Domes but can be put to many other uses. If you decide to make your own floor out of a tarp, use 12 of the Light Fabric Grip Clips to secure the tarp to the walls of your Yurt Dome. This will keep the floor from sliding around. The General Purpose Grip Clip tarp fasteners can add more wind stability to the our standard Sun Shades. If you one or two Grip Clips with cords to the mid edge section of your Sun Shades and tie these out your Sun Shade will flap less in the wind. You can also make your own shelter tarps, canopies, sunshades, and windscreens instantly from any plastic sheeting or fabric. They can be used for joining panels of material together and/or for attaching anchor lines, without perforating the tarps or sheeting. They "button" on quickly and securely, yet can be removed and repositioned as you like. [See how the Grip Clip is applied.](#) You will find endless uses for them about your Yurt Dome, at home, in the garden, while camping, and at construction sites. Almost indestructible and at times indispensable™, Grip Clips will help you create what you need. [More information on the Grip Clip Tarp Fasteners](#) Shipping included in the price. A short length of nylon cord comes with each Grip Clip.

#### **Price:**

4 General Purpose Grip Clip Tarp Fasteners for \$10. These are the Grip Clips that we use on all our Yurt Domes except for the 30 footers.

4 Light Fabric Grip Clips Tarp Fastener \$8. These are the Grip Clips we use these to attach floors to the Yurt Dome's wall.

2 Heavy Duty Grip clatrap Fastener \$10 These are the Grip Clips that we use in our 30' Yurt Domes.



### **Liners**

A full liner will dramatically increase the winter comfort of your dome. A liner reduces heat loss from radiation, conduction and convection by creating an insulating dead air (i.e., the air does not circulate) space of 2"-3". It also prevents condensation which may occur in very cold situations. The full liner is constructed of a white fire-retardant ripstop film with clear vinyl windows for a wonderfully bright and warm space. We also make liners for our greenhouses out of the translucent greenhouse covering. To install, you tie it in place at each intersection point on the dome, pulling it tight. Installation is simple and takes about one hour. You can order a liner with your dome and install it right away, or decide to add one later. If you plan on spending a winter in your dome, a liner will produce a more evenly heated space and you will use less fuel. Be sure to tell us if you want a white or greenhouse liner.

**Price:** 30' liner-\$1550 Shipping \$130; 20'-\$650, Shipping \$35; 18'-\$590, Shipping \$35; 14'-\$490, Shipping \$25; 11'-\$390. Shipping: \$25

### **Repair Kit**

The materials Shelter Systems' tents are are very tough. It is quite hard to poke a hole in them, let alone tear them. However, we do offer a complete repair kit that includes at least 4 square feet of each of the materials that we make the domes of (translucent, and white woven ripstop films and clear vinyl), Grip Clip, 10' of cord, and a tube of clear 100% silicone rubber glue. This kit will allow you to repair most damage to your covering.

**Price:** \$45 (includes Shipping)

### **Extra Poles**

We offer our PVC poles so that customers can make repairs, replacements or just to have extra on hand.

**Price:** \$3 each. Shipping: \$10. Please tell us which size Shelter poles you want.

### **Extra Tri Hubs**

Shelter Systems' Tri Hubs. These are used in our 8 'and 11' Gro-Domes.

**Price:** \$10 each. Shipping: \$10

### **Extra Connectors**

Shelter Systems' connectors come in pairs. They are used in our 10', 14', 18', and 20' Domes.

**Price:** \$25 for 5 pairs. Shipping included.

### **Extra Stakes**

All our Yurt Dome and Gro Domes come with a complete set of stakes made of high-impact ABS plastic. They are 12" long and have excellent holding power in most soils. We do however offer extra Shelter Systems' stakes. **Price:** \$25 for a set of 5.

Shipping included.



### **Shelter Systems' Special Super Strong Woven Ripstop Films**

Shelter Systems' coverings are made by taking a special plastic copolymer (a simple compound composed of carbon and hydrogen which is chemically similar to wax) and stretching it until it becomes stiff. At this point, the material is at its maximum tensile (pull) strength. It is then sliced into thin strips and woven into a fabric. This gives it amazing tear resistance. The fabric is then laminated on both sides with some sheets of the same stretch-strengthened material and is thereby stabilized and super strengthened. You cannot tear it.

All Shelter Systems' coverings incorporate UV sunscreen inhibitors to help block damage from the sun and give the covering a longer useful life.



**Shelter Systems' Translucent: Lets 90% of sunlight through (more than glass). UV transmission is over 75%. Designed for greenhouse and solar use.**



**Shelter Systems' White: Lets 60% of light through; not enough for greenhouse use.**



**Shelter Systems' White with Black Shade Covering:  
White outside to reflect light and the sun and black inside to block light and sun.**

Translucent, White or Shade (White with Black) It comes 6' wide, in any length. You can sew wider widths on with a home sewing machine. The seams tend not to leak but if your use requires them to be totally water tight then you should seal them with silicone rubber.

**Price:** \$8 a yard. Under 20', add \$10 for shipping and handling; over 20', shipping costs increase.

**Clear Vinyl:** Heavy gauge (10 mils), UV-stabilized. We use this for our windows. You can make your own windows by cutting a hole in your dome panel (do not cut the fabric that is tensioned under the poles of your dome) and by shingling a piece of clear vinyl inside the dome above the hole (underlapping) and outside below the hole (overlapping). A simple way to attach the vinyl is with our Sticky-Backed Velcro. The vinyl comes 48" wide, in any length.



**Price:** \$18 a yard, 48" wide, Under 6 yards, add \$10 for shipping; over 6 yards, shipping costs increase.

**Mosquito Netting:** Gray, 58" wide, 4 yards for \$50.00. Shipping costs included.

### **30-DAY RISK-FREE TRIAL 1 1/2-YEAR GUARANTEE**

Our guarantee is simple. **YOU MUST BE SATISFIED!** Everything in this catalog is offered for 30 days' free trial. If for any reason you're not completely pleased with your purchase, return it in original condition within 30 days of receipt for a full refund or exchange as you wish. All items in this catalog have a warranty against defects in materials and workmanship for **1 1/2 years**. Should any product prove defective we will repair or replace it at no cost to you. Special Orders are not returnable.

[To order.](#) by Fax or Mail.

[Order online with our Secure Order Form!](#)

**For fast credit card orders call 650-323-6202**

Questions? E-mail us at [shelter@best.com](mailto:shelter@best.com). Please feel free to call or write us anytime. Shelter Systems-OL, 224 Walnut St., Menlo Park, CA 94025. FAX 650-323-1220 Phone 650-323-6202.

[Shelters](#)

[Greenhouses](#)

[What's New?](#)

[Gillis Designs](#)

[Stories](#)

[Q's & A's](#)

[Price List](#)

[Shelter Systems' Map of Site](#)

**Shelter Systems** © 1996 - 2001 All Rights Reserved

[Shelter Systems' Home](#)



Shelters

Greenhouses

What's New?

Gillis Designs

Stories

Q's & A's

## Domes, Yurts, Tents and Greenhouses Go Up in 30 Minutes

**Shelter Systems domes are not kits.** You don't have to cut anything. You don't need any tools. Everything is in place and ready to assemble. All dome poles are the same length, and interchangeable - every pole will go in every other position. All window poles are the same length. Only the most general directions are required (and are provided with each dome, of course). Most people can put up the largest dome in 30 minutes. Shelter Systems domes create multipurpose enclosures that are affordable, portable, reliable, windproof and watertight.



Shelter Systems domes come to you in two packages of approximately equal weight (for the 18'er 30 lbs each).

Spread out poles and covering on top of floor.





Add poles to top of dome covering one pole at a time. Each pole is the same length so you cannot go wrong.

Continue to work your way around dome adding poles.



The poles bend slightly, adding tension to the covering and the dome begins to lift off the ground.

Before you know it, the last poles are added and your dome is up!

## Up In 30 Minutes!

Questions? E-mail us at [shelter@best.com](mailto:shelter@best.com). Please feel free to call or write us anytime. Shelter Systems-OL, 224 Walnut St., Menlo Park, CA 94025. FAX 650-323-1220 Phone 650-323-6202.

Shelters

Greenhouses

What's New?

Gillis Designs

Stories

Q's & A's

Shelter Systems © 1996 - 2001 All Rights Reserved

[Shelter Systems' Home](#)

[Shelters](#)[Greenhouses](#)[What's New?](#)[Gillis Designs](#)[Stories](#)[Q's & A's](#)

## Comparing Sizes of Yurts, Tents and Domes

People often ask how many people can sit, sleep or stand in a certain size **Shelter Systems'** yurt or dome. Study the drawings below to make size and volume comparisons of our different domes.

You can also mark a full-size circle on the pavement. Have a friend hold to the ground a string equal in length to one half the diameter of the dome you are wondering about. Walk around your friend, keeping the string tight. Use chalk or small rocks to mark a circle "drawn" by the end of the string. After you get your circle marked, put a sleeping bag, cot, chair, table, etc. inside the circle. You can also draw objects in the circle. Invite some friends over to size up your "dome." Draw some other sizes on the ground and compare.

### How to Visualize Interior Space Size

The best way to get an idea of the space inside the dome is to print out a picture of the dome. Then mark a circle on the ground or pavement with chalk or small stones that is the diameter of your Yurt Dome by having a friend hold a cord that is 1/2 the diameter of your Yurt Dome to the ground while you walk around him keeping the cord taught and marking the ground. Next have your friend stand in the circle while you back away from him holding the picture of your Yurt Dome at arms length till the Yurt Dome's diameter in the picture matches the diameter of the the circle you have marked on the ground. Now you can move the picture, keeping it at arms length, over top of your friend and it's base will match the circle. Your photo will be to scale with your friend. You can have him move about inside this "dome" and get a clear idea how much interior space is inside.

**A drawing comparing the sizes of 8'/2.4m, 11'/3.3m, 14'/4.2m, 18'/5.4m, and 20'/6m**

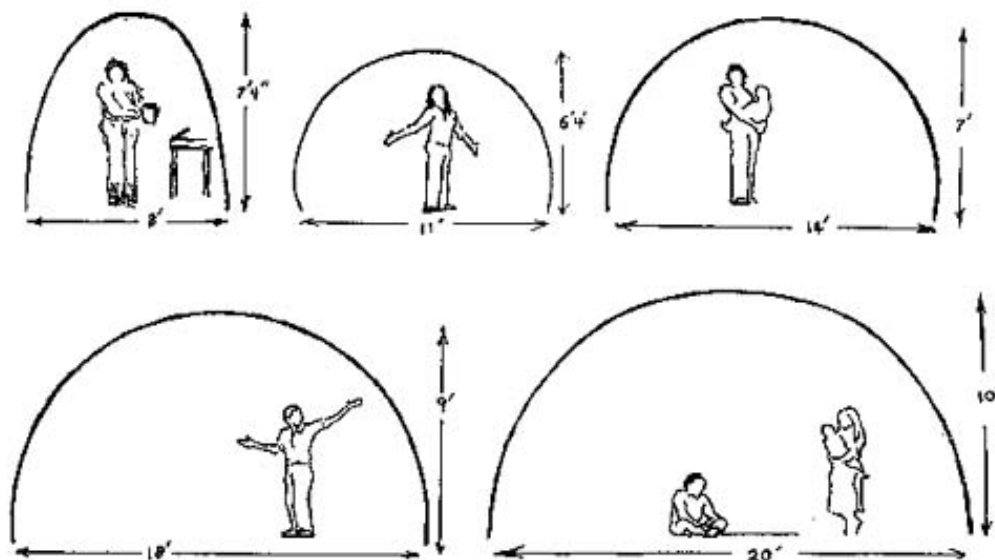

### Comparing the package size and weight, and door size of domes.

|                   | 8'-Yurt     | 11' Yurt  | 14' Yurt    | 18' Yurt    | 20' Yurt    | 30' Yurt    |
|-------------------|-------------|-----------|-------------|-------------|-------------|-------------|
| <b>Pkg Size:</b>  |             |           |             |             |             |             |
| <b>Poles</b>      | 40"x3"x3"   | 45"x3"x3" | 46"x8"x8"   | 57"x11"x11" | 64"x12"x12" | 62"x18"x15" |
| <b>Covering</b>   | 30"x 8"x 4" | 35"x8"x5" | 28"x13"x13" | 31"x24"x18" | 36"x18"x18" | 43"x23"x23" |
| <b>PkgWeight:</b> |             |           |             |             |             |             |
| <b>Poles</b>      | 8 lbs       | 9 lbs     | 22 lbs      | 39 lbs      | 40 lbs      | 112 lbs     |
| <b>Covering</b>   | 9 lbs       | 11 lbs    | 20 lbs      | 31 lbs      | 35 lbs      | 67 lbs      |
| <b>Door Size</b>  | 50"x 50"    | 55"x55"   | 42"x42"     | 51"x51"     | 64"x64"     | 69"x69"     |
| <b>Arch Open</b>  |             |           | 12'         | 15'         | 16.5'       | 24'         |

### Standable distance from wall and standable area for 6 feet or 1.8 meter person

|                     | 8'-Yurt  | 11' Yurt | 14' Yurt | 18' Yurt  | 20' Yurt  | 30' Yurt  |
|---------------------|----------|----------|----------|-----------|-----------|-----------|
| <b>ft from wall</b> | 2 ft     | 5 ft     | 3.4 ft   | 2.8 ft    | 2.1 ft    | 3.3 ft    |
| <b>m from wall</b>  | .6 m     | 1.5 m    | 1 m      | .86 m     | .64 m     | 1 m       |
| <b>sq feet</b>      | 28 sq ft | 1 sq ft  | 36 sq ft | 138 sq ft | 196 sq ft | 429 sq ft |
| <b>sq meters</b>    | 2.6 sq m | .09 sq m | 3.3 sq m | 12.8 sq m | 18.2 sq m | 40 sq m   |

### Relative size footprints

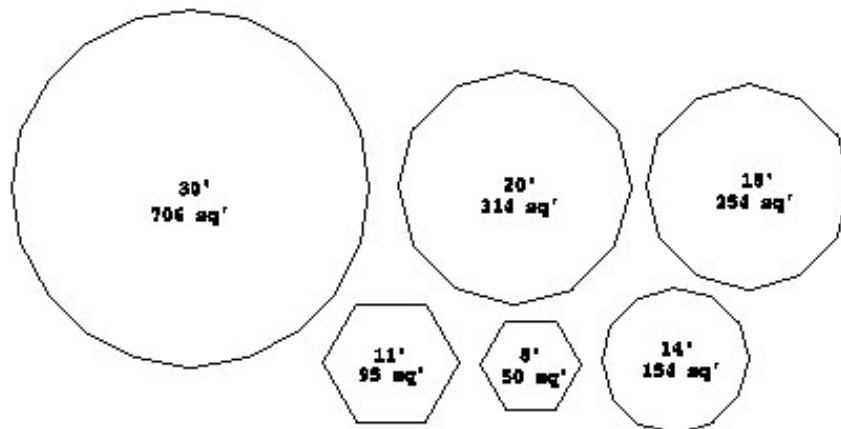

### Comparisons in square feet, square meters, cubic feet, and cubic meters per dome.

|              | 8'-Yurt  | 11' Yurt | 14' Yurt  | 18' Yurt  | 20' Yurt  | 30' Yurt  |
|--------------|----------|----------|-----------|-----------|-----------|-----------|
| <b>sq ft</b> | 50 sq ft | 95 sq ft | 154 sq ft | 254 sq ft | 314 sq ft | 706 sq ft |

|             |            |           |            |            |           |             |
|-------------|------------|-----------|------------|------------|-----------|-------------|
| <b>sq m</b> | 4.65 sq m  | 8.84 sq m | 14.32 sq m | 23.62 sq m | 29.2 sq m | 65.66 sq m  |
| <b>ft 3</b> | 183.5 ft 3 | 348 ft 3  | 718 ft 3   | 1526ft 3   | 2093 ft 3 | 4662.5 ft 3 |
| <b>m 3</b>  | 5.25 m 3   | 9.95 m 3  | 20.5 m 3   | 43.5 m 3   | 60 m 3    | 133 m 3     |

**The number of persons that can sleep in each dome.**

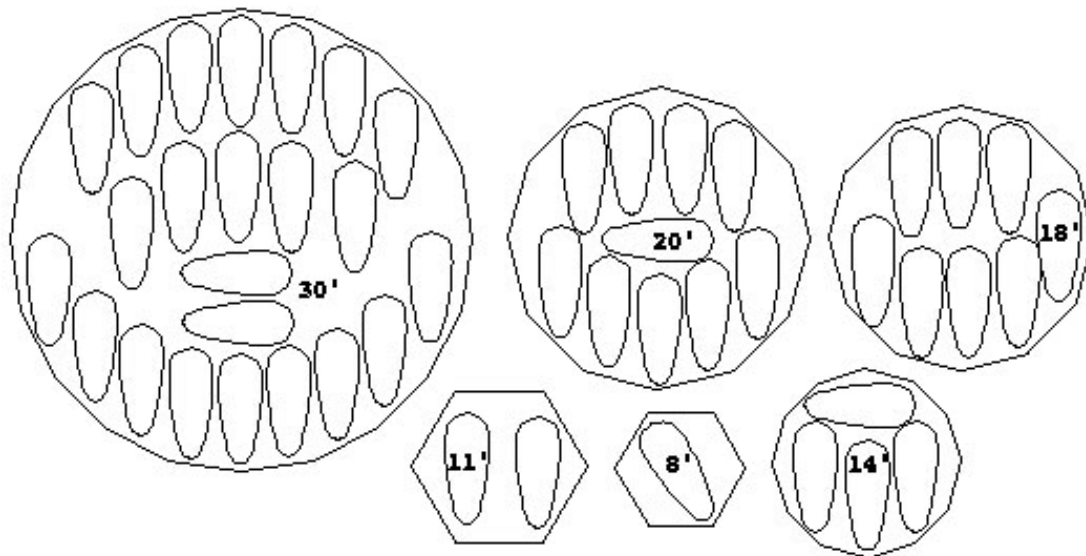

**Comparing the Width and Height of 14',18', 20', and 30' in [Domes with Arch Opened](#)**

| <b>Dome Size</b> | <b>Width of Opening</b> | <b>Height of Opening</b> |
|------------------|-------------------------|--------------------------|
| 14' dome         | 11' 6 "                 | 5' 6"                    |
| 18' dome         | 14' 6"                  | 7'                       |
| 20' dome         | 16' 6"                  | 7' 5"                    |
| 30' dome         | 23' 5"                  | 7' 4"                    |

**Relative volumes of the 30'er, 20' Bubble, 20'er, 18' Bubble, 18'er, 14' Bubble, 14'er, 10' Bubble, 11'er, and the 8'er**

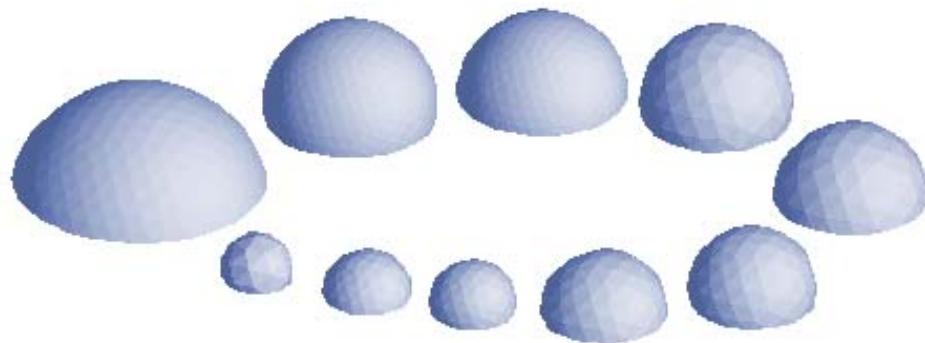

**Side view of 30'er, 20' Bubble, 20'er, and 18' Bubble**



**Side view of 18'er, 14' Bubble, 14'er, 10' Bubble, 11'er, and 8'er**



**30-DAY RISK-FREE TRIAL 1 1/2-YEAR GUARANTEE**

Our guarantee is simple. **YOU MUST BE SATISFIED!** If for any reason you're not completely pleased with your purchase, return it in original, clean condition within 30 days of receipt for a full refund or exchange as you wish. All items in this catalog have a warranty against defects in materials and workmanship for **1 1/2 years**. Should any product prove defective we will repair or replace it at no cost to you. Special Orders are not returnable. Read [Snow and Wind Warnings](#).

[To order](#). by Fax or Mail.

[Order online with our Secure Order Form!](#)

**For fast credit card orders call 650-323-6202**

Questions? E-mail us at [shelter@best.com](mailto:shelter@best.com). Please feel free to call or write us anytime. Shelter Systems-OL, 224 Walnut St., Menlo Park, CA 94025. FAX 650-323-1220 Phone 650-323-6202.

[Shelters](#)

[Greenhouses](#)

[What's New?](#)

[Gillis Designs](#)

[Stories](#)

[Q's & A's](#)

[Price List](#)

[Shelter Systems' Map of Site](#)

Shelter Systems © 1996 - 2001 All Rights Reserved

[Shelter Systems' Home](#)



Shelters

Greenhouses

What's New?

Gillis Designs

Stories

Q's &amp; A's

## Portable Greenhouses: The GroDome™

Shelter Systems' portable GroDome™ greenhouses provide controlled growing conditions your vegetables and flowers. The GroDome greenhouses are lightweight and freestanding so you can easily move them around your garden to improve the growing environment of different plants in different seasons. The portable GroDome greenhouses are easy to assemble--no tools are needed and they can be put up in 30 minutes,. You can use the portable GroDome greenhouse only when needed and move or take them down when not needed thereby freeing up more growing space. You will have plenty of room to work, store tools, build flats, hang potted plants, and care for mature plants in your GroDome greenhouse. Shelter Systems' greenhouses will shelter your plants from cold, rain, wind, frost, and birds. Your vegetables and flowers will thrive in your GroDome greenhouse.

### Useful All Year

GroDome™ is portable, so it has many seasonal uses. In spring you can place the greenhouse in your yard where it will collect the most sun and heat for your seedlings. In the spring you can set the GroDome greenhouse over soil to warm it and plant right in the ground. At the same time, you can use the GroDome greenhouse as a traditional greenhouse to start seedlings in flats. Then you can move the greenhouse and warm the soil somewhere else in your garden and plant directly in the soil. In regions not hot enough to grow certain crops like melons, you can use the greenhouse to create the heat required to grow hot plants that require a hot summer. In fall you can set the GroDome greenhouse over tomatoes and peppers to prolong the harvest. In winter, you can put the greenhouse over a cactus garden to keep the rain off or put it over a fig tree or other cold-sensitive plants.



**GroDome™ 20**

### Affordable

The GroDome uses a patented [Geotensic™](#) structure and fasteners that make it possible for us to construct a greenhouse that is extremely strong for its weight and one that uses less material than other greenhouses. It is lightweight so its fairly inexpensive for us to UPS it to you. Shelter Systems' greenhouses are easy to take it down when you do not need them, say in the heat of the summer or the dark of the winter. Storing your greenhouse will both create more room in your garden to grow things and prolong the life of your greenhouse. Since you can move your greenhouse to different places in your garden you will not have the expense or trouble of replacing the soil in your greenhouse to avoid pathogens that will otherwise collect in soil after a few

years. Your GroDome greenhouse will quickly repay its initial cost in the increased choice, quality and quantity of the plants you can grow.

### Other Uses

Your GroDome greenhouse has many uses in and out of the garden. With your GroDome greenhouse you will have plenty of room to work, store tools, build flats, hang potted plants, and care for mature plants. Since your greenhouse will not leak you can use your greenhouse as a shed to keep tools and equipment dry. You can use it to store mulch, potting soil and fertilizers.

### Sturdy Design

The GroDome's covering is made of Shelter Systems' superstrong, woven, translucent, ripstop [greenhouse film](#), which lets 90% of the sunlight through (more than glass does). Our greenhouse cover was specifically designed for greenhouse use. It is treated with ultraviolet inhibitors, which protect it against sun exposure. It will last years of continuous use even the sunniest parts of the country. The greenhouse covering will not rot or mildew. The greenhouse's frame is constructed of strong, long-lasting PVC tubing. Patented [Grip Clips](#) join the GroDome's cover to the frame. Grip Clips provide greater strength than sewn seams or any type of grommet, because they do not puncture the cover. Each panel of the greenhouse is [shingled](#) over the next so that the greenhouse breathes, yet is completely leakproof! Shelter Systems' greenhouses are made from all the same high quality components that we use to manufacture our [shelters and tents](#).



### [Up In 30 Minutes!](#)

You will be pleased with how easily your GroDome greenhouse goes [up in 30 minutes](#) without tools. You simply insert interchangeable poles into connectors spaced evenly over the greenhouse cover. The poles bend slightly when inserted, which tightens the cover into a wind- and waterproof dynamic greenhouse. The greenhouse is freestanding so you can turn or move the greenhouse into any desired position. If for some reason, your GroDome greenhouse is not being used, just take out the poles, roll up the greenhouse, and store it in a closet or on a shelf.

### Light and Fresh Air

The GroDome 14', 18', and 20' greenhouses each have four flap doors evenly spaced around the dome. The GroDome 8' and 11' greenhouses each have one door. The door coverings close automatically so you can go in or out quickly. There are no zippers to fumble with or break. For maximum ventilation the walls themselves can be rolled up. There is always plenty of light and fresh air in your GroDome greenhouse.

### A Shelter System

Each GroDome greenhouse comes with poles, stakes, guylines, vent tubes, a detailed [Instruction Manual](#) and [Shelter Systems Gardening Manual](#).

### [Accessories](#)

Net Doors, Porches, Liners, etc.



### GroDome™ 8

**Transparent fabric is used in this photo to show the interior;  
the actual greenhouse fabric used is shown in the above GroDome 20.**

Be sure to look at our [Bubble Dome™ Greenhouses](#) which are taller forms of our GroDomes and our new [Solar Shed™: Compact Greenhouse](#)

**[GroDome 30 Greenhouse](#) Diameter 30'x11' High, 706 sq', Weight 190lb. \$1900 Shipping \$160**

**GroDome 20 Greenhouse Diameter 20'x10' High, 314 sq', Weight 70 lb. \$860 Shipping \$55**

**GroDome 18 Greenhouse Diameter 18'x9' High, 254 sq', Weight 60 lb. \$720 Shipping \$45**

**GroDome 14 Greenhouse Diameter 14'x7' High, 154 sq', Weight 40 lb. \$620 Shipping \$40**

**GroDome 11 Greenhouse Diameter 11'x6'4" High, 95 sq', Weight 20 lb. \$450 Shipping \$35**

**GroDome 8 Greenhouse Diameter 8'x7'4" High, 50 sq', Weight 20 lb. \$360 Shipping \$35**

[Sizes:](#) Drawings and tables comparing the dome and door and package sizes, shapes, weights, volumes, and square/cubic feet and meters of 8'er, 11'er, 14'er, 18'er, and 20'ers.

Note that the GD11 and GD8 are constructed using a different geometry that has less panels and only one door. You can see the shape of the GD11 near the bottom of the [Archeology](#) page. The 14, 18, or 20' greenhouses each have four doors. You get a lot more volume for your money as you go up in diameter. When you step inside the 18' greenhouse after just being in the 14' greenhouse, the 18' greenhouse feels twice as big. The 20' greenhouse feels twice the size of the 18' greenhouse. This is because the extra feet in diameter extends out in all directions creating a large increase in volume. Since the surface area of the covering does not increase as rapidly as the volume, the larger greenhouses are less expensive for the space you get.

[Happy Customers:](#) Tell about their experiences with Shelter Systems' domes. Photo rich.

*"Thank you so much for my 14 foot greenhouse. I never thought it would be so easy to assemble. It is a true work of art in my back yard. Keep up the good work." Thanks, Steve Farrell*

### **30-DAY RISK-FREE TRIAL 1 1/2-YEAR GUARANTEE**

Our guarantee is simple. **YOU MUST BE SATISFIED!** If for any reason you're not completely pleased with your purchase, return it in original, clean condition within 30 days of receipt for a full refund or exchange as you wish. All items in this catalog have a warranty against defects in materials and workmanship for **1 1/2 years**. Should any product prove defective we will repair or replace it at no cost to you. Special Orders are not returnable. Read [Snow and Wind Warnings](#).

[To order.](#) by Fax or Mail.

**[Order online with our Secure Order Form!](#)**



**For fast credit card orders call 650-323-6202**

Questions? E-mail us at [shelter@best.com](mailto:shelter@best.com). Please feel free to call or write us anytime. Shelter Systems-OL, 224 West O'Connor St., Menlo Park, CA 94025. FAX 650-323-1220 Phone 650-323-6202.

[Shelters](#)

[Greenhouses](#)

[What's New?](#)

[Gillis Designs](#)

[Stories](#)

[Q's & A's](#)

[Price List](#)

[Shelter Systems' Map of Site](#)

**Shelter Systems** © 1996 - 2001 All Rights Reserved

[Shelter Systems' Home](#)

[Shelters](#)[Greenhouses](#)[What's New?](#)[Gillis Designs](#)[Stories](#)[Q's & A's](#)

## Greenhouses: The GroRow™

Shelter Systems' **GroRow™** is named after its long cylindrical shape and its use in the garden. The GroRow is very quick to assemble and converts easily between two shapes, depending on your gardening needs. It has a sturdy translucent greenhouse covering and frame.

With the GroRow you'll be able to double your growing season. Start earlier and garden later in the year. Protect newly sown seed and seedlings from cold, birds, frost, snow, etc. Grow a wider variety of foods and plants than ever before. Use the GroRow to dry and warm garden soil for pre-spring planting. In cool climates, cover mature tomato, eggplant, and peppers to set and ripen fruit. Use your GroRow as a mini-shed to protect your tools and equipment. The GroRow is also ideal for drying and storing firewood. GroRows are available in 7' and 10' sizes made of our special translucent greenhouse fabric.



**GroRow™ 7**

### Sturdy Design

The [GroRow's cover](#) has been developed for greenhouse applications with UV stabilizers for long life. It is reinforced with woven fibers to prevent tears and to withstand high winds. The cover transmits 90% of visible light (most plants require 65-85% for optimum growth), and unlike glass or clear vinyl, its diffused rays won't burn your plants. The frame is PVC tubing for strength and longevity. Patented clips applied to the cover join and support without puncturing or weakening.

### Easy Set-Up

You will be pleased with how easily your **GroRow™** goes up in five minutes without tools! You simply insert interchangeable poles into connectors spaced evenly over the cover (connectors are factory attached). The poles are bent slightly when inserted and this tightens the cover into a windproof, dynamic gardening tool. When assembled, the GroRow is self-supporting and does not depend on anchors. This means it can be lifted with one hand to water and is easy to move about.



### Gro-Row™ 10

#### **Converts to Tall Storage or Large Plant Use**

The GroRow transforms into a taller, wider size: 4' tall, 5'6" wide, 5'6" long. Just pull on the sides and it pops into a new shape. This size offers better coverage for wider beds, mature plants or equipment. The ability to change size greatly increases its versatility and usefulness. GroRow is a year-round helper.





**GroRow™ 10 transforming from long to a taller size.**



**GroRow™ 7 set up against a building makes a great greenhouse or shed. See our [SolarSheds](#).**

**GroRow 7:** 3' wide x7' long x 20" high \$68 Shipping \$20

**GroRow 10:** 3' x10' x 20" \$98 Shipping \$25

### [GroRow Instructions](#)

[Happy Customers:](#) Tell about their experiences with Shelter Systems Domes. Photo rich.

### **30-DAY RISK-FREE TRIAL 1 1/2-YEAR GUARANTEE**

Our guarantee is simple. **YOU MUST BE SATISFIED!** If for any reason you're not completely pleased with your purchase, return it in original, clean condition within 30 days of receipt for a full refund or exchange as you wish. All items in this catalog have a warranty against defects in materials and workmanship for **1 1/2 years**. Should any product prove defective we will repair or replace it at no cost to you. Special Orders are not returnable. Read [Snow and Wind Warnings](#).

[To order.](#) by Fax or Mail.

[Order online with our Secure Order Form!](#)

**For fast credit card orders call 650-323-6202**

Questions? E-mail us at [shelter@best.com](mailto:shelter@best.com). Please feel free to call or write us anytime. Shelter Systems-OL, 224 Walnut St., Menlo Park, CA 94025. FAX 650-323-1220 Phone 650-323-6202.

[Shelters](#)

[Greenhouses](#)

[What's New?](#)

[Gillis Designs](#)

[Stories](#)

[Q's & A's](#)

[Price List](#)

[Shelter Systems' Map of Site](#)

**Shelter Systems** © 1996 - 2001 All Rights Reserved

[Shelter Systems' Home](#)



Shelters

Greenhouses

What's New?

Gillis Designs

Stories

Q's &amp; A's

## Freestanding, Lightweight, and Portable Tunnel Greenhouse

The translucent **CrystalCave™ Greenhouse** will protect your plants against birds, harsh weather and frosts. You can also use it to get the soil nice and warm earlier in the year. Because our tunnel greenhouse is lightweight, it's movable. So you can easily move it where you need it next. There is adequate space for full-sized plants, with ample space for the gardener and tools, too! We have seen it in use with several layers of seed flats and shelves inside along the length of each side. CrystalCaves can be placed end to end to produce a longer enclosure. It's amazing how much faster your plants will grow inside a CrystalCave greenhouse.



CrystalCave™ 11 made of translucent greenhouse [material](#).



The interior of a CrystalCave™ being used as a greenhouse.

### Easy Set-Up

Your CrystalCave arrives with all hubs and clips attached. Just slip the interchangeable poles into the hubs and in 40 minutes your CrystalCave is complete. It's very easy. Once up, you may lift or turn your CrystalCave into position. If your CrystalCave needs to be transported or stored, it can be disassembled in 5 minutes by removing the poles and rolling it into a compact bundle. You can dramatically extend the sun life of your CrystalCave by storing it during the seasons when not in use.



### Sturdy Design

The strong, woven, laminated [ripstop film](#) used in all our structures has been treated with ultraviolet inhibitors to insure extra long life. The translucent covering used in this greenhouse transmits 90% of visible light. (Most plants require at least 65% for optimum growth). The light is diffused so your plants will never get burned the way they can under glass or clear vinyl. Unique to Shelter Systems' structures are the molded clips at each hub. They are made of an extremely durable plastic. The importance of these components lies in the fact that they grip the film without puncturing it - there are no weak points to tear out in Shelter Systems structures.

### Proven Performance

The tension achieved by the network of hubs and poles keeps the film stretched tight in the wind, preventing tear through wind vibration. The CrystalCave's doors (one at each end) have been designed to bypass the need for zippers. We use hook closures. Zippers are notorious for breaking after a short working life. Our experience has shown that, without them, our doors can't malfunction! An added benefit: there is no sill of material spanning the entrance at ground level. This means that when the doors are open, you have complete access for rolling wheeled carts in and out.

The CrystalCave comes complete with clips and connectors attached to covering, poles, stakes, hooks for hanging potted plants, and instruction manual.

**CrystalCave™ Greenhouse 9:** 9'x9'x7' High, Weight: 40 lb.. **\$550** Ship \$45

**CrystalCave™ Greenhouse 11:** 11'x11'x7' High, Weight: 51 lb.. **\$680** Ship \$55

**Crystal Caves are by special order only.**

Be sure to look also at our [CrystalCave Shelter](#).

### 1 1/2-YEAR GUARANTEE

All items in this catalog have a warranty against defects in materials and workmanship for **1 1/2 years**. Should any product prove defective we will repair or replace it at no cost to you. Special Orders are not returnable; since we do not offer them in our catalog and we would have trouble reselling them.

[To order.](#) by Fax or Mail.

[Order online with our Secure Order Form!](#)

**For fast credit card orders call 650-323-6202**

Questions? E-mail us at [shelter@best.com](mailto:shelter@best.com). Please feel free to call or write us anytime. Shelter Systems-OL, 224 Walnut St., Menlo Park, CA 94025. FAX 650-323-1220 Phone 650-323-6202.

Shelters

Greenhouses

What's New?

Gillis Designs

Stories

Q's & A's

[Price List](#)

[Shelter Systems' Map of Site](#)

**Shelter Systems** © 1996 - 2001 All Rights Reserved

[Shelter Systems' Home](#)





Shelters

Greenhouses

What's New?

Gillis Designs

Stories

Q's & A's

## SolarShed™ Greenhouse Shed

Your Shelter Systems' **SolarShed™ Greenhouse Shed** will, within 15 minutes of your receiving it, begin to serve you. Start seedlings, overwinter plants, store tools and bikes, dry firewood, etc. Shelter your plants from cold, rain, wind, frost, and birds. Start plants sooner in the spring and keep them growing later in the fall.

SolarShed Greenhouse Shed is made entirely of translucent greenhouse fabric. The Solar Shed is lightweight which means you can move it around easily. Clips with cords are provided to attach your SolarShed Greenhouse Shed to your fence or wall.



### Sturdy Design

The **SolarShed™ Solar Greenhouse Shed's** covering is a superstrong woven, translucent, [greenhouse ripstop film](#). It is treated with ultraviolet inhibitors, which protect it against sun exposure. The covering will not rot or mildew. The greenhouse's frame is constructed of strong, long-lasting PVC tubing. Patented Grip Clips join the Solar Shed cover to the frame. Grip Clips provide greater strength than sewn seams or any type of grommet, because they do not puncture the cover. The greenhouse extends over the two doors, so that the greenhouse breathes yet is completely leakproof!



### **Up In 15 Minutes!**

You will be pleased with how easily your **SolarShed™ Solar Greenhouse Shed** goes up in 15 minutes without tools. You simply insert interchangeable poles into connectors spaced evenly over the cover. The poles bend slightly when inserted, which tightens the cover into a wind- and waterproof dynamic shelter. Turn or move the dome into desired position. If for some reason, your SolarShed Greenhouse Shed is not being used, just take out the poles, roll up the Solar Shed, and store it in a closet or on a shelf.

### **A Shelter System**

Each Solar Shed Greenhouse Shed comes complete with two doors, stakes for anchoring to ground, eye screws for attaching to house or fence, a detailed [SolarShed Instruction Manual](#) and "[Gardening with Your Shelter Systems' Greenhouse.](#)"

**SolarShed™ Greenhouse Shed 3'x5.5'x6' Tall. \$185. Shipping \$20**

Affordable, Lightweight, Portable Compact Greenhouse Shed, Also Useful for Bike and Firewood Storage

**SunShade \$25. Shipping \$15.** Made of Shelter System's silver and black shade material. If you plan to use the Solar Shed as storage space, you may wish to use a SunShade to protect the stored items from the damaging effects of the sun's heat and ultraviolet rays. Comes complete with grips and cord for attaching it to the outside poles of the Solar Shed.

**Solar Shed Floor \$20. Shipping \$8.** Made of same tear-resistant material as the Solar Shed. Useful if you plan to use the Solar Shed as storage and wish to exclude the earth's dampness.

### **30-DAY RISK-FREE TRIAL 1 1/2-YEAR GUARANTEE**

Our guarantee is simple. **YOU MUST BE SATISFIED!** If for any reason you're not completely pleased with your purchase, return it in original, clean condition within 30 days of receipt for a full refund or exchange as you wish. All items in this catalog have a warranty against defects in materials and workmanship for **1 1/2 years**. Should any product prove defective we will repair or replace it at no cost to you. Special Orders are not returnable. Read [Snow and Wind Warnings](#).

[To order](#). by Fax or Mail.

[Order online with our Secure Order Form!](#)

**For fast credit card orders call 650-323-6202**

Questions? E-mail us at [shelter@best.com](mailto:shelter@best.com). Please feel free to call or write us anytime. Shelter Systems-OL, 224 Walnut St., Menlo Park, CA 94025. FAX 650-323-1220 Phone 650-323-6202.

Shelters

Greenhouses

What's New?

Gillis Designs

Stories

Q's & A's

[Price List](#)

[Shelter Systems' Map of Site](#)

Shelter Systems © 1996 - 2001 All Rights Reserved

[Shelter Systems' Home](#)

## **Animation of a LightHouse 18 Set up**



**Shelter Systems Domes are not kits.** Everything is in place and ready to go. All poles are the same length, and interchangeable - every pole will go in every other position. All window poles are the same length. Only the most general directions are required (provided with each dome, of course). Most people can put up the largest dome in 30 minutes. Shelter Systems domes create multipurpose enclosures that are affordable, portable, reliable, windproof and watertight.

[LightHouse 18 Up In 30 Minutes!](#) The LightHouse 18 set up step by step.

[LightHouse 14 Up in 20 Minutes!](#) The LightHouse 14 set up.

Questions? E-mail us at [shelter@best.com](mailto:shelter@best.com) Please feel free to call or write us anytime. Shelter Systems-OL, 224 West O'Connor St., Menlo Park, CA 94025. FAX 650-323-1220 Phone 650-323-6202.

[Shelter Systems' Map of Site](#)

© 1996 and 1998 Shelter Systems All Rights Reserved

[Shelters](#)[Greenhouses](#)[What's New?](#)[Gillis Designs](#)[Stories](#)[Q's & A's](#)

# Greenhouse Gardening Manual

## GARDENING WITH YOUR SHELTER SYSTEMS' GREENHOUSE

Your Shelter Systems greenhouse will allow you to sow and harvest crops months earlier than you could otherwise in temperate climates or cool locations. Your growing season will be extended and your annual yield should increase. Certain crops can be harvested continuously and frost-tender plants can be protected with your greenhouse. You'll be able to raise many plants from seed. Growing from seed allows you to pick any variety you choose, rather than just the expensive, narrow selection offered by a nursery. You can grow plants not local to your area and protect special plants from environmental extremes. The relatively high temperature your greenhouse creates can increase the quality and yield of tomatoes and eggplants.

Your Shelter Systems greenhouse will repay its initial cost in the increased choice, quality and quantity of the plants you can grow, and the space it takes up could not be put to a better use!

### SITE SELECTION

Take some time to think about where to put your greenhouse. Choose a place that has good sun exposure. Remember that a site with good sun in the summer will not necessarily have good sun in the winter. The same spot might be shaded by trees or tall buildings. As the shortest day of the year approaches, the sun's angle to the horizon decreases.

Your greenhouse will get more use, and the plants in it will get more care if you have easy access. The best site is often close to your home if it is not shaded. If you attach your greenhouse to your house you can use the same heating system as -your home, if you decide to have a heated greenhouse.

A site in your garden is a good idea also, since the soil there is likely to be rich and drain well. This will allow you to garden right in the soil in your greenhouse. Since Shelter Systems' greenhouses are very easy to move you'll be able to move it about in your garden to plant a succession of crops and there by avoid diseases and pests that would otherwise accumulate and become a problem.

If your chosen site does not drain well, then prepare the soil so it will drain. Try for a spot that is protected from the coldest prevailing winds. The stronger and colder the winds blowing across your greenhouse, the greater the heat loss. Shelter can be provided, if a suitable site is unavailable, by planting a hedge or building an open weave fence.

Ideally your site should be level. If your site is not, move and conserve topsoil to create level site. Do not compact the soil as this damages the soil structure and can lead to drainage problems and loss of fertility.

Access to electricity can be handy for automated fans, heaters, misters and propagators but is generally not needed unless you plan a heated greenhouse.

Heating can be prohibitively expensive and many plants can be grown in a greenhouse with out heating.

### AVOID OVERHEATING!

Your greenhouse is designed to collect and store solar heat.

If the temperature inside your greenhouse gets too hot, your plants will wilt and die. Try to develop a daily routine that maintains an optimum temperature. It takes but one hot hour to destroy all your work. It is better to leave your greenhouse open, and have it be a little cool, than to kill your plants with heat.

To monitor the temperature of your greenhouse, set up a thermometer inside, in the shade, and at the level of your plants (a minimum-maximum thermometer is preferred). The usually excepted optimum temperature for most plants is 80' F. At higher

temperatures your plant's growth will decrease and they may die if they get too hot, too long. Use your thermometer to record the daily extremes of temperature, and try by careful ventilation and heating adjustments, to even out the differences as much as possible.

## **TOO COLD**

Lower temperatures decrease plant vigor and growth. Consider adding "thermal mass" to your domes interior in the form of containers of water. Buckets, jugs, and drums work good. Flats can be set on them. The water will absorb heat in the day and give it off at night. Electric propagators, heaters, and clean burning heaters are effective in a cold spell in keeping the frost away.

## **DAILY ROUTINE**

Make a good path to your greenhouse and walk it everyday.

It is important to establish a regular daily routine when greenhouse gardening. Failure to do so will lead to disappointments and the failure of seedlings and young plants.

An example of a daily routine might be: If the day dawns clear and warm be sure to visit your greenhouse by midmorning. Check the temperature. If it is higher than preferred, or is rising rapidly, open doors and set vent tubes so the temperature will come down and stays at an appropriate level all day. Consider damping down your plants but save the main watering until later in the day.

For the first few days, check the temperature several times and open the doors more and/or provide more vents if Necessary to maintain desired control. Additional "vent tubes" can be made of 3"-4" plastic pots or cans. Late afternoon or evening, visit your greenhouse and close it up, when there is no longer a danger of over heating. Water your plants and flats at this time if they need it.

Once you become more experience you will be able to know how much ventilation is necessary and you will not need to check out your greenhouse, except in the morning and towards evening.

## **STALE AIR**

Stale air is bad for plants. Your dome's shape will help to create healthy convection currents of air. Also, the small spaces around the dome's doors will provide a much change of air. To not make your dome air tight.

## **DOORS**

The doors of your greenhouse should close with a slight tension on the covering. You can adjust them by removing and moving the door clips. Follow the instructions given. If the lower door span is too wide to allow doors to close, move the stakes at the door's base towards each other 1" to 3" This should correct the span. The small gap around the doors is important to provide fresh air. Do not seal up doors tight or stale air will develop. To wheel in tools and soil, unhook doors fully. To simplify opening and closing doors when you just need to check out your plants, try leaving the ground hook attached and release only the hook at chest level. This creates a triangular opening which you can step through.

## **SHADING**

Resort to shading only if your plants are shade loving ones, **or** if all other methods of cooling do not work. The reason for this is that shading decreases the available light to your plants, and slows their growth.

## **STARTING SEEDLINGS**

Setting up flats is a proven method. Set the flats off the ground. It will be easier to work with the seedlings and the soil will be warmed all around. Purchase flats from your local nursery or make them of wood. A small table can be used to hold your flats, or you can support them with 55 gallon barrel, jugs or cinder blocks. You can build a bench for holding your seedlings by driving 2" X 2"s into the ground to create 4 upright posts on which to set your seed flats.

Obtain or make a good soil mix for starting your seedlings. one mix you can make is 1/3 garden soil and 1/3 well seasoned compost and 1/3 sand. Mix well and spread in flats. Plant seeds as directed on the seed package in rows about 3" apart. Plant a small number of seeds every week of two of each type of plant. Then you can be assured of a continual harvest later on.

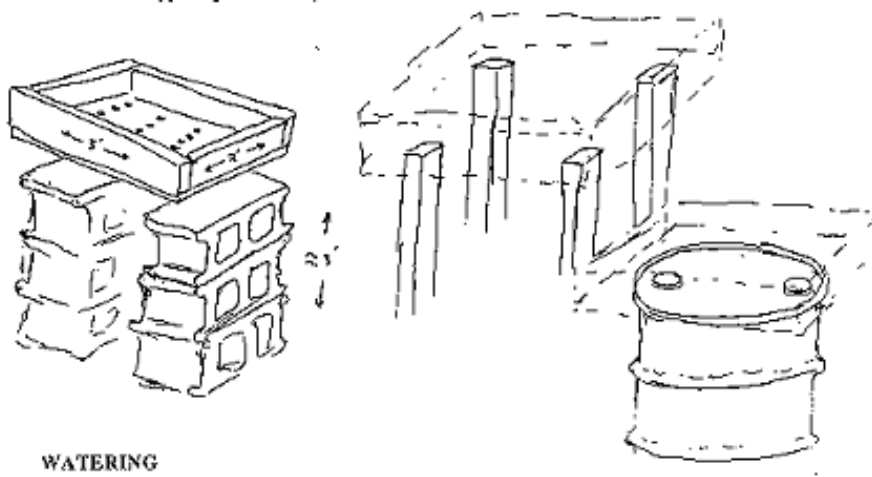

WATERING

## WATERING

Water lightly to avoid causing the seeds to float up to the surface. Keep the soil damp at first but not soggy wet. If your soil turns green you are watering too much. When the seedlings are up they can be thinned if necessary, and weeded. After they reach 2" to 3" high, transplant in the garden.

## FEEDING

Properly formulated soil mixes contain nutrients needed for at least the initial stages of plant growth. As these nutrients become depleted "feed" your plants with a balanced fertilizer designed for your plants. Follow directions, being careful not to over feed as this is much worse than under feeding. One type of feeding mixture is liquid seaweed. Another is homemade animal-manure tea: Fill a burlap sack @2 full of animal droppings. Hang from a stick in a bucket so it is covered with water. After two weeks remove sack and your tea is ready to use. Tomatoes and cucumbers demand feeding each time you water.

## GROWING VEGETABLES IN YOUR GREENHOUSE

You can grow to maturity many garden vegetables right in the soil of your greenhouses. The soil should be rich and drain well. Sow the plant as you would in the garden, but plant earlier. Since Shelter System's greenhouses are easy to move you'll be able to outrun diseases and pests by moving your house to new soil each time you plant. Another way to go is to start a crop at one site in early spring e.g. salad plants, then as the season advances leave the crop to mature in the open and move your house to a new site; where you can start, for example, your tomatoes, early. Never grow the same crop in the same spot two years in a row. Heat loving plants like tomatoes and eggplants can be grown in bags of soil mix by planting right in the bags. Watch you don't over water, since there should be no drainage holes in the bags. They also grow vigorously on bales of wheat straw. The idea is to provide a disease free root run. Set bales on polyethene. Apply a liberal amount of nitrogen rich manure. Water until manure enters bales and they are thoroughly wet. This triggers fermentation, heat builds up and carbon dioxide is given off. Both are good for young plants which are placed on mounds of soil on the bales. To determine the right time to plant: test the temperature in the bales every few days during the fermentation; plant when it drops to 100' F.

## FRUIT

Most permanent fruit plants occupy little space if they are confined to the wall or roof of the house. Some grapevines may exclude light but only during the summer when shading is often welcome. A vine or a peach is certainly worth considering as the fruit will be far superior to those produced outside.

## DECORATIVE PLANTS

Many flower and foliage plants can be cheaply raised from seed and used either as house plants or to decorate the greenhouse itself. The range of possible plants is almost limitless and they will require no heat in most areas once frost danger is over. Grow your plants in peat mixture, potting mixture or your own soil-based medium, depending on your preference. Feed them all with liquid seaweed or animal manure tea while they are growing vigorously.

## **GRO-ROWS**

In temperate climates, the earliest crops have to be sown in a heated greenhouse but the sowing dates of many vegetables can be brought forward by at least a month by using Gro-Rows outside with no heating. After raising an early crop of salad plants, cover frost-tender vegetables like squashes, beans, and tomatoes. Since you will harvest these well before outside sown crops are ready, you'll be eating them while shop prices are still high. At the end of the season, the Gro-Rows can be used again to grow late vegetables while those in the outside garden are finished. Once you have used Gro-Rows, you will not want to be without them. They will certainly pay for themselves easily in the first season.

## **GRO-ROWS THROUGH THE SEASONS**

### January

Put your Gro-Rows over soil one month before planting.

This will dry and warm the soil. Do not close the ends.

### Early Spring

Protect newly sown seed and seedlings.

### Summer

In cool climates, cover mature tomatoes, egg plants and pepper plants to set and ripen fruit.

### Winter

Use Gro-Rows to protect alpine and cactus from rotting in wet soil. Gro-Rows also make handy covers for compost and equipment.

## **GREENHOUSE TIMING**

### January

Plan year's crops; order seeds and seedlings. Sow onions in flats. Sow radishes in greenhouse soil. Bring in bulbs to flower in greenhouse. When bulbs are dome flowering, plant outside. Ventilate greenhouse on sunny days. February  
Ventilate when needed. Water sparingly. Sow lettuce, carrots, beets, parsnips, and bulb onions. Sow tomatoes with additional heating such as an electric propagator or composting manure. Bring in more bulbs to replace those that have flowered. Pot or divide ferns.

### March

Sow lettuce, celery, mustard, and cress. Sow with additional heat eggplants, peppers, beans, tomatoes. Thin lettuce seedlings (put out at end of March). Sow leeks, celery, peas, corn. Bring in more strawberries in pots. Sow alpine. Take ornamental cuttings. Plant more bulbs in pots. Plant out rooted cuttings from winter. Sow half hardy annuals and alpine.

### April

Sow more lettuce, radish, mustard, cress, endive, parsley, corn, beans, and cucumbers. Pick radishes and lettuce. Thin and begin to harden off seedlings. Take cuttings.

### May

Plant eggplants, sweet peppers, okra, cucumbers and melons. Harvest early carrots turnips and beets. Plant out tomatoes after last frost. Harden off more seedlings and plant out after frosts are over. Sow for winter flowers.

### June



Harvest lettuce, radish, beans, etc.

July

Harvest peppers, lettuce, tomatoes in greenhouse etc.

August

Sow lettuce, radishes, alpine strawberries. Plant apricots, peaches, and grape vines. Harvest lettuces etc. Sow hardy annuals for spring flowering in greenhouse. Pot hardy biennials for spring flowering. Plant bulbs.

October

Sow lettuce for spring. Plant fruit trees. Bring in tender perennials for over wintering. Sow annuals. Sow sweet peas.

November

Sow onions for transplanting. Box up rhubarb crowns, chicory (insulate if needed). Bring in pots of herbs for winter supply.. Plant grapevines. Bring bulbs into greenhouse as shoots appear.

December

Harvest chicory. Bring in bulbs for spring flowering. Clean greenhouse.

## **HAPPY GREENHOUSE GARDENING**

This booklet will give you general information about how to use your greenhouse effectively. However, it does not contain the detailed information that would better enable you to utilize all your greenhouse's growing potential. We therefore strongly recommend that you obtain some of the many excellent books on gardening in greenhouses from your library or bookstore.

## **REPAIRS**

A broken pole can be repaired with a wooden insert such as a broom handle. Or replaced with class 200 or 125 PVC from a plumbing, hardware or building supply store.

Broken connectors can be replaced with class 200 or scq. 40 11-4" PVC. Cut to 5", and drill **1-4"** hole in the center.

## **WARNING:**

**Wear eye protection when setting up you dome. The domes' poles could break and parts of the pole could fly toward your face.**

**In heavy snow your dome could collapse which could damage what you have in it or compromise your shelter.**

**Your dome will blow away if it is not anchored properly. Study the anchoring instructions carefully and apply all appropriate means to secure your dome to the earth. Rain will soften the ground and greatly reduce the holding power of the stakes. We provide good general purpose stakes, but they cannot cover all ground conditions. Wind will at times come up unexpectedly. Be prepared!**

**Remember that the dome is a lightweight, portable structure. Its strength comes from tension, not mass or rigid components. Exposed sites with unusually extreme winds are not recommended. It is apparent that you could not climb on top of the dome, nor can you expect it to support heavy snow loads. Accumulated snow, must be melted or shaken off periodically.**

**Keep all flames and heat away from your domes covering and other objects in your dome.**

### **30-DAY RISK-FREE TRIAL 1 1/2-YEAR GUARANTEE**

Our guarantee is simple. **YOU MUST BE SATISFIED!** If for any reason you're not completely pleased with your purchase, return it in original, clean condition within 30 days of receipt for a full refund or exchange as you wish. All items in this catalog

have a warranty against defects in materials and workmanship for **1 1/2 years**. Should any product prove defective we will repair or replace it at no cost to you. Special Orders are not returnable. Read [Snow and Wind Warnings](#).

[To order](#) by Fax or Mail.

[Order online with our Secure Order Form!](#)

**For fast credit card orders call 650-323-6202**

Questions? E-mail us at [shelter@best.com](mailto:shelter@best.com). Please feel free to call or write us anytime. Shelter Systems-OL, 224 Walnut St., Menlo Park, CA 94025. FAX 650-323-1220 Phone 650-323-6202.

[Shelters](#)

[Greenhouses](#)

[What's New?](#)

[Gillis Designs](#)

[Stories](#)

[Q's & A's](#)

[Price List](#)

[Shelter Systems' Map of Site](#)

**Shelter Systems** © 1996 - 2001 All Rights Reserved

[Shelter Systems' Home](#)



Shelters

Greenhouses

What's New?

Gillis Designs

Stories

Q's & A's

## Grip Clip Header Card

This header card is attached to the Grip Clips which Shelter Systems sells in stores. Inquire for dealership.



**Attaching Grip Clips™**

1. Slip cord through ear-holes of larger ring and knot.
2. Place material over small ring with flared side facing up.
3. Push small ring through the larger ring.
4. Turn the smaller ring so it seats snugly. Pull tarp tightly to lock in position.
5. To remove the Grip Clip, simply reverse the procedure.

© 1998 Shelter Systems  
650.323.6202 www.gripclips.com



98822\*80908

**Create what you need**



**Super Tough Tarp Fastener**

The Grip Clip™ attaches quickly and securely, without perforating the fabric, yet can be removed and reused. The Grip Clip can join two tarps together or shape a tarp by gathering up a fold. The Grip Clip provides a secure anchor for staking or attaching poles or lines to a tarp or tent. You will find endless uses for them at home, in the garden, while camping, and at construction sites.

**Almost Indestructible,  
At Times Indispensible!**

## Grip-Clips will help you create what you need.

What you can make with [Grip Clips](#) is limitless!

**30-DAY RISK-FREE TRIAL 1 1/2-YEAR GUARANTEE**

Our guarantee is simple. **YOU MUST BE SATISFIED!** If for any reason you're not completely pleased with your purchase, return it in original, clean condition within 30 days of receipt for a full refund or exchange as you wish. All items in this catalog

have a warranty against defects in materials and workmanship for **1 1/2 years**. Should any product prove defective we will repair or replace it at no cost to you. Special Orders are not returnable. Read [Snow and Wind Warnings](#).

[To order](#) by Fax or Mail.

[Order online with our Secure Order Form!](#)

**For fast credit card orders call 650-323-6202**

Questions? E-mail us at [shelter@best.com](mailto:shelter@best.com). Please feel free to call or write us anytime. Shelter Systems-OL, 224 Walnut St., Menlo Park, CA 94025. FAX 650-323-1220 Phone 650-323-6202.

[Shelters](#)

[Greenhouses](#)

[What's New?](#)

[Gillis Designs](#)

[Stories](#)

[Q's & A's](#)

[Price List](#)

[Shelter Systems' Map of Site](#)

**Shelter Systems** © 1996 - 2001 All Rights Reserved

[Shelter Systems' Home](#)



Shelters

Greenhouses

What's New?

Gillis Designs

Stories

Q's & A's

## Attaching Grip Clips™

The Grip Clip™ is a versatile, superstrong tarp fastener. Here are instructions on how to use it.



Step 1



Step 2



Step 3



Step 4



Step 5



Step 6



Step 7



Step 8

1. Knot cord through Ring part.
2. Wrap material over Button with its flared side facing up as shown.
3. Slip Button through Ring.
3. Turn the Ring so that the Button seats snugly into the locked position.
4. Remove a Grip-Clip by reversing the steps.

# Grip Clips™ will help you create what you need.

What you can make with [Grip Clips™](#) is limitless!

[Grip Clip Pricing](#)

[Grip Clip Header Card](#)

[Grip Clips Own Web Page!](#)

[Emergency Shelter Systems](#)

[Four-Hour Kayak Using Grip Clips!](#)

[Attaching Grip Clips Photos](#) show how to

[The Grip Clip Tarp Kit](#). Tarp with Grip Clips & Instructions.

## 30-DAY RISK-FREE TRIAL 1 1/2-YEAR GUARANTEE

Our guarantee is simple. **YOU MUST BE SATISFIED!** If for any reason you're not completely pleased with your purchase, return it in original, clean condition within 30 days of receipt for a full refund or exchange as you wish. All items in this catalog have a warranty against defects in materials and workmanship for **1 1/2 years**. Should any product prove defective we will repair or replace it at no cost to you. Special Orders are not returnable. Read [Snow and Wind Warnings](#).

[To order](#). by Fax or Mail.

[Order online with our Secure Order Form!](#)

**For fast credit card orders call 650-323-6202**

Questions? E-mail us at [shelter@best.com](mailto:shelter@best.com). Please feel free to call or write us anytime. Shelter Systems-OL, 224 Walnut St., Menlo Park, CA 94025. FAX 650-323-1220 Phone 650-323-6202.

[Shelters](#)

[Greenhouses](#)

[What's New?](#)

[Gillis Designs](#)

[Stories](#)

[Q's & A's](#)

[Price List](#)

[Shelter Systems' Map of Site](#)

Shelter Systems © 1996 - 2001 All Rights Reserved

[Shelter Systems' Home](#)

[Shelters](#)[Greenhouses](#)[What's New?](#)[Gillis Designs](#)[Stories](#)[Q's & A's](#)

## Folding Tent

The Future of Tent Design is wide open and Shelter Systems is on the cutting edge of this potential. The [Flextent](#) foldable tent structure is just one example of what Shelter Systems is up to.



**The structure comes in one package.**



**Set-up begins by unfolding the poles and covering.**



**Part of the side is staked down and unfolding continues.**



**The remaining sides are staked down and the dome is up.**



**Here is an elliptical version of the folding dome designed for the U.S. Army.**

[Our Origami Dome™](#) is an amazing folding dome shelter of rigid panels that folds flat when not needed! [Make one of](#)



[cardboard.](#)

Questions? E-mail us at [shelter@best.com](mailto:shelter@best.com). Please feel free to call or write us anytime. Shelter Systems-OL, 224 Walnut St., Menlo Park, CA 94025. FAX 650-323-1220 Phone 650-323-6202.

[Shelters](#)

[Greenhouses](#)

[What's New?](#)

[Gillis Designs](#)

[Stories](#)

[Q's & A's](#)

**Shelter Systems** © 1996 - 2001 All Rights Reserved

[Shelter Systems' Home](#)

[Shelters](#)[Greenhouses](#)[What's New?](#)[Gillis Designs](#)[Stories](#)[Q's & A's](#)

## Happy Customers

If you are considering buying a **Shelter Systems'** portable, waterproof living or gardening structure, we think you'll find these letters and photographs informative as well as enjoyable. They were sent to us by satisfied people who've bought and used our structures for many varying purposes.

"This photo was taken on the road from Moron to the Dharhat Valley and Lake Hovsgol in northern Mongolia. The tent is used as a general dormitory for our Mongolian guides (who think it is really cool since it is lighter and easier to move and pack than a yurt and it allows them all to sleep in a big lump together, as they are used to doing. They are not so keen on our 4-person backpacking tents. Each to his own.). We also use it as a cooking/dining/meeting tent whenever the weather is bad. It packs on horseback pretty well. The big attraction of the tent for me is that it provides a level of security and comfort in remote regions when traveling with a large group. The difference between huddling under a tarp in the rain and being in the dome is all the difference in the world. In the event of emergency or prolonged bad weather we have a place to keep people safe and secure."  
-Kent, Boojum Expeditions, MT



Hi Bob. Here are a couple of shots from this summer when we used the tent on the first raft trip on the Chuluut river in Mongolia. Cheers.. Kent Madin -- Boojum Expeditions Uncommon Adventures



"I have been completely satisfied with the quality and appearance of our dome. So far it has handled the 20 inches of rain and wind storms very well. The dome is my year-round home. I have a bright, airy but warm home inexpensively. The tipi style doors are a 100% improvement over zippered doors. Living in the dome, one becomes intimate with the sun, clouds, and waning and waxing moon. I love it." -Paul Guree, CA



"The dome has performed well, has stood up to the elements and is quite the conversation piece. We grow a garden in a place noted for a very short growing season. It's been a product that more than lived up to our expectations." - Bob Woodward, OR

"I'm really happy with your design because the ability to cross-ventilate this dome is very important in the tropics. The use of different membrane panels is also a nice feature. My goal is to perfect this structure so that it will eventually be a self-reliant living system powered by solar panels." - Peter Ziegler, Hawaii Institute of Geophysics

"The LightHouse 18 makes for a wonderful portable classroom at our nature preserve. As soon as an area begins to show some wear and tear, we move the tent. It is truly living lightly on the land." -David Wicks, KY

"Just skied down from the high camp and the tent is great. It is a warm and cozy place in this storm we are having and we could not have included 15 kids and 4 adults without it." -Susan and David Beck, Sierra Ski Touring - Mammoth, CA



"Our dome has been very useful. For eight years it has been doctor's office, guest house, and teenage crash pad." -Elsa Etchevery, CA

"We are very pleased with our Solar-Dome greenhouse. We have been able to get a head start on our vegetable garden, start perennials in mid-summer, save a lot on plant costs by purchasing seeds, and bringing into bloom any exotic plants requiring humidity higher than natural for our area." -Bernice Linchester, IL

"Dear folks, This is from Oklahoma. I spoke with you on the phone on Wednesday, ordering some new liners for our 18'ers and 20'ers. This will be our 3rd summer season with a Shelter Systems tent camp. So far, we have nine tents, a mixture of 20'ers, 18'ers, 14'ers, 8'ers, living & greenhouse tents. Even our seven cats have their own tent! Thursday, the day after we called you

for the liners, we had a storm come through. We'd set up several tents, but had not staked all of them down. Okay, that was stupid, but it did have amusing results. Three of the tents took off rolling, one making it through a grove of trees, over a low concrete wall and out across the south pasture. There was a little tearing of this three-year-old tent at one junction (actually, that may have already been there), and one pole fell out. We picked it up, moved it back to the site, and (finally) staked it down well. Of all three tumbling tents, one lost a pole, and another had a window pole snap. Can't help admiring how durable these things are. They even stand up to our sins of omission in properly tying them down!"



"Enclosed are some slides of my old 'Freedom' which I lived in for 4 years (2 in New Hampshire and 2 in Alaska). With the double-walled design and a little wood stove, it was a 'God-send' of a living situation for me. Allowing me to live 'cheaply' anywhere. Thank you so much. It was a 'threshold' period of my life and enabled me to affordably explore new places, opportunities and lifescapes. I currently use my Light House as summertime living quarters while building log cabins for clients in remote parts of the state. I think that in summertime the LightHouse is a nicer alternative to the traditional Alaskan wall tent, being roomier, lighter and less prone to mildew. If the Sourdoughs' had Domes , they would have used them!"



"We used a full sphere 10' Bubble dome as a 'earth container' for a recycling program on Earth Day."

"Dear Bob, Thank you very much for the prompt service. So far I am very pleased with my greenhouse. I had carrots germinating in 90 days - a record for my Alaskan garden." -Pat Kegel , AK

"It's a wonderful space, playing tricks with a mystical light and always letting in the full sound of the wind in the trees and the babbling brook. If I ever have to move, it will be easy to take my dome with me. I think it's way cool." -Tom Zajac , CA

"...We recently had a freeze with a low of 22°. The plants in the greenhouse had minimal frost damage; plants outside were lost. I was impressed with the performance of the greenhouse this winter." John White, Dept of Horticulture, Penn. State

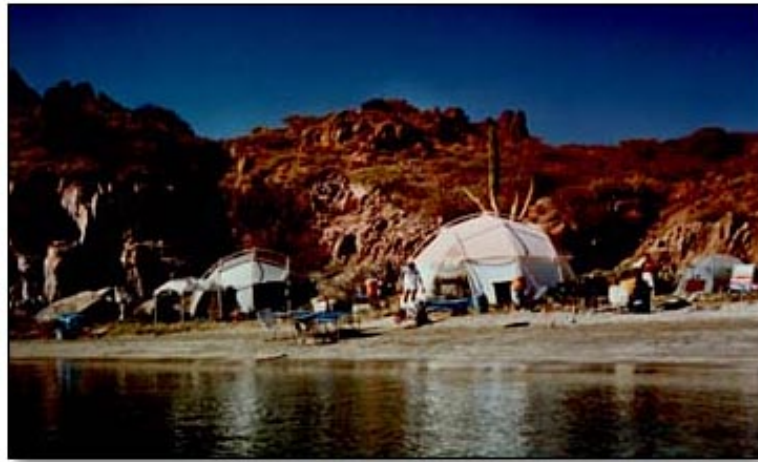

"We used 14 of your domes at the San Ignacio Whale Watch Base Camp. They are truly extraordinary and were instrumental in providing the high degree of comfort and protection we needed. We had some very strong winds and heavy rain and the tents performed flawlessly. For strength, size, cost and aesthetics, your tents are ideal." - Kent Maden, Baja Expeditions, MT



"Greetings from New Mexico. We are the folks that bought two of your 18' domes. We took them on the road - traveling 2,000 miles with 16 kids - exploring Chaco Canyon, Canyon de Chelly, The Grand Canyon, and Hopi. Our experience with the domes on the road was quite marvelous. Kids (ages 11-14) learned how to put them up (often with impending storms) and we loved the cooperative effort that took over our shelter lives. They also faired very well with the rains. We have used lots of different shelters over our nine years of camping with groups and were very impressed. We came back after two weeks traveling feeling quite endeared of our two domes. Thanks." -John M. Leod , Our Children's Earth, NM.



"We own a sea kayaking and whale watching expedition business in Mexico and have found your domes to be a **great** asset when the Baja weather goes bad. Your domes have held up against strong winds and rain and provided a sanctuary for cooking, sleeping, socializing and even dancing to the cumbia music of our 'Pirates of the Gulf' Baja beach band. Thanks!" - Mary Harter & Ricardo Amador, Mar y Aventuras, Mexico

## [More Happy Customers' Photos and Letters.](#)

Questions? E-mail us at [shelter@best.com](mailto:shelter@best.com). Please feel free to call or write us anytime. Shelter Systems-OL, 224 Walnut St., Menlo Park, CA 94025. FAX 650-323-1220 Phone 650-323-6202.

[Shelters](#)

[Greenhouses](#)

[What's New?](#)

[Gillis Designs](#)

[Stories](#)

[Q's & A's](#)

Shelter Systems © 1996 - 2001 All Rights Reserved

[Shelter Systems' Home](#)



Shelters

Greenhouses

What's New?

Gillis Designs

Stories

Q's & A's

## Shingling and Ventilation in Shelter Systems' Domes, Tents, and Yurts

**Shelter Systems'** lightweight, portable domes, tents, yurts, and other shelters are constructed with a method we call "shingling." Shingling is layering the tarp panels over each other (as you would shingle the roof tiles of a house) and then fastening the panels together with our own Grip Clips.



Shingling creates a totally waterproof covering for your dome because the material is not punctured anywhere. It also allows for breathability, because small amounts of air pass between the two overlapping layers. In addition, shingling permits excellent overhead ventilation; you simply insert a lightweight object (eg an empty soda can) or a 3"-diameter Ventilation Tube (two are provided with each yurt) between overlapping panels. (Because the two panels overlap each other so much, rain can't get in.) When the object or tube is removed, the panels snap shut and are watertight.

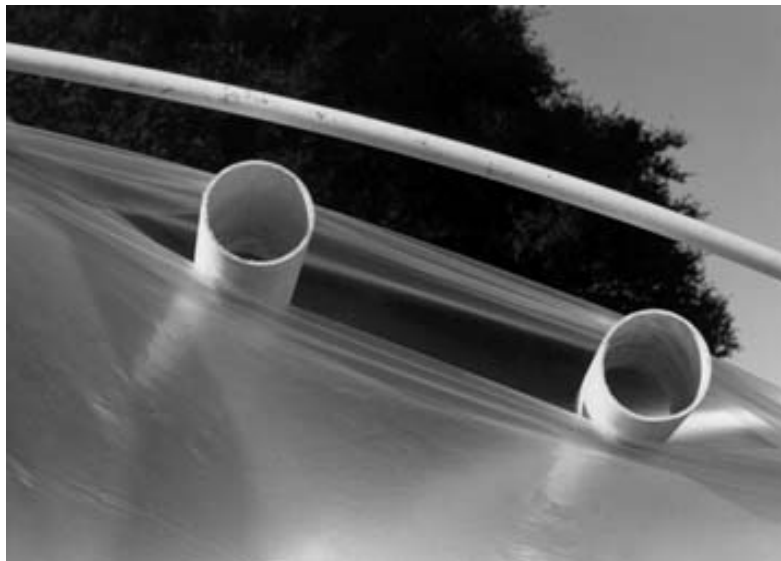

**Shingling allows the installation of Ventilation Tubes.**

Shingling is part of the manufacturing process and is done completely by us at our facility. Each panel overlaps the other by 6". The overlaps are secured by [Grip Clips](#), which are placed 2' to 5' apart. The attached Grip Clips also serve as anchoring points for poles and stakes. The overlaid panels are kept under tension by the poles which are attached to the Grip Clips (like a bow string is held taut by a bow). This constant tension keeps the overlapped panels semisealed.





**Inside the Yurt Dome showing shingling.**

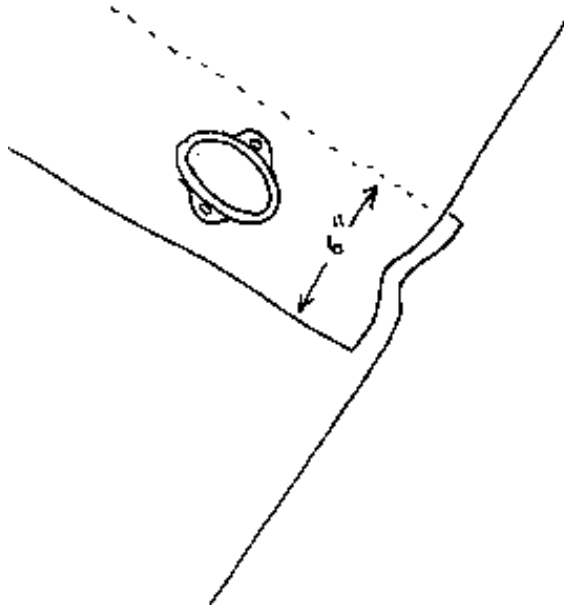

**Photo of poles, Grip Clips, connectors and shingling on 18' Yurt Dome.**

Questions? E-mail us at [shelter@best.com](mailto:shelter@best.com). Please feel free to call or write us anytime. Shelter Systems-OL, 224 West O'Connor St., Menlo Park, CA 94025. FAX 650-323-1220 Phone 650-323-6202.

Shelters

Greenhouses

What's New?

Gillis Designs

Stories

Q's & A's

**Shelter Systems** © 1996 - 2001 All Rights Reserved

[Shelter Systems' Home](#)



Shelters

Greenhouses

What's New?

Gillis Designs

Stories

Q's & A's

# Fabrics, Films, Polyester Canvas, Greenhouse and Solar Film, Shade Fabric and Coverings

## Woven Ripstop Films

The coverings and fabrics for Shelter Systems' Yurt Domes™, tents, greenhouses and other structures are made by taking a special plastic copolymer (a simple compound composed of carbon and hydrogen which is chemically similar to wax) and stretching it until it becomes stiff. At this point, the material is at its maximum tensile (pull) strength. It is then sliced into thin strips and woven into a fabric. This gives it amazing tear resistance. The fabric is then laminated on both sides with some sheets of the same stretch-strengthened material and is thereby stabilized and super strengthened. You cannot tear it.

All Shelter Systems' coverings incorporate UV sunscreen inhibitors to help block damage from the sun and give the covering a longer useful life.



**Shelter Systems' Translucent GroDome Covering: Lets 90% of the light through--more than glass does. It diffuses the light so the light won't burn the plants. You can not see through it. Was designed for greenhouse and solar use. The light that comes through it is somewhat like the light that comes through frosted glass: uvB=59% transmission; uvA=68% transmission; visible light transmission=84%**



**Shelter Systems' White SolarDome covering: Also lets 60% of the light through; not enough for greenhouse use. The light that comes through it is somewhat like the light that comes through white paper : uvB=0% transmission; uvA=0% transmission; visible light transmission 25%**



**Shelter Systems' White and Black Shade Covering:  
White outside to reflect light and the sun and Black inside to block 100% of the light and sun.**

**Other Coverings:**



**Shelter Systems' Clear Vinyl: Heavy gauge (10 mils), UV-stabilized. We use this for our windows.**

**Accessories:** These materials, are available from Shelter Systems.

Questions? E-mail us at [shelter@best.com](mailto:shelter@best.com). Please feel free to call or write us anytime. Shelter Systems-OL, 224 Walnut St., Menlo Park, CA 94025. FAX 650-323-1220 Phone 650-323-6202.

Shelters

Greenhouses

What's New?

Gillis Designs

Stories

Q's & A's

**Shelter Systems** © 1996 - 2003 All Rights Reserved

[Shelter Systems' Home](#)

[Shelters](#)[Greenhouses](#)[What's New?](#)[Gillis Designs](#)[Stories](#)[Q's & A's](#)

## Extra Strong 14', 18' and 20' Yurt Dome

We have developed **Extra Strong Yurt Dome** that has extra strong translucent skylight windows instead of the clear vinyl windows which are standard with our domes. These skylights let in more light than glass and can not crack or stretch like the clear vinyl. They are like frosted glass and thus you can not see through them. If you are interested in an Extra Strong version let us know when you order.



**Extra Strong 18' Yurt Dome** We have these in stock for immediate shipping.  
Diameter 18' x 9' High, 254 sq', Weight 60 lb. **\$720** Shipping \$45

If you are interested in this version of the 18' Yurt Dome let us know when you order that you would like the **Extra Strong Yurt Dome**.

### 30-DAY RISK-FREE TRIAL 1 1/2-YEAR GUARANTEE

Our guarantee is simple. **YOU MUST BE SATISFIED!** Everything in this catalog is offered for 30 days' free trial. If for any reason you're not completely pleased with your purchase, return it in original condition within 30 days of receipt for a full refund or exchange as you wish. All items in this catalog have a warranty against defects in materials and workmanship for **1 1/2 years**. Should any product prove defective we will repair or replace it at no cost to you. Special Orders are not returnable.

[To order.](#) by Fax or Mail.

[Order online with our Secure Order Form!](#)

**For fast credit card orders call 650-323-6202**

Questions? E-mail us at [shelter@best.com](mailto:shelter@best.com). Please feel free to call or write us anytime. Shelter Systems-OL, 224 West O'Connor St., Menlo Park, CA 94025. FAX 650-323-1220 Phone 650-323-6202.

[Shelters](#)

[Greenhouses](#)

[What's New?](#)

[Gillis Designs](#)

[Stories](#)

[Q's & A's](#)

[Price List](#)

[Shelter Systems' Map of Site](#)

**Shelter Systems** © 1996 - 2001 All Rights Reserved

[Shelter Systems' Home](#)



Shelters

Greenhouses

What's New?

Gillis Designs

Stories

Q's &amp; A's

## Manual for the 6-sided 10' RoofShell™

Shelter Systems' **RoofStructures™** are thin sections of spheres or tunnels made from a lightweight, strong, waterproof, ripstop film which is either white, translucent or black/white. They are useful for making jacuzzi covers by simply setting them over your spa; rain and sun porches by tying them to buildings, poles or trees with our attached clips; portable greenhouses by setting them on the ground or over a hole you've dug and can then walk into (ventilation can be provided by propping up one end); quick sheds by setting them on 8' 4x4's sunk in the ground with plywood walls attached; and other low-arched roofs.

**Wind and Snow Warning:** Your Roof Shell is a lightweight structure, therefore extreme wind sites are not recommended.

When possible, avoid exposed hilltops and narrow valleys where wind speed increases. Trees and brush between you and the wind help protect your shelter. Your Roof Shell could be destroyed in extreme weather and your life or safety could be at risk. In heavy snow or wind your dome could collapse, damaging what you have or compromising your shelter. Do not rely on your Roof Shell as your only shelter. Accumulated snow, must be melted or shaken off.



Fence



Wind



- 1) Assemble your poles by joining the six poles with flared ends to six poles that are not flared.
- 2) Spread out the covering so that with the clips with the cord loops and the center clip with connectors are facing up.



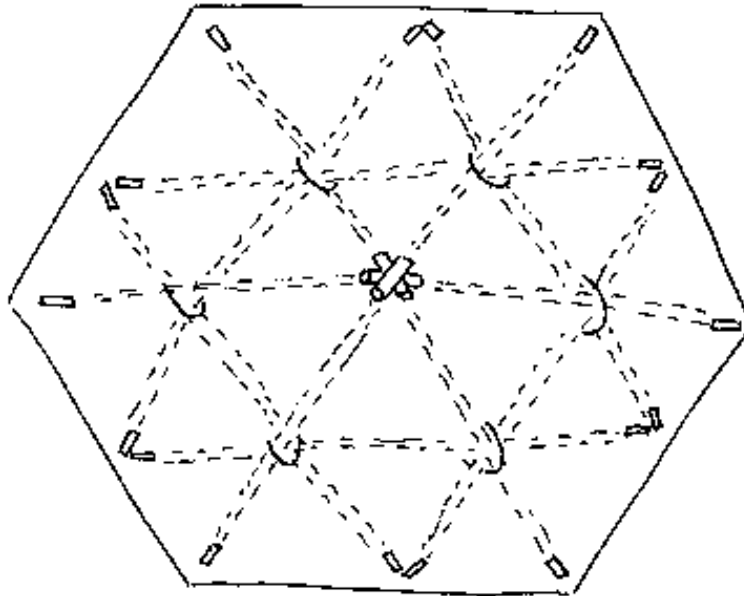
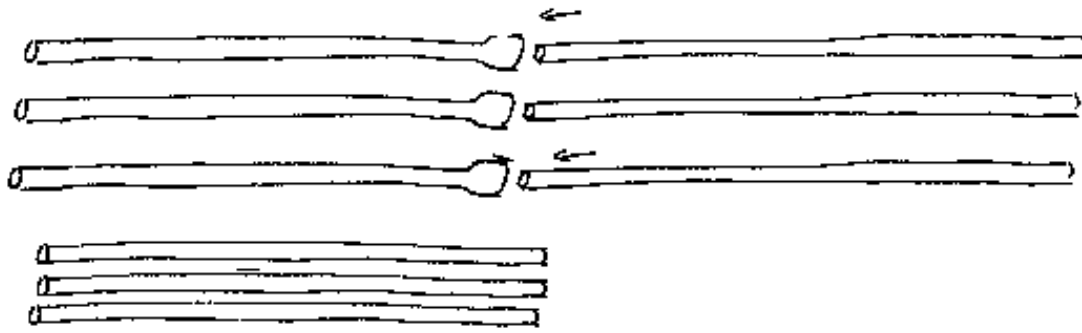

3) One at a time, slide the six remaining unjoined poles through the clip loops and into the connectors at the center of the covering. Then bend the poles upward slightly and insert the plugs attached to the coverings perimeter clips into the poles outer facing ends.

4) Now proceed one at a time to slide the six joined poles through the covering loops so that these six poles lie parallel to the poles that cross at the center. Insert the plugs attached to the coverings perimeter clips into the poles outer facing ends (You may need to push on the poles causing them to bend upward slightly to get both end plugs in).

**Repairs:** Your Roof Shell is designed to be durable and problem free. However, some of our customers use their structures for so many years that eventually they need some maintenance. A broken pole can be repaired with a wooden insert such as a piece of broom handle or a straight stick. Poles can usually be obtained from a building supply or plumbing store. Ask for class 200, class #125 or schedule 40 will also work. Poles may also be ordered from Shelter Systems (send length and size).

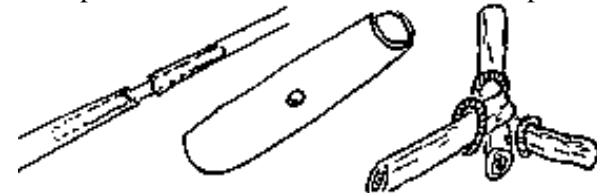

Broken connectors can be replaced with class 200 PVC (1-1/4" for the 20' and 18' domes and 1" for the 8', 10', 11', and 14' domes). The simplest way to repair a hole or cut in the covering is to cut a patch from the material the dome came wrapped in. Use silicon rubber to glue your patch on the outside of the tear. If the tear is small you may be able to plug it up with a blob of silicon rubber alone.

It is best to replace a whole panel if a tear is immediately adjacent to a clip. Order the same panel from Shelter Systems. 1) Arrange the replacement panel over top of the damaged panel so that it is in the same orientation. 2) Remove only one clip from your dome being careful not to disrupt the layering sequence of the panels on your dome. 3) Take your time to carefully slide out the corner of your damaged panel and insert your replacement panel into the same layering sequence as that of the damaged panel. 4) Now with all layers in the same order and orientation as before; gather these tightly around the male clip and slip over the female clip as described below. When many layers are involved as is the case with the corners of the windows, attaching the

female clip can be difficult; practicing on scraps and making the layers warm with the sun or heat lamp (be careful not to melt the covering by getting it to hot) can help. If your dome is flattened by snow, carefully remove the snow without tearing its covering. You may find it will pop back up or that you have to remove some of the poles and set up again. Replace any broken poles.

Attaching Grip Clips: 1. Knot cord through Ring part.



2. Wrap material over Smaller Button part with its flared side facing up as shown.



3. Slip Button through Ring.



4. Turn the Ring so that the Button seats snugly into the locked position.

5 Removal of a clip is just the reverse procedure.

**WARNING:** Your Roof Shell could be destroyed in extreme weather and your life or safety could be at risk. In heavy snow or wind your yurt could collapse, damaging what you have or compromising your shelter. Do not rely on your Roof Shell as your only shelter. Accumulated snow, must be melted or shaken off periodically. Do not set your Roof Shell under a tree or branch that might fall on you. Keep all flames and heat away from your Roof Shell's covering and objects in your Roof Shell.

Patented. Others pending. 650-323-6202 [www.shelter-systems.com](http://www.shelter-systems.com)

Questions? E-mail us at [shelter@best.com](mailto:shelter@best.com). Please feel free to call or write us anytime. Shelter Systems-OL, 224 Walnut St., Menlo Park, CA 94025. FAX 650-323-1220 Phone 650-323-6202.

Shelters

Greenhouses

What's New?

Gillis Designs

Stories

Q's & A's

**Shelter Systems** © 1996 - 2001 All Rights Reserved

[Shelter Systems' Home](#)



# Emergency and Disaster Relief Portable Geodesic Yurt and Dome Tent Shelters

**Shelter Systems' Emergency and Disaster Relief Portable Geodesic Yurt and Dome Tent Shelters** have been sheltering families for extended periods of time in all climates for over 20 years. Shelter Systems' Emergency Disaster Relief Tents are made of a strong, tear-resistant fabric and non-puncturing tarp fasteners. Shelter Systems' Relief Tents offer the best value because they are strong, durable, watertight, wind-resistant, pleasant to live in, easily set up, and affordable.

## Easy Set Up

Shelter Systems' Emergency Disaster Relief Yurt and Dome Tents can be set up by one person [in 30 minutes](#) without tools. Insert the interchangeable poles into factory-attached connectors spaced evenly over the cover. The poles are bend slightly when inserted, tightening the cover into a wind- and waterproof shelter. The cover is freestanding requiring no guy lines and can be moved into the desired position or location without taking it down. The Yurt Dome can be taken down in 5 minutes: just remove the poles and roll up the covering.



Venezuela Flood Shelter Relief [See More Photos](#)

**18 foot (5.4 meter) Emergency Relief Tent Shelters**  
Quantities of 1000 \$320.00 each

## Sturdy Design

Shelter Systems' Relief Tents are dome shaped patented [Geotensic™](#) structures. Geotensic structures are stronger than any other structure made of the same materials. Because of their curved shape with no corners, there are no weak points. Shelter Systems' Relief Tents are drum tight, completely waterproof and wind-resistant.

Shelter Systems' Emergency Disaster Relief Yurt Dome Tents have the poles on the outside with the covering suspended under the frame via Shelter Systems' own Grip Clip tarp fasteners. The frame and the covering are not in direct contact. The important benefits from this design are that the covering is under constant, even tension so that the tent will not flap in the wind. The poles cannot rub against the covering. This prevents wind flap shredding and pole friction wearing. Also, since the poles and covering are not touching, there is no temperature buildup to degrade the fabric at contact points. Shelter Systems' Emergency and Disaster Relief Yurt Dome Tents perform excellently in strong wind due to evenly space cross bracing and anchor points.

The [shingled](#) panels of our Relief tents overlap each other by 6", making the structure stronger and completely leak proof. The shingling also allows the structure to breathe. The buildup of moisture is driven out through the overlapped panels by vapor pressure and does not condense inside the tent.

Shelter Systems' patented [Grip Clips™](#) tarp fasteners join the Yurt Dome's cover to the frame. Grip Clips also fasten the shingled panels together, providing greater strength than sewn seams or any type of grommet because they do not puncture the cover. The Grip Clips grip a large area of fabric spreading wind loads and preventing tearing.



**The 18' (5.4 m) in a village setting. Eight to ten people can be sheltered in each dome**

## Durable Materials

Shelter Systems' Emergency and Disaster Relief Yurt and Dome Tents are made wholly of a superstrong, tear-proof, [woven ripstop film](#) which will not rot or mildew. The covering effectively excludes rain, dampness, wind, cold, and sun. The completely waterproof covering and the shingled breathability make a rain fly unnecessary. The covering is UV-stabilized to withstand up to 3 years of full sun exposure. The white color of the covering reflects the heat of the sun and provides 40% shade.

The frames are constructed of strong, long lasting, resilient, UV-stabilized, Class 200, 1 1/4"-diameter (3.5 cm.) PVC tubing.

## Affordable

Our waterproof design does not require a rain fly and the particular geometric shape utilizes material efficiently. The high performance covering is affordable. Because of the design and our tarp fasteners, our tents are labor efficient to build. These factors make for reliable and affordable Emergency and Disaster Relief Shelters.

### **Comfortable Living Space**

Shelter Systems' Disaster Relief Yurt and Dome Tents are light filled and well ventilated. The white covering creates a pleasingly bright interior. Shelter Systems' 5.4 meter Emergency Disaster Relief Tent has four flap doors evenly spaced around the dome for good cross ventilation and light. The door coverings close automatically so you can go in or out quickly. There are no zippers to fumble with or break. Over each door is a translucent skylight window which allows 90% of the sunlight to pass through it while preserving the privacy of the people within.

Shelter Systems' Emergency Relief Shelters are winter-ready tents. They do not require a fly or liner (for extreme cold we do offer a [liner](#)). Our Relief Tents are completely water tight and will not leak. The [shingled construction](#) allows moist air to be driven out through the by vapor pressure. Shelter Systems' Relief Shelters have a minimal surface area for their volume and are thus easy to keep warm with a stove ([Stove installation instructions](#) are included with each tent).

[Overhead ventilation](#) is easily attained by inserting a lightweight object (eg, an empty can) between panels. This ventilation is shingled and sheds rain. When the can is removed, the panels snap shut. For maximum ventilation the walls themselves can be [rolled up](#).



The dome shape has other comfort features: The interior can be divided into "rooms." The tent has more volume than a flat-sided one and therefore feels, and is, more spacious. The shape is more heat efficient requiring less fuel to heat it. Air circulates more evenly in the dome shape than any other shape. The cover of the dome is easily cleaned with a damp cloth.

### **Comparing Different Domes**

The 5.4 has 254 square feet, a height of 9 foot and sleeps eight to ten people. The 9 meter dome has 706 square feet, a height of 11' and can sleep 30 to 40 people.



The 5.4 meter Emergency and Disaster Relief Yurt and Dome Tents has four flap doors evenly spaced around the dome for good cross ventilation. The 9 meter shelter has eight doors. [More on sizes.](#)

**Complete and Adaptable**  
Shelter Systems' Emergency and Disaster Relief Yurt Dome Tents come complete with poles, high quality 12" Durapeg stakes, guy

lines for extreme wind settings, ventilation tubes, spare parts (Grips Clips and pole connectors) and a [Instruction Manual](#) that details floors, site selection, anchoring, cooling, winterizing, and stove installation.

Shelter Systems' Emergency and Disaster Relief Yurt Dome Tents are ideally suited for most climates; however, they can be further adapted for use in extreme climates. For the extreme cold, where fuel is in short supply, we offer a full liner. For extreme heat, we offer net doors and a sunshade which blocks one hundred per cent of the sunlight. Other [accessories](#) available include rain porches and floors.



**The 30' (9 m) Emergency Disaster Relief Tent** makes an excellent community focal point for "villages" of smaller domes. Quantities of 20 **\$800.00** each Weight:190 lbs (86 kg)



### **Available**

Availability of shelters is critically important in emergency situations. We have about 500 to 2000 depending on the day. Please call about availability. We can produce 40 to 80 Emergency Relief Shelters per day and we will expand our production capabilities to fill any order.

### **Price and Payment**

Payment is by advanced wire transfer or irrevocable letter of credit. CIF pricing is available upon request

### **14 foot (4.2 meter) Emergency Disaster Relief Tent Shelters**

Quantities of 1000 **\$270.00** each

Quantities of 100 **\$300.00** each

Poles - 46" x 8" x 8" @ 22 lbs.

Tent covering- 28" x 13" x 13" @ 20 lbs.

### **18 foot (5.4 meter) Emergency Disaster Relief Tent Shelters**

Quantities of 1000 **\$320.00** each





Quantities of 100 \$350.00 each

Poles - 57" x 10" x 10" @ 44 lbs.  
Tent covering- 42" x 16" x 16" @ 32 lbs.

**30 foot (9 meter) Emergency Disaster Relief Tent Shelters** (shown packed up to the right)

\$1200.00 each

Quantities of 20 **\$800.00** each

Poles - 2 x (62" x 12" x 12" @ 56 lbs.  
Tent covering- 43" x 20" x 20" @ 67 lbs.

FOB from Georgia, USA. Poles and covering are packaged separately.

Shipping by Sea takes about three weeks (250 of the 5.4 m Emergency Relief Shelters fit in a 8' x 8' x 40' shipping container).

Shipping by Air about 2 - 4 days. Samples shipped UPS or Fed Ex.



**Caring Best For Those Most In Need.™**

**For orders call 650-323-6202**

Questions? E-mail us at [shelter@best.com](mailto:shelter@best.com) Please feel free to call or write us anytime. Shelter Systems-OL, 224 West O'Connor St., Menlo Park, CA 94025. FAX 650-323-1220 Phone 650-323-

**Shelter Systems © 1996 - 2004 All Rights Reserved**

[Shelter Systems' Home](#)



Shelters

Greenhouses

What's New?

Gillis Designs

Stories

Q's & A's

## Photos of Shelter Systems' Emergency Family Relief Shelters and Tents



Bam Iran after earthquake 30'er as a warehouse. Photo by J. White / Mercy Corps



Set up in Bam



**Venezuela Flood Shelter Relief**



**Quick and Easy to set up**



**Comfortable**



**Family Relief Shelter**



**Light Weight and Freestanding**

[Still More Photos](#)

[Back to Relief Tents](#)

Questions? E-mail us at [shelter@best.com](mailto:shelter@best.com). Please feel free to call or write us anytime. Shelter Systems-OL, 224 West O'Connor St., Menlo Park, CA 94025. FAX 650-323-1220 Phone 650-323-6202.

[Shelters](#)

[Greenhouses](#)

[What's New?](#)

[Gillis Designs](#)

[Stories](#)

[Q's & A's](#)

**Shelter Systems** © 1996 - 2001 All Rights Reserved

[Shelter Systems' Home](#)



Shelters

Greenhouses

What's New?

Gillis Designs

Stories

Q's &amp; A's

# ShelterFirst™ Emergency and Disaster Relief Tent Shelter

**Family Size High Strength Low Cost Portable Package Up In 15 Minutes!**

**Family Sized:** ShelterFirst emergency and disaster relief tent shelter has a roomy floor area of 255 square feet and covers 16' x 16' area with a height of 7'4". It has four doors for good ventilation. The door covers can be pulled out to create a porch over the door openings. The doors tie closed, there are no zippers to fumble with or break. The interior can be divided with fabric to create private areas. Since the covering is not punctured or cut in the manufacture of the tent it can not leak! Vents can be created where side walls hit the ground for extra ventilation in hot weather. The covering's white color reflects the sun's heat during the day and makes for a pleasingly bright interior during the night. ShelterFirst tents are light filled and well ventilated. The cover of the tent is easily cleaned with a damp cloth.



**High Strength:** The covering is evenly supported to create a drum tight wind shedding shelter. Roof is steeply peaked to shed snow well. The ShelterFirst relief tent is a self-supporting tension structure. There are no guy lines to set or get in the way.

The covering is made of Shelter Systems' super tough multi-laminated woven ripstop film. It is completely synthetic and will not rot or mildew. It is ultra violet stabilized for a long life and fire-resistant for safety. The covering is entirely waterproof. The four doors and side vents provide breathability making a rain fly unnecessary. It's white color reflects the heat of the sun and the black core provides shade.

Poles are relatively short and are entirely under compression making for a strong snow and wind shedding shelter. The poles are constructed of strong, long lasting, resilient, UV-stabilized, Class 200, 1 1/2"-diameter (3.5 cm.) PVC tubing



The ShelterFirst emergency and disaster relief tent shelter is constructed with special patented [Grip Clips™](#) that spread tension evenly and join tent to the ground providing greater strength than sewn ties or any type of grommet because they do not puncture the cover. Shelter Systems' patented [Pole Clips™](#) joins the poles to the covering with out weakening or puncturing the covering. The Grip Clips grip a large area of fabric spreading wind loads and preventing tearing. Thus there is no puncturing or cutting of the tarp to create the shelter and therefore there are no points to leak.

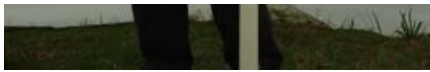

**Low Cost:** ShelterFirst emergency and disaster relief tent shelter is an efficient tent to manufacture and thus offers maximum value with minimum cost. Materials used in its construction are chosen and combined to perform at optimum strength to cost. It uses a minimal amount of materials in its construction to achieve a maximum of sheltered space. It is labor efficient to build. These factors allow us to price these shelters to reach the maximum number of people in need.



**Compact Portable Package:** The ShelterFirst disaster relief tarp tent shelter fits in a compact box on pallets for rapid world wide shipping. It's weight of only 35 lb. and small packaged size of 45" x 12" x 14" keeps shipping costs down and allows for a large number of shelters to fit into an aircraft. The ShelterFirst tents are cost effective to ship world wide. The ShelterFirst is light and compact enough for one person to easily carry to their preferred village or home site.

**Sets Up In 15 Minutes!:** The ShelterFirst sets up easily and quickly by one person. First the covering is staked out. Then you climb under the covering and insert the five vertical poles into the factory attached Pole Clips™. Its that simple.



**Multiple use potential:** The ShelterFirst emergency and disaster relief tent shelter is an assemblage of removable parts. Each part to be used alone or combined together in ways that are different than the original tent. The ShelterFirst tent can be taken apart without tools or damage to any of the parts. The covering is not cut or punctured in the finished tent. The clips can be removed and the covering can then be joined with the clips and poles to customize the needs of the user, for example by creating alternative shelters, rain catchment collectors, sheds fish pond liners or rain coats etc. The poles are PVC tubing and can be used to transport water for drinking or irrigation..

**Complete Shelter Systems:** Each ShelterFirst emergency and disaster relief tent shelter consists of a heavy duty covering with Grip Clips and Pole Clips attached, segmented PVC poles, heavy duty stakes and instructions.

**Available:**

Availability of shelters is critically important in emergency situations. We have about 500 to 4000 depending on the day. Please call about availability. We can produce 80 to 200 Emergency Relief Shelters per day and we will expand our production capabilities to fill any order.

**Complete ShelterFirst Price: In quantities of 500 to 1000 \$140 each  
2000 \$135 each  
5000 \$130 each**

**ShelterFirst Frame Kit (all that is needed is a 24' by 24' tarp)  
Price: In quantities of 500 to 1000 \$60 each  
2000 \$55 each  
5000 \$50 each**

Heavy Duty covering with Grip Clips and Pole Clips attached, segmented PVC poles, stakes and instructions. Floors are available for an additional \$20.

**Payment:** is by advanced wire transfer or irrevocable letter of credit. CIF pricing is available upon request

**Shipping:** FOB from Georgia, USA. Box size 45" x 12" x 14" Weight 35 lb. Shipping by Sea takes about three weeks (480 ShelterFirst emergency disaster relief tent shelters fit in a 8' x 8' x 40' shipping container). Shipping by Air about 2 - 4 days. Samples shipped UPS or Fed Ex.

## Caring Best For Those Most In Need.™

Questions? E-mail us at [shelter@best.com](mailto:shelter@best.com). Please feel free to call or write us anytime. Shelter Systems-OL, 224 Walnut St., Menlo Park, CA 94025. FAX 650-323-1220 Phone 650-323-6202.

Shelters

Greenhouses

What's New?

Gillis Designs

Stories

Q's & A's

**Shelter Systems** © 1996 - 2003 All Rights Reserved

[Shelter Systems' Home](#)





# Emergency and Disaster Relief Portable Tunnel or Quonset Shaped Tent Shelters

Shelter Systems' **Emergency and Disaster Relief Portable Tunnel or Quonset Shaped Tent Shelters** were designed to cover a rectangular space. Since there is no cutting or sewing in the structure it is cost effective to produce. The large doors assure good ventilation. Both sizes of the sturdy yet lightweight **Emergency and Disaster Relief Portable Tunnel or Quonset Shaped Tent Shelters** has been used for a large variety of shelters for over 14 years. The **Emergency and Disaster Relief Portable Tunnel or Quonset Shaped Tent Shelters** can be placed end to end to produce a longer enclosure. The **Emergency and Disaster Relief Portable Tunnel or Quonset Shaped Tent Shelter** is freestanding and portable. It's covered with a strong, waterproof ripstop film. **Emergency and Disaster Relief Portable Tunnel or Quonset Shaped Tent Shelters** have been used as emergency relief shelters in Guatemala by the United States Government.

## Easy Set Up

The **Emergency and Disaster Relief Portable Tunnel or Quonset Shaped Tent Shelters** is packaged with all hubs and clips attached. Just slip the interchangeable poles into the hubs and in 40 minutes the **Emergency and Disaster Relief Portable Tunnel or Quonset Shaped Tent Shelters** is up. It's very easy. Once up, you may lift or turn your shelter into any position since it is free standing. If your **Emergency**



**and Disaster Relief Portable Tunnel or Quonset Shaped Tent Shelters** needs to be transported or stored, it can be disassembled in 5 minutes by removing the poles and rolling it into a compact bundle.

## Sturdy Design

The strong woven, laminated [ripstop film](#) used in all our structures has been treated with ultraviolet inhibitors to insure extra long life. The white out and black in laminated fabric we use

in our **Emergency and Disaster Relief Portable Tunnel or Quonset Shaped Tent Shelters** block 100% of the sun. The upper 1/3 of the doors are made of a translucent skylight material that lets 90% of the light in (more than glass). Unique to Shelter Systems' structures are the molded [Grip Clips™](#) at each hub. They are made of an extremely durable plastic. The importance of these components lies in the fact that they grip the film without puncturing it - there are no weak points to tear out in Shelter Systems' structures.



### **Proven Performance**

The tension achieved by the network of hubs and poles keeps the film stretched drum tight in the wind, preventing tear due to wind vibration. The **Emergency and Disaster Relief Portable Tunnel or Quonset Shaped Tent Shelter's** doors (one at each end) have been designed to bypass the need for zippers. We use hook closures. Zippers are notorious for breaking after a short working life. Our experience has shown that,

without them, our doors can't malfunction! An added benefit: there is no sill of material spanning the entrance at ground level. This means that when the doors are open, you have complete access.

**Emergency and Disaster Relief Portable Tunnel or Quonset Shaped Tent Shelters being used in the winter.**

### **Complete Shelter System**

The **Emergency and Disaster Relief Portable Tunnel or Quonset Shaped Tent Shelters** come complete with clips and connectors attached to covering, poles, stakes, and instruction manual.



**Emergency and Disaster Relief Portable Tunnel or Quonset Shaped Tent Shelters in use.**

**Price and Payment**

Payment is by advanced wire transfer or irrevocable letter of credit. CIF pricing is available upon request

**Emergency and Disaster Relief Portable Tunnel or Quonset Shaped Tent Shelters 9**

9' x 9' x 7' High, Weight: 40 lb.

Quantities of 1000 **\$200** each

**Emergency and Disaster Relief Portable Tunnel or Quonset Shaped Tent Shelters 11**

11' x 11' x 7' High, Weight: 51 lb.

Quantities of 1000 **\$250** each

**Floor 9' x 9'**

Quantities of 1000 **\$10** each

**Floor 11' x 11'**

Quantities of 1000 **\$15** each

FOB from Georgia, USA. Poles and covering are packaged separately. Shipping by Sea takes about three weeks Shipping by Air about 2 - 4 days. Samples shipped UPS or Fed Ex.

**For orders call 650-323-6202**

Questions? E-mail us at [shelter@best.com](mailto:shelter@best.com). Please feel free to call or write us anytime. Shelter Systems-OL, 224 West O'Connor St., Menlo Park, CA 94025. FAX 650-323-1220 Phone 650-323-6202.

**Shelter Systems** © 1996 - 2001 All Rights Reserved

[Shelter Systems' Home](#)

### **Shelter Systems' Emergency and Disaster Relief Shelter Frames**

Our Emergency Disaster Relief Shelter Frame Kits are designed to utilize an approximate 24' by 24' sheet of OFDA plastic sheeting (not included) although it is compatible to use with other sizes and types of sheeting and covering materials. The PVC frame is intended to be configured in a specific domed shape that couples with Shelter Systems non puncturing Grip Clips™ to covering in a strength enhancing manor to create the maximum strength for the materials used. The Emergency Disaster Relief Shelter Frame Kits and instructions also suggest other possible configurations that the end user might find more appropriate to their needs. When the Emergency Disaster Relief Shelter Frame Kit is no longer needed, each section of the PVC frame is easily joined to another to create a continuous water tight conducting pipe line that can be used for drinking water or irrigation. Patents and Pending. No tools required. Comes compleat with segmented poles, tie tape, cords, Heavy Duty Grip Clips™, stakes and instructions. Quantities of 1000 **\$170** each.



### **Shelter Systems' Emergency and Disaster Relief Shelter Frames**

Quantities of 1000 **\$175** each

FOB from Georgia, USA. Shipping by Sea takes about three weeks. Boxed 16" x 13" x 42". Shipping by Air about 2 - 4 days.

**For orders call 650-323-6202**





# Emergency and Disaster Relief Tarp Tent Shelter Grip Clips™

The Strongest, Most Versatile Tarp Fastener Ever!™

**Emergency and Disaster Relief Tarp Tent Shelter Grip Clips™ Fasteners** attach quickly and easily to tarps or any fabric without tools. They can be used to join two tarps or to shape a tarp into a shelter or to a desired function by gathering up a fold. It also provides a secure anchor for staking or attaching poles or guy lines.

## Thousands of Uses

In a relief situation Grip Clips™ Disaster Relief Tarp Tent Shelter Tarp Fasteners can transform tarps and fabric into hundreds of useful items: shelters and tents of all kinds, raincoats, water catchments, trouts, tubs, covers, curtains, mosquito netting. You can secure tarps to standing walls to create secure roofs. Join and repair tarps...The possibilities are endless!



Almost indestructible and at times indispensable!™

- Easy Assembly
- Will Not Puncture Tarps
- 150 lb. Side Pull
- 200 lb. 2-Tarp Hang Test
- Join Two Tarps
- Will Not "Pop Off"
- Pull From Any Direction
- Repair Torn Tarps

## The Design

The Grip Clip™ Disaster Relief Tarp Tent Shelter Tarp Fasteners specially designed to lock on to tarps and fabrics, without puncturing them. The Grip Clip™ tarp fastener will withstand a 150-to-200 lb. pull without coming off or tearing the tarp at the point of attachment. We achieve this through the following design features. The tarp passes over and under multiple sections of the

tarp fastener. Thus the tarp is in contact with a large surface area of the fastener. By spreading out the force exerted on the tarp and increasing the friction between it and the fastener, the tarp is prevented from slipping or tearing. The two pieces of the Grip Clip™ tarp fastener lock together (somewhat like a button in a button hole), engaging the tarp between them, so that the two pieces cannot come apart accidentally.

### Construction

The Grip Clip™ Disaster Relief Tarp Tent Shelter Tarp Fastener is made of a UV-stabilized (for longer sun resistance), extremely tough and durable copolymer. The tarp fastener's Trademark color is white to reflect the sun's heat and light which will prevent the sun from degrading the tarp at points of attachment. The cord provided with each Grip Clip is of super strong nylon with a weight-bearing strength of 550 pounds.

### The Revolution

The Grip Clip™ Disaster Relief Tarp Tent Shelter Tarp Fasteners will revolutionize the way you think of tarps. No more grommets ripping out and your expensive tarp, ruined, flapping in the wind. You will find that you can--on the spot--join and shape tarps to create watertight covers without resorting to sewing (time consuming and leaks at the seams), tape (messy and peels off) or other inferior tarp fasteners (which pop off when tarp is loaded sideways).

### Tarp Shelters

Shelters constructed using the Grip Clip™ Disaster Relief Tarp Tent Shelter Tarp Fasteners can be shingled providing greater strength and making them water tight because they do not puncture the cover. Grip Clips allow for you to pull out on tarps and thus provide more room under the tarps. The part of Grip Clips that is inside the shelter has holes in it so you can tie a pole to it to support the tarp from within or attach cords, room dividers, or insulating liners. The Grip Clips are removable and reusable.

**Light Fabric Grip Clip™**



Light Fabric Grip Clip (1

**General Purpose Grip Clip™**



**Heavy-duty Grip Clip™**



Heavy-duty (3 5/8") Grip Clip



|                                                                                                               |                                                                                                                                                                 |                                                                                                                                  |
|---------------------------------------------------------------------------------------------------------------|-----------------------------------------------------------------------------------------------------------------------------------------------------------------|----------------------------------------------------------------------------------------------------------------------------------|
| <p>3/8") is tough and small. Use for thin nylon tarps and mosquito netting.</p> <p>Weight: 6 grams, .2 oz</p> | <p>General Purpose (2 3/8") Grip Clip is versatile and strong. Use with normal tarps plastic coverings, and the woven films.</p> <p>Weight: 14 grams, .5 oz</p> | <p>is rugged and tough. Use in severe weather, for extra strength or on large or thick tarps.</p> <p>Weight: 28 grams, 1 oz.</p> |
|---------------------------------------------------------------------------------------------------------------|-----------------------------------------------------------------------------------------------------------------------------------------------------------------|----------------------------------------------------------------------------------------------------------------------------------|

**Emergency and Disaster Relief Tarp Tent Shelter Grip Clips™ Fasteners:  
Call for pricing**

**Payment**

Payment is by advanced wire transfer or irrevocable letter of credit. CIF pricing is available upon request

FOB from California, USA. Shipping by UPS or Fed Ex.

**Caring Best For Those Most In Need.™**

**For orders call 650-323-6202**

Questions? E-mail us at [shelter@best.com](mailto:shelter@best.com) Please feel free to call or write us anytime. Shelter Systems-OL, 224 Walnut St., Menlo Park, CA 94025. FAX 650-323-1220 Phone 650-323-

**Shelter Systems © 1996 - 2001 All Rights Reserved**

[Shelter Systems' Home](#)

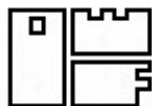

# OUTDOOR WILDERNESS FABRICS INC.

16415 Midland Blvd \* Nampa, Idaho 83687 \* **FAX:** (208) 463-4622 or (800) 333-6930

**PHONE:** (208) 466-1602 or For Orders Only: (800) OWF-SHOP (693-7467)

**Complete orders only** E-MAIL: [order@owfinc.com](mailto:order@owfinc.com) for questions: [owfinc@owfinc.com](mailto:owfinc@owfinc.com)

Monday-Thursday 8-5 MST Friday 8-4 MST closed Saturday and Sunday except by special appointment.

[Home](#)
[OWF TALKS](#)
[e-mail OWF](#)
[Friends of OWF](#)
[THE CREW](#)
[FABRICS](#)
[CAMOUFLAGE](#)
[HARDWARE](#)
[PATTERNS](#)
[ZIPPERS](#)
[ORDER INFO](#)
[CATALOG](#)

## Sale Items for September



**Outdoor Wilderness Fabrics** is in business for **YOU**. We strive to carry everything you need to create your own Outdoor Gear and we work to have the best prices anywhere. Browse through each page and let your creativity run wild.

Make your own **skiwear**, **winter wear** or **fleece clothing**. Sew up a **tent**, **tarp** or **sleeping gear**. We carry just the right fabrics and hardware for your **packs** and **bags** of all kinds. Don't forget your pets, maybe they need a **dog pack** or a **horse blanket**. Your kids would love a new **kite** or maybe make a **windsock** for yourself.

Whatever you want to make we have the supplies you need. **If we don't carry it, we will do our best to find it for you, or tell you who does carry it.**

**We now offer, straight cut, stack cutting service for our customers interested in this option.**

**Please ask for pricing. Pricing is determined by the job.**

### Sample Options:

|                                   |        |
|-----------------------------------|--------|
| Full Set of Fabric Samples        | \$6.00 |
| Set of Fleece Fabric              | 3.25   |
| Set of Nylon/Woven Fabric         | 3.25   |
| Set of Fleece Prints 3" x 3"      | 2.50   |
| Fleece 6x6" single samples (each) | .50    |
| Set of Fleece Camo Prints 3" x 3" | 2.50   |
| Set of Camo Nylon Fabric 3" x 3"  | 2.50   |
| Cording Sample Card               | .50    |
| Insulation Sample Card            | .50    |
| Webbing Sample Card               | .50    |
| Elastic Sample Card               | .50    |
| 1 String                          | Free   |

### Address & Phone numbers

**Come see us if you are in our area.**  
**We would love to give you a tour of our shop.**  
[\(map of our location\)](#)

Find any bugs? e-mail us [owfinc@owfinc.com](mailto:owfinc@owfinc.com)

This site was last updated:  
**Friday, September 03, 2004**

**33032** Visitors this year



Copyright © 2003 OUTDOOR WILDERNESS FABRICS, INC. All rights reserved.  
*This web page was developed and is maintained by: [Webmaster](#)*

**Please come see us if you are in our area.**

## **Shelter Systems' Emergency and Disaster Relief Shelter Frames**

Our Emergency Disaster Relief Shelter Frame Kits are designed to utilize an approximate 24' by 24' sheet of OFDA plastic sheeting (not included) although it is compatible to use with other sizes and types of sheeting and covering materials. The PVC frame is intended to be configured in a specific domed shape that couples with Shelter Systems non puncturing Grip Clips™ to covering in a strength enhancing manor to create the maximum strength for the materials used. The Emergency Disaster Relief Shelter Frame Kits and instructions also suggest other possible configurations that the end user might find more appropriate to their needs. When the Emergency Disaster Relief Shelter Frame Kit is no longer needed, each section of the PVC frame is easily joined to another to create a continuous water tight conducting pipe line that can be used for drinking water or irrigation. Patents and Pending. No tools required. Comes compleat with segmented poles, tie tape, cords, Heavy Duty Grip Clips™, stakes and instructions. Quantities of 1000 **\$170** each.



## **Shelter Systems' Emergency and Disaster Relief Shelter Frames**

Quantities of 1000 **\$175** each

FOB from Georgia, USA. Shipping by Sea takes about three weeks. Boxed 16" x 13" x 42".  
Shipping by Air about 2 - 4 days.

**For orders call 650-323-6202**

The Shelter Frame put up easily by first tape tying two poles at the top.



This shows the tape tying process.



After the Shelter Frame is assembled and secured a Grip Clip™ is attached to the center of a tarp approximanlty 24' by 24'. This tarp fasterner is then tied to the center top of the Shelter Frame.



The tarp is then tied to the frame with more Grip Clip tarp fasteners at multiple points. This straightens and stabilizes the frame and holds the tarp to the frame in high winds.





The tarp is gathered at the base to shape it to fit the frame and tied to stakes to hold the shelter down in winds.



As many as four doors can be opened by rolling up and tying the tarp at the middle of the sides.



Door rolled and tied up from the inside of the shelter.



Sidewall rolled up for cooling.



Low vent.



Roomy interior. Good ventilation. Strong frame for use with tarps of any kind or other covering such as cardboard, mats etc. The parts of this frame kit can be combined to make many other shaped frames. Each pole segment is flared at its end and can be joined together to create a long water or irrigation pipe. The tarp fasteners can be used to join tarps together to make larger structure and can be adapted to other poles such as bamboo.

