

AT MICROFICHE
REFERENCE
LIBRARY

A project of Volunteers in Asia

Slow Sand Filtration

by: L. Huisman and W. Wood

Published by:
World Health Organization
CH-1211 Geneva 27
Switzerland

Paper copies are \$ 7.40.

Available from:
World Health Organization
Distribution and Sales Service
CH-1211 Geneva 27
Switzerland

Reproduced by permission of the World Health Organization.

Reproduction of this microfiche document in any form is subject to the same restrictions as those of the original document.

SLOW SAND FILTRATION

L. HUISMAN & W. E. WOOD



World Health Organization, Geneva

SLOW SAND FILTRATION

L. HUISMAN

*Professor of Sanitary Engineering, Department of Civil Engineering,
Technological University, Delft, Netherlands*

W.E. WOOD, F.I.C.E.

*formerly Chief, Community Water Supply,
World Health Organization, Geneva*



WORLD HEALTH ORGANIZATION

GENEVA

1974

ISBN 92 4 154037 0

© World Health Organization 1974

Publications of the World Health Organization enjoy copyright protection in accordance with the provisions of Protocol 2 of the Universal Copyright Convention. For rights of reproduction or translation of WHO publications, in part or *in toto*, application should be made to the Office of Publications and Translation, World Health Organization, Geneva, Switzerland. The World Health Organization welcomes such applications.

The designations employed and the presentation of the material in this publication do not imply the expression of any opinion whatsoever on the part of the Director-General of the World Health Organization concerning the legal status of any country or territory or of its authorities, or concerning the delimitation of its frontiers.

The mention of specific companies or of certain manufacturers' products does not imply that they are endorsed or recommended by the World Health Organization in preference to others of a similar nature that are not mentioned. Errors and omissions excepted, the names of proprietary products are distinguished by initial capital letters.

PRINTED IN BELGIUM

CONTENTS

	Page
Preface	7
1. INTRODUCTION	9
Water quality criteria	10
Choice of raw water source	11
Choice of treatment processes	12
2. FILTRATION OF WATER SUPPLIES	15
History	15
Comparison of filter types	16
Elements of a slow sand filter	18
Purification in a slow sand filter	20
Application of slow sand filtration	22
Limitations of slow sand filters	23
Advantages of slow sand filters	25
3 THEORY OF BIOLOGICAL FILTRATION	27
Mechanisms of filtration	27
Effects of algae on filters	34
Hydraulics of filtration	38
Effects of filtration on delivered water quality	43
4. FILTER DESIGN AND CONSTRUCTION	47
Supernatant water reservoir	51
Filter-bed	52
Under-drainage system	54
Filter box	59
Filter controls	64
Covering of filters	70
5. OPERATION AND MAINTENANCE	73
Initial commissioning of a filter	76
Filter cleaning	78
Resanding	80
Mechanical cleaning of filters	84
Choice of cleaning methods	94
Management	95

6. SLOW SAND FILTRATION AND ARTIFICIAL RECHARGE	99
Methods of artificial replenishment	100
Slow sand filtration in artificial recharge	105
Artificial recharge in the Ruhr	106
Reduction of salt content	108
Annex 1. Maximum variation in piezometric level in a typical under- drainage system	111
Annex 2. Piezometric level in an under-drainage system constructed with standard bricks	115
Selected bibliography	116
List of reviewers	117
Index	119

Preface

In recent years there has been a tendency to assume that slow sand filtration is an old-fashioned method of water treatment that has been completely superseded by rapid-gravity and other high-rate filtration techniques.

This idea is definitely mistaken. Under suitable circumstances, slow sand filtration may be not only the cheapest and simplest but also the most efficient method of water treatment. Its advantages have been proved in practice over a long period, and it is still the chosen method of water purification in certain highly industrialized cities as well as in rural areas and small communities. It has the great advantage over other methods that it makes better use of the local skills and materials available in developing countries, and it is far more efficient than rapid filtration in removing bacterial contamination.

Because of the evidence that water treatment designers tend to neglect consideration of slow sand filters when planning new works, the World Health Organization commissioned Professor L. Huisman, an internationally known specialist in water treatment, to visit and report on installations using slow sand filtration in various parts of Europe and to compare costs and performance, particularly with regard to the quality of the treated water. From his original study, Professor Huisman, in collaboration with Mr W. E. Wood, formerly Chief, Community Water Supply, WHO, developed the present book, which describes the construction and operation of modern slow sand filters, the latest developments in operating techniques, the theory of biological filtration, and the application of the principle of slow sand filtration to the artificial recharging of groundwater sources—a technique practised extensively in the Netherlands.

It is hoped that the book will encourage the greater use of the excellent and reliable method of slow sand filtration, especially in developing countries.

1. Introduction

The object of this volume is to discuss the various aspects of one particular form of water treatment--the "biological filtration" or "slow sand filtration" process. This system of water purification has been in continuous use since the beginning of the nineteenth century, and has proved effective under widely differing circumstances. It is simple, inexpensive, and reliable and is still the chosen method of purifying water supplies for some of the major cities of the world.

A myth has grown up that this process is old-fashioned and therefore inefficient, that new techniques have rendered it obsolete, and that because it is simpler than many more recent innovations it is necessarily inferior to them.

None of these objections to biological filtration is warranted. In many circumstances it is still the most appropriate choice when treatment methods are being selected, and the designer who automatically turns to other methods is often acting in ignorance of the potentialities of the technique.

It is perhaps paradoxical that this water treatment process, the oldest of them all, is one of the least understood and that less scientific research has been carried out into its theoretical and practical application than into other more recent but less effective methods. It is hoped that this volume will help to redress the balance. No startling new discoveries are reported; rather, the book gathers together the results of practical experience gained in many countries under diverse conditions and summarizes the theoretical work carried out in many institutions on different aspects of the process. It does not claim that the processes described are necessarily applicable everywhere and under all conditions; indeed, no single panacea has yet been found, or is likely to be found, that will solve every water treatment problem. It is hoped, however, that it will enable those responsible for deciding on treatment methods for new supplies to judge whether safety, efficiency, and economy may be more readily attainable through the use of slow sand filters than through the use of any other comparable method in the prevailing conditions.

Before proceeding to describe the details of the process, we shall first consider the criteria upon which such judgements depend.

Water quality criteria

Modern technology provides a choice of treatment methods that can produce virtually any desired quality of water from any given source, the limiting factor being economic rather than technical. Where cost is no constraint, it is possible to obtain water of an extremely high degree of purity from such unlikely raw materials as seawater or sewage effluent by a variety of methods such as distillation, electro dialysis, or reverse osmosis. Compared to the cost of producing drinking-water from relatively unpolluted ground or surface water sources, such processes are very expensive and are outside the scope of the present volume, which will be confined to a discussion of the so-called "conventional" methods of treatment.

By the selection and combination of different stages of treatment and by the judicious choice of source, it is possible to achieve varying degrees of water quality at varying capital and running costs. Those responsible for planning new supplies must therefore decide first of all what they want to achieve in this direction.

It is probably easiest to define the minimum quality that should be permitted in any water supply destined for drinking and domestic purposes. This minimum standard water is often referred to as "safe" water because it contains nothing that can harm the consumer, even when ingested over prolonged periods. To achieve this condition, parasites and pathogenic organisms must be reduced or inactivated to the point where they do not constitute a hazard to the consumer, and toxic and radioactive substances must not be present in excess of the maximum permissible levels that research and experience have shown to be safe. Guidance on these matters may be found in the *International Standards for Drinking-Water*.¹

A safe water is one that cannot harm the consumer when drunk under normal conditions. This does not necessarily mean that it is pleasant to drink or to use for domestic purposes. It may be coloured, excessively hard, have an unpleasant odour, possess a bitter or salt taste, contain iron or manganese salts that stain clothes washed in it, or corrode pipes and metal fittings with which it comes into contact. In some cases it may be sufficiently unpalatable to drive consumers to other, less safe, sources. Water supplied to a community should therefore be not only completely safe but agreeable to use; such a supply may be termed "acceptable" or "potable".

The provision of more social amenities and greater economic prosperity of a community are usually followed by a call for an increasing standard of water quality, for which the community is prepared to pay. Occasional harmless discoloration due to seasonal turbidity of the source, which may

¹ World Health Organization (1971) *International standards for drinking-water*, 3rd ed., Geneva.

be acceptable in a remote village, will not be tolerated in the modern city. Prosperous communities demand a "good" water—one that is safe and has consistently good physical properties, with perhaps other refinements such as carefully controlled pH and hardness, the addition of fluorides to combat dental decay, an absence of chlorine smell, a "live" taste associated with the correct degree of oxygenation, and so on. It is unlikely that all these demands will be made in the initial stages, but the planner, while attempting to meet the customary need for economy, must make provision for the later addition of refinements, which experience has shown are eventually demanded by consumers.

Choice of raw water sources

It is often stated that when alternative sources of water are available for use as a public supply the overriding criterion for selection should be the quality of the raw water. Although there is some foundation for this assertion, it is not invariably true; reliability may be more important, since technically it is often more feasible to improve the quality than to increase the quantity of a supply. In a natural desire to supply the safest and best quality water possible, the planner may underestimate the importance of ensuring that the source is of sufficient size to satisfy future demand. Just as improved quality is called for with improved social and economic conditions, so does the amount of water required increase. This increase is due to two separate pressures—population growth and greater personal requirements of individual members of the population. It is worth noting that in several cities suffering from outbreaks of cholera it was established that the quality of the water delivered by the public supply was satisfactory but that the quantity was insufficient, so that people were forced to drink from other, unsafe, sources.

With this proviso, it is undoubtedly good practice whenever a choice exists between two sources of adequate capacity to select the one that is potentially least dangerous. The word "potentially" is stressed; the present excellent quality of the mountain stream is no guarantee of its future quality, and treatment proposals must always assume that at some time it will become contaminated with human excreta and that the individual from whom this contamination originates will be suffering from (or be a carrier of) an infection capable of being transmitted by water.

This potential hazard must always be attributed to surface supplies, however rigidly it is possible to control the catchment area from human access. Seagulls, for instance, can transmit infection from a sewage disposal works or sewer outfall to any open body of water on which they subsequently alight. Thus, when an adequate source of groundwater exists it will almost always be worthy of consideration as a preferable alternative.

Exceptions occur, of course, as with groundwater held in karstic limestone that has fissures through which pollution can rapidly travel from the surface to the groundwater. Again, subsurface supplies may be so heavily impregnated with minerals that they constitute a hazard from chemical toxicity. In general, however, it is true to say that groundwater needs minimal or no treatment while surface water must always be assumed to contain pathogens that have to be removed or inactivated.

It is sometimes claimed that surface water can be so effectively treated that the advantages of groundwater sources can be ignored, but there is always an implicit hazard (however remote) when the quality of the delivered water depends on the regular supply of chemicals or on freedom from human error or mechanical breakdown.

Certainly for smaller supplies, and for those where supervision and skilled operation are less than desired, there is much to be said for choosing a safer underground source (provided that its reliability has been established) even if its use involves some additional capital and recurrent cost. Such extra expenditure is, in any case, frequently counterbalanced in whole or in part by savings in the cost of treatment.

Choice of treatment processes

In its natural state, during its passage through the hydrological cycle, water is constantly changing in chemical and bacteriological composition. Polluting and purifying processes are continually at work. At the moment of evaporation from the ocean's surface it is virtually a pure compound of hydrogen and oxygen; when it reaches the point of condensation it is mixed with carbon dioxide and other gases; during its fall to earth it collects dust particles and dissolves further gases, both those naturally occurring and those present as pollutants in the air. On reaching the ground and during its passage above or within the ground it not only dissolves minerals from the rocks with which it comes into contact but also acquires a load of suspended solids (many of organic origin) and an infinite variety of living matter, ranging from microorganisms through a number of animal and vegetable species to large and complex aquatic life forms, such as fish and water weeds. At the same time it is being acted upon by sunlight, aeration, biological oxidation, settlement, chemical reactions, and the action of predators in the ascending food chain, all of which tend to convert those organisms that might be hazardous to humans into harmless and even beneficial forms.

Man, extracting water at any stage of this cycle, makes use of these natural processes of purification and creates conditions that will enable them to be speeded up in time and compressed in space. However complex or sophisticated modern processes may be, each has (with one exception)

its counterpart in nature. Even modern desalination and demineralization techniques derive from natural processes; distillation plants simulate evaporation from the surface of the sea; osmotic and membrane techniques attempt to do what the fish's skin, the vegetable cell wall, and the human kidney are continuously achieving; freezing separation can be seen in the formation of largely fresh-water ice in the ocean. Among the conventional treatment methods, sedimentation, microstraining, flocculation, filtration, aeration, and ultraviolet disinfection have their counterparts in natural processes acting on surface and ground waters.

The exception referred to above is the addition of concentrated chemicals to raw or treated water either to intensify one of the natural processes (e.g., a coagulant to speed up flocculation) or to inactivate living organisms (e.g., chlorine to disinfect water or kill algae). A significant difference between natural and artificial processes arises in the latter case; in nature the organisms die away and are consumed, settled, and strained out, while disinfection kills them without removing them and at the same time adds an additional constituent to the treated water.

Undoubtedly the introduction of chlorination at the beginning of the present century greatly increased our ability to ensure the safety of drinking-water supplies. It was an entirely new approach to water treatment and a technical innovation of the greatest importance—today it would be hailed as a major “breakthrough”. As a result there has been a tendency in some quarters to regard it as a process complete and sufficient in itself rather than to look upon it as a useful stage in a complete treatment pattern, as a second line of defence in the event of malfunctioning of other processes, and as a means of inactivating that small percentage of pathogens that inevitably slip through the various stages of conventional treatment. It is also frequently forgotten that to achieve efficient disinfection, the water must be prepared for chlorination by the prior removal of substances that would tend to inhibit the disinfecting properties of chlorine.

The water supply planner, having decided on the quality standard at which he is aiming, and having selected the source of water to be used, has at his disposal a range of processes to achieve his purification requirements. If he is fortunate enough to have access to an underground source with a safe level of chemical constituents he may be able to dispense with purification entirely or use simple chlorination alone as a safety measure. If his source is a surface one he will probably design a system that operates in successive stages.

(1) The chemical forms of dissolved substances are changed as far as possible to permit their removal in stage (2) (e.g., using aeration to break down organic compounds, to convert soluble ferrous salts into insoluble ferric ones, to oxidize other salts, and to remove or convert dissolved gases).

(2) As much suspended matter and as many living organisms as possible are removed by settlement (assisted by chemical treatment if necessary), straining, and filtration.

(3) Most of the organisms are allowed to die off in storage and the remainder are killed by chlorination, the water having first been prepared (e.g., by removing ammonia and organic matter) to enable the applied chlorine to exert the maximum disinfecting action.

It is because slow sand filtration combines within itself so many of these purification functions that it is still the most useful all-round treatment process. Within a single unit it incorporates settlement, straining, filtration, organism removal, organism inactivation, chemical change, and (to some extent) storage. It prepares water for subsequent chlorination (if, indeed, this is deemed necessary) with maximum efficiency. It has certain limitations, which will be fully discussed later, and it may be necessary to reinforce certain of its purification functions by pretreatment, in order to achieve an economic design and to deal with unusually severe quality defects in the raw water. It probably represents the nearest approach, in each of its functions, to the processes that occur in nature. Perhaps because of this it has unusual powers to suffer misuse without failure, and a capacity for self-regeneration after such misuse.

2. Filtration of water supplies

History

As far as is known the first instance of filtration as a means of water treatment dates from 1804, when John Gibb designed and built an experimental slow sand filter for his bleachery in Paisley, Scotland, and sold the surplus treated water to the public at a halfpenny per gallon.¹ He and others improved on the practical details, and in 1829 the method was first adopted for a public supply when James Simpson constructed an installation to treat the water supplied by the Chelsea Water Company in London. By 1852 the practice had become so established, and its advantages so evident, that the Metropolis Water Act was passed requiring all water derived from the River Thames within 5 miles of St Paul's Cathedral to be filtered before being supplied to the public.

At that time the existence of pathogenic bacteria was unknown, and the slow sand filter was regarded as a mechanical means of straining out turbidity and suspended solids. John Snow, however, in his studies of cholera transmission, had come to the conclusion that the disease was waterborne, and he postulated the existence of *materies morbi*—a material derived from previous cases that could transmit infection to those who ingested it. This *materies morbi* was removed, with other solids, by filtration, or could be avoided by drawing the supply from a point upstream of any sewer discharge. As a result the first regular examinations of water supplies, including chemical analyses, were initiated in London in 1858. In 1885, following the discoveries of Pasteur, Koch, Escherich, and others during the 1860s and 1870s, they were extended to include bacteriological examination.

The most convincing proof of the effectiveness of water filtration was provided in 1892 by the experience gained in two neighbouring cities, Hamburg and Altona, which drew their drinking-water from the River Elbe, the former delivering it untreated except for settlement, while the latter filtered the whole of its supply. When the river became infected from

¹ Baker, M.N. (1949) *The quest for pure water*, New York, American Waterworks Association.

a camp of immigrants, Hamburg suffered from a cholera epidemic that infected one in thirty of its population and caused more than 7 500 deaths, while Altona escaped almost unscathed. Subsequent waterborne epidemics in many parts of the world have confirmed this experience; in every case infection has been almost entirely confined to people drinking unfiltered water.

In 1885 the first mechanical filters were installed in the USA, and in 1899 automatic pressure filters were first patented in England. Since then a number of modifications and improvements have been introduced and have attained varying degrees of popularity, particularly in highly industrialized countries. Most of these improvements relate to constructional details—the reduction of the amount of land required for construction or the introduction of automatic operation and control—rather than to the quality of the delivered water. Even today, the performance of the biological or slow sand filter in producing high-quality water has not been surpassed, and there are a number of cities in industrial countries where filters of this type are being (or have recently been) constructed; examples include Amsterdam, Antwerp, London, Paris, Springfield (Mass.), and various cities in Sweden and Japan.

Comparison of filter types

Filters may be divided into two types—pressure and gravity. Pressure filters consist of closed vessels (usually steel shells) containing beds of sand or of other granular material through which water is forced under pressure. These filters are frequently used in certain industrial situations, and a number have been installed for public water supplies. They are especially suitable in plants where a high degree of automation is necessary, in remotely situated treatment plants that have to operate with only occasional attendance, and in systems where for some reason it is desirable to have only a single pumping stage between the inlet and the distribution system. As their initial cost may be high, especially when their component parts have to be imported, their principal use is in the industrialized countries where they are manufactured; they will not be described here in detail as their operation is adequately explained in standard textbooks on water treatment.

A gravity filter consists essentially of an open-topped box (usually made of concrete), drained at the bottom, and partly filled with a filtering medium (normally clean sand). Raw water is admitted to the space above the sand, and flows downward under the action of gravity. Purification takes place during this downward passage, and the treated water is discharged through the under-drains. In turn, gravity filters are subdivided into slow and rapid types, the latter operating at rates 20–50 times faster than those of the

former, and hence requiring (in theory) only some 2–5% of the area needed for slow filters. In practice the reduction in space requirements is partially offset by the additional pretreatment stages needed for rapid filtration, and the figure is likely to be nearer 20%.

On the assumption that both types of gravity filter are equally efficient in removing suspended matter, it would appear that the rapid filter must become choked and require cleaning 20–50 times as often as the slow. However, the comparison is not as straightforward as this.

In slow filtration, a fine sand is used, and the designed rate of downward flow of the water under treatment normally lies between 0.1 and 0.4 m³/h per square metre of surface. Unless the water to be treated is of exceptional turbidity, a filter of this type may run for weeks or even months without cleaning. The suspended solids and colloidal matter are deposited at the very top of the bed, from which they can be removed by scraping off the surface layer to a depth of one or two centimetres. This infrequent operation may be carried out by unskilled labourers using hand tools or by mechanical equipment such as that described in Chapter 5.

The medium used in rapid filtration is considerably coarser, with an effective grain size of 0.6–2.0 mm. The interstices between the grains are larger, providing less resistance to the downward flow, and thus permitting higher velocities, usually in the range 5–15 m³/m²/h. Not only are the impurities deposited more rapidly, but they are carried more deeply into the medium. Some catalytic action also takes place, encouraging deposition of iron and manganese within the bed. As a result, the necessity for cleaning occurs at frequent intervals (often only one or two days), and, in order to restore the capacity of the filter and the quality of the effluent, the medium has to be cleaned throughout its whole depth. The only practical method so far developed of achieving this is by backwashing, a process in which high-pressure water is forced upwards through the whole bed and compressed air or mechanical agitation is used to scour the individual grains so that the accumulated impurities can be flushed away.

Raw water entering a slow sand filter lies for several hours (on average) in the space above the medium, during which time there is some separation and settlement of the larger particles. It then percolates through the sand-bed (a process taking 2 hours or more), and as it does so it is subjected to a number of purification processes that will be described later. In contrast, water is in contact with the bed of a rapid gravity filter for a few minutes only. If rapid filtration were the only treatment to be given, little effective bacterial purification and only limited chemical improvement could take place during this short time, and even the mechanical straining action would be less efficient owing to the larger water channels between the grains. However, rapid filters are frequently used in conjunction with earlier stages of chemical treatment, flocculation, and sedimentation, which remove most of the impurities in the raw water before it reaches the filter. The few

that do reach the filter-bed are easily removed in their coagulated state, the finer flocculi forming a film on the sand particles.

To this film further particulate impurities in the water adhere, and a certain degree of bacterial purification is believed to take place within its thickness, but in view of the frequency with which it is necessary to wash the coating from the grains it is unlikely that this bacterial action contributes significantly to the overall process.

A similar film builds up on the grains of a slow sand filter, but because it is not regularly washed away the purifying bacteria become well established and play an important part in the treatment process. It is because of this difference that slow filters are often referred to as "biological" filters.

Elements of a slow sand filter

Fig. 1 shows, in diagrammatic form, the various elements that go to make up a slow filter. Essentially these consist of:

FIG. 1. DIAGRAM OF A SLOW SAND FILTER

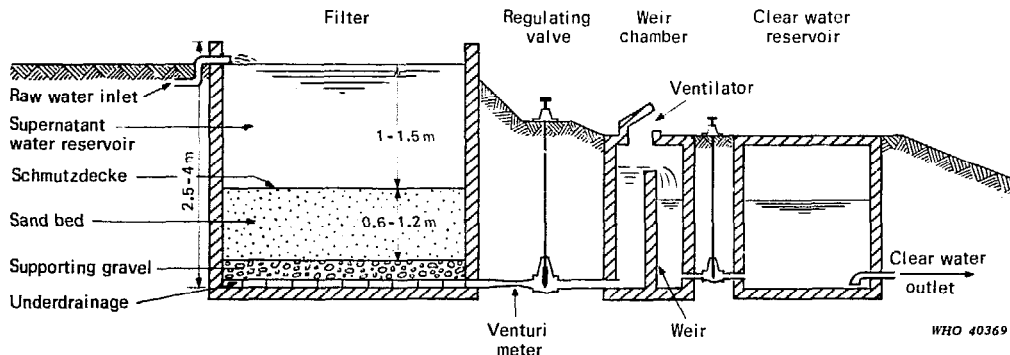

The control devices are shown in greater detail in Fig. 18.

(1) a supernatant (raw) water reservoir, the principal function of which is to maintain a constant head of water above the filter medium, this head providing the pressure that carries the water through the filter;

(2) a bed of filter medium (nearly always sand), within and upon which the various purification processes take place;

(3) an under-drainage system, which fills the dual purpose of supporting the filter medium while presenting the minimum possible obstruction to the treated water as it emerges from the underside of the filter-bed; and

(4) a system of control valves to regulate the velocity of flow through the bed, to prevent the level in the raw water reservoir from dropping below

a predetermined minimum during operation, and to permit water levels to be adjusted and backfilling to take place when the filter is put back into operation after cleaning.

The first three of these features are contained within a single open-topped filter box, the control valves being usually in adjacent structures. The box is usually rectangular in shape, from 2.5 to 4 metres in depth, and built wholly or partly below ground. To save space (particularly in larger installations) the walls are normally vertical or near-vertical, and may be made of stone, brick, or concrete according to which is most easily obtainable at the site. Sloping sides and a variety of lining materials may be found in the more remote locations where land is plentiful and economy of construction is the first consideration.

At the bottom of the box is the under-drainage system, which may consist of a false floor of porous concrete or a system of porous or unjointed pipes, surrounded and covered with graded gravel to support the sand-bed and prevent fine grains being carried into the drainage pipes.

Above the under-drainage system is the sand itself, to a thickness of 0.6–1.2 m, above which the raw water will lie to a depth of 1–1.5 m. Various refinements, such as scum removal channels, inlet, outlet, and drainage devices, will be described later.

FIG. 2. SLOW SAND FILTERS AT MADRAS WATERWORKS, INDIA

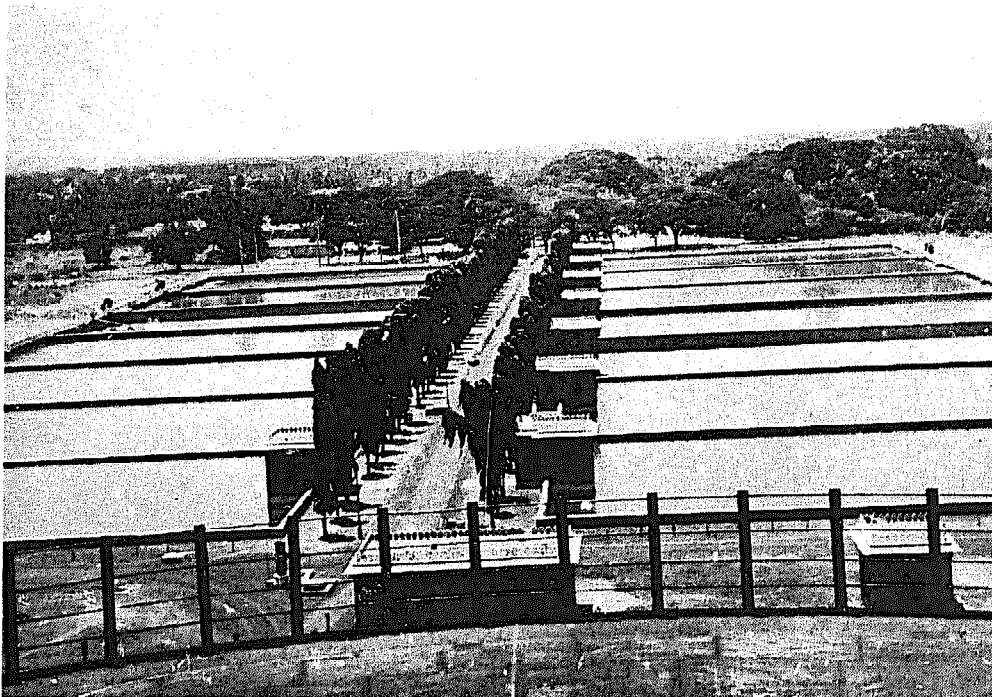

Madras Municipal Corporation/Swamy News Photo Service

Special mention should, however, be made of the outlet weir and valve to control the rate of flow. For reasons that will be fully explained it is most undesirable that the water level in the filter box should drop below the surface of the filter medium during operation. To eliminate the possibility of this happening, a weir is incorporated in the outlet pipe system. It accomplishes the dual purpose of maintaining a minimum water depth within the filter box and of aerating the outgoing water to some extent, so that oxygen is absorbed and dissolved gases, which might otherwise impart unpleasant tastes or odours to the treated water, are released. Moreover it renders the operation of the filter independent of fluctuations in the water level in the clear water reservoir.

The general appearance of a slow sand filtration plant is shown in Fig. 2.

Purification in a slow sand filter

The various processes that take place in a slow sand filter are described in some detail in Chapter 3, but the following paragraphs describe them briefly and show how they complement each other to provide an overall system that improves the physical, chemical, and bacteriological qualities of the delivered water simultaneously. Let us consider a particular sample of raw water in its passage through a biological filter and examine the various purifying influences that act upon it successively.

Firstly, the sample enters the water resting above the filter-bed, awaiting its downward passage through the medium. This raw water reservoir is about 1–1.5 m deep, and the average time that the sample will remain here varies from 3 to 12 hours, depending on the filtration velocity. The heavier particles of suspended matter start to settle, and some of the lighter particles coalesce, so becoming more amenable to subsequent removal. During the day, and under the influence of sunlight, algae are growing and are absorbing carbon dioxide, nitrates, phosphates, and other nutrients from the water to form cell material and oxygen. The oxygen dissolves in the water as it is formed and enters into chemical reaction with organic impurities, rendering these, in turn, more assimilable by the algae.

On the surface of the sand there is a thin slimy matting of material, largely organic in origin, known as the *schmutzdecke*, or filter skin, through which the water must pass before reaching the filter medium itself. The *schmutzdecke* consists of threadlike algae and numerous other forms of life, including plankton, diatoms, protozoa, rotifers, and bacteria. It is intensely active, the various microorganisms entrapping, digesting, and breaking down organic matter contained in the water passing through. Dead algae from the water above and living bacteria in the raw water are alike consumed within this filter skin, and in the process simple inorganic salts are formed. At the same time nitrogenous compounds are broken

down and the nitrogen is oxidized. Some colour is removed, and a considerable proportion of inert suspended particles is mechanically strained out.

Having passed through the *schmutzdecke*, the water enters the filter-bed and passes downwards through the interstices between the sand grains—a process that normally takes several hours.

When James Simpson installed his first slow sand filters nearly a century and a half ago, he had no idea of the complex processes of purification he was initiating. He looked upon his sand-bed as a very effective strainer that would retain those particles that were larger than the interstices between the sand grains. This straining action does undoubtedly take place, though in view of the preliminary screening undergone by the water in passing through the *schmutzdecke* it is unlikely that mechanical straining within the bed constitutes more than a small part of the total purification process. Only gradually, as the nature of colloids, bacteria, and viruses became known, did the earlier concept become obviously insufficient to explain the removal of these particles, the dimensions of which are much smaller than the pore sizes of the finest sand used in a filter-bed. Nevertheless the fallacy of regarding filter media solely as straining mechanisms has persisted until comparatively recently, and unwarranted doubts about the efficacy of biological filtration have been raised by falsely equating the results of laboratory tests, in which pathogens and some parasites have been shown to pass unaffected through a column of clean sand, with the conditions that prevail in a working filter through which the same organisms undoubtedly could not pass.

A more significant property of the sand-bed is adsorption, a phenomenon resulting from electrical forces, chemical bonding, and mass attraction interacting in a way that is not yet completely understood. Adsorption takes place at every surface at which water comes in contact with a sand grain. To appreciate the extent of this action it is necessary to visualize the interior of the sand bed as a series of grain surfaces over which the water must pass. The aggregate area of these surfaces is extremely high; in one cubic metre of filter sand there will be some 15 000 m²—one and a half hectares—of surface. Over this the water passes in a laminar flow that is constantly changing direction as it leaves one grain and meets the next. At each change of direction gravity and centrifugal forces act upon every particle carried by the water.

Between the grains are the pores or open spaces, totalling some 40% of the total volume of the bed. Water passing over a grain surface is suddenly slowed down each time it enters one of these pores, and as a result millions of minute sedimentation basins are formed in which the smallest particles settle onto the nearest sand grain before the water continues on its downward path.

Hence during the passage of the water through the bed every particle,

bacterium, and virus is brought into contact with the surfaces of the sand grains, to which they become attached by mass attraction or through the operation of electrical forces. The surfaces become coated with a sticky layer, similar in composition to the *schmutzdecke*, but without the larger particles and the algae, which have failed to penetrate. It sustains a teeming mass of microorganisms, bacteria, bacteriophages, rotifers, and protozoa, all feeding on the adsorbed impurities and on each other. The living coating continues through some 40 cm of the bed, different life forms predominating at different depths, with the greatest activity taking place near the surface, where food is most plentiful.

The food consists essentially of particles of organic origin carried by the water. The sticky coating holds the particles until they are broken down, consumed, and formed into cell material, which in turn is assimilated by other organisms and converted into inorganic matter such as water, carbon dioxide, nitrates, phosphates, and similar salts that are carried downward by the passing water. As the depth from the surface increases the quantity of organic food decreases and the struggle among the various organisms becomes fiercer. Other bacteria then predominate, utilizing the oxygen content of the water and extracting nutrients that would otherwise have passed unchanged in solution through the filter. As a consequence the raw water, which entered the bed laden with a variety of suspended solids, colloids, microorganisms, and complex salts in solution, has, in its passage through some 40–60 cm of filter medium, become virtually free of all such matter, containing only some simple (and relatively innocuous) inorganic salts in solution. Not only has practically every harmful organism been removed but also the dissolved nutrients that might encourage the subsequent growth of bacteria or slimes. It may be low in dissolved oxygen and may contain dissolved carbon dioxide but subsequent aeration caused by falling over the discharge weir will go far to remedying both these defects.

In tests on working filters it is not uncommon to find the total bacteria count reduced by a factor of between 1 000 and 10 000, and the *Escherichia coli* count by a factor of between 100 and 1 000. Starting with an average quality of raw water it is usual to find *E. coli* absent in a 100 ml sample of delivered water, thus satisfying normal drinking-water quality standards.

Application of slow sand filtration

Slow sand filtration is an efficient method of removing particulate suspended matter and is therefore applicable to the treatment of groundwater containing solids in suspension. In Surinam and elsewhere it is used to remove ferric and manganic compounds that have been converted by aeration from soluble ferrous and manganous salts in groundwater.

Its principal use, however, is in the removal of organic matter and

pathogenic organisms not normally found in groundwater, for which purpose it is a particularly appropriate form of treatment for surface waters of moderate turbidity. Although slow filters are capable of coping with turbidities of 100–200 mg/l for a few days, a figure of 50 mg/l is the maximum that should be permitted for longer periods, and the best purification occurs when the average turbidity is 10 mg/l or less (expressed as SiO_2). When higher turbidities are expected, biological filtration should be preceded by other forms of treatment, such as (in ascending order of efficiency):

- (1) plain sedimentation (for turbidities of 20–100 mg/l);
- (2) storage with microstraining for algae removal, the detention periods varying from a few weeks to a few months (for turbidities of up to several grams per litre);
- (3) natural screening prior to intake (for turbidities of 10–20 mg/l, depending on the degree of clogging of the river bed);
- (4) rapid “roughing” filtration (for turbidities of 20–50 mg/l); and
- (5) sedimentation preceded by chemical coagulation (if necessary) and followed by rapid “roughing” filtration (for turbidities of 50–200 mg/l).

The turbidity ranges quoted give only a general indication of the limits of each process, and it must be borne in mind that the degree and type of pretreatment may depend as much on the particle size distribution of the suspended matter in the raw water as on the total amount of solids present.

In each case biological filtration will be the last stage of treatment, except when the precautionary measure of chlorination is adopted. It should be particularly noted that biological treatment brings the water to the optimum condition for chlorination, thereby effecting considerable savings in the quantity of chemical required to achieve a given degree of disinfection.

Limitations of slow sand filters

Certain conditions may be encountered that may offset the advantages of slow sand filtration and lead to the choice of rapid filters as a more appropriate treatment method. These conditions are described briefly in the following paragraphs.

- (1) Where land is restricted or very expensive, the much larger area needed for biological filters may add considerably to the capital cost, or even rule out this form of treatment as a practical proposition.

The areas required for treatment plants vary widely and depend on many local considerations, but the following figures, based on actual plants

treating turbid river water and having capacities of about 50 million m³ per year, may be useful for purposes of comparison:

(a) rapid filtration plant, preceded by upward flow settling tanks, chemical dosing, etc.—3000 m²;

(b) slow sand filtration—20 000 m² to which must be added the following areas for pretreatment stages:

plain sedimentation—10 000 m²,

raw water storage—up to 1 000 000 m² according to detention period,

rapid “roughing” filters—1 000 m², and

coagulation and sedimentation—3 000 m².

(2) In countries where construction methods are largely mechanized and where the importation of such materials as steel and cast-iron pipework presents no problems, the reinforced concrete construction and metal fittings of rapid filters may be cheaper to construct than the more extensive (though simpler) non-reinforced construction of slow filters.

In the Netherlands, for instance, the initial cost of slow filters is nearly three times that of rapid filters, but this figure includes complete structural covering of the beds, and the installation of mechanical sand-bed cleaning equipment.

(3) Where unskilled labour for cleaning is in short supply it may be easier and cheaper to recruit the skilled staff required to operate and maintain rapid filters (especially when these are fitted with automatic control equipment) than to retain the necessary labour force. However, recent developments in mechanical cleaning of slow sand filters, which will be described later, make this condition of less consequence than formerly.

(4) In climates where the winters are very cold it may be necessary to install expensive structural precautions against freezing. At the same time the efficiency of purification will be adversely affected by low temperatures. Rapid filters will be equally affected, but because of their smaller area they are cheaper to cover.

(5) Where the water to be treated is liable to severe and sudden changes in quality or where certain types of toxic industrial wastes or heavy concentrations of colloids may be present, the working of biological filters can be upset.

(6) Certain types of algae may interfere with the working of the filters, the usual result being premature choking, which calls for frequent cleaning. In such cases it may be necessary to cover the filter-beds to exclude light—a comparatively expensive addition to capital cost unless it is possible to use locally available materials for the purpose. It is worth noting that this applies only to certain types of algae; other types may actually improve the quality of the treated water and the efficiency of the filters by oxygenating the supernatant water during the hours of daylight.

It is significant that, of the six adverse conditions given above, the first

five are particularly applicable to industrialized countries in northern latitudes, and yet, because the advantages of biological filtration so often outweigh the drawbacks, it is in those same industrialized countries that the world's largest installations embodying slow sand filters may be seen.

In countries where these limitations do not apply to such an extent, and for small installations especially, slow sand filtration is undoubtedly the simplest and most efficient method of treatment for many types of surface water.

Advantages of slow sand filters

(1) Quality of treated water

No other single process can effect such an improvement in the physical, chemical, and bacteriological quality of normal surface waters as that accomplished by biological filtration. The delivered water does not support aftergrowth in the distribution system, and no chemicals are added, thus obviating one cause of taste and odour problems.

(2) Cost and ease of construction

The simple design of slow sand filters makes it easy to use local materials and skills in their construction. The cost of imported materials and equipment may be kept to almost negligible proportions, and it is possible to reduce the use of mechanized plant to the minimum and to economize on skilled supervision. Design is easier, little special pipework or equipment is required, instrumentation can be almost completely eliminated, and a greater latitude in the screening of media and the selection of construction materials can be permitted. Only when a high price has to be paid for land and when expensive superstructures are necessary for protection against low temperatures is the capital cost of slow sand filters likely to equal or exceed that of comparable rapid filters.

(3) Cost and ease of operation

The cost of operation lies almost wholly in the cleaning of the filter-beds, which may be carried out either mechanically or manually. In developing countries and elsewhere where labour is readily available, the latter method will be used, in which case virtually the whole of the operating cost will be returned to the local economy in the form of wages.

No imported chemicals or other materials are needed for the process, though in many cases chlorination is practised as an additional safeguard. However, chlorination would be equally necessary with any other form of treatment, and, in general, the dosages required to disinfect biologically

treated water are less than those needed to disinfect water treated by other methods.

No compressed air, mechanical stirring, or high-pressure water is needed for backwashing, thus there is a saving not only in the provision of plant but also in the cost of fuel or electricity.

The operator of a biological filter requires far less training and skill than does his colleague in charge of a rapid gravity filter, and less supervision and support (e.g., laboratory testing of chemical quality) are called for. Slow sand filters automatically accommodate minor fluctuations in raw water quality, temperature, and climatic conditions and can stand short periods of excessive turbidity or demand without breaking down.

(4) *Conservation of water*

In water-short areas, biological filters have the additional advantage of not requiring the regular flushing to waste of wash water. In the case of pressure or rapid gravity filters, which need cleaning every few days, this wastage represents some 2-3% of the total amount treated. Reclamation may be practical in some places but represents an additional expense.

The water that is passed through a slow sand filter immediately after cleaning and before the biological function has been restored (a process known as "ripening") can either be returned to source or diverted to another filter since it does not carry any impurities additional to those in the raw water.

(5) *Disposal of sludge*

Sludge storage, dewatering, and disposal are less troublesome with slow sand filters than with mechanical filters, particularly when the latter contain chemical coagulants. Since the sludge from biological filters is handled in a dry state there is virtually no possibility of polluting neighbouring watercourses, and the waste material is usually accepted by farmers as a useful dressing for their land, the mixture of sand and organic matter being especially suitable for conditioning heavy clay soils.

3. Theory of biological filtration

Mechanisms of filtration

Biological (or slow sand) filtration is accomplished by passing raw water through a bed of sand. During its passage the particulate impurities are brought into contact with the surface of sand grains and held in position there. Those that consist of inert material are retained until eventually removed during the cleaning process, while those capable of chemical or biological degradation are converted into simpler forms that are either carried away in solution or remain, with the inert material, for subsequent removal.

A number of complex forces contribute to each of these stages, which, for convenience, will be referred to as transport, attachment, and purification mechanisms respectively. It should be emphasized that although these forces will be described separately the division between them under actual working conditions is by no means clear cut. Indeed, there is still a need for considerable research before the interaction of all these processes is fully understood.

Transport mechanisms

The principal processes by which particles are brought into contact with the sand grains consist of (a) straining or screening, (b) sedimentation, (c) inertial and centrifugal forces, (d) diffusion, (e) mass attraction, and (f) electrostatic and electrokinetic attraction.

Screening. This is the most obvious process for the interception and retention of particles too large to pass through the interstices between the grains of sand. It takes place almost entirely at the surface of the filter, and is independent of the filtration rate.

As will be seen from Fig. 3, the pores within a tightly packed bed of spherical sand grains of uniform size are sufficiently small to prevent the passage of particles one-seventh of the diameter of the sand grains. Thus with a grain size of 150 μm (the normal minimum effective size for media

FIG. 3. RELATION BETWEEN GRAIN SIZE AND PORE SIZE

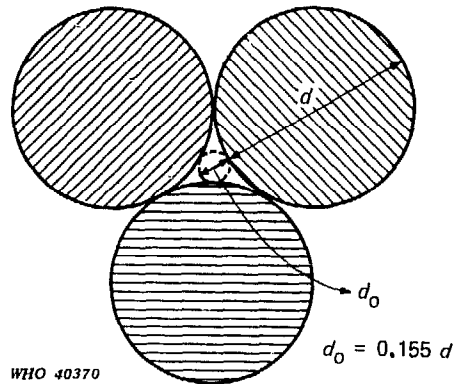

of this nature), the smallest pores are a little over $20\ \mu\text{m}$ in diameter and are unable to intercept colloidal particles (diameters of $1\ \mu\text{m}$ or less) or bacteria (lengths up to $15\ \mu\text{m}$).

Through the twisting movement of flow through the sand-bed, small particles within the water are brought into contact with each other and some aggregation takes place. When the agglomerated particles become large enough to be retained by the screening mechanism they will be deposited.

As the *schmutzdecke*, or filter skin, forms with the ripening of the filter, it contributes to the screening efficiency of the bed, which is further enhanced in time by deposits on the grains of sand that gradually constrict the pore openings. The sum effect is an improvement in the straining effectiveness of a filter with length of use, but this effectiveness is accompanied by an increased resistance to the downward passage of the water which indicates the need for cleaning of the bed.

Sedimentation. The settling action within pores, whereby particulate suspended matter is precipitated onto the grains, is comparable to that in a conventional settling tank, but in a tank the deposits form only on the bottom, whereas in a filter the total upward-facing surface area of all the grains is theoretically available.

One cubic metre of filter sand with a porosity p and a grain diameter d has a gross surface area of $(6/d)(1-p)$ square metres.¹ Thus, in $1\ \text{m}^3$ of sand having a porosity of 38% and an average diameter of $0.25\ \text{mm}$, the gross surface area of the grains amounts to $15\ 000\ \text{m}^2$. Even after making full allowance for the surfaces not facing upward, in contact with other grains, or exposed to scour, the area of deposition below each square metre of filter surface will easily reach the value of $1000\ \text{m}^2$.

Treating this sum of grain surfaces as though it were a single connected sedimentation area, the surface loading, i.e. the quantity of water treated divided by the area of deposition, will be extremely small; with a filtration rate of $0.2\ \text{m/h}$ it will have a value of $0.2 \times 10^{-3}\ \text{m/h}$.

The sedimentation efficiency is a function of the ratio between the surface loading and the settling velocity of the suspended particles. When the latter is equal to or greater than the former, complete removal by settlement may be expected.

¹ Ratio of area to volume of each grain is $\pi d^2/(\pi d^3/6)$, so that the total area of the grains = $6/d \times$ total volume of grains. In $1\ \text{m}^3$ the volume of the grains = $1-p$. Thus total area = $(6/d)(1-p)$ square metres.

According to Stokes, the settling velocity u for laminar settlement is given by the formula:

$$u = \frac{1}{18} \cdot \frac{g \cdot \Delta\rho}{\nu \cdot \rho} \cdot d_p^2$$

where d_p = particle diameter
 ρ = density of water
 $\rho + \Delta\rho$ = density of suspended matter
 g = acceleration due to gravity (9.81 m/s²)
 ν = kinematic viscosity of the fluid.

For water at 10°C, $\nu = 1.31 \times 10^{-6}$ m²/s, and the equation becomes:

$$u = 1.5 \times 10^{-3} \times \frac{\Delta\rho}{\rho} \cdot d_p^2 \text{ m/h.}$$

Suspended matter of organic origin has a density only slightly greater than that of water, and the ratio $\Delta\rho/\rho$ is usually smaller than 0.01. Hence in the example quoted, complete removal of organic particles by sedimentation may be expected when

$$1.5 \times 10^{-3} \times 0.01 \times d_p^2 \geq 0.2 \times 10^{-3}$$

or $d_p \geq 4 \mu\text{m}$

FIG. 4. TRANSPORT OF DISCRETE PARTICLE IN WATER

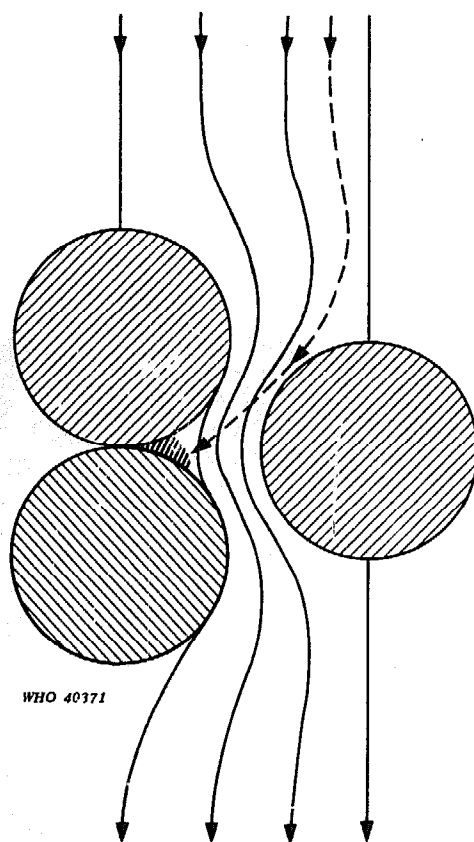

The diagram shows how inertial and centrifugal forces cause the particle to move out of the flow line and deposit in crevices between grains.

Smaller and lighter particles may be partially removed, and flocculation will slightly increase sedimentation efficiency as the water penetrates deeper into the bed. Colloidal matter, with particle diameters of 1 μm or less, will not be removed by sedimentation.

Inertial and centrifugal forces. Fig. 4 shows how inertial and centrifugal forces act upon particles with a specific gravity higher than that of the surrounding water, causing them to leave the flow lines and come in contact with the sand grains.

Diffusion (Brownian movement). Diffusion, which brings suspended particles into contact with containing surfaces, acts independently of the filtration rate throughout the whole depth of the filter, even when the water is not flowing,

although its effects are minor compared with those previously described.

Mass attraction (Van der Waals force). This force operates universally, and contributes to both the transport and the attachment mechanisms.

According to the example given in the section on sedimentation, in 1 m^3 of filter sand, having a gross surface area of $15\,000 \text{ m}^2$ and 0.38 m^3 of water in the interstices (38% porosity), the average thickness of the film of water surrounding individual sand grains will be in the region of $25 \mu\text{m}$. Small though this thickness may seem to be, it is still far too great for mass attraction to play a significant role in drawing colloidal and molecular impurities to the grain surfaces, since the Van der Waals force is a weak one even at molecular distances and it decreases with the sixth power of the distance. The force does, however, supplement inertial and centrifugal forces when the latter have brought particles into very close proximity to a grain surface.

Electrostatic and electrokinetic attractive forces (Coulomb forces). These are described in some detail in the section on attachment mechanisms. While their principal effect is to hold particles that have been brought into contact with sand grains, they do also contribute to the total transport mechanism before such contact is made.

Attachment mechanisms

The main forces that hold particles in place once they have made contact with the sand grain surfaces are (a) electrostatic attraction, (b) Van der Waals force, and (c) adherence. A combination of these forces is frequently referred to under the general heading of adsorption.

Electrostatic attraction. The attraction between opposite electrical charges is inversely proportional to the square of the distance between them. Like the Van der Waals force, it may supplement other transport mechanisms when these have brought a particle into the near vicinity of a sand grain having an opposite electrical charge. A sand grain having a similar charge will, of course, repel the particle, which will continue on its course until it encounters a grain of opposite charge.

Owing to the nature of its crystalline structure clean quartz sand has a negative charge and is thus able to attract positively charged particles of colloidal matter (such as crystals of carbonates, and flocculi of iron and aluminium hydroxide) as well as cations of iron, manganese, aluminium, and other metals. Colloidal particles of organic origin, including bacteria, usually have a negative charge and are consequently repelled; this is one of the reasons why such impurities are not removed when a filter with clean sand is first taken into service. However, during the initial ripening process positively charged particles may accumulate on some of the filter grains to such an extent that oversaturation occurs with a consequent reversal of

charge, rendering the grain and its attached particles positive. Adsorption on such grains is then able to remove negatively charged impurities, including colloidal matter of animal or vegetable origin and anions such as nitrate and phosphate radicals, until oversaturation again leads to charge reversal. This continuing reversal of charge, once started, continues throughout the life of the filter-bed. A further factor contributing to this phenomenon is the dragging away by flowing water of weakly adsorbed ions from the crystal lattice of the sand.

Although clean sand, obtained by the breaking of solid rock, carries a negative charge, a natural sand has always picked up some positive charges from the groundwater flowing through it, and consequently such sand needs less time for ripening to bring it into optimum filtering condition.

Van der Waals force. Mass attraction, which has only a very minor effect in drawing particles from the water, is considerably more effective in holding them to surfaces once contact has been made, since the distance between centres of masses is then very much smaller.

Adhesion. During the ripening period, particles of organic origin will be arrested or deposited on the filter surface and on the individual grains in the upper part of the bed. These deposits quickly become the breeding ground of bacteria and other microorganisms, which produce a slimy material known as zoogloea, which consists of active bacteria, their wastes and dead cells, and partly assimilated organic materials. The zoogloea forms a sticky gelatinous film on the surfaces of the *schmutzdecke* and sand grains, to which particles from the raw water tend to adhere when they are brought into contact by one of the transport mechanisms described earlier. Those particles consisting of organic matter are assimilated to become in due time part of the zoogloea film, while inert matter is held until eventually removed by sand-bed cleaning operations.

Purification mechanisms

The various purification processes, whereby the trapped impurities on and within the filter-bed are broken down and rendered innocuous, are interdependent and are therefore better described in combination than separately. The two principal agencies contributing to the overall effect are chemical and microbiological oxidation, but other biological processes involving various forms of animal and vegetable life may play a significant part.

Within the *schmutzdecke* and zoogloea film, bacteria derived initially from the raw water multiply selectively, the deposited organic matter being used as food. The bacteria oxidize part of the food to provide the energy they need for their metabolism (dissimilation), and they convert part of it into cell material for their growth (assimilation). Thus dead organic

substances are converted into living matter. The dissimilation products are carried away by the water, to be used again at greater depth by other organisms.

The bacterial population is limited by the amount of organic material supplied by the inflowing raw water; the growth (assimilation) is therefore accompanied by an equivalent dying off. This in its turn liberates organic matter, which becomes available to bacteria at lower depths. In this way the whole of the degradable organic matter present in the raw water is gradually broken down and converted into water, carbon dioxide, and relatively innocuous inorganic salts such as sulfates, nitrates, and phosphates (mineralization) to be discharged in the filter effluent.

The bacterial activity described is most pronounced in the upper part of the filter-bed and gradually decreases with depth as food becomes scarcer. When a filter is cleaned by scraping off the top layer, the bacteria in the layer are also removed, and a further ripening period is necessary to bring the population up to the required strength. Below a depth of 30–40 cm (depending on the filtration rate) bacterial activity is small, but biochemical reactions take place converting such microbiological degradation products as amino acids into ammonia, nitrites, and nitrates (nitrification).

Different types of bacteria are normally found at various depths below the filter surface, the true water bacteria predominating at deeper levels. According to Schmidt,¹ this points to a subdivision of the filter-bed into zones, in each of which specific bacteria abound, each producing well defined effects.

Sudden changes in filtration rate tend to upset this equilibrium, resulting in deterioration of effluent quality, for which reason it is most desirable to design the plant to operate continuously without interruption and at as constant a filtration rate as possible. In a similar way the various bacterial populations are adapted to the type and amount of food supplied by the passing water, and sudden fluctuations in raw water quality should be avoided. If necessary, a raw water storage reservoir of sufficient capacity to smooth out such fluctuations could be provided.

For satisfactory biochemical oxidation of organic matter, sufficient time must be allowed, enough oxygen must be available, and the temperature of the water must not be allowed to fall too low. Adequate time is ensured by keeping the filtration rate down, thus maintaining a sufficient contact time within the bed. The oxygen content is important; if it falls to zero during filtration anaerobic decomposition occurs, with consequent production of hydrogen sulfide, ammonia, and other taste- and odour-producing substances together with dissolved iron and

¹ Schmidt, K. (1963) *Die Abbauleistung der Bakterienflora bei der Langsandsandfiltration und ihre Beeinflussung durch die Rohwasserqualität und andere Umwelteinflüsse* [The decomposition of bacterial flora in slow sand filtration and the influence thereon of raw water quality and other environmental factors], Dortmund, Hydrological Research Department of the Dortmunder Stadtwerke AG.

manganese, which make the treated water unsuitable for washing clothes and other purposes. Thus the average oxygen content of the filtered water should not be allowed to fall below 3 mg/l if anaerobic conditions are to be avoided throughout the whole area of the filter-bed. This requirement may call for aeration of the raw water to increase its oxygen content or pretreatment to lower its oxygen demand.

The efficiency of slow sand filtration may also be seriously reduced by low temperatures, owing to the influence of temperature both on the speed at which chemical reactions take place and on the rate of metabolism of bacteria and other microorganisms. This is illustrated by the effect of temperature on the reduction in permanganate consumption brought about by slow filtration. According to Van de Vloed,¹ if T is the temperature in degrees Celsius, the reduction in permanganate consumption in milligrams per litre is equal to $(T+11)/9$. Thus at 25°C permanganate consumption is reduced by 4 mg/l, while at 7°C it is reduced by only 2 mg/l.

Below 6°C the oxidation of ammonia practically comes to a standstill. When air temperatures drop below 2°C for any considerable period it is necessary either to cover the filters to reduce heat losses or to provide for subsequent chlorination as a precaution against incomplete purification in the filtration plant.

The bacteria—including *E. coli* and possibly pathogens—contained in the raw water are carried to the filter grain surfaces by the mechanisms already described. Conditions within the filter are unsuitable for the multiplication of intestinal bacteria. They do not thrive at temperatures below 30°C, and the filter-bed does not usually contain enough organic matter of animal origin to meet their nutritional needs. Added to this, many types of predatory organisms (such as protozoa and lower metazoa) abound in the upper part of the bed, while at lower depths suitable food becomes even scarcer so that they starve—particularly at higher temperatures when their metabolic rate increases. Although relatively few quantitative data are available, it is known that the microorganisms in a slow sand filter produce various substances that act as chemical or biological poisons to intestinal bacteria. The overall result is a substantial reduction in the number of *E. coli*, and an even greater proportional decrease in pathogens. This effect becomes greater as the flora and fauna of the filter develop in the presence of adequate food, oxygen, and suitable temperatures.

At low temperatures, the activity of bacteria-consuming protozoa and nematodes drops sharply,² and at the same time the metabolism of the intestinal bacteria themselves slows down, increasing the chance of survival of those that are carried through the bed. The factor by which the numbers of *E. coli* are reduced, which is normally in the range

¹ Van de Vloed, A. (1956) *Comparison between slow sand and rapid filters*. In: *International Water Supply Association, Third Congress, London, 1955*, London, International Water Supply Association, p. 537.

² Burman, N. P. (1962) *Effl. Wat. Treat. J.*, **2**, 674.

100–1000, may fall as low as 2 at temperatures of 2°C or less,¹ and chlorination is then essential if the quality of the delivered water is to be maintained.

Effects of algae on filters

Although they do not, strictly speaking, take part in the mechanism of filtration, certain types of algae can have significant effects on the working of a biological filter. These effects may be beneficial or harmful, depending on a variety of conditions.

Practically all surface waters contain algae, their presence contributing to the natural regenerative processes in streams, rivers, and lakes. According to the nature of the water source, its pH, temperature, chemical composition and turbidity, the concentration of nutrients it carries, its depth and velocity of flow, the amount of sunlight it receives, and other factors, different species will predominate. The algae found in a section of a shallow fast-flowing stream, for instance, may not be the same as those prevalent in a deep pool or reservoir fed by that stream. For the same reason the algae predominating in the supernatant water of a filter may markedly differ from those in the raw water source from which it is drawn. Both groups, however, will have an influence on the efficiency of subsequent filtration, the algae in the raw water affecting the dissolved oxygen content at the point of entry to the supernatant reservoir, and the algae in the supernatant water itself producing a number of changes in the chemical quality of the water within the reservoir during the waiting period before it passes downwards into the sand-bed.

As autotrophic organisms, algae need light for their photosynthetic processes and are therefore likely to be almost entirely inactive in the supernatant water when the filter structures are covered. Even in uncovered filter reservoirs their growth may be markedly reduced if the raw water is sufficiently turbid to cut off the essential sunlight.

The property of algae most significant to the water purification process is the ability to build up cell material from simple minerals such as water, carbon dioxide, nitrates, and phosphates. The carbon cycle may be described by the relationship:

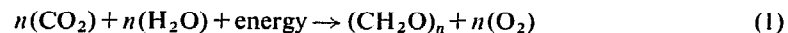

The energy they require for their metabolism is derived from the oxidation of organic matter. The reverse reaction also occurs when algae die and their

¹ Burman, N.P. (1963) *J. Instn Wat. Engrs*, 17, 551.

cell material is liberated to be consumed by the bacteria of the filter-bed:

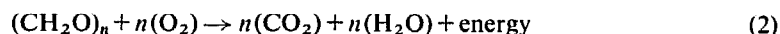

The relative magnitude of these two reactions governs the growth, constancy, and decline of the algal population.

As long as algae are in an active state of growth (in spring and summer in temperate climates and longer in tropical areas) reaction (1) predominates, increasing the oxygen and decreasing the carbon dioxide content. The rise in oxygen content, sometimes to as much as three times the theoretical saturation level, is always an advantage, but the lowering of the carbon dioxide content may cause bicarbonates to dissociate into carbonates and carbon dioxide:



The lowering of the bicarbonate content will decrease the temporary hardness, and the insoluble carbonates will precipitate, thus contributing to the clogging of the filter. As the growth of algae continues and their volume increases, the downward movement of the water is hindered, necessitating the periodic removal of the algae from the filter surface.

When the algae are in a steady state, equations (1) and (2) will balance each other. The process described by equation (1), however, requires sunlight, while the degradation of organic matter according to equation (2) continues at all times. The overall effect is thus an increase in oxygen content during daylight hours and a corresponding decrease at night. The diurnal variation may be considerable, and in severe cases anaerobic conditions may occur during the dark hours, with the unpleasant consequences already mentioned in the previous section.¹

In northern climates the temperature of the water will fall during autumn, causing algae to die away as their living conditions become less favourable. This results in the liberation of organic matter, the consumption of oxygen, and the production of carbon dioxide, so increasing the possibility that anaerobic conditions will occur, while the higher carbon dioxide content will lower the pH value of the water. Even when the oxygen content of the effluent remains satisfactory, part of the filter may be covered with patches of dead algae, below which reduction occurs, producing etheric oils of abhorrent taste.

If the temperature drops suddenly, or if conditions become unfavourable in some other way (for instance, through the appearance in the raw water of industrial pollutants of an algicidal nature), a massive mortality of algae may ensue. So much degradable organic matter is thereby liberated that

¹ Taylor, E.W. (1961-62) *Fortieth report on the results of the bacteriological, chemical and biological examination of the London waters*, London, Metropolitan Water Board, p. 58.

decay sets in, and the filter must be taken out of service for cleaning. As the conditions will probably affect more than one filter simultaneously, serious difficulties in maintaining both the quantity and the purity of the supply may well result.

Clearly, unless their numbers are controlled by periodic harvesting, algae in the supernatant water may give rise to serious operational problems that demand constant supervision.¹ In temperate and cold climates where, in addition to the foregoing hazards there is the possibility of freezing in winter, the filters are often covered in order to exclude the sunlight and inhibit the growth of algae. It must not, however, be thought that the actions of algae are entirely adverse; their presence may have beneficial effects that more than compensate for the disadvantages, especially in warm climates.

Algae use organic matter from the raw water to build up cell material, and although when they die an equivalent amount of organic material is liberated, the new material is more easily degradable than the old. There is little difference between a closed and an open filter in the average oxygen content of the effluent. But the oxygen consumption of the open filter is about 10 times that of the covered (15 mg/l compared with 1.5 mg/l). This is due not only to the carbon cycle shown in equations (1) and (2) above, but also to the conversion of unassailable into degradable organic material. The greater oxidative activity means that the chances of harmful organic substances (both living and dead) being destroyed are correspondingly increased.

Further beneficial effects of algal growth may be found in the contribution that filamentous species make to the formation of an active *schmutzdecke*, the zoogeleal content of which forms a medium for the trapping and proliferation of plankton, diatoms, and other forms of life, thus enhancing straining and adsorption. Less suspended matter reaches the filter medium when the *schmutzdecke* is well established, and this helps to lengthen the interval between successive filter cleanings. In addition, a favourable environment is provided for protozoa and other higher organisms, which feed on bacteria and materially reduce the number of *E. coli* and pathogens that reach the sand bed. The algae themselves, according to some investigations, produce substances harmful to bacteria, thus reducing their chances of survival.

The species of predominating algae is here important. When they are mainly filamentous a zoogeleal mat is formed with closely interwoven fibres that give it considerable tensile strength. When, under the influence of strong sunlight, bubbles of pure oxygen are produced within and upon this mat, its buoyancy is increased and it may be lifted together with adhering grains

¹ Brix, J., Heyd, H. & Gerlach, E. (1963) *Die Wasserversorgung* [Water supplies], Munich, Oldenbourg p. 333.

from the upper surface of the filter-bed. This reduces the filter resistance and the rate of flow correspondingly increases, sometimes very rapidly. On the other hand, when small algae such as diatoms predominate, the matting is poorly formed and the resistance of the filter skin is increased. Blooms of such algae can cause a very rapid clogging of the filter bed, resulting in shortened filter runs, operational problems, and a lower effluent quality.

The whole question of the proliferation of algae and of the species that will predominate is bound up with the composition of the raw water and with climatic and other conditions. Sufficient light, nutrients, and suitable temperatures encourage growth; a clear water of low turbidity containing such mineral constituents as carbon dioxide, nitrates, and phosphates provides a particularly favourable environment for them. Experience shows that water is likely to be poorer in phosphates than in other constituents, either because the source of water has a low initial content of phosphorus salts or because these salts have been precipitated in combination with iron, whether naturally occurring or the result of human activity.

The presence of heavy algal growths always carries the potential risk that the filter will have to be cleaned too frequently, so that it will be out of service for too great a proportion of time and perhaps require a larger labour force than would otherwise be necessary. In temperate climates this risk is accentuated during seasons of rising temperatures, which may cause extensive and sudden algal blooms, and in periods of falling temperatures, when massive mortality may occur. In tropical climates other meteorological or seasonal changes may bring about similar phenomena.

Covering the filters helps to solve this problem; longer and more regular filter runs result, and cleaning may be carried out by day or night and during periods of frost or other inclement weather. The absence of algae in the raw-water reservoir of a covered filter may lead to a somewhat reduced filter efficiency, particularly with respect to the reduction of intestinal bacteria, but a compensating benefit may accrue from the exclusion of windborne contamination or bird droppings. An increase in the rate of chlorination will ensure the hygienic quality of the delivered water. Covering the slow sand filters at one of the treatment plants of the Amsterdam municipal waterworks allowed the average filtration rate under all weather conditions to be raised from 0.1 to 0.3 m/h, while the length of filter runs increased slightly and became decidedly more regular.

Under tropical conditions in which the periods of blooming and dying of algae are less pronounced and ice formation does not occur, filter cleaning normally becomes necessary only at regular and not-too-frequent intervals, and there is little justification in covering filters. With each filter cleaning, all algal material is removed—both dead and living. New algal material is brought in by the raw water, and the reaction according to equation (1) predominates, so causing an increase in the oxygen content, which in turn allows more organic matter to be degraded. At the same

time the carbon dioxide content decreases, rendering the water less corrosive, and the concentration of nutrient salts and organic material is reduced, lessening the load on the filtration processes. The straining and purifying effects of the *schmutzdecke* in open filters will contribute to the overall efficiency by maintaining the hygienic quality of the effluent, decreasing filter clogging, and prolonging filter runs.

So many variables govern the predominating species and the rate of growth of algae in different raw waters that it is virtually impossible to make firm predictions, except on the basis of previous experience with the particular water concerned. Unless this experience is available (e.g., from existing filters operating under similar conditions) it is usually worth while to experiment on a pilot plant scale before undertaking the design of large installations. Studies should continue over a full year so that all seasonal and climatic changes may be taken into consideration.

Hydraulics of filtration

In slow sand filtration the rate of downward movement of the water is kept so small that laminar flow conditions may be assumed to prevail throughout the bed. The resistance H offered by a clean filter-bed is therefore in accordance with Darcy's law:

$$H = \frac{v_f}{k} \cdot h$$

where h is the thickness of the bed, k the coefficient of permeability, and v_f the filtration rate (the volume passing per hour divided by the surface area of the bed).

The coefficient k has the dimensions of velocity, and may be expressed in metres per hour. Its value is best determined in a laboratory by actual measurement of the resistance of a representative sample of the filtering medium concerned, but it may also be estimated theoretically by using one of the many formulae available, for example:

$$k = 150(0.72 + 0.028 T) \frac{p^3}{(1-p)^2} \phi^2 d_s^2 \text{ m/h}$$

in which T = temperature in degrees Celsius
 p = porosity (ratio of volume of pores to total volume of filter medium)
 ϕ = shape factor (sometimes referred to as sphericity)
 d_s = specific diameter of sand grains in millimetres.

The shape factor ϕ is the ratio of the surface area of a sphere to the surface area of an average grain of the material having the same volume; consequently it cannot have a value greater than unity and the less spherical the grains the smaller it will be. The shape factor for various kinds

of sand grains is as follows:

	spherical	nearly spherical	rounded	worn	angular	broken
ϕ	1.00	0.95	0.9	0.85	0.75	0.65

The specific diameter d_s is a means of describing the grain size of an ungraded natural sand, taking into account the variation in size of the individual grains. It is defined as the size of an imaginary grain from a uniform sand of which a certain weight has the same gross surface area as an equal weight of the filtering medium under consideration.

It is possible to calculate the specific diameter in the following way. A sample of weight W of the material is separated through a series of sieves into fractions of weights $W_1, W_2 \dots W_n$ having limiting diameters d_1 and d_2, d_2 and $d_3, \dots d_n$ and d_{n+1} . The value of d_s can then be calculated from the relationship

$$\frac{1}{d_s} = \frac{W_1/W}{\sqrt{d_1 d_2}} + \frac{W_2/W}{\sqrt{d_2 d_3}} \dots + \frac{W_n/W}{\sqrt{d_n d_{n+1}}}$$

The use of calculations involving specific diameter is normally restricted to rapid filtration, where the grading of the sand must be more accurately

FIG. 5. SIEVE ANALYSIS

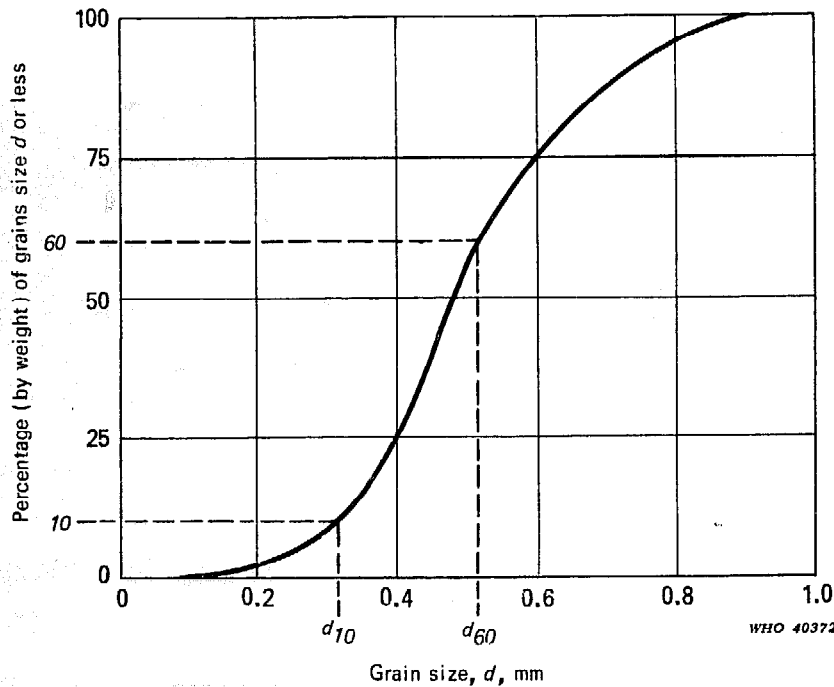

controlled than is necessary with slow filtration. In the latter case, the sand is usually characterized by its effective diameter and its coefficient of uniformity. The concept of effective diameter was introduced by A. Hazen as long ago as 1892; it is defined as the size of the sieve opening through which 10% of the material will just pass (Fig. 5) and is therefore given the symbol d_{10} . In a similar way, the sieve opening through which 60% of the material will pass is shown as d_{60} .

The coefficient of uniformity U is the ratio d_{60}/d_{10} . Natural sands often have a size/frequency distribution that yields a more or less straight line when plotted on logarithmic probability paper (Fig. 6). When this geometric normality is strictly true the ratio ψ between the specific diameter and the effective diameter (d_s/d_{10}) may easily be calculated from the following

FIG. 6. SIZE/FREQUENCY DISTRIBUTION OF GRAINS IN A SAND MEDIUM

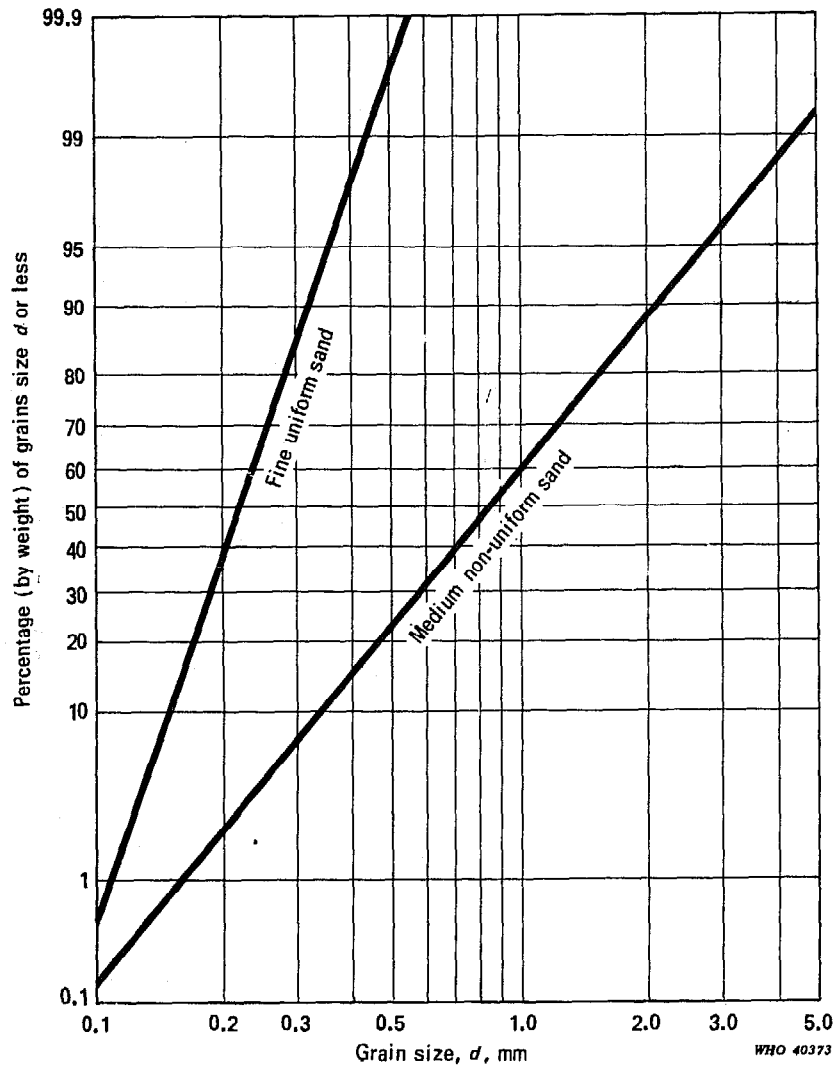

formula, with fair accuracy when U is reasonably small (e.g., between 1.0 and 2.0):

$$d_s = d_{10}(1 + 2 \log U) = \psi d_{10}.$$

When the sand is less uniform, ψ may be obtained from the following table:

U	1.0	2.0	3.0	4.0	5.0
ψ	1.00	1.60	1.93	2.11	2.21

It should also be noted that a sieve with a mesh width s will pass grains up to a volumetric diameter d , which may be larger or smaller than s depending on the shape of the sieve opening. For filtering sand it is usual to use square-woven wire screens with a ratio between d and s varying between about 1.05 (rounded grains) and 1.2 (elongated). For ellipsoidal grains, such as are commonly met with in filter sands, a constant ratio of 1.10 is usually assumed, thus:

$$d = 1.10 s.$$

By substitution of this relationship and of the ratio between specific and effective diameter, the formula for calculating the coefficient of permeability becomes:

$$\begin{aligned} k &= 150(0.72 + 0.028 T) \frac{p^3}{(1-p)^2} \phi^2 \psi^2 (1.10 s_{10})^2 \\ &= 180(0.72 + 0.028 T) \frac{p^3}{(1-p)^2} \phi^2 \psi^2 s_{10}^2 \end{aligned}$$

in which s_{10} is the clear opening of an imaginary square-woven wire screen that would pass 10% of the filtration material. Values of ϕ and ψ are tabulated above.

Assuming a sand with nearly spherical grains ($\phi^2 = 0.9$) and a coefficient of uniformity a little less than 2.0 ($\psi^2 = 2.5$), a temperature of 10°C , and a porosity of 0.38, the formula above gives, for effective sizes s_{10} of 0.15 mm and 0.35 mm, coefficients of permeability of about 1.1 m/h and 6.0 m/h respectively. The latter value is so large that even with thick beds (1.2 m) and high filtration rates (0.5 m/h) the initial resistance is equivalent to a loss of head of less than 0.1 m. On the other hand the smaller sand with a permeability of 1.1 m/h produces an initial resistance of over 0.5 m with the same bed thickness and filtration rate. In order to keep the resistance down to 0.1 m or less, the bed thickness must be limited to 0.5 m and the filtration rate must be restricted to about 0.2 m/h by adjustment of the outflow valve of the filter.

With fine-grained filtering materials, therefore, the thickness of the filter-bed should be kept as small as the desired effluent quality will permit and (unless the raw water is of exceptional clearness) high rates of flow should be avoided.

When, during filtration, the impurities from the raw water deposited in and upon the surface layer of the sand-bed begin to reduce the pore space available, resistance will increase. The time taken for this to occur depends on the amount of suspended matter carried by the raw water, the rate of filtration, and the size of the sand grains (and hence of the pores) in the bed. The rate of increase in resistance cannot be readily calculated, and must be found by experimenting with the particular water, filter medium, and climatic conditions that will be met with under actual working conditions.

Generally speaking, during the early stages of ripening, the overall resistance will build up slowly from the initial (theoretical) value of a clean sand-bed, but at a later phase of the filter run it will increase very sharply. The permissible resistance (which opposes the head of water above the filter-bed) should not exceed 1–1.5 m in normal design. In exceptional conditions it may be allowed to reach a maximum of about 2 m, but it is unlikely that filter runs will be appreciably lengthened in this way.

As the impurities from the raw water are deposited almost entirely in and on the *schmutzdecke* and the extreme top layer of the bed, the resistance will increase only in this surface zone. This phenomenon has a marked influence on the pressure distribution through the bed. Without water movement, pressure increases hydrostatically with depth; under conditions of flow, however, the pressure at any given depth is lowered. In a clean filter there is a gradual decrease in hydrostatic pressure from the top of the bed to the bottom, where the total decrease is equal to the initial loss of head H_0 . The clogging resulting from filtration lowers the pressure still further, but as the increase in resistance takes place at the surface the lowering effect is felt only immediately below the filter-skin.

The need for a weir (Fig. 1) may now be fully appreciated since this simple device ensures that the pressure below the filter-skin can never fall below a certain minimum. In the absence of a weir, and if the filtration continued for a long time, the pressure immediately below the filter-skin could become negative—i.e., the filtered water could drain away from the supernatant water, leaving a partial vacuum. This could seriously interfere with the reliable working of the filter, because abundant algal growth can cause the supernatant water to become supersaturated with oxygen, which would be released in the low-pressure region below the filter-skin to form bubbles in the pores—a condition known as “air binding”. If this occurred over a part of the filter the loss in capacity might pass unnoticed, but the remaining part would become overloaded, and the effluent quality would deteriorate. Even worse would be the situation in which air binding

occurred over a large area, causing a marked fall in filtration rate and a consequent rise in hydrostatic pressure, which might rupture the filter-skin and lead to a dangerous deterioration in the public water supply.

Negative pressures must therefore be prevented by all possible means, and the maximum allowable resistance H_{\max} has to be restricted to the combined values of the depth of water on top of the filter and the (minimum) initial resistance H_0 of the clean bed. The simplest and surest way of achieving this is to pass the effluent over a weir, making it physically impossible for the filtered water level to drop below the top of the sand-bed.

Effects of filtration on delivered water quality

The ultimate aim of the designer of a sand filter must be the maintenance of a high standard of quality of the delivered water. At the same time he must try to economize on running costs by ensuring that the intervals between successive cleanings are as long as possible. Generally speaking both these aims depend on four factors:

- (1) the quality of the raw water,
- (2) the climatic conditions (particularly temperature),
- (3) the filtration rate,
- (4) the composition of the filter medium.

The first two of these conditions must be accepted as they exist; the filtration rate and the filter-bed composition are matters of choice. To a great extent, the finer the grains of the filter medium the better will be the quality of the effluent. Straining is more efficient with smaller pore openings, while sedimentation and adsorption are improved with the increased gross surface area of the medium. At the same time a larger habitat is offered to the microorganisms responsible for the biochemical degradation of organic matter, and the resulting decrease in the concentration of nutrients available to the bacteria in the bed causes them to die off more rapidly, with a consequent improvement in effluent quality.

A greater combined surface area of the grains also promotes a more intimate contact between the constituents of the raw water, thus speeding up chemical reactions (surface catalysis). The surface area could equally well be increased by increasing the depth of the filter-bed but, when it is noted that a depth of 0.6 m of sand comprising grains of 0.15 mm diameter presents the same surface area as a depth of 1.4 m of sand of 0.35 mm grains, it is obvious that the application of finer sand is economically a better method.

Straining efficiency is independent of flow rate, and it has been shown earlier that sedimentation removes only a fraction of the particles—namely,

in the example given, only those particles with diameters in the range 4–20 μm —so that a decrease in sedimentation efficiency accompanying a higher filtration rate is likely to have little influence on the turbidity of the final effluent. The forces contributing to the adsorption mechanism are affected by the velocity of flow only to a minor extent.

On the other hand biological activity is very time-dependent (especially at low temperatures) and higher filtration rates will lower the contact period between the water and the purifying microorganisms. These microorganisms are normally present only in the upper 30–40 cm of the bed, but as the rate of filtration is increased the food supply to the bacteria is carried deeper into the medium. Under these circumstances they adapt themselves to living at greater depths, but only to a limited extent. If the velocity of flow becomes too high a breakthrough of organic matter into the effluent occurs.

At the other extreme, in open filters with abundant algal growth, very low filtration rates (say, a few centimetres per hour) may result in the discharge of certain by-products of the metabolism of the algae, which may cause unpleasant tastes and odours in the delivered water.

Summing up, it is clear that effluent quality depends largely on the grain size of the filtering medium but not (except within defined limits) on filtration rate. At the waterworks at Amsterdam three covered filters have been operated for a full year at different constant rates of 0.1, 0.25, and 0.45 m/h without any marked difference in effluent quality being detectable. Rechenberg¹ on the other hand has shown the following relationship between the permanganate consumption of influent c_i and that of effluent c_e in a slow sand filter with a filtration rate v_f :

$$\frac{c_e}{c_i} = 0.8 v_f^{1/6}.$$

Doubling the filtration rate would thus increase the permanganate consumption of the delivered water by 12%—a small but still distinct difference.

There are no mathematical formulae that permit the intervals between successive cleanings to be calculated, but it is clear that the runs will be shorter with higher filtration rates and with finer grained media. Where filters are cleaned manually, short filter runs (during periods of algal blooms, for instance) will impose heavy burdens on the cleaning labour force, may endanger the continuity of supply, and may also lower the quality of effluent because of reduced filtration efficiency immediately after cleaning. Consequently filters should be designed and operated in such a way that under the worst conditions of raw water quality the length of filter runs will not drop below 2 weeks. It may then be expected that under average running conditions the interval between cleanings will be several months.

¹ Rechenberg, W. (1965) *Versuche zur Verbesserung der Qualität von künstlich angereichertem Grundwasser durch Verwendung von Vorfiltern* [Attempts to improve the quality of artificially recharged ground water by prefiltration], Dortmund, Hydrological Research Department of the Dortmunder Stadtwerke AG.

The only satisfactory way of assessing the length of filter runs is to carry out experiments, either in a laboratory or (preferably) on a pilot plant, filtering the actual raw water to be treated through media of differing grain sizes. The filtering material should be sufficiently fine to satisfy the quality requirements of the effluent and the filtration rate should then be established. It should be low enough to ensure a minimum length of filter run of at least 2 weeks under the most unfavourable conditions.

Filter sand should not normally be finer than necessary, otherwise the filter runs will be unduly short. If an additional margin of safety is required, it may be obtained by increasing the bed thickness rather than by reducing the grain size.

According to these criteria, however, very clear raw water would call for a coarse-grained sand, which would be deeply penetrated by the clogging material, and surface scraping would be ineffective as a cleaning procedure. In such cases the use of a finer-grained medium than is strictly necessary may well be warranted.

Turbid waters are likely to call for very low filtration rates if the filter runs are to be kept reasonably long, and the designer will have to consider the alternative of pretreatment for the removal of at least part of this turbidity. Costs of construction and operation will obviously vary from country to country, but in general it has been found that pretreatment (by sedimentation or rapid filtration, for example) can become financially attractive if it allows a slow sand filtration rate of 0.1 m/h to be increased by about 20%, or a rate of 0.2 m/h by roughly 60%.

Pretreatment may also be advisable when the raw water quality fluctuates widely and frequently. Although short periods of quality fluctuation may be insufficiently serious to have any marked effect on the length of filter runs, they could lead to deterioration of delivered water quality, which might pass unnoticed if sampling and analysis are not regularly and frequently carried out. Pretreatment, consisting of aeration either alone or in combination with other processes, is likely to be particularly necessary when the oxygen demand of the raw water regularly exceeds its dissolved oxygen content. Unless this condition is corrected, the unpleasant consequences of anaerobic working are almost certain to ensue.

While rapid or "roughing" filters are often used for pretreatment, other processes may be more suitable or more economical depending on the particular raw water conditions. For example, turbidity can be reduced by storage and sedimentation, the latter process being more efficient if coupled with chemical coagulation. Microstrainers are sometimes used with advantage to reduce an excessive concentration of algae, particularly when the water is drawn from an impounding reservoir. The use of screened intakes, consisting of naturally or artificially sand-packed tube wells or infiltration galleries, is a useful and inexpensive way of excluding suspended organic

matter, but such intakes are only practicable when conditions are favourable for their installation.

The microorganisms that operate so effectively within a slow sand filter to break down pathogens and other organic matter of animal origin are less potent when dealing with similar substances of vegetable origin. This is not to say that they are entirely ineffective in this respect, but when dealing with particularly stable compounds such as peat they can remove only part of the colour. Under many circumstances (e.g., in small tropical installations where economical working is a prime consideration) this may be acceptable. Indeed, slow sand filtration is as effective as any other conventional treatment method for colour removal. In more highly industrialized communities where the consumers demand, and are willing to pay for, water of a better aesthetic quality, additional treatment to supplement filtration may be called for. It may take the form of ozonation or a heavy dose of chlorine. In such cases it will usually be safe to increase the filtration rate in view of the bactericidal properties of the chlorine or ozone.

Even where no additional treatment is incorporated and where filtration is the final or only stage of purification, an application of chlorine to the effluent is a wise safety precaution. In this case the dosage is relatively small (usually about 0.5 mg/l and rarely more than 1.0 mg/l) and it must be considered a safety measure only. In other words, the filters must be run so as to produce a safe effluent even if the chlorination plant breaks down, thus providing double protection to the consumer.

The point has been made, but is worth repeating, that microbiological processes and chemical activity both slow down under conditions of low temperature. This is often to some extent compensated for by reduced consumption by the public during cold weather, permitting lower filtration rates, but if prolonged or severe cold conditions are expected filters should be covered to prevent heat losses, and subsequent treatment with chlorine or ozone should be provided.

4. Filter design and construction

The essential parts of a slow sand filter are:

1. the supernatant water reservoir,
2. the filter-bed,
3. the filter bottom and under-drainage system,
4. the filter box, containing (1), (2), and (3) above,
5. the filter control system.

In addition, a filter covering structure may be required in certain circumstances.

Before designing these constituent parts it will be necessary to consider the treatment plant as a whole, to decide on the methods of delivery of the raw water and collection of the treated effluent, to determine whether and to what extent pretreatment is called for, and to select the number and size of the filters required. Consideration should also be given to the likelihood of future extensions being required so that provision for additional filters may be made in the original layout. It should be possible for such extensions to be made without interrupting the working of the original plant. Thus, access for construction plant and materials to future sites should be allowed for, and pipework should be of adequate capacity to deal with future loading and should be provided with suitable T-junctions or blank ends to facilitate the connexion of the new filters when built.

The first decisions will concern the quantity of water to be treated—that is to say, the average quantity per day, the average quantity per hour, and the peak flows.

The average quantity per day that must be provided to a public water supply system comprises:

- (1) the number of consumers multiplied by the average consumption per head,
- (2) water for industrial, commercial, or other special purposes,
- (3) wastage.

These items will be considered in reverse order.

Wastage. This must obviously be kept to a minimum by ensuring that the mains, fittings, service pipes, and other parts of the distribution system

are watertight. However, even with new installations that have been subject to the most careful supervision during construction and to regular servicing afterwards, some wastage inevitably occurs. In older systems, where earth movements and corrosion have affected mains, or where inadequate precautions are taken against dripping taps, leaking washers, or careless use by consumers (in areas where consumption is not metered), wastage may account for an appreciable part of the daily demand. Actual figures for water "unaccounted for" amounting to 25–30% of the total quantity treated are not unknown. Such losses constitute an expensive drain on the financial resources of a water undertaking and an unforeseen load on the treatment plant. The designer will be wise to include an allowance for wastage depending on the complexities of the system and on his own judgement of the quality of care and supervision that will go into the construction and maintenance of the system as a whole.

Special purposes. Where industrial premises are to be served from the public supply it will be necessary to estimate the rate of withdrawal on a daily basis under the worst possible conditions. It is sometimes possible to smooth a fluctuating load by making arrangements with the industrial consumer; for example, a plant working 5 days a week may be required to install a storage tank and take only a specified maximum quantity daily. Commercial consumption may similarly fluctuate. In a small installation, especially, such demands as the washing down of a market should be anticipated if stores of treated water are not to be depleted. In larger communities the various demands may well smooth themselves into a fairly average rate of withdrawal, but they should be assessed in advance and provision made in the capacity of the treatment plant. Allowance should also be made for sudden heavy demands for water such as occur when fire hydrants are used or the streets are cleansed by the municipal authorities.

Domestic use. The demand for domestic water is usually by far the largest demand on a supply authority, and it consequently needs the greatest study to ensure that the treatment works will have an appropriate capacity. Two factors have to be considered—the number of consumers and the daily requirements of each. The first of these should be relatively easy, but allowance must be made for future population growth over the design period, say 7–10 years, since it will usually be a most unpopular move politically if extensions are called for soon after the works are completed. On the other hand, a design that attempts to accommodate an uncertain population increase that continues into the distant future may be economically inexcusable.

The average demand per head of the population is more difficult to forecast unless experience in similar circumstances is available. In a community having piped water for the first time, individual consumption may start slowly, but familiarity with piped water will soon stimulate

demand. In an industrialized society the number of domestic fittings may be expected to increase, and once the supply is shown to be ample and reliable such appliances as washing machines, air conditioning units, and hoses for car washing and garden watering will be connected. In developing countries, street standpipes will give way to individual house connexions, waterborne sewerage may be installed, fittings such as baths and lavatories will proliferate, and mains water will be used for the watering of domestic animals and garden crops.

Hourly consumption. It has been shown in earlier chapters that a slow sand filter is at its most efficient when a constant filtration rate is maintained, i.e., when the daily quantity to be treated is equally divided among the 24 hours. Continuous operation is no problem as far as the filter itself is concerned, but the pumping schedules may call for three-shift working (unless automatic devices such as float- or electrode-operated pumps are installed) and the raw water and treated water reservoirs will have to be adapted to continuous operation. Some additional expenditure may be involved in such items as external lighting for the safety of night shifts.

On the other hand, the hourly quantity to be treated will be correspondingly reduced and the area of the filter-beds will be smaller. Except perhaps for the very smallest installations, the capital cost of a continuously working plant is likely to compare very favourably with one designed for intermittent operation.

It should be made clear that the term "intermittent operation" refers to intermittent filter operation and not to interrupted delivery to consumers. Delivery through the public mains must always be continuous; the importance of this cannot be overstressed. Intermittent supply to consumers can never be justified, because it carries grave health hazards and in the long run saves neither water nor costs. Interrupted supplies to consumers must always be regarded as a serious reflection upon the designers or the operators of a water system.

Peak flows. Peak flows may be of several types daily, weekly, seasonal, or occasional. Daily peaks are inevitable and are accommodated by having an adequate storage capacity of treated water. To a great extent weekly peaks (e.g., the Monday-morning wash-day customary in many communities) may be accommodated in the same way, as may certain occasional peaks such as might arise in an emergency such as a fire or a burst water main.

Seasonal fluctuations are often more difficult to cater for. In most communities maximum demand takes place at the worst time of the year from the waterworks operator's point of view, i.e., in the hottest season when the source water may be at its scarcest. In northern latitudes another seasonal peak may occur during heavy frost, when wastage from burst pipes and fittings and from taps deliberately left dripping to avoid freezing coincides with reduced biological activity in the filters. To some extent such

peak demands may be met by forethought in operation—for instance, by arranging that filter cleaning is carried out in advance of a period of excessive demand so that the full filtration area is available during a seasonal emergency.

Total filter area. After taking all the above factors into account, the designer will be able to determine his first criterion—the hourly quantity of water to be treated, Q . The other key factor is the filtration rate v_f , and the method of arriving at this has been discussed in previous chapters. The total filtration area A must clearly be equal to or greater than Q/v_f . The next step will be to choose the number, shape, and dimensions of the filters to provide this total filtration area.

Filters need periodic cleaning, which, when carried out by hand, should be completed in 1–2 days. However, it is usually necessary to allow a further period for ripening, if the effluent quality is to reach its former standard. To avoid overloading the remaining filters, with consequent clogging and reduced flow rates, at least one additional filter (and in large installations two or more filters) should be provided as a reserve. Thus the number of filters n may be obtained by dividing the total filtration area by the area of each filter S and adding the chosen number of reserve filters. Certain further factors will influence the relationship between the number of filters and the surface area of each.

(1) The weakest part of a filter (from the point of view of effluent quality) is the edge of the filter-bed, where the raw water may leak past the sand if care is not taken in design and operation. In order to minimize this weakness, filters should not be too small. The minimum workable size is usually considered to be 100 m^2 , and filters of twice this area are to be preferred.

(2) Larger units have a lower initial cost per square metre than do smaller units.

(3) Over a certain size the risk of cracks due to subsidence or temperature stresses increases greatly, the dangers depending on such factors as the structure of the subsoil and climatic conditions. A maximum size, which might be between 2000 m^2 and 5000 m^2 , should be decided upon.

(4) No treatment plant for public supply, however small, should have less than two filters, and four is a much more suitable minimum number.

(5) More flexible operation is possible with a larger number of filters, and smaller filters are more easily cleaned, with consequent saving in the number of labourers required.

Only after all these factors have been weighed can the final decision be made, but a useful first approximation can be made from the formula:

$$n = \frac{1}{4} \sqrt{Q}$$

in which n is never less than 2 and Q is expressed in m^3/h .

With regard to the shape and spacing of individual filters, the following considerations have to be borne in mind.

- (1) Easy access to every filter is desirable to facilitate cleaning by hand, particularly when the removal of large quantities of algae may be expected.
- (2) The construction of filters of random size to make the best use of available land may effect initial economies, but if mechanical cleaning is contemplated it will be preferable to make the beds of equal size and rectangular in shape (Fig. 7).

FIG. 7. COPPERMILLS PLANT OF THE METROPOLITAN WATER BOARD, LONDON

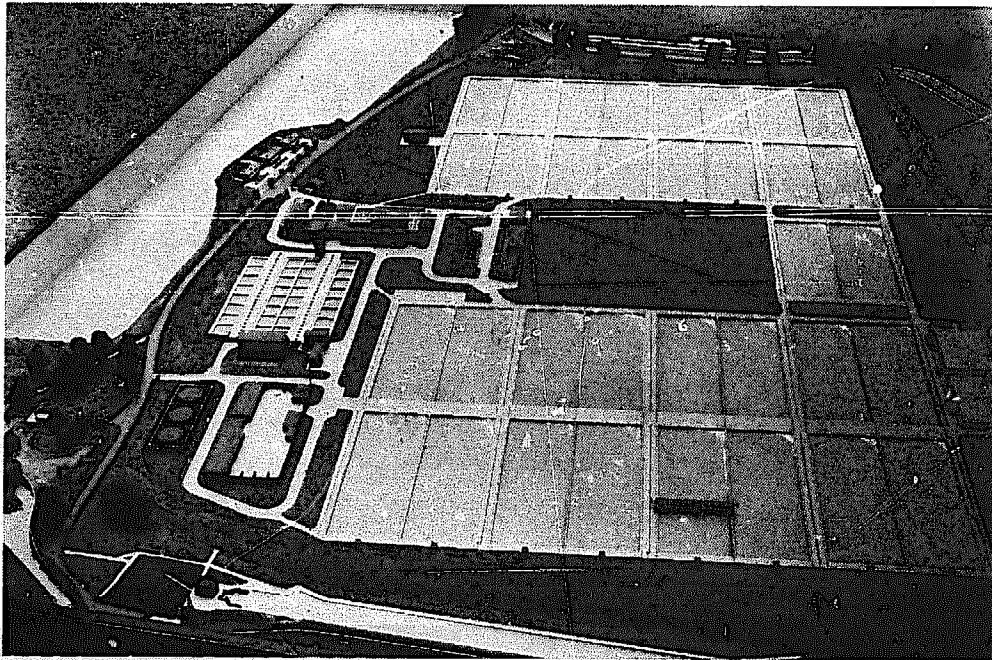

Metropolitan Water Board, London

(3) If filters are to be covered, the quantity of material to be removed at each cleaning will be greatly reduced, since little or no algae will be present. A few access points for cleaning will suffice, and filters may be built adjacent to each other. Rectangular filter boxes of standard size will then permit the use of prefabricated construction elements.

(4) For maximum economy, the position of influent and effluent pipes should be planned at an early stage.

Supernatant water reservoir

Having decided on the number and surface area of the filters to be constructed, the designer will have to consider the component parts of each.

The supernatant water reservoir consists essentially of an upward extension of the walls of the filter box from the sand-bed surface. The reservoir so formed serves two purposes: it provides a waiting period of some hours for the raw water, during which sedimentation, particle agglomeration, and oxidation occur, and it provides a head of water sufficient to overcome the resistance of the filter-bed, thereby inducing downward flow through the filter.

It is this second factor that determines the vertical dimension of the reservoir. Since, as has been shown, the resistance varies from a minimum H_0 when the bed has been newly cleaned to a maximum H_{\max} at the end of the filter run, the water level in the reservoir may theoretically be allowed to vary within these limits, but in practice it is preferable to maintain a constant depth of water, equal to or greater than H_{\max} , by imposing an artificial resistance with the aid of a regulating valve on the effluent pipe. A constant depth reduces the dangers of disturbing the *schmutzdecke* as it forms, enables floating impurities to be removed from the reservoir through fixed scum outlets, and prevents the deep penetration of sunlight, which might encourage the growth of rooted aquatic plants in the filter surface.

The depth of water in the reservoir will be determined according to the maximum resistance anticipated. In practice, a head of between 1.0 m and 1.5 m is usually selected. The figure may, exceptionally, be as high as 2.0 m, but rarely more than this.

Above the water level in the supernatant reservoir the walls must be carried up to form a freeboard about 20–30 cm high.

Filter-bed

The medium through which the water is passed is normally a selected sand, though other granular substances such as crushed coral or burnt rice husk have been used in the absence of suitable sand. As the amounts required are large it is usual to employ ungraded material as excavated from natural deposits. In rapid sand filtration ungraded media would not be satisfactory, since the backwashing process would result in stratification of the material. Slow filtration does not suffer from this disadvantage, and the relatively heavy expense of careful grading is avoided.

Some degree of uniformity is, however, desirable in order to ensure that pore sizes are reasonably regular and that there is sufficient porosity. Accordingly sand having a coefficient of uniformity (see page 40) of less than 3 should always be chosen. A coefficient of less than 2 is preferable, but there is little advantage, in terms of porosity and permeability, in sand having a coefficient below 1.5 if additional cost is thereby incurred.

Filter media should be composed of hard and durable grains, preferably rounded, free from clay, loam, and organic matter. If necessary the sand

should be washed—a process that will also remove the finest grains, thus lowering the coefficient of uniformity and raising the average particle diameter. To prevent cavities developing in the filter-bed through attack by water that has a high content of carbon dioxide, the sand should not contain more than 2% of calcium and magnesium, calculated as carbonates.

FIG. 8. COMBINATION OF TWO TYPES OF STOCK SAND

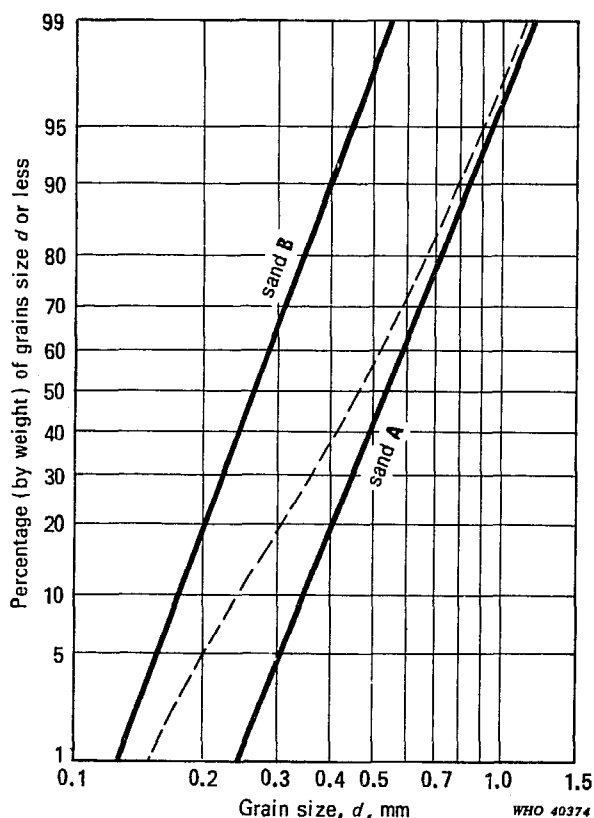

The broken line indicates the filtering material obtained by mixing 3 parts of sand A with 1 part of sand B to obtain an effective diameter of about 0.25 mm.

Ideally the effective diameter of the sand, d_{10} , should be just small enough to ensure a good quality effluent and to prevent penetration of clogging matter to such a depth that it cannot be removed by surface scraping. This effective diameter usually lies in the range 0.15–0.35 mm and is determined by experiment. Both finer and coarser materials have been found to work satisfactorily in practice, and the final selection will usually have to depend on the locally available materials. It is possible to combine two or more types of stock sand to bring the effective diameter of the mixture closer to the ideal (Fig. 8). Mixing must be carried out very thoroughly, preferably in a concrete

mixer. The resulting medium will have a higher coefficient of uniformity than either of its components.

The factors governing the thickness of the filter-bed have been discussed in earlier chapters. Since much depends on local circumstances, the thickness can be more effectively determined by experiment than by any other means. In general, three important considerations must be kept in mind:

- (1) Immediately below the filter-skin lies the zone in which purifying bacteria abound. The thickness of this zone is usually between 0.3 m and 0.4 m, the higher figure being appropriate when the sand grains are relatively coarse and the filtration rate reasonably high.

(2) Below this depth, chemical reactions take place in what may be described as the "mineral oxidation" zone, within which the organic materials liberated by the bacterial life-cycle in the upper sand layer are chemically degraded. The thickness of this zone may be between 0.4 m and 0.5 m, the higher figure applying when the raw water has a high organic content. Therefore under no circumstances should the total bed thickness, (1) plus (2), be less than 0.7 m.

(3) Except when hydraulic processes are used, a filter is cleaned by skimming off the top 1–2 cm of material. This material is not immediately replaced, and on restarting the filter the whole filtration process takes place at the same depth below the new surface, i.e., 1–2 cm lower in the same bed. Only after the filter has been operating in this way for some years will the bed surface be brought back to its former level by the addition of new material. Provision must therefore be made in the original thickness to allow for successive cleanings during this period. In a filter having an average run of 2 months between cleanings some 9–10 cm will be removed each year, and an allowance of an additional 0.5 m of thickness will allow for 5 years of operation before resanding becomes necessary.

These three considerations, taken together, lead to a total of 1.2–1.4 m for the filter-bed thickness to be provided initially. It may be somewhat less if the raw water is reasonably clear and filter runs are consequently longer than average.

When an effluent of particularly high quality is desired, a layer of activated carbon is sometimes incorporated into the filter-bed. This layer, about 0.1 m in thickness, is usually placed near the bottom of the filter-bed, thus permitting it to adsorb any last traces of taste- and odour-producing substances that have passed through the filtration process. It normally has to be removed and replaced during resanding operations, by which time the carbon will have become saturated with the impurities. In a similar way a layer of crushed shells is sometimes included to correct the pH of a naturally aggressive water.

Under-drainage system

The under-drainage system, though unseen, plays an important part in the efficient operation of a filter. It serves the dual purpose of supporting the filter medium and of providing an unobstructed passage-way for the treated water to leave the underside of the filter. Once the filter bed has been laid, the under-drainage system cannot usually be inspected, cleaned, or repaired in any way without a major disturbance to the bed as a whole, and it is therefore important that it should be so designed and constructed that it cannot become choked by the entry of granular material

from above, that it does not become disturbed during the laying and spreading of the filter medium, and that at all times it collects the treated water evenly over the entire bed area so that all parts of the filter perform the same degree of work.

The simplest form of under-drainage consists of a system of main and lateral drains (Fig. 9). Although improved methods and materials have been

FIG. 9. COMMON ARRANGEMENTS FOR THE MAIN DRAIN OF A SLOW FILTER

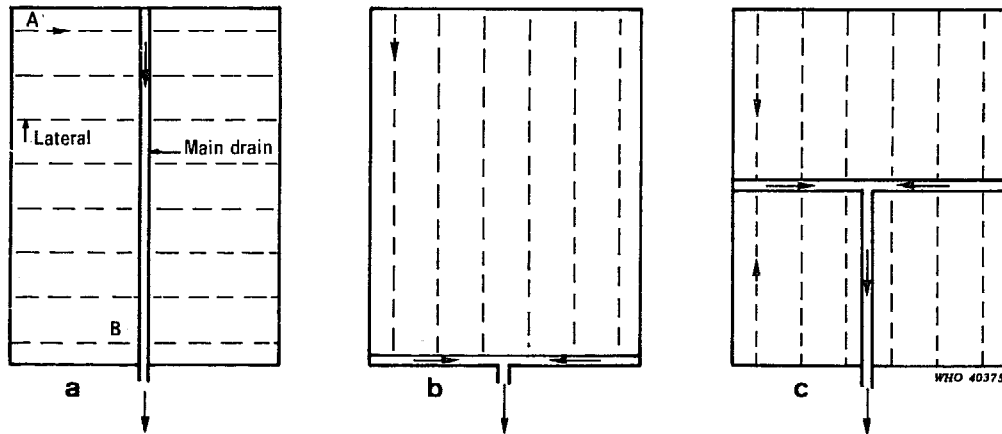

introduced at various times to increase the efficiency of the system, the hydraulic principles remain much the same.

In the simple, piped system, the lateral drains consist of porous or perforated unglazed drainage tiles, glazed pipes laid with open joints, or perforated pipes of asbestos cement or polyvinylchloride, covered with layers of gravel of successively diminishing grain size to prevent the intrusion of filtering medium. In small filters the main drain may also be constructed of pipes, but in larger filters it is more commonly made of concrete, frequently recessed into the floor of the filter box.

The flow of water through such a system is accompanied by head losses due to friction, turbulence, and the conversion of static head into velocity head, resulting in a lowering of the piezometric level. The head of the filtered water is thus not constant, but varies from point to point over the area of the filter-bed, while the raw water head has the same value at all points of the area. The resulting variation in filtration rate cannot be entirely prevented but it can be minimized by good design, which should ensure that the differences in filtered water head remain small in relation to the total head loss encountered by the water in its downward percolation through the filter.

The maximum variation in the piezometric level of the filtered water in a typical under-drainage system of the kind shown in Fig. 9a is calculated in Annex 1. The total loss in the under-drainage system should not usually

exceed 10% of the resistance of the filter-bed when at its lowest (i.e., when the sand is clean and the bed is at its minimum thickness after repeated scrapings) so that the variation over the area of the filter may be kept within an acceptable limit. In the example given in Annex 1 the consequences of this constraint are examined in detail.

Fig. 10 shows a number of arrangements for the construction of the

FIG. 10. VARIOUS TYPES OF FILTER BOTTOM

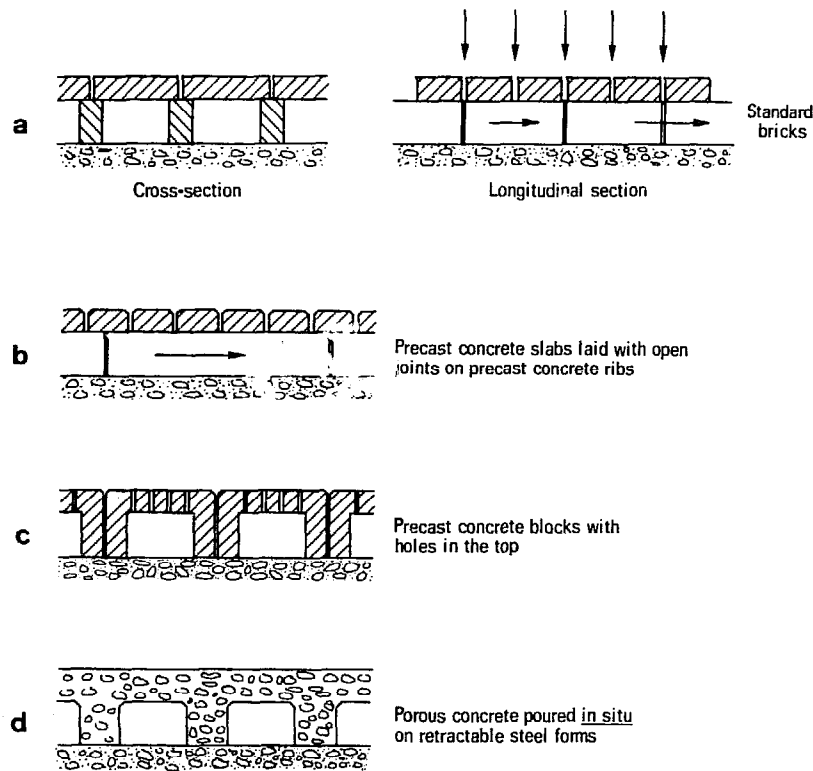

filter bottom, and Annex 2 gives the relevant calculations of loss in piezometric level for a filter bottom constructed with standard bricks, as shown in Fig. 10a.

Between the under-drainage system proper and the filter-bed itself there should be some layers of gravel to prevent the filtering medium from entering and choking the drainage waterways and to ensure a uniform abstraction of the filtered water when a limited number of drains are provided. This supporting gravel system is built up of various layers, ranging from fine at the top to coarse at the bottom, each layer composed of carefully graded grains (i.e., the 10% and 90% passing diameters should differ by a factor of not more than $\sqrt{2} = 1.41$).

The grains of the bottom layer of gravel should have an effective diameter of at least twice the size of the openings into the drainage system (e.g., the spacings between bricks or between open jointed pipes). Each successive layer should be graded so that its smaller (d_{10}) particle diameters are not more than four times smaller than those of the layer immediately below.

The uppermost layer of gravel must be selected with a d_{10} value more than four times greater than the d_{15} value of the coarsest filtration sand and less than four times greater than the d_{85} value of the finest filtration sand taken from natural deposits, which will vary in grain size from one spot to another. Hence, when supporting a filter medium for which $d_{15} = 0.18$ mm and $d_{85} = 0.3$ mm, the uppermost layer of the supporting gravel should have a d_{10} value between 0.7 mm (4×0.18 mm) and 1.2 mm (4×0.3 mm).

A gravel with a d_{10} value of 1.0 mm, and a d_{90} value of 1.4 mm ($d_{10} \times \sqrt{2}$) would therefore be suitable. The layer immediately below could have equivalent values of 4.0 mm and 5.6 mm, and the third layer 16 mm and 23 mm respectively. If the joints in the under-drainage system are 8 mm or less in width, these three layers will suffice.

Where it is too difficult or expensive to grade the gravel within a layer to the recommended ratio of $1 : \sqrt{2}$, the requirement may be relaxed to a factor of 1 : 2, but in this case the layers should have their d_{10} values restricted to three times that of the layer above. In the example just quoted, four layers would then be required with gradings of 0.7–1.4 mm, 2–4 mm, 6–12 mm, and 18–36 mm. Some engineers even prefer the d_{10} ratio between layers to be restricted to a factor of 2, which in the case quoted would call for six layers with gradings of 0.6–1.2 mm, 1.2–2.4 mm, 2.4–4.8 mm, 4.8–10 mm, 10–20 mm, and 20–40 mm.

Gravel for slow sand filters should conform to similar specifications to those applied to the filtering medium itself. The stones should be hard, preferably rounded, with a specific gravity of at least 2.5, and should be free from sand, clay, loam, dirt, and organic impurities of all kinds. If necessary the gravel should be washed to ensure its cleanliness. Not more than 5% by weight should be lost after immersion for 24 hours in warm concentrated hydrochloric acid. The thickness of each layer should be at least three times the diameter of the largest stones in its grading, but for practical purposes the minimum thickness of the layers is usually increased to 5–7 cm for the finer material and to 8–12 cm for the coarser gravel.

A number of such layers amounts to an appreciable depth of gravel, which has little effect on the quality of the effluent but involves expense in the construction of the filter box as well as in the provision of the gravel itself. To reduce this expense to the minimum, the openings into the under-drainage system are kept as small as possible, often by the use of porous concrete or similar material having fine openings. A floor of such material,

as illustrated in Fig. 10*d*, made of porous concrete using 5–10 mm aggregate, would require only one layer of 1.2–2.4 mm gravel to support a filter sand with an effective size of 0.3 mm or more.

Because of the high permeability of gravel, the resistance to downward flow is negligible. As an example, with a filtration rate of 0.5 m/h, the total resistance of the four-layer filter support referred to above would be made up as follows:

- (1) Top layer, 6 cm thick, 0.7–1.4 mm gravel, $k = 25$ m/h:
resistance = $0.5 \times 0.06/25$ m = 1.20 mm.

FIG. 11. UNDER-DRAIN SYSTEM AND SUPPORTING GRAVEL LAYERS IN A SLOW FILTER

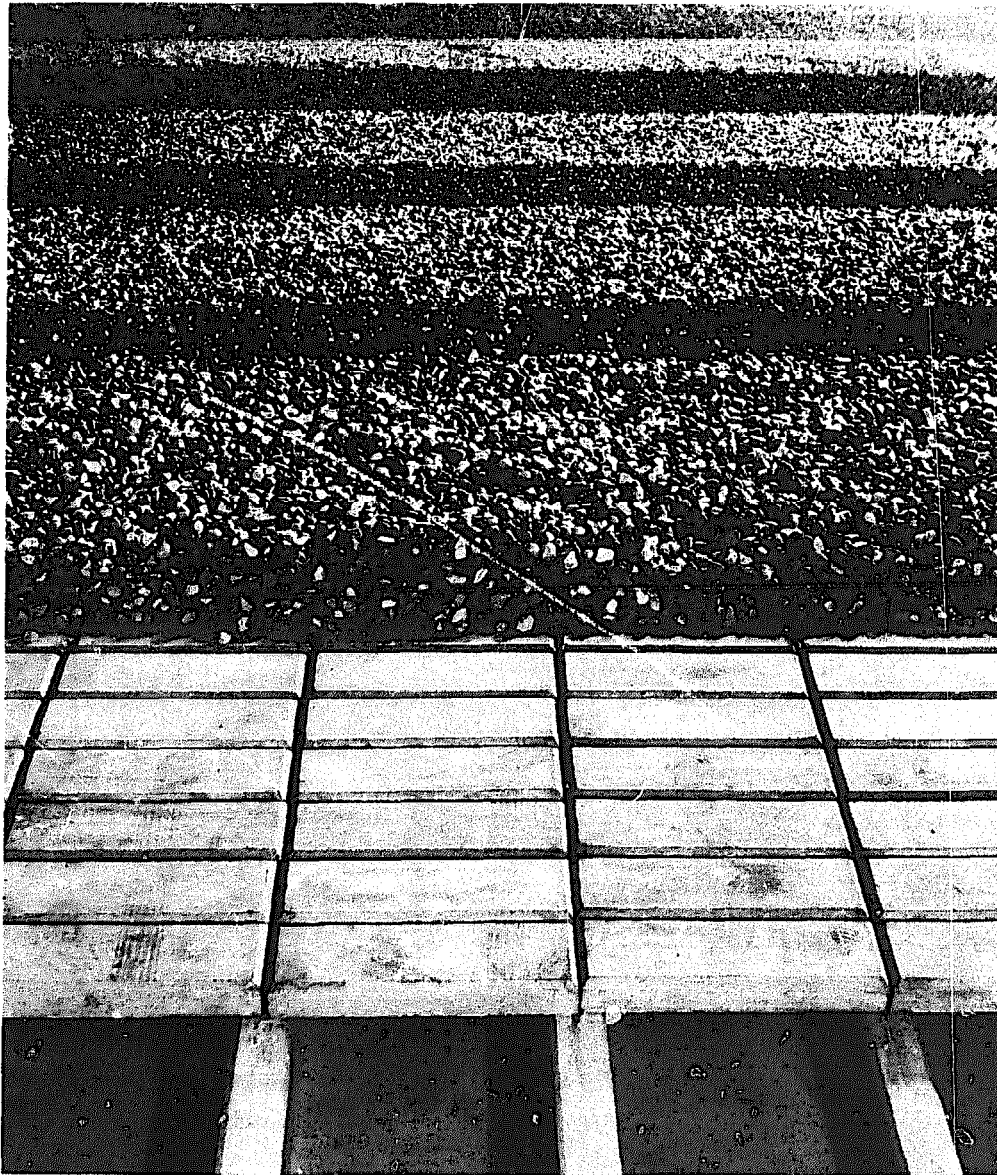

Municipal Waterworks, Amsterdam

- (2) Second layer, 6 cm thick, 2–4 mm gravel, $k = 200$ m/h:
resistance = $0.5 \times 0.06/200$ m = 0.15 mm.
 - (3) Third layer, 6 cm thick, 6–12 mm gravel, $k = 1800$ m/h:
resistance = $0.5 \times 0.06/1800$ m = 0.02 mm.
 - (4) Bottom layer, 12 cm thick, 18–36 mm gravel, $k = 16\ 000$ m/h:
resistance = $0.5 \times 0.12/16\ 000$ m = 0.00 mm.
- Total resistance for filter support 30 cm thick = 1.37 mm.

The resistance of a filter bottom made of bricks or concrete slabs is also extremely small. One constructed of slabs (Fig. 10*b*) with 15 cm between supports and 5 mm open joints has a resistance (when the flow rate is 0.5 m/h) of only 0.1 mm.

The gravel layers must be carefully placed (Fig. 11), since subsequent movement may disturb the filter sand above and either lead to choking of the under-drainage system or produce cavities through which the water may pass with insufficient treatment. The larger sizes of gravel may even be hand packed.

Filter box

Most filter boxes are today built with vertical or near-vertical walls (in which case the horizontal dimensions will be those of the filter-bed surface) of a depth sufficient to accommodate the constituent parts just described. In the example given, the internal depth of the box would be the sum of the following depths, starting from the top:

Freeboard above supernatant water level	0.25 m
Supernatant water	1.25 m
Filter medium (initially)	1.25 m
Four-layer gravel support	0.30 m
Brick filter bottom	0.16 m
	<hr style="width: 10%; margin-left: auto; margin-right: 0;"/>
Total	3.21 m

Other conditions may call for depths of between 2.5 m and 4 m. The most common constructional materials are concrete for the floor and concrete (mass or reinforced), stone, or brick for the walls, according to the materials and skills most readily available. Occasionally, where economy in initial capital cost is of overriding importance, sloping walls are used, thus reducing the structural stresses by making fuller use of the bearing capacity of the ground. However, this technique calls for a greater land area and may present problems of aquatic growth at the edges and of watertightness. Reliance has sometimes been placed on puddled clay as a waterproof bottom and as a backing for brickwork or masonry sides

FIG. 12. SLOW SAND FILTER CONSTRUCTED OF MASONRY ON PUDDLED CLAY

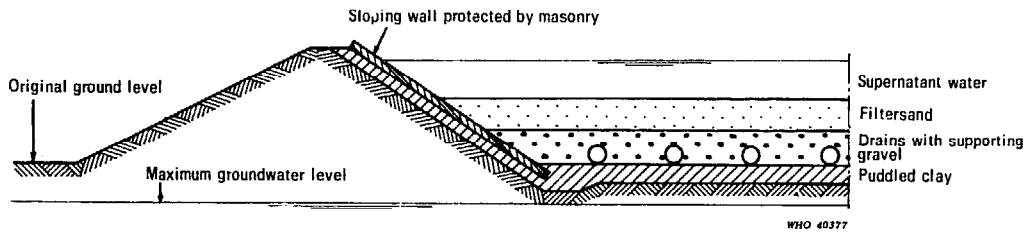

(Fig. 12), but unless it is extremely well prepared and laid it can prove very inefficient.

In the past, filters have been constructed to curved plans and random areas to conform to the contours of the site or in irregular geometrical

FIG. 13. AERIAL VIEW OF THE HONINGERDIJK PLANT FOR ROTTERDAM WATER SUPPLY, NETHERLANDS

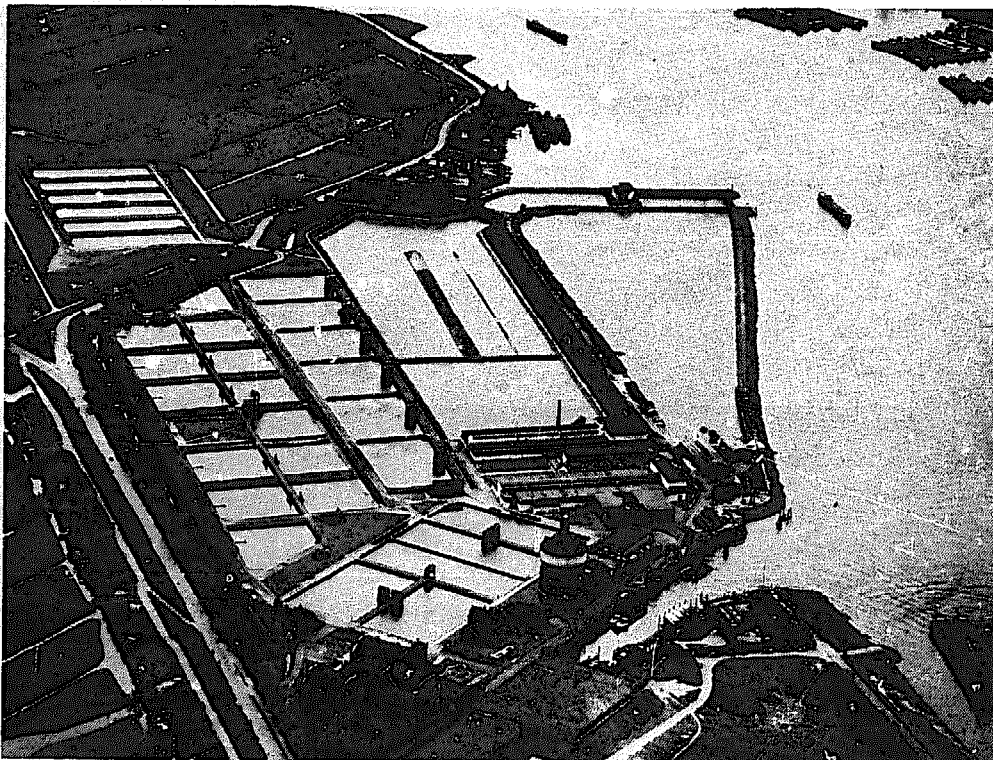

KLM Aerocarto N.V.

shapes to take maximum advantage of the available area (Fig. 13). Some have even been laid out to give the appearance of ornamental gardens.

Nowadays, except for the very smallest installations, when circular filters (occasionally encased in steel tanks) may be used (Fig. 14 and 15),

FIG. 14. CIRCULAR FILTERS FOR RURAL WATER SUPPLIES, SURINAM

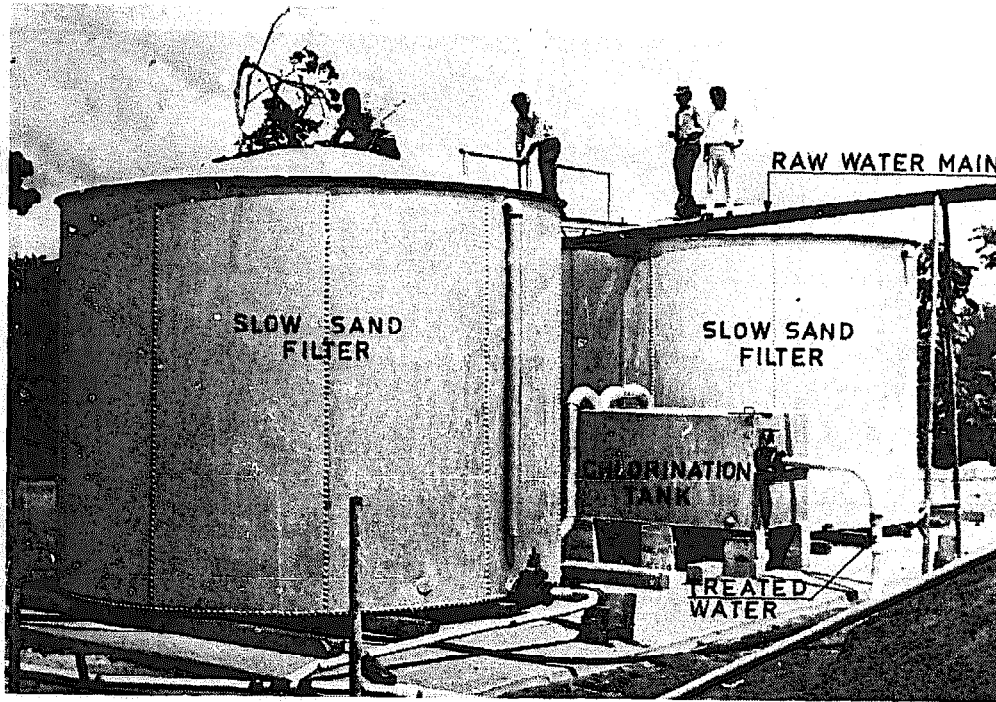
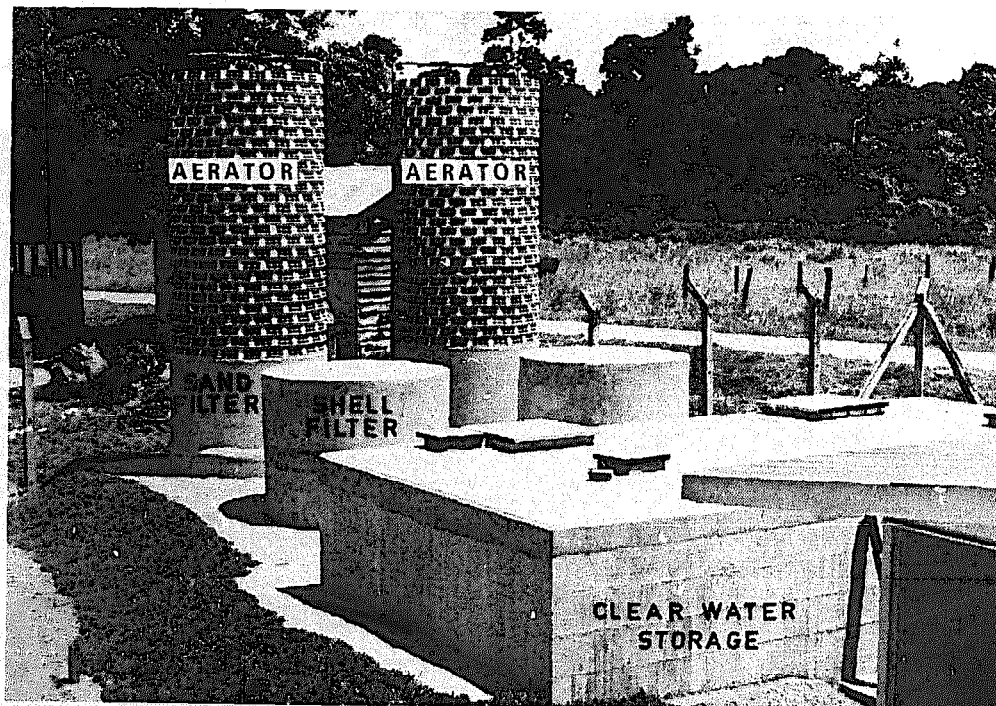

FIG. 15. PILOT PLANT IN SURINAM USING SMALL CIRCULAR FILTERS



Note the shell filters for pH correction after filtration.

filters are generally rectangular in plan and all the units in a plant are of similar size.

Filter boxes should be watertight, not merely to prevent loss of treatment water but to preclude ingress of groundwater, which might contaminate the treated effluent. For the same reason it is a wise precaution to ensure that the floor is above the highest water table.

FIG. 16. VILLAGE WATER TREATMENT INSTALLATION, S URINAM

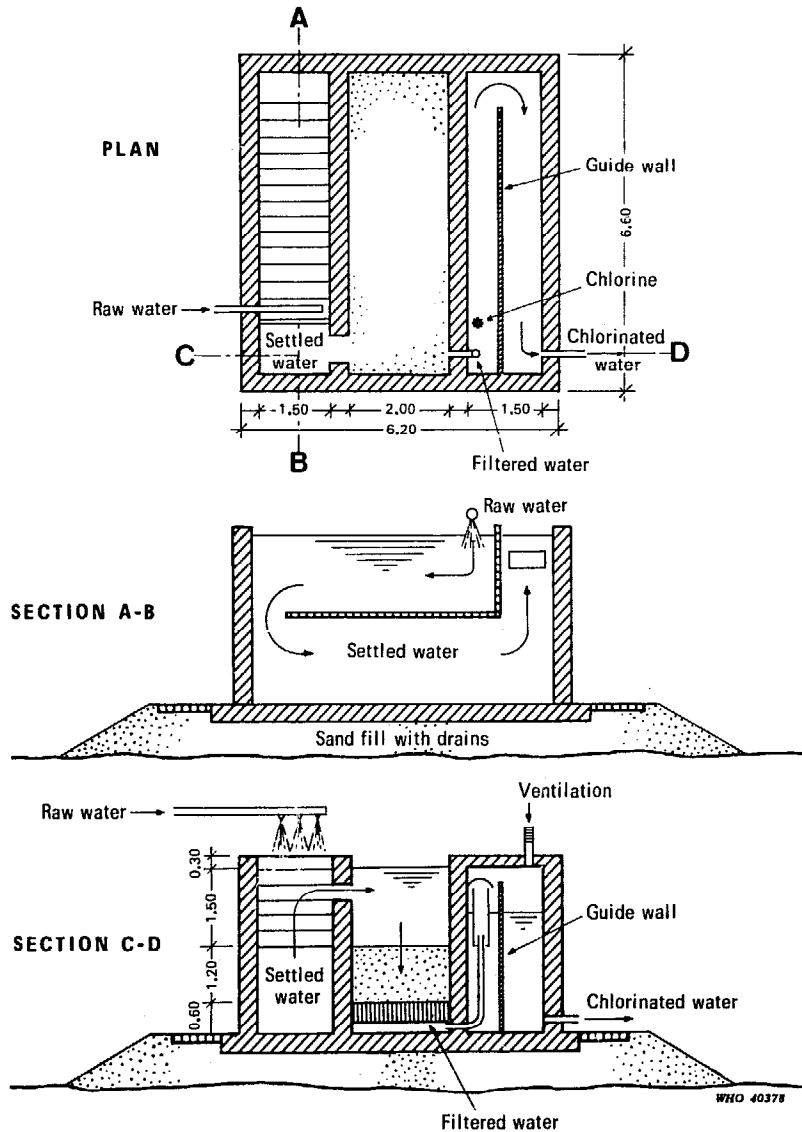

Both for heat insulation and for easy access, the top of the walls should be only a short distance above finished ground level, the surrounding area being made up or graded to accomplish this. It is, however, prudent to allow part of the wall to protrude above ground level, to about the same

height as that of the internal freeboard element, in order to trap wind-blown dust and debris and to reduce the chances of small animals falling into the filter.

In climates where low temperatures are not a problem, it may be more convenient to build small filters above ground. This may be so where the groundwater table is high or where excavation in hard rock would be expensive. Fig. 16 shows one of the treatment units constructed in Surinam to serve villages of up to 500 inhabitants (capacity 25 m³/day). The units are built in pairs to ensure continuity of supply. As will be seen, the whole unit—settlement tank, aerator, filter, clear-water tank and chlorine doser—is built above ground level.

“Short circuiting”, or the downward percolation of water along the inner wall face without passing through the filter-bed, endangers the purity of the effluent, and structural precautions must be taken against it. It is no problem with sloping walls, since the sand tends to settle tightly against them, but with vertical walls it may be necessary to incorporate devices such as built-in grooves or artificial roughening of the internal surface (Fig. 17). The most effective precaution is to give the walls a slight outward

FIG. 17. METHODS OF PREVENTING THE SHORT CIRCUITING OF THE FILTER-BED ALONG THE VERTICAL WALL

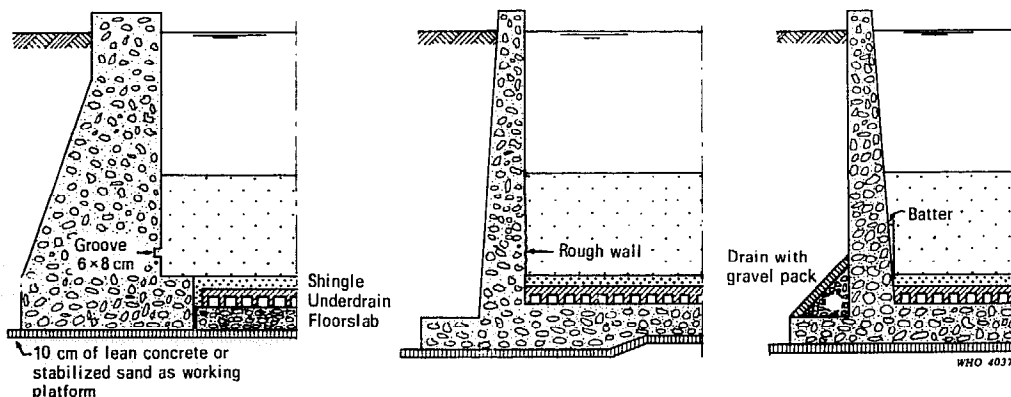

batter, so as to obtain the advantages of sloping walls, and to use grooved or roughened surfaces in addition. A precaution that was once in common use was to keep the under-drainage some distance from the base of the walls, but this method decreases the effective filtering area and is rarely adopted nowadays. Above and below the area of contact with the sand-bed, all concrete surfaces should be as dense and smooth as possible to reduce fouling by slimes and other aquatic growths.

When designing filter boxes it should be remembered that the special requirements relating to water-retaining structures and the precautions necessary against thermal expansion and contraction, shrinkage of concrete,

uplift of floors, and unequal settlement become more difficult as the area of the structure increases. To ensure watertightness it may be preferable to plan for a larger number of filters of smaller size.

Filter controls

To be certain that the filters will operate successfully in accordance with the calculated hydraulic characteristics already described, it is important that the pipework, valves, and devices used to regulate the operation of the filter should be planned and calculated with the same care.

Basically, means must be available to:

- (1) deliver raw water into the supernatant water reservoir;
- (2) remove scum and floating matter from the supernatant water;
- (3) drain off the supernatant water prior to filter cleaning;
- (4) lower the water level within the bed;
- (5) control the rate of filtration and adjust it as bed resistance increases throughout the length of the filter run (a venturi or other type of meter is a very desirable component of the regulating system and is recommended for all but the smallest filters);
- (6) ensure that negative pressures cannot occur within the bed (the weir is the device usually used for this purpose);
- (7) convey the filter effluent to the filtered water reservoir;
- (8) run filtered water to waste or to the inlet side of other filters during the ripening process;

FIG. 18. DIAGRAM OF A SLOW FILTER, SHOWING CONTROL VALVES

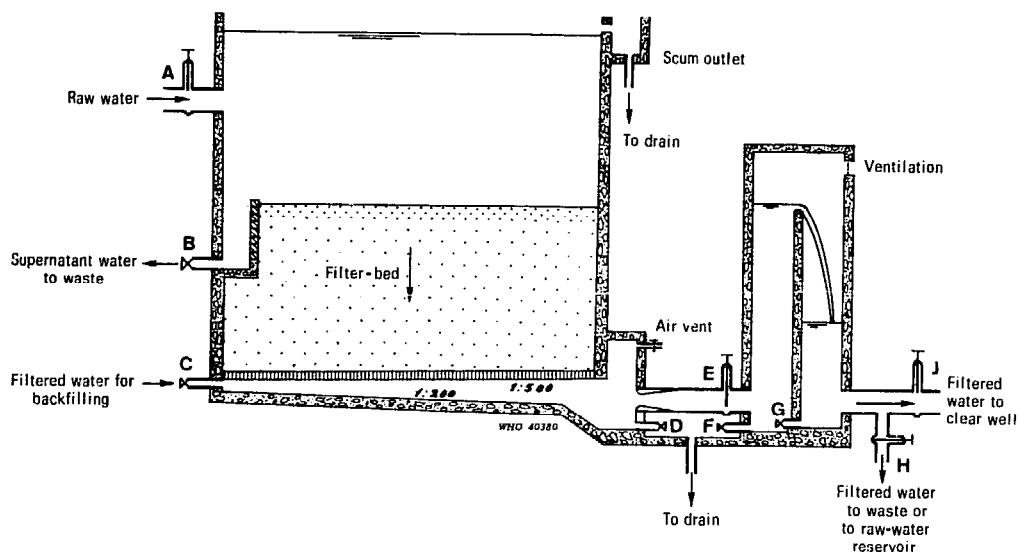

(9) fill the sand-bed from below with filtered water (from other filters) after cleaning.

Fig. 18 is a diagram of a slow sand filter on which all these various regulating devices are indicated, and it is pertinent to consider their inter-relationship during the normal working of a filter.

The flow of water through a filter-bed depends on three factors (Fig. 19):

- the raw water (or inlet) head H_1
- the filtered water (or exit) head H_2
- the filtration rate, or velocity of flow, v_f .

FIG. 19. DARCY'S LAW AS APPLIED TO FILTRATION THROUGH CLEAN SAND

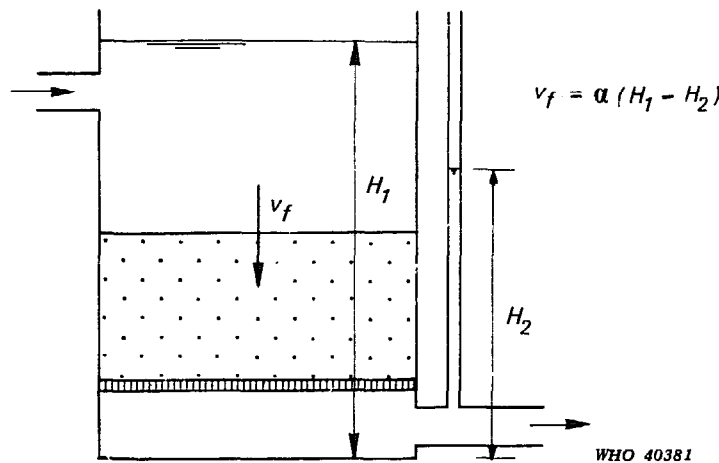

These factors are related, according to Darcy's law, by the equation

$$v_f = \alpha(H_1 - H_2)$$

in which the coefficient α depends on the hydraulic characteristics of the complete filter. Some of these characteristics are "built-in" (e.g., the thickness and grain size of the medium and the hydraulic resistance of the under-drainage system), but the most significant is clogging, which increases with the length of the filter run and depresses the value of α .

The importance of maintaining a steady rate of filtration throughout the filter run and the advantages of keeping a constant head of water over the bed surface have been discussed. It is usual, therefore, to control the influent raw water to keep H_1 constant, and to adjust the exit head H_2 to compensate for the decrease in α as the bed resistance builds up.

It would at first sight appear simpler and equally satisfactory to operate a slow sand filter with no control on the outlet by delivering a constant quantity at all times (by the regulation of the delivery pump for example).

FIG. 20. UPSTREAM RATE CONTROL

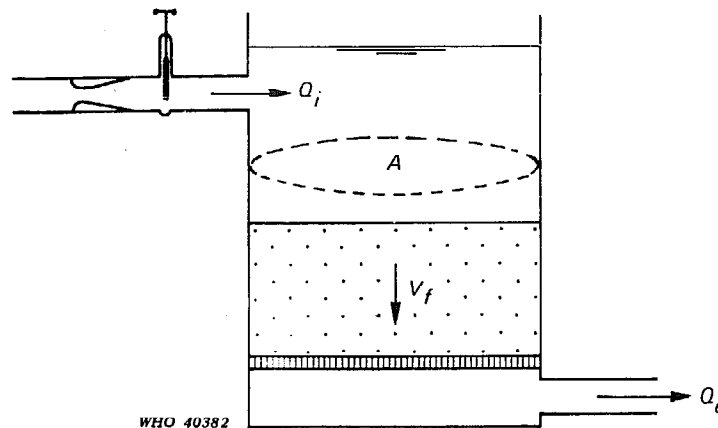

Fig. 20 illustrates this arrangement. However, apart from the consequent variations in the level of the supernatant reservoir (H_1 continually increasing to compensate for the reducing coefficient α), this method of operation is unsatisfactory for the following reason.

It will be obvious that the quantity of the influent raw water Q_i will be equal to the effluent quantity Q_e only when the supernatant water level remains steady. If H_1 drops by an amount δH in unit time the inlet and outlet quantities will bear the relationship:

$$Q_e = Q_i + \delta H A$$

where A is the area of the filter surface. Since it is the outflow Q_e that determines the filtration rate v_f ,

$$v_f = \frac{Q_e}{A} = \frac{Q_i}{A} + \delta H.$$

Even under the most careful working conditions it is possible for δH to reach a value of 0.1 m/h. In rapid filtration, with Q_i/A in the neighbourhood of 5–10 m/h, such a lowering of the raw water level would increase the filtration rate by a mere 1–2%, which is negligible, but in slow sand filtration, with Q_i/A as low as 0.1–0.2 m/h, it would increase the filtration rate by 50–100%, with a consequent deterioration in effluent quality. It is thus more satisfactory to maintain a constant raw water level and to regulate the filtration rate by a control in the effluent line.

The raw water level may be maintained automatically by means of a float-controlled butterfly valve, as shown in Fig. 21, or by manual operation of the raw water inlet valve or supply pump. Manual control is relatively simple since the water level can be maintained immediately below the lip of the scum outlet troughs (which act as an overflow if the level rises). It has a further advantage in the case of filters supplied by individual pumps, for then the output of the raw and filtered water pumps

FIG. 21. AUTOMATIC CONTROL OF RAW WATER LEVEL; MANUAL CONTROL OF FILTRATION RATE

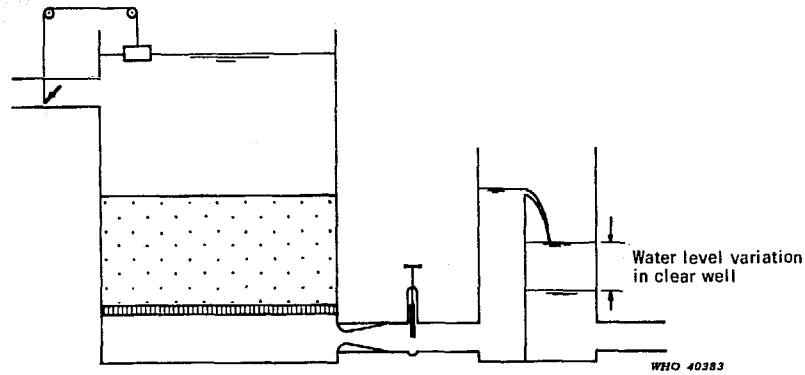

may be balanced if no separate storage reservoir for filtered water has been provided.

Control of the filtration rate by means of a regulating valve on the effluent line may also be effected automatically, using one of the many rate controllers manufactured for the purpose. In rapid filtration, with a fast build-up of filter resistance, automatic control is virtually essential, but with slow filtration the increase in filter resistance and the resulting decrease in filtration rate proceed so gradually that manual control need present no difficulties. In Fig. 21 the gate valve in the effluent line is regulated by hand in such a way as to maintain a constant filtration rate, the value of which can be accurately read from the preceding venturi meter. Where labour is scarce the valve may be automated to operate from the meter, or a remote control system may be installed. While such devices will add to the initial cost, the need for supervision will be reduced, though this in itself may carry dangers if minor defects are not noticed and corrected promptly.

FIG. 22. MANUAL CONTROL OF RAW WATER LEVEL; MANUAL CONTROL OF FILTRATION RATE BY MEANS OF ADJUSTABLE OVERFLOW TUBE

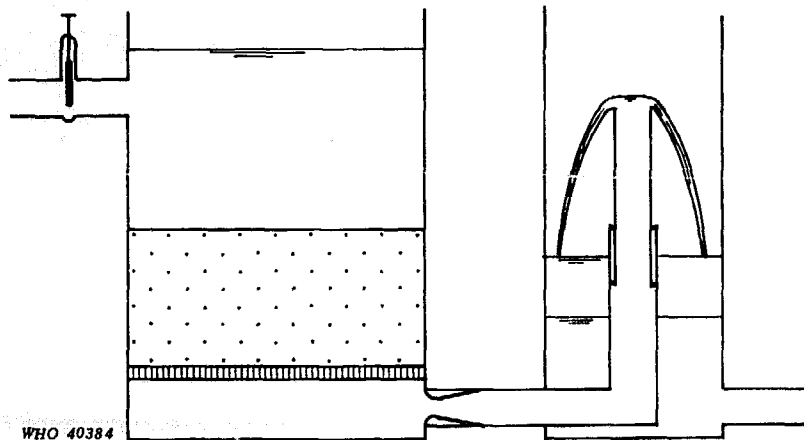

It has been shown earlier that the provision of an effluent weir is a valuable device to prevent negative heads and air binding, and Fig. 21 shows such a weir at the entrance to the clear well. In Fig. 22, on the other hand, the weir and control valve are combined into a single and very simple unit consisting of a pair of telescopic tubes, the inner of which can be raised and lowered to adjust the rate of filtration.

The various controls listed at the beginning of this section are discussed in the following paragraphs.

Raw water delivery. When individual pumps for each filter are provided, control of the quantity supplied may be effected at the pump outlet, but in the more usual case where a common set of pumps supplies a number of filters or the raw water flows by gravity from a single reservoir a regulating valve will be necessary to maintain the supernatant water at a constant level, (valve A in Fig. 18).

The entrance of the raw water into the supernatant water reservoir must be so arranged that the sand-bed below is not disturbed by turbulence. In one arrangement, shown in Fig. 18, a drainage trough is constructed under the inlet to absorb the vertical force of the incoming water at the start of filling operations, before a sufficient layer of water has accumulated to protect the filter surface.

Scum outlet. This should preferably take the form of a trough, and in large filters several should be constructed on different sides of the filter box so that whichever way the wind is blowing floating matter may be removed by the simple method of increasing the rate of inflow very slightly and allowing the supernatant water to spill over the lip of the trough. No valve need be provided on the trough drain, which is led to waste. The scum outlet acts also as a safety overflow to prevent the supernatant water level rising excessively owing to careless operation.

Supernatant water drain. When a filter is due for cleaning it is necessary to remove the supernatant water so that the bed surface is exposed. The resistance of the filter being high, it would take a long time to lower the level of the supernatant water by allowing it to drain through the filter-bed and would cause an excessive delay in restoring the filter to operational use.

A separate drain and emptying trough (B in Fig. 18) is therefore provided through which the supernatant water may be discharged to waste (if water is plentiful) or returned to the raw water pumps or reservoir for treatment through other filters.

It must be remembered that with successive filter cleanings the bed surface will be lowered until after some years it approaches 0.5 m below its original level. If the emptying trough is fixed in height, this depth of water will be left on the filter surface. A common practice is therefore to construct the trough with an adjustable sill along at least part of its length,

so that after each cleaning the lip can be matched to the new surface level. The length of time the filter is idle is reduced by rapid emptying, which depends on the capacity of the discharge pipe and the accompanying losses due to friction and turbulence.

Bed drainage. After draining off the supernatant water it is desirable, before cleaning, to lower the level within the bed by a further 10 cm or more so that the *schmutzdecke* and the top layer is relatively dry and easy to handle. Resanding, replacement of an activated charcoal layer, or repairs to the underdrainage system will need more complete drainage of the bed. A valve (D in Fig. 18) should be provided to carry this drainage to waste.

Effluent control valve. The use of this, the most important control in filter operation, has already been referred to in some detail earlier. It is shown diagrammatically at E in Fig. 18, immediately downstream of the flow meter.

Effluent weir. This may take the form of a fixed weir as shown in Fig. 18. To enable its height to be varied to suit the head loss through the system, this weir should either have an adjustable crest plate or a telescopic outlet, as shown in Fig. 22, in which case it is possible to omit the effluent control valve.

The purpose of the weir is threefold—to prevent negative heads developing in the bed with consequent air binding, to aerate the effluent, thus raising its oxygen content and releasing such dissolved gases as carbon dioxide that could render the water aggressive, and to make the operation of the filter independent of water-level fluctuations in the clear-water reservoir. The structure enclosing the weir must be very well ventilated both to provide oxygenating air and to prevent possible accumulations of gas that could be harmful to operators.

A bypass valve (G in Fig. 18) should be provided to enable the downstream side of the weir to be emptied through valve F, which is also capable of draining the chamber upstream of the weir.

Adduction line. The outlet valve (J in Fig. 18) and pipes leading to the clear water reservoir should, like the raw water pipeline, be of a size that accords with normal hydraulic principles, taking into account losses from friction and turbulence. It should be remembered that, once a filter has been built, the filtering area is fixed but the filtration rate is capable of being changed. An increase in filtration rate might, for example, become possible in the future if the raw water quality were to be improved by pretreatment. If the adduction lines and control valves were inadequate to cope with this increase, the cost of duplication or replacement would be high. It is good practice, therefore, to install pipework capable of carrying, say, 50% more than the load immediately anticipated, since this adds little to the initial cost but could save large sums later.

Diversion of filtered water. During the ripening period of a new or

recently cleaned filter it is necessary to divert the effluent to waste, or return it to the raw water reservoir, until the bacterial action of the bed has become established and the effluent quality is satisfactory. Valve H in Fig. 18 is included for this purpose.

Backfilling. After the cleaning of a filter-bed (as well as during its initial filling) filtered water is introduced from the bottom to drive out air bubbles from the medium as the water level inside the sand rises. The filtered water is obtained from the clear well or from the outlet side of another filter and is admitted through valve C in Fig. 18.

Miscellaneous. Fig. 18 also shows how, by sloping the floor of the filter box, it is possible to drain the filter completely and how vents can be suitably located to prevent any air pockets forming in pipework or valve chambers.

Covering of filters

Covering of filters may be necessary for one or more of the following reasons:

- (1) to prevent deterioration of effluent quality during periods of low temperature, i.e., below 6°C for several months during the year or below 2°C for one month or more;
- (2) to prevent the expense and operational difficulty of ice removal in places where heavy frosts may occur;
- (3) to prevent algal growth in the supernatant water, by excluding sunlight;
- (4) to avoid a deterioration of the raw water quality through windborne contamination or bird droppings.

The first two of these obviously apply to plants constructed in temperate or cold climates, whether due to latitude or to altitude. If conditions are likely to be severe, heat insulation is required, which was at one time usually accomplished by constructing a flat concrete roof and covering it with a layer of soil. This had certain disadvantages. Soil, especially when saturated, is very heavy, necessitating an expensive load-bearing roof, while the insulating properties of wet soil are not particularly high. This method of construction has now been almost entirely superseded by lightweight roofs lined with insulating material such as plastic foam, but precautions must be taken against corrosion of the structure since a high degree of condensation of an aggressive nature can be expected beneath the cover.

The same type of covering can obviously be used to exclude sunlight where both temperature and algal problems are to be expected. In tropical

or subtropical climates, sunlight exclusion alone may be needed, and a much less solid structure will suffice. Indeed, small filters are often roofed with removable frames covered with corrugated iron or even grass matting, placed on bearers immediately above the water level and having small sections easily lifted for inspection.

Permanent structures must have ample working headroom above the filter surface, with sufficient access for the removal of filter scrapings and the introduction of new sand when replacement becomes necessary. With large filters, the ability to drive dump trucks on to and around the surface may save considerable handling costs during resanding operations. If mechanical cleaning is to be adopted, the construction of the roof must obviously allow sufficient clear space free from supports or other structural members and even if mechanical equipment of this nature is not to be immediately installed the possibility of later conversion must be borne in mind if high structural conversion costs are to be avoided in the future.

With both permanent and light temporary structures, allowance must be made for wind pressures and uplift acting on the comparatively large areas of unsupported roof involved in filter covering.

5. Operation and maintenance

One of the points in favour of slow sand filtration as a water treatment process that appeals particularly to those responsible for public water supplies in developing countries and other areas where skilled staff may be difficult to recruit is its extreme simplicity of operation. Provided that a plant has been well designed and constructed there is little that can go wrong as long as the simple routine of operation is carried out.

The operation of the filter is determined by the filtration rate, which is controlled at the effluent outlet. Inflow, which may be delivered by a pump, by gravity supply from a constant level reservoir, or by flow from a raw water storage-pond regulated by an automatic control valve in an adjoining chamber, is adjusted so that the head of water in the supernatant reservoir remains constant at all times. Excessive raw water delivery will cause overflow through the scum outlets, while a reduction in the rate of inflow will cause the level in the supernatant water reservoir to drop; either condition should alert the operator to a defect in the mechanism controlling the supply of raw water. In the case of very small filters or those constructed to low-cost specifications and gravity fed from a reservoir, stream catchment, or similar source, a simple manually operated valve may be the only inlet control. This will need periodic checking if a balance is to be kept between the dangers of wasting raw water (through overflow) and diminishing output (through a dropping head over the filter-bed).

The filtration rate is controlled by a single regulating valve on the effluent delivery. At the beginning of the filter run this will be partially closed, the additional resistance thereby provided being equal to that which will later build up within the filter-bed. Day by day as the run continues this valve must be checked and opened fractionally to compensate for the choking of the filter and to maintain a constant filtration rate. In the early part of the filter run the daily build-up will be almost imperceptible, calling for very little valve adjustment, but toward the end the resistance will increase more rapidly, necessitating a more positive opening of the valve and signalling the impending need for filter cleaning.

To enable the operator to regulate the valve precisely, it is necessary to have some form of measuring device on the effluent outlet. The most satis-

factory is a venturi meter immediately upstream of the valve, and in most installations of reasonable size it is considered essential. The meter dial is placed next to the valve control gear so that the operator can check the reading while making flow adjustments, and it is usual also to incorporate an automatic recording chart so that the manager or supervisor can assure himself that the velocity rate has been continuously controlled. In very small installations, a gauge showing the height of flow over the weir or telescopic outlet may be used as a substitute for the flow meter. This is very much cheaper than venturi equipment but less accurate and less easy to read.

Excessive algal growth may cause trouble in the operation of open filters. Pretreatment by microstrainers is one method of removing the algae contained in the raw water, but it will not necessarily prevent the growth of different species within the supernatant reservoir. Various methods of reducing their numbers have been adopted. The most effective (but expensive) way of excluding the sunlight that is essential for their growth is to cover the filters. When turbid river water is pretreated to provide a raw water source for the filter it is sometimes possible, by bypassing the pretreatment stage, to increase the turbidity in the supernatant water reservoir during periods of particular activity, thereby cutting down the penetration of the sunlight and inhibiting algal growth. This can be justified only when the interference due to the algae is greater than the choking effect of the turbidity.

To deal with occasional outbreaks of vigorous algal blooms, treatment of the raw water by chlorination (0.2–1.0 mg/l) or the application of copper sulfate (0.15 mg/l) is sometimes resorted to, but it is definitely not to be recommended as a general practice because it may interfere with the bacterial activity of the filter-bed, with a consequent drop in effluent quality. Chemical treatment should be carried out under strict supervision to ensure that mixing is adequate and to avoid overdosing. In small filters some improvement may be effected by the removal of algae by hand, particularly from the filter box walls above the sand-bed, but the expedient of breaking

FIG. 23. RECIRCULATION OF EFFLUENT

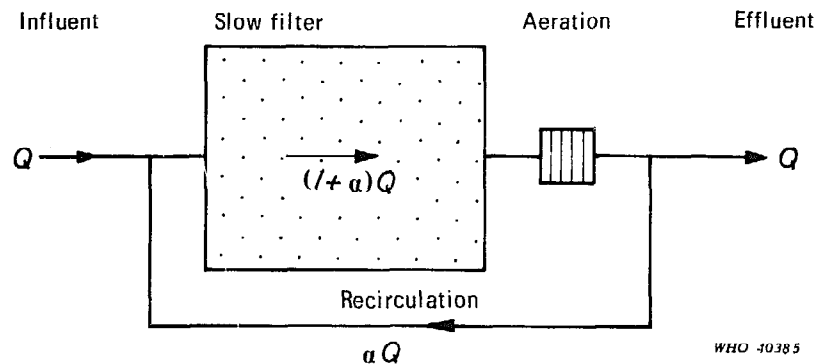

WHO 30385

up the *schmutzdecke* with rakes is a bad one since it can easily lead to a sharp fall in effluent quality.

If the dissolved oxygen content of the raw water drops below the potential oxygen demand, anaerobic conditions may develop within the bed. To some extent a reasonable growth of algae in the supernatant reservoir oxygenates the supernatant water as discussed in an earlier chapter. Where the composition of the raw water or the climate does not favour the growth of algae, or where chemical dosing or some other device has been used to remove or exclude them, it may be necessary to use other expedients to increase the dissolved oxygen content, such as aeration of the incoming raw water. A simpler method, which may be adopted when the condition is only temporary, is to recirculate part of the effluent as shown in Fig. 23. Its working may best be explained by an example.

Let us assume that raw water is being supplied to a filter at the rate of Q m³/h and that it has a dissolved oxygen content of 6 mg/l with a potential oxygen consumption of 8 mg/l. Without recirculation the effluent would have an oxygen content of zero and an oxygen demand of 2 mg/l. Cascading over the weir after filtration may increase its oxygen content to, say, 9 mg/l, but the gain comes too late to prevent anaerobic conditions from developing within the filter-bed itself.

When a proportion (αQ) of the effluent (after aeration) is recirculated and mixed with the incoming raw water, the oxygen demand of the latter can be satisfied completely, leaving an effluent oxygen content C_e , which may be calculated as follows:

$$(Q \times 6) + (\alpha Q \times 9) - (Q \times 8) = (1 + \alpha) Q \times C_e$$

$$C_e = \frac{9\alpha - 2}{\alpha + 1}$$

To ensure that anaerobic conditions do not develop in any part of the filter-bed, the oxygen content of the effluent should not be allowed to drop below 3 mg/l. Substitution of this value in the equation gives $\alpha = \frac{5}{6}$, so that the filtration rate must be nearly doubled. This would materially increase the head loss, and might prove impossible towards the end of the filter run, although the rate of clogging would not increase since the recirculation of filtered effluent would not add to the total amount of impurities being removed by the filter.

The operator will be expected to keep the filter structure and its surroundings in clean condition and to remove floating scum, leaves, and other debris through the outlets provided. Apart from this he has one other main duty—to take samples of raw and filtered water at stated intervals for analysis.

The frequency with which samples are taken will depend (in practical terms) on the availability of facilities for analysis. In a large waterworks with its own laboratory, sampling will almost certainly be carried out

daily, since the effluent analysis constitutes the only certain check that the filter is operating satisfactorily, and the raw water analysis provides what is possibly the only indication of a change in quality that might adversely affect the efficiency of treatment. At the other extreme is the small remote plant with two or three filters, able to afford only unskilled attendance and with no easy access to a laboratory. Even under such circumstances, an attempt should be made to conduct sampling on a regular basis. It may, for example, be carried out by the visiting supervisor or the local medical authorities. Water quality may also be measured with a fair degree of accuracy using field testing equipment based on membrane techniques; no formal laboratory is required nor a high level of skill. A compromise measure is to supplement infrequent bacteriological examinations with comparatively simple tests for free ammonia. Since ammonia should not be detectable in the effluent when aerobic conditions prevail in the filter, its presence is a good indicator of malfunctioning.

Initial commissioning of a filter

When first constructed, the bed of clean sand within which purification will eventually take place cannot, strictly speaking, yet be called a filter; certainly not a biological filter since the vital living organisms on which treatment depends are not yet present. The sand medium is, as we have seen, merely a framework upon which these organisms can establish themselves.

Building up the biological content of a new filter is a slow process calling for careful supervision. When another, actively operating filter exists nearby, some acceleration of the original "ripening" stage may be effected by "seeding" the new filter with some of the active material removed in cleaning, but otherwise there is no short cut to the following procedure.

First, with all outlet valves closed, the filter must be charged with filtered water, introduced from the bottom to drive out the air bubbles from the interstices of the sand, thus ensuring that the whole surface of every sand grain is in contact with the water. Water then continues to be introduced from below until the sand-bed is covered by a sufficient depth to prevent its being scoured or disturbed by turbulence from the admission of raw water. The raw water inlet may be sited immediately above the supernatant drain trough; if it is not, a concrete slab or some other protective device must be placed on the surface of the sand bed at the point where inlet turbulence is at its maximum (Fig. 24).

Top filling now commences, slowly at first, but at an increasing rate as the water cushion on the sand deepens, until the future normal working level in the supernatant water reservoir is reached. The outlet valve (H in Fig. 20) is then opened, and the effluent is run to waste at a rate

FIG. 24. CONCRETE APRONS TO PREVENT SCOUR AT INLET TO SLOW SAND FILTER
MADRAS WATERWORKS, INDIA

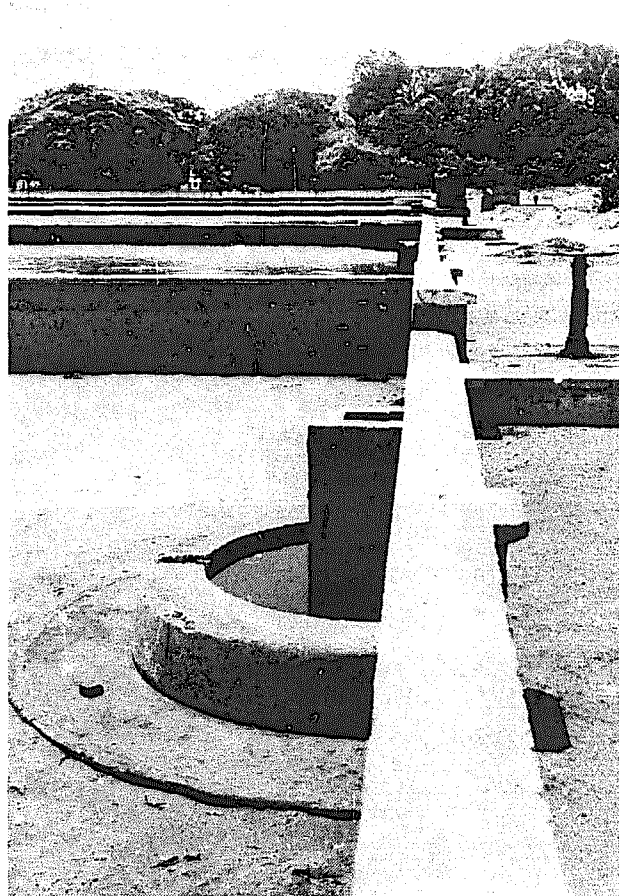

Madras Municipal Corporation/Swamy News Photo Service

(controlled by the filter regulating valve) of approximately one quarter of the normal filtration rate.

The filter must now be run, continuously and without interruption, discharging to waste (or to another filter) for at least several weeks in tropical climates and longer where temperatures are low. The time also depends on the nature of the raw water; the cleaner it is the longer the ripening process will take. The rate of flow is gradually increased during this period until it reaches the designed filtration rate. As ripening proceeds, there will be a slight increase in the head loss in the bed as the organisms build up, and the formation of a *schmutzdecke* will gradually become visible. These are signs that ripening is proceeding satisfactorily, but only after comparative chemical and bacteriological analyses of raw water and effluent have demonstrated that the filter is in full working condition may the waste valve be closed and the effluent directed to the public supply. From this point onwards the filter should operate under normal working conditions. If for any reason (say a temporary shutdown

of the public supply while a new water main is being connected) delivery is interrupted for a period too long to be accommodated by filling the clear water reservoir to capacity, filtration should be continued and the effluent diverted to waste, since any shutdown for an extended period must be followed by further ripening if the quality of the effluent is to be maintained.

Filter cleaning

When, during a filtration run, the bed resistance has increased to such an extent that the regulating valve is fully open, it is time to clean the filter-bed, since any further increase in resistance is bound to reduce the filtration rate. Resistance accelerates rapidly as the time for cleaning approaches. In many filtration plants, indicators are installed showing the inlet and outlet heads, from which the head loss can be regularly checked; this gives a direct picture of the progress of choking and the imminence of the end of the run. Without any measurement of head loss the only true indicator of build up of resistance is the degree of opening of the regulating valve, though the experienced operator may be able to recognize preliminary visual warnings in the condition of the filter-bed surface. Certain other warning signs may be given by a slight deterioration in effluent quality—another good reason for regular analysis wherever practicable.

To clean a filter-bed, the raw water inlet valve is first closed, allowing the filter to continue to discharge to the clear water well as long as possible (usually overnight). As the head in the supernatant reservoir drops, the rate of filtration rapidly decreases, and although the water above the bed would continue to fall until level with the weir outlet, it would take a very long time to do so. Consequently, after a few hours (e.g., next morning), the effluent delivery to the clear water well is closed, and the supernatant water outlet is run to waste through the drain valve provided.

Unless there is sufficient capacity in the clear water reservoir to maintain the supply during the cleaning period or unless an additional filter is available to take over the duties of the one being cleaned, the remaining filters must be operated at an increased filtration rate, which will inevitably result in more rapid clogging. Clearly, one of the advantages of installing a number of small filters rather than a few of greater area is that less spare capacity has to be provided to prevent the overloading of the remaining filters during the cleaning of any one of them.

When the supernatant water has been drained off (leaving the water level at the surface of the bed) it is necessary to lower the water within the bed still further, until it is some 10 cm or more below the surface. This is done by opening the waste valve (D in Fig. 18) on the effluent outlet pipe. As soon as the *schmutzdecke* is dry enough to handle, cleaning should start. If the filter-bed is left too long at this stage it is likely to attract scavenging

birds that will not only pollute the filter surface but disturb the sand to a greater depth than will be removed by scraping.

The cleaning of the bed may be carried out by hand or with mechanical equipment. Mechanical cleaning is a large subject and is dealt with in a separate section below. Hand cleaning is done by labourers using square-bladed shovels. Working as rapidly as possible, they should strip off the *schmutzdecke* and the surface sand adhering to it, stack it into ridges or heaps, and then remove the waste material by barrow, handcart, basket, conveyer-belt or other device (Fig. 25). When the filter-beds are very large,

FIG. 25. MANUAL CLEANING OF A SLOW FILTER



Municipal waterworks, Amsterdam

wide-tracked dumpers may be used, and the skimming may be accomplished by a similar tractor having an attached scraping blade, but only specially designed vehicles should be permitted on the bed surface otherwise the upper layers of the medium will be disturbed to the detriment of their bacterial population. For the same reason, barrows or handcarts should always be run on protective planks.

When the *schmutzdecke* consists largely of filamentous algae forming an interwoven mat, cleaning is a simple matter. The labourers will quickly acquire the knack of curling back this mat in reasonably large sections at a time, provided that the operation is timed so that the material is neither waterlogged nor so dried out that it is brittle. If the predominant species of the *schmutzdecke* is diatomous or some other non-filamentous type,

cleaning will be less easy, and closer supervision will be necessary to control the depth of scraping. After removal of the scrapings the bed should be smoothed to a level surface. The quicker the filter-bed is cleaned the less will be the disturbance of the bacteria and the shorter the period of re-ripening. Provided they have not been completely dried out, the microorganisms immediately below the surface will quickly recover from having been drained and will adjust themselves to their position relative to the new bed level. In this event a day or two will be sufficient for re-ripening.

The procedures to be followed during the re-ripening period will follow the pattern set when the filter was originally put into service, although they will be much accelerated. Before the filter box is refilled, the exposed walls of the supernatant water reservoir should be well swabbed down to discourage the growth of adherent slimes and algae, and the height of the supernatant water drain and of the outlet weir must be adjusted to suit the new bed level. The water level in the bed is then raised by charging from below with treated water from the clear water well or from one of the other filters. As soon as the level has risen sufficiently above the bed surface to provide a cushion, the raw water inlet is gradually turned on. The effluent is run to waste until analysis shows that it satisfies the normal quality standards. The regulating valve on the effluent line will be substantially closed to compensate for the reduced resistance of the cleaned bed, and the filter will then be ready to start a new run.

During cleaning operations precautions should be taken to minimize the chances of pollution of the filter-bed surface by the labourers themselves. Such measures as the provision of boots that can be disinfected in a tray of bleaching solution may be wise, hygienic personal behaviour should be rigidly imposed, and no labourer with symptoms that might be attributable to waterborne or parasitic disease should be permitted to come into direct or indirect contact with the filter medium.

Resanding

After several years' operation and, say, twenty or thirty scrapings the depth of filtering material will have dropped to its minimum designed level (usually about 0.5–0.8 m above the supporting gravel, according to the grain size of the medium). In the original construction a marker, such as a concrete block or a step in the filter box wall, is sometimes set in the structure to serve as an indication that this level has been reached and that resanding has become due.

During the long operation of the filter some of the raw water impurities and some products of biochemical degradation will have been carried into the sand-bed to a depth of some 0.3–0.5 m, according to the grain size of

the sand. To prevent cumulative fouling and increased resistance, this depth of sand should be removed before resanding takes place, but it is neither necessary nor desirable that it should be discarded. Instead it is moved to one side, the new sand is added, and the old sand replaced on top of the new, thus retaining much of the active material to enable the resanded filter to become operational with the minimum re-ripening.

This process, known as "throwing over", is carried out in strips. Excavation is carried out on each strip in turn, making sure that it is not dug so deeply as to disturb the supporting gravel layers below. The removed material from the first strip is stacked to one side in a long ridge, the excavated trench is filled with new sand, and the adjacent strip is excavated, throwing the removed material from the second trench to cover

FIG. 26. RESANDING OF A SLOW FILTER

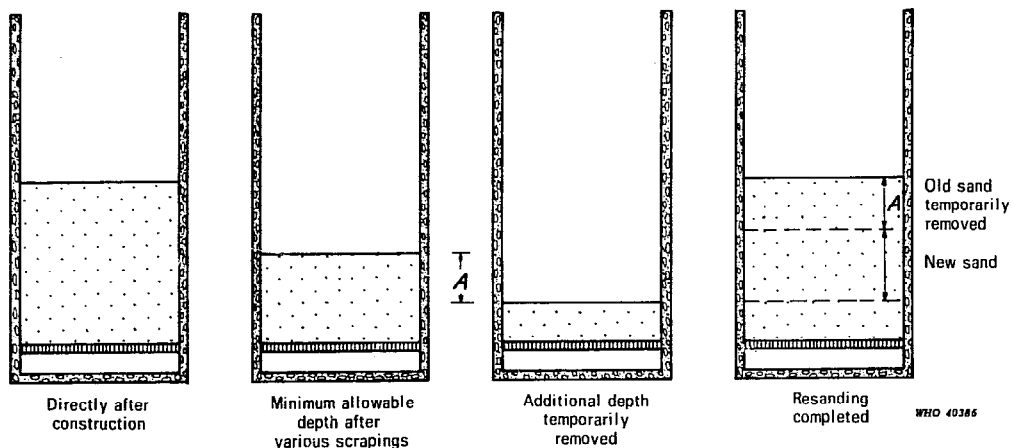
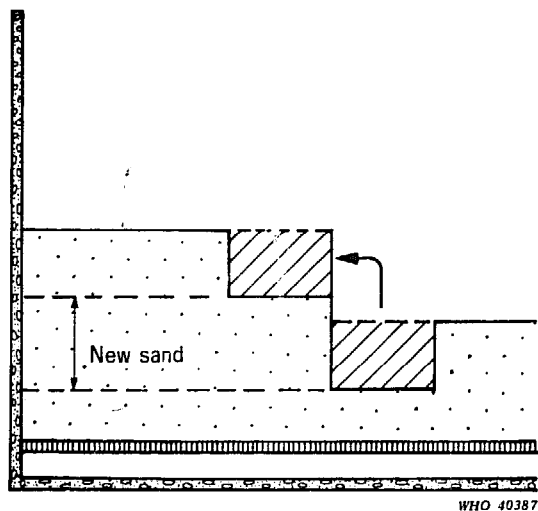

FIG. 27. "THROWING OVER" OF RESIDUAL SAND



the new sand in the first. The operation is illustrated in Fig. 26 and 27. When the whole of the bed has been resanded, the material in the ridge from the first trench is used to cover the new sand in the last strip.

In areas where sand is expensive or difficult to obtain, the surface scrapings from regular cleanings may be washed, stored, and used for resanding at some future date. These scrapings must be

washed as soon as they are taken from the filter, otherwise, being full of organic matter, the material will continue to consume oxygen, quickly become anaerobic, and putrefy, yielding taste- and odour-producing substances that are virtually impossible to remove during any later washing process.

A simple method of washing sand is shown schematically in Fig. 28, and a practical example is given in Fig. 29 and 30, which shows the sand-

FIG. 28. SAND WASHING MACHINE, EJECTOR TYPE

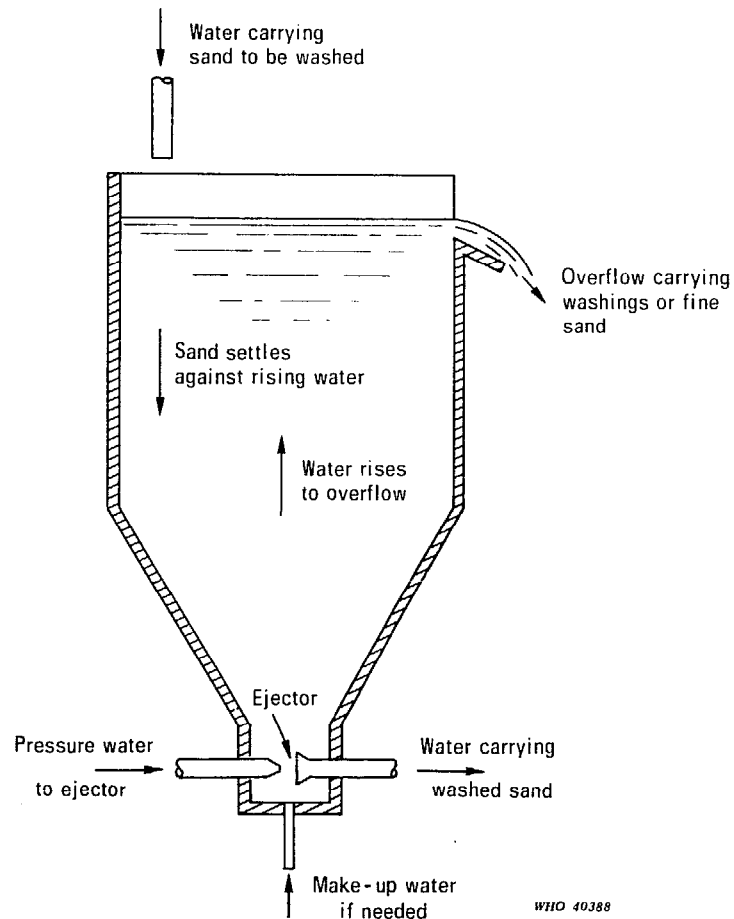

From: Fair, G.M. & Geyer, J.C. (1954) *Water supply and waste-water disposal*, New York, John Wiley

washing machine at the Madras waterworks, India. In this machine, the dirty sand from the filter-bed is fed into a drum. Filtered water is injected under pressure into the bottom of the drum, carrying the impurities upwards past a set of steel stirrers to the top, from where they are conveyed to a wooden Pelton wheel, which drives the stirrers. The clean sand and water are discharged to the filter-bed, while the dirty water flows into a sludge pit.

FIG. 29. GENERAL VIEW OF SAND WASHING PLANT AT MADRAS WATERWORKS, INDIA



Madras Municipal Corporation/Swamy News Photo Service

A completely clean sand is difficult to attain, both when fresh from excavation and when subsequently prepared for reuse. Washing rarely removes the strongly adherent organic coating entirely from the grains, and, after exposure to air, this coating becomes soluble and acts as a nutrient for bacterial growths. Under favourable temperature conditions micro-organisms will multiply, so that when the sand is reused during warm weather it may contain large numbers of bacteria, by no means all of which are of a nature to contribute to the water purification qualities of the filter-bed. It is often better, therefore, if washed sand is to be used, to carry out resanding operations in the winter, even if working conditions are then less favourable.

It must also be remembered that filter sand, when washed, loses its finer particles, so that the effective diameter is increased. This is likely to result in deeper penetration of impurities into the bed during subsequent filter runs.

A procedure once extensively adopted but little practised today is to wash the sand immediately after each scraping and return it to the filter-bed surface. The method has obvious advantages in the saving of transport and labour and in the fact that the depth of the bed remains constant, so permitting the use of shallower beds (since no additional depth need be allowed for the periodic removal of scrapings). Although this results in considerable savings in construction costs, the method has one serious

disadvantage that caused it to be discontinued early in the present century—only the top 0.05–0.10 m of the filter-bed is ever washed in a complete cycle, and the sand below this layer remains in place indefinitely until, in due course, clogging becomes persistent.

FIG. 30. SAND WASHING DRUM AT MADRAS WATERWORKS

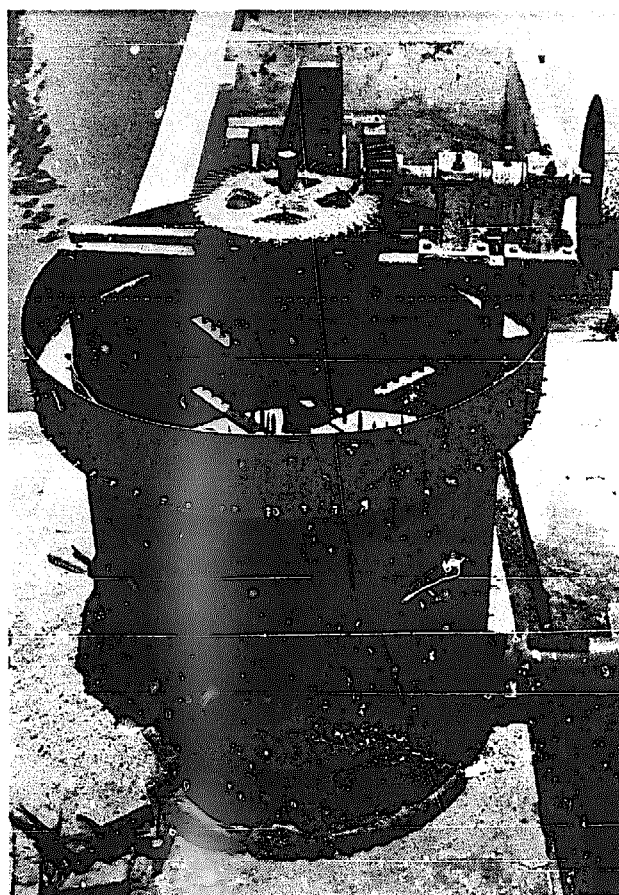

Madras Municipal Corporation/Swamy
News Photo Service

Mechanical cleaning of filters

The manual method of filter-bed cleaning requires only unskilled workmen using hand tools; it demands no special materials, equipment, or skills, and relatively little skilled supervision. It may therefore have considerable attractions in areas of high unemployment, but it is certainly unpopular in countries where labour costs are high and unskilled workers difficult to obtain. This position has gradually developed in the industrialized countries and has been balanced by an equally gradual introduction of mechanical aids such as portable conveyor-belts (Fig. 31) and hydraulic sand ejectors (Fig. 32) that enable the waste material to be

FIG. 31. TRANSPORTATION OF SAND WITH A CHAIN OF PORTABLE CONVEYOR-BELTS

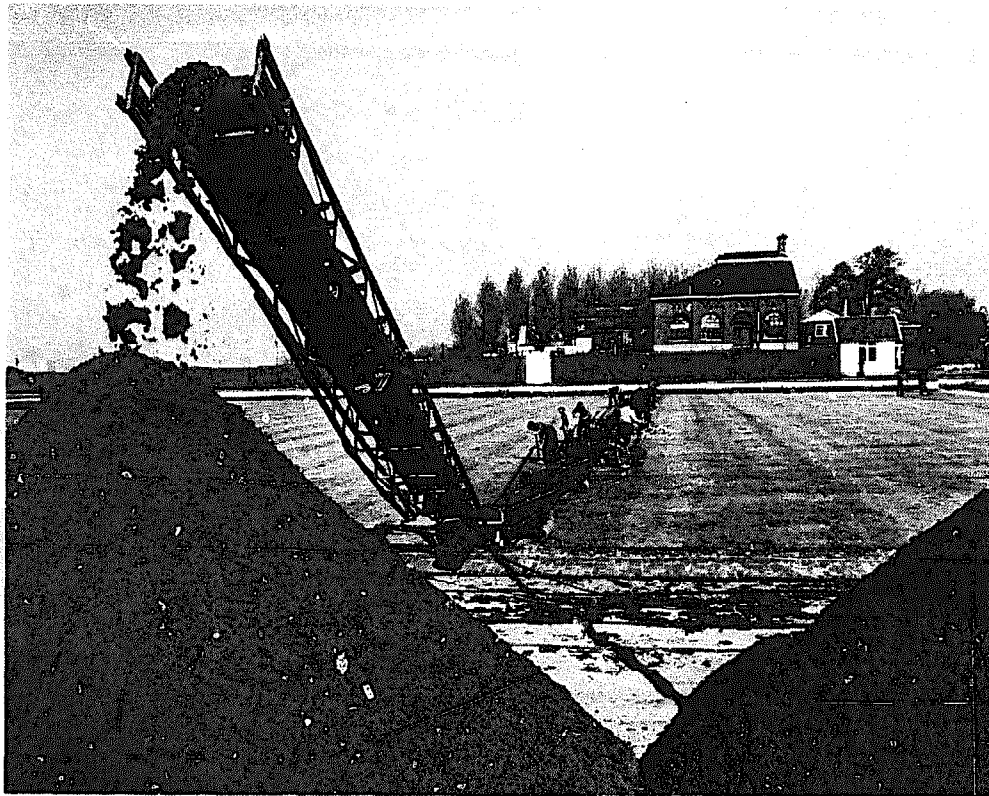

Municipal Waterworks, Amsterdam/Govert H. Vetten

FIG. 32. HYDRAULIC SAND EJECTOR

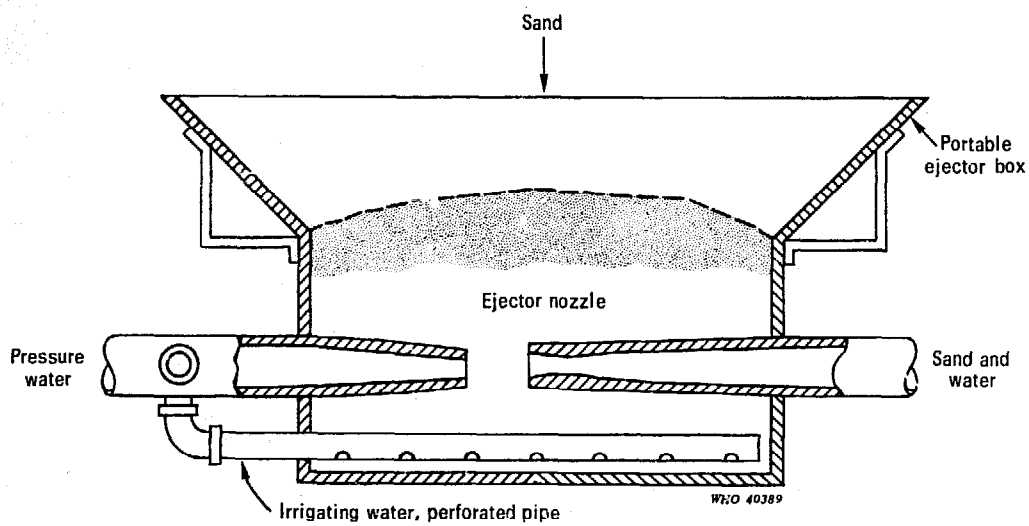

From: Fair, G.M. & Geyer, J.C. (1954) *Water supply and waste-water disposal*, New York, John Wiley.

lifted from the bed and conveyed to the central washing or disposal site with the minimum of handling. Over the past few decades the process of mechanization has accelerated, and there now exist, in many cities, systems whereby the whole of the cleaning of slow sand filters is carried out mechanically or hydraulically, using the bare minimum of operating staff.

The first fully mechanized system for this purpose was developed by the Metropolitan Water Board in London,¹ where very large filter-beds—up to 4000 m² in area—make hand cleaning a laborious and time consuming operation. The new system was devised to be used on existing beds, and so the need for special filter box construction had to be avoided. Each phase of cleaning is mechanized separately, using modified light agricultural tracked vehicles moving over the filter-bed itself. To prevent compaction of the medium (which would result in higher filter resistance immediately after cleaning) the soil pressure has been kept below 33 kN/m² by suitable adaptation of the vehicles.²

The key to the system is the use of skimming machines (Fig. 33) that scrape off the required amount of sand to a preset depth of 1–3 cm. From

FIG. 33. TRACTOR-MOUNTED SKIMMER

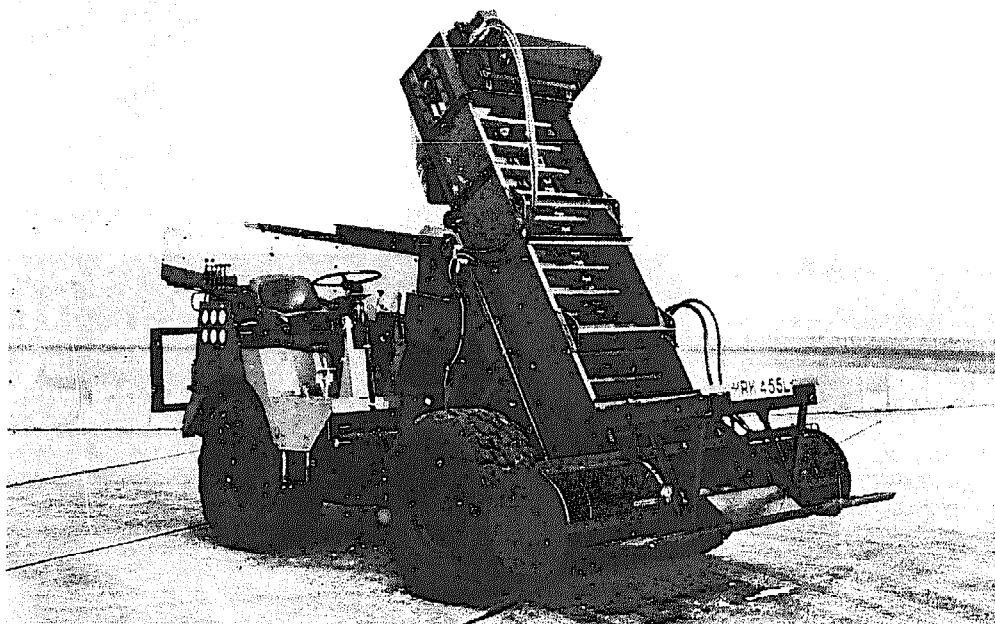

Metropolitan Water Board, London

¹ Lewin, J. (1961) *J. Instn Wat. Engrs*, 15, 15.

² In this publication pressures are given in newtons per square metre, in conformity with the recommendations of the International Organization for Standardization. $1 \text{ N/m}^2 = 1.019 \times 10^{-5} \text{ kgf/cm}^2$; $1 \text{ kgf/cm}^2 = 98.1 \text{ kN/m}^2$.

the skimming blades the sand is carried to the rear by screw conveyor and belt loader, being discharged into a following tractor with dumper body (Fig. 34). Special rake attachments trailed behind the tractors leave the

FIG. 34. FOUR-WHEEL-DRIVE DUMPER, 300 KG CAPACITY



Metropolitan Water Board, London

The ramps shown in the photograph allow access to and from the filter-bed, enabling the dumper to operate direct between the skimmer and the sand bay and thus eliminating the intermediate stage in which the sand is dumped on the filter-bed and removed by crane.

surface of the filter-bed in a level and finished condition. Trenching machines, also tracked, are used when a greater depth of excavation is needed, as in resanding (Fig. 35).

This system permits the number of labourers required to be halved, although those employed must possess a higher degree of skill. When allowance is made for amortization of the capital outlay on equipment, the saving in operational cost is not impressive, while the presence of motorized vehicles on the filter medium always carries a hazard of pollution from oil drippings. However, there has been a great saving of time in filter-bed cleaning, and hence in the period during which each bed is out of action, and this may be taken as the principal justification for mechanization.

In addition to treating the public supply, the Berlin waterworks has adapted the slow sand filtration principle to the treatment of raw water used for groundwater recharge. The spreading basins (see Chapter 6) are

FIG. 35. TRENCHING MACHINE FOR RESANDING OPERATIONS



Metropolitan Water Board, London

lined with a 0.4 m depth of coarse sand (grain size 0.5–2.0 mm) through which the downward percolating water passes at 0.04 m/h. Despite the coarseness of the sand and the low rate of filtration, the nature of the raw water is such that clogging is rapid and each basin lining requires cleaning once every 3 weeks. This is effected by scraping off a layer 1.5 cm thick with somewhat similar mechanical equipment to that used in London—skimmers on tracks (soil pressure less than 30 kN/m²) moving at 7–12 m/min—but the skimmers used in Berlin have blades 1.2 m wide

FIG. 36. MECHANICAL CLEANING AT THE BERLIN WATERWORKS

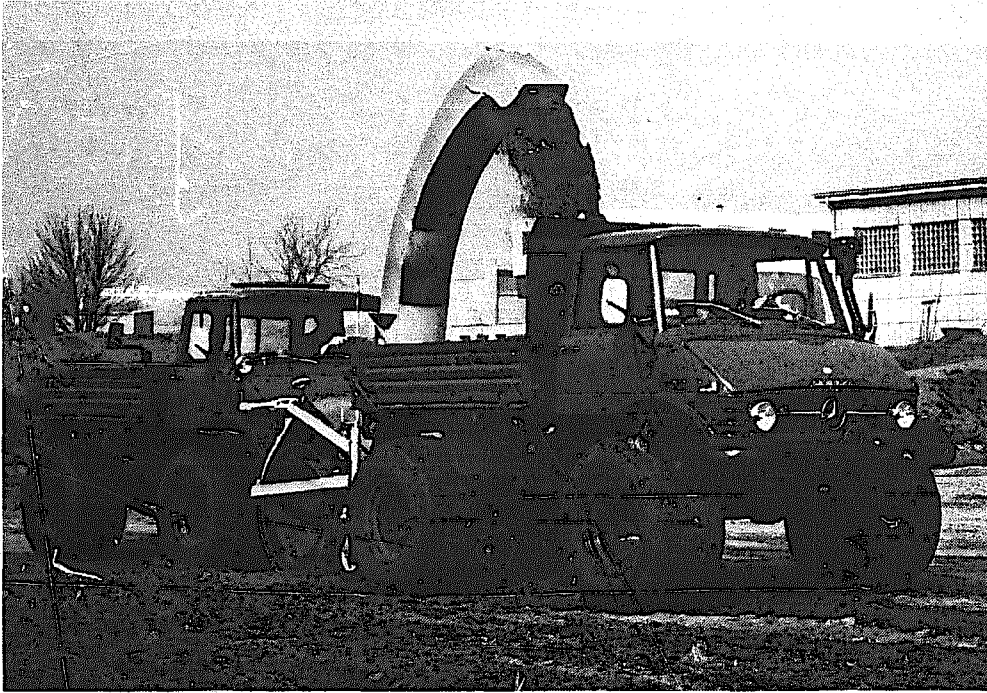

Berlin Waterworks/ Günther Metzner

separately supported on six pneumatic tyres, capable of preserving a constant depth of skim of up to 5 cm, however wavy the surface (Fig. 36). Instead of small tracked dumpers, large wheeled trucks are used, one per skimmer, fitted with oversized low-pressure tyres, and suitable for other duties when bed cleaning is not in progress.

Mechanization has been carried a stage further at one of the water treatment plants at Amsterdam (Fig. 37). The filters, each 25 m × 40 m,

FIG. 37. SKIMMING MACHINE AT AMSTERDAM WATERWORKS

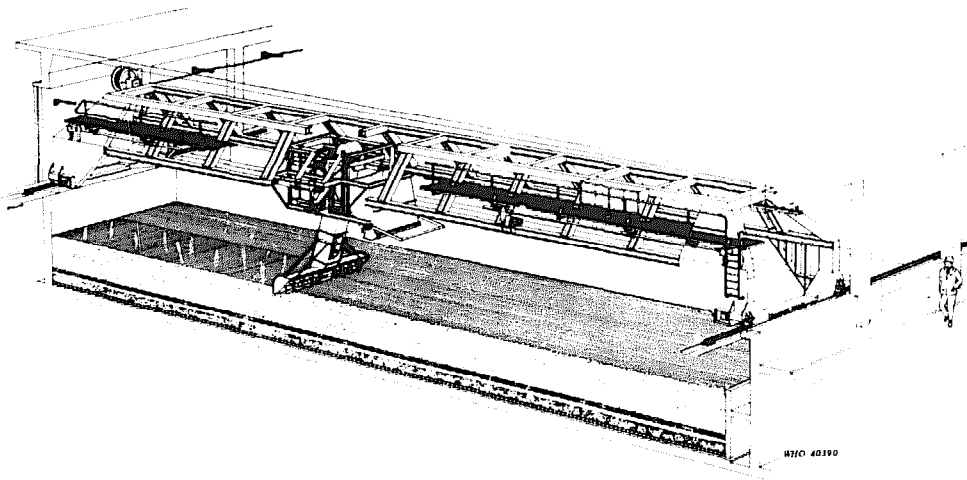

are constructed within a building on both sides of a central corridor. Each filter is spanned across its width by a travelling bridge from which the scraper mechanism is suspended. The filter sand is fine ($d_{10} = 0.12$ mm; $d_{60} = 0.2$ mm), resulting in a very shallow depth of penetration by impurities, hence a skim 1 cm or less in thickness is sufficient, and the sand surface is left completely flat after the passage of the scraper. The blade is

FIG. 38. MACHINE FOR THE HYDRAULIC CLEANING OF FILTER-BEDS (SIVADE SYSTEM)

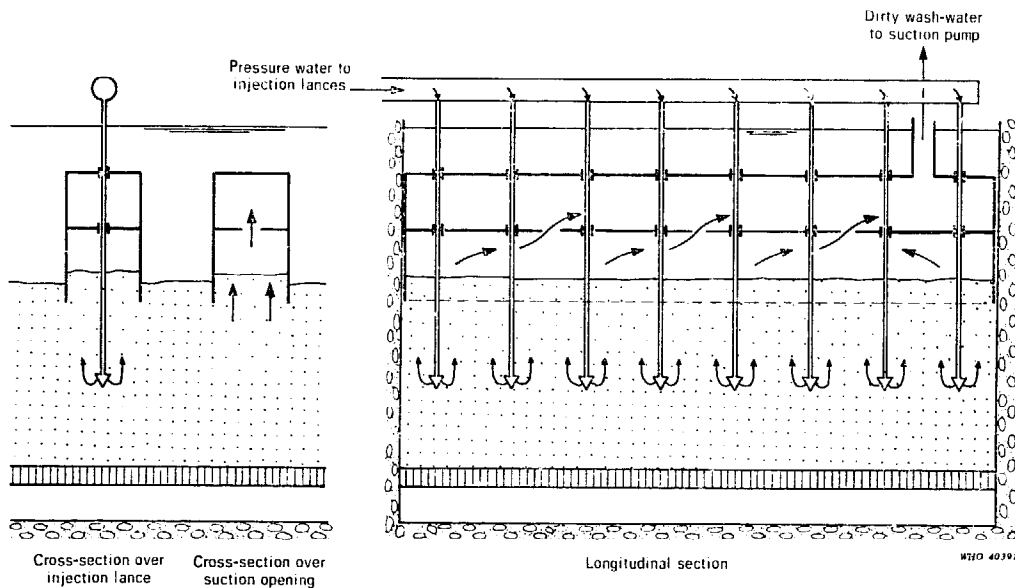

2.5 m wide, has a forward speed of 9 m/min and a backward speed of 18 m/min. A screw conveyor carries the sand to a bucket elevator, which transports the material to a bunker (also suspended from the bridge). The bunker has a capacity of 1 m^3 , sufficient for the scrapings of two strips to a depth of 0.8 cm. When the bunker is full it is emptied into a steel tank in the corridor, which is transported by fork lift truck to a disposal site outside the building. Labour requirements are very small, and two men can clean a filter of 1000 m^2 in less than $1\frac{1}{2}$ hours.

The hydraulic cleaning of filter-beds is the result of a different approach to the same problem. Its first known application was in 1933, when Sivade installed a plant for the Compagnie Générale des Eaux, Paris.¹ Similar systems have been installed in London² (1958), Antwerp (1967), Istanbul, and various other cities.

Backwashing has always been the recognized method of cleaning rapid filters, but two particular problems made it difficult to adapt the same

¹ Laval, M. (1952) *J. Instn Wat. Engrs*, 6, 155.

² Lewin, J. (1961) *J. Instn Wat. Engrs*, 15, 15; Burman, N.P. & Lewin, J. (1961) *J. Instn Wat. Engrs*, 15, 355.

FIG. 39. HYDRAULIC SAND-WASHING MACHINE AT ANTWERP WATERWORKS, BELGIUM

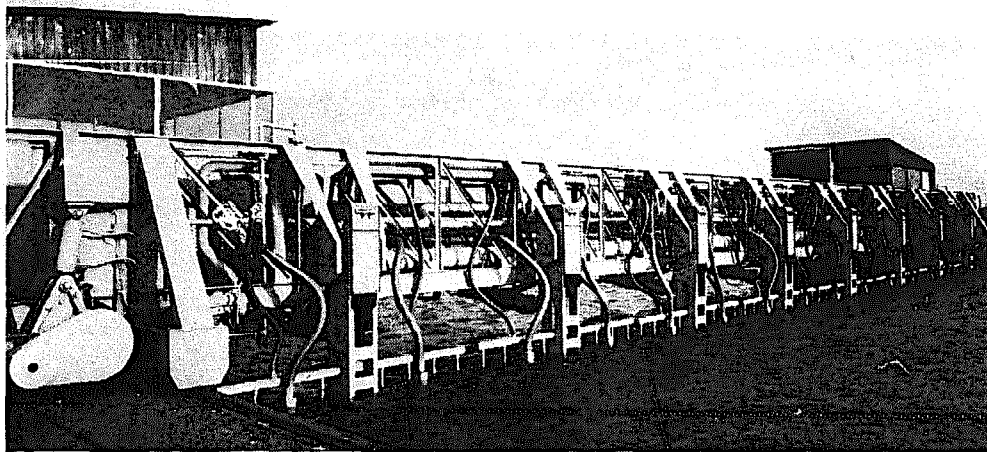

Antwerp Waterworks/Frans Claes

The machine is shown with the box lowered beneath the surface of the supernatant water.

principle to the cleaning of slow filters—the large quantities of water required to clean the much greater filter areas involved and the necessity of avoiding excessive disturbance of the lower active layers of the bed.

The Sivade system surmounted these difficulties by subdividing the beds into comparatively small sections and washing each in turn and by introducing the wash water from above to a predetermined depth below the surface and allowing it to force its way upwards from this point.

The equipment (Fig. 38) consists of a long, narrow, two-storied, bottomless box 0.3 m wide and having a length equal to the width of the filter. The box is carried by a gantry spanning the bed (Fig. 39). The cleaning operation starts by lowering the box until its lower edge penetrates the bed surface by about 5 cm, thus isolating that strip of the filter-bed (Fig. 40). Injection lances 0.3 m apart are lowered through the box in guide tubes and penetrate the sand-bed to a level well below the normal depth of penetration of raw water impurities (i.e., 15–30 cm below the surface). The lances are connected at their upper ends, through flexible tubes, to a header pipe containing filtered water at a pressure of 10–30 m head. At their lower ends they are fitted with points having radially disposed orifices through which the wash water is transmitted into the bed. These orifices are small, so that the water emerges in high-pressure jets and, owing to the high resistance, is equally distributed along the length of the strip being treated.

When backwashing slow filters, a high degree of scouring is not required, and a small expansion of the bed medium suffices, hence relatively low washwater velocities are called for (of the order of 10–30 m/h, depending upon the grain size of the sand). The width even of the largest filters will rarely exceed 50 m, so that the area enclosed by the caisson box

is relatively small (say 15 m² or less) and the quantity of washwater needed is correspondingly small.

FIG. 40. SAND WASHING *IN SITU*: MODE OF OPERATION

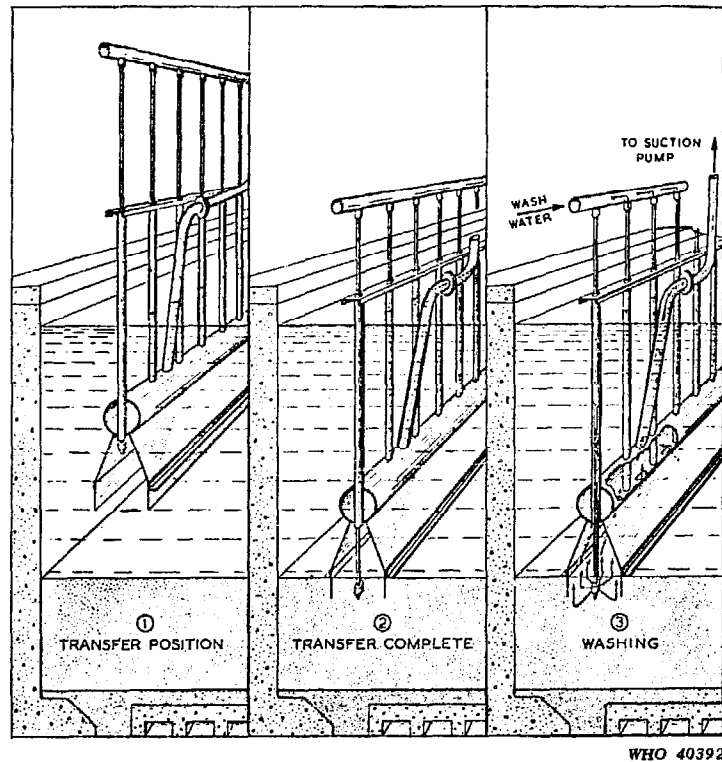

WHO 40392

From: Burman, N.P. & Lewin, J. (1961) *J. Instn Wat. Engrs*, 15, 355-367.

The water from the points of the lances rises to the surface, loosening and carrying the impurities from the upper sand layer, and passes through the lower chamber of the caisson boxes into the upper chamber, from which it is removed by a suction pump and delivered into a drain running alongside the filter. Careful adjustment of the box apertures through which the washings pass and careful balancing of the pressure and suction pumps ensure uniform washing conditions over the whole strip being treated. Backwashing lasts about one minute, after which the lances are withdrawn, the boxes are lifted, and the gantry is moved along the bed a distance equal to the width of the box, which is then relowered and the process repeated. Electrical controls enable the whole process to be carried out automatically. Occasionally heavy algal growths render the *schmutzdecke* too tough for complete removal by backwashing, in which case mechanical rakes are fastened to the side of the gantry to loosen up and remove the filamentous mat from each strip before backwashing.

Of all the cleaning methods available, hydraulic cleaning offers the greatest saving in time and labour. It is not even necessary to drain off the supernatant water, so the time normally taken in this process and in subsequent recharging is saved. One man can clean the largest filter in 9 hours. Since the impurities are washed clear of the sand within the bed itself virtually none of the medium is removed during the process. Hence there is no reduction in sand depth and a smaller initial bed thickness will suffice. An undisturbed depth of 40–60 cm (according to the grain size of the medium) should be allowed below the level of the lances. Thus, if the lances are set to penetrate 20 cm into the filter-bed, the total bed thickness will be only 60–80 cm.

However, apart from the high cost of the equipment involved, the system does have some disadvantages. It is not applicable to existing filters, because the walls have to be strong enough to accept the gantry rails and the filter-beds must be long and narrow if the apparatus is to be economically designed. A much more serious disadvantage is that the system suffers from operational defects that have not as yet been solved.

Firstly, a separation of grains occurs during backwashing, and the finer grains are brought to the surface, thus accelerating filter clogging and shortening the filter runs. Theoretically this disadvantage could be obviated by a better grading of the medium, but in the quantities used the cost would be prohibitive.

Secondly, since the filter is not emptied during cleaning, the environment in the supernatant water reservoir never becomes unfavourable to algal growth. Only some of the algae are removed, and the remainder are left in an active state of division to cause clogging and a further reduction in the length of filter runs.

Thirdly, some of the impurities are actually carried to a greater depth in the filter-bed by the wash water, owing to its unavoidably uneven distribution even when the points of application are as little as 0.3 m apart. The deeper the penetration of the lances the greater this effect is. This problem is the most serious drawback of the method and can result in deterioration of effluent quality. The only real cure would be a period of re-ripening, but this would nullify the main advantage—the speed with which a bed can be returned to service after hydraulic cleaning. Normally, therefore, chlorination of the effluent is relied on to counter any potential dangers from this source, and the “second line of defence” concept, which calls for the addition of chlorine as an *added* precaution, is therefore lost.

Another effect of the uneven distribution of the wash water may be seen by looking at the cleaned filter-bed surface. The position occupied by each lance is now marked by a small crater, within and below which organic impurities accumulate. The oxygen demand in the immediate vicinity of each crater often becomes so high that local anaerobic conditions result and become evident as black spots (caused by iron sulfides).

Choice of cleaning methods

The initial investment required for manual cleaning equipment is negligible, but as mechanization is introduced capital costs rise, becoming fairly high when it is carried out on the scale adopted at the London and Berlin waterworks and reaching a very high figure when travelling bridges are installed to support mechanical scrapers or hydraulic systems. Economic justification for the capital costs involved must obviously depend on the degree to which labour and other costs are reduced. Relevant factors include the reduction in time during which filters are out of service and the improvement in working conditions, which may ease the problem of staff recruitment.

Taking as an example a slow sand filter 2000 m² in area, the following table compares the length of time and numbers of men required to clean it and return it to service, using various methods described. The overnight lowering of the water level in preparation for the removal of the filter from service has not been taken into account. Savings due to mechanization will be somewhat less with smaller filters, rather more with filters of greater area.

COMPARISON OF CLEANING METHODS
Slow sand filter with an area of 2000 m²

	Manual method	Tractor scrapers		Gantry scraper Amsterdam	Hydraulic method
		London	Berlin		
Number of hours required for					
Draining	2	2	2	2	0
Cleaning	9	4	5	3	6
Refilling	5	5	5	5	0
Re-ripening	24	24	24	4	4
Total time out of service (hours)	40	35	36	14	10
Total number of men employed	8	4	2	2	1
Total number of man-hours involved	75	20	15	10	10

It will be noted that a saving of time on the re-ripening period is possible in methods using a travelling bridge (last two columns) because the sand is not contaminated by human contact when men do not actually enter the filter box. As the hydraulic method does not involve draining or refilling a further saving in time is possible.

Manual cleaning requires 75 man-hours of labour, while automatic methods, on average, require only 15. If the filter is cleaned five times a year, the saving in labour through the use of mechanical methods is 300 man-hours per annum. On a plant consisting of 10 similar filters (having a treatment capacity of about 50 million m³/year, and assuming the cost

of employing a labourer to be about US \$2.33 per hour, the saving in money by mechanization would amount to about \$7 000 per year, corresponding to an initial capital outlay of \$70 000 (interest at 6%; amortization period 15 years). This would be ample for mechanization on the lines adopted in London and Berlin, but would be far from enough for the installation of systems using travelling bridges like those in Amsterdam and Paris.

These figures illustrate the way in which comparative calculations can be made, but they are not intended as an accurate picture of the current costs actually prevailing in the countries concerned. It should also be remembered that comparisons between manual and mechanized costs are valid only when the labourers are fully occupied on other useful work when not engaged on filter cleaning. For example the eight labourers required to clean the 10 filters described above would each be employed for some 40 hours per week—a total of about 16 000 man-hours per year for the whole team. Cleaning the 10 filters five times each would require less than 4 000 man-hours per year—about one quarter of their time. Unless there is other genuinely productive work on which these men can be employed during the intervals between cleanings, the true cost comparison (equal to \$280 000 capital outlay) must be even more favourable to mechanization.

Management

The primary objectives of the manager of a water treatment plant will be to maintain a high quality standard of the delivered water at all times, to ensure that the supply is continuous for 24 hours a day and 365 days a year, and to achieve these aims in an economical way.

In general it may be said that some individual (whether or not he is described as a manager, whether he is in charge of one or many waterworks, and whether or not he has other functions unconnected with water supply) must be responsible for the supervision, safety, method of working, and economic running of every treatment plant, however small. Above all someone, somewhere, must think ahead—must recruit and retain an adequate labour force; must prepare for filter cleaning, resanding, and other activities in their due season; must foresee emergencies; must recommend improvements, extensions, or alterations as necessary and in good time to the appropriate financing authority; and must be sufficiently acquainted with the routine running of the plant to be able to ensure that it is being carried out efficiently.

It has been shown that a filter can exhibit individual characteristics that depend on a large number of external circumstances—variations in raw water quality, climatic changes, the biology of its algal population, the care taken during its initial construction, and so on. It is not a machine,

the properties of which can be precisely calculated, but an ecosystem of living organisms the behaviour of which may be forecast only tentatively.

As a basis for making such forecasts, and hence for obtaining the best possible results under varying circumstances, the manager must first of all rely on the history of the individual filter concerned, and secondly on the experience gained with similar plants operating under comparable circumstances. Since it never can be said that the operational conditions of any two separated filters are and always have been precisely similar, the records of each assume an even greater importance as a guide to their future behaviour and capabilities and to the design criteria for new constructions, extensions, and improvements at the same (or comparable) treatment works.

The degree and form of records kept will obviously depend to a great extent on the literacy and ability of the operator. Imbeaux¹ set out what he considered to be essential data necessary to provide a complete history of each filter, and this (after nearly 40 years) still provides an excellent guide to water supply managers. The following are the basic records that he recommended to be kept for every filter:

- (1) The date of each cleaning (commencement of process).
- (2) The date and hour of return to full service (end of the re-ripening period).
- (3) Raw and filtered water levels (measured each day at the same hour) and daily loss of head.
- (4) The filtration rate, and hourly variations, if any.
- (5) The quality of the raw water in physical terms (turbidity, colour) and bacteriological terms (total bacterial count, *E. coli*), determined by samples taken each day at the same hour.
- (6) The same quality factors of the filtered water.
- (7) Any incidents occurring, e.g., plankton development, rising *schmutzdecke*, and unusual weather conditions.

Many modern works are able to provide better data than these, particularly when the automatic recording of head loss, filtration rate, etc. provide a continuous picture. On the other hand, for many of the smaller or more remote treatment plants, daily bacteriological analyses will be impossible. However, even in these plants the manager should insist on records being kept to the extent of the local operator's ability, if only as a guide to the supervisor when making his periodic visits.

In a wisely managed water supply undertaking, critical periods will be anticipated. For instance, it should never be necessary for two filters to be taken out of service for cleaning simultaneously. Such an event would

¹ Imbeaux, E. (1935) *Qualités de l'eau et moyens de correction* [Quality of water and means of correction], Paris, Dunod, pp. 436-495.

put unnecessary strain on the remaining filters, and would fail to make the most economic use of the labour force, whose efficient employment depends on their activities being regularly spaced throughout the year. The situation can be prevented by cleaning some of the filter-beds before it is strictly necessary, and this is especially important immediately before difficult seasons—e.g., when heavy algal blooms are expected, as judged by the records of previous years.

Among the manager's responsibilities is the time distribution of plant operation. The greater efficiency of a filter when working 24 hours a day for 7 days a week has already been discussed, but there are still a number of smaller plants where one or two 8-hour shifts comprise the working day. Many factors enter the economic argument. A filter working round the clock need only be one third the area of one working 8 hours a day (and hence only one third of the cost). On the other hand the clear-water reservoir must be big enough to make up the difference between the lower treatment rate and the demand at peak periods of the day. The number of men required for three-shift working is more likely to depend on the pumping arrangements than on the filter, which can continue during the night hours without attention or with only occasional cursory inspection. Sometimes a filter is designed for future loading on a 24-hour basis but is operated for 8 hours during the initial period of low consumption. Whether it is better to do this or to run it continuously at one third of its designed filtration rate is a matter for local judgement. The decision might well depend on such minor considerations as reduced electricity tariffs for pumping at night or the need for employing for other purposes the staff who would normally keep an eye on the semi-automatic pumping plant.

Filters should be adequately protected against trespass and against intrusion by animals. A supernatant reservoir 1.5 m deep is sufficient to drown adventurous children. Not only should the full site be adequately fenced but the filters themselves should be suitably protected. If night working is expected, lighting and guard rails may be required to protect the staff.

In tropical areas the supernatant water reservoir may be found to contain fish that have either been brought in through the intake or carried in in egg form by birds. If such fish are top feeders like *Tilapia*, no harm ensues—they may in fact be beneficial in keeping down algae and the larvae of gnats or mosquitos.

However, carp and other bottom feeders must be removed as soon as their presence is noticed, either by netting or by temporarily lowering the supernatant water level, otherwise they will disturb the *schmutzdecke* and upper sand layer, through which raw water may then pass without adequate treatment.

6. Slow sand filtration and artificial recharge

As the function of a safe water supply in the prevention of epidemic diseases such as typhoid and cholera came to be generally accepted during the last century, the demand for such supplies grew rapidly, and cities in all parts of the world started to install piped systems. At that time, having no knowledge of the role played by pathogenic bacteria and consequently no conception of the potentialities of chemical disinfection, water suppliers and consumers alike judged water by its physical attributes—absence of turbidity, taste, colour, and odour. It was found that two types of source could provide water that was of good quality according to these criteria; by a fortunate chance it was later shown that supplies obtained from these sources were also those most likely to be free of dangerous bacteria. They consisted of:

- (1) groundwater abstractions, and
- (2) water drawn from clear springs and lakes and subsequently treated by slow sand filtration.

It has been shown in earlier chapters that slow sand filtration embodies many of the natural processes of purification, and this is most evident in the downward percolation of rainwater through porous soil until it reaches and recharges the body of groundwater stored in an aquifer. To what extent this process was understood it is difficult to say, but for many centuries groundwater has been accepted as the purest source for domestic purposes, and it was undoubtedly for this reason that the first choice of early water undertakings was almost always groundwater, as soon as technology had provided a means of abstracting it economically in the quantities required.

With the growth of industry, population, and individual demand, water consumption in the cities rose rapidly and continuously, and by the beginning of the present century many of the groundwater sources were proving inadequate to meet the demand. The effect of industrial pollution on surface waters was already beginning to be felt in the neighbourhood of

the cities looking for extra water, and as yet no methods of removing these pollutants had been devised. Experience with groundwater had been excellent, and so the obvious direction in which to attempt to improve supplies lay in augmenting the yield of the proven aquifers. This led, in 1897, to the first application of artificial recharge by Richert for the water supply of the city of Göteborg in Sweden. He was able to augment the amount of water entering the aquifer, giving a corresponding increase in the quantity abstracted with no deterioration in quality.

Methods of artificial replenishment

Since that time many successful projects for the augmentation of underground supplies have been carried out. In general these have fallen into two categories:¹

(1) Artificial recharge, by spreading surface water over pervious soils in basins, ponds, or ditches, by flooding less pervious areas, or by injecting water directly into the aquifer through wells, shafts, or pits.

(2) Induced recharge, by abstracting groundwater from sites close to surface water bodies having pervious banks or beds, thus lowering the subsurface water table in the vicinity and stimulating an increased downward flow from the surface water into the ground.

FIG. 41. INDUCED RECHARGE WITH A LINE OF WELLS PARALLEL TO A STREAM

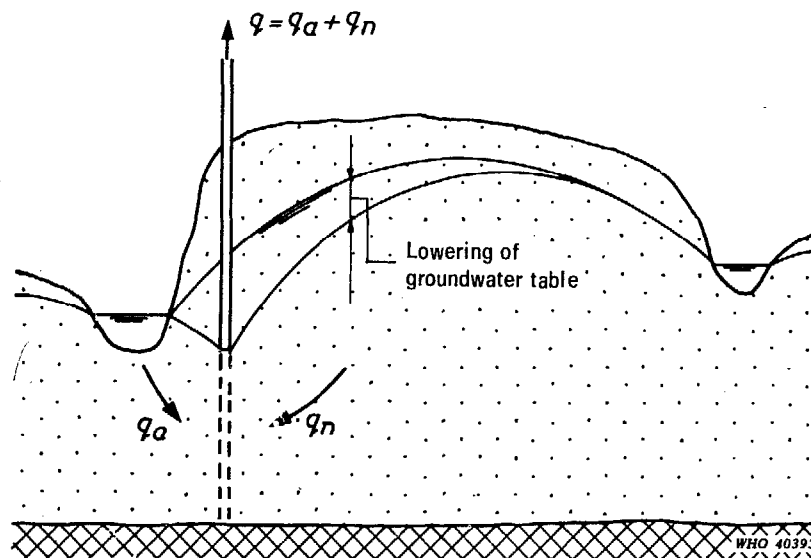

¹ Huisman, L. (1965) *Artificial replenishment*. In: *International Water Supply Association, Sixth Congress Stockholm, 1964*, London, International Water Supply Association, vol. 1, p. J1.

Induced recharge often occurs unintentionally wherever a stream crosses a catchment in which the groundwater table has been lowered by subsurface abstraction. For planned induced recharge, the collectors are deliberately set near to and parallel to the course of the stream (Fig. 41). To obtain the best results the distance between the watercourse and the collectors must be chosen with care. They must be sufficiently close together to ensure that groundwater tables are not lowered over a wide area to the prejudice of agricultural and other interests. At the same time the inflow and abstraction must be far enough apart to ensure that the recharging water travels a sufficient distance and remains within the ground a sufficient length of time for natural purification to take place. Spacing too closely could lead to short circuiting of this natural process.¹

In artificial recharge, water from another source, often from a river or other body a considerable distance away, is conveyed to the point at which aquifer replenishment is required, where it is allowed to percolate downwards through the ground or is directly injected if the soil overlying the aquifer is impervious. If the pervious material of the aquifer continues upwards to the surface, the recharge water can be fed into spreading basins, which may consist of ditches parallel to the collectors when the transmissibility of the water-bearing strata is low (Fig. 42 and 43), or of ponds

FIG. 42. ARTIFICIAL RECHARGE

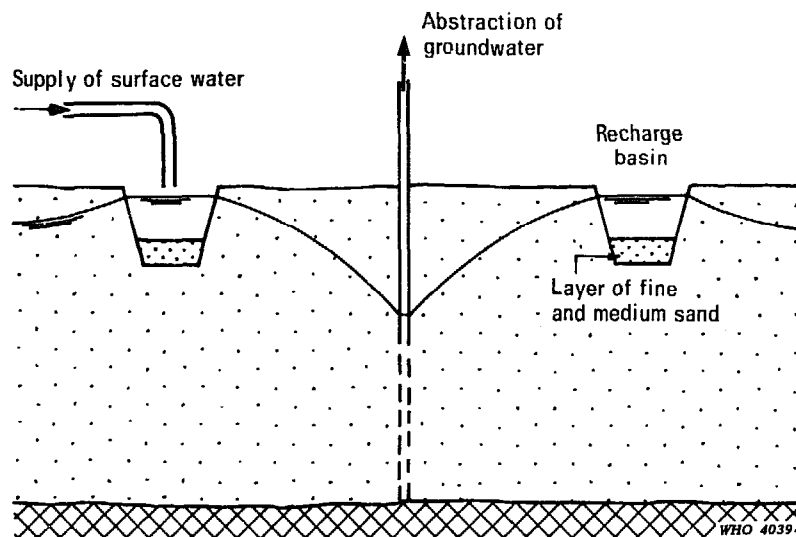

at greater distances from the collectors when the transmissibility is high (Fig. 44).

Where the aquifers are "confined", i.e., where there is an impervious

¹ Huisman, L. (1967) *Artificial recharge for public water supplies in urbanized regions*. In: *International Association of Scientific Hydrology, Symposium, Hajta, 1967*, Gentbrugge, International Association of Scientific Hydrology (IASH Publication No. 72), p. 200.

FIG. 43. ARTIFICIAL RECHARGE WITH DITCHES

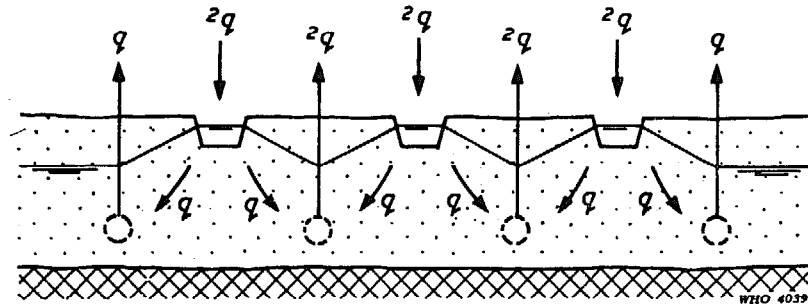
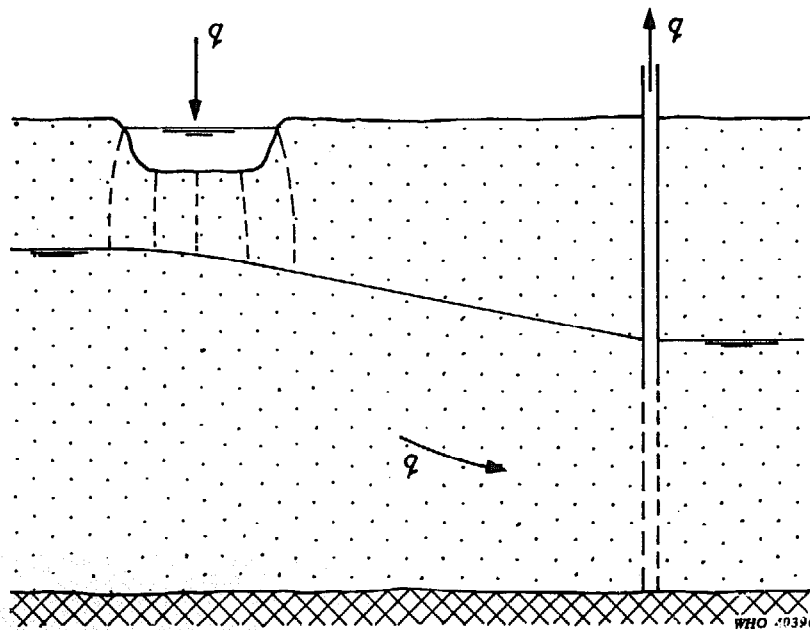

FIG. 44. ARTIFICIAL RECHARGE WITH PONDS



layer above the water-containing strata, the same method may be used only when the impervious material is sufficiently thin to permit full penetration by the spreading basins (Fig. 45), otherwise a well, shaft, or pit must be used to reach the aquifer (Fig. 46). In either case adequate separation of inflow and outflow must be maintained or the quality of the water will suffer.¹ Provided that the recharge system is carefully designed and that the quantities of replenishment water introduced are within the transmission capacity of the subsoil, the groundwater table outside the immediate area of withdrawal will be unaffected.

¹ Huisman, L. & van Haaren, F.W.J. (1967) *Treatment of water before infiltration and modification of its quality during its passage underground*. In: *International Water Supply Association, Seventh Congress, Barcelona, 1966*, London, International Water Supply Association, vol. 1, p. G1.

FIG. 45. ARTIFICIAL RECHARGE WITH SPREADING BASINS

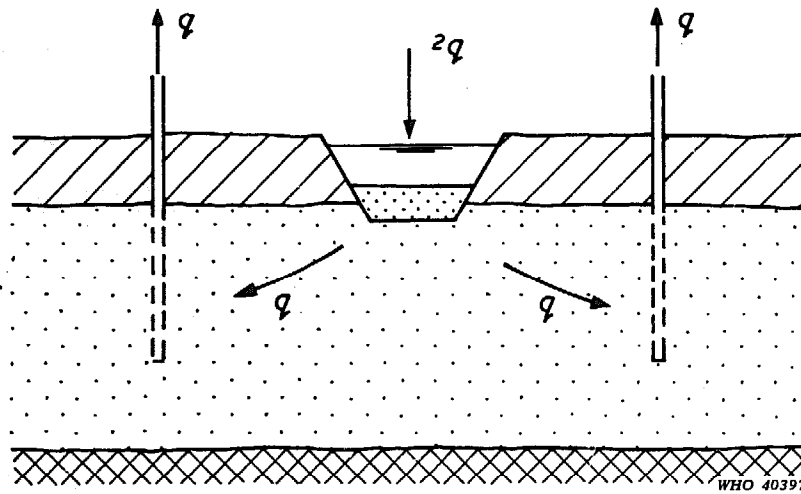

Induced recharge has always suffered from a declining capacity as the surface of the pervious ground in contact with the water source (e.g., the bed and banks of a stream or lake) becomes choked with suspended matter. Some natural scouring takes place when a stream is in spate, but this is often prevented by the introduction of measures of flow control (such as impounding dams or weirs) designed to improve the regularity of the replenishment. Now that persistent and nondegradable pollutants of

FIG. 46. ARTIFICIAL RECHARGE WITH WELLS AND SHAFTS

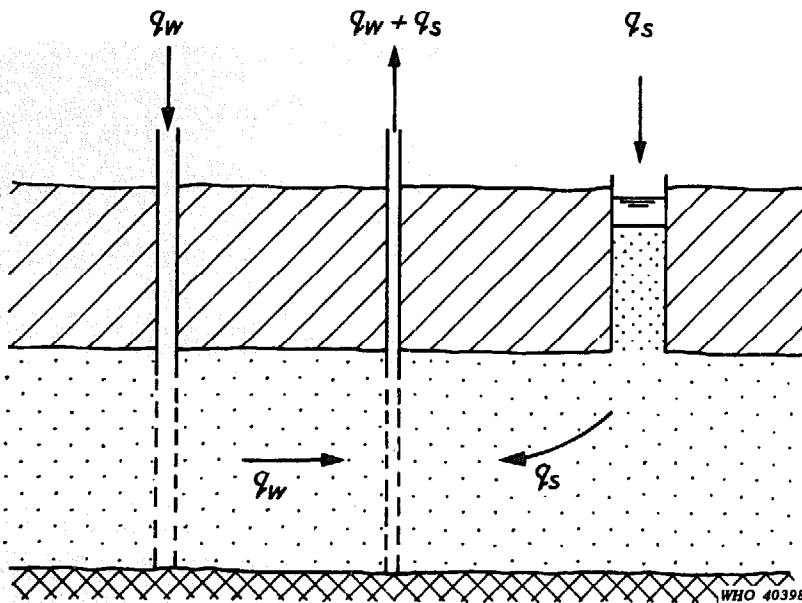

domestic and industrial origin are present in most rivers in the vicinity of cities (where induced recharge is most likely to be called for), this method of replenishment is becoming less widely practised because it is impossible to control the quality of the inflow to the aquifer and there is thus a possibility that the groundwater reserves will become polluted.

The water used for artificial recharge, on the other hand, can be treated before being fed into the aquifer. The treatment may take the form of aeration and the removal of oxygen-consuming organic compounds by conventional filtration (with or without the application of chemicals), so that fully aerobic conditions may be maintained throughout the recharge process, including the period during which the water is within the aquifer. Should the river-water being used as a source for replenishment be found to contain poisonous substances that cannot be removed by the pretreatment processes, it is possible to discontinue artificial recharge until the position is rectified, while continuing to use the groundwater present in the aquifer as a source of supply. Induced recharge, on the other hand, cannot be stopped as long as abstraction is taking place, and the only way to prevent pollutants from being drawn into the aquifer is to stop withdrawal altogether—a remedy often impossible to adopt without seriously interrupting the supply to the public.

Hence induced recharge is nowadays little practised in densely populated and industrial areas and is restricted to the vicinity of streams of consistently good quality that normally exist only in remote areas. Where induced recharge has to be abandoned because of deteriorating quality of the source water, it is sometimes possible to convert the process to artificial recharge through controlled injection points, as illustrated in Fig. 47.

FIG. 47. ARTIFICIAL RECHARGE REPLACING INDUCED RECHARGE

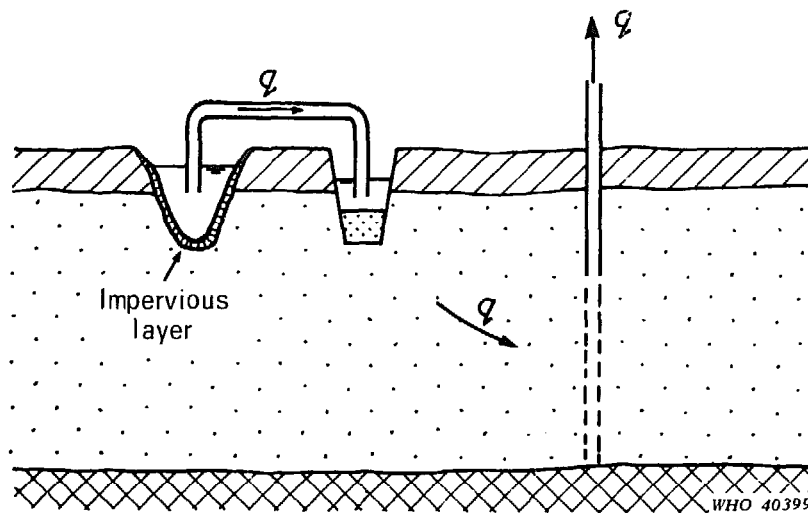

WHO 40399

An additional factor to be considered is that the naturally occurring and the artificially introduced waters within an aquifer must be chemically compatible. The rather complex investigations involved in ensuring this condition are outside the scope of the present publication, but it should be noted that they may call for pretreatment of the recharge water, especially when it has been brought from a different source from that naturally supplying the aquifer.

Slow sand filtration in artificial recharge

The purpose of artificial recharge is to increase not only the volume of the replenishment water but its rate of transfer from surface to aquifer. In the natural process, the very slowness and limited quantities involved in this transfer mechanism serve as a protection against the development of clogging and other undesirable conditions in the water-bearing strata. The artificial intensification of this mechanism thus calls for a parallel supplement to the natural purification process. When the recharge water is to be injected into a confined aquifer through wells or shafts it must be given full pretreatment by conventional methods to achieve a quality equal to that expected in the abstracted water. When spreading basins or similar devices are used as replenishment points it is possible to combine treatment and recharge by incorporating slow sand filters into the basins themselves.

This is accomplished by covering the bottoms of the basins with a layer of sand 0.5–1.0 m thick, having a grain size distribution equal to, or slightly coarser than, the slow sand filters described in earlier chapters. The sand must be sufficiently coarse to prevent its grains from being carried into the material of the aquifer with which it is in contact and fine enough to prevent deep penetration of the impurities contained in the raw water. If the grading is correct the sand-bed will function in precisely the same way as the bed of a conventional slow sand filter, the impurities will collect and undergo treatment on and immediately below the bed surface, from which they can be removed in a similar way at the end of the filter run. As the filtration rates are normally considerably lower (0.01–0.1 m/h) than those in conventional filters, the treatment efficiency is high and filter runs are usually long. The effluent from the bed percolates downwards into the aquifer instead of into a filter drainage system, and since it then has to travel over a considerable horizontal distance (usually more than 50 m) its detention time may be measured in days, weeks, or even months instead of in hours.

Precautions must be taken against subsequent pollution while the treated water is flowing through the ground strata. With confined aquifers this presents little difficulty, since the overlying impervious strata will

prevent downward percolation of contaminating substances, but in the case of unconfined aquifers a strict control of activities on the surface between the inflow and abstraction points may be necessary.

Artificial recharge in the Ruhr

A practical example of artificial recharge of a confined aquifer, using slow sand filters adapted as spreading basins, is provided in the Ruhr district of the Federal Republic of Germany (Fig. 48). At first a system of

FIG. 48. ARTIFICIAL RECHARGE IN THE RUHR DISTRICT

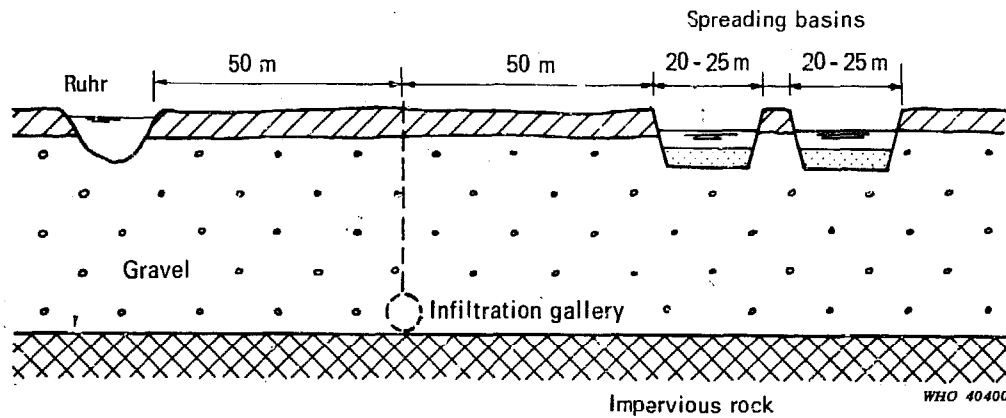

induced recharge was installed, based upon a series of galleries and lines of vertical wells constructed parallel to, and some 50 m away from, the River Ruhr, but owing to the construction of impounding reservoirs in its tributaries, the bed became progressively more clogged until infiltration became negligible.

It was therefore decided to convert the system to one of artificial recharge, and two spreading basins with sand-bed bottoms were constructed at a distance of 50 m on the other side of the gallery. They were fed by river water and delivered their effluent into the gravel layer that lies below the confining impervious topsoil. At the beginning of the filtration run, the water level in the basins is some distance below the level of the river (which is itself kept reasonably constant by weirs). As the resistance in the beds builds up through clogging, the infiltration rate is kept at its designed value by increasing the depth of supernatant water in the basins until no more gravity flow from river to basins is possible. The influent pipe is then closed and the water level drops to below the surface of the sand-bed, which is cleaned in the same way as is a conventional slow sand filter. Reference

has been made in the preceding chapter to the mechanical equipment used in this cleaning process. One of the twin basins is always kept operating while the other is being cleaned, so that recharge is continuous.

A few years ago, despite efforts to maintain the quality of water in the river, some contamination occurred and the quality deteriorated. In particular there was an increase in oxygen-consuming organic compounds,

FIG. 49. ARTIFICIAL RECHARGE WITH PREFILTRATION

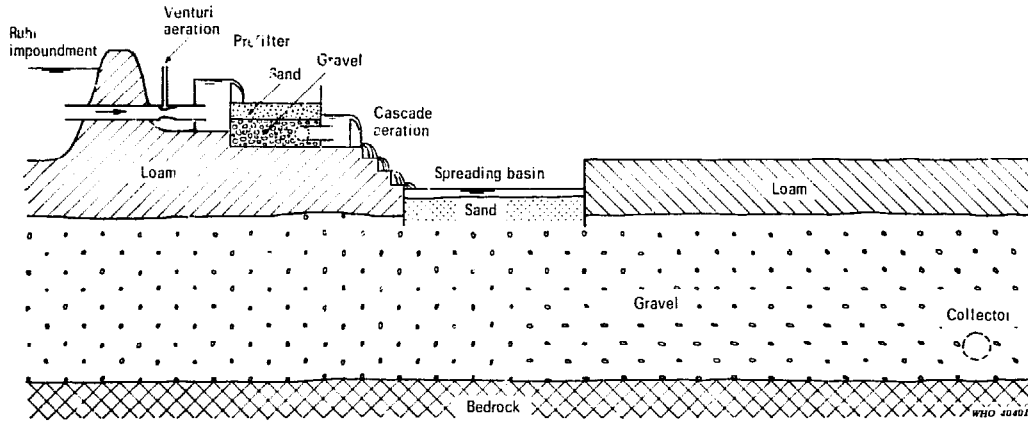
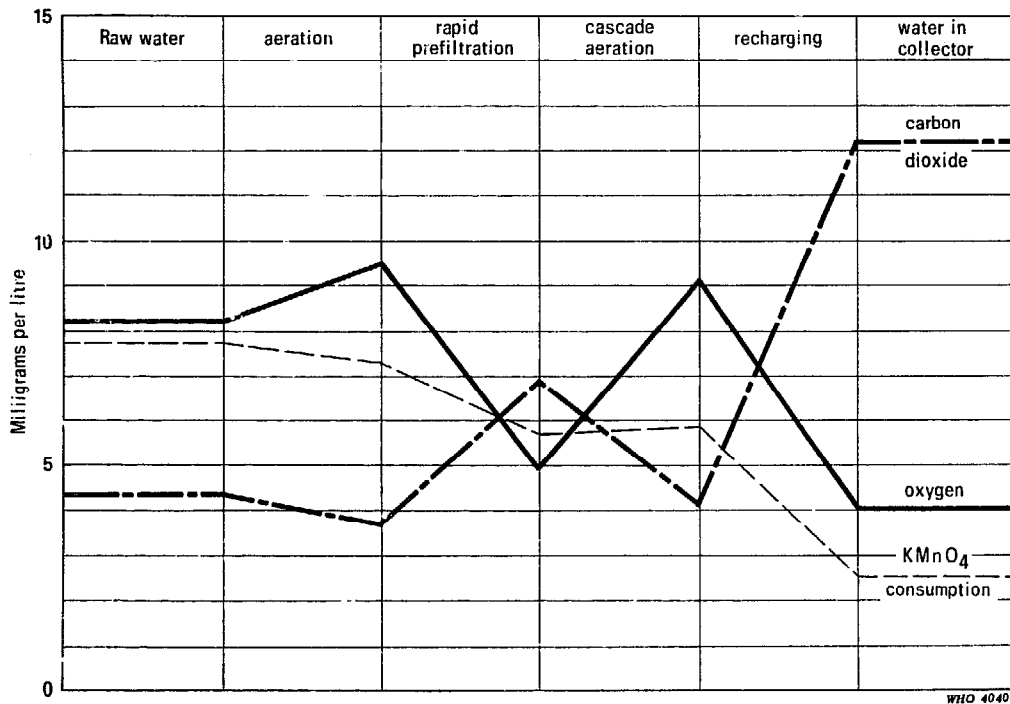

FIG. 50. CHANGES IN THE COMPOSITION OF THE WATER DURING EACH STAGE OF THE TREATMENT ILLUSTRATED IN FIG. 49



which threatened to lower the oxygen content of the effluent from the spreading basins and cause anaerobic conditions to develop in the aquifer, so dissolving iron and manganese from the subsoil. The effect of this sequence would have been to necessitate treatment of the abstracted water by aeration and refiltration, thus defeating the whole purpose of slow sand filtration in the artificial recharge process. Accordingly the simpler expedient of pretreatment (Fig. 49) was adopted. In this system the oxygen content of the raw water is increased by aeration and its oxygen demand decreased by filtration, which removes part of the oxygen-consuming impurities. The improvement in the quality of the water at various stages may be seen in Fig. 50.

Reduction of salt content

One of the problems associated with the pollution of streams and rivers with domestic or industrial wastes is the continuous rise in the content of inorganic salts. These salts are stable and unaffected by conventional water treatment processes, including filtration. Common salt (NaCl) is normally the most ubiquitous and, while in reasonable concentrations it cannot be rated as harmful to the consumer, it can nevertheless render a water supply unpalatable and unsuitable for many industrial purposes. It is, moreover, an indicator of the possible presence of other less innocuous inorganic compounds that may have originated from the same source of pollution.

In the years 1960–64, the River Rhine, which receives direct and indirect discharges from the numerous industrial plants along its banks, had a salt load averaging no less than 270 kg of chloride per second in an average river flow of 2 200 m³/s—i.e., an average chloride (Cl⁻) content of 123 mg/l. In the course of the year the river flow varies from a maximum in winter and spring to a minimum in summer and autumn, so that while the amount of chloride remains reasonably constant the concentration fluctuates considerably. Fig. 51 illustrates the variation in chloride concentration during normal years and during a particularly dry summer, such as may be expected to occur once in 10 years.¹ It will be seen that maximum concentrations of 230 and 320 mg/l occurred in the normal and the dry years respectively, and that the commonly accepted limit of 150 mg/l was exceeded during 4½ months of a normal year and 9½ months of a dry year. The level at which undesirable taste and corrosion effects manifest themselves (200 mg/l) was exceeded during 2 and 5 months in the normal and the dry year respectively. Today the chloride flow is in the

¹ Martijn, Th. G. (1967) *Water*, 51, 76.

FIG. 51. VARIATION IN THE CHLORIDE CONTENT OF THE RIVER RHINE IN NORMAL AND DRY YEARS

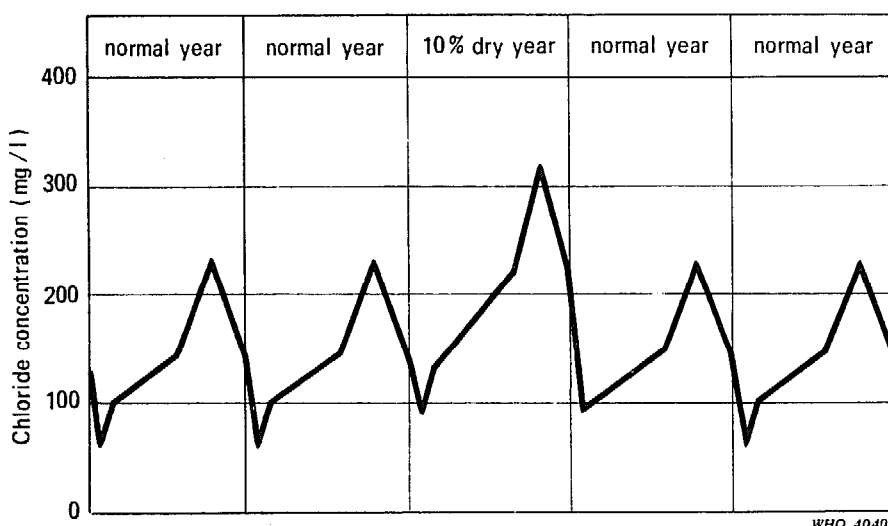

WHO 40403

neighbourhood of 360 kg/s, and the other figures exhibit a corresponding deterioration.

In the Netherlands, water from the River Rhine has to be used for public supplies, but when the chloride content is above about 200 mg/l it is unsuitable for this purpose. To reduce the salt concentration by desalination methods would be prohibitive in cost, even if electro dialysis were used to make a limited reduction only. A more economical solution is the mixing of water extracted at different times of the year, thus smoothing out extreme variations in quality, but in view of the great quantities extracted annually to supply this populous region the only way in which this can be done is to perform the mixing and storage in the immense reserves that lie underground.

The method of accomplishing this is artificial recharge, with varying distances between the influent and abstraction points, so spaced that the length of time within the aquifer (which varies according to the distance travelled by the water below ground) can be planned in advance. Fig. 52 shows the resultant fluctuation in chloride content in the abstracted water over a succession of normal years, interrupted by a dry year. Comparison with Fig. 51 will show how the extremes of quality variation have been smoothed out, making the resulting water acceptable for use in public supplies. When the difference between maximum and minimum detention times has values of $\frac{1}{2}$, 1, and 2 years, the highest chloride contents become 248 mg/l, 200 mg/l, and 173 mg/l respectively—a very considerable improvement on the quality of the river-water during the same periods.

Increasing the detention time from a few days (as in the Ruhr recharge illustrated in Fig. 48) to months or years is not necessarily

expensive when abstraction points and pumping equipment already exist. The natural recharge of the groundwater reserves is the amount of rainfall percolating to the aquifer (i.e., the total precipitation less evaporation losses), which in the Netherlands normally amounts to about 0.3 m/year, so that the normal yield of the underground catchment is limited to about 0.3 million cubic metres per year for each square kilometre of surface area.

FIG. 52. VARIATION IN THE CHLORIDE CONTENT OF WATER FROM THE RIVER RHINE AFTER RECHARGE, WITH PLANNED VARIATION OF UNDERGROUND DETENTION TIME

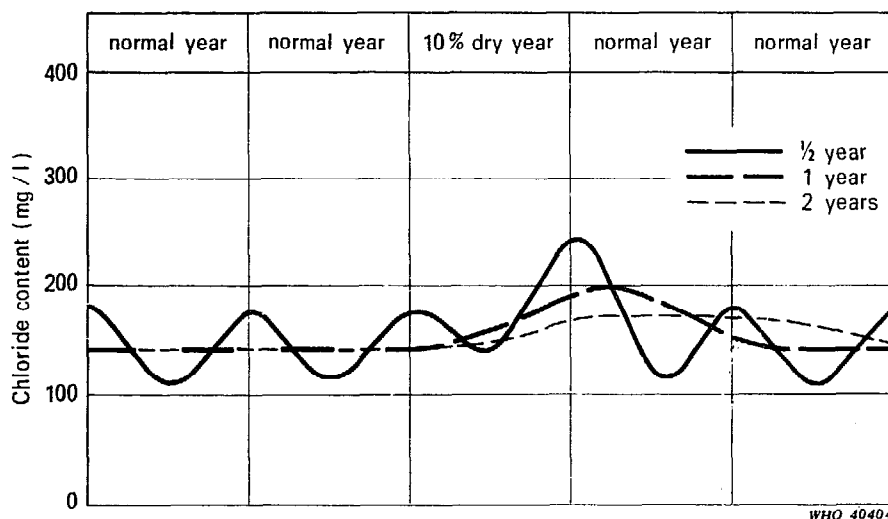

The curves show the effect of differences between maximum and minimum detention times of 1/2 year, 1 year, and 2 years.

With, for example, an aquifer thickness of 50 m and a porosity of 30%, the amount of groundwater stored in the pores of the water-bearing strata is 15 million m³ per square kilometre of surface area. Thus the use of artificial recharge with an average retention period of 6 months makes available a capacity of 30 million m³/year/km²—no less than 100 times the yield originating from rainfall over the same area.

For densely populated, heavily industrialized areas where surface waters are polluted and alternative sources nonexistent or prohibitive in cost, artificial recharge on the lines described may prove the best solution to the problem of maintaining an ample water supply of acceptable quality, provided that the geology of the area is favourable to underground storage. The principle is also capable of extension to other types of water-short areas where appropriate aquifer conditions exist.

Annex 1

MAXIMUM VARIATION IN PIEZOMETRIC LEVEL IN A TYPICAL UNDER-DRAINAGE SYSTEM

The accompanying figure shows the layout of a typical under-drainage system. The maximum variation in piezometric level of the filtered water occurs between points A and G of the bed. If, for simplicity, the turbulence in passing from point G to point H is omitted from the calculation, the variation in piezometric level is seen to be made up of three components:

- (1) the resistance due to the subsurface flow of water from A to B through the layer of gravel surrounding the drain,
- (2) the resistance and conversion of static head into velocity head as the water flows through the lateral drain from B to C, and
- (3) the resistance and conversion of static head into velocity head as the water flows through the main drain from D to H.

Component (1)

The pressure losses due to component (1) may be calculated on the basis of Darcy's law, the resistance H_1 being obtained from the formula:

$$H_1 = \frac{1}{2kh} \times v_f \times \left(\frac{a}{2}\right)^2$$

where v_f = filtration rate
 a = distance between centres of lateral drains
 k = coefficient of permeability of the gravel surrounding the lateral drains
 h = thickness of gravel surround.

With gravel of 5 mm diameter, k is about 700 m/h (assuming 40% porosity). When h is 0.15 m, kh is approximately 100 m²/h. With a high filtration rate of 0.5 m/h (to consider an extreme condition) and an interval between lateral drains of 1.5 m as shown in the figure, the resistance

$$H_1 = \frac{1}{2 \times 100} \times 0.5 \times \left(\frac{1.5}{2}\right)^2 = 0.0014 \text{ m} = 1.4 \text{ mm.}$$

Component (2)

The losses due to component (2) are calculated in the following way. In the lateral drain, length l , the flow increased linearly from B to C to a maximum value Q equal to the area drained multiplied by the rate of filtration, i.e.:

$$Q = a \times l \times v_f = 1.5 \times 10 \times 0.5 = 7.5 \text{ m}^3/\text{h} = 2.08 \times 10^{-3} \text{ m}^3/\text{s.}$$

A lateral drain 8 cm in diameter has a cross-sectional area of $5.03 \times 10^{-3} \text{ m}^2$, so that the velocity of water in the drain at C is:

$$v = Q/A = (2.08 \times 10^{-3}) / (5.03 \times 10^{-3}) = 0.414 \text{ m/s,}$$

and the velocity head is:

$$v^2/2g = 8.7 \times 10^{-3} \text{ m (since } g = 9.81 \text{ m/s}^2\text{).}$$

Given a linear increase in velocity from B to C, the resistance offered by a pipe of diameter d and length l is:

$$\frac{1}{3} \times \lambda \times \frac{l}{d} \times \frac{v^2}{2g}$$

where λ is the friction factor—a quantity obtained from Colebrook's formula: $1/\lambda = 2 \log (K/3.7d) + (2.51/R_e \sqrt{\lambda})$, in which K is the roughness of the pipe and R_e is the Reynolds number (derived from the kinematic viscosity at the particular temperature under consideration, the velocity of

CALCULATION OF THE LOSSES ACCOMPANYING THE FLOW OF WATER THROUGH
THE UNDER-DRAINAGE SYSTEM

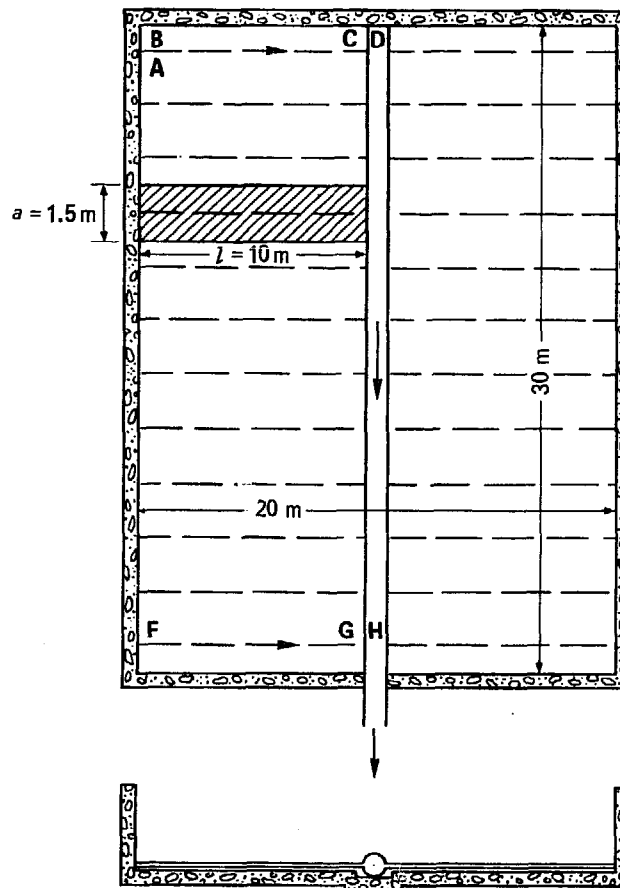

flow, and the diameter of the pipe). Since the Reynolds number varies with the velocity of flow, λ also varies along the length of the pipe. For a temperature of 10°C and a pipe roughness of 0.25 mm, λ ranges from 0.04 at one end of the pipe to 0.03 at the other, the average being about 0.033.

Thus, the resistance offered by the pipe is:

$$\frac{1}{3} \times 0.033 \times \frac{10}{0.08} \times \frac{v^2}{2g} = 1.37 \times \frac{v^2}{2g}$$

to which must be added a factor of $2v^2/2g$ representing the pressure loss due to the conversion of static head outside the drain to velocity head inside. This gives as the total change in piezometric level over the length BC:

$$H_2 = 3.37 \times v^2/2g = 3.37 \times 8.7 \times 10^{-3} \text{ m} = 30 \text{ mm.}$$

Component (3)

The losses due to component (3), i.e., the fall in piezometric level due to the flow from D to H, may be calculated in a similar way. In the example under consideration (see figure), where the length l of the main drain is 30 m, the diameter d of the drain is 0.5 m, the width of the filter-bed is 20 m, and the filtration rate v_f is 0.5 m/h, the following quantities are readily calculated:

$$\begin{aligned} \text{quantity carried, } Q &= \text{area of filter-bed multiplied by filtration rate} \\ &= 20 \times 30 \times 0.5 = 300 \text{ m}^3/\text{h} = 8.33 \times 10^{-2} \text{ m}^3/\text{s} \\ \text{cross-sectional area of drain, } A &= 19.6 \times 10^{-2} \text{ m}^2 \\ \text{velocity of flow, } v &= Q/A = (8.33 \times 10^{-2})/(19.6 \times 10^{-2}) = 0.425 \text{ m/s.} \end{aligned}$$

The friction factor λ , obtained from Colebrook's formula, varies from 0.04 to 0.019, with an average value of 0.026. Thus, the resistance of the pipe over the length DH is:

$$\frac{1}{3} \times 0.026 \times \frac{30}{0.5} \times \frac{v^2}{2g} = 0.52 \times \frac{v^2}{2g}$$

to which must be added a further $2v^2/2g$ to convert the static head into velocity head. The total loss in piezometric level over the length DH then amounts to:

$$H_3 = 2.52 \times v^2/2g = 2.52 \times 9.2 = 23 \text{ mm.}$$

The total pressure loss between A and G is now seen to be:

$$H_1 + H_2 + H_3 = 1.4 + 30 + 23 = 54.4 \text{ mm} = 0.054 \text{ m.}$$

In order that the variation over the area of the filter may be kept within an acceptable limit, say 10%, the total loss should not exceed 10% of the resistance of the filter-bed when at its lowest (i.e., when the sand is clean at the start of a filter run and when the bed is at its minimum thickness after repeated scrapings).

Under these conditions, with a depth of sand h of 0.75 m and a filtration rate v_f of 0.5 m/h, the filter-bed resistance H for a coefficient of permeability k is given by:

$$H = v_f h / k = 0.5 \times 0.75 / k = 0.375 / k.$$

If the maximum under-drainage losses (0.054 m) are to be kept within 10% of this value:

$$0.054 < 0.1 \times 0.375 / k, \text{ or } k < 0.7 \text{ m/h.}$$

To obtain a coefficient of permeability of this value, a filter sand with an effective diameter of less than 0.15 mm is called for. If the sand is coarser than this, it will be necessary either to increase the diameters of the lateral and main drains or to lay the lateral drains more closely together. Since the variation in piezometric level is inversely proportional to between the fourth and fifth power of the pipe diameter, a small increase in the latter will make a large reduction in the head lost by the flowing water. It is therefore the remedy most commonly adopted. Similar measures will be necessary if it is desired to restrict the variation in filtration rate to a lower value than 10% (5% above and below average), but in view of the relatively small influence of filtration rate on effluent quality this precaution is seldom required.

Annex 2

PIEZOMETRIC LEVEL IN AN UNDER-DRAINAGE SYSTEM CONSTRUCTED WITH STANDARD BRICKS

There is a tendency today to use drainage systems other than pipes, except for the smallest filters. Fig. 10a (page 56) shows one of the simplest of such arrangements, using standard bricks to support the medium and to provide drainage space. If the dimensions of the bricks are $5 \times 11 \times 22$ cm, each channel drains a strip 23 cm wide and has the following hydraulic characteristics:

$$\begin{aligned}\text{Cross-sectional area } A &= 0.11 \times 0.18 = 1.98 \times 10^{-2} \text{ m}^2 \\ \text{Wetted perimeter } P &= 2 \times (0.11 + 0.18) = 0.52 \text{ m} \\ \text{Hydraulic diameter } d &= 4 A/P = 4 \times 1.98 \times 10^{-2} / 0.52 = 0.152 \text{ m}.\end{aligned}$$

If an under-drainage system of this kind is used for the filter-bed shown in Fig. 9b (page 55), the length of the filter-bed being 60 m and the filtration rate being 0.5 m/h, the loss in piezometric level over the length of one channel may be calculated as follows:

$$\begin{aligned}Q &= 0.5 \times 60 \times 0.23 = 6.9 \text{ m}^3/\text{h} = 1.92 \times 10^{-3} \text{ m}^3/\text{s} \\ v &= Q/A = (1.92 \times 10^{-3}) / (1.98 \times 10^{-2}) = 0.097 \text{ m/s} \\ \lambda &= 0.04 \text{ (from Colebrook's formula assuming a roughness of 1 mm and a temperature of } 10^\circ\text{C)}\end{aligned}$$

$$\text{Thus resistance} = \frac{1}{3} \times 0.04 \times \frac{60}{0.152} \times \frac{v^2}{2g} = 5.3 v^2/2g.$$

When the addition of $2v^2/2g$ is made for the conversion of static head into velocity head, the total head loss becomes $7.3 \times v^2/2g = 7.3 \times 0.48 = 3.5$ mm.

In such a large filter the main drain will be constructed in concrete and will probably be large enough to allow workmen to enter. A drain of this size involves a very low velocity of flow, and the drop in piezometric level will be less than 1 mm, thus giving a total head loss for the whole drainage system of $3.5 + 1.0 = 4.5$ mm.

With, as in Annex 1, a filtration rate of 0.5 m/h and a depth of sand-bed of 0.75 m, the variation in filtration rate throughout the filter-bed will be less than 10% when k is less than 8 m/h, or d_{10} is less than 0.45 mm. This requirement will nearly always be fulfilled, but it is nevertheless still good practice to check the hydraulic characteristics of the under-drainage system in every design. Other variations of the same principle are possible, and the engineer may exercise his ingenuity in devising the most suitable and economic system in the light of the materials locally available.

SELECTED BIBLIOGRAPHY

- Berend, J.E. (1971) *Clogging processes and optimisation of basin recharge*. In: *Conference on artificial groundwater recharge, Reading, 1970*, Medmenham, The Water Research Association
- Bize, J., Bourguet, L. & Lemoine, J. (1972) *L'alimentation artificielle des nappes souterraines*, Paris, Masson
- British Standards Institution (1960) *British standard code of practice for the design and construction of reinforced and pre-stressed concrete structures for the storage of water and other aqueous liquids*, London, (CP 2007)
- Cox, C.R. (1964) *Operation and control of water treatment processes*, Geneva (*World Health Organization: Monograph Series*, No. 49)
- Frank, W.H. (1969) Recherches récentes sur la recharge des eaux souterraines par des filtres à sable opérant lentement et application pratique des résultats [Recent research on the recharging of ground waters by slow sand filters and the practical application of the results], *Terres et eaux*, **22**, 19.
- Hagel, G. von (1964) *Neue Ergebnisse zum Problem der Dekontaminierung von Oberflächenwasser in Langsamsandfiltern* [Recent findings concerning the purification of surface water in slow sand filters], Dortmund, Hydrological Research Department of the Dortmunder Stadtwerke AG
- Hespanhol, I. (1969) *Investigação sobre o comportamento e aplicabilidade de filtros lentos no Brazil* [Study on the performance and applicability of slow filters in Brazil], University of São Paulo
- India, Central Public Health Engineering Research Institute (1971) Survey of water treatment plants, *Techn. Dig. (Nagpur)*, No. 13
- Moravcová, V. (1971) Algal growth in slow sand filters and consequent clogging, *Wat. Treat. Exam.*, **20**, 245-252
- Pearsall, W.H., Gardiner, A.C. & Greenshields, F. (1946) *Freshwater biology and water supply in Britain*, Ambleside, Freshwater Biological Association (Scientific Publication No. 11)
- Pollitzer, R. (1959) *Cholera*, Geneva. (*World Health Organization: Monograph Series*, No. 43)
- Schmidt, K. (1972) *Intermittierender Betrieb von Langsamsandfiltern zur künstlichen Grundwasseranreicherung* [Intermittent use of slow sand filters in the artificial recharging of groundwater], Dortmund, Dortmunder Stadtwerke AG (Report No. 118)
- Skeat, W.O., ed. (1961) *Manual of British water engineering practice*, 3rd ed., London, The Institution of Water Engineers
- Stuhlmann, F. (1972) *Studien zum Verhalten stickstoffhaltiger Wasserinhaltsstoffe bei der Langsamsandfiltration* [Studies on the behaviour of nitrogenous substances in slow sand filtration], Dortmund, Water Research Institute and the Hydrological Research Department of the Dortmunder Stadtwerke AG (Publication No. 10)
- Wagner, E.G. & Lanoix, J.N. (1959) *Water supply for rural areas and small communities*, Geneva, (*World Health Organization: Monograph Series*, No. 42)
-

LIST OF REVIEWERS

- Dr R.G. ALLEN, Director, The Water Research Association, Medmenham, Bucks., England
- Mr J.A. ANDU, General Manager, Western Nigeria Water Corporation, Ibadan, Nigeria
- Mr C.K. ANNAN, Managing Director, Ghana Water and Sewerage Corporation, Accra, Ghana
- Mr Jorge ARBOLEDA, Adviser on Water Treatment, Pan American Center for Sanitary Engineering and Environmental Sciences, Lima, Peru
- Professor S.J. ARCEIVALA, WHO Visiting Professor of Sanitary Engineering, Middle East Technical University, Ankara, Turkey
- Professor J.M. de AZEVEDO NETTO, Professor of Sanitary Engineering, University of São Paulo, Brazil.
- Mr Richard F. COLE, Director, International Program in Sanitary Engineering Design, Department of Environmental Sciences and Engineering, School of Public Health, University of North Carolina, Chapel Hill, N.C., USA
- Dr Hamid Ibrahim HAMID, Head, Civil Engineering Department, Faculty of Engineering and Architecture, University of Khartoum, Sudan
- Ing. Ivanildo HESPANHOL, Professor of Sanitary Engineering, University of São Paulo, Brazil.
- Professor G. van R. MARAIS, Professor of Water Resources and Public Health Engineering, Department of Civil Engineering, University of Cape Town, South Africa
- Mr M.S. MARZOUK, formerly Chairman, Alexandria General Water Authority, Alexandria, Egypt.
- Professor D. MINTZ, Director, Municipal Water Supply and Sewage Research Institute, Academy of Municipal Economy, Moscow, USSR
- Dr G.J. MOHANRAO, Scientist-in-Charge, Central Public Health Engineering Research Institute, Nagpur, India
- Professor M.B. PESCOD, Chairman, Division of Environmental Engineering, Asian Institute of Technology, Bangkok, Thailand
- Mr S. RAJAGOPALAN, Consulting Public Health Engineer, New Delhi, India
- Mr Rodolfo SÁENZ, WHO/PAHO Sanitary Engineer, Quito, Ecuador
- Dr-Ing. K.E. SCHICKHARDT, German Society of Gas and Water Engineers, Frankfurt am Main, Federal Republic of Germany
- Mr Edmund G. WAGNER, Engineer, United States Agency for International Development, Rio de Janeiro, Brazil

Additional background information used in the preparation of this publication was provided by the following:

- Mr M. DURAIRAJAN, Chief Engineer, Tamil Nadu Water Supply and Drainage Board, Madras, India
- Mr Chumpol RUGPRATUM, Director, Community Water Supply Project, Ministry of Public Health, Bangkok, Thailand
- Mr S.G. SERDAWELY, WHO Regional Adviser, Paramaribo, Surinam

INDEX

- Access to filters, 47, 51
- Activated carbon layer, 54
- Adduction line, 64, 69
- Adhesion, 31
- Adsorption, 21, 43
- Aeration, 13, 75
 - as pretreatment process, 45, 108
- Air binding, 42
- Air pockets, 70
- Algae, absorption of nutrients by, 20
 - as cause of choking of filter, 24, 35
 - beneficial effects, 36
 - by-products of metabolism in effluent, 44
 - dead, liberation of carbon dioxide from, 34
 - as source of etheric oils, 35
 - effect of different species on filter resistance, 36-37
 - effect of massive mortality, 35-36
 - effect on bacteria, 36
 - effect on filters, 34-38
 - inhibition of growth of, 74
 - liberation of oxygen by, 20, 24, 34
 - removal by microstrainers, 74
 - suppression by chemical treatment, 74
- Amino acids, conversion into simple compounds, 32
- Ammonia, effect of temperature on oxidation of, 33
 - liberation in biochemical reactions, 32
 - presence in effluent, 76
- Anaerobic conditions, 32, 82
 - prevention, 75
- Analysis of samples, 45, 75, 77
- Area requirements of slow sand filters, 17, 23-24, 50
- Artificial recharge, 87, 99-100
 - in the Ruhr, 106-108
 - reduction of salt content, 108-110
 - using prefiltration, 107-108
- Assimilation, 31
- Attachment mechanisms, 30-31
- Automation of control valve, 67

- Backfilling, 19, 65, 70, 76
- Backwashing, 17, 91-93
- Bacteria, intestinal, 33
 - survival of, effect of temperature on, 33
- Bacteria count, reduction in, 22, 33
- Bicarbonates, dissociation into carbonates and carbon dioxide, 35

- Biochemical reactions, 32
- Biological activity, temperature dependence, 33, 46
 - time dependence, 44
- Biological filters, 18
 - theory, 27-46
- Brownian movement (diffusion), 27, 29
- Butterfly valve, for control of raw water level, 66

- Carbon dioxide, absorption by algae, 20
 - high concentration in effluent, 22
 - liberation by microorganisms, 22, 32
- Centrifugal forces, 27, 29
- Chemical activity, temperature dependence, 33, 46
- Chloride content, reduction by artificial recharge, 108-110
- Chlorination, 13, 14, 23, 25, 46
- Cholera, 15, 16
- Cleaning of filters, 17, 32, 37, 44, 78-80
 - choice of methods, 94-95
 - comparative costs, 94-95
 - effect of tropical conditions, 37
 - hydraulic method (Sivade), 90-93
 - hygienic precautions, 80
 - manual method, 79
 - mechanical methods, 84-93
- Coagulation, 23, 45
- Coefficient of permeability, 38
- Coefficient of uniformity, 40, 52
 - improvement by mixing sand stocks, 53
- Colebrook's formula, 112
- Colour removal, 21, 46
- Commissioning of filter, 76-78
- Construction of filters, 47-71
 - cost, 25, 50
 - use of local materials, 25
- Consumption of water, average per day, 47-49
 - average per hour, 47, 49
 - domestic, 48
 - fluctuations, 48
 - peak flows, 47, 49
 - seasonal fluctuations, 49
- Continuous operation of filter, 49
- Control devices, 18, 64-70
- Costs, constructional, 24, 50
 - operational, 25, 94-95
- Coulomb forces, 30
- Covering of filters, 24, 37, 51, 70-71

- Covering of filters (*continued*)
 as method of controlling algae, 37, 70
 as method of preventing ice formation, 70
- Cracks, danger of, 50, 63
- Darcy's law, 38, 65
- Demand, *see* Consumption
- Design of filters, 47-71
- Detention time, 105, 109
- Diameter of sand grains, effective, 40
 specific, 39
- Diffusion, 27, 29
- Dissimilation, 31
- Drainage of supernatant water, 64, 68, 78
- Drainage trough, 68
 as means of protecting filter-bed, 68
- Dumpers, 79, 87, 89
- Effective diameter, 40
- Effluent control valve, 67, 69
- Electrostatic attraction, 27, 30
- Elements of slow sand filter, 18-20
- Escherichia coli* count, 22, 33
- Ferric compounds, conversion to ferrous, 22
- Filter-bed, 18, 52-54
 cleaning, 17, 32, 37, 44
 lowering of water in, 64, 68, 78
 marker to indicate minimum level, 80
 protection from incoming water, 68, 76
 thickness, 53-54
- Filter bottom, construction, 55, 56
- Filter box, 19, 59-64
 circular, 60-61
 construction, 59
 depth, 59
 devices to prevent short circuiting, 63
 sloped floor, 70
 watertightness, 63
 with sloping walls, 59
- Filter controls, 64-70
- Filter medium, 18, 52
- Filter runs, length, 44
- Filter sand, fineness, 45
- Filter skin (*schmutzdecke*), 20
- Filters, access to, 47, 51
 covering of, 24, 37, 51
 elements of, 18-20
 for village water supply, 63
 gravity, 16
 mechanical, 16
 number, 50, 64, 78
 presence of fish, 97
- Filters (*continued*)
 pressure, 16
 protection against trespass and intrusion, 97
- Filtration, 14
 continuous, 49
 effects on water quality, 43-46
 hydraulics, 38-43
 intermittent, 49
- Filtration rate, 17, 38, 44
 constancy, 32, 65
 control, 64, 66, 67, 68, 73
 automatic, 67
 effect of sudden changes in, 32
 measurement, 64, 67, 73-74
- Fish, presence in supernatant water, 97
- Flocculation, 17
- Flow meter (venturi), 64, 73-74
- Fluctuations in water consumption, 48
- Freeboard, above supernatant water, 52, 59
- Freezing, 70
- Future extensions, provision for, 47
- Grading of sand, 40-41, 43, 45, 52-53
- Gravel, graded layers as support for filter-bed, 19, 56-59
- Gravity filters, rapid type, 16
 slow type, 16
- Groundwater, 99
 compared with surface water, 11-12
 recharge, 87, 99-110
- Head losses in under-drainage system, 55, 111-114, 115
- Hydraulic cleaning of filter-bed, 90-93
- Hydraulic sand ejector, 84
- Hydraulics of filtration, 38-43
- Hydrogen sulfide, liberation under anaerobic conditions, 32
- Induced recharge, 100-101
- Inertial forces, 27, 29
- Inlet for raw water, 64, 73
- Inorganic matter, produced by microorganisms, 22
- Intermittent operation of filter, 49
- Iron in effluent, 32
- Labour requirements, 24, 94
- Management of water treatment plant, 95-97
- Manganese in effluent, 33
- Manganic compounds, conversion to manganous, 22

- Mass attraction, 27, 30, 31
Mechanical cleaning of filters, 84-93
Mechanical filters, 16
Mechanisms of filtration, 27-34
Metazoa, 33
Microbiological oxidation, 31
Microorganisms, on sand grains, 22
Microstrainers, 45, 74
Mineralization, 32
Mixing of sand stocks, 53
- Negative pressure, prevention by weir, 42-43, 64
Nitrates, absorption by algae, 20
 liberation by microorganisms, 22, 32
 liberation in biochemical reactions, 32
Nitrification, 32
Nitrites, liberation in biochemical reactions, 32
Nitrogen, oxidation of, in *schmutzdecke*, 21
Number of filters, 50, 64, 78
- Odour-producing substances, 32
 removal by activated carbon, 54
Operating costs, 25
Operation and maintenance, 73-97
Organic matter, removal, 22, 32
Oxidation, chemical, 31
 microbiological, 31
 of ammonia, effect of temperature on, 33
 of nitrogen, 21
Oxygen, effect on organic impurities, 20
 liberation by algae, 20
 low concentration in effluent, 22
Oxygen content, 32
 diurnal variation, 35
 of raw water, improvement by recirculation, 75
Ozonation, 46
- Pathogens, removal, 22, 23, 33
Peak flows, 47, 49
Peat, removal, 46
Permanganate consumption, 44
 reduction in, 33
Permeability, coefficient, 38
pH value of water, correction by layer of crushed shells, 54
 lowering by carbon dioxide, 35
Phosphates, absorption by algae, 20
 liberation by microorganisms, 22, 32
Piezometric level in under-drainage system, 55, 111-114, 115
Pilot plant studies, 38, 45
- Pipework, capacity of, 47
Pollution, industrial, effect on algae, 35-36
Porosity, 28, 38
 and removal of microorganisms, 21
Potable water, 10
Pressure filters, 16
Pressures, negative, 43-43, 64
Pretreatment, advisability of, 45, 47
Protozoa, 33
Purification processes, 20-22, 31-34
- Quality of effluent, deterioration due to low temperature, 33-34, 70
 prevention of deterioration by covering filter, 70
 testing of, 76
Quality of raw water, effect of sudden changes in, 24
Quality of water, effects of filtration on, 43-46
- Rapid "roughing" filtration, 23, 45
Raw water, colloids in, 24
 constant level in supernatant reservoir, 66
 delivery, 64, 68
 effect of sudden changes in quality, 24, 32, 45
 toxic industrial wastes in, 24
Recharging of groundwater, *see* Artificial recharge, Induced recharge
Rechenberg, W., permanganate consumption formula, 44
Recirculation of effluent, 75
Record keeping, 96
Resanding, 80-84
Resistance of filter-bed, 41-42
Ripening, 26, 76, 80
 acceleration of, 76
 disposal of filtered water during, 64
- Safe water, 10
Salt content, reduction by artificial recharge, 108-110
Sampling, 45, 75
Sand, mixing of different stocks, 53
 reuse, 83
 washing, 81-84
Sand grains, coating of microorganisms (zoogloea), 22, 31
 total surface area, 28, 43
Schmutzdecke, 20, 36
 action on organic matter, 20
 constitution, 20
 part played in screening, 28

- Scour of sand-bed at inlet, prevention, 68, 76
- Scrapers, 86-87
gantry type, 89-90
- Screened intakes, 45
- Screening, 27-28
- Scum, removal, 64, 68
- Sedimentation, 17, 27, 28-29, 43, 45
- Sedimentation efficiency, 28, 44
- Settlement, 14, 17, 64
- Settling velocity, 28-29
- Shape factor (sphericity), 38
- Shape of filters, 51
- Short circuiting of filter-bed, 63
- Shrinkage of concrete, 63
- Sieve analysis, 39-41
- Sivade system, 90-93
- Size of filters, 50, 64, 78
- Skimming machines, 86-87
gantry type, 89-90
- Sludge disposal, 26
- Sources of raw water, choice of, 11-12
- Specific diameter, 39
- Sphericity, 38
- Spreading basins, 87, 101, 105
- Stokes's formula, 29
- Straining, 14, 27, 43
- Subsidence, 50
- Sulfates, liberation by microorganisms, 32
- Sunlight, influence of, 20
- Supernatant water reservoir, 18, 51-52
depth of water in, 52
- Surface catalysis, 43
- Surface loading, 28
- Surface water, compared with ground-water, 11-12
- Taste-producing substances, 32
removal by activated carbon, 54
- Temperature, effect on filtration, 33
- Throwing over, 81
- Training requirements for operators, 26
- Transport mechanisms, 27-30
- Treatment, choice of processes, 12-14
- Trenching machines, 87
- Turbidity, limits for slow sand filters, 23, 45
reduction by pretreatment, 23, 45
- Under-drainage system, 18, 54-59, 111-114, 115
- Uniformity, coefficient, 40, 52
- Van de Vloed, formula for reduction in permanganate consumption, 33
- Van der Waals' force, 30, 31
- Vegetable matter, removal, 46
- Ventilation, 69
- Venturi meter, 64, 73-74
- Washing of sand, 81-84
- Wastage in distribution system, 47-48
- Waste material, as agricultural dressing, 26
- Water, acceptable, 10
filtered, conveyance to clear water reservoir (adduction line), 64, 69
diversion during ripening, 64, 69
potable, 10
raw, delivery of, 64, 68
safe, 10
- Water level in filter box, 20
- Water quality, effects of filtration on, 43-46
- Water sources, choice of, 11-12
- Waterborne diseases, 15, 16
- Weir, 20, 42, 64, 69
telescopic, 68, 69
- Zones, in filter-bed, 32, 53-54
- Zoogloea, 31

WHO publications may be obtained, direct or through booksellers, from:

ALGERIA	Société nationale d'Édition et de Diffusion, 3 bd Zirout Youcef, ALGIERS.
ARGENTINA	Librería de las Naciones, Cooperativa Ltda, Alsina 500, BUENOS AIRES — Editorial Sudamericana S.A., Humberto 1° 545, BUENOS AIRES.
AUSTRALIA	Mail Order Sales, Australian Government Publishing Service, P.O. Box 84, CANBERRA A.C.T. 2600; or over the counter from Australian Government Publications and Inquiry Centres at: 113 London Circuit, CANBERRA CITY; 347 Swanston Street, MELBOURNE; 309 Pitt Street, SYDNEY; Mr Newman House, 200 St. George's Terrace, PERTH; Industry House, 12 Pirie Street, ADELAIDE; 156-162 Macquarie Street, HOBART — Hunter Publications, 58A Gipps Street, COLLINGWOOD, Vic. 3066.
AUSTRIA	Gerold & Co., I. Graben 31, VIENNA 1.
BELGIUM	Office international de Librairie, 30 avenue Marnix, BRUSSELS.
BRAZIL	Biblioteca Regional de Medicina OMS/OPS, Unidad de Venta de Publicaciones, Caixa Postal 20.381, Vila Clementino, 01000 SÃO PAULO, S.P.
BURMA	see India, WHO Regional Office.
CANADA	Information Canada Bookstore, 171 Slater Street, OTTAWA, Ontario K1A 0S9; Main Library, University of Calgary, CALGARY, Alberta; 1683 Barrington Street, HALIFAX, N.S. B3J 1Z9; 640 Ste Catherine West, MONTREAL, Quebec H3B 1B8; 221 Yonge Street, TORONTO, Ontario M5B 1N4; 800 Granville Street, VANCOUVER, B.C. V6Z 1K4; 393 Portage Avenue, WINNIPEG, Manitoba R3B 2C6. Mail orders to 171 Slater Street, OTTAWA, Ontario K1A 0S9.
CHINA	China National Publications Import Corporation, P.O. Box 88, PEKING.
COLOMBIA	Distrilibros Ltd, Pío Alfonso García, Carrera 4a, Nos 36-119, CARTAGENA.
COSTA RICA	Imprenta y Librería Trejos S.A., Apartado 1313, SAN JOSÉ.
CYPRUS	MAM, P.O. Box 1674, NICOSIA.
CZECHO-SLOVAKIA	Artia, Smecky 30, 111 27 PRAGUE 1.
DENMARK	Ejnar Munksgaard, Ltd, Nørregade 6, COPENHAGEN.
ECUADOR	Librería Científica S.A., P.O. Box 362, Luque 223, GUAYAQUIL.
EGYPT	Nabaa El Fikr Bookshop, 55 Saad Zaghloul Street, ALEXANDRIA.
FIJI	The WHO Representative, P.O. Box 113, SUVA.
FINLAND	Akateeminen Kirjakauppa, Keskuskatu 2, HELSINKI 10.
FRANCE	Librairie Arnette, 2 rue Casimir-Delavigne, PARIS 6 ^e .
GERMANY. FEDERAL REPUBLIC OF	Gövi-Verlag GmbH, Beethovenplatz 1-3, FRANKFURT A. M. 6 — W. E. Saarbach, Postfach 1510, Follerstrasse 2, 5 COLOGNE 1 — Alex. Horn, Spiegelgasse 9, 62 WIESBADEN.
GREECE	G. C. Eleftheroudakis S.A., Librairie internationale, rue Nikis 4, ATHENS (T. 126).
HAITI	Max Bouchereau, Librairie "A la Caravelle". Boite postale 111-B PORT-AU-PRINCE.
HUNGARY	Kultura, P.O.B. 149, BUDAPEST 62 — Akadémiai Könyvesbolt, Váci utca 22, BUDAPEST V.
ICELAND	Snaebjörn Jonsson & Co., P.O. Box 1131, Hafnarstraeti 9, REYKJAVIK.
INDIA	WHO Regional Office for South-East Asia, World Health House, Indraprastha Estate, Ring Road, NEW DELHI 1 — Oxford Book & Stationery Co., Scindia House, NEW DELHI; 17 Park Street, CALCUTTA 16 (Sub-agent).
INDONESIA	see India, WHO Regional Office.
IRAN	Mesrob Grigorian, Naderi Avenue (Arbab-Guiv Building), TEHERAN.
IRELAND	The Stationery Office, DUBLIN.
ISRAEL	Heiliger & Co., 3 Nathan Strauss Street, JERUSALEM.
ITALY	Edizioni Minerva Medica, Corso Bramante 83-85, TURIN; Via Lamarmora 3, MILAN.
JAPAN	Maruzen Co. Ltd, P.O. Box 5050, TOKYO International, 100-31.
KENYA	The Caxton Press Ltd, Head Office: Guthani House, Huddersfield Road, P.O. Box 1742, NAIROBI.
KHMER REPUBLIC	The WHO Representative, P.O. Box 111, PHNOM-PENH.
LAOS	The WHO Representative, P.O. Box 343, VIENTIANE.
LEBANON	Documenta Scientifica/Redico, P.O. Box 5641, BEIRUT.
LUXEMBOURG	Librairie du Centre, 49 bd Royal, LUXEMBOURG.
MALAYSIA	*The WHO Representative, P.O. Box 2550, KUALA LUMPUR — Jubilee (Book) Store Ltd, 97 Jalan Tuanku Abdul Rahman, P.O. Box 629, KUALA LUMPUR — Parry's Book Center, K.L. Hilton Hotel, KUALA LUMPUR.
MEXICO	La Prensa Médica Mexicana, Ediciones Científicas, Paseo de las Facultades, 26, MEXICO CITY 20, D.F.

Price: S v. fr. 16.—

Prices are subject to change without notice.

WHO publications may be obtained, direct or through booksellers, from :

MONGOLIA	<i>see</i> India, WHO Regional Office.
MOROCCO	Editions La Porte, 281 avenue Mohammed V, RABAT.
NEPAL	<i>see</i> India, WHO Regional Office.
NETHERLANDS	N.V. Martinus Nijhoff's Boekhandel en Uitgevers Maatschappij, Lange Voorhout 9, THE HAGUE.
NEW ZEALAND	Government Printing Office, Government Bookshops at : Rutland Street, P.O. 5344, AUCKLAND; 130 Oxford Terrace, P.O. Box 1721, CHRISTCHURCH; Alma Street, P.O. Box 857, HAMILTON; Princes Street, P.O. Box 1104, DUNEDIN; Mulgrave Street, Private Bag, WELLINGTON — R. Hill & Son Ltd, Ideal House, Cnr. Gilles Avenue & Eden Street, Newmarket, AUCKLAND S.E. 1.
NIGERIA	University Bookshop Nigeria, Ltd, University of Ibadan, IBADAN.
NORWAY	Johan Grundt Tanum Bokhandel, Karl Johansgt. 43, OSLO 1.
PAKISTAN	Mirza Book Agency, 65 Shahrah Quaid-E. Azam, P.O. Box 729, LAHORE 3.
PARAGUAY	Agencia de Librerías Nizza S.A., Estrella No. 721, ASUNCIÓN.
PERU	Distribuidora Inca S.A., Apartado 3115, Emilio Althaus 470, LIMA.
PHILIPPINES	World Health Organization, Regional Office for the Western Pacific, P.O. Box 2932, MANILA — The Modern Book Company Inc., P.O. Box 632, 926 Rizal Avenue, MANILA.
POLAND	Skladnica Księgarska, ul. Mazowiecka 9, WARSAW (<i>except periodicals</i>) — BKWZ Ruch, ul. Wronia 23, WARSAW (<i>periodicals only</i>).
PORTUGAL	Livraria Rodrigues, 186 Rua Aurea, LISBON.
REPUBLIC OF KOREA	The WHO Representative, Central P.O. Box 540, SEOUL.
REPUBLIC OF VIET-NAM	The WHO Representative, P.O. Box 242, SAIGON.
SINGAPORE	The WHO Representative, 144 Moulmein Road, G.P.O. Box 3457, SINGAPORE 1.
SOUTH AFRICA	Van Schaik's Bookstore (Pty) Ltd, P.O. Box 724, PRETORIA.
SPAIN	Comercial Atheneum S.A., Consejo de Ciento 130-136, BARCELONA 15; General Moscardó 29, MADRID 20 — Librería Diaz de Santos, Lagasca 95, MADRID 6.
SRI LANKA	<i>see</i> India, WHO Regional Office.
SWEDEN	Aktiebolaget C.E. Fritzes Kungl. Hovbokhandel, Fredsgatan 2, STOCKHOLM 16.
SWITZERLAND	Medizinischer Verlag Hans Huber, Länggass Strasse 76, 3012 BERNE 9.
THAILAND	<i>see</i> India, WHO Regional Office.
TUNISIA	Société Tunisienne de Diffusion, 5 avenue de Carthage, TUNIS.
TURKEY	Librairie Hachette, 469 avenue de l'Indépendance, ISTANBUL.
UGANDA	<i>see address under</i> KENYA.
UNITED KINGDOM	H. M. Stationery Office: 49 High Holborn, LONDON WC1V 6HB; 13a Castle Street, EDINBURGH EH2 3AR; 109 St Mary Street, CARDIFF CF1 1JW; 80 Chichester Street, BELFAST BT1 4JY; Brazenose Street, MANCHESTER M60 8AS; 258 Broad Street, BIRMINGHAM B1 2HE; 50 Fairfax Street, BRISTOL BS1 3DE. <i>Air mail orders should be sent to</i> P.O. Box 569, London SE1 9NH.
UNITED REP. OF TANZANIA	<i>see address under</i> KENYA.
UNITED STATES OF AMERICA	<i>Single and bulk copies of individual publications (Not subscriptions)</i> : Q Corporation, 49 Sheridan Avenue, ALBANY, N.Y. 12210. <i>Subscriptions</i> : Subscription orders, accompanied by check made out to the Chemical Bank, New York, Account World Health Organization, should be sent to the World Health Organization, P.O. Box 5284, Church Street Station, NEW YORK, N.Y. 10249. Correspondence concerning subscriptions should be forwarded to the World Health Organization, Distribution and Sales Service, 1211 GENEVA 27, Switzerland. <i>Publications are also available from the United Nations Bookshop, NEW YORK, N.Y. 10017 (retail only).</i>
USSR	<i>For readers in the USSR requiring Russian editions</i> : Komsomolskij prospekt 18, Medicinskaja Kniga, MOSCOW — <i>For readers outside the USSR requiring Russian editions</i> : Kuzneckij most 18, Meždunarodnaja Kniga, MOSCOW G-200.
VENEZUELA	Editorial Interamericana de Venezuela C.A., Apartado 50785, CARACAS — Librería del Este, Av. Francisco de Miranda 52, Edificio Galipán, CARACAS.
YUGOSLAVIA	Jugoslovenska Knjiga, Terazije 27/II, BELGRADE.

Orders from countries where sales agents have not yet been appointed may be addressed to :
World Health Organization, Distribution and Sales Service, 1211 Geneva 27, Switzerland, but must be paid
for in pounds sterling, US dollars, or Swiss francs.