

AT MICROFICHE
REFERENCE
LIBRARY

A project of Volunteers in Asia

Wells Construction

by: Richard E. Brush

Published by:

Peace Corps
Information Collection and Exchange
806 Connecticut Avenue, N.W.
Washington, DC 20525 USA

Available from:

Peace Corps
Information Collection and Exchange
806 Connecticut Avenue, N.W.
Washington, DC 20525 USA

Reproduction of this microfiche document in any form is subject to the same restrictions as those of the original document.

APPROPRIATE TECHNOLOGIES FOR DEVELOPMENT

ACTION
PEACE CORPS



Wells
Construction

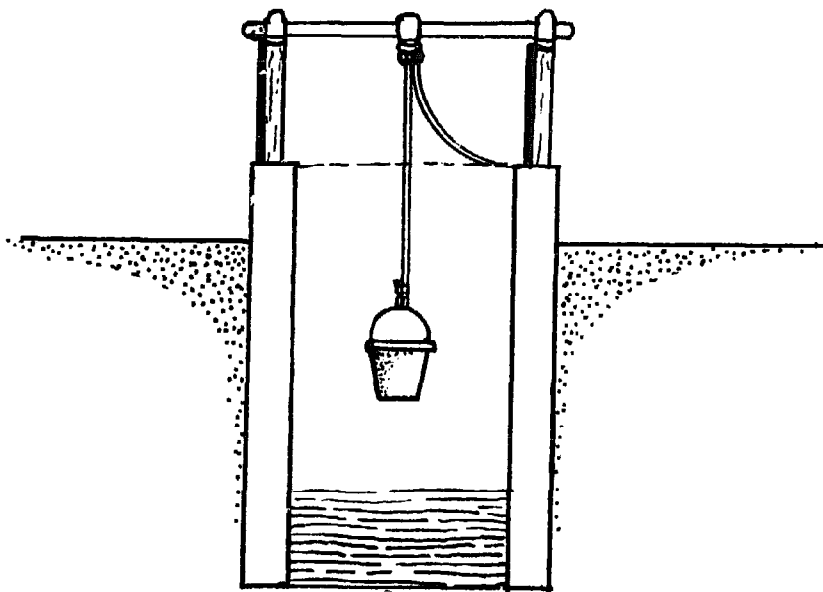

P&T

INFORMATION COLLECTION & EXCHANGE

Errata

Design Alternatives, Inc. designed, edited and illustrated WELLS CONSTRUCTION based on Peace Corps materials and experience. Author Richard Brush, Editor Dave Tyler and Illustrator Laura Gould are former Peace Corps Volunteers.

Note that figures A and B have been printed, for reference purposes, inside the front and back covers and can be unfolded to use in conjunction with any other part of the manual.

NOTES AND ERRATA

page	line	
i	32	others
v	11	Figures (A and B), which appear inside the front and back covers are reproduced at the beginnings of Section Two and Section Three respectively.
39	28	Wood precedes "This also is only a temporary solution"
60	8	pre-cast not pre-cut
66	d.	Vertical re-rods of the first pour were tied to the vertical re-rods of the second pour before concrete was placed behind the mold for the second meter.
82	25	$\left[(\text{hole diameter}) - (\text{lining thickness}) \right] \times 3.1416 + 20$ $(\text{re-rod diameter}) + 2(5 \text{ cm end hooks}) = \text{length}$
86	10	This lining method
100	Fig 9-1	Trough or Channel
114	1	in the Cement Appendix
	27	10 mm re-rod
153		delete dashes before last two paragraphs
182	28	If a tripod
185	18	Rotating the pipe clockwise will assist . . .
194	35	well sinking operation
195	29	delete co at the beginning of the line
199	32	extend
200	15	or where drilling mud
225	7	make it cure properly
254	8	the cylinder material

ABOUT THIS MANUAL...

Wells Construction is a how-to manual, the ninth in Peace Corps' Appropriate Technologies for Development manual series. It is designed as a working and teaching tool for development workers in their field activities, with information presented in a form easily adapted to on-the-job needs. Wells Construction brings together in one volume the principles of wells construction and the practical techniques currently being used and tested around the world. Of course it is impossible in a single publication to cover all situations, but those who understand the basic unchanging principles can adapt and modify ideas, suggestions, and technologies from another part of the world to their own situation.

Manuals in the Appropriate Technologies for Development series are based on Peace Corps field experience. Since the Peace Corps began in 1961, more than 82,000 Volunteers have served in some 75 countries around the world in people-to-people development projects. Living and working at the grassroots level, they have learned the restrictions of high technology; with very limited resources, they join their host country counterparts in adapting local materials and technologies for better health, agriculture, education, and overall community development. Years before the term "appropriate technology" came into usage, Peace Corps Volunteers and their hosts were pioneering in this field.

ICE, Peace Corps' Information Collection & Exchange, was established to take ideas and technical information developed in the field and to share them widely among Peace Corps Volunteers and other working at the grassroots development level. In addition to publishing Peace Corps Appropriate Technologies for Development Manuals, Reprints, and Resource Packets, ICE serves as the technical assistance unit with Peace Corps, answering specific requests from Volunteers for project related information.

For an annotated listing of publications or for more information, contact:

Peace Corps
Information Collection & Exchange (ICE)
Washington, D.C. 20525 USA

ACKNOWLEDGEMENTS

Many thanks are due to F. Eugene McJunkin for his technical review of the material in Wells Construction. Thanks to Sam Kunkle who wrote Appendix II, Vegetation as an Index of Ground Water.

Thanks also to the many people who helped in the preparation of this manual, especially Craig Hafner, Howard Ebenstein, Brenda Gates, Francis Luzzatto, Laurel Druben, Sue Chappellear, Pascal Pittman, Mary Ernsberger, Vic Wehman, Vicki Fries, Vernell Womack, and Teri Barila.

INTRODUCTION

Purpose

This manual is intended for use by development workers involved in the construction of wells to supply water to a local population for personal consumption. It has been designed to help field workers with little or no construction experience to assist communities in:

- planning and designing a well, or wells, appropriate to the needs of the local population;
- assessing the advantages or disadvantages of locally available construction materials;
- deciding on the most appropriate construction techniques;
- constructing a well, or wells, capable of meeting the community's needs.

Most of the materials, tools, and methods covered in this manual are applicable throughout the world in a variety of local situations. The techniques are designed to be useful in the rural areas of most developing countries. Step-by-step plans outline construction materials and techniques to be used where skills may be limited. Although all potential situations cannot be covered, this manual provides enough background to allow workers to assess unusual situations, and determine what available techniques might be useful.

Organization of This Manual

The manual is organized into three sections. Section One, Planning, introduces the knowledge needed for wells planning and discusses those aspects of water development and wells construction that should be considered before a wells project is begun. It also presents an outline of the different methods of constructing wells. These are covered in greater detail in the next two sections. Section One will give you some basic ideas about the kind of well that might be most appropriate in your situation.

Section Two, Hand Dug Wells, provides information on wells that can, or must, be dug by hand:

- a detailed outline of the tasks involved in wells construction;
- a discussion of the top, middle and bottom sections of a hand dug well, their parts, and methods used in constructing them;
- the tools, equipment and materials needed;
- if tools and supplies can safely be lowered into and out of the well;
- the operations that must take place in the hole;
- details of the construction of the middle section;
- details of the construction of the bottom section.

Section Three, Drilled Wells, provides information on drilling techniques that can be used in certain situations:

- the basic components and procedures used in drilling for water;
- the different possible sinking methods;
- a detailed description of equipment and procedures used in a variety of hand-drilling methods;
- how the bottom section of a drilled well is constructed and finished for use.

Several appendices follow, giving useful information on:

- Metric-English measurement conversion;
- vegetation as a possible indicator of water;

- use of dynamite;
- use of cement;
- techniques of levelling and plumbing molds;
- piping;
- pumps.

Following these, the two Figures (A and B) which appear inside the front and back covers are reproduced for convenience, and the manual concludes with a glossary and an annotated bibliography.

How the Manual Can Be Used

You can use this manual:

- as a text to teach and train people about wells and their use;
- to locate the information necessary to construct a well;
- to stimulate thinking about possible useful modifications of presently used techniques;
- to locate other sources of information.

FIGURE A
CROSS SECTION OF HAND DUG WELL

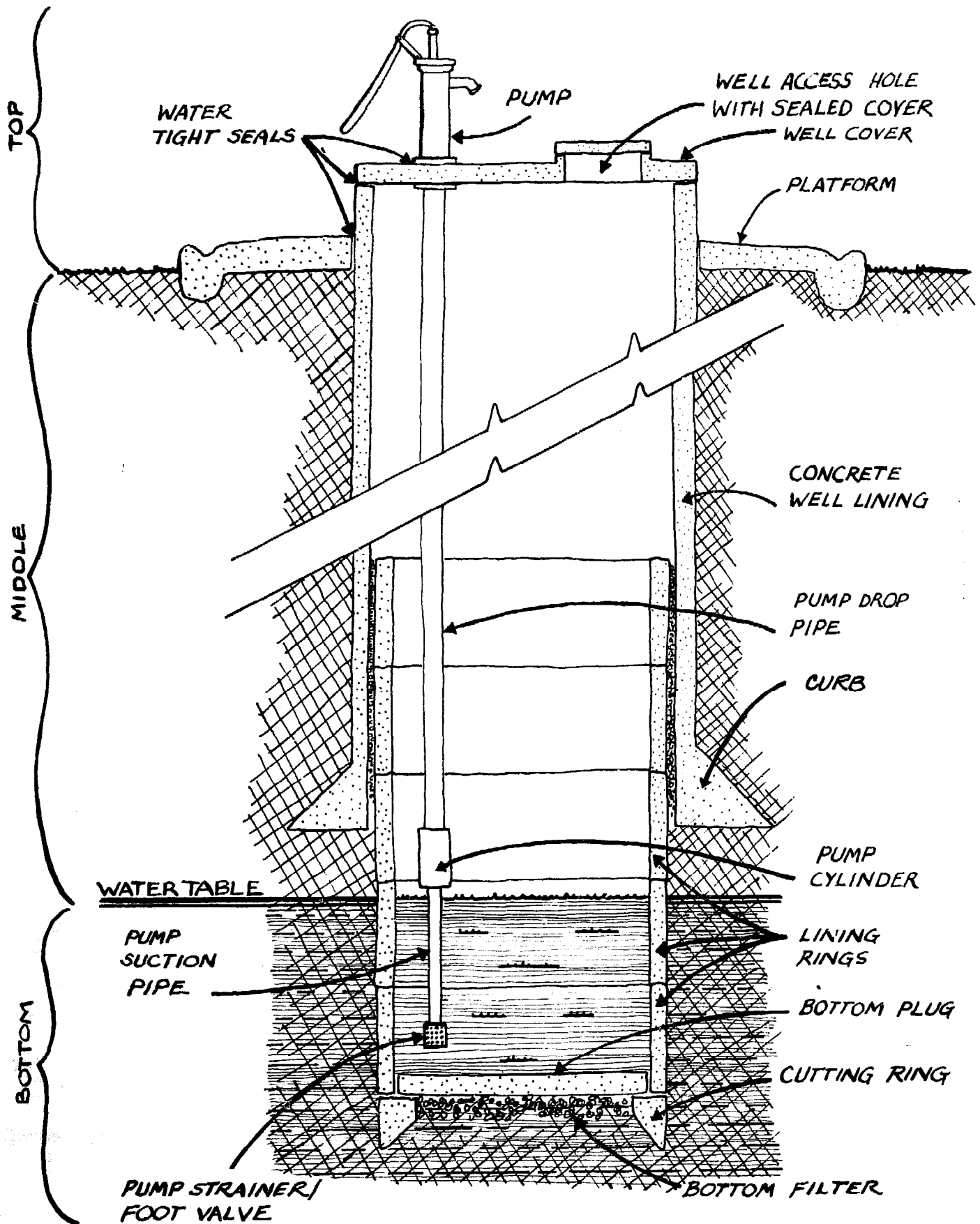

FIGURE B
CROSS SECTION OF HAND DRILLED WELL

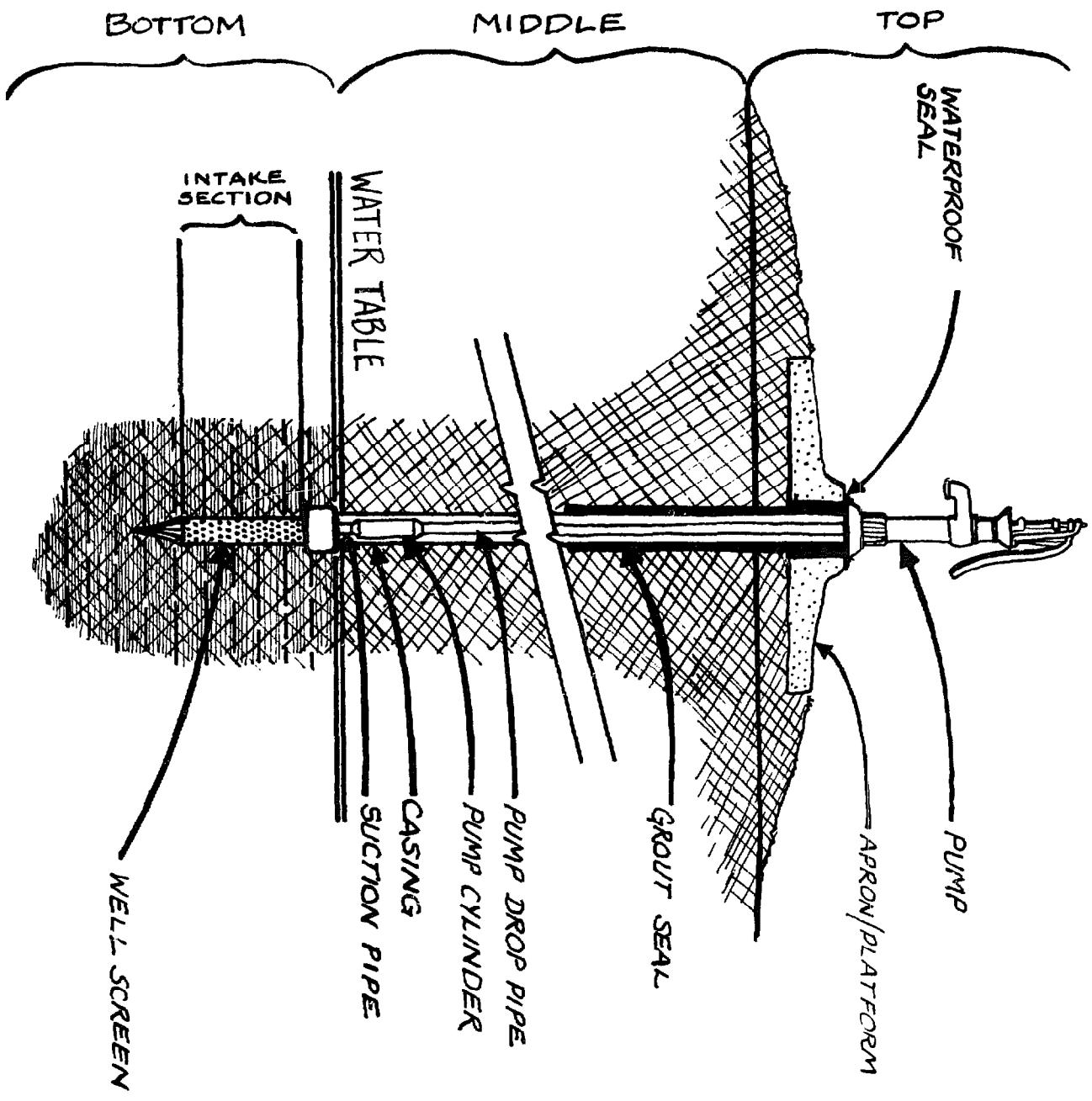

TABLE OF CONTENTS

SECTION ONE: PLANNING

Chapter 1:	Introduction to Wells Planning	1
------------	--	---

SECTION TWO: HAND DUG WELLS

Chapter 2:	Introduction to Hand Dug Wells	19
Chapter 3:	Well Design	23
Chapter 4:	Supplies	37
Chapter 5:	Lowering and Raising Workers and Equipment	43
Chapter 6:	Digging	57
Chapter 7:	The Middle Section: Overview of Lining Techniques	63
Chapter 8:	Construction of the Middle Section	77
Chapter 9:	Construction of the Bottom Section	99

SECTION THREE: DRILLED WELLS

Chapter 10:	Introduction to Drilled Wells	117
Chapter 11:	Drilling and Casing Techniques	129
Chapter 12:	Construction: Hand Rotary and Hand Percussion Methods	147
Chapter 13:	Construction: Sludger Method	165
Chapter 14:	Construction: Driven and Jetted	173
Chapter 15:	The Bottom Section	191

APPENDICES

Appendix	I:	Conversion Factors and Tables209
Appendix	II:	Vegetation as an Index of Ground Water211
Appendix	III:	Uses of Dynamite in Hand Dug Wells213
Appendix	IV:	Cement221
Appendix	V:	Leveling and Plumbing the Mold239
Appendix	VI:	Pipe243
Appendix	VII:	Pumps249
Appendix	VIII:	Water Treatment in Wells261
Appendix	IX:	Rope Strength267
Glossary of Terms269
Annotated Bibliography273

Section 1:

PLANNING

Chapter 1

INTRODUCTION TO WELLS PLANNING

A. Overview

There is water at some depth almost everywhere beneath the earth's surface. A well is a dug or drilled hole that extends deep enough into the ground to reach water. Wells are usually circular and walled with stone, concrete or pipe to prevent the hole from caving in. They are sunk by digging or drilling through one or more layers of soil and rock to reach a layer that is at least partially full of water called an aquifer. The top of the aquifer, or the level beneath which the ground is saturated with water, is called the water table. In some areas there is more than one aquifer beneath the water table. Deep wells, such as those sunk by large motorized equipment, can reach and pull water from more than one aquifer at the same time. However, this manual will only discuss sinking wells to the first usable aquifer with hand-powered equipment.

B. The Need for Adequate Water Supply

A new properly built well can provide people with more and better water. But the new well itself may have little or no impact on the surrounding community's health if the well users do not know how to make effective use of the water.

It is important to learn the water needs of a local population in order to construct an appropriate water source. In all locales an adequate supply of clean water is essential for maintaining and improving health. Many of the most common and serious diseases in developing countries are closely related to the amount and quality of water people use. Without an adequate supply of clean water, little can be done to control diseases that spread through contaminated water supplies.

In order to ascertain local needs, you must consider two limiting aspects to the provision of water: 1) the quality of the water and 2) the quantity of water available locally.

Good quality water does not contain chemicals and bacteria which are hazards to health and life. The quality of water can be assured by:

- locating the site to avoid possible water contamination;
- proper construction of the well or any other water source, to protect the water supply from contamination;
- initial and periodic water treatment, usually with chlorine, to kill dangerous bacteria (see Appendix VIII, Water Treatment);
- education of the local users so that they can maintain the purity, or at least prevent the gross contamination of their water.

The quantity of water is often more difficult to ensure. Especially in a rural setting, access (distance) to water will often limit the amount that can be used by each individual, because of the time needed to convey it. Quantity, however, has a direct bearing on health.

Five liters per person per day is considered the minimum consumption level, although desert dwellers exist on less. More than 50 liters per person per day, it has been estimated, gains no further health benefits. Twenty-five liters per person per day may become an acceptable goal in places where piped connections to individual houses are not feasible. Wherever possible, water use beyond minimum-level consumption should be encouraged. Consumption will rise under the following circumstances:

- new well construction to provide a water source closer to a group of people, who will then presumably be able to gather more water in the same amount of time that they previously were able to do;
- education of local users toward a greater use of water, especially for hygienic purposes (bathing, washing clothes and cooking utensils).

The quantity of water needed may also be significantly affected by the number of livestock that require water and by whether the water is to be used for garden irrigation.

C. Involving the Local Community

The degree of community participation and control may be the most important factors in determining the success of any wells construction project. The ideal situation is that the entire project be completely controlled and run by the local people. This, however, is often not possible. It therefore becomes the task of the development worker to see that a community in need of a better water supply is encouraged to realize that need and act to meet it.

It is usually best to use the decision-making systems that have already been established and accepted by the community. These systems vary between open town meeting-type forums where everyone who wishes to can speak, and a relatively closed council or other politically established group or person. In all cases, each of the various possibilities for well construction should be fairly presented so that whatever decisions are made realistically reflect the needs and concerns of the decision-making unit.

Some kind of organized educational campaign should be an integral part of every water supply improvement project. The benefits to be gained from using larger quantities of clean water are not often understood by the local users. Unless they can be convinced of the benefits clean water can bring to them and their children, they are not likely to make effective use of a newly developed water source. In societies where change is often very slow, such an attitude change will take time. Only when the people become willing to act on their understanding of the importance of clean water and what needs to be done to keep it clean can any water supply improvement project be truly successful.

This educational effort is probably one of the most important and difficult aspects of water supply development. Even with a massive education campaign, real change may take many years. But without it, a supply of clean water may mean nothing.

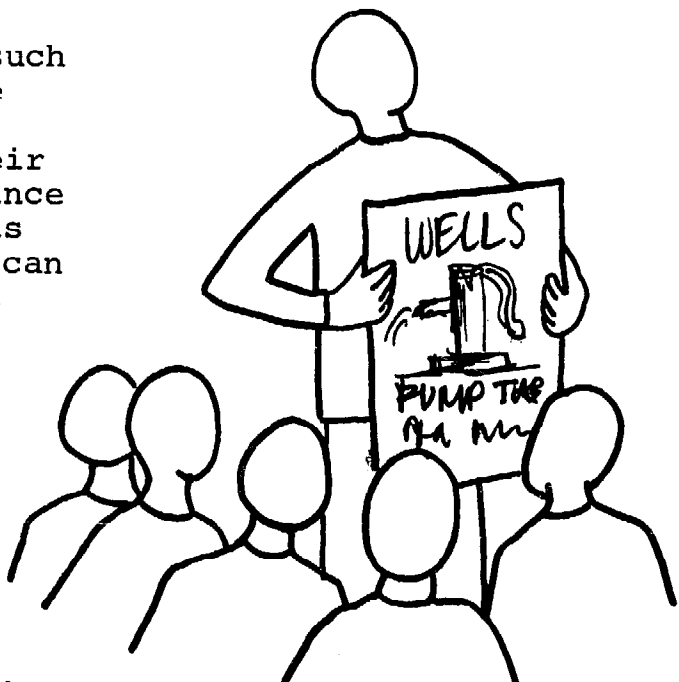

Such a campaign of education is especially important for the future maintenance of the well. If people can see clean water as being vital to them, they will be willing to occasionally spend a little time or money to keep their water supply safe. However, where people are not involved in planning and, to some extent, construction from the beginning, no amount of general education later will be effective.

D. Selecting the Most Appropriate Water Source

When the community has decided that more and better water is needed, it will be necessary for them to decide what kind of source is possible and will best suit their needs. A well is not always the most appropriate water source in a particular locale. Their goal is to find the cheapest, most reliable way to provide the needed amount of clean water.

Here are the chief potential sources of water listed in their approximate order of preference based on cost, quality of water, need for equipment and supplies:

- Springs - If there are year-round springs nearby, they can usually be developed to supply clean water. This water can often be conveyed through pipes without the expense of pumps or water treatment. Springs can most often be found in hilly or mountainous regions (see Fig. 1-1);

- Wells - Because there is water at some depth almost everywhere beneath the earth's surface, a well can be sunk (using the appropriate technique), almost anywhere. The water that comes into the bottom of a well has filtered down from the surface and is, in most cases, cleaner than water that is exposed on the open ground;

- Rainwater - Collection and storage of rainwater may provide another source where surface and underground water supplies are limited or difficult to reach. Normally, except in the rainiest regions, rainwater will not supply all the water needs of a locale; however, as a supplement, it can be collected from roofs or protected ground run-off areas, and stored in covered cisterns to prevent contamination.

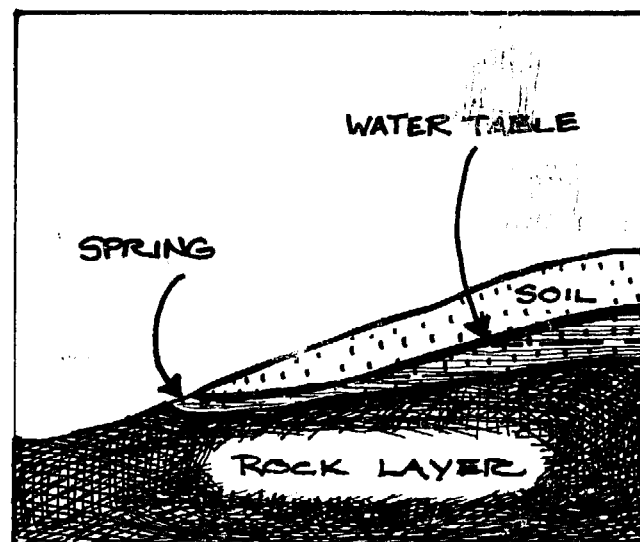

FIG. 1-1. SPRING LOCATION

- Surface water - Streams, rivers, and lakes are all commonly used as sources of water. Although no construction is needed to enable them to supply water, the quality of the water is almost always poor. Only clear mountain streams flowing from protected watersheds could be considered as fit for human consumption.

E. Site Choice

Locating the site for a well should be based on the following guidelines:

The well should be located at a site that is:

- water bearing;
- acceptable to the local community;
- suitable to the sinking methods available;
- not likely to be easily contaminated.

It is not always possible for a site to meet all of these guidelines. Therefore, a site will need to be chosen which best approximates the guidelines, with particular emphasis on the likelihood of reaching water (see Fig. 1-2). Where there is an equal chance of reaching water at several different locations, the one closest to the users is preferable.

- Where is water likely to be found

A development worker can assist the community's effort to locate a likely site by collecting available information on local ground water. In many countries, some information is available through appropriate ministries, water agencies, and international development organizations.

Choosing the site for a well can be difficult, because easily available and abundant water can never be guaranteed. Even professionals, before a well is sunk, rarely know where they will reach water and how much will be available. However, there are a number of guidelines which can be very useful in providing information about possibly successful well sites.

Where possible, a well can be located near a past or present water source. By doing so, you are likely to reach water at approximately the same depth as the other source.

If no other sources exist or have ever been developed nearby, you must be more cautious in choosing a well site. Unless you have the benefit of detailed geological information, it is best simply to look for the lowest spot nearby. Both surface and ground water are likely to collect here. In some cases, plants can be indicators of the presence of ground water (see Appendix, Vegetation as an Indicator of Ground Water). However, be careful not to build in a place so low that the well would be susceptible to flooding in heavy rain.

FIG. 1-2. POSSIBLE WELL SITES

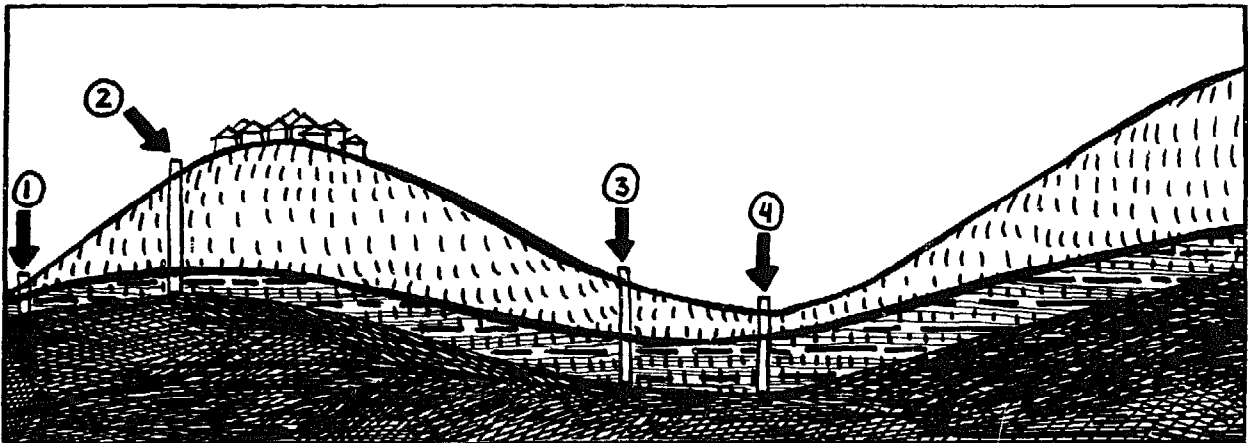

- ① Limited water would be available at this site, because the impermeable rock layer is close to the ground surface, allowing slight fluctuations in the water table to drastically affect water availability.
- ② Closest site to village and therefore the best site if it is possible to dig down far enough to reach water.
- ③ At this site, there would be a better chance of reaching more water than at 2. but the site is further from the village.
- ④ This is the site where water is most likely to be reached by a well although it is some distance from the village. Because it is in the absolute bottom of the valley, it may be subject to flooding.

- Is the site acceptable to the local community?

The community must accept the final site choice and be willing to use the well when it is completed. Only then will it benefit local residents.

- Is the site suitable to the available sinking methods?

If the most likely site would require that the well penetrate a layer of rock, and if there are no tools available to do so difficult a job, the site is not an appropriate one.

- Is the well likely to be easily contaminated?

The most important consideration here is that the well not be located within 15 meters of a latrine or other sewage source. This would also include not placing the well where it might be damaged or inundated by a flood or heavy rain.

F. Preventing Water Contamination

What is the optimum well design for the prevention of contamination?

The only way to design a well to prevent water contamination is to seal it so that water can enter only through the bottom section. Dug wells need to be covered with a permanent cover through which a pump is installed to draw water. All wells should have a platform around them that is at least 1 meter wide, one which water will not penetrate. This platform ought to be sloped in such a way that any spilled water runs off away from the well. (See Figs. A and B on inside of front and back manual covers.)

These and other measures are described in more detail in the design section for the different types of wells (pp. 23 and 124).

G. Types of Wells

In general, there are two types of wells: dug wells and drilled wells. The obvious difference between the two is the size of the holes. (See Figs. A and B).

Dug wells are sunk by people working down in the hole to loosen and remove the soil. They need to be at least 1 meter wide to give people room to work.

Drilled wells, on the other hand, are sunk by using special tools which are lowered into the ground and worked from the surface. These wells are normally less than 30 centimeters (cm) in diameter, and for the purpose of this manual, will usually be less than 15 cm. The reason for this is the difficulty of drilling larger holes with hand-powered tools.

In both categories, there are many different specific sinking techniques which will be discussed in more detail later.

H. Well Sections

Every well, whether drilled or dug, has three sections: top, middle, and bottom. Each of these sections varies in construction, because each must function differently. (See Figs. A and B.)

- Top section - That part of the well at or above the ground surface level. It should be designed to allow people to get water as easily as possible, and, at the same time, to prevent water, dirt, and other contaminants from entering.
- Middle section - That part of the well which is between the ground surface and the water. This section is usually a circular hole. It is reinforced with some kind of lining to prevent the walls from caving in.

NOTE: Lining and casing refer to the same part of the well (see Figs. A and B). Lining is used to refer to that part of the dug well, while casing refers to the pipe used to reinforce a drilled well.

- Bottom section - That part of the well that extends beneath the water table into the aquifer. It should be designed to allow as much water as possible to enter, and yet prevent the entrance of any soil from the aquifer. Its lining will have holes, slots, or open spaces, allowing water to pass through.

I. Materials

1. Availability of Materials

Even as you are beginning site selection and community awareness activities, you should determine the availability of construction materials and the difficulty in obtaining them. Later you will need to assess in greater detail the specific tools and supplies needed, and the quantities of each.

First of all, can you get cement or pipe? If cement is available, it should be fresh and powdery, and not congealed in hard clumps. Cement, sand, gravel, and water can be mixed to make concrete which when it hardens is very strong and long lasting especially when reinforced with steel reinforcing rod (rerod). If neither cement nor pipe is available, you will need to find a local material that can serve as the lining. (See p. 38.)

Metal, plastic, or concrete pipe can be used. Metal pipe, usually galvanized iron or steel, is more durable for well sinking but is subject to corrosion and rusting over time. Plastic pipe, on the other hand, has less strength and is not easy to use in the sinking process. Nevertheless, it is virtually unaffected by ground water quality. Large diameter concrete pipe can be used to line dug wells.

If you can get these basic materials, you will probably be able to find the other related tools, equipment, or adapt local equipment. A local metal worker (welder or blacksmith) can probably make any special tools you may need. For a list of these, see page 37 of the next section.

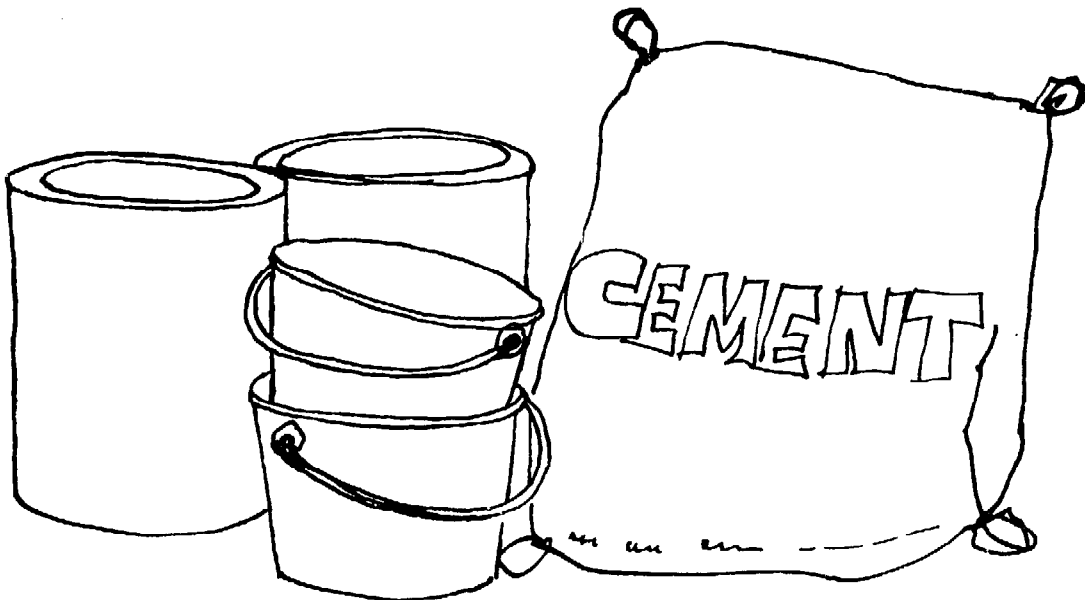

2. Use of Local Materials

Construction of a well is cheaper, more easily understood, and more likely to be incorporated into the culture if the builders use local materials whenever possible.

The materials required to construct the bottom section, lining, well head, and pump (see Figs. A and B) should be sufficiently strong to withstand the stress of installation and the wear and tear of daily use. They should also be able to support the weight of the column where necessary and not contaminate the water, as a result of natural wear, during the lifespan of the well.

In emergency situations, when the best water available is immediately needed, a number of substitute materials and techniques can be used. For example, wood lining can be used instead of cement. Wells built with wood or other substitute materials and techniques will supply acceptable water for a short period of time. However, they cannot now or in the future be converted into permanent sources of clean water without rebuilding major portions of the structure.

3. Materials for Well Parts

The two most important sections of the well are the lining (or casing), and the bottom (or intake) section. While it is not necessary that both be built of the same material, it is often cheaper and more convenient to do so. Almost all modern well linings are made of either concrete or pipe (metal or plastic).

Nowadays, concrete is used most often in the lining of hand-dug wells. It can be easily mixed and cast in place in the well. Reinforcing bars can be added to either mortar or concrete to make a much stronger and more durable lining. (See Appendix IV, Concrete.)

Metal pipe is normally used in the construction of drilled wells. It can easily be shaped to make the necessary tools with which to sink the well and can also serve as the permanent casing and bottom section.

Plastic pipe is too soft to use during drilling but is in many situations a better casing than metal pipe, because it will not rust or corrode.

Cement and pipe are available in most countries and usually in all but the most remote regions. When both materials are available, consider such factors as transportation, type of well, depth, ease of construction, and adaptability to local practices before deciding which is the more appropriate.

J. Tools and Equipment

The choice of tools and equipment will depend on the construction material and its use. Many basic tools can be used to perform a number of different functions. However, a job is more easily and quickly done with the tool designed for that job. The following are the tools and equipment recommended for wells construction: hammer, nails, wood, saw, hacksaw, chisel, mason's trowel, level, shovel, mixing hoe, pick, ruler, plumb-bob, buckets, heavy rope, pulley, square, pliers, crow-bar, wrenches, pipe wrenches, screwdriver, file, mason's hammer, tie wire, sheet metal, pipe cutter, tripod, and pipe threader. For specifics, see the chapters on sinking methods in the sections on Dug Wells (Chapters 7-8) and Drilled Wells (Chapters 12-14).

K. Sinking Method

A sinking method is a specific way of sinking a well. Wells may be dug by hand, drilled with hand tools, or drilled with motorized equipment. Many methods and techniques are used. The particular choice depends on the available materials and equipment, the expected ground conditions at the well site, and your familiarity with a specific sinking technique.

Motorized drilling techniques are summarized in the section on Drilled Wells, but are not described in detail because of the high level of technical expertise necessary in the use of the equipment.

The following are general descriptions of hand-dug and hand-drilled sinking methods. For more details, see the manual sections on Hand-Dug Wells and Drilled Wells.

1. Hand-dug wells are sunk by digging a hole as deep as is necessary to reach water. Once the water bearing layer is reached, it should be penetrated as far as possible. This process is always basically the same, with only minor variations because of the particular tools and equipment available and the variety of ground conditions (see Fig. 1-3).

Advantages

- This procedure is a very flexible one. It can be easily adapted with a minimum of equipment to a variety of soil conditions, as long as cement is available.
- Because the resulting well is wide-mouthed, it is easily adaptable to simple water-lifting techniques, if pumps are not available or appropriate.
- It provides a reservoir which is useful for accumulating water from ground formations which yield water slowly.

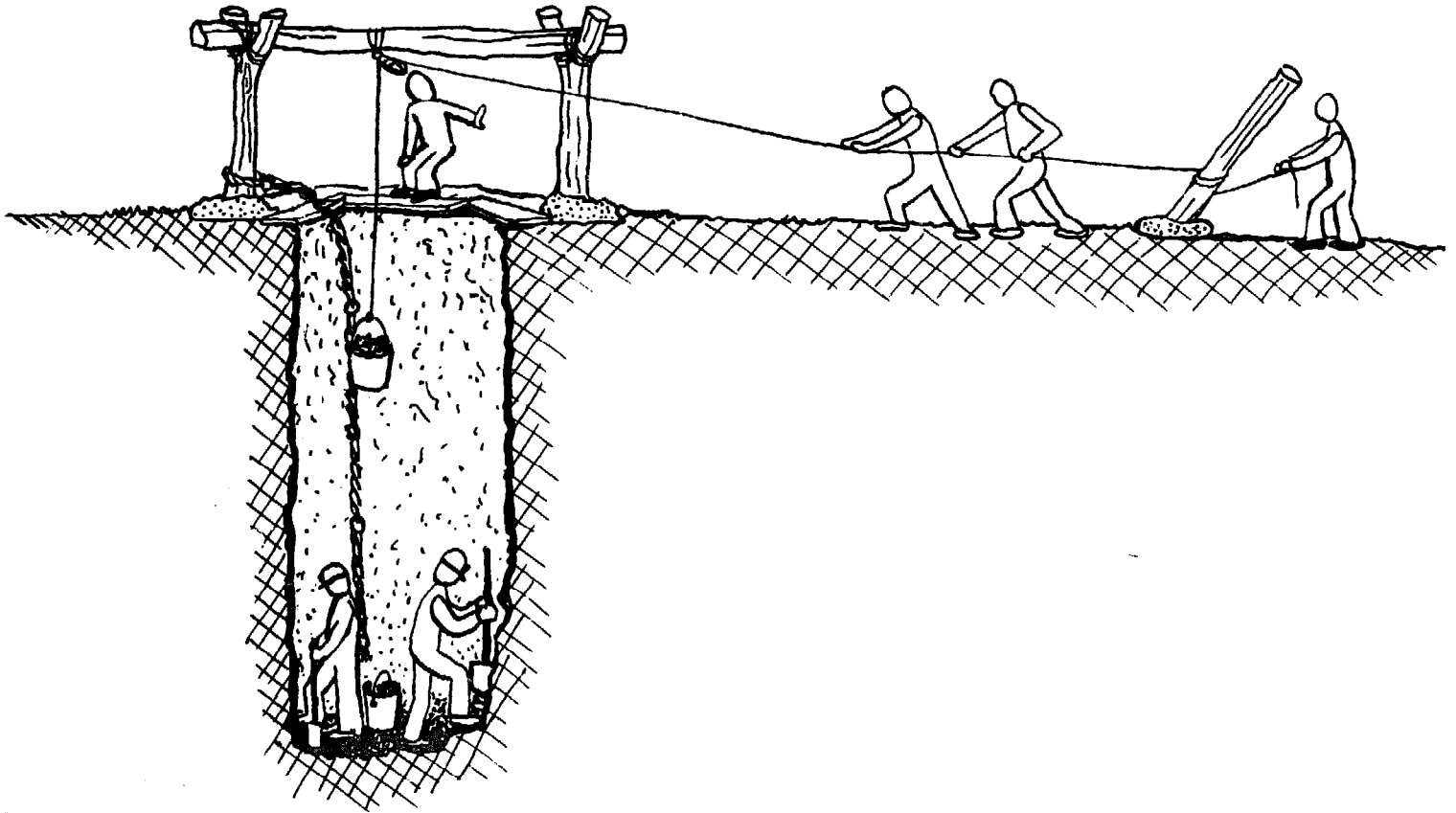

Disadvantages

- A hand-dug well takes longer to construct than a drilled well.
- It is usually more expensive than a hand-drilled well.
- It cannot easily be made into a permanent water source without the use of cement.
- Hand-digging cannot easily penetrate hard ground and rock.

- It may be difficult to penetrate deeply enough into the aquifer so that the well will not dry up in the dry season.

2. Drilled wells are sunk by using a special tool, called a bit, which acts to loosen whatever soil or rock is at the bottom of the hole. It is connected to a shaft or line which extends to the ground surface and above. The part of the shaft or line extending above the ground can then be moved to operate the bit (see Fig. 1-4).

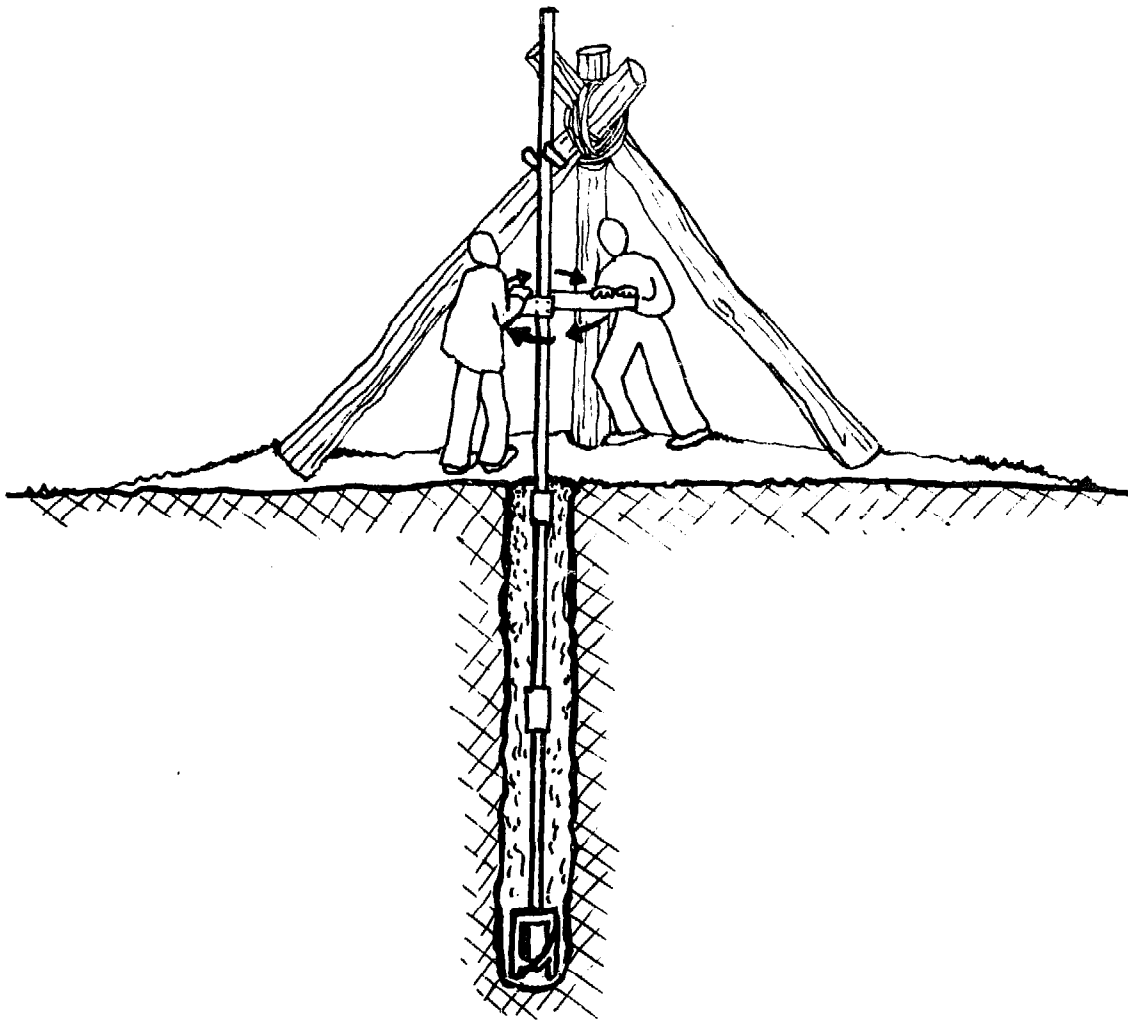

FIG. 1-4. DRILLING A WELL

Advantages

- It is fast.
- Where cement is not available, wells can be sunk with locally made drilling equipment and lined with local materials.

- While not easy, it is possible to penetrate hard ground and rock formations that would be very difficult to dig through.
- Drilling usually requires fewer people than hand-digging.
- It is especially suitable for use in loose sand with a shallow water table.

Disadvantages

- There are a number of different hand-drilling techniques that are suitable for a wide range of ground conditions. However, each requires special equipment.
- Pumps almost always have to be used because buckets are too large to be lowered into the well.
- Limited depth can be reached with hand-powered drilling equipment.

Suitability of Well Construction Methods
to Different Geological Conditions

Characteristics	Types of Wells		
	Dug	Hand Drilled	Machine Drilled
Range of practical depths (general order of magnitude)	0-30 meters	0-30 meters	0-300 meters
Diameter	1- 6 meters	0.05-0.30 meters	0.1-0.5 meters
Type of geological formation:			
Clay	Yes	Yes	Yes
Silt	Yes	Yes	Yes
Sand	Yes	Yes	Yes
Gravel	Yes	Yes	Yes
Cemented gravel	Yes	No	Yes
Boulders	Yes	Yes, if less than well diameter	Yes, when in firm bedding
Sandstone , Limestone	Yes, if soft and/or fractured	Yes, if soft and/or fractured	Yes
Dense igneous rock	No	No	No

L. Preparation for Construction

Once you have decided how to sink the well and what materials to use, you need to organize and prepare for the construction.

1. Workers

It is best if local laborers perform as much of the work as they are capable of performing without spending too much time in training. This will allow them to better understand the well, its construction, and later maintenance needs.

With any laborers it should be very clearly established before construction begins who is expected to do what, how long it should take, and what quality the end product should be. Any later misunderstandings can be more easily cleared up if an initial understanding was agreed to by all parties.

Consider the following questions concerning the workers:

- What skills are required?
- Will the workers require training?
- If so, how much training?
- How many workers are needed?
- How long will their services be needed?
- Will they volunteer their work or will they be paid?

NOTE: While you can be of assistance, it is important to let the community set their own goals.

2. Materials

Before the construction begins, it is helpful to have at the well site as many of the tools, equipment, and supplies as you think will be necessary to complete the job. This prior organization will facilitate the day-to-day operation. If large quantities of supplies

will need to be stored at the site (such as the sand and gravel for concrete) , the storage site should be decided on beforehand so as not to interfere with later work. If theft is a serious problem, workers may have to take turns guarding the construction site at night.

M. Planning

Planning the construction of a well can be complicated. There is the necessity to find the appropriate material, the initial decision as to which sinking method will be used, and the complexity in assessing the ground conditions of the well site. These factors are difficult ones to evaluate, especially when information about local conditions is incomplete. Because situations change, the feasibility studies and planning may have to be repeated and updated before well construction begins.

To help you to plan effectively, the following is an outline of the wells construction process.

Overview of Well Construction

Initial feasibility questions

- Is there a need for water?
- Is a well the most appropriate water source to build?
- Are construction materials available?
- Who can do the work?

Community involvement

- How will the community participate?
- What training is needed?
- How will they be organized?

Technical questions

- Where will the well be sunk?
- How will the well be sunk?
- How will the well be designed to best prevent water contamination?

Construction of the middle section

- Initial site preparation.
- Sinking the hole.
- Lining (casing) the hole.

Construction of the bottom section

- Testing the quality and quantity of water available.
- Sinking and lining below the water table.
- Constructing the bottom plug or filter.

Construction of the top section

- Building the head wall.
- Constructing the platform.
- Installing the pump.

Well disinfection before initial use

Maintenance - The question of who will maintain the well and pump after their construction should be realistically resolved before construction.

After you have read the rest of the manual and have decided how you can best sink a well, you should use this overview as a checklist to make sure that you have considered all the necessary aspects of wells construction.

Section 2:
HAND DUG WELLS

FIGURE A
CROSS SECTION OF HAND DUG WELL

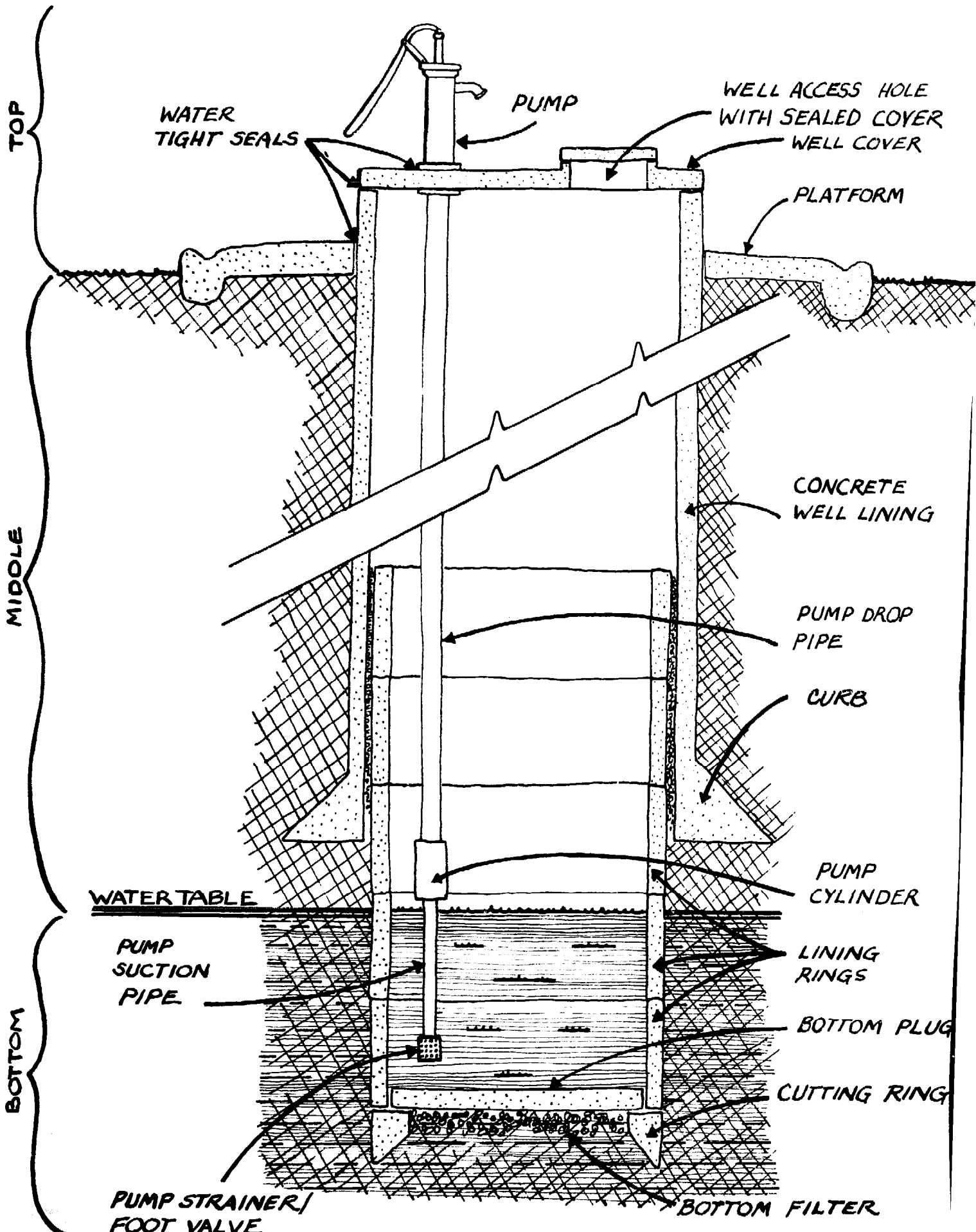

Chapter 2

INTRODUCTION TO HAND-DUG WELLS

A. Overview

Rural communities have frequently employed hand-dug wells to increase the supply of water available for individual use. Using simple construction techniques and suitable materials, hand-dug wells can provide reliable sources of water and offer the following advantages:

- Because the community can be involved in the actual construction, it is "their" well, which they are more likely to maintain.
- The equipment needed is light and simple and thus suitable for use in remote areas.
- The construction techniques are easily taught to unskilled workers, thus cutting supervision time.
- With the exceptions of cement and reinforcing rods, the necessary materials are usually locally available, making it one of the cheapest methods of wells construction in a rural community.
- A completed well provides a reservoir at the source which will accumulate and store water from aquifers that would otherwise be too weak to use.

On the other hand, hand-dug wells present certain limitations:

- 60 meters is usually the practical limit to the depth that can be reached, although most dug wells are less than 20 meters deep.
- Construction is slow.
- Extracting large quantities of water with motorized pumps is not feasible.
- Hard rock is very difficult to penetrate and often can only be accomplished by blasting, which is slow, hard work.
- Because it is difficult to penetrate very far into the aquifer, slight fluctuations in the water table often make hand-dug wells unpredictable and unreliable.

The hand-dug well is the only method of well construction where people actually go into the well to work. An educational campaign to demonstrate and explain what each part of the well is and how it works might help villagers understand and then want to work with and maintain it more. In so doing, proper maintenance necessary in keeping the well functioning might be better carried out, particularly in communities using a well or an improved water source for the first time.

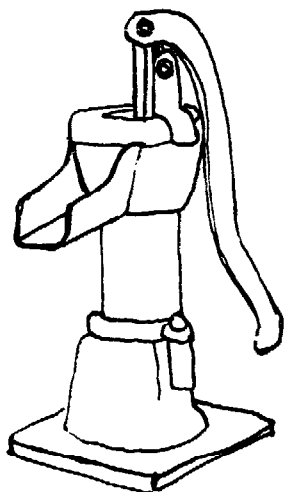

For sanitation reasons a pump is desirable. If installed on a hand-dug well with a full cover, a pump will help reduce chances of contamination significantly. In rural areas where pump maintenance and repair can be a real problem, large diameter wells are often the best solution to water supply problems. Pumps can be installed while leaving an accessway through which water can be drawn by rope and bucket if the pump should break down. (See Pumps Appendix).

Compared to other well sinking methods, digging a well by hand takes a long time. An organized and experienced construction team consisting of five workers plus enough people to lower and raise loads in the well can dig and line 1 meter per day in relatively loose soil that does not cave in. However, the bottom section is likely to take 2 or 3 days per meter because of the difficulty in working while water continually enters the well. Depending on how you plan to develop the well, the top section can take anywhere from a day or two to several weeks. An experienced team sinking a 20 meter well and installing pulleys on the top structure could easily take 5 weeks, including occasional days off (this, of course, assumes no major delays). A new or inexperienced group would be expected to take twice that time.

Hand-dug wells should be dug during the dry season when the water table is likely to be at or near its lowest point. The well can be sunk deeper with less interference from water flowing into it. The greater depth should also ensure a year-round supply of water.

If the well cannot be dug during the dry season, plan to go back to it at the end of the dry season to deepen it.

B. Work Outline

Outlined below are the major steps involved in digging a well. The appropriate community leaders, health committee, public works committee, and others who are interested should be involved in all the planning decisions.

- Begin community education and awareness activities to enable the people to understand what is happening and how they can benefit.
- Choose a well site based on geological factors, user preference, sanitary conditions, and accessibility.
- Determine available expertise - people (including yourself) with well or general construction experience.
- Assess materials available - tools, cement, reinforcement rods (re-rods), sand, gravel, wood.
- Select methods of construction that are most suitable for the use and available materials, considering shape, size, depth, lining, bottom, and top.
- Plan and begin any training that will be necessary for workers.
- Before construction begins, put down in writing the workplan for the construction of the entire well.
- Gather all equipment and materials needed for construction of the well at the well site. Arrange these at the site so as to facilitate construction as much as possible.
- If concrete lining rings are to be used, begin constructing them in advance. Each ring must be cured for at least 4 days before it is put in place at the well head.
- Lay out the hole with provisions for checking diameter and plumb (see p. 53).
- Arrange for people and materials to get in and out of the well.

- Dig and line the middle section.,
- Continue the digging and lining procedure until
 - (1) you reach water, or
 - (2) some obstruction causes you to
 - (a) change digging/lining procedure
 - (b) abandon this well and pick a new site.
- Dig and line the bottom section as far as possible into the aquifer. The method used to dig and line the bottom section will often be different from the digging and lining method used in the middle section. This may be necessary because you are not only concerned with digging, lining, and possible hole collapse (as in the middle section), but also with removing enough water from the well to permit work to continue.
- Install a simple sand and gravel filter or porous concrete plug across the bottom of hole.
- Extend the lining up above ground to form the head wall.
- Build and install the well cover.
- Install the pump in the cover on the well.
- Disinfect the well.
- Build the apron (platform) around the head wall to channel the run-off to one particular place.
- Build a drainage pit or other device for removal of standing water.*
- Build an animal trough.*
- Build a wash-basin platform.*

*These items are not always necessary but should be considered.

Chapter 3

WELL DESIGN

A. Introduction

To design a well, it is necessary to decide what materials will be used and how they will be put together. This includes determining:

- the size and shape of the hole;
- which digging and lining methods will be followed;
- how much water needs to be available, and, therefore, how deep the bottom section should go into the aquifer;
- how the top section should be constructed to best protect the well from contamination, while allowing easy access to water by those who will use the well;
- the anticipated well depth.

This chapter discusses the decisions that must be made and presents options for consideration.

B. Well Shape

The shape of the well is what it would look like if you were looking straight down into it.

C. Well Size

The size of the well is a measure of how wide it is. Some holes are very large, and some are very small. The size will be largely determined by: (1) the way it is excavated, (2) the materials used to line it, and (3) the purpose of the well.

The size of the round hole is usually expressed by its diameter, a measurement from one edge of the hole through the midpoint of the well to the other side of the circle. (See Figs. 3-2 and 3-3.)

Although wells can be dug in any shape, almost all wells are round. The reason for this is that a round well produces the greatest amount of water for the least amount

of work. Also, a round lining is the strongest that can be built for the smallest quantity of materials. Thus, while other well shapes have been used without problems, a round shape enables the builder to get the most from available time, money, and materials.

Square or rectangular wells are usually dug where materials to be used in lining the well necessitate such a shape. This is most often the case when flat wood boards are the only lining materials available. Wood, however, is not recommended for several reasons which will be discussed later. (See p. 74.)

FIG. 3-1. SQUARE WELL

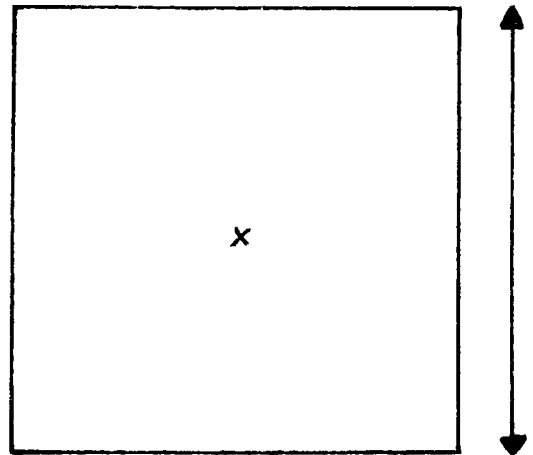

1. Well Size-Diameter

Before the actual digging work begins, the exact diameter of the hole must be decided (see Figs. 3-2 and 3-3).

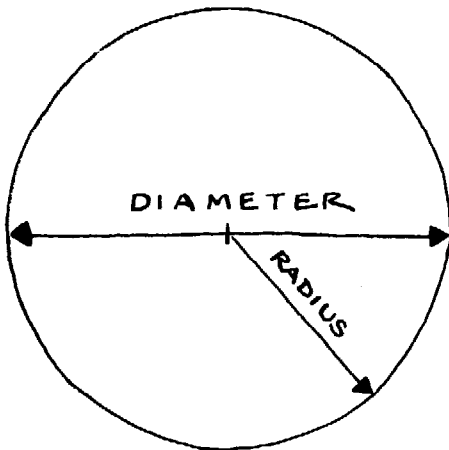

FIG. 3-2. ROUND WELL

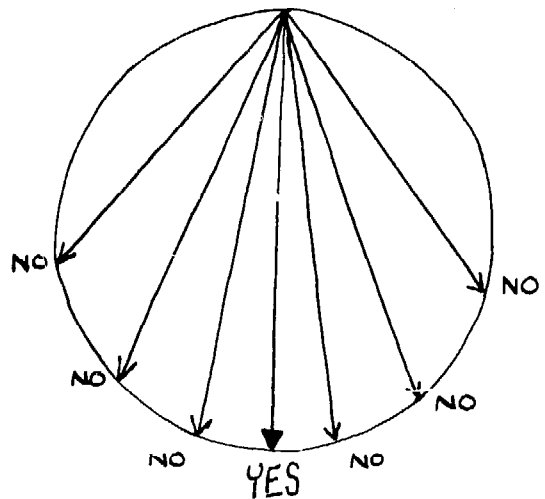

FIG. 3-3. DIAMETER IS THE LONGEST MEASUREMENT ACROSS THE HOLE

Many factors could determine which diameter should be used.

- If there is a government-sponsored organization or agency which does wells construction using a standard diameter, you should consider using the same diameter. Doing so will make the eventual incorporation of the well into community and government planning and development much easier.
- If forms or pre-cast lining sections are available, you might consider using them. It would necessitate choosing an appropriate diameter for the particular equipment you have. However, if the former situation (mentioned above) also exists, it should in most cases receive priority.

Generally, the choice of diameter will be based on two considerations. The well should have (a) the smallest diameter which still provides (b) a comfortable working space for the number of people that will be working in the well at one time.

a. The smaller the diameter of the well, the less soil and rock will have to be dug and the less materials will be required to line the well. Remember, if you double the diameter of the well, you increase the amount of soil and rock that must be dug by four times. For example, as indicated in the table below, a 1.0-meter diameter well 20 meters deep requires removal of 15.7 cubic meters (m^3) of material while a 2.0-meter diameter well 20 meters deep will require the removal of 62.8 m^3 .

Diameter x Diameter x 0.7854 = Area.
Area x Depth = Volume

Diameter	Area	Depth	Volume
1.0 m	0.79 m^2	20 m	15.7 m^3
1.1	0.95	20	19.0
1.2	1.13	20	22.6
1.3	1.33	20	26.6
1.4	1.54	20	30.8
1.5	1.77	20	35.4
1.6	2.01	20	40.2
1.7	2.27	20	45.4
1.8	2.54	20	50.8
1.9	2.84	20	56.8
2.0	3.14	20	62.8

b. The workers will need enough space so that they are not hampered in their work. There must be enough space for them to use their tools and for the bucket which will remove excavated materials from the well. Without enough space, they will continually bump into each other and the wall. During stages of its construction, a well may have two or sometimes three different diameters (see Fig. 3-4).

(1) The hole is dug to the diameter decided upon.

(2) When a lining is installed, the diameter is further reduced along with the available working space.

(3) You may be installing the bottom section lining inside the existing lining. This will further reduce the diameter.

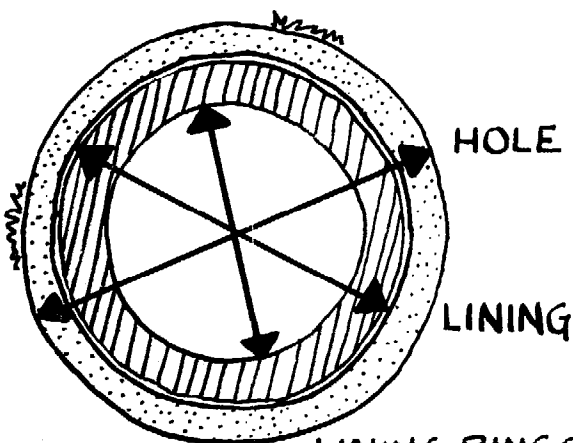
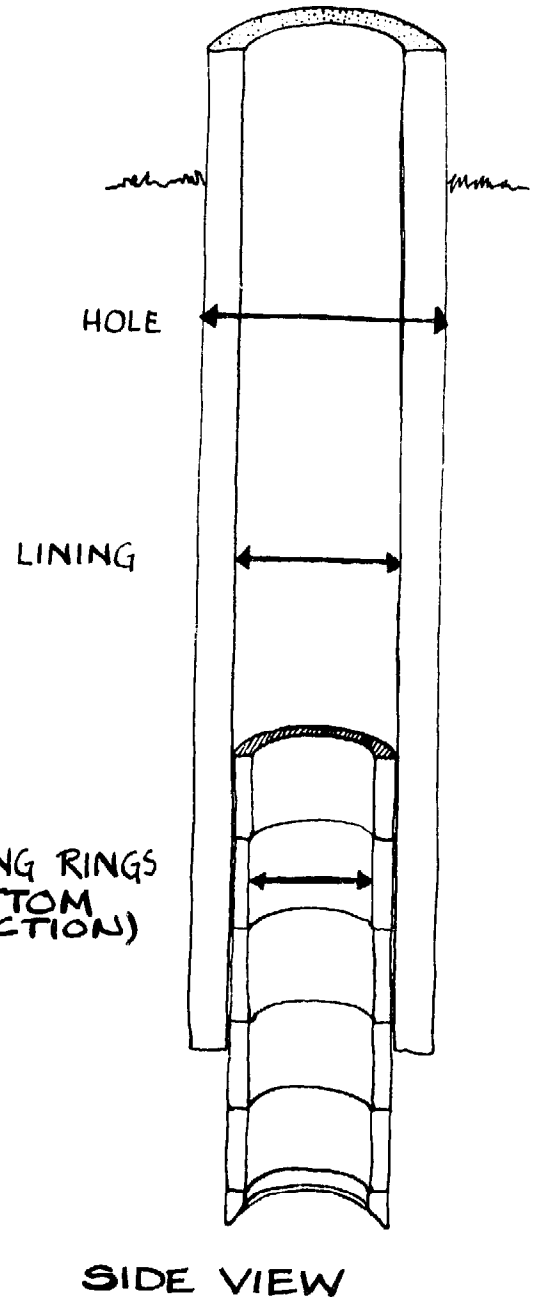

TOP VIEW

FIG. 3-4. THREE DIFFERENT WELL DIAMETERS USED DURING CONSTRUCTION.

D. Ground Conditions and Lining

It is very difficult to anticipate what the final depth of a well will be before it is begun. However, if there are other wells in the area, it is possible to get an idea of the approximate depth of the water table. This can be a great help when gathering supplies needed for lining construction, because it will enable you to stock-pile approximately enough materials to complete the well.

All wells, except those drilled through rock, can be expected to cave in with time unless a lining is installed to support the well. The lining thus helps to keep the well open. There are certain acts of nature, such as earthquakes or even gradual ground shifts, which will break even the strongest linings, but these cannot be planned for or anticipated. Occasionally slight ground shifts can put pressure on linings causing them to split and separate if not strongly built. Geologists can usually predict where such shifts are likely to occur. If no such information is available, it is recommended that you build the lining strongly enough to withstand normal earth stresses.

Depending on ground conditions, you may or may not be able to dig the complete hole and then line it. In very loose sandy soil, for example, the sand from the walls of the hole will frequently cave into the hole, seriously hampering efforts to deepen the hole. There are often relatively simple methods of dealing with such problems (see p. 58).

Designing the lining for the middle section is largely a matter of assessing the ground conditions and materials availability to determine the lining materials and method most appropriate for the situation.

1. Ground Conditions

- Very loose soil (example: dry sand) - the hole is as wide as the hole is deep because its sides continually collapse and cave in (Fig. 3-5a).
- Loose soil (example: damp sand) - a relatively shallow (1 to 5 meters) hole can be dug before its sides may cave in Fig. 3-5b.
- Firm soil (example: compacted clay and sand mix) - a hole can be dug to the water table with minimal danger of collapse and cave in Fig. 3-5c.

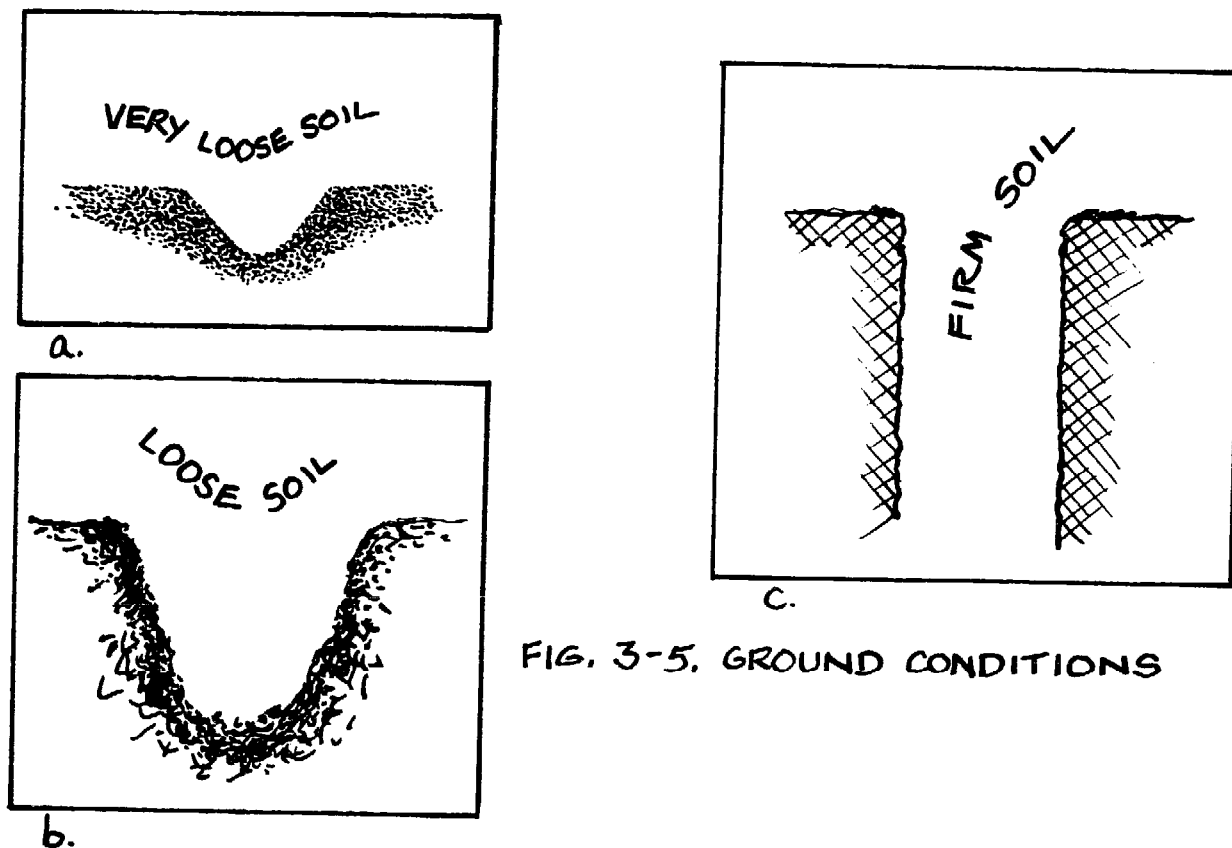

FIG. 3-5. GROUND CONDITIONS

Unless you have had substantial experience digging in the area and this particular type of soil, or have been trained in the identification of soils and their properties, do not leave the hole unlined for more than 5 meters.

The only possible advantage to digging the entire hole first is that you can then be certain that water can be reached before you start using your often expensive materials to line the well. However, if there is any question about the safety of working in an unlined section of the well, it is not worth the gamble to leave it unlined.

2. Dig and line options

● Dig a short section and line

One source has suggested that for safety reasons, no more than 5 meters of a well should be dug and left unlined. More commonly, this cautious method is used in loose soil. This means of construction is also recommended in all soils when workers are inexperienced. Using this method, wells are dug in 0.5 to 5 meter sections, and then lined.

- Dig to water table and line

This method is commonly used in firm soil, especially where the water table is not very deep. It has the previously mentioned advantage of not using any expensive materials in a well until a good supply of water can be assured. However, this method should not be attempted by workers inexperienced with well work.

- Dig complete well and then line

This method is not recommended because of the danger of cave-ins beneath the water table which would undermine the entire well shaft. The only situation in which this method might be justified is where the middle section lining must rest on the bottom section lining for support, but there are many ways of avoiding that necessity.

E. Design: The Bottom Section

There are two basic methods for constructing the bottom section - sink lining and dig-and-line.

1. Sink lining into place. Advantages include:

- The method protects workers from cave-ins during sinking;
- Workers in the well can put all their effort into removing soil and water, presumably allowing greater well penetration into the aquifer.

A disadvantage is the possibility that workers may have difficulty in firmly attaching the rings together. (See lining rings, Fig. A.)

2. Dig and then line. Advantages include:

- The method requires less special preparation;
- The bottom section lining attaches directly to the lower part of the middle section lining, thus producing a stronger, continuous structure.

The disadvantages include:

- Workers probably cannot get as far into the aquifer as in the other method because of the necessity for workers to remove soil and water and place reinforcing rod and concrete at the same time;
- There is greater possibility of cave-ins because of a need to work beneath concrete that has not had time to completely set;
- The method may require special fast-setting cement so as not to be washed away by water entering the well.

The purpose of the bottom section is to allow as much water as possible into the well without permitting any of the fine soil particles from the surrounding aquifer to enter the well.

There are three commonly used methods of allowing water to enter the well. (See Fig. 3-6.)

- Through porous concrete lining - Lining rings sunk into the bottom section can be made of porous concrete which acts as a filter to prevent soil particles from entering the well.
- Through angled holes in the lining - Holes can be punched in a freshly poured concrete ring which, when cured, can be sunk into the bottom section. These holes are more effective at preventing soil entry if they are slanted up toward the middle of the well.
- Through the bottom - The bottom of the well should always be constructed to allow water to come up through it. Often the bottom is simply left open and uncovered but it is preferable to prevent soil entry and the gradual filling up of the well.

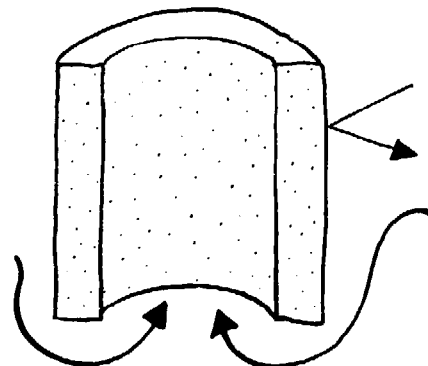
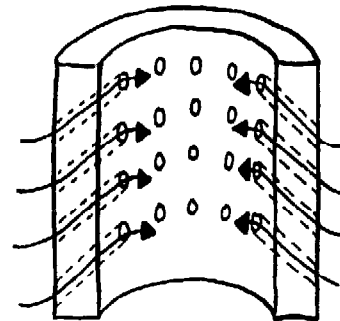
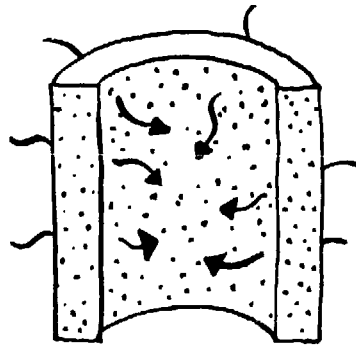

FIG. 3-6. WATER ENTRY INTO WELL

F. Design: Top Section

The purpose of the top section is to provide safe and easy access to well water and to prevent as much contaminated surface materials as possible from entering the well.

The design of the top section is strongly influenced by two aspects of well usage: (1) access to water or how water is drawn from the well, and (2) preventing, as much as possible, surface contaminants from entering the water. These two functions are not always compatible. It is often necessary to compromise sanitation for the sake of water access and community acceptance. Obviously you want to do this as little as possible but not to the point of jeopardizing support from the local community or government.

A top section, in fact, is not absolutely necessary for the function of a well. However, the different design of the parts of the top section is intended to make the well safer, cleaner, and more convenient for users.

Here are the major components of the top section:

- Head wall;
- Drainage apron (platform);
- Cover;
- Animal trough;
- Wash basin.

1. Head wall

A head wall should be built on all wells which will not be fitted with a permanent cover and a pump as a simple inexpensive safety feature which will prevent people and animals from accidentally falling in.

This is simply a wall which extends above the surface of the ground far enough to prevent most accidental entry of people, particularly children, and animals. Its external dimension is dependent on how thick you want the head wall to be. A head wall that is unnecessarily thick will encourage people to stand on it to draw their water, creating an unsafe situation. The easiest and best way to construct the head wall is as an extension of the lining. In most cases it will be convenient to build the head wall as an extension of the lining

above ground. You will already have the equipment and supplies on site with which to do this. The head wall should extend 80 to 100 cm above the ground surface or apron, if there is one (see Fig. 3-7).

FIG. 3-7. TOP SECTION

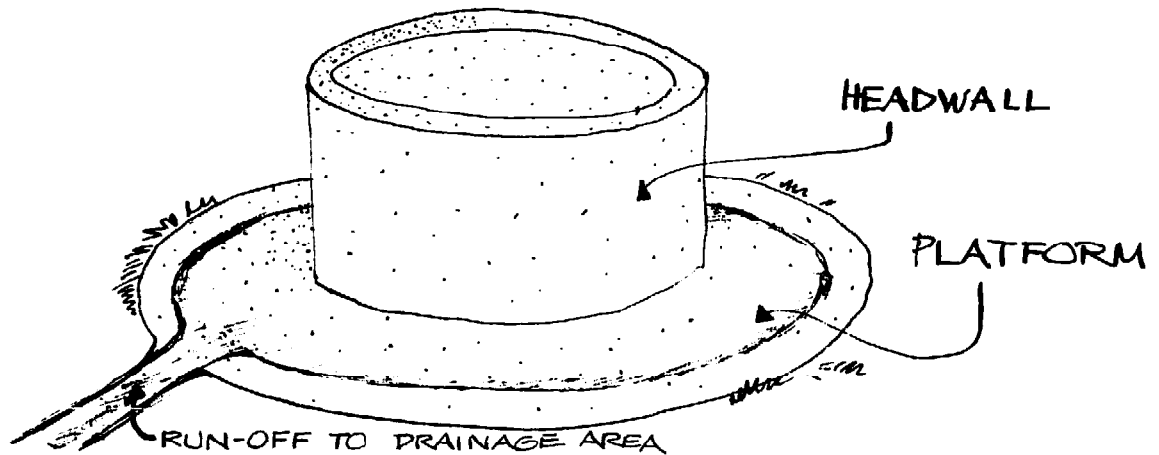

2. Drainage apron (platform) (See Fig. A.)

A drainage apron is most often a reinforced concrete slab 1 to 2 meters wide which surrounds a well and, because of its slight slope, channels surface water away from the well. Wire mesh reinforcing may be used if it is available.

By forcing water to flow away from the well, the apron serves two functions:

- It prevents contaminated surface water from following the outside of the lining and flowing back down into the well before it has had a chance to be sufficiently filtered by the earth.
- It prevents the formation of a mucky area immediately around the well which can be a breeding ground for disease and a source of contaminants to the well water.

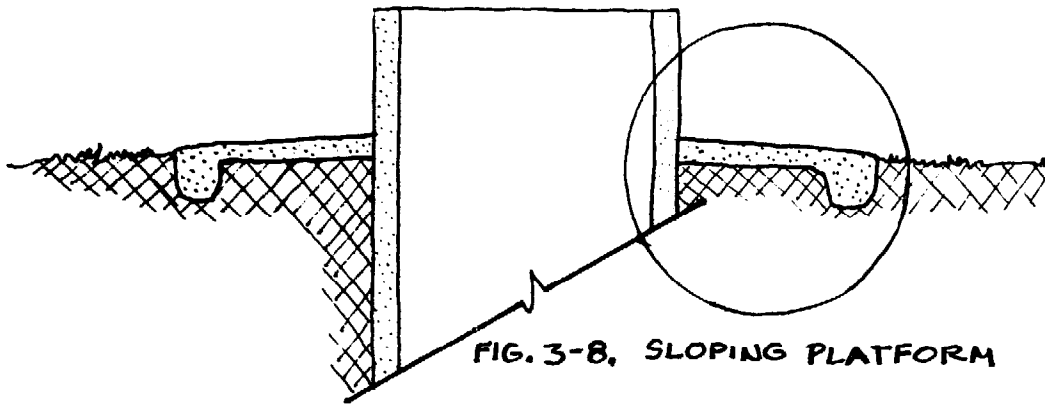

FIG. 3-8. SLOPING PLATFORM

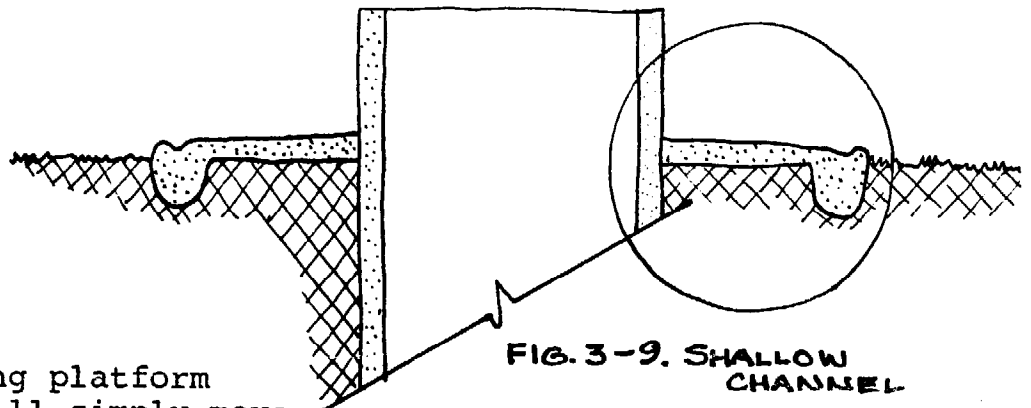

FIG. 3-9. SHALLOW CHANNEL

A sloping platform (Fig. 3-8) will simply move the mucky area from direct contact with the head wall to the edge of the platform. It will still be an eyesore and health hazard, although not so much as if it were right next to the well.

By installing a shallow channel (Fig. 3-9) or very short wall (Fig. 3-10) around the edge of the platform, the water can be funnelled off to one specific area away from the well where people and animals will not have to track through it to get to the well.

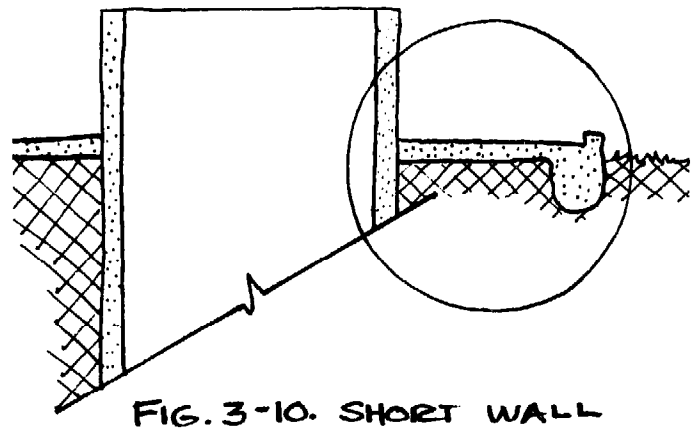

FIG. 3-10. SHORT WALL

The apron should be strongly and carefully constructed as it will receive a lot of wear, and any cracks or chips which develop will decrease the effectiveness of the apron.

An apron can be built of stone with mortared joints if cement is in short supply. If for some reason it is not feasible to build an apron, dirt should be built up around the well so that water spilled will tend to run off away from the well rather than collect around it.

3. Cover

A cover can improve the sanitary quality of the water in the well by preventing the dust and dirt normally carried in the air from entering and contaminating the water. It also prevents people from dropping things into the well.

There are two basic variations of well covers—temporary (removable) and permanent (fixed in place).

- A temporary cover would be one that covers the well between the times it is being used, but must be removed to pull water from the well. For example, a temporary cover would be a wooden cover that rests on top of the well but must be removed to throw a bucket, tied to a rope, into the well. This is a limited step toward protecting the well water from surface contamination.
- A permanent cover is usually made of reinforced concrete. It can be poured in place on the well or pre-cast in one or more pieces and later set over the well. (See Fig. 9-9.) Pump mounting bolts and an access door can be cast into the concrete. Pre-casting the cover in one or two pieces may be easier because of the difficulty of building a form which is both strong enough to support the weight of the concrete over the open well and which can then be removed after the concrete has set.

4. Drainage pit

In some areas it may be necessary to construct a special drainage pit to allow spilled and run-off water to soak into the ground. This may be used where other measures cannot feasibly prevent the build-up of standing water. If such a pit is deemed necessary, make sure that it is at least 10 meters from the well. The pit can simply be a hole dug in the ground which is then filled with loose rock and gravel.

NOTE: Where the water table is less than 3 meters from the surface, a drainage pit should not be dug because of the danger of directly contaminating the water supply.

5. Animal trough

If an animal trough is necessary, it should be built far enough from the well so that neither the animals nor their dung will collect around the well and thus contaminate the water.

6. Wash basin

It may be useful to build a wash basin if clothes washing is done at the well. It is important to prevent wash water from pouring back into the well and thus contaminating it. The basin should, therefore, be watertight and built at an elevation below the mouth of the well. Where there is no place to build a basin below the level of the well, it can be located 10 meters from the well.

Chapter 4

SUPPLIESA. Introduction

Supplies include the materials, tools, and equipment necessary for construction of the well.

The following supplies will be needed for construction of any hand dug well:

- digging tools - shovel, pick, mattock;
- equipment to lower and lift people and supplies in and out of the well;
- construction material and the tools needed to work with it.

Tools that may be used with the various materials include the following:

- reinforced concrete - cement, sand, gravel, forms, reinforcing-rod, tie wire, re-rod cutter, re-rod bender, wire cutters, pliers, buckets, 1 trowel (2 would be better), mixing hoes, aggregate gauge box;
- concrete - cement, sand, brick or rock, mixing area, buckets, trowel, mixing hoes, aggregate gauge box;
- wood - wood, saw, nails, hammer.

B. Tools and Equipment

- lowering equipment - tripod, headframe or pulley support with pulley;
- cable or rope - 12 mm steel or 25 mm hemp;
- buckets - 1 large, 2 small;
- square nosed shovel (mixing);

- round nosed shovel (digging);
- hammer;
- hard hat for each worker in well;
- spare shovel and hammer handles;
- plumb bob and plumb line;
- level.

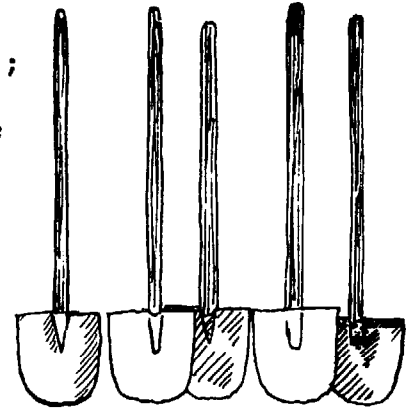

C. Materials

1. Cement

Most of the lining methods discussed here rely on the use of cement in one form or another, including concrete, mortar, and porous concrete. For the construction of permanent, sanitary hand-dug wells, cement compounds are the only materials in common use around the world. There is no other material so readily available worldwide that combines the strength, workability, and adaptability of cement compounds. Without cement it will be very difficult to build a permanent, sanitary water source. (See Cement Appendix, p. 221.)

a. Limited amount of cement available

Where there is a limited supply of cement available which will not permit you to pour linings or build masonry, you might consider building a loose rock or brick wall. Simply mortar the inside layer to prevent it from falling into the well. This should only be attempted in very stable ground not subject to collapse.

In some areas only the top 3 meters of the well needs to be lined. This reinforces the area of the well which is most likely to cave-in and uses a minimum of material, and it can be attempted only where a mortar or concrete lining is built in place in a well which is being sunk in firm soil.

Wells lined like this are rarely more than 10 meters deep.

b. Cement Substitutes

Cement substitutes are sometimes commercially available or can be manufactured locally. Lime, for example, can be mixed with sand and water to

form a mortar-like paste which can be used in laying brick or rock walls. Like other cement substitutes, it does not have anywhere near the bonding strength of cement mortar.

2. Other Materials

If you cannot get cement in a reasonable length of time and at a reasonable cost, you should consider building the well with other materials such as wood or unmortared rock. These other materials will not last as long as cement but they will enable you to make water available where it is needed now.

- Unmortared brick or rock

Many wells have been built of unmortared rock and have lasted for hundreds of years. This, however, is only where highly skilled stone masons and suitable rock are both available.

Normally unmortared brick or rock is only a temporary solution which will collapse in time. Where the ground is very stable, you might consider such a lining, although the well may stand unharmed without a lining for a long time in this case.

This also is only a temporary solution. It will rot soon (in 1-3 years), tainting the water and allowing cave-ins.

D. Organization of supplies at the well site

In your planning consider:

- the space needed for each operation;
- the arrangement of supplies within each operation space;
- which operations must be performed at the same time so that their respective spaces do not conflict or cross;
- that a different lining method may be used for the bottom section which will require space for working and materials.

There are 3 different types of operations which must be performed during the sinking of a well:

- removing excavated soil and rock and dumping it;
- lowering and lifting people and supplies in and out of the well;
- preparation and placement of lining materials.

The purpose of organizing the supplies around the well is to provide comfortable working spaces for each of these operations where they will not conflict with each other but are still close enough to be coordinated and efficient. (See Fig. 4-1)

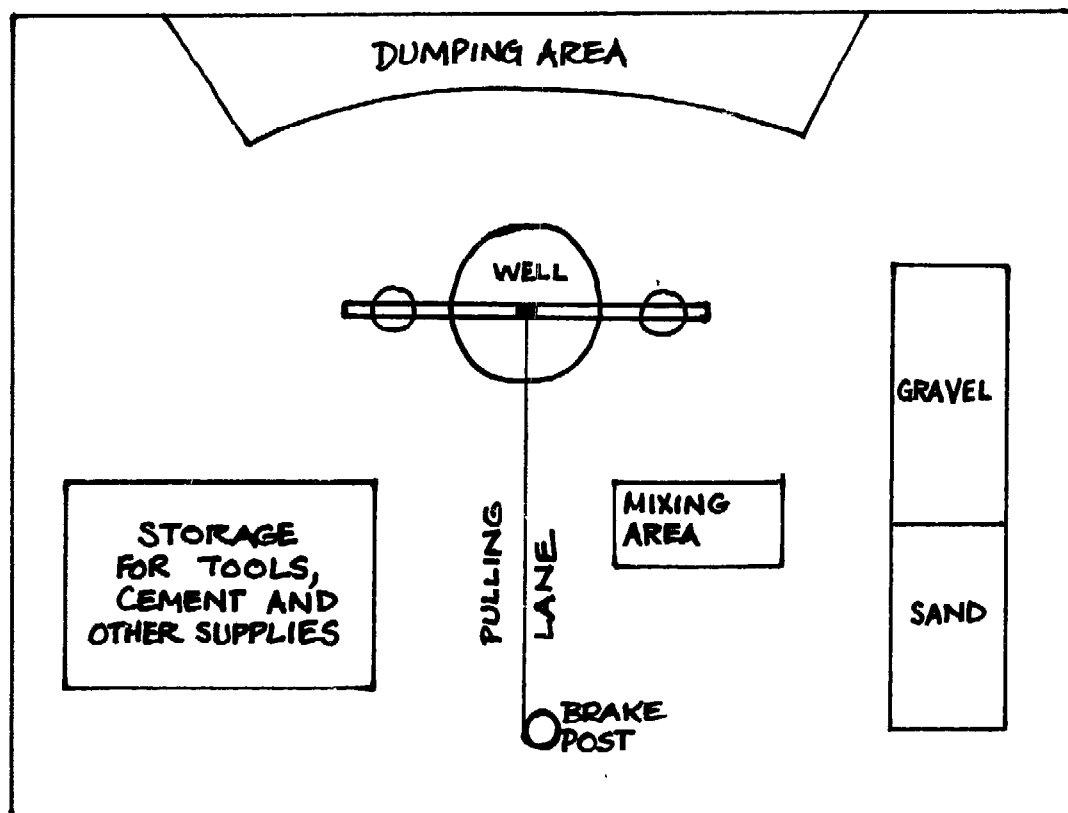

FIG. 4-1.
LAYOUT OF MATERIALS AND SUPPLIES

1. Removing excavated soil and rock and dumping it.

A great deal of time will be spent performing this same basic operation over and over again. As a result workers will be tempted to do the least amount of work

necessary to get by. It is important that the dumping area be:

- far enough away from the well to not subject the well to danger of caving in;
- not so far away as to slow well sinking because excavated material is not being dumped fast enough;
- located so that rain will not wash material back into the well;
- located in order that water pulled from the well for sinking the bottom section will run off and not collect near the well;
- large enough to hold all the material taken from the well.

2. Lowering and lifting people and supplies in and out of the well.

This operation is critical for the whole well sinking process but is also so flexible in its placement that too often it is simply assumed that space can be found after everything is set up. Unnecessary delays and possibly dangerous situations can be avoided in later work by simply arranging the supplies so that nothing ever obstructs the lane the pullers must use to raise and lower supplies in the well. Also avoid placing supplies so that they must cross the pulling lane to be used.

3. The preparation and placement of lining materials.

Most hand dug wells need space to store and later mix sand, water, gravel, and cement to form concrete. The actual mixing area should be close to the well and next to the pulling lane to permit easy movement of concrete into the well. The materials necessary for concrete should be stored near the mixing area but far enough from the well to prevent danger of cave-ins.

Sand and gravel storage will take up a large amount of space, which should preferably be easily accessible from the mixing area and from the opposite side to allow for replenishment if necessary. Also, if you plan to use pre-cast lining rings, you will have to allow space for their construction.

The importance a few minutes worth of planning can have is demonstrated in the following example.

Assume that we have a well with a 1.3m interior finish diameter, a 7.5cm thick reinforced concrete lining, and a depth of 20m--an average sized well. This well will require about fifty 50kg bags of cement for construction of the middle and bottom section. If only complete bags of cement are mixed at a time that will require:

- 50 trips to and from the cement storage area;
- 50 wheelbarrow trips of sand;
- 100 wheelbarrow trips of gravel;
- some multiple of 50 trips to and from the water supply;
- about 500 trips with concrete from the mixing area to the well, depending on the size of the concrete buckets.

Obviously the shorter all these trips can be, the less time and energy will be consumed by them. Remember too that as you take sand and gravel from the near side of the storage piles you have to walk farther and farther.

Chapter 5

LOWERING AND RAISING WORKERS AND EQUIPMENTA. Introduction

- At some point most materials and equipment involved in hand dug wells construction will be lowered into or pulled out of the well. This raising/lowering operation is so basic to wells construction that it will be discussed here in some detail. (See Fig. 5-1)

The raising and lowering operation will eventually become routine because it must be performed so often. Before the real well sinking work is begun, you should try to plan that routine by considering what equipment will be used and how the workers should be organized to use the equipment safely.

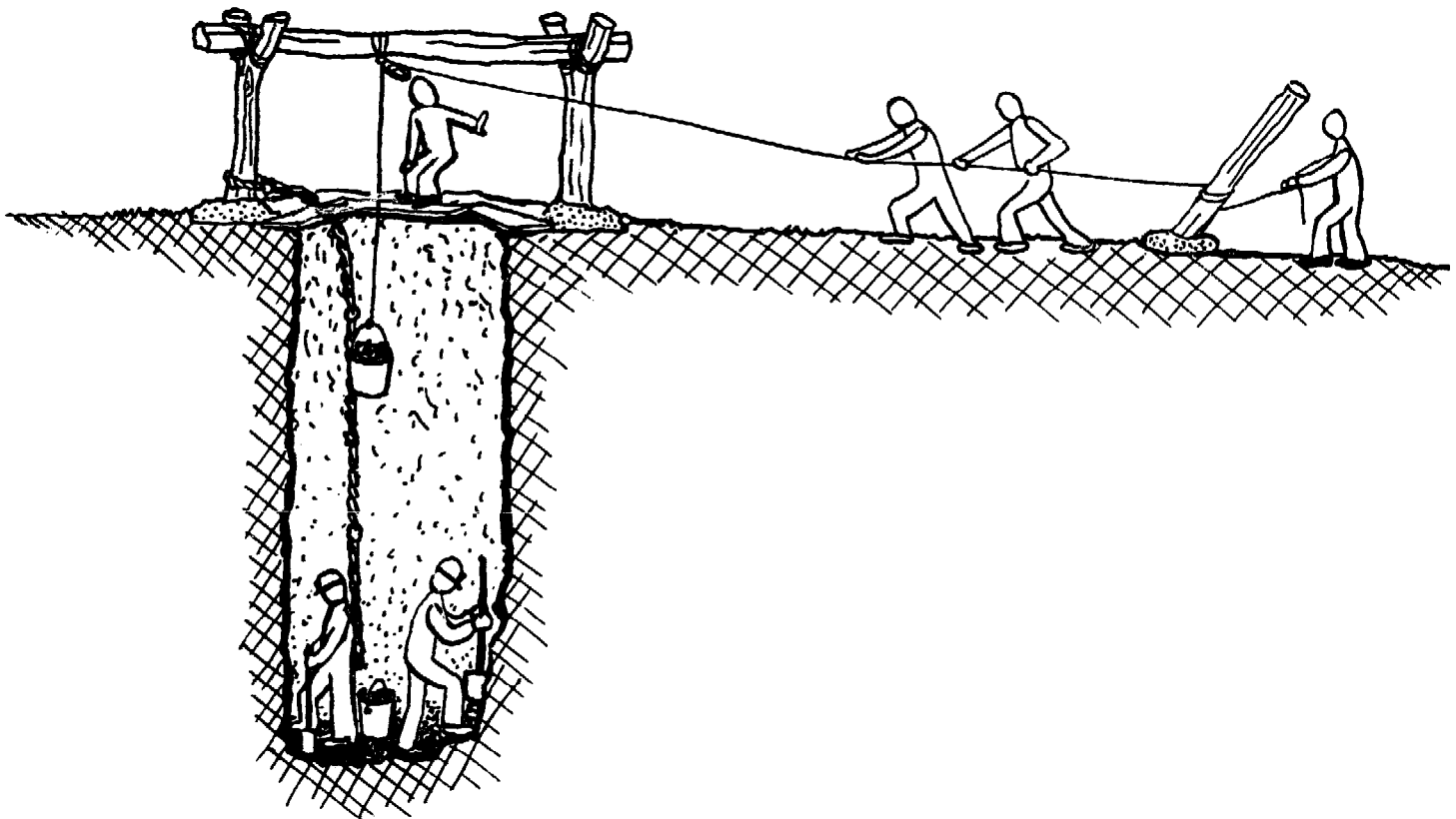
FIG. 5-1. RAISING AND LOWERING OPERATION

B. Safety

Most major accidents or injuries that happen during the construction of a well result from faulty raising and lowering procedures. Accidents usually occur because someone forgot, didn't understand, or wasn't ready to perform his/her part of the operation. Remember that people's lives depend on how carefully this operation is performed.

There are many tools, pieces of equipment and items of knowledge that can help in this operation by making it easier and safer. They include:

- tripod, headframe;
- pulleys;
- winch;
- rope-knots;
- buckets.

Everyone coming in contact with this raising/lowering operation should be thoroughly familiar with it. It is a good idea to do a couple of practice runs so that everyone understands exactly what is involved. Switch people around to help them understand what is happening at different points in the operation. It is also useful to have well workers lowered in and out of the well to help resist any later tendencies for joking while pulling on the rope. That way, everyone understands the reality of being suspended on a rope with no way to help yourself if a problem occurs.

Certain safety features should be followed:

- All workers in the well should wear hard hats;
- People are most safely raised or lowered in the well on a bosun's chair made of a board, log or other appropriately strong seat firmly tied to a rope (see Fig. 5-2).
- Nothing should ever be left lying on the ground near the opening of the hole. In a working situation, people can easily trip and fall, knocking loose materials into the well.

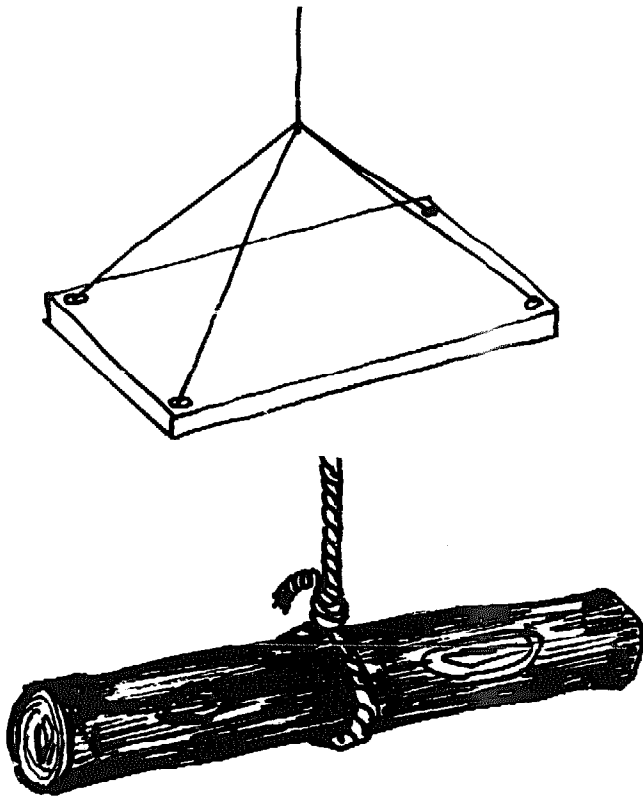

**FIG. 5-2. TWO SUGGESTED
DESIGNS FOR A BOSUN'S
CHAIR**

- It is also necessary to be concerned with the safety of people other than the well workers. Passersby have a natural curiosity and wish to find out what is happening. Before construction is begun, it is very useful to establish some kind of perimeter, or even a fence, which is to be crossed only by those actually involved in construction. This may be difficult enough to enforce during working hours but becomes more important and more difficult at night and on non-working days. It may then be necessary to use a guard to remind passersby that they are not supposed to be in the area. The guard can also make sure that tools and supplies are not taken from the site.

It is very helpful to have a set of signals to control raising and lowering. These should be voice commands as well as hand signals. Four simple signals will usually cover most of your needs (see Fig. 5-3).

- raise;
- lower;
- stop;
- slower.

FIG. 5-3. HAND SIGNALS

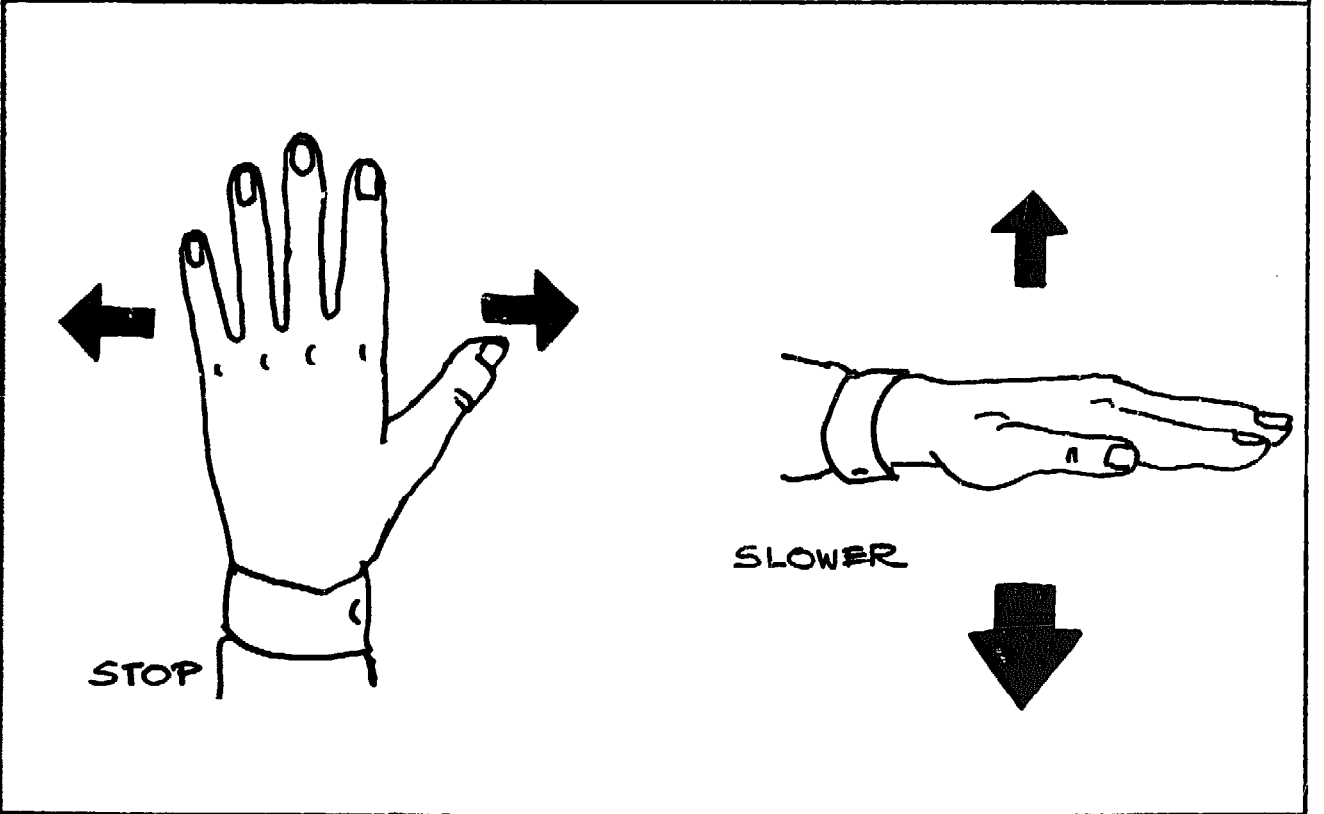
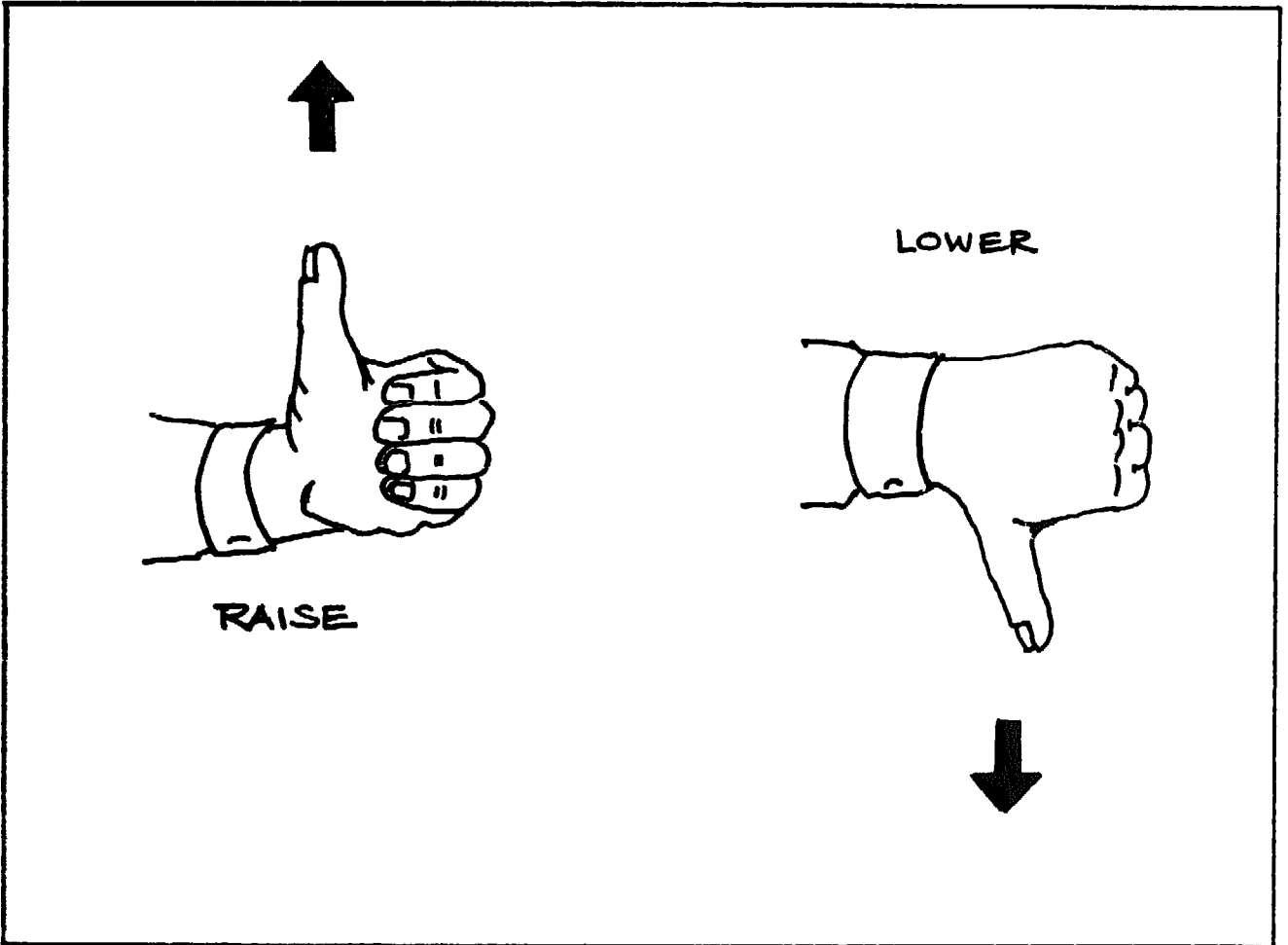

C. Lowering Supports, Tripod, Headframe

Some type of lowering support is necessary when digging, except in very shallow wells. It provides a much safer and easier way to lower tools and materials for use in the well and remove the soil and rock dug up in the hole. Such a structure usually has 1 or 2 pulleys which can be suspended over the center of the hole or offset. The offset arrangement is often easier to work with.

Choose the type of lowering support most suitable for the kind of work you expect to be doing and the materials you have available. (See Figs. 5-4, 5-5, and 5-6.)

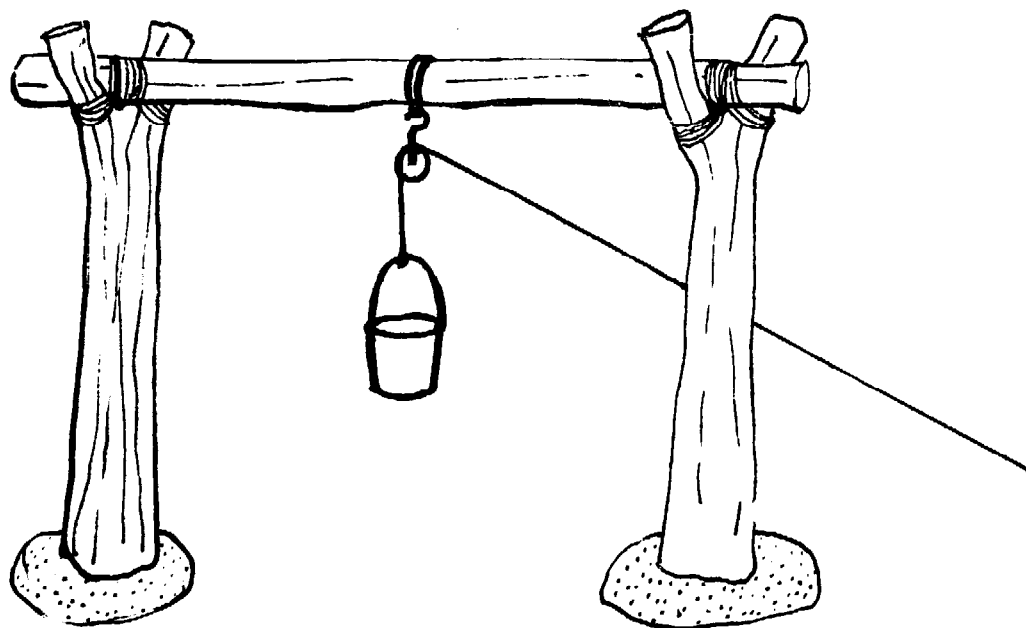

FIG.5-4. WOOD LOWERING SUPPORTS

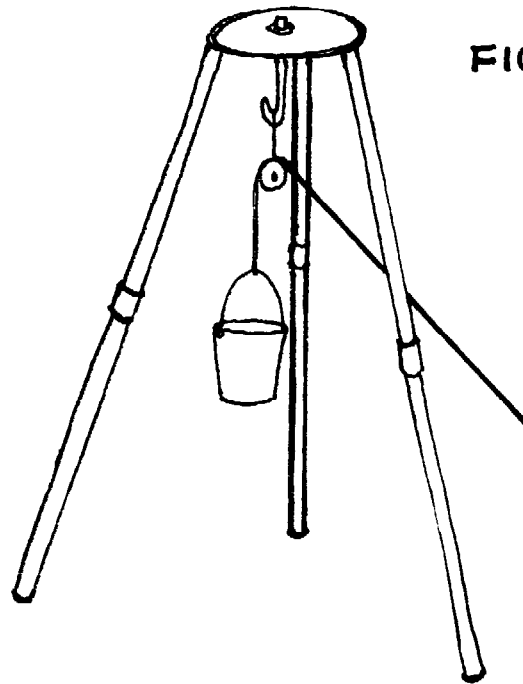
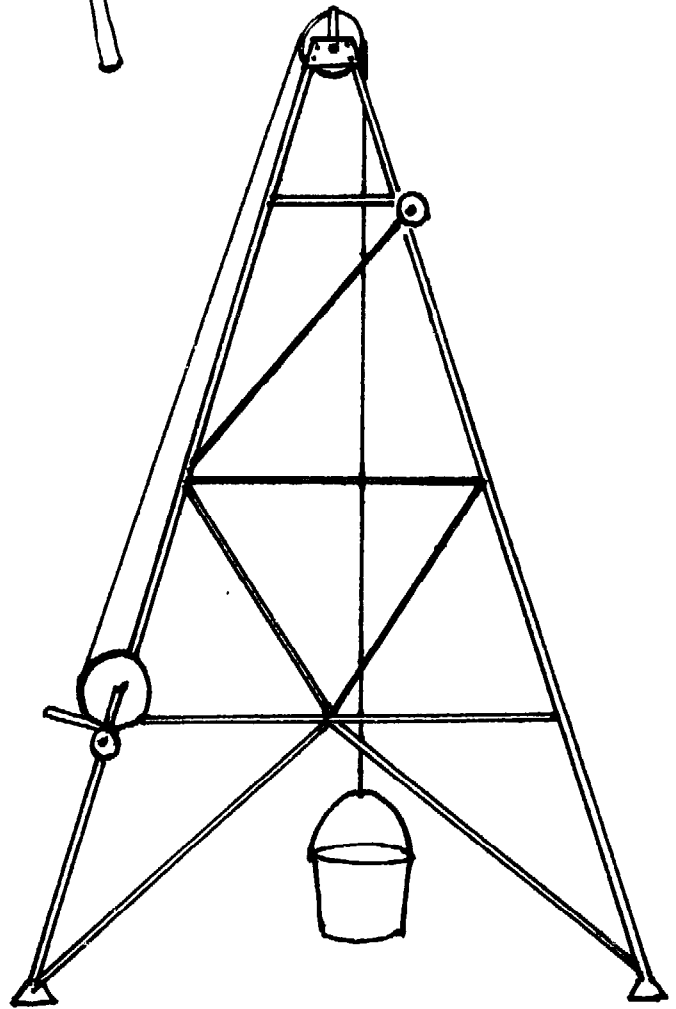

FIG. 5-5.
TRIPOD

FIG. 5-6.
HEADFRAME



If they will not obstruct other operations, the lowering supports can be erected before you begin digging. Or, more often, erect them after you have dug a meter or two and passing buckets by hand in and out of the well begins to get difficult.

It is the operation of this unit which will largely determine the safety of the workers in the hole. Emphasize this major point to all workers and visitors at the well site. Also, observe these six points on safety:

- 1) Lowering and raising materials and people should always be done with enough people on the rope. It is dangerous to rely on one or two strong individuals. Using several people assures control of the load even when a hauler trips or is otherwise unable to continue supporting the load, when people are in the well, or when someone is on the rope being raised or lowered in the well.
- 2) Someone should always be posted at the well edge, watching the load being worked within the well. In case of a problem this person can alert the haulers or other workers. The same individual could also hook and unhook buckets, loads, and people from the rope and ease them into and out of the well.
- 3) When pulling large buckets full of soil, rock and water from the well, two people may be needed to pull the heavy bucket out of the well and place it on the ground next to the well for later dumping.
- 4) There should be an established set of signals which the person at the well head will use to direct those hauling on the rope. (See Fig. 5-3) These signals should be taken very seriously and are to be used only when necessary, but with no hesitation when they are necessary. Practice in using and understanding the signals is advisable.
- 5) Throughout the well sinking process be especially careful that nothing falls into the well. Even a small pebble unknowingly knocked into the well can cause serious injury to a worker at the bottom if it falls from a distance. Take preventive measures. Be careful how you work around the edge of the well.

- 6) Always leave a safety line hanging in the hole. This is a rope tied off at the ground surface which can be used in an emergency as an exit from the well.

D. Other Raising/Lowering Arrangements

While lowering supports have been found to be the easiest and safest form of entry and exit, many other methods have been used. In these other methods tools and materials are lowered by rope by people standing next to the hole. People may be raised and lowered in this way but it is usually easier for individuals to make their own way in and out of the hole by climbing up and down:

- an anchored stationary rope which may be knotted at regular intervals;
- a rope ladder; or
- a regular wooden ladder which may be constructed in stages for use in deeper wells and anchored to the walls of the hole.

E. Common Raising/Lowering Problems

- Lack of tools or materials from which to make the equipment necessary for the raising/lowering operation

This is rarely a real problem because some way can always be found to raise and lower people and supplies if you and the local people are committed to constructing the well.

- Equipment breakage

This is usually due to misuse by overstressing or old age. Misuse can be prevented by careful work habits and frequent inspection of the equipment.

Equipment will gradually wear out with time. While this cannot be prevented, it can be anticipated, so that old equipment is replaced before it becomes dangerous.

- Lack of sufficient people to perform raising/ lowering operation

This too is more of a perceived problem than a real one. If there are enough people in an area to warrant digging a new well, then there should be enough available to help with this aspect of the work.

If vehicles are available they can be more reliable pullers than people. Workers can also easily raise and lower themselves where necessary. (Figs. 5-7 and 5-8)

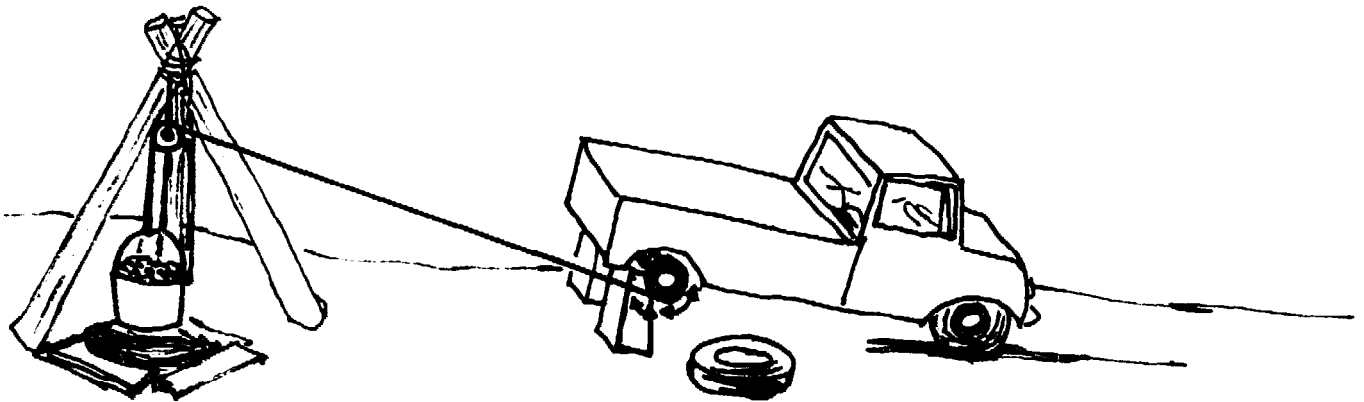

FIG. 5-7. WHEEL RIM CAPSTAN

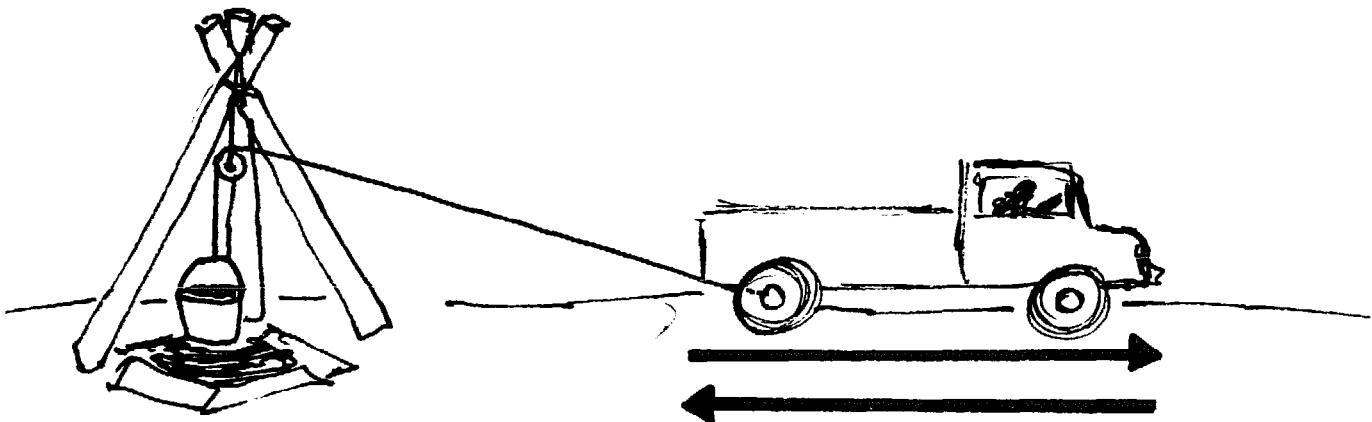

FIG. 5-8. LOWERING/RAISING ROPE ATTACHED TO VEHICLE

F. Useful Equipment

1. Ropes

The lives of you and your workers will depend on the ropes you use, so be very careful in selecting rope.

Make sure that the rope you use is strong enough for the loads you will impose on it. (See Rope Strength Appendix, p. 267.) It should be inspected regularly for flaws and traying. If possible, use new rope. As rope ages it loses up to half its strength. You should take this into consideration during selection and use.

Hemp rope is usually available and is very suitable for wells construction, although contact with cement will speed its natural aging and deterioration.

Nylon rope is often available and suitable, although it will stretch as a load is put on it.

Wire rope is excellent, combining strength and small size although it is really only suitable for use with a winch. Wire rope should not be pulled by hand without the use of gloves as it tends to fray, leaving ends sticking out which easily cut the skin.

2. Knots

A few basic knots, when used properly, can help make the work easier and safer.

- bowline - This knot can be tied to form a loop of whatever size you need that will not slip or come loose.

Its most common use is in rescue operations where people have to be hauled or lifted out of dangerous situations. (Fig. 5-9)

FIG.5-9. BOWLINE

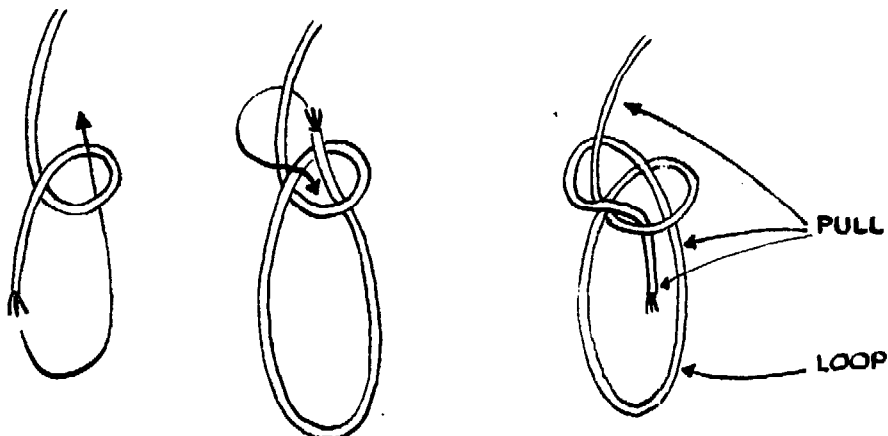

- square knot - This knot is used to join two ropes together. (Fig. 5-10)

FIG. 5-10.
SQUARE KNOT

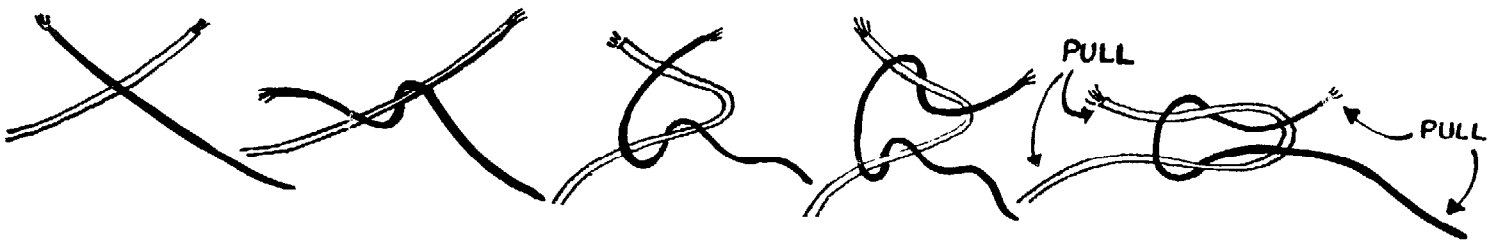

- half hitch - This is very commonly used to attach a rope around a solid object. Once tied, it is difficult to tighten the rope although the knot itself will only become tighter if the rope is pulled. (Fig. 5-11)

FIG. 5-11.
HALF HITCHES

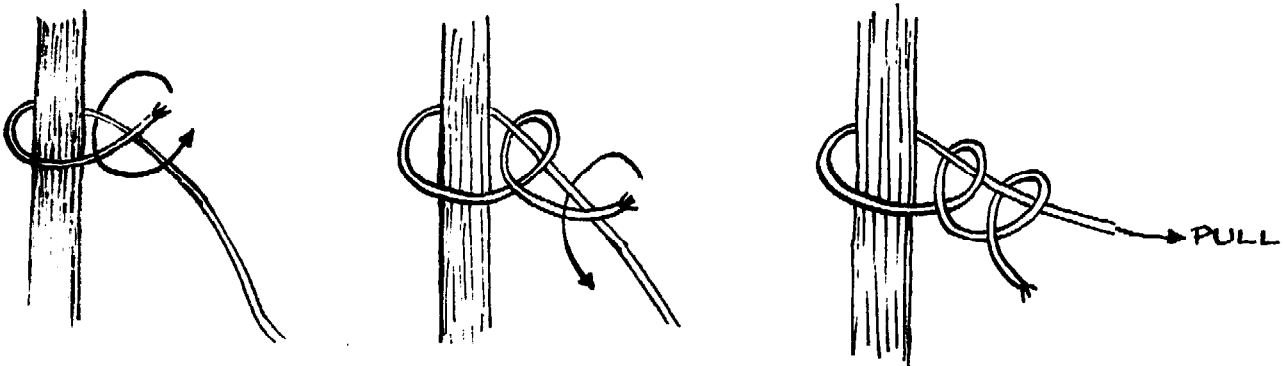

3. Buckets

The use of two or three different kinds of buckets is often convenient for work in a well.

To avoid the possibility of tipping over while being lowered or raised in the well buckets should have two features (Fig. 5-12).

- handles attached to the bucket along its upper rim. Any weight in the bucket will tend to keep it upright.

- buckets should be deeper than wide, which concentrates the weight further down making the buckets even harder to tip over.

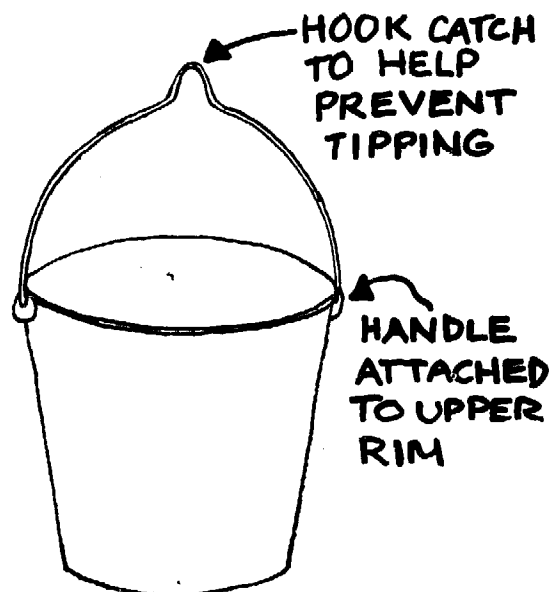

FIG. 5-12.
BUCKET

Buckets, like ropes, should be checked regularly for defects. Particularly look for:

- a weak bottom;
- a worn handle/bucket junction;
- cracks or broken places;
- worn handle.

Discard rejected buckets, if possible, to avoid possible future confusion and unsafe use in the well.

Buckets may be used for different operations and their desired features will vary accordingly. Buckets used in excavation, such as removing soil and rock from the hole should have:

- handles that connect to the bucket rim;
- greater depth than width;
- reinforced bottoms;

- handle safety latches; and
- hocks in the middle of the handles.

Buckets used for cementing (lowering cement into the well) should have:

- handles connecting to the rim of the bucket;
- wide rims for pouring.

Buckets used for lowering and raising tools should have:

- handles connecting to the rim of the bucket;
- greater depth than width.

4. Pulley

The use of a pulley will greatly facilitate well construction work. If unavailable, arrange a cross piece with a smooth surface over which you can pull the rope. It is far more preferable to pull the rope over a pulley than try to stand at the well edge and pull the rope straight up hand over hand. Ropes will wear much faster when pulled over even a relatively smooth surface than when a pulley is used and should therefore be checked frequently.

- Pulleys are often available as a unit with a hook. (Fig. 5-13)

- Pulleys can also be built with shaft ends. (Fig. 5-14)

- Pulleys may be mounted in hard wood blocks anchored to solid frame. (Fig. 5-15)

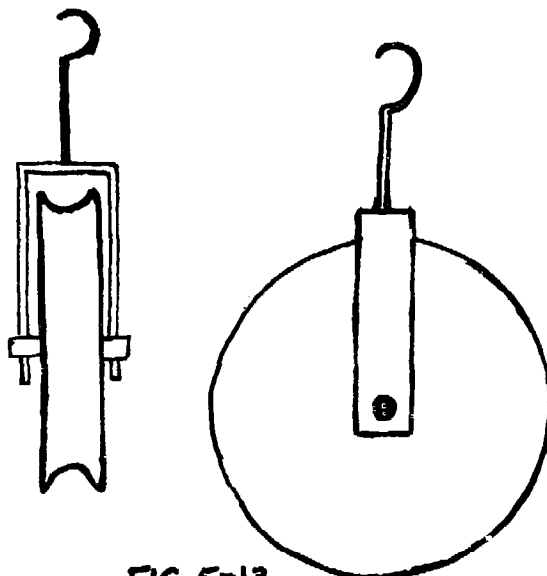

FIG. 5-13.
PULLEY WITH MOUNTING HOOK

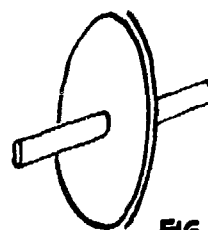

FIG. 5-14. PULLEY
ON A SHAFT

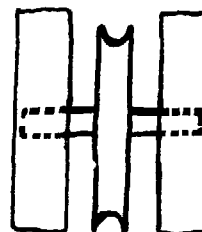

FIG. 5-15. PULLEY
MOUNTED IN
WOODEN BLOCKS

5. Brake Post

The brake post is a log set in the ground 4 to 5 m from the well which, when the raising/lowering rope is wrapped around it several times, acts as a friction brake. This can help, especially when lowering heavy objects into the well, by allowing much easier control of the lowering speed. A person standing behind the brake post controls the lowering speed by the amount of tension he/she keeps on the rope as it feeds around the post and on to the well.

A brake post should be:

- located 4 to 5 m from the well straight out from the pulley (See Fig. 5-1.);
- about 25 cm in diameter, round, and smooth;
- set in concrete 1 m into the ground;
- set at an angle of about 60° from the well.

Chapter 6

DIGGING

A. Introduction

Hand dug wells are sunk working down inside the hole to loosen the sub-soil which is then lifted to ground level and dumped. How one actually digs and then lifts out the loose dirt and rock depends largely on personal preference, based on the available equipment and safety procedures one wishes to follow.

B. Tools

The tools you need depend on the soil conditions. Shovels, picks, mining bars, hoes, jack hammers, and hands have all been used. Anything that will loosen the dirt and rock so that you can then load it into containers and haul it to the surface will work.

NOTE: By shortening the normally long handles of shovels in particular, you can reduce the possibility of injuries and make them easier to use in the confined space at the bottom of a well.

C. Digging

Digging a hole that reaches water and becomes a well is slightly different from just digging a hole. Pay attention to the diameter of the hole, how smooth and even the walls are, and whether the hole is straight up and down.

Many people have found it convenient to follow these steps when using a sinking technique where the hole is first dug, and lined afterward.

- Dig down and remove a layer from 10 to 40cm thick that comes to within 5 or 10cm of the desired diameter (see Fig. 6-1b);
- Continue removing layers of soil until you have reached a depth of about a meter (see Fig. 6-1c);

FIG. 6-1. STEPS TO DIGGING THE HOLE

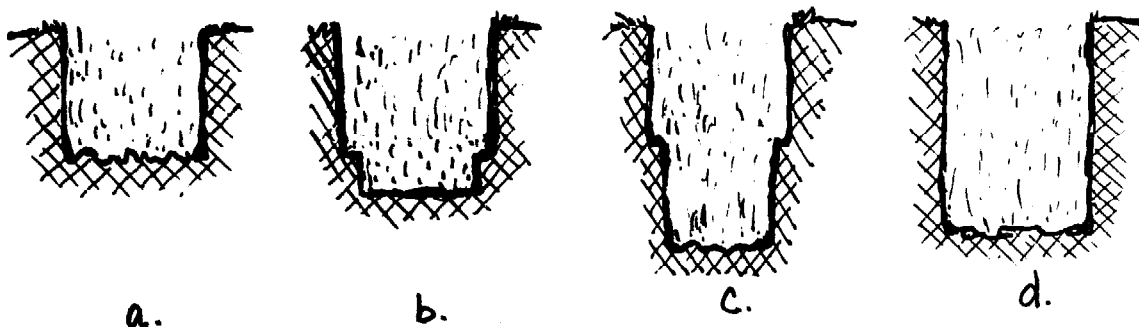

- Now go back and trim out this section to the desired diameter, making sure that the hole walls continue to be plumb (see Fig. 6-1d);
- Continue this process, which may be broken up by periods of lining the hole, until you reach the desired depth of the hole.

While digging a well, you are likely to encounter several different types of soils which range between very loose and very hard. It can be difficult to sink a hole into either extreme. Digging in loose, dry sand can present some serious problems because of its tendency to fall back in. Dry sand acts like a very thick liquid. Unless you can stop the sand from continually flowing back, your well will end up V-shaped but even wider at the top than the hole is deep. In such a situation you can sometimes stop the sand by digging 10 to 15 cm and then splashing a mixture of cement and water on the wall. This will dry in minutes to form a thin hard layer. If that fails, pour 200 liters of water into the hole before digging the next meter. This saturates the sand to make it more stable. If this fails, you should consider sinking the lining through the sand.

D. Hard Rock

Digging down and reaching a hard rock layer above an aquifer is one of the most discouraging things that can happen to a well digger, who must then either try to continue sinking the well into and through the rock layer by whatever means possible, or abandon the hole and try again someplace else.

In order to proceed correctly you need to research and analyze existing information on water accessibility and rock layers. Often there will be only minimal documentation available. Wells project workers may have to

reach conclusions on the basis of incomplete information. Here is a series of questions, the answers to which will assist well workers in developing such information:

- Has this or a similar rock layer been encountered before in other attempts to sink wells?
- Where were the wells attempted?
- At what depth was rock encountered?
- Is this a situation that local people know about?
- Is this a general long slope of the ground surface in a certain direction?
- What do you think happens to this rock layer in that direction?
- Is there another source of water that could be further developed to supply additional water?
- How important is it that these people have a well to supply them with water?

E. Plumb

An object is plumb if it is straight up and down (perfectly vertical). Wells should be as plumb as possible for convenience and to avoid many other possible complications. This is particularly important in sinking pre-cast lining sections. Structurally, a well that is plumb is generally stronger than one that is not.

Plumb can be checked with simply a string with a weight tied to the bottom of it (see Fig. 6-2). Plumb-bobs can be purchased commercially and are relatively cheap. For convenience sake it may be useful to purchase one, especially if there is a sliding piece for the top which is exactly the same width as the plumb-bob itself so that you can easily get exact measures.

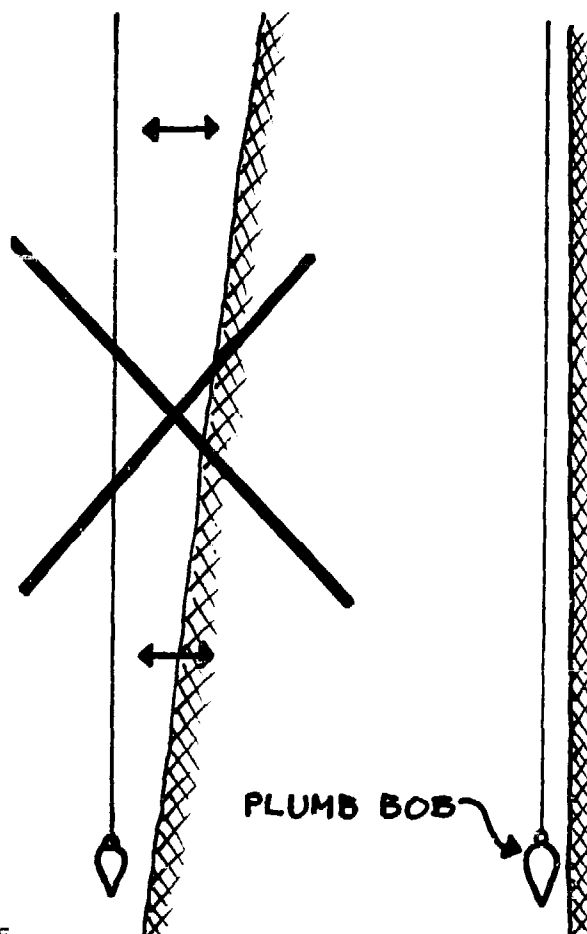

FIG. 6-2. PLUMB-BOB BEING USED TO CHECK PLUMB OF HOLE

F. Diameter

It will be necessary to regularly check the diameter of the well for many reasons. The hole you dig should have the exact diameter that you have designed for it.

If the hole diameter is less than planned, the pre-cut lining may not fit or poured concrete walls, will be thin and weak. This can be easily fixed by trimming the hole to the desired diameter.

If, on the other hand, you have dug the hole too wide, it probably won't affect the final condition of the well, but you will have spent unnecessary extra time digging and it will take more time, and perhaps materials, to fill the well back in to the desired diameter. Excessive width is especially serious when pouring concrete walls in place in the well. The diameter of the forms is set and filling in behind them will require a great deal more concrete.

G. Methods of Checking the Diameter

1. Drop Bar

Preparation

- Bend 6mm re-rod into a circle which conforms to desired circumference of the well.
- Continue bending the re-rod around a second time to make double bar and tie the two together.
- Check roundness by rotating a straight bar the same length as the diameter within the circle drop bar.

During Digging

- Dig one meter and be careful not to displace the drop bar or excessively dig outward at the wall. After you have dug one meter, you are ready to use the drop-bar.

- For right-handers, place your left hand lightly on the bar. Hold the trowel sideways under your left forearm. Using the upper back corner of the trowel, work towards your body and scrape away the dirt below the bar.

- Work along the circumference, scraping away just enough dirt to allow the bar to drop. Continue in this manner, working around the hole until the bar is at the bottom of the hole. (See Fig. 6-3)

- If you constantly look at the bar and keep it level, the bore of the well will be straight and consistent.

- If you now plan to pour the lining in the well, dig a bit with the trowel until the bar is below the floor of the first dig and cover it with sand.

- Do not smooth the wall.

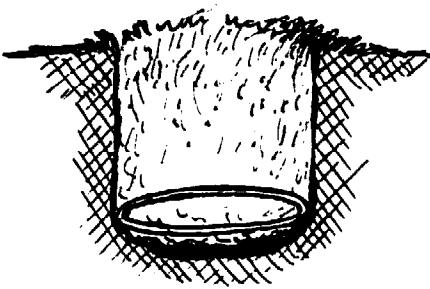

FIG. 6-3

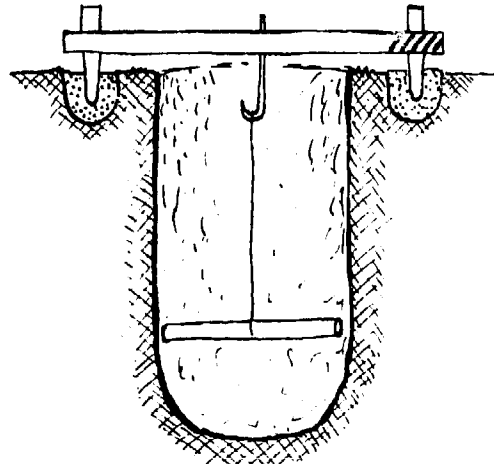

FIG. 6-4

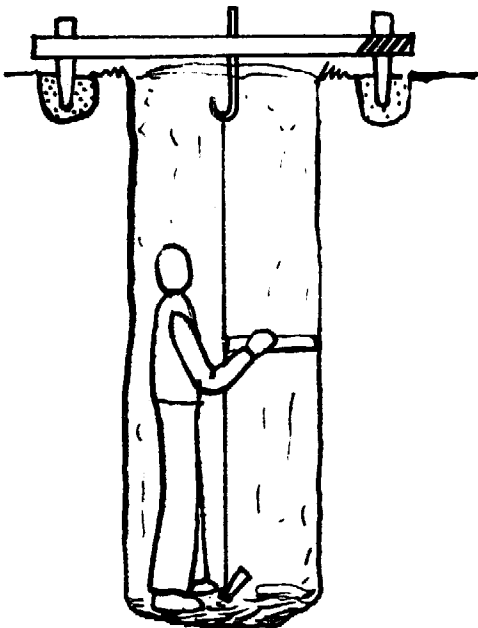

FIG. 6-5

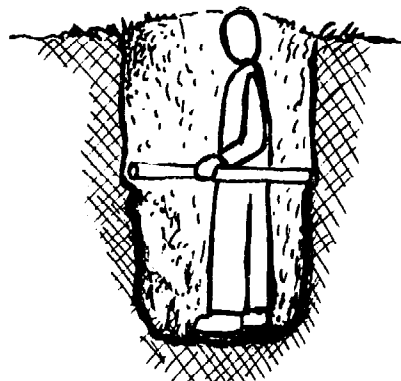

FIG. 6-6

2. Other Methods

This next method can be used to check both the diameter and plumb and can also be used to center forms used in the well.

This method involves hanging a measuring bar from the center of a centering board which fits across the top of the well and is located by a stake on either side of the well. (See Fig. 6-4.)

- Dig anchoring holes for re-rod stakes, one on either side of the location of the well and about 30cm back from what will be the edge of the hole.

- Cement stakes in place and place tops of both stakes through holes already drilled in centering board before the cement sets, to exactly locate stakes.

- Locate a hook or hole in the center of the board

- Draw a circle of the desired hole size in the ground centered at the hook. This exactly locates the hole to be dug.

- As each meter is dug, hang the measuring bar from a line board over the hook. The bar should pivot freely, just touching the edge of the hole with both ends to indicate that the hole is both plumb and the proper size.

A variation of this would be to use a plumb-bob to locate the center and gauge the radius of the well from there. (See Fig. 6-5) Hang a plumb-bob from the hook to locate the center of the hole.

- With a re-rod measuring piece cut to the exact radius of the hole, check the diameter as shown in Fig. 6-5. The measuring piece should just fit between the plumbline and the wall.

A person could also stand in the hole with a rod which is the exact diameter as the hole in order to trim the hole down to the desired size. (See Fig. 6-6.)

Chapter 7

THE MIDDLE SECTION: OVERVIEW OF LINING TECHNIQUES

A. Introduction

The middle section of the well is the first part to be built. It involves digging and lining the hole from the ground surface to the water table.

B. Lining: Purposes

The lining is a circular wall made of a strong, permanent material placed or built adjacent to the walls of the hole.

The lining has three purposes:

- it retains the walls after completion; it keeps the hole from caving in;
- it acts as a seal to prevent polluted surface water from entering the well;
- it serves as foundation and support for the well top.

Wells should be lined if possible. Without linings, wells are subject to damaging cave-ins.

Only in hard rock formations are linings not necessary because rock is not liable to cave-in. Linings should be built of permanent materials which will not rot, decay or otherwise lose their strength in a relatively short period of time.

In some places wells are lined, meter by meter, only down to a depth of about 3 meters. From there down the walls are left unlined. Such a limited lining reinforces what is normally the most unstable part of the well. If caving in is not a problem, this amount of wall reinforcement may enable the development of a semi-permanent water source. It requires a minimum amount of materials but is not really suitable for development as a sanitary water source.

It would be tempting to think of this kind of well as an appropriate temporary solution which could later be easily up-graded to meet the need for a permanent sanitary water source. However, consider that although the partly-lined well meets the current water needs, it may be difficult to motivate local inhabitants to donate time and money to later improve a source that already meets their felt needs.

C. Lining: Methods

There are two basic methods of lining a hand-dug well.

- Dig and line

The hole or a portion of the hole is first dug and then lined. This is a very flexible method and is therefore suitable for use in many different ground conditions.

- Sink lining

Pre-made lining sections are put in place and sunk by digging soil out from inside the bottom lining section. This method is used primarily in loose, dry sands where dig-and-line methods will not work because hole walls cave in too quickly. (Fig. 7-1)

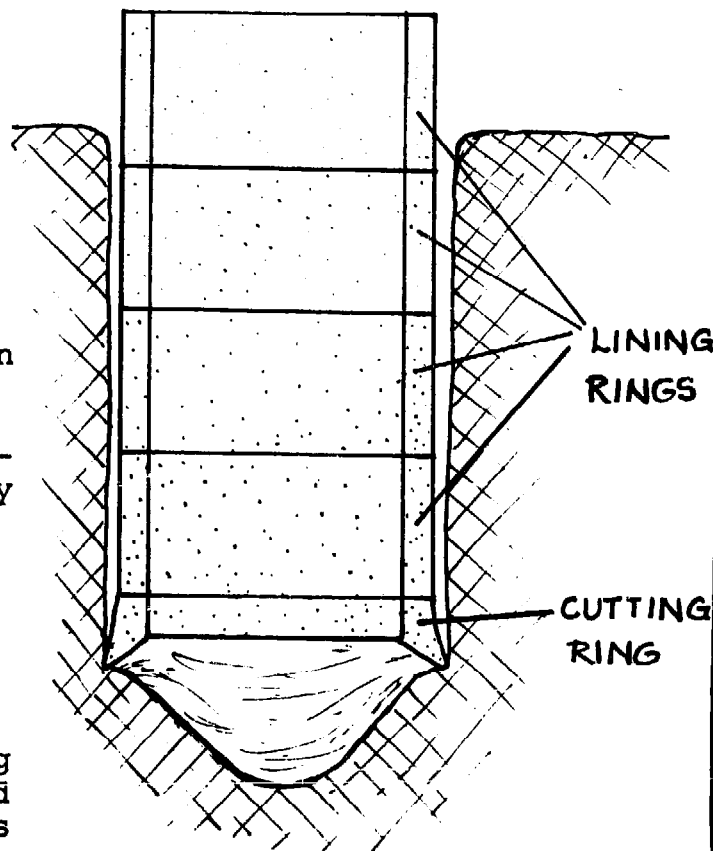

FIG. 7-1.
SINK LINING

1. Dig and Line

This method, which has been traditionally used for well sinking in all parts of the world, has many variations that make it suitable for many different construction materials and ground conditions.

In this method the hole is always dug first and then lined.

Commonly used variations of this method are:

- dig-a-meter, pour-a-meter (see Fig. 7-2);
- dig-and-line-in-short-sections(see Fig. 7-3);
- dig a hole to water and line;
- dig a hole as far into water as possible and line.

The advantages of a dig-and-line method are that:

- it enables you to dig as deep as you can before committing expensive materials to lining the hole;
- it is capable of penetrating anything except hard rock (hard rock can sometimes even be penetrated for short distances);
- the lining can be built in place in the well or built on the surface and lowered into the completed hole;
- the lining curbs (see p. 69) can be built in to increase lining stability.

Its disadvantages include:

- possible dangers from cave-ins if the hole is dug too far without lining;
- requiring more work in the well than "sink-lining."

2. Sink Lining (Caissoning)

This method is most suitable for use in loose fluid soils.

The lining is assembled at the surface before it is sunk. It can be made of pre-cast reinforced concrete rings which are set in place at the ground surface one by one as the others are sunk, or brick or circular rock walls which are built up at the surface layer by layer as the column sinks.

The lining is sunk by workers standing inside the lining column and digging out soil. As more supporting soil is removed the lining will gradually sink under its own weight.

The sinking proceeds by digging out soil until the top

(continued on p. 68)

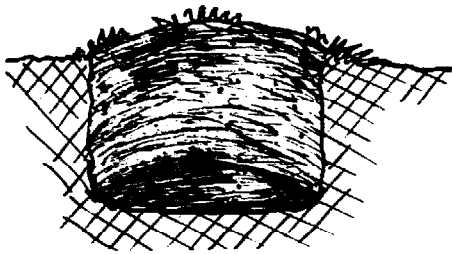

a. The hole is dug and trimmed to the exact diameter and depth required.

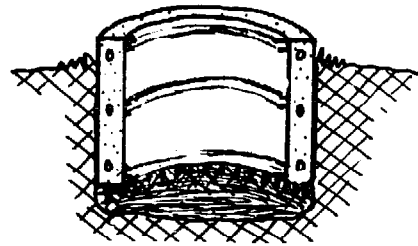

b. The concrete lining for the first meter has been poured in place in the well between the form and the hole wall. Ends of the vertical reinforcing rod have been pushed into the ground beneath the poured concrete section so that they can later be connected with the following pour.

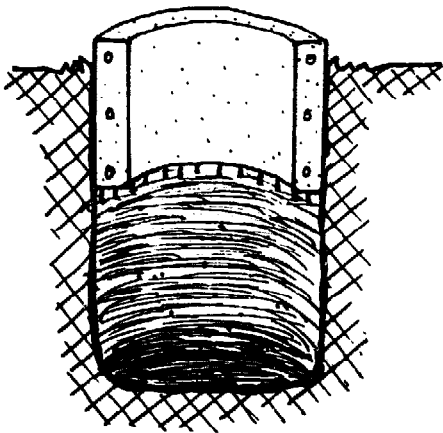

c. The hole has been dug beneath the first pour to a depth slightly greater than the height of the form to allow space for concrete to be poured into the second lined section.

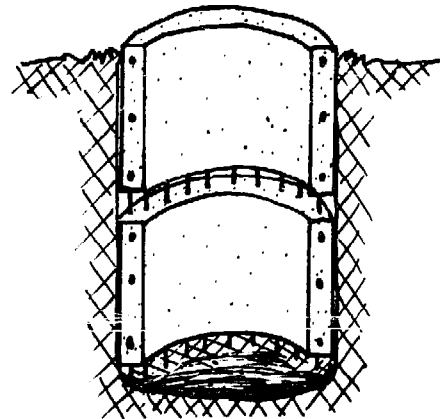

d. The second meter has been reinforced and poured as in the first meter. Vertical re-rods of the first pour before concrete was placed behind the mold for the second meter.

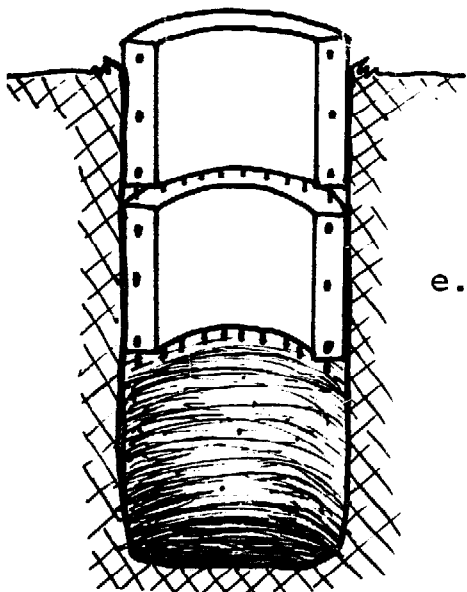

e. The hole has again been dug down beneath the last poured lining section to a depth slightly more than the height of the mold. The gap between the first and second pours can now be filled in with mortar to give a smooth continuous lining.

a. The hole has been dug as deep as five meters and trimmed to the proper diameter. Vertical reinforcing has been put in place over the entire dug section. The second pour has just been completed on top of the first pour. Each successive poured lining section will be poured on top of the previously poured section until the hole is completely lined.

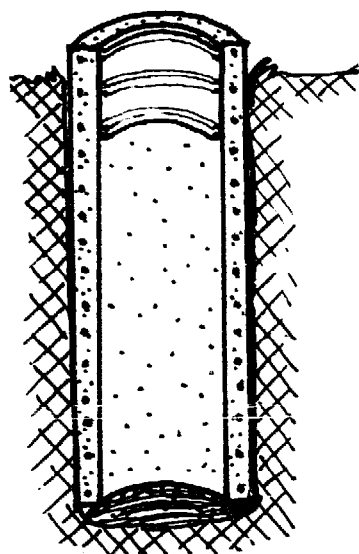
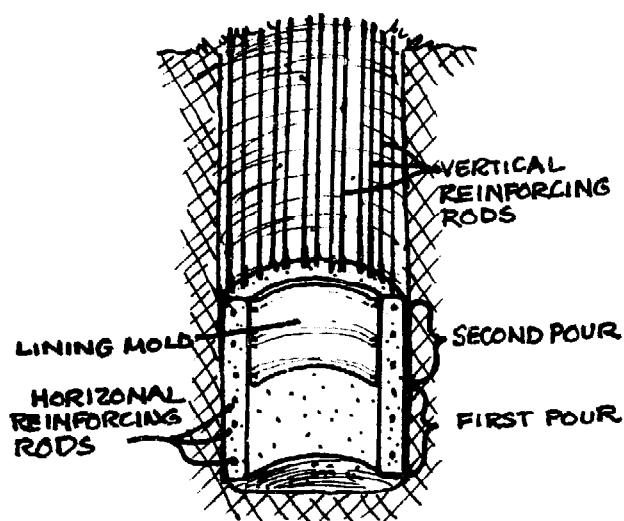

b. The final poured section has been completed for this short section of the well.

c. The hole is now extended as deep as five meters beneath the first short section. It will then be lined as in the previous short section and connected to it with the vertical re-rod that was left beneath the first pour of the first short section.

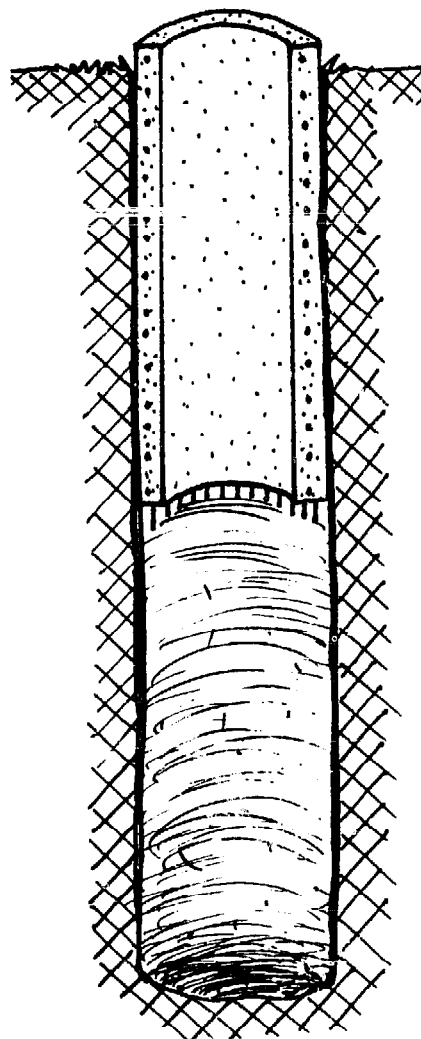

of the lining sinks almost to ground level and adding another lining section, digging and sinking that section to the ground level, and so on until the lining is sunk as far into the water as possible.

As a well sinking method to be used from the ground surface, it is useful for shallow wells and those wells with larger than normal diameters where the ground is free from boulders and other huge obstructions.

This method has these advantages:

- the equipment is simpler than that required for dig and line;
- a headframe is not essential;
- not as much re-rod is required;
- most construction work is carried out on the surface;
- advance preparation of lining can significantly speed the sinking process.

The disadvantages include the following:

- it is difficult to keep shaft vertical;
- boulders or even large stones in the ground can cause the column to tilt;
- the stability of the completed lining depends entirely on the friction between the lining and the hole wall and since this is irregular, stresses are set up which may cause slipping, jamming or opening construction joints;
- as the depth of the well increases, a tendency develops for sections to "hang", causing tension failure, or to buckle or crush under the weight of the column of rings;
- the aquifer may become contaminated by seepage from the surface down the outside of the lining ring because it is not sufficiently form-fitted to the hole wall.

FIG. 7-4. LINING CURB

D. The Curb

The curb is an elbow-shaped cut made in the wall that is poured full of concrete and acts as an anchor to prevent the lining from sliding down through the ground. The bottom of the cut is flat, 40 cm into the wall, and the top is cut 40 cm higher than the bottom cut, and allows concrete to flow to all parts of the curb. The re-rod should be attached to each vertical (as shown in Fig. 7-4). It will obviously take more concrete for a pour that includes a curb.

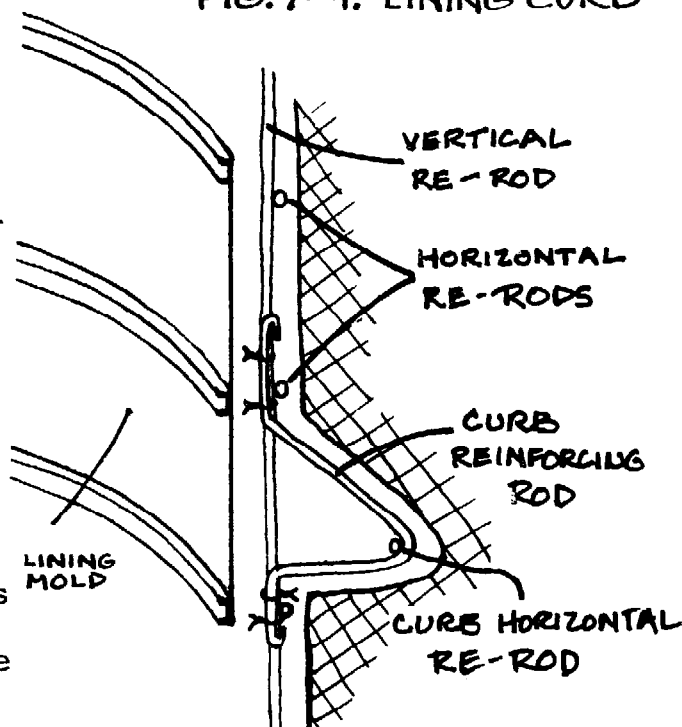

There is no commonly accepted standard regarding a recommended distance between curbs. In fact, some sources question whether they are even necessary where a concrete lining is poured in place. Other sources recommend curbs every 5 meters to 10 meters. It is recommended here that curbs be installed every 10 meters.

It is always a good idea to install a curb at or near the bottom of the middle section lining, just above the water table.

E. Cast-in-Place Versus Pre-Cast

1. Definitions

Cast-in-Place

The lining is built in place right up against the walls of the hole.

Pre-Cast

Sections of the lining are built above ground and later lowered or sunk into place in the well.

2. Decide Whether to Pre-Cast or Cast in Place

The decision to pre-cast or cast in-place the middle section lining usually depends on such factors as size of the project, lining materials, equipment available, ground conditions, and personal preference.

Generally, a lining that is built in place is better than one that is built ahead of time and then installed in the well. By building it in place, especially if using reinforced concrete or mortar, the lining conforms to the walls better, providing greater adhesion, stability, and sealing, as well as preventing the entry of contaminated surface water.

Cast-in-Place

- generally preferable-- strong, waterproof, permanent;
- bonds well with excavation walls;
- limited working space in the well.

Pre-Cast

- forms helpful but not required;
- pre-made concrete sections available;
- provides more time and space to build a stronger lining;
- may not bond well with the hole wall;
- requires heavy lowering equipment.

To prevent tools and materials from being accidentally knocked into the well and the possible collapse of the looser surface soil into the well you may wish to install a lining in the top meter of the well as soon as it is dug. This can be either a temporary or permanent lining depending on what materials you have available and the lining method you plan to use.

When in place, this lining should reach at least 10 cm above the ground surface to prevent tools, materials, and other articles from falling into the well.

An inside lining mold can be used as a temporary lining. (See Fig. 7-5.) There must be enough room for people and supplies to move in and out of the hole. The mold should be carefully packed in place to prevent it from slipping down while the hole is being excavated beneath it. Remember that, once in place, this temporary lining cannot be moved until the construction is complete. It is, therefore, necessary to plan on making or purchasing this in addition to all lining molds needed for the construction of the permanent lining.

If you build a permanent lining, pour it in place possibly with an anchor above ground.

As you sink the well beyond this top support, taper the inside hole walls out to the desired hole diameter about 30-40cm below bottom of top support. This will help support it while digging continues below it.

If you decide not to put a top support in you should make some effort to ensure that workers in the well are safe from ground surface collapse and accidental entry of anything into the well. For example, four boards may be laid in a square around the hole and used to accomplish this.

Such a construction will help to distribute weight near the edge of the hole and act as a constant reminder to well workers and others to be careful.

Many wells have been dug without the use of any measures to prevent accidents except to warn everyone about the consequences. Well workers will all be sensitive to the need for safety but local villagers often are not.

In some cases wells projects have established rules that no one, including village elders and children, can come within 2 meters of the well until it is completed. This may be hard to enforce but is nevertheless a very useful procedure.

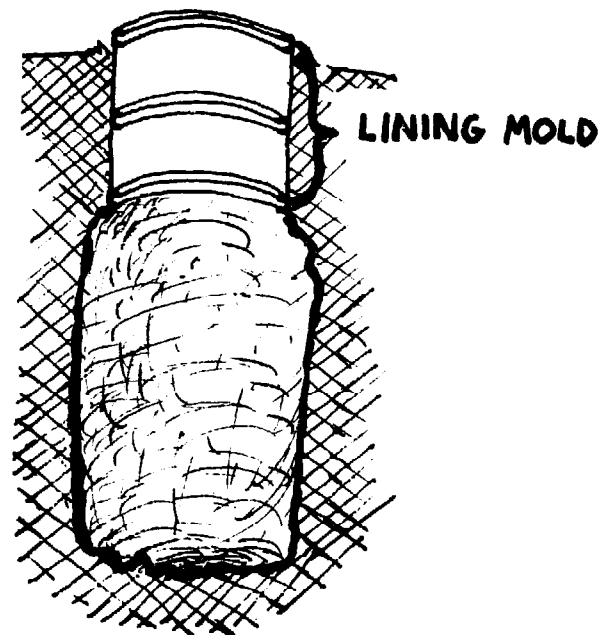

FIG. 7-5
LINING MOLD AS
TEMPORARY LINING

NOTE: Hole diameter and lining thickness: As a general rule the lining thickness should be about 1/20 of the hole diameter but never less than 7 cm.

Finish well diameter = interior lining form diameter = 9/10 hole diameter (for wells w/hole diam. \geq 1.40m)

F. Lining: Materials

The availability of materials largely determines how you line the well. Here are the most frequently used lining materials in order of preference.

This order is generally applicable to most locales although there may be minor changes due to limitations of geological conditions. Such limitations are almost always due to the fact that soil conditions will not permit you to dig down to the water table without first reinforcing the walls. The installation of temporary reinforcing is sometimes an appropriate solution, but that involves a large added expense for temporary lining which is beyond the scope of this manual.

- Reinforced concrete

This is probably the best material now commonly available for large-diameter well lining. When properly cured it is very strong. Depending on its ingredients it can be virtually waterproof or quite porous. Re-rod is available in most countries, although it is sometimes difficult to transport to the well site. Concrete can be pre-cast into appropriately sized sections and then lowered into the hole or it can be poured and cured in place inside the well. Depending on what other equipment and materials are available for use with it, it is the most adaptable material for many of the situations which may be encountered in wells construction.

- Reinforced mortar

This material has all the same advantages and uses as reinforced concrete. The difference is that only sand is added to cement to make mortar while sand and gravel are added to cement to make concrete. Gravel acts as a stretcher to make the concrete go further so mortar is more expensive for the same volume of final product. Mortar is a more "workable" mixture and in some cases may be more suitable than concrete.

- Concrete

Concrete without re-rod is not as strong as reinforced concrete.

- Mortar

This has the same qualities as concrete but is more expensive.

- Brick

Brick should be solid rather than hollow. It is best suited for digging to the water table and then lining the complete well. It can be used to line in short sections although it is difficult to support a lined section while digging beneath it. Mortared brick makes a strong lining but does not adhere very well to the hole wall.

- Rock

Rock is very similar to brick in that it is best suited for lining a hole that has been completely dug. Mortared rock walls can be quite strong although because of their irregular shapes and strengths they will often contain weak spots and be subject to cracking.

Unmortared rock walls can also be very strong if built properly, but require proper materials and a degree of expertise which cannot be adequately covered in this manual.

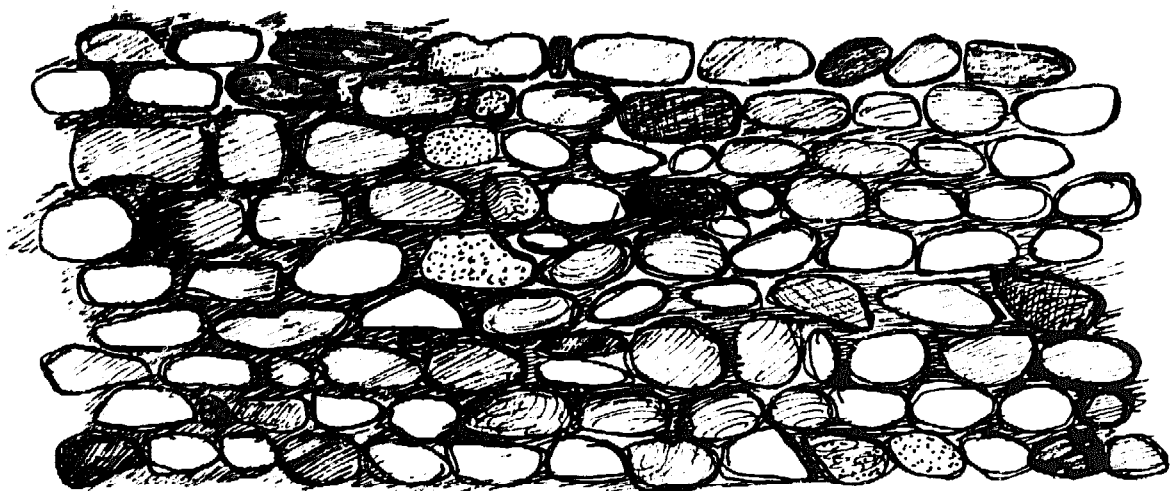

FIG. 7-6. ROCK WALL

- Timber (wood)

The only advantages of wood are that it has been generally available, moderately strong and cheap. In many areas of the world wood is no longer generally available or cheap, and its disadvantages are such as to prevent any serious consideration of wood as a lining material for a permanent potable water source. It is liable to rot, taint the water and harbor insects. It is impossible to make the lining watertight and so prevent re-entry of contaminated surface water.

G. Possible Digging/Lining Methods for Each Material

1. Reinforced concrete cast in place:

- Dig to water and line;
- Dig-a-meter, pour-a-meter;
- Dig and line in short sections.

2. Reinforced concrete pre-cast:

This requires heavier capacity lowering equipment.

- Dig to water and line;
- Sink lining.

3. Reinforced mortar thrown in place:

- Dig to water and line;
- Dig-a-meter, pour-a-meter;
- Dig and line short sections.

4. Reinforced mortar pre-cast:

- Dig to water and line;
- Sink lining.

5. Unreinforced concrete or mortar cast in place:

This has very little tensile strength.

- Dig to water and line;
- Dig-a-meter, pour-a-meter;
- Dig and line in short sections.

6. Unreinforced concrete or mortar pre-cast:

Its low tensile strength makes lowering it into the well difficult.

- Dig to water and line;
- Sink lining.

7. Brick or rock:

These materials also have relatively low tensile strength:

- Sink lining (on cutting ring);
- Dig to water and line;
- Dig and line in short sections with anchoring curbs.

8. Wood (timber or split bamboo):

- Employ verticals with horizontal supports all anchored to walls;
- Use any sinking method but try to avoid the use of wood in the first place, for reasons discussed above.

NOTE: Efficient use of cement

Cement is probably the most expensive material of all so it should be used as efficiently as possible.

Of all cement compounds, reinforced concrete requires the least amount of cement per volume of building material (either mortar or concrete) produced.

On one wells construction project where 50 cm rock walls were built, 15 cm reinforced concrete was tried instead.

The results were a 1/3 reduction in cement used, walls were more waterproof, and the construction time was significantly reduced. The initial cost was greater because of the need for forming materials, but forms can be re-used. By prorating the cost of forms over a number of wells and figuring the reduced labor costs the total cost of each well went down about 25%.

Chapter 8

CONSTRUCTION OF THE MIDDLE SECTION

A. Introduction

This chapter first presents a step-by-step description of the use of reinforced concrete in the construction of the middle section by three methods: 1) dig-a-meter, pour-a-meter; 2) dig-and-line-in-short-sections; and 3) dig-to-the-water table-and-line. It then describes the use of the same material in building lining rings and concludes with a discussion of the use of alternative materials, mortar and mortared brick or stone.

B. Sinking Depth and Lining

How deep you sink the hole before you begin lining it is a question you must answer for yourself, given the local conditions. Major concerns are the ground conditions, the lining material to be used and personal preference.

● ground conditions

In loose soil, dig to whatever depth can be conveniently dug and lined without the hole walls caving in; 1/2 meter is the usual minimum.

In firm soil, the maximum recommended depth without lining is 5 meters. This is usually a safe depth and may prevent or at least limit the damage resulting from cave-ins.

Many experienced well diggers will simply dig as far as they can until either 1) walls show signs of loosening and possible cave-in, or 2) they reach the water table. This is, however, not recommended for beginning well diggers who have little or no experience estimating the strength of various ground formations.

NOTE: In some locales where the soil is firm all the way down to the water table, entire wells have been dug before any lining was constructed. Where necessary and where ground conditions permit, wells can still be dug that way.

C. Dig-a-Meter, Pour-a-Meter

One meter is the height of the circular forms, sometimes called molds, which will be placed in the well and around which concrete will be poured. Circular lining forms do not have to be one meter high and where they are not the general procedure for this digging/lining method can still be followed. Another name for this method could be dig one mold height and then line one mold height.

● Outline of Work

1. Dig the hole to the specified depth.
 - Check the diameter and plumb. (See pp. 59-62.)
2. Assemble the re-rod cage in place. (See Fig. 8-1.)
 - 25 to 30 cm of each vertical re-rod should extend into the soil below the bottom of this pour.
 - Evenly space the horizontal re-rods along the height of the pour and tie them to the verticals.

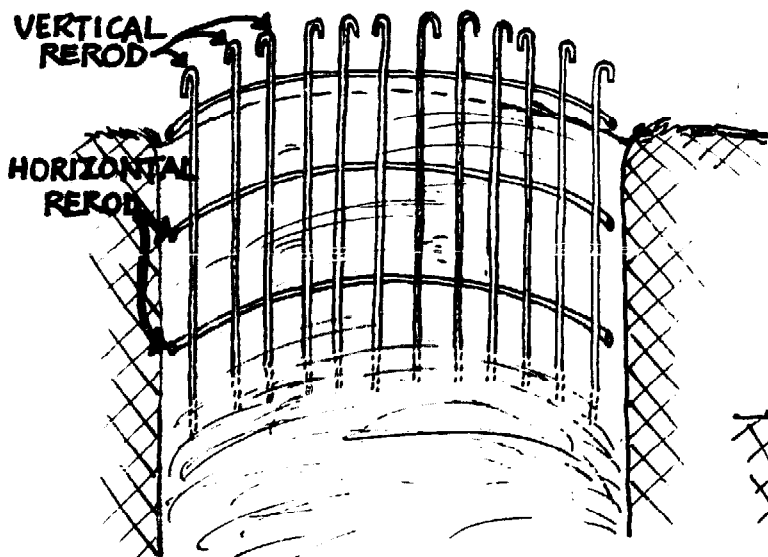

a. The hole has been dug to the required depth and re-rod verticals stuck into the ground. The re-rod horizontals are then tied to the verticals.

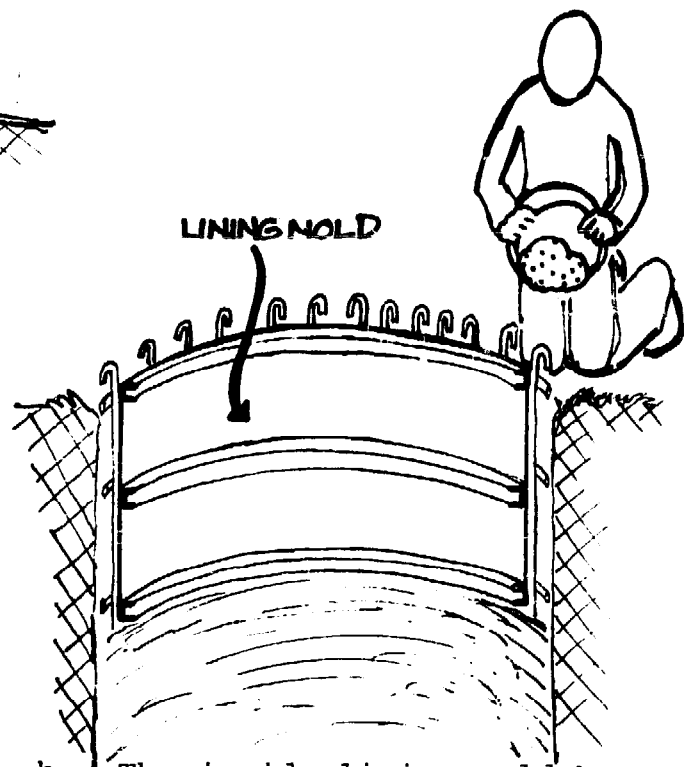

b. The inside lining mold has been centered and leveled. Concrete can now be poured around the re-rod between the lining mold and the side of the hole. Also see Fig. 8-3.

FIG. 8-1. REINFORCED CONCRETE LINING BUILT IN PLACE

3. Lower and assemble the mold.
 - Level and center the mold. This is very important for the first section.
4. Pour concrete behind the mold (see Fig. 8-1b) and on all sides of mold to evenly distribute and not displace the mold. Gently tap around mold with a hammer to settle the concrete and prevent honeycombing.
5. Leave the mold of first pour in place.
 - Dig beneath it to a depth of a mold plus 10 cm (8-15cm) (If 1 m mold, dig 1.1 m; if 1/2 m mold, dig 60cm)
 - Check diameter and plumb.
6. Assemble the re-rod in place.
 - Tie the top of the vertical piece to the bottoms of the pieces extending out below the previous pour.
7. Lower and assemble the mold (another one, or the drop mold used in the first section)
 - Level and center the mold.
 - There will be a 10 cm gap between the top of the mold and the bottom of the previous pour through which to pour the concrete.
8. Mix and pour the concrete behind the mold.
9. Continue as in second meter.

After the mold is placed for the third pour, plaster the joint between the first and second pours with mortar for a smooth continued surface.

A more specific work plan for each of these steps is given in the next section.

● Dig-a-Meter, Pour-a-Meter: Work Plan

1. Dig hole to desired depth

- Check diameter and plumb. (See pp. 59-62.)
- Determine depth of hole, as follows.

When you dig the hole for the first one meter section to be poured, the actual depth of the hole will depend on 1) how much of a headwall you wish to include as part of the first pour, and 2) how you can best leave 25 cm to 30 cm of each vertical re-rod beneath the pour in such a way that they will not be embedded in the concrete. This will later be connected to the next lower pour.

Here are various headwall options for your consideration:

- No headwall

The depth of the hole is the height of the mold so that the pour will be flush with the ground surface.' (See Fig. 8-2)

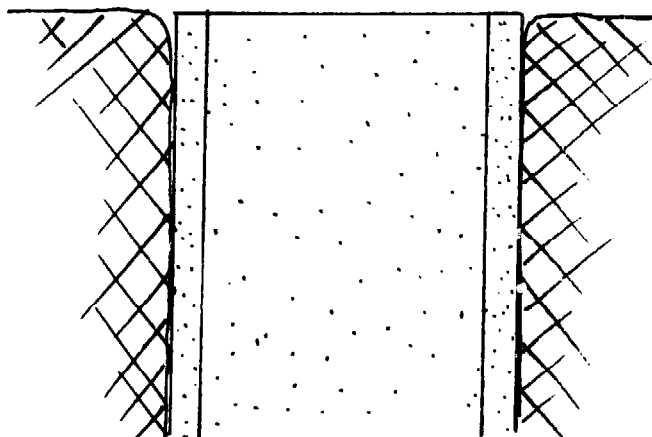

FIG. 8-2. NO HEADWALL

- 10cm headwall

The depth will be 10cm less than the height of the mold.

- 50m headwall

You will need an optional 50cm exterior headwall mold. The depth will be 50cm less than the height of the mold. For a 50cm headwall the mold should be 1m high. Assemble the normal 1m re-rod cage in

place. The cage will extend almost 50cm above ground. Place, level and center the interior and exterior molds. The tops of both molds should be approximately even with the top of the re-rod slightly (3cm) below that. The width of the head-wall is determined in the same way as the hole diameter.

2. Assemble re-rod cage in place.

The total height of the vertical re-rods should be (mold height) + 20(re-rod diameter)+ 10cm (for space to pour concrete between pours) + 10cm (for one 5 cm hook on each end of the rod).

For example: When using a one meter mold and 8mm re-rod verticals will be 1 meter (mold height) plus 0.16m (20x8mm re-rod diameter) also .10m (for concrete pouring gap) plus .10m (2-5cm hooks). The verticals will be 1.36 meters long.

- Normally use about 15 vertical pieces although you may need up to 30 pieces in very loose unstable soil.
- Bend over a 5cm hook on one end of each vertical re-rod.
- Space re-rods evenly around the hole. Push the unbent end of each re-rod about 30cm into the ground or until the top of the hooked end is about 3cm below the top of this poured section of lining.
- These re-rods should all be pushed into the ground where they will be approximately in the middle of the lining thickness. (See Fig. 8-3)

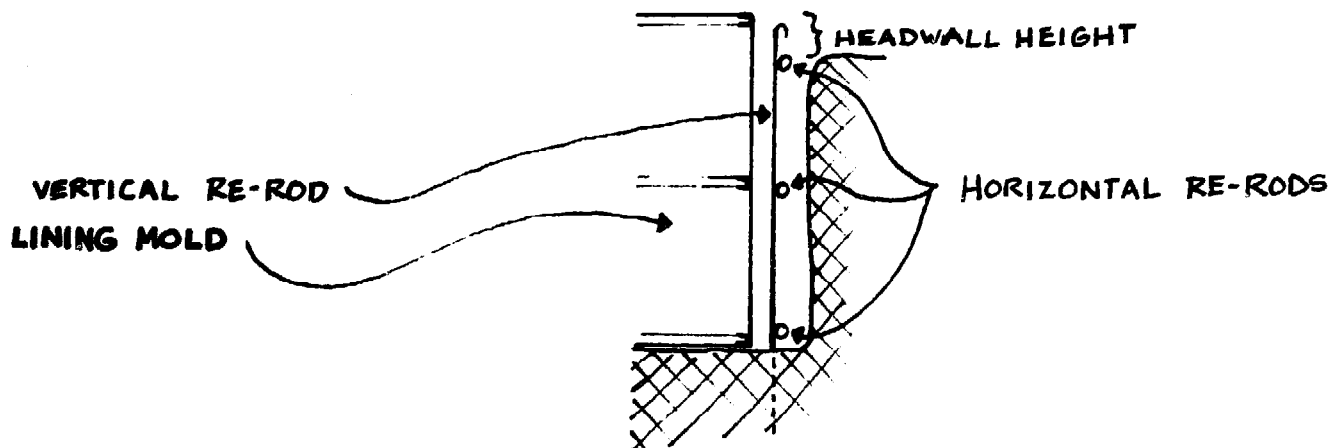

FIG. 8-3. PLACEMENT OF RE-ROD AND FORM IN HOLE

- If the ground is too hard to push the re-rod straight down, then dig down far enough to provide space for the bottom ends and fill the hole back in to the desired depth. However, this may waste time and effort that could be used more economically by digging the hole deeper before you line it. (See an alternative sinking technique on p. 86.)
- You will normally need 3 horizontal reinforcing rods per meter, although in loose soil 4 horizontal re-rods are better. These will be circles of re-rod with a diameter slightly less than the hole, they are usually placed on the outside of the verticals.
- To compute the length of re-rod which will need to be bent into the proper size circle for use as a horizontal reinforcing rod, used the following formula. The complete lengths of the re-rod will be the distance around the circle at the point where the re-rod will be placed, plus the length of the re-rod overlap, plus the length of the hook on each end of the re-rod.

[(hole diameter)-(lining thickness)] + 20(re-rod diameter) + 2(5cm end hooks) + length of horizontal re-rod

Example: For a well with a hole diameter of 1.5 meters with a lining thickness of 7.5cm (.075m) using 6mm (.006m) re-rod, the computation would look like this.

$$\begin{aligned} & [(1.5) - (.075)] \times 3.1416 + 20 (.006) + 2 (.05) \\ & [1.425] \times 3.1416 + 0.12 + 0.10 \\ & 4.48 + 0.12 + 0.10 = 4.7 \text{ meters.} \end{aligned}$$

- Horizontals should be evenly spaced in each meter; for example, if there are three horizontals, one is placed in the middle of each meter; the other two are placed 37cm away on either side. (See Fig. 8-3) Be sure to include the 10cm or 15cm gap between successive poured sections if applicable in the computation of the length over which the horizontal re-rods should be evenly spaced. Tie all intersections of horizontal and verticals; make sure the re-rod is no closer than 3cm to the hole wall. Put pieces of stone or dried concrete between the re-rod and the hole wall where it is necessary to ensure spacing.

NOTE: Instead of using a certain number of horizontal pieces, you can also use a continuous spiral re-rod which circles the hole 3 or 4 times per meter depending on how strong the lining must be.

3. Lower and assemble the mold.

- Lower the mold sections into the well and assemble them in place.
- It is also possible to assemble the mold above the ground and lower it into place.
- Center the mold in the hole making sure that it is level and that the distance between the mold and the hole wall is the same all the way around the hole. (See Fig. 8-4.)

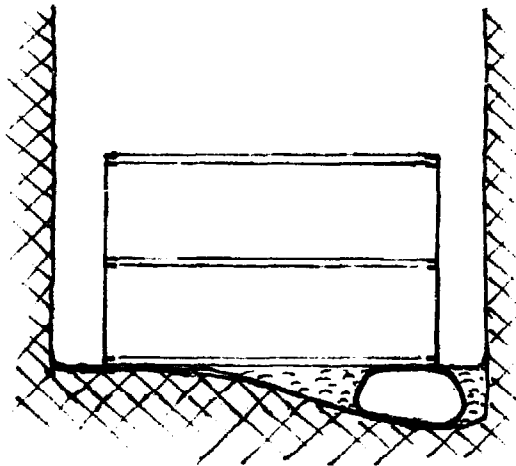

FIG. 8-4. MOLD LEVELED AND CENTERED

- It is very important that the mold be correctly centered and leveled for this first section because all of the other pours must line up and be attached to it. If the first poured section is not aligned properly all subsequent sections, if followed from the first one, could magnify that error and cause the well shaft to curve or angle out of plumb as it is sunk.
- Especially with the first meter it is often a good idea to check the level and centering again, just before the concrete is poured, to make sure that it has not been disturbed.

4. Pour concrete behind mold.

- Concrete is mixed on the surface (See Cement Appendix, p. 221.) and lowered in buckets down to workers in the well who will pour the concrete behind the mold.
- When pouring concrete behind the mold, do so from alternating opposite sides of the mold. If you continually pour the concrete into one spot or unknowingly concentrate on one side of the concrete, it will soon build up enough weight that it will move the mold off center or out of line. Once that happens it is virtually impossible to move the mold back to its intended position. (See Fig. 8-5.)
- Once the concrete is poured, gently tap around the inside of the mold with a hammer. This slightly vibrates the concrete so it settles into any voids that may have been left while pouring. After the concrete has set in an hour or two, you can begin working on the second pour.

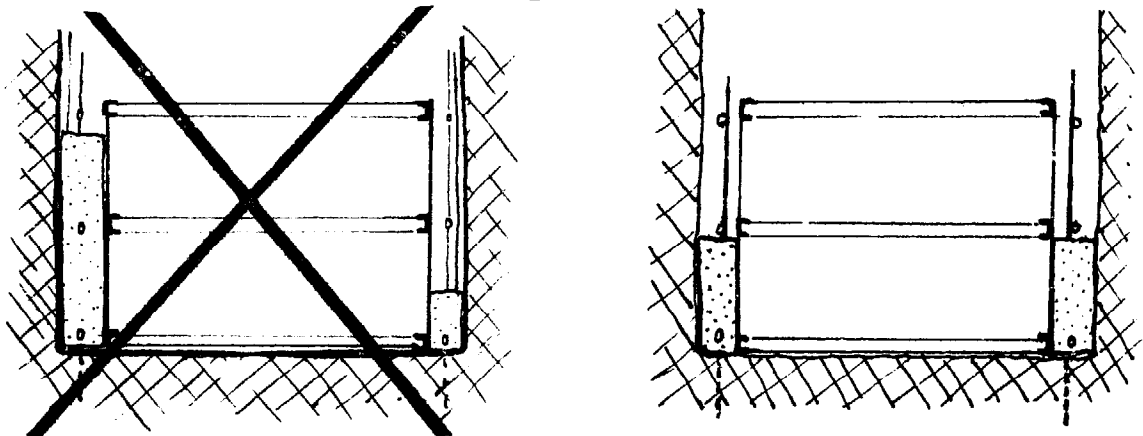

FIG. 8-5. POURING CONCRETE EVENLY IN PLACE AROUND MOLD.

5. Dig hole beneath the first poured section

The depth of this dig should be the mold height plus 10 cm for a gap between the bottom of the first poured section and the top of the second pour through which you will pour concrete. (See Fig. 8-6.)

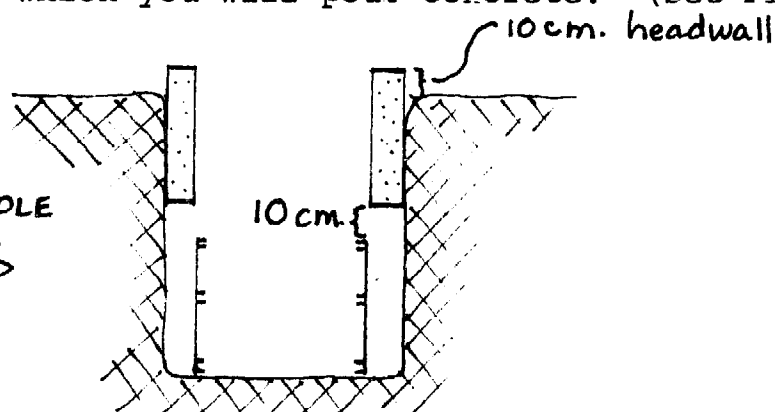

FIG. 8-6. PROPER HOLE DEPTH BENEATH AN ALREADY POURED LINING SECTION

6. Assemble reinforcing rod in place

- Bend a 5 cm hook on the bottom ends of the re-rod extending down from the previously poured section.
- Place the horizontal pieces in the well; pull the horizontal pieces up into place and tie all intersections with horizontals.
- Assemble the same number of vertical pieces as in the first pour.
- Bend a 5 cm hook on one end; stick the unhooked end into the ground 25-30 cm directly beneath the verticals of the previously poured section and inside the horizontals lying on the ground.
- Connect the verticals to the previous verticals with sufficient overlap, twenty times the diameter of the re-rod, and a 5 cm hook at either end of the overlap.
- Place the horizontals as in the first pour. Make sure the re-rod is no closer than 3 cm to the hole wall.

7. Lower mold into place

- If you have only one mold, remove and lower it from the previously poured section.
- This way it is possible to dig and line about 1 meter each day in soil that is easily dug. A single mold should be cleaned and oiled at least once every 3 meters.
- During the one day that each poured concrete section sits while the following section is dug, it will set sufficiently to enable the mold to be carefully removed. (See Cement Appendix, p. 221.)
- If you have more than one mold you may leave them in place until needed for constructing subsequent sections.
- Center and level (plumb) the mold.

8. Mix and pour concrete behind mold

Don't forget to alternate sides for pouring each successive bucket to allow the concrete to settle evenly.

9. Successive pours

- Continue as in second pour;
- Fill gaps between pours with mortar when the molds have been removed from both sections.

D. Dig-and-Line-in-Short-Sections

The lining method involves digging the hole to some convenient depth and then lining it. Once the lining for that section is complete and is anchored in place, continue digging the hole beneath the already lined sections. These sections are dug and lined until the water table is reached. The depth of each section can be whatever you feel comfortable with both from the point of view of safety and work convenience.

1. Dig hole to certain depth

Dig a hole until you reach a depth where you feel it might be unsafe to continue, or until you have sunk the hole a maximum of 5 meters. Depending on whether you want a headwall and, if so, on the height you want it to be, you may want to slightly change the hole depth so that the top of the mold will be at the desired top of the headwall after a number of poured lining sections are completed.

2. Assemble re-rod cage in place

- Where possible, use single long pieces of re-rod for verticals. These can be anchored to the hole wall with short pieces of re-rod bent into hooks and pounded into the hole wall around the verticals.
- Put horizontals in place, beginning at the bottom and working up.
- Tie each horizontal in place temporarily with enough ties to hold it in place. This allows for any adjustments that might be necessary later.
- Before the mold is put in place for each pour, securely tie all of the intersections of horizontals and verticals.

3. Lower and assemble mold

- Level and center the mold in the bottom of the hole.

4. Pour concrete behind mold

- Leave the top surface rough for a good bond to the next pour.

5. Lower and assemble another mold

- Set it directly on top of previous mold;
- Pour concrete behind mold;
- Repeat this step until you reach the ground surface or bottom of the previous set of pours.

6. Repeat steps 1 through 5

- Repeat these steps until water is reached. The bottom of the lining should be constructed with a curb just above the water table.

NOTE: If you are digging and lining beneath a previous lift be careful to leave enough room between the top of this lift and the bottom of the previous lift through which you can pour concrete (See Fig. 8-6.)

E. Dig-down-to-Water-Table-and-Line

This method is recommended only where the water table is within a few meters of the earth's surface and the ground is firm. It is included here to demonstrate that the same operations must always be performed although, depending on the depth, they may be done in a slightly different order:

1. The hole is dug down to just slightly above the water table.
2. Dig out a curb at the bottom of the hole.
3. Assemble the re-rod in place.
4. Set the form in place. Remember to carefully center and level the form.
5. Mix and pour the concrete into the form.
6. Continue lowering molds on top of previous molds and pouring concrete behind them until you reach the ground surface.

F. Pre-Cast Reinforced Concrete Rings

Pre-cast reinforced concrete rings are often used to line wells. They are poured and cured above ground to be lowered into the well later. There are two basic methods for installing rings:

- lowering and stacking them in an already dug well:
(See Fig. 8-7.)

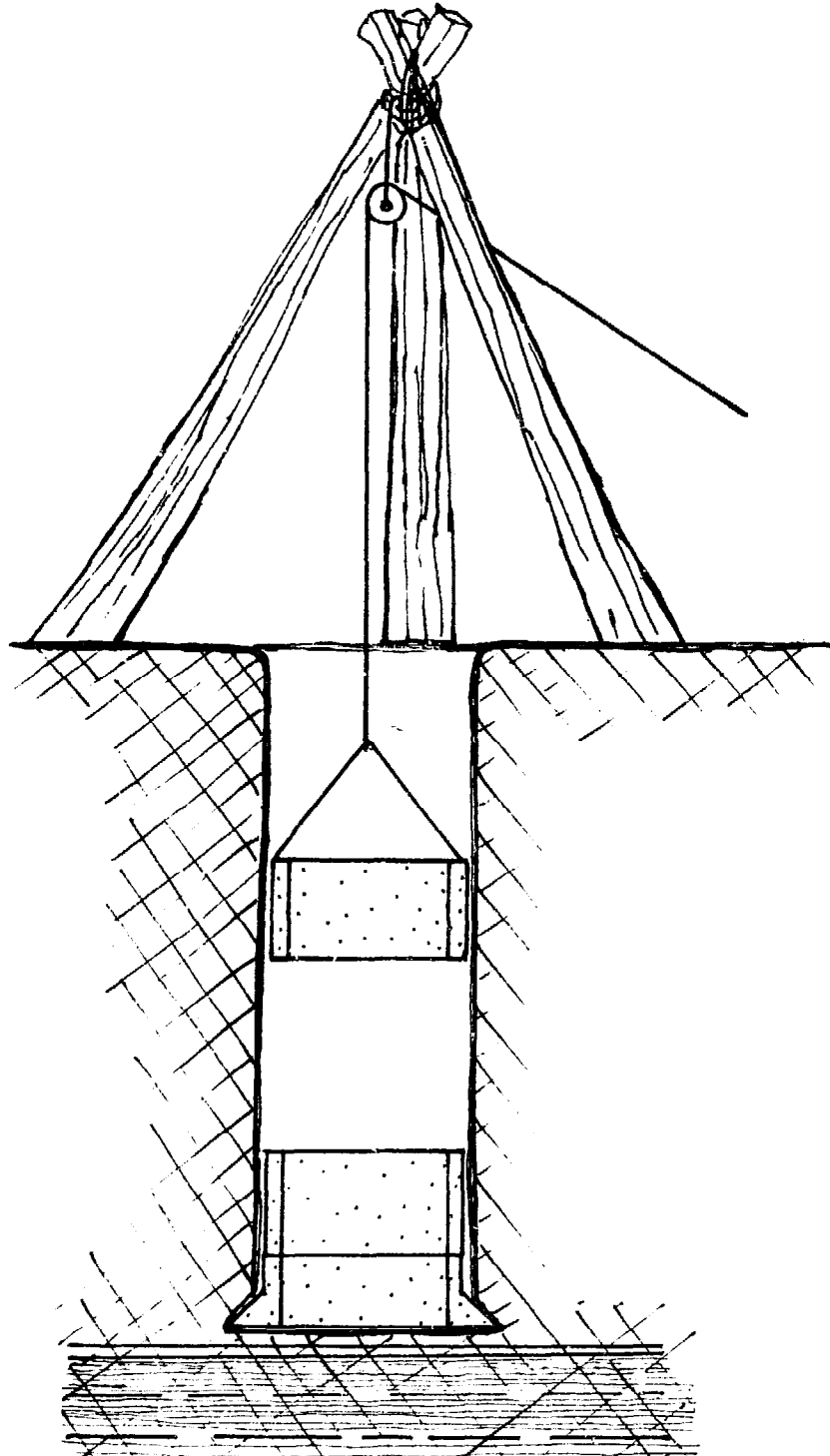

FIG. 8-7. LOWERING PRE-CAST CONCRETE RINGS

- setting them in position at the ground surface and sinking them into place. (See Fig. 8-10.)

Rings should be made so that they:

- can be easily stacked or attached one on top of another;
- can form a watertight joint where they meet;
- are strong enough to support weight of a long column of rings;
- will not rot, corrode, rust or otherwise lose any of the above qualities;
- will not react with water to make the water less desirable for consumption.

This method is more useful in a large project where rings can be centrally manufactured and then transported to the well site for use.

Making your own rings will require the use of inner, outer, top and bottom forms. The inner, outer and top forms can be carefully removed after the concrete has just started to set, usually in an hour or two, making it possible to make several rings each day if enough bottom forms are available. Where a number of forms are available, it is better to leave them in place to allow the concrete to cure better.

You can 1) make your own reinforced concrete rings or 2) sometimes obtain them on the local market as culvert pipe or a similar item. Both are suitable.

Determining how two rings fit together is a major concern when lining a well with concrete rings. Frequently flat edges have simply been mortared and stacked on flat edges. (See Fig. 8-8a.) This provides very little resistance if an unequal sideways force is exerted. A tapered or flared fit is better. (See Fig. 8-8b and c.) These will resist sideways forces better and should be arranged so that water flowing down the outside of the lining will tend to flow away from and not into the well. Where possible, the two rings should be firmly attached together. This is most often done with nuts and bolts through steel fittings cast into the rings. This type of connection is especially useful when the lining will be sunk into place but may not be necessary when stacking rings in an already open hole.

FIG. 8-8. CONCRETE LINING RING JOINTS

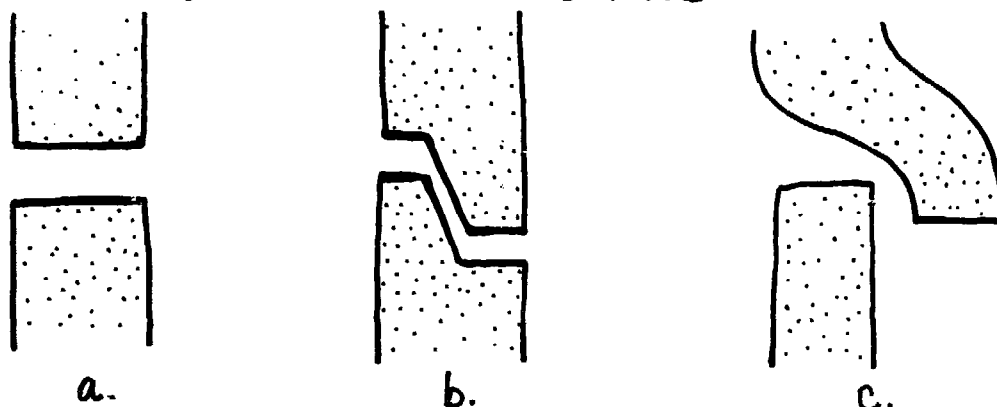

As with most other concrete casting techniques, the concrete in the rings can either be made watertight or porous. Porous concrete rings can be especially useful when sinking the lining into the bottom section of the well.

1. Stacked in open hole: Work Plan

- Dig curb slightly above water level;
- Reinforce the curb and pour it around a form in such a way that a lining ring will sit on top of it. (See Fig. 8-9.)

2. Lower ring into place on top of curb.

- The major problem with lining a well this way is that there is very little adhesion between the lining and surrounding soil.
3. Continue lowering rings and filling in around them until you reach the ground surface.

NOTE: It may be useful to install curbs or some other type of anchoring to help hold the column in place.

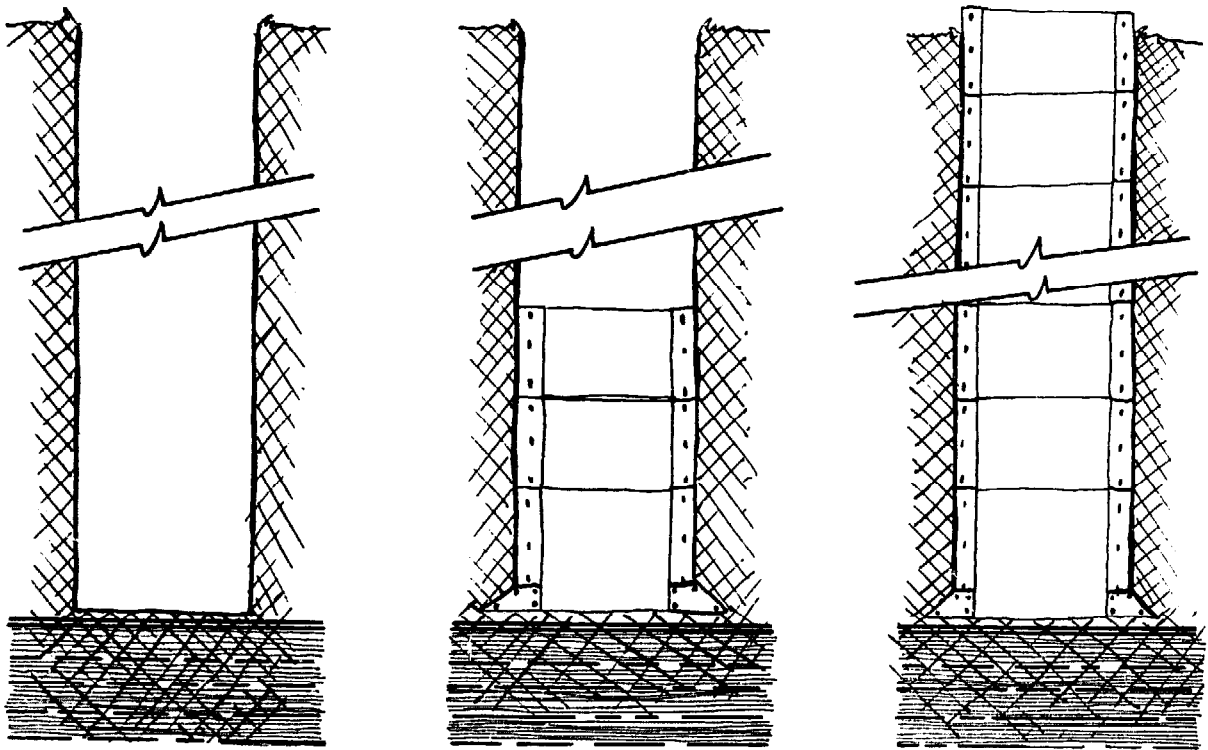

FIG. 8-9. LINING RINGS LOWERED INTO PLACE ON ANCHORING CURB

2. Sunk from ground surface: Work Plan

This involves stacking rings as necessary on a cutting ring while the whole column is sunk by digging out soil from inside and underneath the bottom of the column. Because of its complete protection from caving this method is used in very loose soils that would be difficult to keep the column going out of plumb, especially in loose soils. The problem is compounded by the fact that once the column begins sinking askew it is very difficult and sometimes impossible to get it straight again.

A cutting ring is a special ring that provides a cutting edge to help sink the column and also helps to funnel soil directly underneath it into the middle of the hole for removal. (See Fig. 8-10a.)

1. Set 1 or 2 lining rings on top of the cutting ring. The more rings you can stack, the more weight the column will have and the easier it will be to sink. However, the rings are very heavy and it will usually be very difficult to lift the rings any higher than 1 meter with locally made equipment.
2. Workers will stand inside the ring and dig to remove soil and permit column to sink. (See Fig. 8-10b.)
3. Digging should be done especially carefully to try to remove soil evenly from around the bottom of the hole so that the column will sink plumb.
4. Add more rings when the existing column sinks down to where another ring can easily be added (usually about ground level or just above). (See Fig. 8-10c.)
5. Continue sinking the column and adding rings as far as possible into the water table. (See Chapter 9, p. 99.)

NOTE: Because of the strong possibility of rings sinking askew and the uneven forces that will often have to be applied to the column in order to get it straight again, it is a good idea to have the rings firmly attached to one another.

FIG. 8-10.
SINKING LINING RINGS

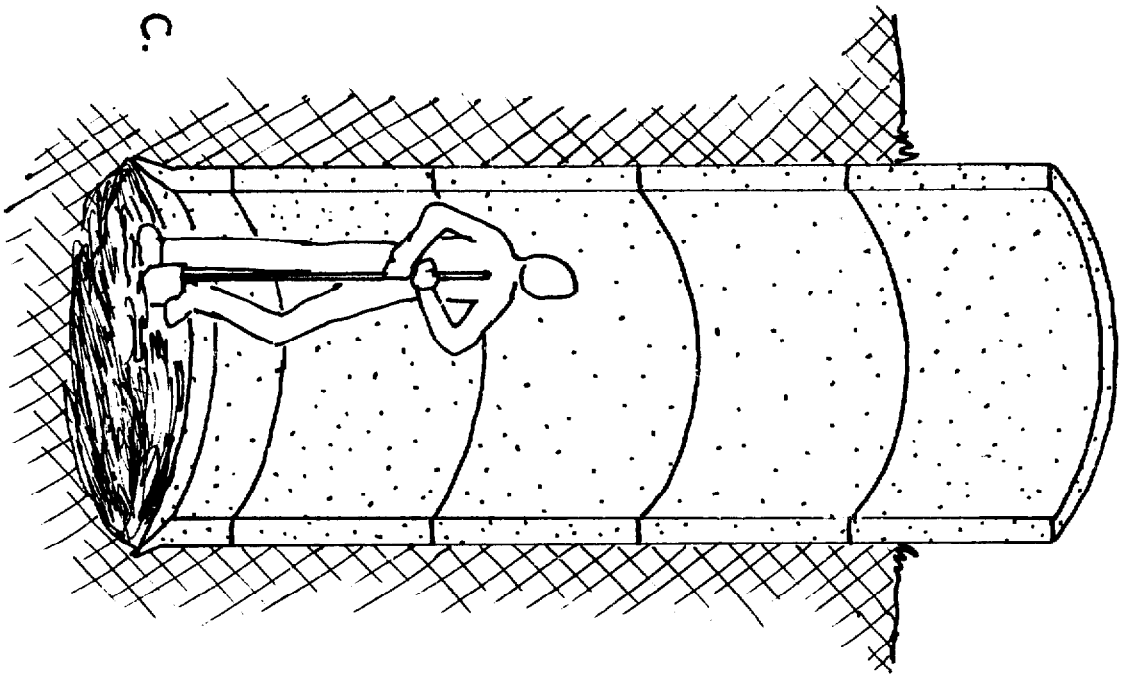
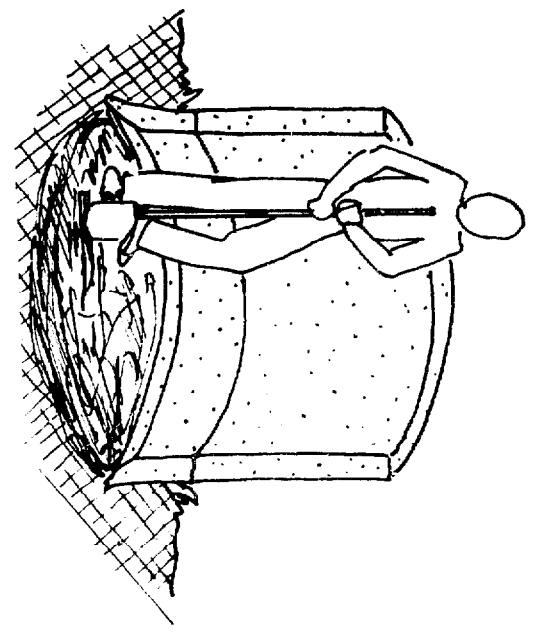
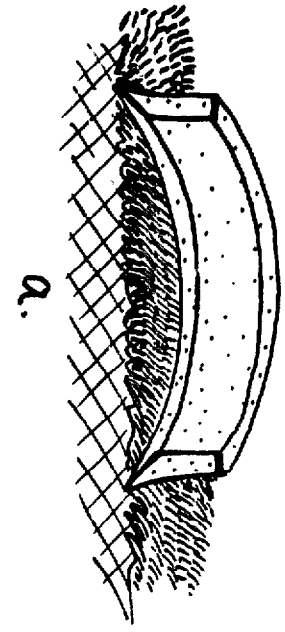

Often in loose soil, mostly sands, the rings sink askew, which causes problems, especially when the thickness of the loose layer is about 4 m or more. In less thick layers (about 2 m) the best way to sink the column relatively plumb is to continue digging as fast as possible until firmer layers are struck. Even if the rings are standing askew, they may be put in an upright position again as follows.

If the rings are askew, as in Fig. 8-11a, work inside the column of rings to remove the soil from beneath the lowest edge of the bottom ring as shown. The hole you dig should extend underneath and beyond the outside edge of the ring. When this is completed, carefully dig the soil away from beneath the opposite side of the column but, on this side, try not to dig any further out beneath the ring than absolutely necessary. (See Fig. 8-11b.) As the column sinks from this point, it should gradually ease over toward the side that was first dug out. (See Fig. 8-11c.)

FIG. 8-11. STRAIGHTENING A COLUMN THAT HAS BEEN SUNK OUT OF PLUMB

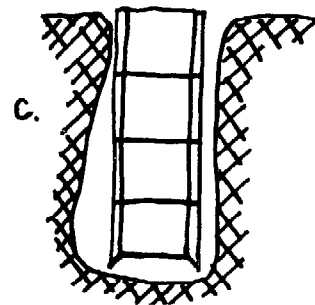
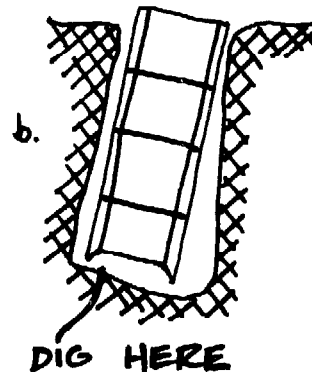
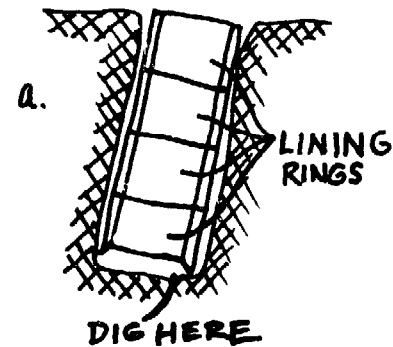

G. Mortar (plaster)

1. Cast in place

Reinforced mortar is used much like reinforced concrete. The major advantage of this method is that no forms are required because the mortar is thrown onto the wall in place.

This variation evolved in Senegal. It was difficult to transport heavy steel molds to the well sites, so the masons would "throw" the concrete onto the walls. But concrete is not very workable so the masons began leaving out the gravel and using just mortar.

Walls are normally plastered meter-by-meter as the well is dug. This is a variation of the "dig-a-meter-pour-a-meter" method used with reinforced concrete.

This process is as follows:

1. Dig the hole about 1.1 m deep.
2. Check the hole diameter and plumb.
3. Cut and shape as much re-rod as possible beforehand because the next steps must be done quickly.
4. Splash the mixture (1:4, cement: water) on all surfaces to be plastered. If the surface dries too quickly, wet it again immediately before plastering.
5. Apply a 3cm thick layer of mortar with a trowel.
6. Place the re-rod.
7. Apply second 3cm coat of mortar while the first is still wet.
8. A third, thinner layer may be applied to make the walls as smooth as possible.

2. Pre-Cast

Mortar can also be used to pre-cast rings even where forms are not available.

1. Dig a round hole with the desired outside diameter of the ring. (See Fig. 8-12a.)
 - The hole's depth will determine the height of the ring.
2. The hole is then plastered and reinforced just as it would be in the well. (See Fig. 8-12b and c.)
3. After it has cured for several days it can be dug up and later installed in the well. (See Fig. 8-12d.)
 - This type of ring should be allowed to harden for at least one week before it is placed in the well.

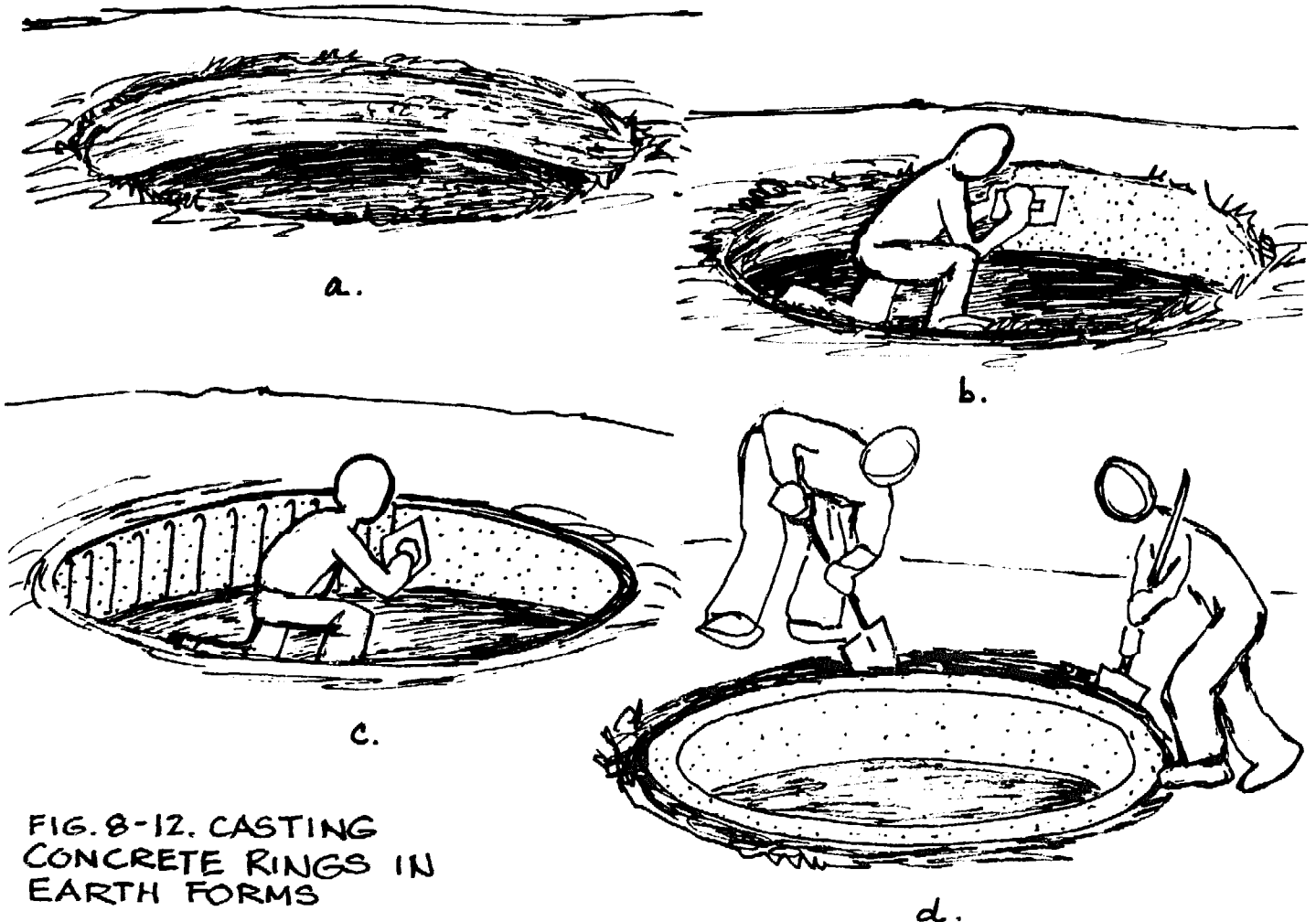

FIG. 8-12. CASTING
CONCRETE RINGS IN
EARTH FORMS

H. Mortared brick or stone (masonry)

Rock has been used to construct linings in wells for centuries. Construction of a well using rock usually involves digging the hole as far as possible into the water table before the lining is built. Once the foundation under water is established, the walls are usually built up in a double layer about 50 cm. thick. Rock walls are very weak in tension so they can be easily cracked if any uneven stresses are put on them.

This type of well can provide acceptable quality well water if precautions are taken to prevent contamination from surface water seepage through the lining. A 5 cm. thick layer of concrete or mortar around the top 3 m. of the lining can prevent the seepage of contaminated surface water back into the well. In fact, the surface water seepage may eventually reach the water table and find its way back into the well, but if this seepage has been filtered through at least 3 m of soil, the potentially harmful contaminants will have been removed. (See Fig. 8-13.)

Brick or stone masonry can be used in most of the different digging and lining methods but, because of its tendency to crack under stress, it is not normally used except to build the lining from the bottom of the well up, in one continuous operation.

A brick or rock wall can be built up on a cutting ring and sunk into the ground (See Fig. 8-14.) but any caving

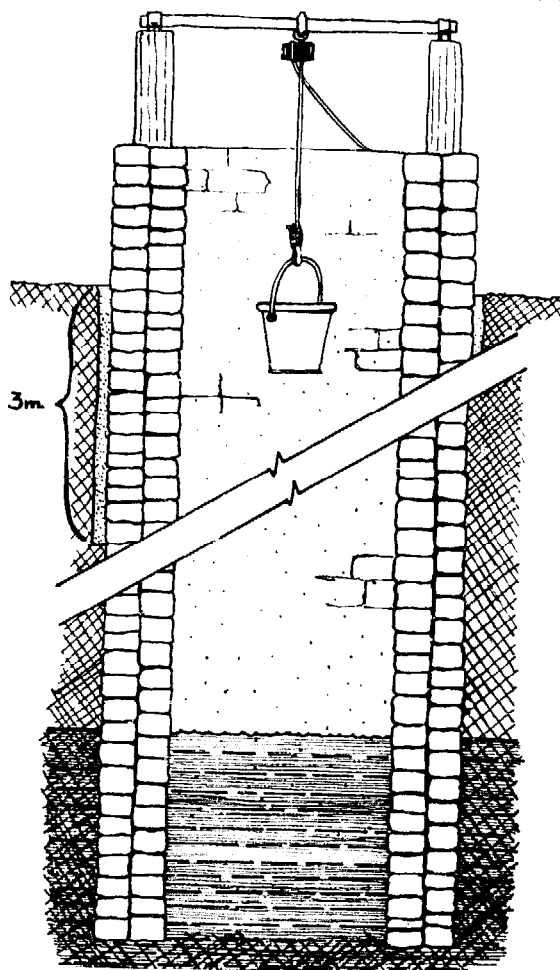

FIG. 8-13. ROCK LINED WELL. 3m. OF CONCRETE OR MORTAR SEAL IS TO PREVENT CONTAMINATION

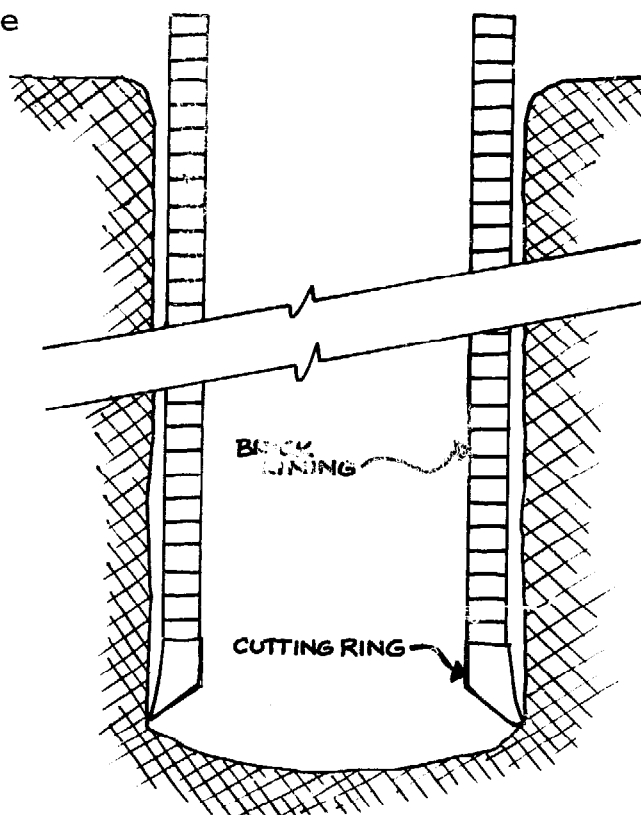

FIG. 8-14. BRICK LINING SUNK ON A CUTTING RING

around the outside could crack or topple the wall. If such a column were to sink askew it could be very difficult to get it upright again without exerting some kind of sideways force on the column which could crack or destroy the column.

It is possible to use reinforcing rod to help hold a brick lining together. This is sometimes used in sinking the bottom section of a well. It is not normally used for construction of the middle section because in most cases a reinforced concrete or mortar wall could also be built with the same materials, and provide a stronger lining. (See Fig. 8-15.)

It is also possible to use masonry to line the wall in sections. When a lining is needed after having dug down a number of meters, a curb can be installed and the lining built up on the curb. The curb serves as a base on which the lining can be built up and as a solid anchoring piece which can be supported to allow digging to continue beneath and through it. As a safety precaution, the curb should be supported by long pieces of wood, or whatever else is available, which can be wedged between the bottom of the hole and the curb. (See Fig. 8-16.)

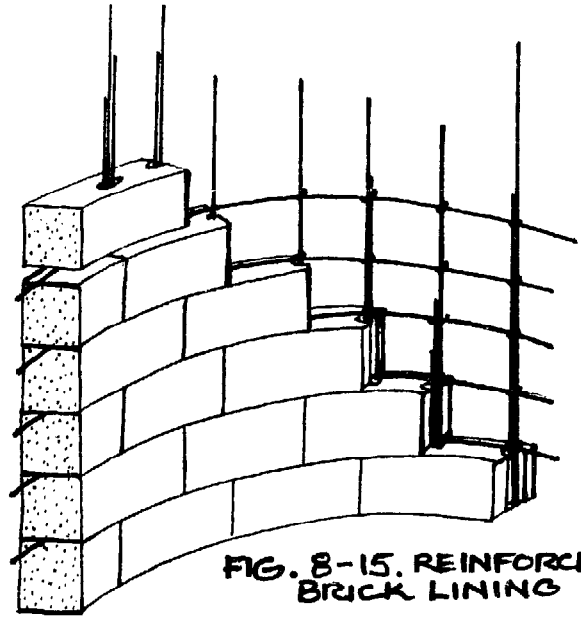

FIG. 8-15. REINFORCED BRICK LINING

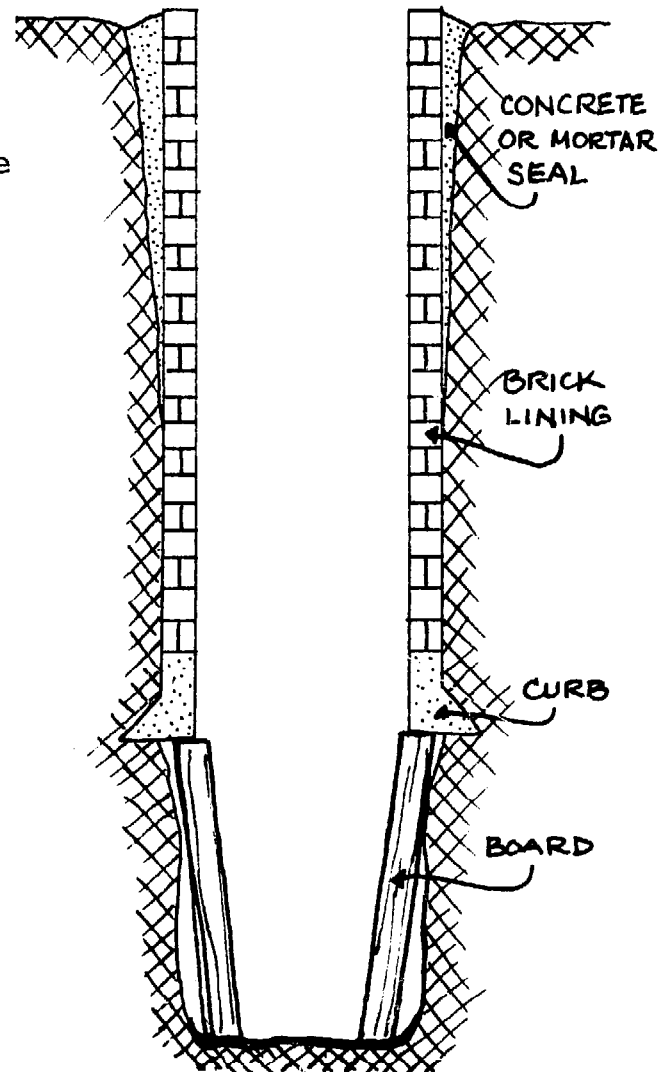

FIG. 8-16. SECTION OF BRICK LINING

Chapter 9

CONSTRUCTION OF THE BOTTOM SECTION

A. Introduction

This chapter provides detailed information to assist wells workers to construct the bottom section of the well. Describing the unique features of that section, it also raises such special concerns as the choice of sinking/lining methods, selection of materials, keeping water out of the well to allow diggers to dig deeper, and facilitating water entry.

The bottom section is that portion of a well below the water table. Its purpose is to allow as much water as possible to enter the well while blocking fine soil particles from the surrounding aquifer. This is accomplished by digging a hole and extending an appropriate lining as far beneath the water table into the aquifer as possible.

As the bottom section is being sunk, using whatever method, water will have to be removed to allow continued sinking. This can be done by simply filling the buckets normally used to remove excavated material and emptying them at the ground surface, or by using a pump. Pumps are generally easier to use because they allow water to be removed from the well faster; a well can be dug deeper than if buckets were used. This will be especially important if the bottom section is being constructed when the water table is above its lowest level and the well is being finished at any other time than the end of the dry season. (See Fig. 9-1.)

The construction of the bottom section consists of the same two operations, digging and lining, as the middle section. However, because water is entering the well while the digging is proceeding and the lining is being installed, the whole process becomes more complicated.

These two situations will limit your ability to dig deeper:

- water flowing into the well

As you begin to get into the water layer there will probably be little water entering the well. As you go further down, water will enter the well

FIG. 9-1.

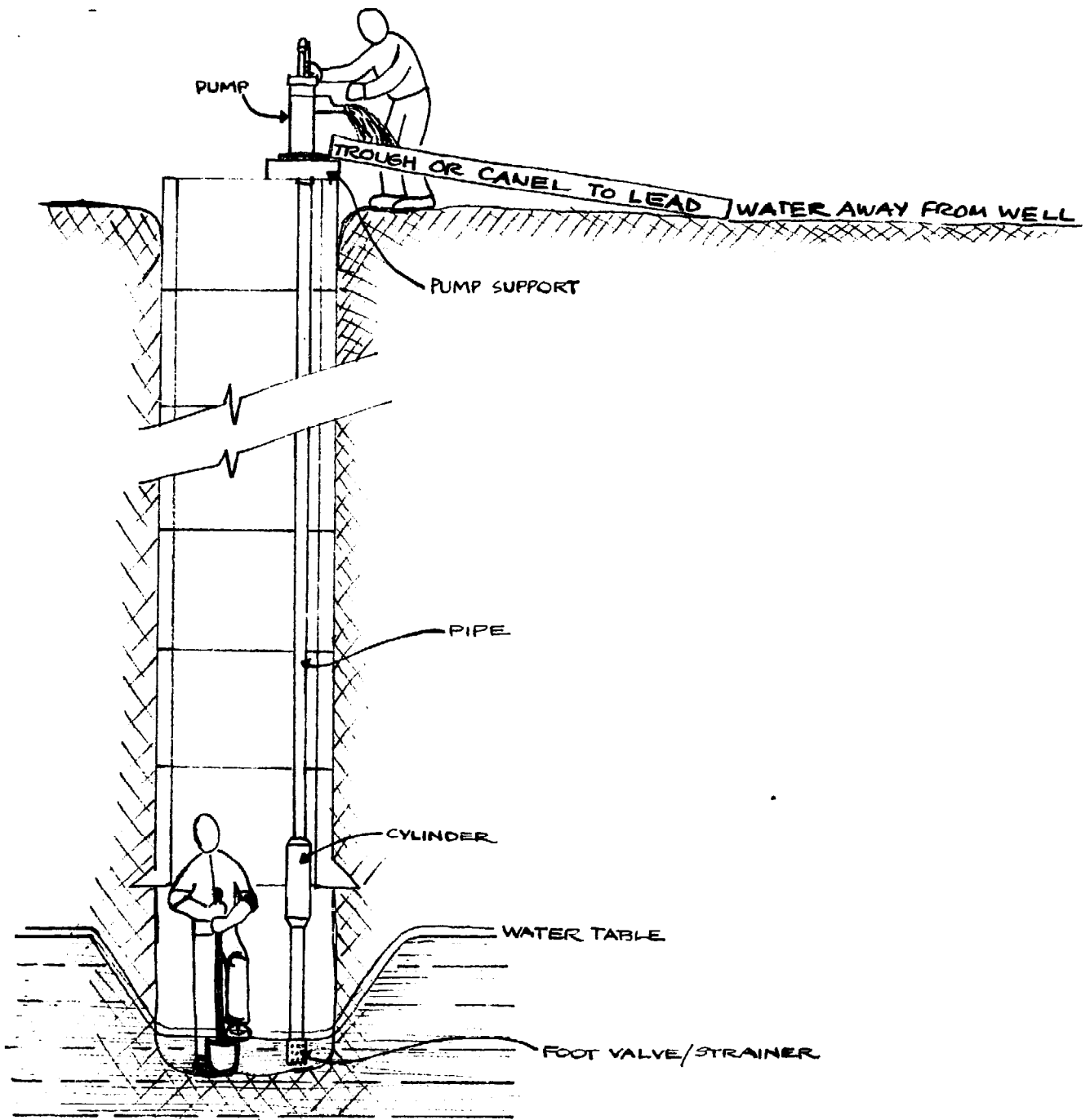

**USING A PUMP TO REMOVE WATER FROM
BOTTOM SECTION WHILE SINKING**

faster until 1) it is coming in so fast that you can no longer remove enough of it to be able to continue digging or 2) you reach the bottom of the water bearing layer. If you reach the bottom of the water bearing layer you will have to evaluate whether the supply of water is sufficient for the needs of the local users. Again there are two possibilities: a) the water flows very slowly, or b) this is an isolated small pocket of water that is limited and will be quickly used up.

In a), the well will always have water in it but there may be very little and people's water consumption may be limited. It might be possible to dig other wells which could each supply a limited amount of water but which combined with the rest would allow for an increase in water consumption.

In b), the decision will have to be made whether to try to continue sinking this well or start another well in a different location.

● walls collapsing as you dig

This is likely to be a problem in all wells, but it will be much more serious in wells which reach aquifers composed of loose, usually sandy soil. The deeper the hole is sunk into the aquifer, the more serious the problem will become. The collapsing of the walls is caused mainly by the flow of water coming into the well. The water, as it flows into the well, exerts pressure on the aquifer particles around which it must pass. The faster the water enters the well, the more pressure it exerts and therefore the more likely the walls are to collapse. By sinking the bottom section lining ring into place, the possible hindrance and danger of collapsing hole walls can be prevented. (See Fig. 9-2.)

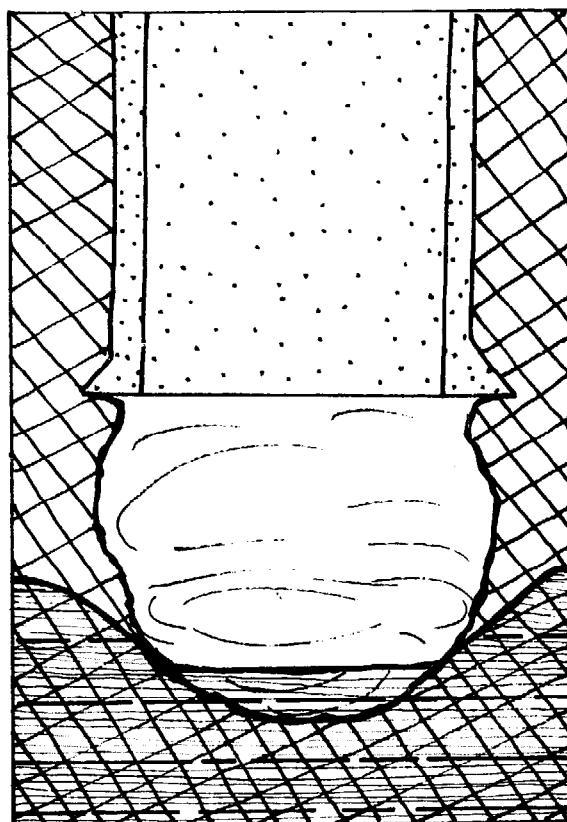

FIG. 9-2. HOLE WALLS
COLLAPSING IN BOTTOM
SECTION

B. Sinking/Lining Methods

1. Sink Lining

To sink the lining into the bottom section the rings must be made just small enough to fit inside the middle section lining. When using reinforced concrete a different set of forms from those used for the middle section lining will be needed. A well can probably be sunk a little deeper using this method rather than others, because it allows workers to spend all their time removing soil and water from the bottom of the hole, thus deepening it.

2. Dig-to-Bottom-and-Line

This method is limited to sites where ground conditions permit digging below the water table. This can only be done where aquifers are made up of relatively consolidated material and is not recommended where the aquifer consists of loose materials that tend to cave-in.

NOTE: Wells have been sunk into loose, unconsolidated aquifers by using temporary lining to reinforce the walls and prevent cave-ins. In most cases today, time and money that would before have been spent on temporary lining can now be more usefully and safely spent working with permanent cement linings installed as the hole is dug either by sinking the lining or digging and lining in short sections.

3. Dig-and-Line-Short-Sections

It may be possible in slightly caving formations to dig and line several short 1/2 m sections before reaching a point where water enters the hole fast enough to slowly erode the earth walls or wash away wet concrete or mortar from inside a form. At this point the lining can no longer be built in complete rings but will have to be continued by completing each 1/2 meter ring in several sections one at a time. The use of quick drying cement will significantly aid this work.

Some have used this technique because it requires less preparation than sinking a lining which requires pre-casting lining rings. It requires less equipment and may produce a structurally superior well, although the structural continuity achieved here may not be of significant advantage in the overall functioning of a well. On the other hand, for shallow wells that reach a limited supply of water, expenditure in time and money on a more elaborate well structure probably will not be worthwhile. Also, the actual work required is somewhat complicated, requiring well diggers to perform various tasks simultaneously and with great competence.

C. Water Entry

The bottom section should be constructed so that the water comes in through the bottom, and perhaps lining, depending on the bottom lining procedure and the ground conditions. (See Fig. 9-3.)

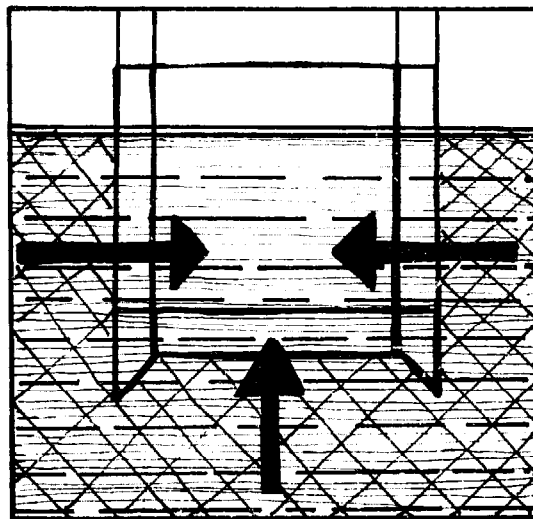

FIG. 9-3. WATER ENTRY INTO BOTTOM SECTION

<u>Lining Procedure:</u>	<u>Water entry through:</u>
sink lining	bottom, and perhaps lining
dig-to-bottom-and-line	bottom, and perhaps lining
dig-and-line-short-sections	bottom

It is best to construct the bottom section so that water will come through the lining as well as the bottom. The more area you have open for water to enter the faster the well will recharge and the less strain there will be on those areas where water comes through. However, an impermeable lining is recommended where the aquifer is likely to be very fine sand that will clog or come through even porous concrete.

1. Water Entry through Lining

There are two methods used predominantly for constructing lining sections that will permit water to flow through. In both cases it is better to construct the lining sections on the surface where their construction can be more easily controlled before they are sunk into the bottom.

a. Leave holes in lining sections

1) Concrete

- Forms should have holes through which you can stick re-rod to make the holes in the concrete.
- Holes should be sloped up and to the middle to prevent aquifer particles from entering the well. The holes could be perfectly horizontal where aquifer particles are larger than the holes.
- Holes can also be poked in the bottom of the well, although this has rarely been attempted.

2) Brick or Rock

Dig to the bottom of the well and stack unmortared brick or rock. The open spaces between the stacked brick or rock allow water to enter.

Many successful wells have traditionally been built this way but it can be difficult to do, is sometimes dangerous, and cannot usually penetrate an aquifer as far as other lining methods.

b. Use porous concrete (cement and gravel with little or no sand)

- Use porous concrete to make lining rings. Simply substitute porous concrete for regular concrete when casting lining sections. Some have suggested using regular concrete for 10 cm of top and bottom edges to strengthen these. Porous concrete is not as strong as regular.
- Use porous concrete to make blocks which can be set on a cutting ring and sunk or built up from the bottom.

2. Water Entry through the Bottom

The bottom of the well should normally permit water to come up through it. However, in unconsolidated (loose) aquifers the water will tend to carry particles of the aquifer along with it up into the well to completely fill and clog it.

Where the well is sunk into a relatively consolidated (firm) aquifer, water coming in through the bottom tends to act similarly but the aquifer particles are usually too big and heavy to be moved by water. In both cases it is advisable to put a filter or plug across the bottom of the hole.

When the aquifer is composed of very fine sand, this sand tends to act as a liquid and follow the water up through the bottom filter. The filter, if properly constructed, will prevent the sand from doing this but must, at the same time, be able to withstand the pressure of the sand and water. Rather than coming up through the filter the sand and water can possibly exert sufficient pressure to push the whole filter layer up into the well and clog it. This is admittedly an extreme case but one that must be carefully guarded against.

D. Construction of the Bottom Section

1. Sink Lining Method

a. Lining Rings:

- are manufactured on the ground surface for later sinking into the the bottom section of the well;
- should allow for water to enter the well, as discussed previously;
- should have the capacity to be firmly attached together;
- should have an outside diameter 10cm less than the inside diameter of the lined middle section of the well;
- can be very heavy and awkward to move and so may require a special lowering device;
- are most commonly made of reinforced concrete or mortar which should be cured at least 3 days

after pouring before being lowered into the well (see Cement Appendix, p. 221.)

- are usually set on a cutting ring which can also be poured at the ground surface although it will require a different form.

NOTE: A cutting ring may not be a necessity in loose sandy aquifers but is useful. The cutting edge could also be cast on to the bottom lining ring. A flat edge will tend to be caught more easily, preventing further sinking, as opposed to a cutting edge which will tend to cut through loose material and funnel it toward the center for easier removal from the well. (See Fig. 9-4.)

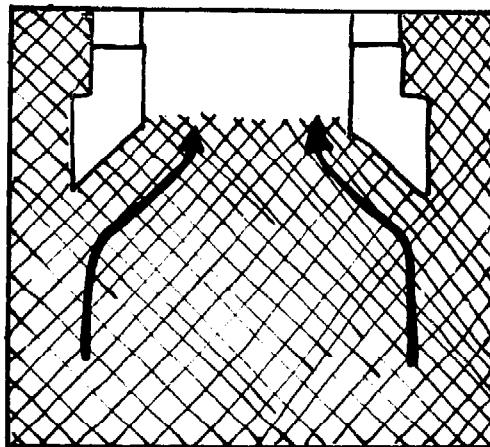

FIG. 9-4.
CUTTING RING EFFECT

b. Construction Procedure

1) The general construction procedure to be followed when all materials are assembled and ready for use is as follows.

- stack several (usually 2 to 4) lining rings on top of a cutting ring which has been centered and levelled in the bottom of the hole.

This initial column should be 2 to 3 meters high whether it is composed of 1/2 meter high rings or 1 meter high rings. If holes have been made in the rings to allow water entry, make sure that the holes slant up toward the middle of the hole. Firmly attach rings together by whatever means you have chosen.

Unstable ground can make the initial leveling/plumbing of rings very difficult. Where you can anticipate this, place a layer of gravel on the bottom before lowering the cutting ring into the hole.

- after the lining rings have been stacked on the cutting ring in the hole, well diggers will fill in the space between the lining and the middle section lining with gravel. (See Fig. 9-5.) Instead, some have placed several boards vertically in that space to act as a guide to help the column sink straight. (See Fig. 9-6.) Gravel is easier and better to use because it will tend to fill in around the rings as they are sunk, filling up any voids that might be created by over-pumping. Gravel is also a convenient filler that is normally used to fill that space once the bottom section is sunk.

FIG. 9-5. GRAVEL USED TO GUIDE SINKING RINGS

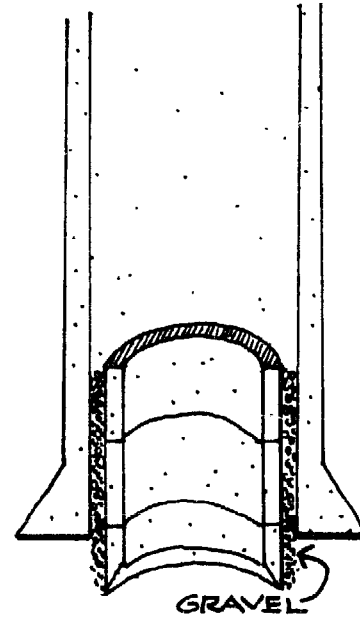
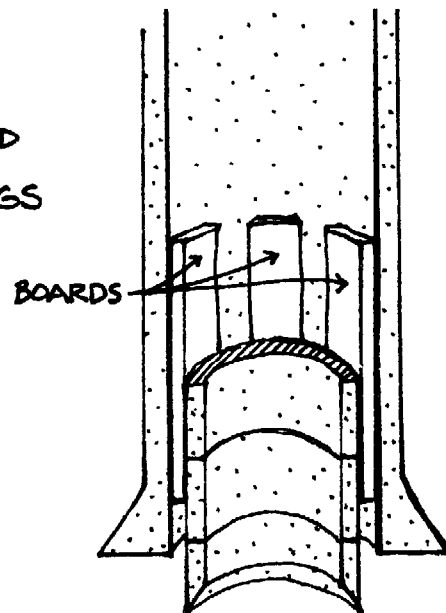
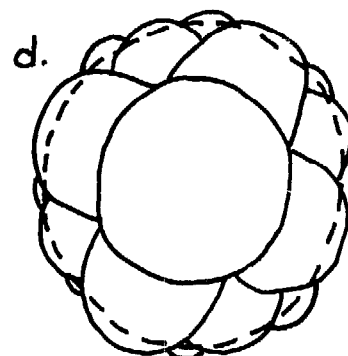
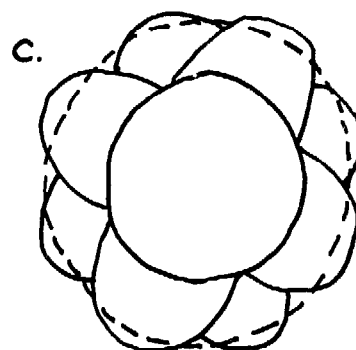
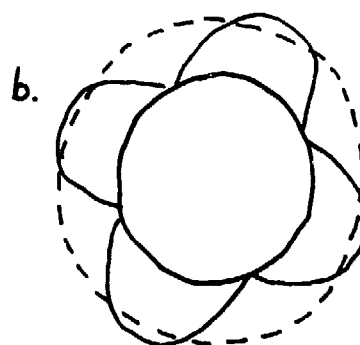
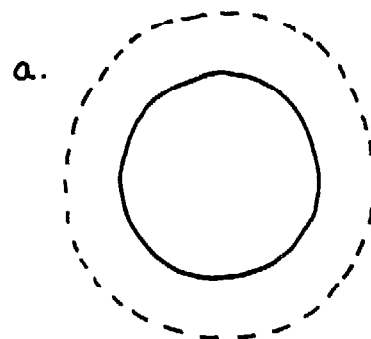
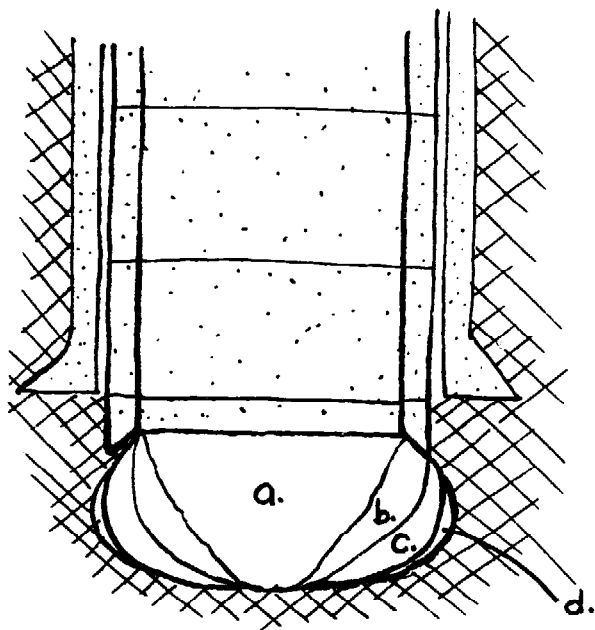

FIG. 9-6. BOARDS USED TO GUIDE SINKING RINGS



- Remove soil and water from inside the cutting ring thus causing the column to sink. Begin digging in the middle and gradually work out to the edges of the column being careful to remove soil evenly so as not to encourage the column to sink out of alignment with the rest of the hole. (See Fig. 9-7.)
- Add more rings as necessary as the column sinks. It is always necessary to have some overlap of the sinking column and the middle section, and helpful to have up to 2 meters of overlap to provide extra weight which will aid sinking and help to guide the column down.
- Plan to add more rings when it won't interrupt the sinking process. If it requires many people to lower the rings, lower as many as you need in one or two sessions to avoid the need to regather and reinstruct a large group of people.
- Continue digging and sinking until water can no longer be removed from the hole fast enough to allow further sinking. This will occur when well workers are digging in as much as 1 meter of water. Remember, the farther this column is sunk into the water bearing layer without going beyond it, the more water will be available from that well. In commonly-found loose sand aquifers, the column of rings is usually sunk between 2 and 4 meters beneath the bottom of the middle section lining. In more consolidated aquifers, where water generally enters the well more slowly, a greater depth can and should be reached.
- When sinking is stopped it is necessary to have some overlap between the respective linings of the middle and bottom sections. If the well has been completed in other than the end of the dry season, it may be useful to leave several extra ring sections stacked up into the middle section lining. If necessary, the well can then be easily deepened at the end of the dry season when the water table is at its lowest level. This will help to provide a permanent supply of water.

FIG. 9-7.



Digging steps while sinking lining

- a. Dig a cone-shaped hole down to a convenient depth.
- b. At four evenly spaced points in this cone-shaped hole, widen the hole so that it reaches the width of the cutting ring.
- c. Widen the hole at four more places between the areas already widened.
- d. Continue enlarging and widening the hole until the column of rings sinks.

2. Dig-to-Bottom-and-Line

It is likely that this method will only be considered when:

- The middle section of the well has been dug but not lined because there is little danger of soil collapse. (A temporary lining could be used to reinforce the section or help prevent caving.)
- The water bearing soil is firm enough to permit digging and removing water without great danger of collapse.

Under these conditions an open hole can be dug down into the aquifer. Even so, digging beneath the water table must be done very carefully and can only reach a limited depth because of the increased danger of cave-ins and collapse as the hole reaches deeper and deeper into the aquifer. The hole should be dug as deep as is safely possible.

In the traditional well, the lining is begun by stacking rounded stones to a height of between .5 and 1m. (See Fig. 9-8.) A rock or brick masonry wall is then built on top of the loose rock wall. Alternately, pre-cast rings can be lowered in place or the lining could possibly be poured in place. If, however, one has the equipment and supplies to cast concrete walls, it is usually possible to sink the lining into place. This is much safer and can reach a greater depth where there is any danger of cave-ins. Whatever lining method is used is then continued up to the ground surface and the top section of the well constructed.

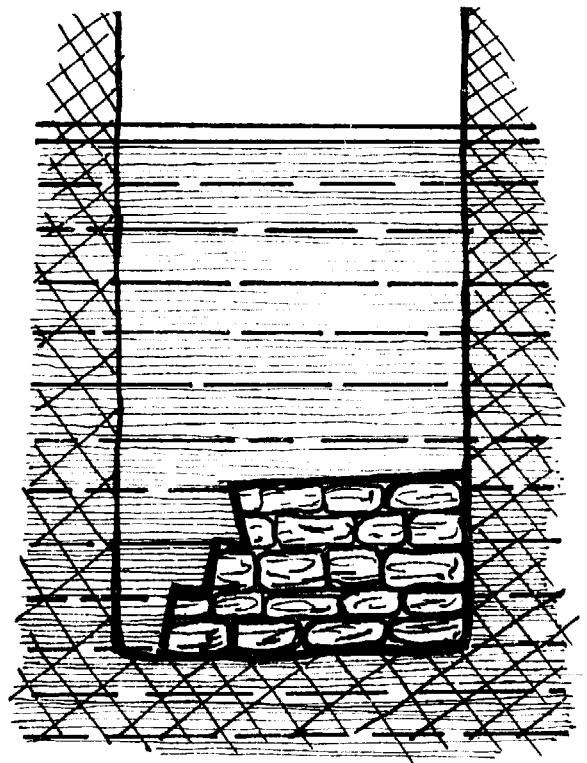

FIG. 9-8. TRADITIONAL WELL BOTTOM

3. Dig-and-Line-Short Sections

This particular method of digging into the water table is a variation of the "dig-a-meter, pour-a-meter" method sometimes used to line the middle section. The bottom section is dug and lined, usually 1/2 meter at a time. As the aquifer is penetrated increasing amounts of water will enter the well as the depth increases. Eventually a depth will be reached where the water is coming into the well so fast that 1) it will wash away the mortar or concrete before it has a chance to set, or 2) it will wash the walls in before there is time to set a form, re-rod, and pour. From this point, use the following procedure to extend the well as far into the aquifer as possible.

- Make sure that the vertical re-rods extend beneath the bottom of the last pour so that the subsequent sections can be attached to the existing lining.
- Dig in the center of the hole to form an inverted cone which is about 40 cm deep and sloped out to the bottom of the previous plastered section. (See Fig. 9-9a.) This tapered hole keeps sand from washing out from behind the sections already lined.
- Quickly dig a short section on one side down to about 30 cm. (See Fig. 9-9b.)
- Roughly plumb and smooth the newly dug short section.
- Throw handfuls of dry quick-setting cement mix onto the moist slowly collapsing sand.
- Moisten small quantities of the mix and quickly plaster the short section. The mortar should set (in about 5 minutes) before the water flow causes it to collapse. (See Fig. 9-9c.)
- Continue digging and plastering short sections 30 cm deep around the hole until one complete 30 cm deep section is plastered. (See Fig. 9-9d.)
- Place re-rod; leave extensions below plaster limit for connection to next pour.

NOTE: A quick-setting mortar mix consists of 1 part quick-setting cement, 2 parts ordinary cement, and 1 part sand.

- Plaster over re-rod with same quick-setting mix.
- Continue digging and plastering short sections

FIG. 9-9
DIG AND LINE
BOTTOM SECTION

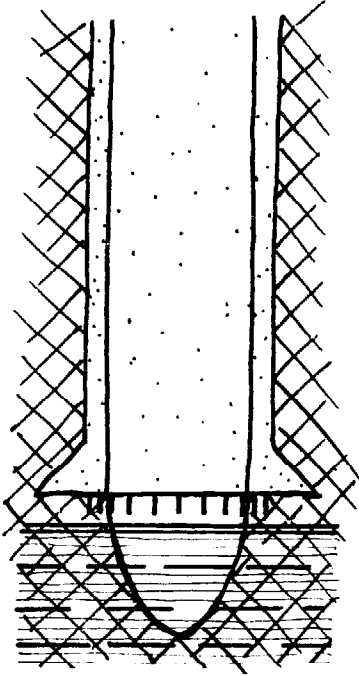

- a. Dig a 40 cm deep inverted cone-shaped hole.

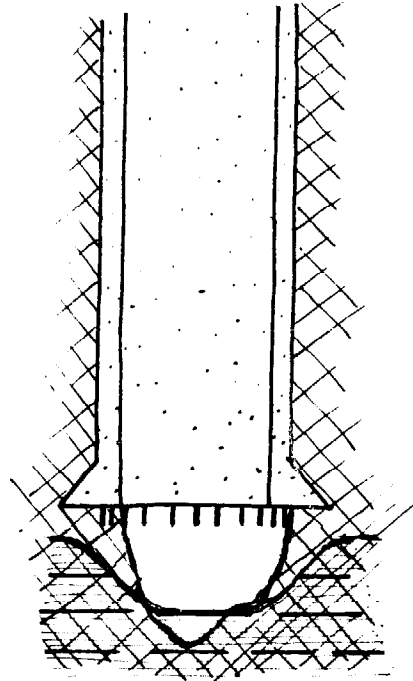

- b. On one side, quickly dig and plumb a 30 cm deep section.

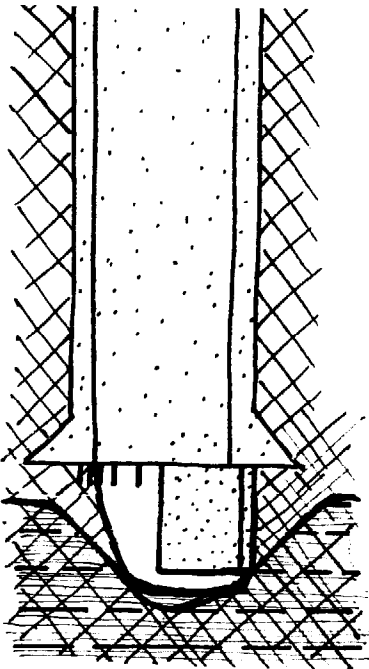

- c. Immediately cover the 30 cm deep section with a layer of mortar.

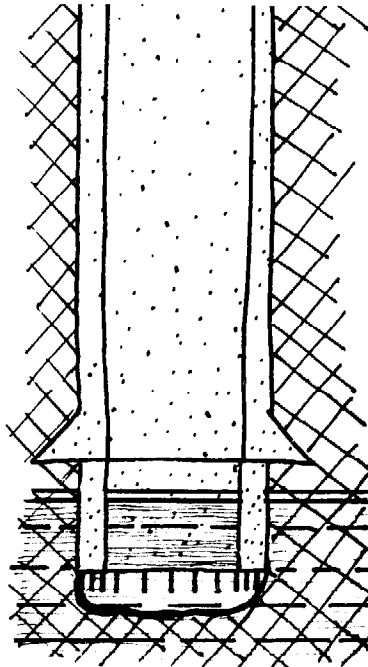

- d. Continue mortaring short sections until the hole is lined all the way around, then attach re-rod and put another layer of mortar over the re-rod.

until 1) the water flowing into the well prevents further plastering, or 2) you have reached the desired depth into the water table. Do not leave any re-rod exposed to water. If necessary bend it up and plaster, or cut it off and plaster.

NOTE: Special bricks may be made for covering places where water is coming through the sand too quickly to permit plastering. These bricks are made outside the well by spreading a 1 1/2 cm. layer of mortar on a flat surface, and then cutting it into 15 cm.x 15 cm. squares with the edge of trowel before the mortar dries. Whenever a spot is found where the water flow is so rapid that it erodes even the rapid setting mix, one of these square mortar bricks can be used as a stopper. Throw dry cement mix freely on the place where the water is entering and slap a flat brick over it. Hold the brick in place until the cement sets. It can then be plastered over in the same manner as the rest of the short section being lined.

E. Bottom Plug or Filter

Most hand dug wells need a filter over the bottom of the well that will allow only water and no fine particles of soil to enter the well. It is especially critical where the aquifer is very fine sand. Only where wells are sunk into hard rock is this not a consideration.

There are two different materials that can be used separately or together: a gravel filter or a porous concrete plug.

1. Gravel Filter

A layer of gravel across the bottom of the well can serve as the filter.

A minimum depth of 20 cm is suggested. The filter can be made more effective by using 2 or more different sizes of gravel in separate layers with the smallest size gravel on the bottom and the largest size gravel on top.

2. Concrete Plug

a. This is a slab of porous concrete which fits closely to the inside diameter of the bottom lining. The slab can be cast in sections on the surface and later lowered and placed in the well. It is placed in the well on top of a shallow (10 - 15 cm) layer of gravel.

The slab should be made porous either by making holes in a regular concrete slab or using a concrete

mixture with very little sand as described in the Concrete Appendix. It can easily be cast on the surface digging a mold out of the ground.

b. Making a bottom plug with the ground as the form

- Choose a fairly flat section of ground that can be dug and will hold its shape.
- Draw a circle with a diameter a few centimeters less than the inside diameter of the bottom section.
- Dig out the circle to a depth of 6 cm and make the bottom surface fairly even and square with the sides. (See Fig. 9-10.)
- Put a divider across the center of the circle so that you will then pour two halves of the slab which can be more easily lowered and placed. The divider should be at least 6 cm high and be made from some suitable form material. (Alternately where a divider is not available or appropriate, two circles can be drawn but then only half of each dug out to form the two halves of the slab.) (See Fig. 9-10.)
- Place re-rod in each half of the form. Leave handles or lowering hooks. When using 10 cm re-rod it can be placed 20 cm apart or with 8 mm re-rod leave 15 cm between re-rods.
- Pour concrete - either standard or porous mix. If using non-porous concrete, make holes through the slab with a piece of re-rod when the concrete begins to set.
- Cure for about a week.
- Place in well on 10 to 15 cm of gravel.



a. Dig a 6 cm deep hole to the desired size.

b. Pour concrete in the form after the re-rod has been placed.

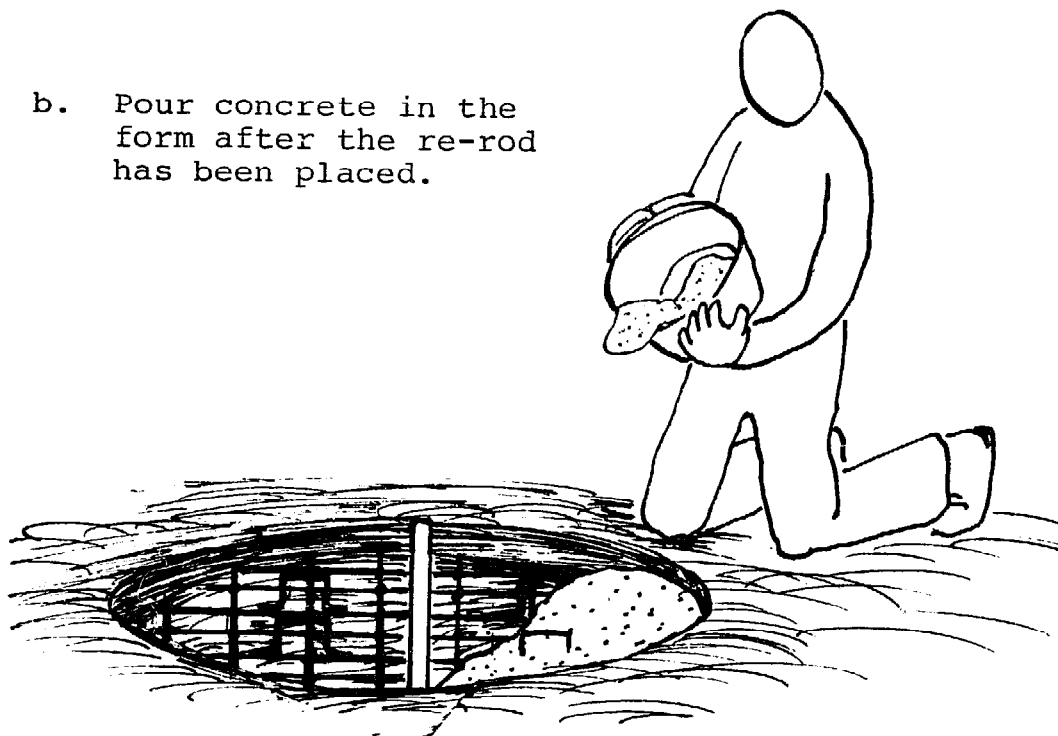

c. After the concrete has set and cured for a week, it may be dug up and placed in the well.

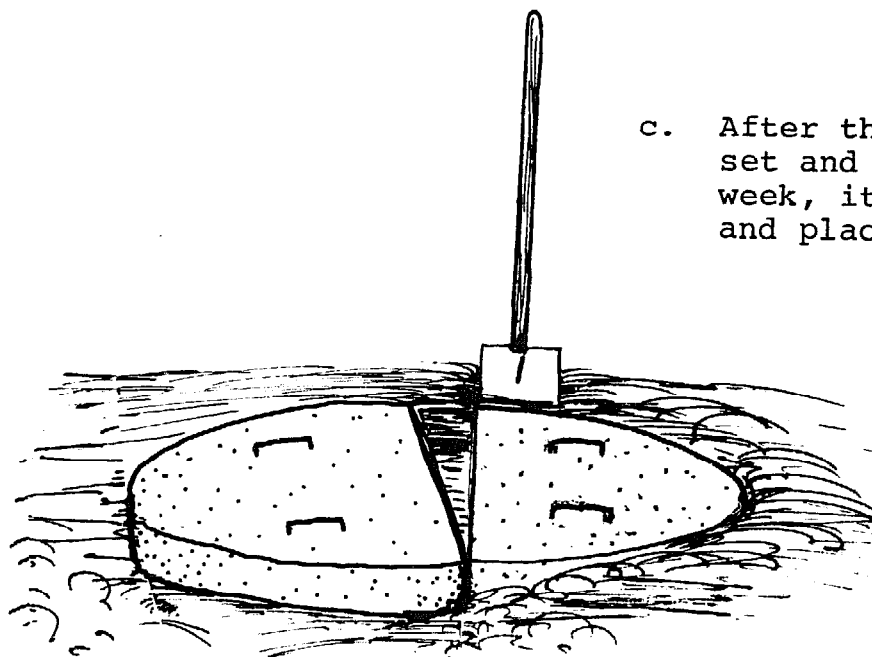

Section 3:
DRILLED WELLS

Chapter 10

INTRODUCTION TO DRILLED WELLS

A. Overview of Small Diameter Wells

1. Basic Features

Small diameter wells usually have diameters of less than 50 cm and can be as small as 2.5 cm. For the purposes of this manual, all wells that are sunk by using tools from the ground surface, and therefore do not require that people go down and work in the well to sink them, are small diameter wells. They are also called "drilled" wells, "tube" wells, or "boreholes."

Small diameter wells normally require a pump to supply water on demand at the surface. These wells are usually small enough so that a bucket used to lift water from a large diameter well will not fit into the well. A special water lifting device must then be built and installed in the well to allow people to draw water.

There are many different kinds of water lifting devices that may be used, ranging from a modified bucket arrangement that will fit in the well to a motor-powered turbine pump capable of delivering thousands of liters per minute. This manual emphasizes pumps that will comfortably supply enough water to meet the minimal needs of the local population.

Every small diameter well is sunk by using the same arrangement of equipment. At the ground surface is a power unit which supplies the necessary motion to sink the hole.

At the bottom of the hole is a cutting tool (drill bit) which, when moved in a certain way, loosens whatever soil or rock is beneath it in the hole. (See Fig.10-1)

Between the power unit and the bit is a connecting mechanism that transmits the motion of the power unit to the cutting tool.

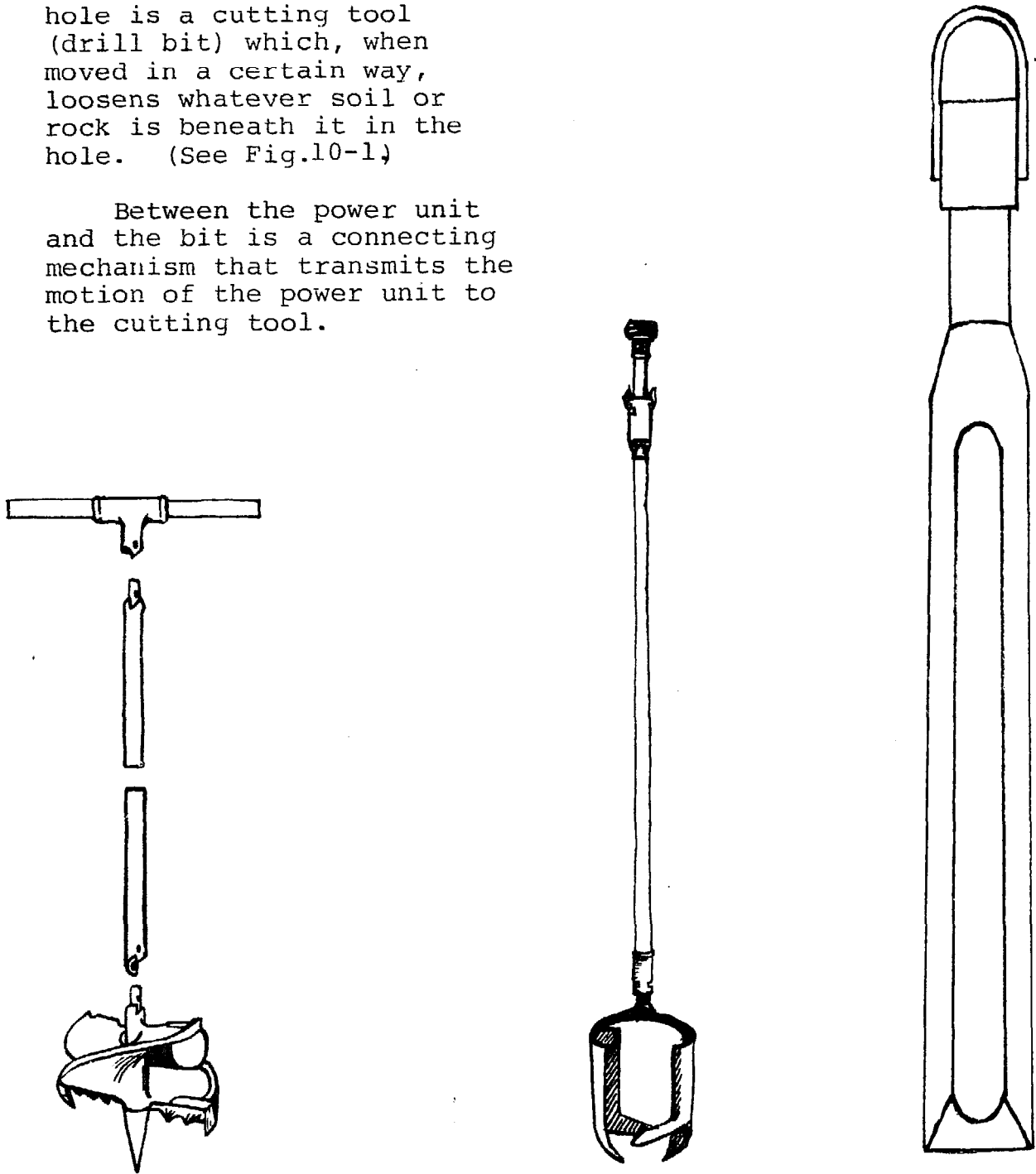

FIG. 10-1. DRILL BITS

2. Drilling Motions

Because of the size and shape of small diameter wells and the equipment required to sink them, there are only two different kinds of drilling motion that are used (Fig. 10-2):

- a. up and down - called percussion
- b. around and around - called rotary

All well sinking equipment is intended to use one of these two different motions. However, all such equipment is designed to use one of the motions predominantly and often the other motion in some secondary capacity. Thus, tools that use an up-and-down motion are referred to as "percussion" tools because they rely on their downward fall to stike and loosen ground materials. Tools that must be turned to gouge and scrape ground materials are referred to as "rotary" tools for obvious reasons.

Both of the different types of equipment can be adapted for use in most ground conditions. However, when using simple hand powered variations of either of these techniques there are certain limitations which will be noted later.

3. Removal of Drill Cuttings from the Hole

In order for the cutting tool or drill bit to effectively do its job of loosening the soil at the bottom of the hole, the soil and rock that it has already loosened or chipped away must be removed so as not to hinder the bit's continued operation. There are several different techniques and tools that can be used.

- A special tool can be lowered into the well to remove the drill cuttings. For example, a bailer, which is essentially a hollow tube with a valve at

FIG. 10-2. DRILLING MOTIONS

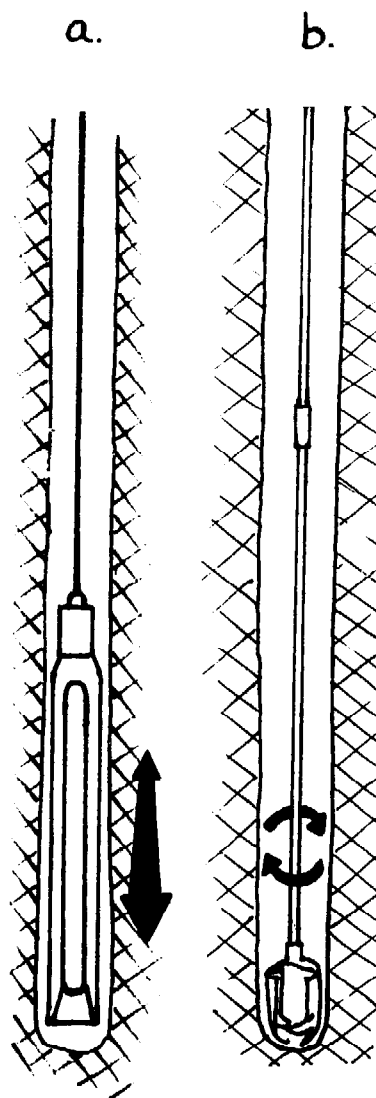

the bottom end, can be lowered to the bottom of the hole and then dropped, to pick up the drill cuttings. When the bailer is dropped onto a pile of drill cuttings, the cuttings force the valve open as the bailer falls down around the cuttings. When the bailer is lifted, the valve closes, allowing the bailer with the cuttings inside it to be lifted to the surface and emptied (Fig. 10-3)

- The cutting tool itself can be used to remove drill cuttings from the hole. For example, auger bits which are screwed into the ground remove soil by either accumulating the loosened soil inside the bit (see Fig. 10-4a) which will have to be emptied regularly, or by forcing the soil upwards as the bit is rotated. (See Fig. 10-4b.)
- A fluid can be used to continually pick up drill cuttings and carry them to the surface. Fluid is normally pumped down through the drill rod and out of holes in the bit where it picks up drill cuttings and carries them back up through the hole.

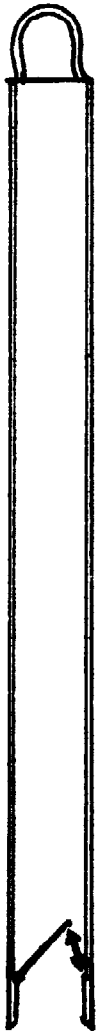

FIG. 10-3. BAILER

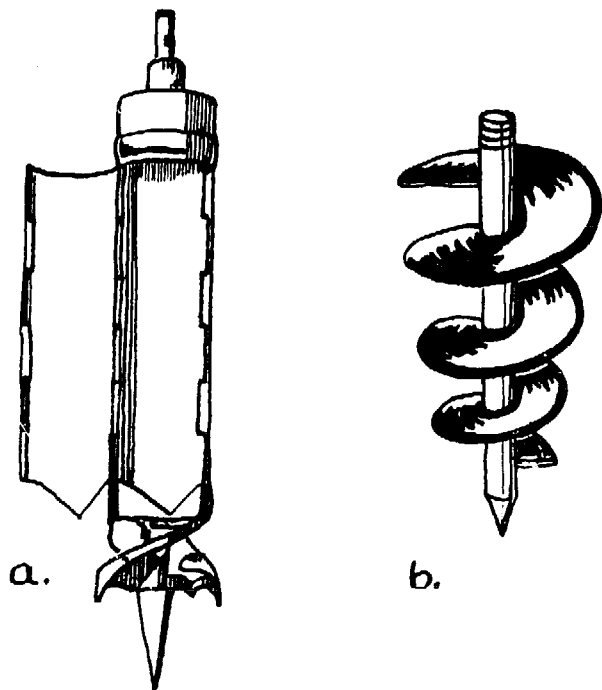

FIG. 10-4. AUGER BITS.

4. Equipment and Materials

Here are the equipment and materials that are usually employed (see Fig. B for illustration of Materials):

- hole sinking equipment: Choose equipment which is appropriate to the particular ground conditions.
- hand tools: Each sinking method will require a specific set of hand tools. Example of tools that are often needed include pipe wrenches, screwdrivers, tape measures, and hack saws.
- lifting/lowering equipment: This equipment is always useful but the particular sinking technique chosen and the depth of the well will determine whether it is necessary.
- casing: This pipe is used to hold the hole permanently open to allow the use of pumps.
- well screen: This allows water entry and prevents the entrance of aquifer material.
- water lifting device (see Pumps): This pulls water out of the narrow casing pipe.
- material to build platform around well head (cement preferred).

5. Casing

A pipe is installed in a well to prevent the hole walls from caving in and provide a conduit through which water can be brought to the surface.

If a well is sunk through anything other than consolidated rock, it will need to be cased to assure a permanent hole.

The casing extends from just above the ground surface to the top of the well screen which is at the bottom of the well.

Commercially drilled wells are usually cased with steel pipe which is either welded together or coupled, using specially threaded couplings. Although plastics are being used increasingly because they will not rust or corrode, nevertheless they cannot be driven into the

hole as required by some drilling techniques and ground conditions. Basically, any cylindrical product which can be installed in the hole to prevent its collapse will work. For small diameter shallow wells, galvanized iron pipe, clay tile, bamboo and even hollowed logs have been used, although the last two are, for obvious reasons, not recommended.

NOTE: Before using steel or even galvanized iron casing, test the water to obtain some kind of measure of its corrosive properties. In Liberia, wells with steel casing had life spans of as little as six months due to corrosion.

6. Well Screen

This is the water intake section at the bottom of the well. It is about the same diameter as the casing and is made as long as is necessary a) for the depth of aquifer and 2) to produce the amount of water needed.

The screen itself acts both as a filter and as a medium through which the soil particles immediately surrounding the screen can be rearranged to permit easier and better water flow into the well, a process known as well development. Wells are usually developed by rapidly forcing water in and out of the well screen. This removes the fine soil particles from right next to the screen leaving only larger soil particles with larger spaces between them, thus permitting more and easier water movement into the well. (Fig. 10-5)

The different kinds of screens are discussed in detail in Chapter 15.

FIG. 10-5. CONTINUOUS SLOT WELL SCREEN IN DEVELOPED GROUND FORMATION

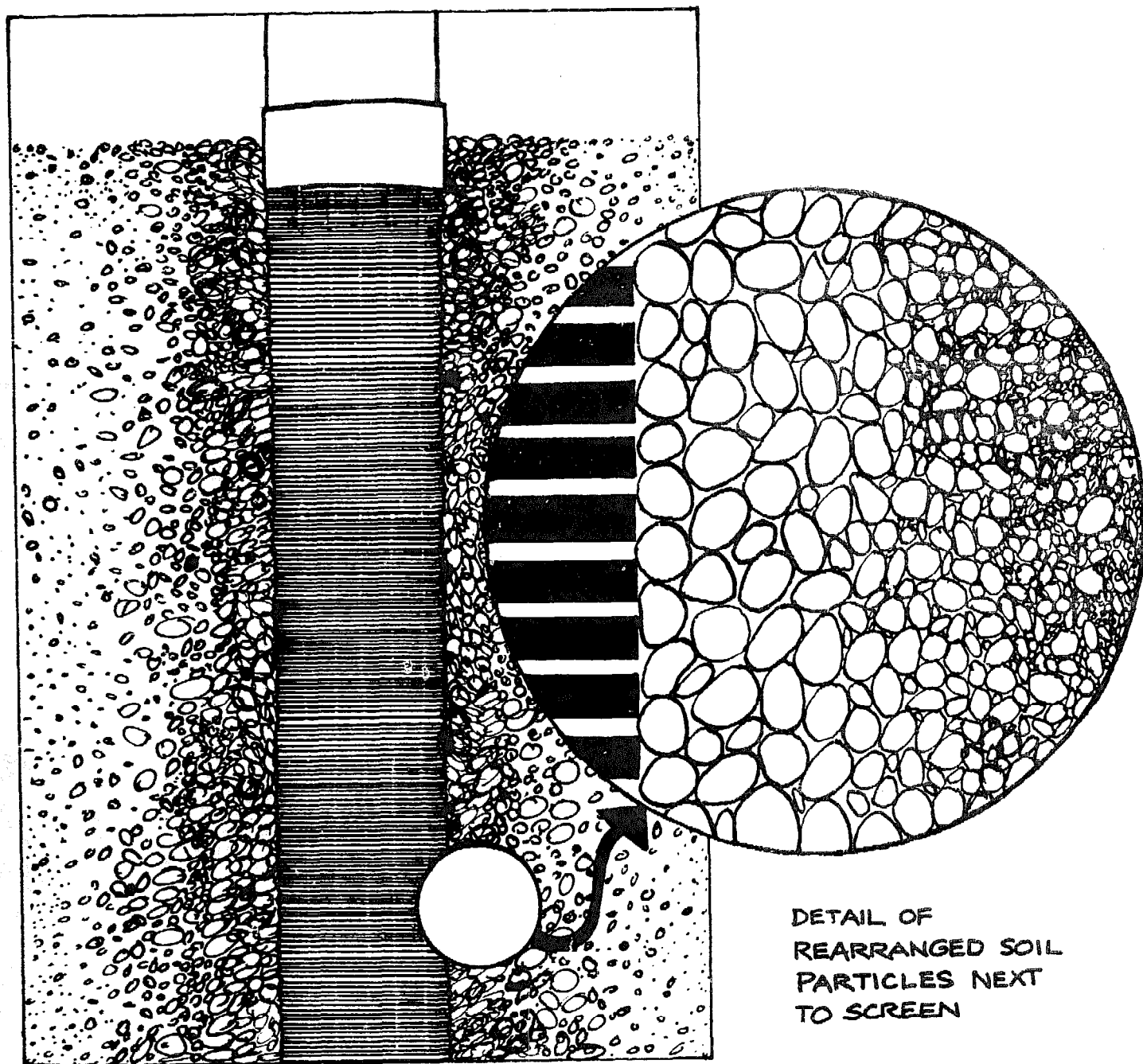

B. Design of Drilled Wells

The basic objective of well design is to achieve the best combination of materials, techniques, and cost to produce a well which is useful to a local community. Against a background of scarce material and financial resources, the design of wells for small rural communities in the developing countries requires a flexible approach to individual water supply needs that involves compromises on the allocations of community resources.

1. Design Problems

Two major problems in all water improvement projects: a) system maintenance and b) water testing and treatment should be considered in the design and planning of the well.

- Maintenance is the major problem in water development. A system cannot last anywhere nearly as long as expected unless regular maintenance is performed on the system and the usual minor problems are fixed as they happen.

- Water testing and treatment:

Water is rarely tested to determine its chemical and bacteriological characteristics. Chemical testing is necessary to determine possible appropriate materials for intake and pumping equipment, as well as potability. Bacteriological testing is needed to detect possible disease-carrying organisms. Many simple, inexpensive, and relatively effective methods of treatment are available and could easily be used to help ensure water potability and to lower disease rates. (See Appendix VIII.)

2. Diameter

Where large supplies of water are needed, the normal procedure for determining the well diameter is to:

- determine the quantity of water needed;
- find the size of the pump needed to deliver a certain quantity of water per unit of time which is lifted a certain distance (head);

- choose casing that is slightly larger than the pumping equipment;
- excavate a hole whose diameter can accommodate the required casing. (See p. 145.)
This presumes finding one or more aquifers that can deliver the quantity of water needed.

For small wells, the same general considerations apply, although based on the selection of the most appropriate equipment available. The casings in most of these wells will be between 5 cm and 10 cm in diameter.

3. Depth

- Where it is possible to get any idea of what the depth of the well will be, a sinking method must be chosen that is capable of reaching that depth.
- Where small water supplies are being developed, the usual practice is to develop the first major aquifer, reached by sinking the intake section as far into the aquifer as possible with the given equipment, until a sufficient supply to meet local needs is assured.
- The possible depth of the well sunk with hand-powered drilling techniques is usually about 20 meters except where a fluid is used to remove drill cuttings, in which case wells can often be sunk deeper.

4. Choice of Pump (Also see Pump Appendix.)

- The largest commonly manufactured hand pump cylinder will fit in a 14 cm hole.
- The deeper a well is, the smaller the diameter of the pump cylinder used.
- It may be difficult to introduce hand pumps on previously open wells where the depth is greater than 30 meters. The reason is that people who probably had been using animals to draw their water will be required to do the pumping themselves.
- If the well is properly developed, most small diameter wells cannot be pumped dry with a hand pump.

C. Planning

Overview

Here is an overview of planning which presents major choices and their determining factors. Use it as a checklist in your planning activities.

- a. How you sink the hole depends on:
 - ground conditions: What ground conditions do you expect? Are you prepared to go through rock? How much rock must be penetrated?
 - sinking methods: What sinking methods can you use in these ground conditions?
 - equipment: What equipment do you have? How accessible is it? Which equipment is suitable for the ground conditions you expect? (See Small Equipment and Drilling Techniques, p. 137.)
- b. How you case the well (reinforce the hole walls) will depend on:
 - material: What material will the casing be made of? What casing material would be suitable for the chemical and bacteriological characteristics of the water to be tapped?
 - ground conditions: If loose, caving formations are encountered, it may be necessary to sink the casing along with the excavation to keep the hole open and thus allow continued sinking. It is not necessary to case a hole that is sunk into solid rock, although if the hole continues on through the rock into another unconsolidated formation, the entire hole should be cased.
 - sinking methods: The casing can be lowered into the hole after the hole is excavated or driven along with the excavation process.

- c. How the intake section is constructed will depend on:
- materials: What kinds of screens can be built locally or are commercially available? What effect will different possible choices of screens have on well production?
 - ground conditions: The aquifer depth and particle size will determine the optimum length and opening size of the intake section.
 - sinking methods: The method used to sink the intake section can determine the type of well screen that will be used.
 - casing: Whether the casing is sunk along with drilling or lowered into the completed hole will determine the type of screen connection to the casing.
- d. How the top section is constructed will depend on: 1) the degree of sanitary protection that is felt necessary and 2) users' preferences for a particular method of water delivery.
- e. The maintenance performed on the well depends on:
- the arrangements made for regular maintenance.
 - the community involvement and interest in the well throughout the construction process.
 - the understanding of the connection between improved water supplies and better health.

D. Work Outline

Here is an outline of the essential construction activities, in working order:

- Community awareness and education activities should be in progress so that actual construction can serve to illustrate ideas that have already been presented.

- Gather and arrange supplies at the well site. Planning the placement and use of supplies around the well can make work more efficient and easier.
- Excavate hole (sink hole, dig or drill hole). The hole is sunk as near to the desired depth as possible. This will often include sinking the hole as far as necessary into the aquifer, as ground conditions permit.
- Case hole (line and reinforce walls). (See p. 145.) In all wells except those sunk through hard rock, a casing must be installed to prevent possible collapse of hole walls. For small diameter wells, the casing is usually pipe.
- Excavate bottom section. If the bottom section cannot be sunk by whatever method was used to excavate the middle section, then another sinking method which is more appropriate to the ground conditions will have to be used.
- Install a well screen. (See p. 122.) A well screen is a filter which enables the development of the surrounding aquifer to allow as much water and as few aquifer particles as possible to enter the well. The well screen can be attached to the casing and installed with it. Or it can be installed separately after the casing is in place.
- Seal top 3 m of casing. Grout around the casing down to at least 3 m below the ground surface, to help prevent surface contamination from entering the well.
- Construct a platform around the hole which, by gently sloping away from the hole (1:40 slope), allows water to run off, preventing accumulation and possible well contamination from surface water seeping in around the pump.
- Install a pump or water lifting device which conforms as much as possible with local water gathering customs and practice.

CHAPTER 11

DRILLING AND CASING TECHNIQUESA. Introduction

Small diameter well sinking techniques include:

- techniques that require large, expensive equipment;
- techniques that need only small equipment.

Large scale techniques are covered here in enough detail to understand their basic operating principles. These methods use large, expensive, complicated machinery whose detailed operation can be adequately understood only with the benefits of hands-on training. However, the basic drilling techniques used with these larger rigs are, in many cases, the same as those which can be used with smaller equipment and may serve to better illustrate the possible variations of each technique.

Small scale techniques are covered later in enough detail to enable interested persons to perform them.

B. Drilling Techniques with Large Scale Equipment1. Types of Rigs

These techniques all use a specially made unit known as a "rig" which includes all of the different power systems needed to operate one or a variety of types of drilling tools. The cost of these rigs ranges from about \$20,000 to \$500,000 and up. Depending on the type of rig and the drilling method, holes can be sunk with diameters ranging from 4 cm to 1.4 m. (See Fig. 11-1.)

There are two basic types of large drilling rigs, percussion rigs which give an up-and-down motion to the tools and rotary rigs which turn the drilling tools.

By far the most common type of percussion rig is the cable tool. Drilling tools are suspended on a cable which is alternately pulled and released to create the up-and-down motion of the tools. When drill cuttings have accumulated to the point that they impede the action of the bit, it is removed from the hole and a bailer is lowered, usually on a second cable, to pick up the cuttings. This is one of the two most common methods of well drilling and is known as cable tool percussion. Cable tool

FIG. 11-1. CABLE TOOL PERCUSSION DRILLING RIG

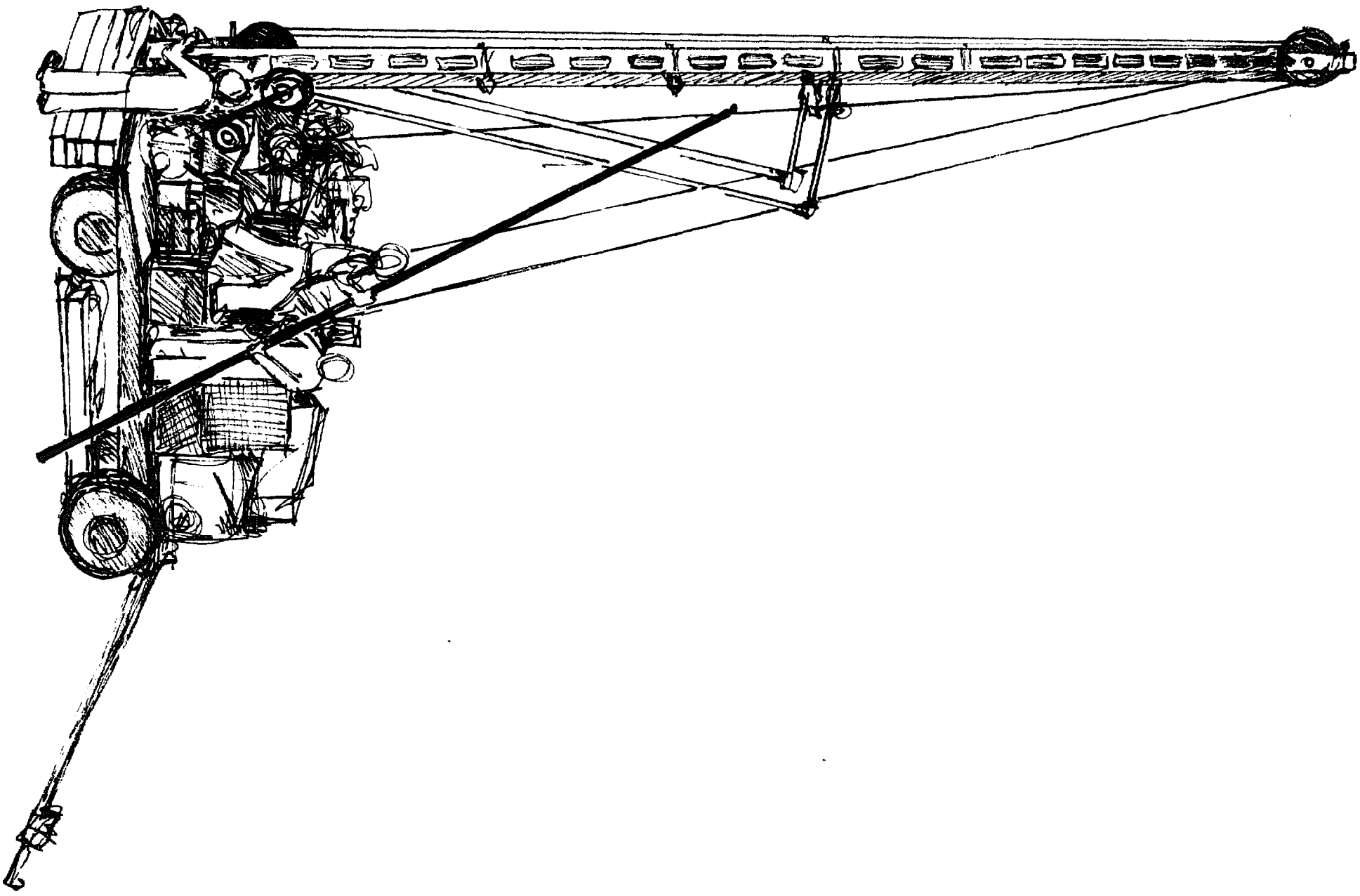

rigs are also adaptable to other forms of percussion drilling such as hydraulic percussion and jet percussion. These other percussion techniques are not, however, commonly practiced.

Unlike percussion, there are several different relatively common types of rotary rigs. The biggest of these, and perhaps the most complicated of all well drilling machinery, is the rig capable of hydraulic rotary drilling and its variants. This and the cable tool are the two most commonly used water well drilling rigs.

Other types of rotary rigs are those that use augers and core drills. Auger rigs are designed to drill relatively large diameter holes to a relatively shallow depth in non-caving formations. Core drills are designed to drill very small diameter holes to great depths and recover samples of all the materials drilled through. Both of these kinds of rotary drills have been used to drill water wells, although both have limitations for such use.

NOTE: When considering using this equipment, carefully check the manufacturer's size specifications. There has been much confusion and delay resulting from the fact that tools and equipment are commonly manufactured in both English and Metric sizes, which are not generally compatible. To compound the problem there are many different kinds of thread patterns in use which can be cut on either English or Metric pipe sizes.

2. Drilling Variations

There are a number of possible drilling variations given the two basic methods, percussion and rotary, depending on whether or not a fluid is used and which way it is circulated.

- percussion only - cable tool percussion. (See Fig. 11-2a.)
This is commonly used to sink wells through all kinds of formations.
- percussion and regular fluid circulation - jet percussion. (See Fig. 11-2b.)
This method is no longer frequently used but where wells are jetted from the surface it is usually a form of jet percussion.

- percussion and reverse fluid circulation - hydraulic percussion. (See Fig. 11-2c.)
This method is not commonly used with large machines, although the small scale version, known as the sludger technique, has been extensively used in some areas.
- rotary only - auger. (See Fig. 11-2d.)
Augering or boring is commonly used to drill relatively shallow holes for wells and many other uses.
- rotary and regular fluid circulation - hydraulic rotary. (See Fig. 11-2e.)
This method is commonly used to drill wells through all kinds of formations.
- rotary and reverse fluid circulation - reverse circulation. (See Fig. 11-2f.)
Reverse circulation drilling has the same uses as hydraulic rotary and is sometimes preferred.
- rotary and air as drilling fluid - air rotary or down-the-hole hammer.
This is a relatively new technique which uses compressed air as the drilling fluid and is most suitable for drilling through rock.

The following two techniques are not really primary drilling techniques since they are not often used with large drilling equipment to sink wells from the ground surface. They are, however, frequently used in well drilling operations to sink the well screen and casing into place in the aquifer after a hole has been drilled down to the water table by any of the above techniques. For more information, see Chapter 14.

- regular fluid circulation only - jetting or washing. (See Fig. 11-2g.)
The fluid itself loosens the soil at the bottom of the hole and also carries the loosened soil to the surface.
- no fluid circulation - driven. (See Fig. 11-2h.)
With this technique the casing and well screen are simply pounded into the ground.

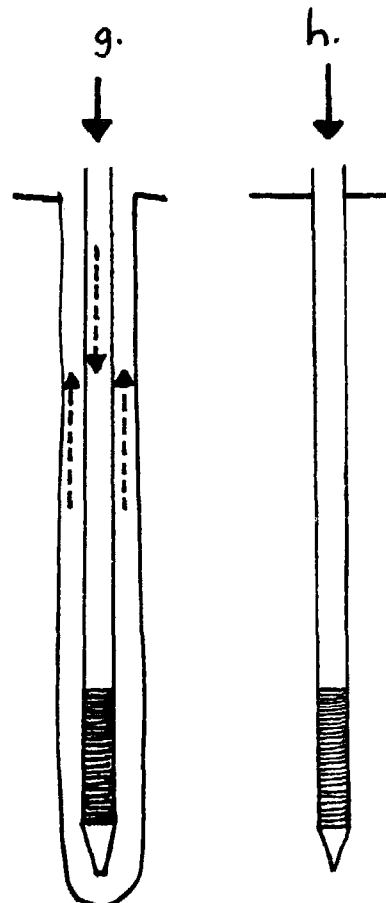
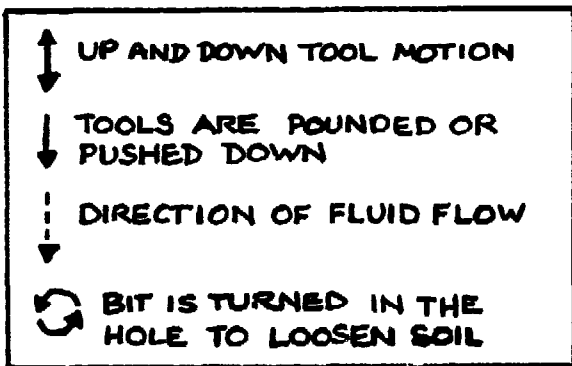
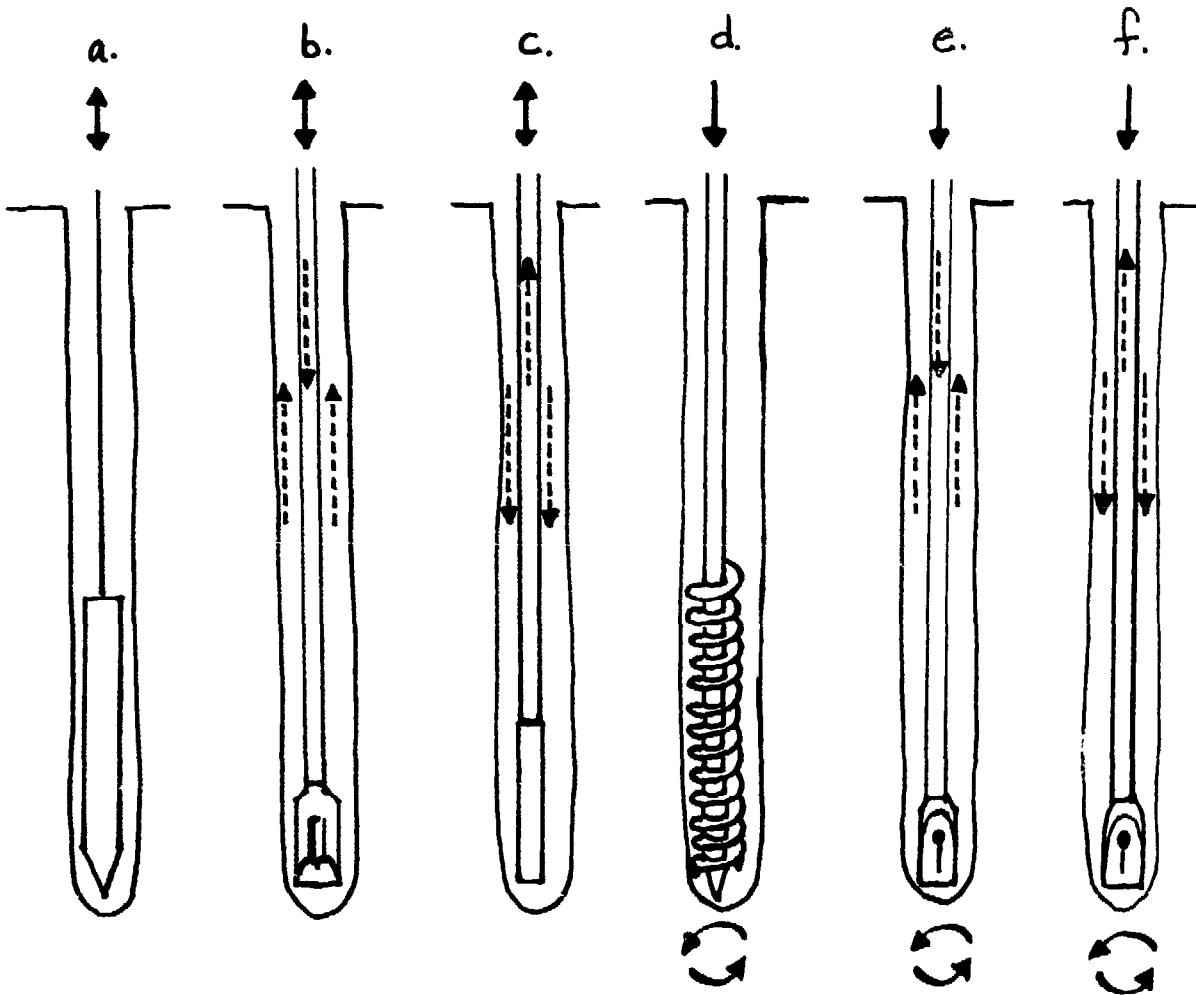

FIG. 11-2.
 DRILLING METHODS.
 THE CHOICE OF DRILLING
 METHOD DEPENDS MAINLY
 ON WHAT MATERIALS
 ARE AVAILABLE.

3. Drilling Depth

Assuming that the rig and tools are appropriate for the particular ground formation being penetrated, the depth that can be drilled is limited only by the ability of the rig to lift the tools from the hole.

For example, one particular manufacturer provides the following suggested depth capabilities for their top-of-the-line hydraulic rotary drilling rig fitted out with various drilling tools.

drilling method	hole diameter	depth
auger	900 mm	12 m
continuous flight auger	300 mm	15 m
reverse circulation	600 mm	150 m
air rotary	170 mm	450 m

The same company's core drilling rig is capable of drilling a 48 mm diameter hole to 1400 meters.

C. Overview of Small-Scale Techniques

1. Introduction

The small-scale techniques given here have been adapted for use with a minimum amount of equipment and expense. These techniques may require only hand tools, pipe, and a great deal of labor, or they may require a tripod, a motor pump, drilling pipe, and drill bit plus whatever material will be permanently installed in the well. Wells workers may select from a variety of equipment varying in cost and technical difficulty, all of which are less expensive and less complicated than a drilling rig.

These sinking methods may be used in largely consolidated ground formations (see Glossary). The suitability of the different methods varies with the degree of caving expected and whether rock will be encountered.

It is common practice to use more than one method to sink the complete hole. With adequate finances and equipment, it is helpful to use the particular technique most suited to the (1) ground conditions, (2) expected depth of water, and (3) the section of well being worked on.

Each individual small equipment sinking technique is generally limited to use in a certain type of soil. Where the soil layers to be penetrated are similar, using one appropriate sinking technique will be most efficient. However, it is much more likely that you will encounter several different soils, requiring the use of variations on a single sinking technique, or even different techniques. When evaluating the various sinking techniques, choose the one most appropriate to a particular situation. You may also want to consider what other equipment might be needed in different ground conditions.

In many cases, ground conditions will vary between the middle and bottom sections of the well. The same type of soil may surround the complete well, but where that soil is saturated with water (bottom section), its drilling characteristics will usually be different. For example, a sand or combination of sand and gravel aquifer will usually be subject to caving, making it impossible to excavate a hole down into the aquifer without sinking a casing with the drilling tools. Sand that is only damp, on the other hand, will tend to stick together and not cave in.

However, if rock is struck, the well must be moved to a different site where rock might not be encountered, or the workers must switch to drilling tools appropriate for rock. Hand-powered tools commonly used in unconsolidated formations generally gouge and slice through soil to loosen it. This is not suitable for rock, which must be smashed and chipped or broken into smaller pieces in order to be removed from the hole.

2. Sinking Methods and Ground Conditions

There are then three basic types of ground conditions that can be encountered while drilling.

Ground Condition	Suitable Sinking Technique
Rock	percussion
Loose, non-caving	rotary, percussion or sludger
Loose, caving	driven, jetted

Where all three ground conditions are likely to be encountered you should be equipped with the types of tools appropriate to each.

3. Level of Complexity and Common Uses of Small Scale Techniques

- a. techniques that require the least equipment and expertise
- driven - Variations of this technique are used in almost all methods. By itself it can only reach a limited depth in relatively loose soil.
 - sludger - This is a specific adaptation of a percussion technique which uses a drilling fluid but does not require a pump during drilling. The technique is quick and there are good possibilities where the ground permits.
- b. techniques that require a minimum of manufactured equipment but require that materials and semi-skilled labor be available to produce the necessary equipment.
- hand percussion - This excavation technique works in the widest range of soil conditions. However, it is slow and requires considerable hard labor. Although it is simple, there are many possible minor variations which could affect drilling but which require some experience to use effectively.
 - hand auger - This is one of the simplest and most easily understood methods for simple field work. It is limited to non-caving formation without rocks bigger than the auger. It is also slow and can only reach a limited depth.
- c. techniques that require at least local manufacture of the necessary equipment and pumps.
- jetted - This technique will only work in the same places that the sludger method will and it requires more equipment and expertise. It will, however, usually be faster and require less work than sludger.

D. Small Equipment and Drilling Techniques

Here is basic information on small equipment drilling techniques, which provides the following information on each method:

- materials required;
- quick description of method;
- suitability of ground conditions;
- cost;
- work;
- depth.

1. Rotary hand auger

- Materials required - auger, drill stems to connect the auger bit with the handle, and a handle.
- The particular operation will depend on the exact bit being used. Most often the bit is turned in the hole until it is full of drill cuttings. It is then brought to the surface, emptied, and returned to the hole. This process is continued until the desired depth is reached or ground conditions change causing this method to be unusable. (See Fig. 11-3.)

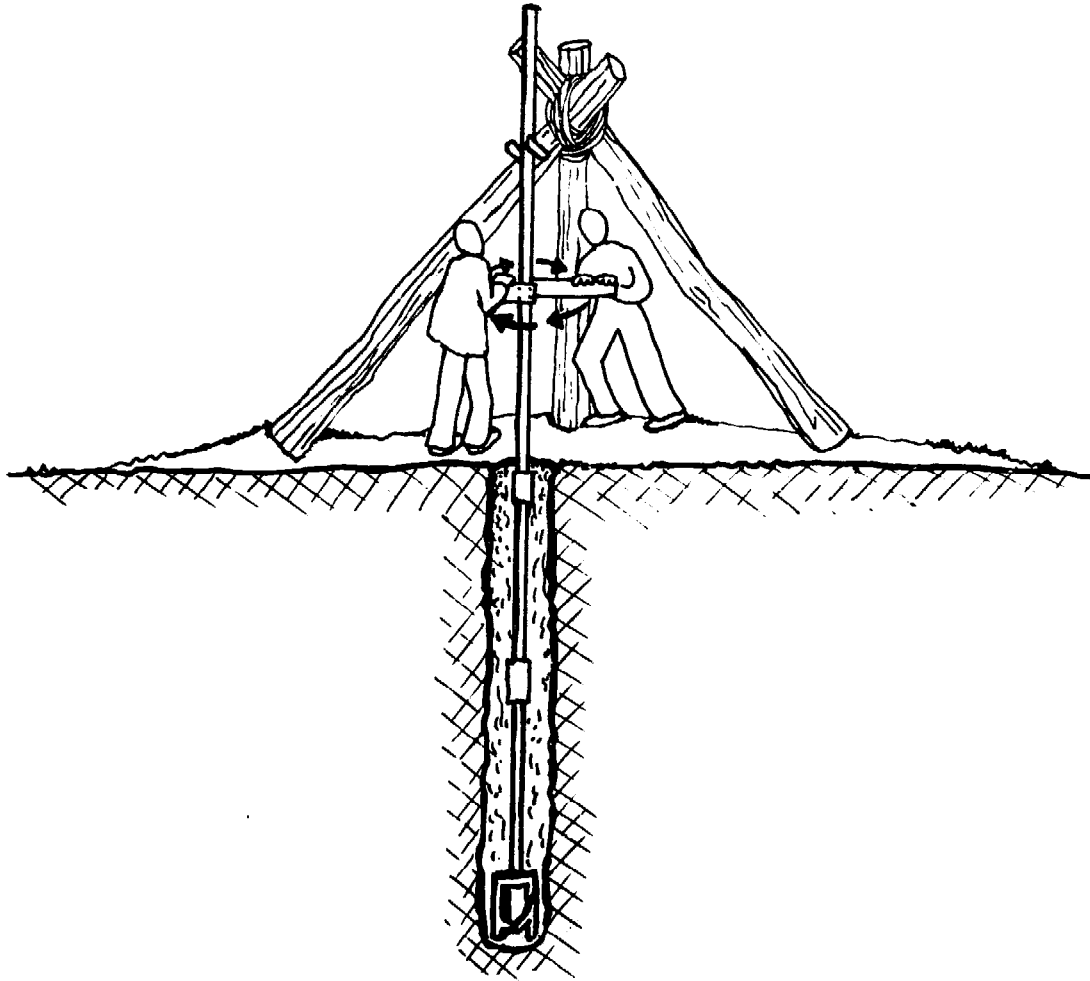

FIG. 11-3. HAND AUGERING

- Suitability to ground conditions - This method can be used in clay, silt, and sand formations not subject to caving. In caving formations a casing slightly larger than the bit can be driven down as the hole is sunk. Where rock is reached this sinking method will have to be discontinued.
- Cost - The U.S. cost of a 10 cm diameter auger, drill stem, and handle in the spring of 1978 was \$16.50.
- Work - Unskilled workers can easily be taught to use this method to sink and finish wells up to 20 m deep in five days.
- Depth - 20 m is the usual maximum depth.

- Depth - Great depths are possible in optimum ground conditions but as the hole gets deeper more and more time will be spent switching back and forth between the bit and the bailer because of the greater distance they must be raised and lowered.

This method is best suited for drilling through soft rock and well packed, non-caving soils. It can be used in hard rock although progress will be slow and drilling bits will need to be sharpened frequently. It can also be used in caving soils if the casing is driven in as the hole is sunk.

3. Hand percussion and fluid (sludger)

- Materials required - You will need metal pipe and couplings, a cutting bit which can be made from a coupling, pipe wrenches, and a tripod or lever structure with which to lift and drop the metal pipe.



FIG. 11-5. BAILER

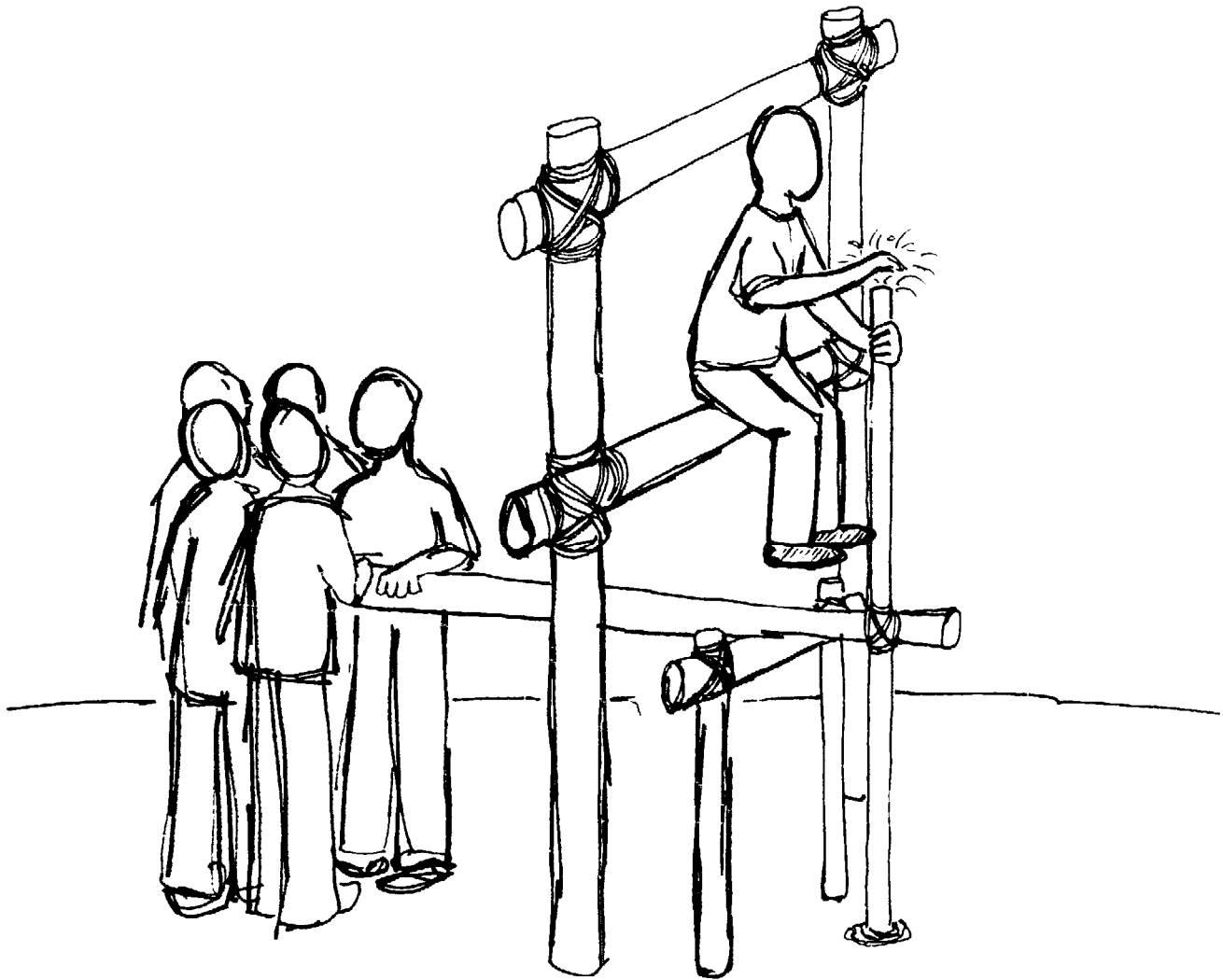

FIG. 11-6. SLUDGER TECHNIQUE

- The pipe string equipped with a one-way valve is lifted and dropped into the hole which is full of drilling fluid (usually water). The one-way valve permits fluid and cuttings to flow up through the pipe but not down. The up-and-down action of the pipe, acting with the valve, allows the tool string to act as a pump removing fluid and cuttings from the well. The fluid can be recirculated if cuttings are allowed to settle out. (See Fig. 11-6.)

- Suitability to ground conditions - This method can be used in fine or sandy soils as long as rocks are no larger than medium-sized gravel.
- Cost - Obviously the cost will vary from place to place, but to give an example, wells using this technique drilled with 1.5" G.I. and finished with plastic casing cost 12¢ to 16¢ per ft. in Nepal in 1976.
- Work - Six relatively unskilled men can build a 4 cm diameter 60 m deep well in four days.
- Depth - Maximum 80 m.

4. Driven

- Materials required include a drive point, a casing pipe, a drive cap to protect casing pipe when driven, and a heavy weight to strike the cap.
- Driven wells are sunk by pounding a special type of well screen called a drive point (well point) into the ground. The drive point is attached to the casing pipe and more casing pipe is added as necessary as the whole string of casing pipe and drive point is driven down. (See Fig. 11-7.)
- Suitability to ground conditions - This method is generally used and easiest to drive in loose, caving formations. It will not go through rock and sinks through clay only with difficulty.

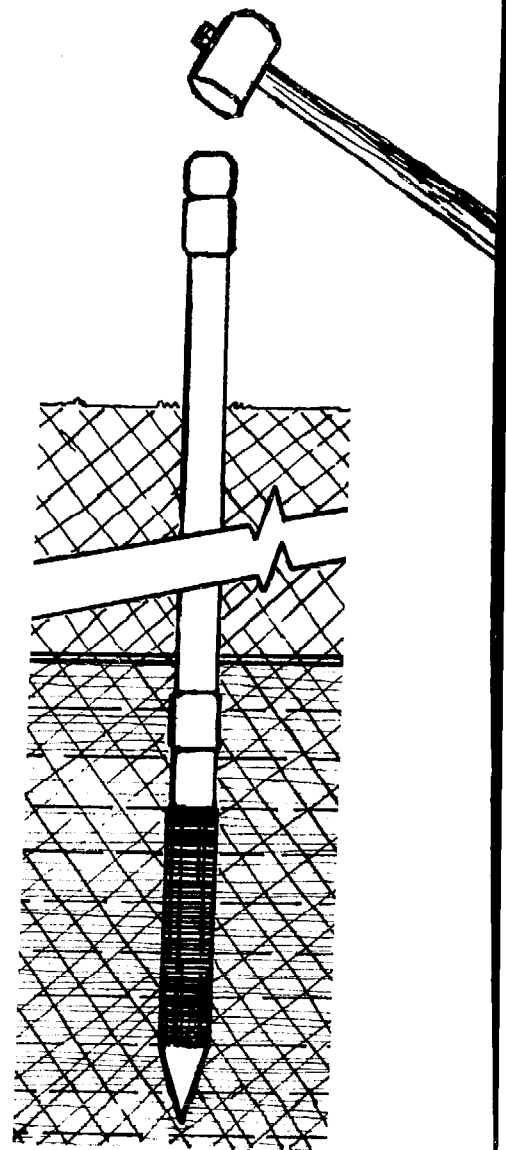

FIG. 11-7.
DRIVEN WELL

- Cost - As of August 1976, a 91 cm long, 5 cm diameter, stainless steel, continuous slot drive point cost \$80.14 and a 305 cm length of 5 cm diameter seamless, ungalvanized (black), steel casing pipe cost \$43.65 in the U.S. These are manufacturers' prices and are given here merely as examples. Acceptable substitutes for both of these can usually be locally manufactured.
- Work - The majority of the work involved in sinking a well with this method is lifting and dropping a heavy weight to drive the pipe into the ground.
- Depth - Wells can usually not be driven more than 10 m by hand or 20 m by machine because of the friction between the casing pipe and the soil.

5. Jetted

- Materials required include a pump, hoses, a watertight connection of the hose to the top of the drilling string, a hollow drill pipe, a hoist, and a jetting bit.
- Jetted wells are sunk by pumping drilling fluid (usually water) down through the drill pipe and out a special jetting bit. This works on the same principle as a flowing garden hose that can be pushed into the ground. The washing action of a stream of water alone can be used to sink small diameter pipe and well screens in sandy formations. (See Fig. 11-8.)

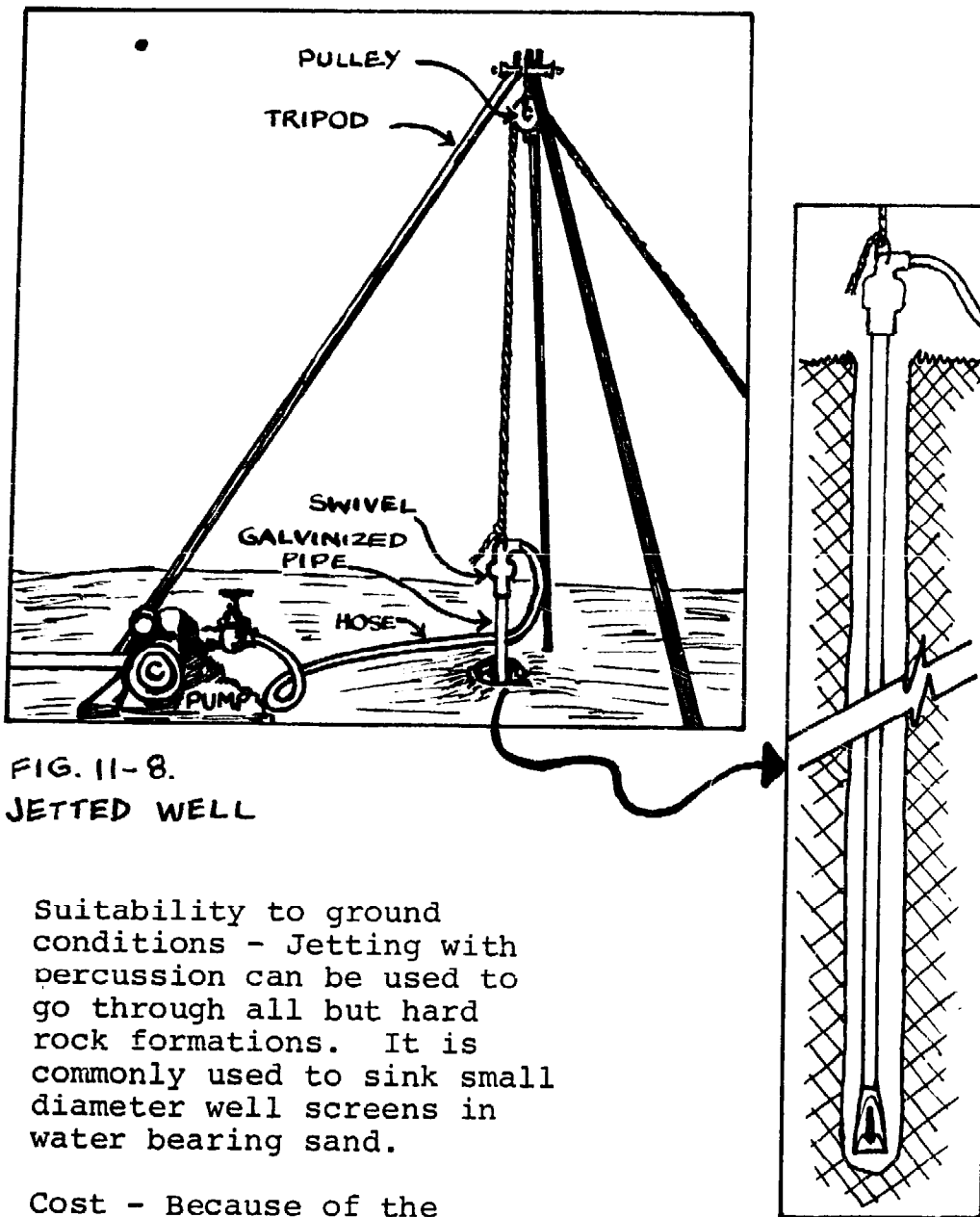

FIG. 11-8.
JETTED WELL

- Suitability to ground conditions - Jetting with percussion can be used to go through all but hard rock formations. It is commonly used to sink small diameter well screens in water bearing sand.
- Cost - Because of the equipment necessary, this sinking method is more expensive than the other techniques covered here. Its actual cost is difficult to estimate because of the wide range of equipment possibilities that can be used. A simple hand-operated diaphragm pump can be used to sink one long pre-assembled length of casing into place at a cost comparable to other methods discussed.
- Depth - Jet percussion builds wells 8 to 10 cm in diameter up to 60 m. With simple equipment, a well can be jetted to a depth of about 20 m.
- Work - This method requires some technical skill, experience, and judgment, although all of these are straightforward and easily understood by people with modest technical backgrounds.

E. Casing Installation

1. Overview of Casing Techniques

How the casing is installed in the well depends on such factors as casing materials, and ground conditions.

Before the casing is set into place it is very important that you also consider how the well screen will be attached to it. (See p. 192.) If the casing above is set in place the well screen must later be telescoped into place. Special tools and materials are then required to seal the well screen to the casing.

The same three methods of installing the casing are possible whether or not the well screen is attached.

- Lowering the casing into the hole - Where the drilled hole will remain open without caving for a long enough period of time, the casing can simply be lowered into the completed hole. Normally, the casing is lowered as far as possible into the hole, after which it can be sunk further by one of the following methods.
- Driving the casing - This method can only be used where heavy metal pipe, which will not deform as it is driven, is used as the casing. It can be used in all but very hard formations although it is most often used in loose caving formations. (See p. 163.)

The casing can be driven into place either after the hole has been sunk as far as possible or as the drilling proceeds. The latter is used primarily with percussion techniques where a bailer can be worked inside the casing to remove loose, caving types of soil as the casing is driven in to reinforce and maintain the hole. In this instance special drive clamps must be attached around the casing pipe so that it can be driven while the bailer is inside it.

When the casing will be driven into place before the well screen is attached, a sharpened coupling can be screwed on to the bottom of the casing to facilitate sinking. (See Fig. 11-9.)

FIG. 11-9.
SHARPENED
COUPLING

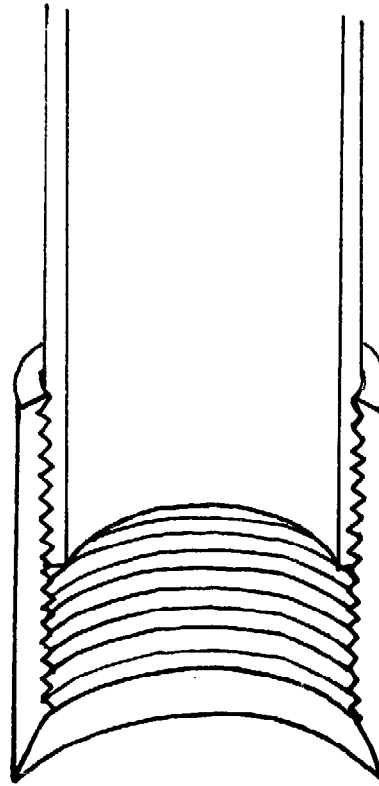

- Washing the casing into place - This method uses the process of pumping a fluid down through the pipe to remove loosened soil particles from the hole and allow the casing to sink. The only difference between this and the jetting process described on page 176 is that a special jetting bit which directs a high velocity fluid stream at the bottom of the hole is not used. Because this method requires that the pipe joints be watertight, it generally is used only with manufactured pipe. It also requires the use of a pump, to force water down through the casing, and a watertight connection at the top of the casing through which the water can be pumped. (See p. 239.)

2. Sealing the Casing

Once the casing is set in its final position in the well any space around the casing should be filled in. The top three meters of this space should be filled with mortar or concrete to seal the casing to the ground formation and thus prevent possible contaminants from easily flowing down along the outside of the casing pipe.

Chapter 12

CONSTRUCTION: HAND ROTARY AND HAND PERCUSSION METHODS

A. The Hand Rotary Method

1. Overview of Method

This method of well sinking has been commonly referred to as boring. Sometimes percussion techniques are included under the general title of bored wells. Because of the limited soil conditions in which simple rotary methods are effective, it is often useful to have percussion tools available. However, for clear explanation, simple rotary and percussion techniques are discussed separately here.

Where sophisticated drilling methods are available for well sinking, hand augering is used only for taking soil samples at relatively shallow depths. It is cheap and provides very accurate soil samples, but requires time and effort and is limited to unconsolidated non-caving formations.

An auger, which functions as a drill bit, is attached to the bottom of a length of drilling rod and turned with the handle, which is attached to the top of the drilling rod. (Fig. 12-1.)

The auger serves first to loosen soil at the bottom of the hole and second to remove it. As the auger is turned, the loosened soil accumulates in or on the auger.

When the auger is full, it is lifted to the surface and emptied and then returned to the hole to continue sinking. Lengths of drilling rod are added to the tool string as the hole is deepened. It has been estimated that 70 to 80% of the time required for this sinking method is taken up by raising and lowering the tool string.

2. Advantages and Disadvantages

There are several advantages to this method.

- The equipment is simple, light, portable and easy to make from available materials.

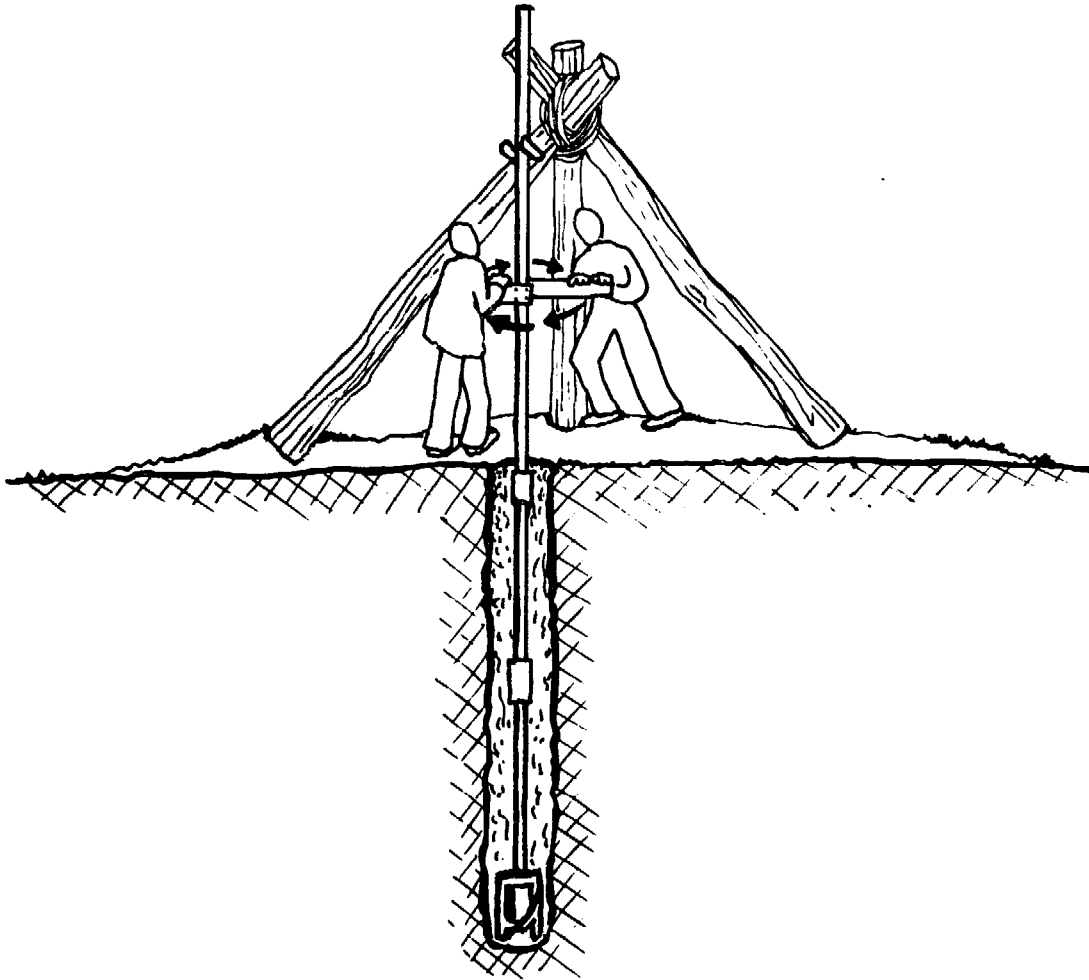

FIG. 12-1. HAND AUGERING

- It provides excellent samples of soil layers penetrated for future reference.
- The technique is simple and easily taught.
- It is easily combined with simple percussion techniques to make the combination method suitable even where some rock exists.

It has, however, certain disadvantages.

- It is limited to unconsolidated, non-caving ground formations.
- Well depth is limited to 15 or 20 meters maximum because of the physical difficulty of operating a tool string any longer than that.

3. Equipment

Excavating equipment includes:

- auger - An auger works at the bottom end of a tool string to excavate soil. There are two general types of augers each of which has variations which are suitable for use in different ground conditions:
 - a. cylindrical bucket type - different variations used for hand or power drive. (See Fig.12-2.)
 - b. open blade type - used mainly with power equipment (continuous spiral) although some are available with hand drive. (See Fig. 12-3.)

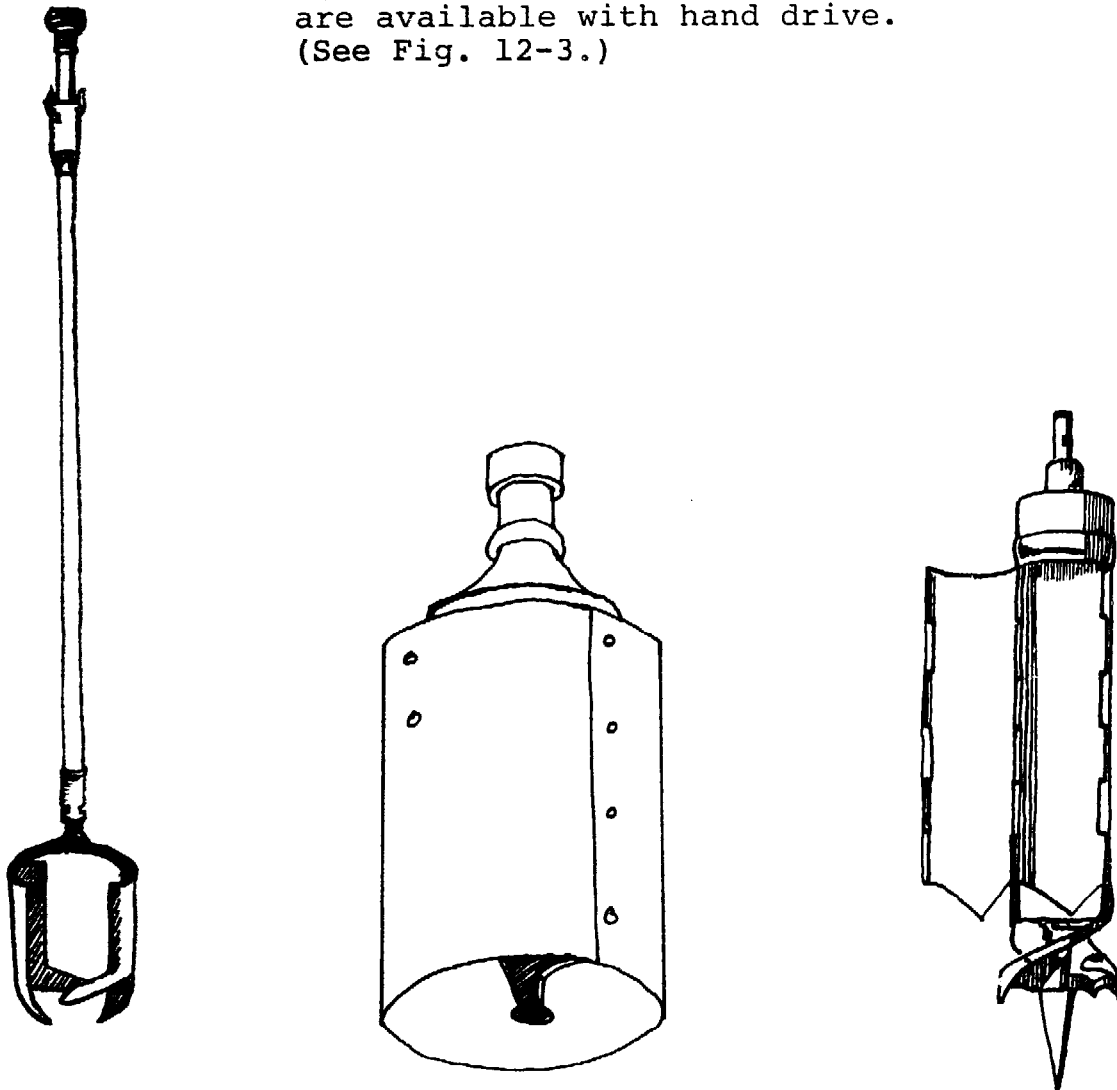

FIG.12-2. BUCKET AUGERS

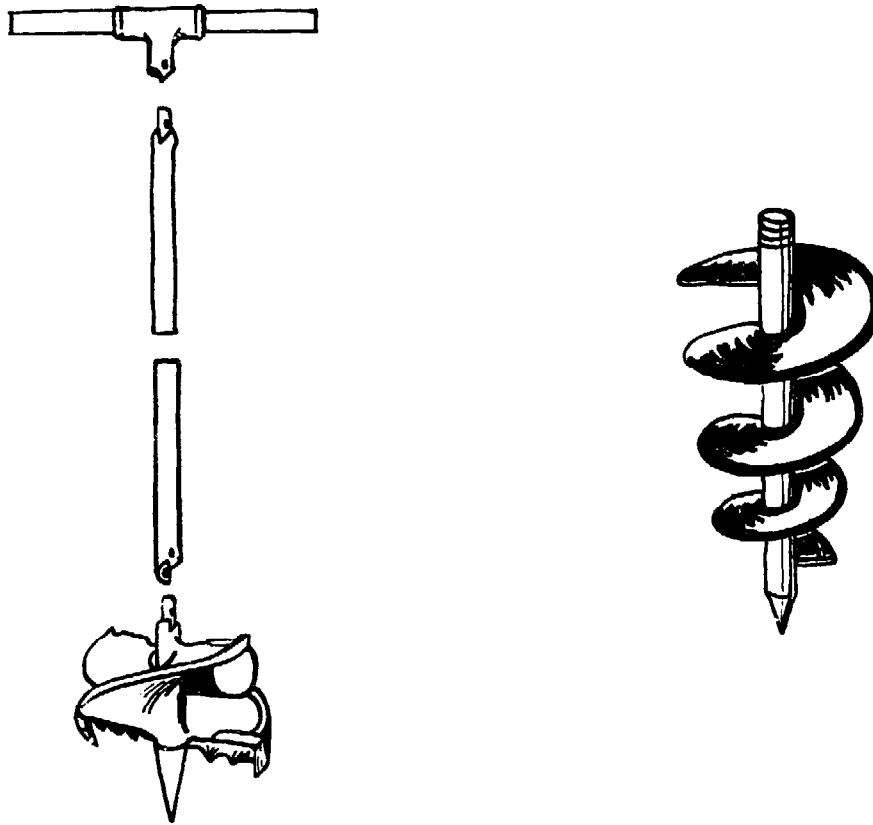

FIG.12-3. OPEN BLADE AUGERS

- drill shaft (drill stems, drill rod) - The drill shaft is made up of 1 to 5 meter sections which are connected together between the auger and the handle. It is most often fairly small diameter hollow metal pipe. This size and shape help to reduce the weight of the tool string as well as provide the appropriate motion and strength necessary to transmit the drilling motion from the handle to the bit. Because so much time is spent removing and lowering the bit, the shaft connections should be quick, easy, and sure. It is necessary that all of the equipment use the same type of drill shaft connection.

The following are examples of types of connections that have been used.

- Threaded pipe and coupling is probably the most frequently used connection because it is so readily available.

- Another connection involves slipping the two connecting ends of the drill shaft into a slightly larger piece of pipe and bolting them in place. Only one bolt needs to be removed to disconnect the two shaft sections. That can usually be easily done because it has been found that the bolts need only be finger tight. An alternative to using a regular nut and bolt could be to use a toggle type bolt.

- Rock hammer - This is a percussion tool which can be dropped or thrown down the hole to chip or break rocks which are too large to be removed by the auger.
- Sand bailer - This can be used to remove sand from loose caving formations.
- Casing - Some type of casing must be installed in the well to reinforce the walls. In caving formations, a sand bailer can be operated inside the casing to sink the hold and the casing. The inside diameter of the casing will need to be slightly larger than the outside diameter of the sand bailer.
- Tripod - This can hold a pulley to aid in lifting the tool string and also support the upper end of the drill stems when drilling through harder layers, such as laterite (see Glossary). The support is to hold drill stems plumb while drilling with extra weight on the stems to enable penetration of the hard formations.
- Fishing tool - This is used for retrieving tools and equipment that have come disconnected from working pipe string or have dropped into the hole. (See Fig. 12-4.)

FIG. 12-4.

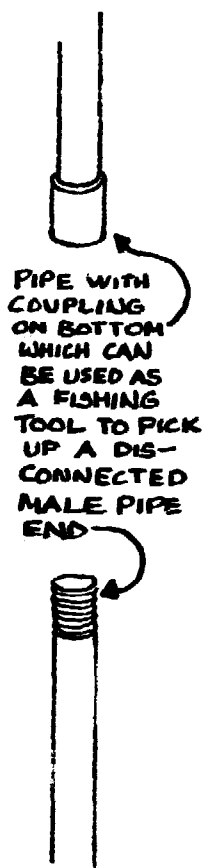

NOTE: A magnet can be a fishing tool for small items dropped into the hole.

- Plumb bob and level - These may be used to check whether a hole is perfectly straight and vertical.
- Handle - The handle attaches to the drill shaft enabling the auger to be turned by people at the ground surface. It can either be attached to the top end of drill stems to form a T or be a cross piece that clamps to the drill stem wherever it is needed.

4. The Sinking Process

- Arrange and set up all tools, equipment and supplies; clear the area immediately around well site of all unnecessary tools. Set up and locate a tripod or headframe if it is necessary to provide support for the upper end of the drill stem. Locate it directly over the hole so that the drill stem will be plumb.
- Assemble the auger, drill stems and handle.
- Begin boring by forcing the auger blades down into the soil while turning the tool. Digging a 30 to 50 cm deep hole of sufficient diameter to allow introduction of the auger usually helps to get the drilling started.
- Turn the bit until it is full of loosened soil. It is only necessary to turn the bit just enough to fill it. The number of turns required to fill the bit is determined by the soil hardness, and may be only two or three turns. Be careful with some augers not to screw them too tightly into the ground. In hard formations, it may be necessary to push down as well as turn the tool. (See Fig. 12-5.)

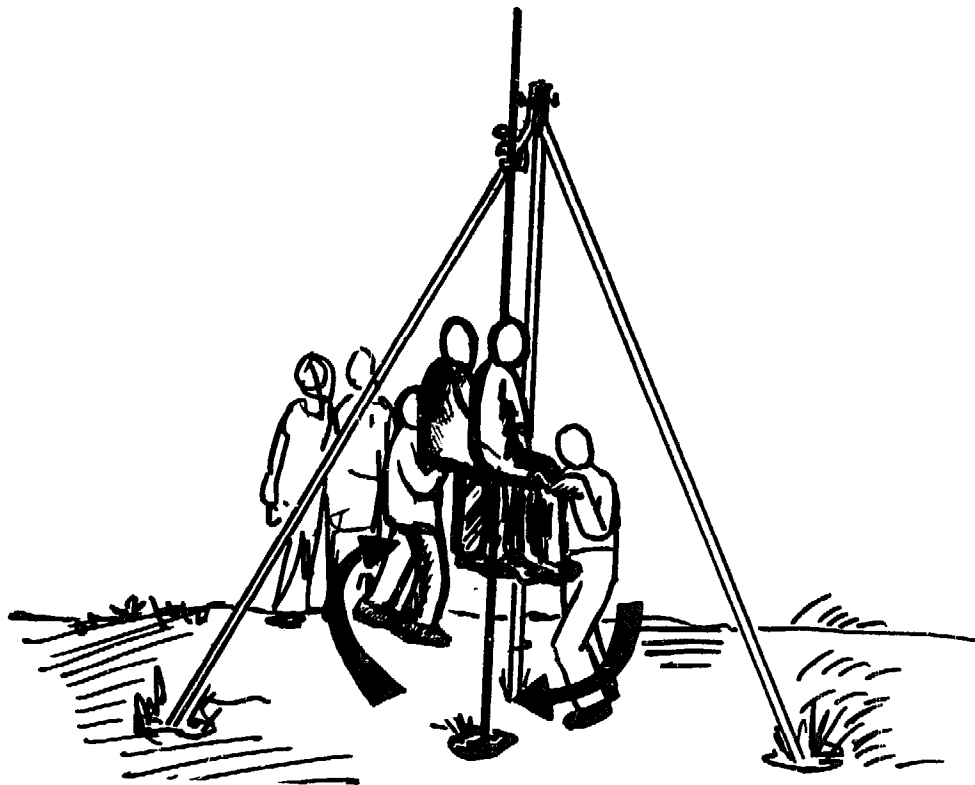

FIG. 12-5. ADDED WEIGHT NECESSARY TO PENETRATE HARD GROUND

- Remove loosened soil from the hole. Lift the auger from the hole and empty the soil accumulated on or in it. By systematically depositing the components of the auger in short ridges, each containing the soil from 1/2 or 1 meter of well depth, you can keep a record of the soil layers penetrated. Keep the samples far enough away from the well so as not to hinder the well sinking operations.
- Return the auger into the hole and continue sinking.
- Continue turning the auger, removing the auger from hole when full, emptying and returning the auger to the hole to be turned more. As the hole is sunk deeper and deeper, more and more drill stem sections will need to be added.
- Continue sinking the hole by the same process until a) you have reached a sufficient depth into the water table or b) you can no longer sink the hole any deeper by this process. If (a) is the case, see Chapter 15, p. 191. If (b) is the case, you were probably stopped for one of the following reasons: the auger encountered rock, the hole continues to cave in permitting you to go no deeper, or the tool string is not long enough to go further.

- If the auger encounters rock you still have several options. Try to remove the entire rock from the hole with a ram's horn (spiral auger). (See Fig. 12-6.) This will work only if the rock is smaller than the hole.

- Although a spiral auger is a piece of equipment listed in the literature for removing rocks from augered holes, field experience has found that percussion techniques work better. (See Hand Percussion, p. 155.)

A percussion rock bit

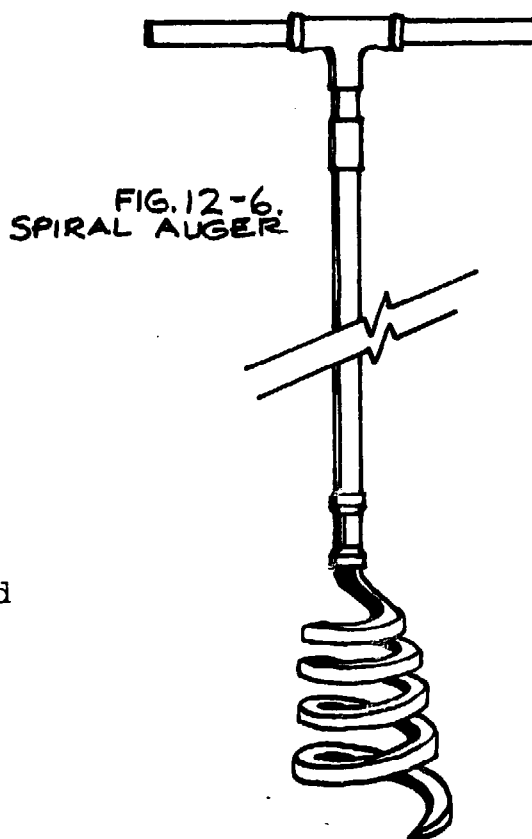

would be attached to a rope and dropped in the hole or attached to the end of the drill shafts just as the auger is. Abandon the hole and try some other place if you have no equipment to penetrate a rock layer or if it is too thick or hard to be penetrated by whatever tools you have.

If the hole continues to cave in permitting you to go no deeper, you have two options. If you have hit water at the same time, see "Bottom Section." If the hole is still dry, however, you must evaluate your situation to decide whether you want to continue sinking this hole. The hole will usually be caving because the earth is loose sand. To go deeper you will need to sink a casing to hold the walls in place. Determine how much deeper you can go and whether it is worthwhile.

If the tool string is not long enough to go further, abandon this hole and try another location.

5. Time Saving Suggestions

- Disconnect as few of the drill shaft connections as possible. Simply remove and replace shaft sections in lengths as long as you can comfortably handle.
- Leave disconnected shaft lengths standing upright right next to the well. A scaffold could be built against which long shaft sections could be leaned while waiting to be reconnected and go back into the hole.
- Use an auger with a long central cavity in which to accumulate drill cuttings.
- Leave an opening in the auger which will enable the cuttings to be quickly and easily poked out.

B. The Hand Percussion Method

1. Introduction

This method has usually been classified as a variation or useful addition to hand augering. It makes use of the same methods that are used on a larger scale in cable-tool percussion drilling with large rigs.

The basis of this method is the up and down motion used to sink a hole. The tool string is lifted by an appropriate means and dropped, causing the bit at the bottom of the string to come into sudden, forceful contact with the bottom of the hole. The heavier the tool string, the harder it will strike the bottom of the hole.

It is usually useful to have several different bits suitable for varying ground formations. All of these bits are operated by dropping them onto the bottom of the hole. It will often be useful to turn the bit in the hole, either with a wrench or with a handle, that can be attached similar to an auger handle to make drilling easier and help ensure a round hole.

Cuttings can be removed from the hole in several different ways depending on the particular bit being used. Hard rock cuttings and very loose, caving material is usually removed with a bailer. (See Fig. 12-10.) Non-caving soil can usually be packed into a hollow bit. (See Fig. 12-9.)

2. Advantages and Disadvantages

The hand percussion method is suitable for use in a wide range of ground conditions, and may be effective where an auger is not.

This method can be slow, especially in hard formations.

3. Equipment Overview

- Cutting bits. There are several different kinds of bits that are commonly used depending on the characteristics of the formation being penetrated.
- A cutting bit is needed for hard formations. (See Figs. 12-7 and 12-8.) Heavy bits with sharp hard edges are used to smash and chip rock. The bit action cuts and mixes the drill cuttings with a small amount of water added to hole to form a paste which can be easily removed with the bailer (too much water will slow drilling). While a solid piece of regular steel can be used to make the rock bit, it is a good idea to face or fit the cutting edges of hard steel. This can be done by building up the tip with welding steel and grinding it down to the desired shape. The bit will require less frequent sharpening and will last longer. The bit can be worked either hanging by rope or cable, or connected to drill shafts.

Rope or cable will tend to wear and may break during the drilling process. If this happens, the bit will have to be "fished" from the hold. (p. 163.) Although rope wears faster, it does have one advantage over cable. When rope sud-

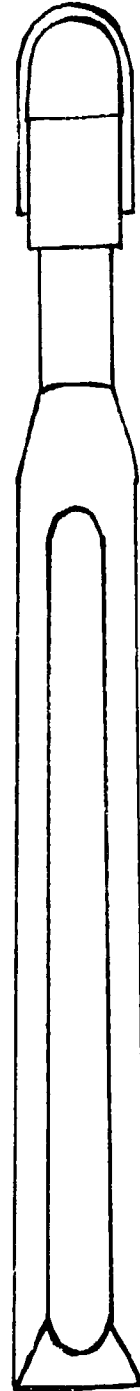
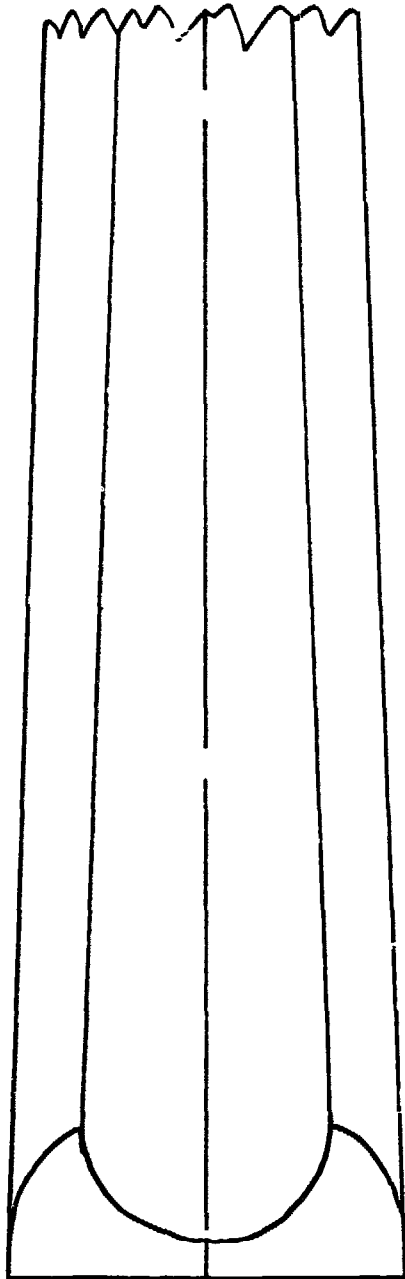
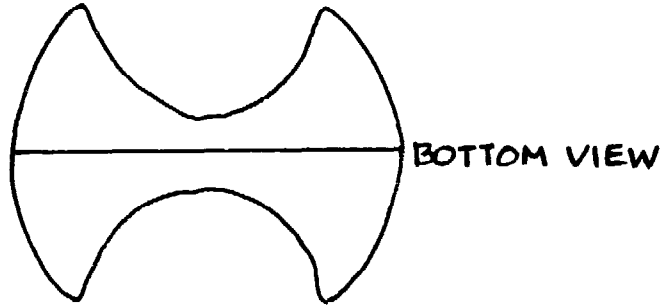

FIG. 12-7.
PERCUSSION
BIT

FIG. 12-8 DETAIL OF PERCUSSION BIT

FRONT VIEW
(See Fig. 12-7)



HARD SURFACE CUTTING EDGE

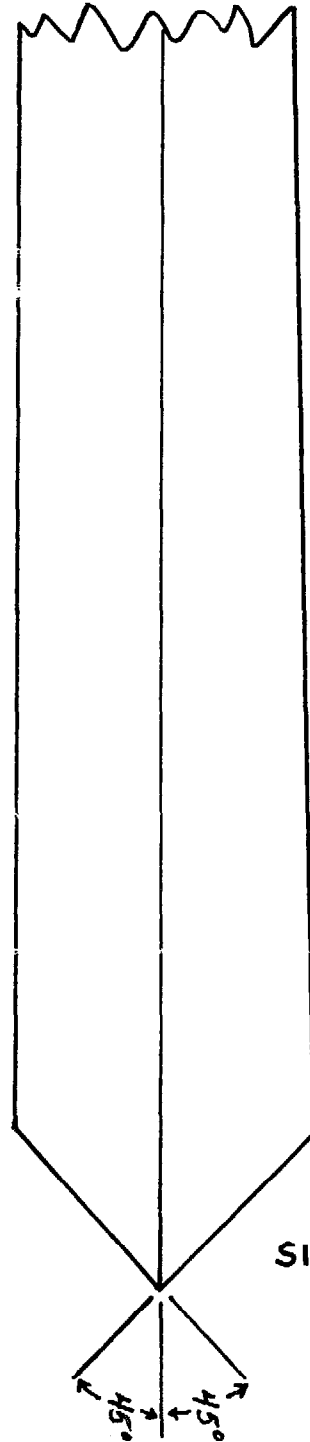

SCALE: 1/2 SIZE

MATERIAL: MILD STEEL

Courtesy of VITA
The Village Technology
Handbook, p. 45.

denly reaches the end of its fall, it gives a quick little turning motion to the bit which helps prevent the bit sticking in the hole. For the very heavy (80 kg) bits which are more effective in harder rock, rope or cable seems far more suitable than drill shafts. With an 80 kg bit, five to seven people are needed and they require frequent rests (every 50 to 100 strokes). The best action with a rock bit can be achieved with short (50 cm) rapid strokes.

- A hollow rod bit can be easily made locally from a piece of heavy metal pipe. (See Fig. 12-9.) Galvanized iron pipe is sufficient. It can be made with either a sharpened straight bottom edge as in the figure or a jagged bottom edge. The straight edge is simply sharpened with a file while the jagged edge can be cut with a hack saw. The opposite end of the bit should be fitted so that it can connect to a

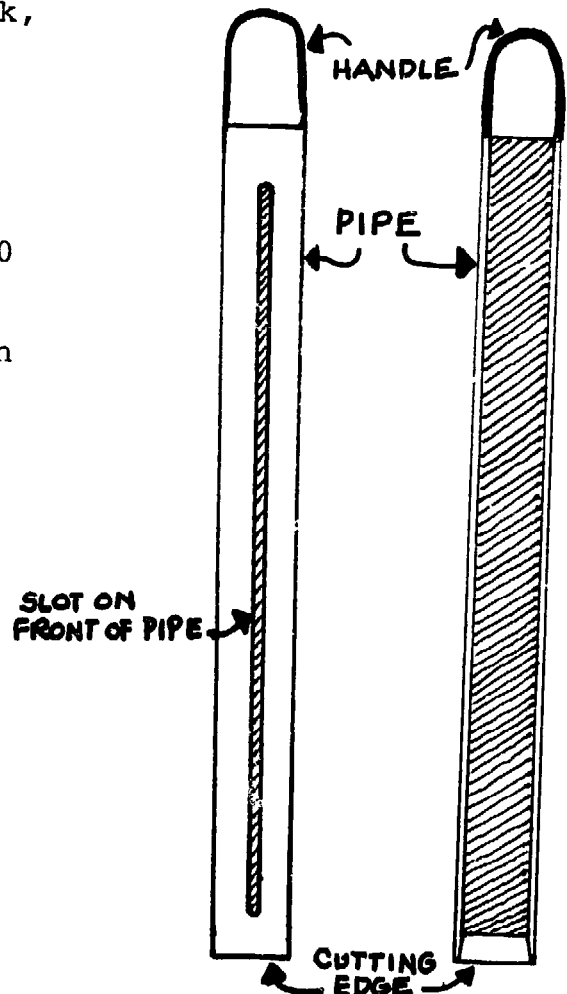

FIG. 12-9. HOLLOW ROD BIT

NOTE: If you reach rock, it is usually advisable to continue drilling for three to five days to get an idea of whether this is an isolated boulder; a thin, easily penetrable rock layer; or a virtually impenetrable thick rock layer. After about 50 cm penetration into rock, it is normally possible to identify a boulder, because a boulder will usually break up.

drill shaft or rope. It will probably be better with this type of bit to attach it to a drill shaft so that the bit can be forcibly turned or pushed down as necessary. It will be very useful to leave or cut a narrow slot almost the entire length of the bit so that drill cuttings that have been packed up into the bit can be removed by prying with a piece of re-rod or something similar.

FIG. 12-10.
BAILER



A bailer is the most commonly used tool in loose soils. It is a long cylindrical tube with a valve in the bottom end which permits material to be forced up into the tube but will not permit it to fall back out (See Fig. 12-10.) Bailers used with hand equipment are most often equipped with flap valves. The bailer is lowered to the bottom of the hole. Lift it 1 to 2 meters and drop it. The impact of the bailer on the bottom of the hole will force some of the loose soil up into the hollow core. Continue lifting and dropping until the bailer is full or until it has picked up as much of the loose material as it can. Experience will show how long to continue lifting and dropping the bailer to get the maximum usage. When the bailer is full, pull it up to the surface and empty it away from the well.

A bailer has several uses in different situations. It removes rock pieces loosened by rock bit; it removes sand in caving formations from inside the casing; it functions to remove loose material that cannot be packed or retain its shape.

- Drill shaft. The shaft lengths connect the bit to the lifting apparatus. Connections between the rods need to be strong, to withstand constant lifting and dropping, and quick because of the frequent necessity to disconnect and reconnect rods when raising and lowering bit to empty it (see details on drill rod).
- Turning handle. This is not necessary, but it can be useful to turn the tool string to facilitate sinking and help ensure a round hole.
- Lifting apparatus. A lifting apparatus can be made from whatever materials are locally available.
- "Fishing" tool. A fishing tool is useful for retrieving tools that have become disconnected in the hole.
- Casing. Casing is necessary for permanent well construction and can be used to reinforce the hole when sinking through caving formations.
- A plumb-bob or level is needed to check the verticality of the hole especially when the hole is started.
- Hand tools. Very few hand tools are absolutely necessary although many will be found useful by those who know how to use them.
- Rope is always useful for a variety of purposes.

FIG. 12-11.

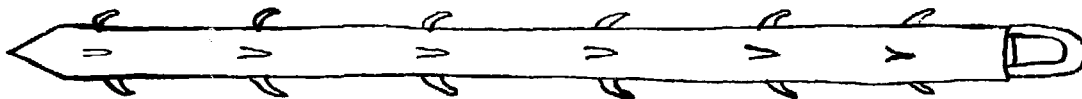

FISHING TOOL - WHICH CAN BE USED TO PICK UP BROKEN ROPE OR CABLE

4. The Sinking Process

- Arrange and set up all tools, equipment and supplies. Clear the area immediately around the well. Locate a tripod or other lifting apparatus directly above hole site. It should be anchored well to prevent the legs moving when a heavy weight is supported by the tripod. The exact hole location can be found by hanging a plumb-bob

from the drill shaft guide or from the lifting point of the tripod or frame. This will help ensure a vertical hole.

- Dig a shallow starting hole before beginning the sinking process with tool string.
- Assemble the tool string and set it in place. It is very useful at this point and also during the sinking process to have a guide for that part of the drill shaft which will extend above ground level. This will help to ensure that the hole is perfectly vertical, especially when starting the hole. However, do not depend on the shaft guide alone to ensure a plumb hole.
- Frequently and carefully check to see that the tool string continues to be plumb, especially when the hole begins to guide the tools. At a depth of about 50 cm, the hole itself will probably have more of a guiding effect than any above-ground tool string guide.
- Begin the sinking process by lifting and dropping the tool string; the lifting and dropping tools may be connected to a rope. The rope comes from the bit or tool string over a pulley and back to a solid post or tree around which it can be wrapped or tied at a convenient height so that workers can easily reach it. Workers can then raise the bit by lining up along the rope and pressing down. From there it is quickly released to allow the bit to fall in the hole. You can also use a rear car wheel as shown in Figs. 5-7 and 5-8.

5. Sinking Variations

There are three variations of this sinking process that can be used depending on the ground conditions encountered.

- In hard, compacted formations, a club type bit has been found most effective. (See Fig.12 7.) When dropped, the bit smashes and chips the hard formation to break away small pieces at a time. As the bit continues to be lifted and dropped, the small drill cuttings will gradually accumulate in the hole until they prevent the bit from coming in contact with the bottom of the hole. The driller should continually watch the progress of the bit so that he can stop the drilling and remove the accumulated cuttings whenever the progress of the bit is slowed significantly. Determining when to stop and remove the cuttings is a matter of judgment and experience. After the bit has been lifted from

the hole, the cuttings are removed by lowering a bailer into the hole and lifting and dropping it until it has accumulated as much of the cuttings as possible. Adding a small amount of water to the hole sometimes aids the bit in pulverizing rock and producing a slurry that can easily be removed by a bailer.

- In loose, non-caving formations, a hollow rod bit can sometimes be used effectively. (See Fig. 12-9.) When this bit is dropped in this type of ground, it does two things: 1) the circular bottom edge of the bit cuts out a plug of material that it has sunk into and 2) this plug forces material already picked up in the hollow inner core of the bit farther up in the bit and packs it in so that it cannot fall out when the bit is lifted again. It is this packing of the loosened, cut-away material into the bit that allows the material to be removed from the hole by lifting the bit to the surface and prying out the packed in material.

Here are some comments and suggestions that may help. It may be necessary to add water to the hole to facilitate sinking because either too much or not enough soil is sticking to the bit. Rotating the bit in the hole is sometimes useful to loosen the bit after it has been dropped and to help maintain a round hole. Leaning the tool string against the rod support or tripod to empty the bit, as opposed to laying it down, saves time and energy. Where the handle is needed to turn the bit, it will be most useful if it can simply be clamped into the tool string wherever desired. This can be long hard work but a system of alternating work and rest periods for teams of workers has proved efficient.

As the bit fills with the loosened soil, it picks up less and less with each stroke until it becomes so packed that it can no longer loosen and pick up any soil. Because different soils pack differently, the bit may be as little as one third full when it must be removed and emptied. With experience, one quickly gains a feel for when the bit needs to be emptied.

- In loose, caving formations like saturated sand, a bailer can be operated inside the casing to sink the hole as the casing is sunk or driven. (See Fig. 12-10.) The outside diameter of the bailer should be slightly less than the inside diameter of the casing being installed.

If the casing will sink by itself, the bailer is simply worked up and down inside the casing pipe to pick up loose ground material. As the bailer picks up the material from the bottom of the hole, the casing should sink under its own weight. (If the casing does not sink, it can be driven.) When the bailer fills up, it will need to be removed from the hole and emptied.

The casing can be driven at the same time that the bailer is being worked or it can be driven down about .5 m and then bailed. This particular process of driving and bailing is very commonly used to penetrate loose caving formations.

6. Problems in Sinking

- If the bit becomes stuck in the bottom of the well, it may be freed by attaching to the rope or shaft a long pole which pivots over a rock or log next to the hole to lever up the bit. (See Fig. 14-10.)
- Fishing - When a rope becomes worn, it may break, especially under the added strain of trying to retrieve a stuck bit. It may be possible to fit a hook onto the end of the drill shaft, hook the bit, and pull it up. A solid drill shaft is much easier to control and maneuver in the hole than rope or cable.

Chapter 13

CONSTRUCTION: SLUDGER METHOD

A. Hand Percussion and Fluid (Sludger)

1. The Method

A sinking method that has been used quite successfully in India and Pakistan is called the "sludger" method. It is an adaptation of the "hollow rod" technique which has been used with large drill rigs to sink wells. It is more formally referred to as the "hydraulic percussion" method; "hydraulic" because drilling fluid is used and "percussion" because the motion of the tools is up-and-down.

The tool string consists simply of a bit, a check valve, and lengths of hollow drill pipe. The tool string is lifted and dropped in the hole which is full of drilling fluid (usually water). The check valve in the tool string allows drilling fluid and the drill cuttings which are suspended in the fluid to pass through the valve on the downstroke of the pipe. These are not permitted to flow back out on the upstroke of the pipe. With the next downstroke more fluid and cuttings are forced up through the valve, thereby forcing the first mass further up the pipe. This continued up-and-down motion of the tool string then causes it to function as an inertia pump which acts to remove the drill cuttings from the hole. (See Fig. 13-1.)

FIG. 13-1. SLUDGER DETAIL

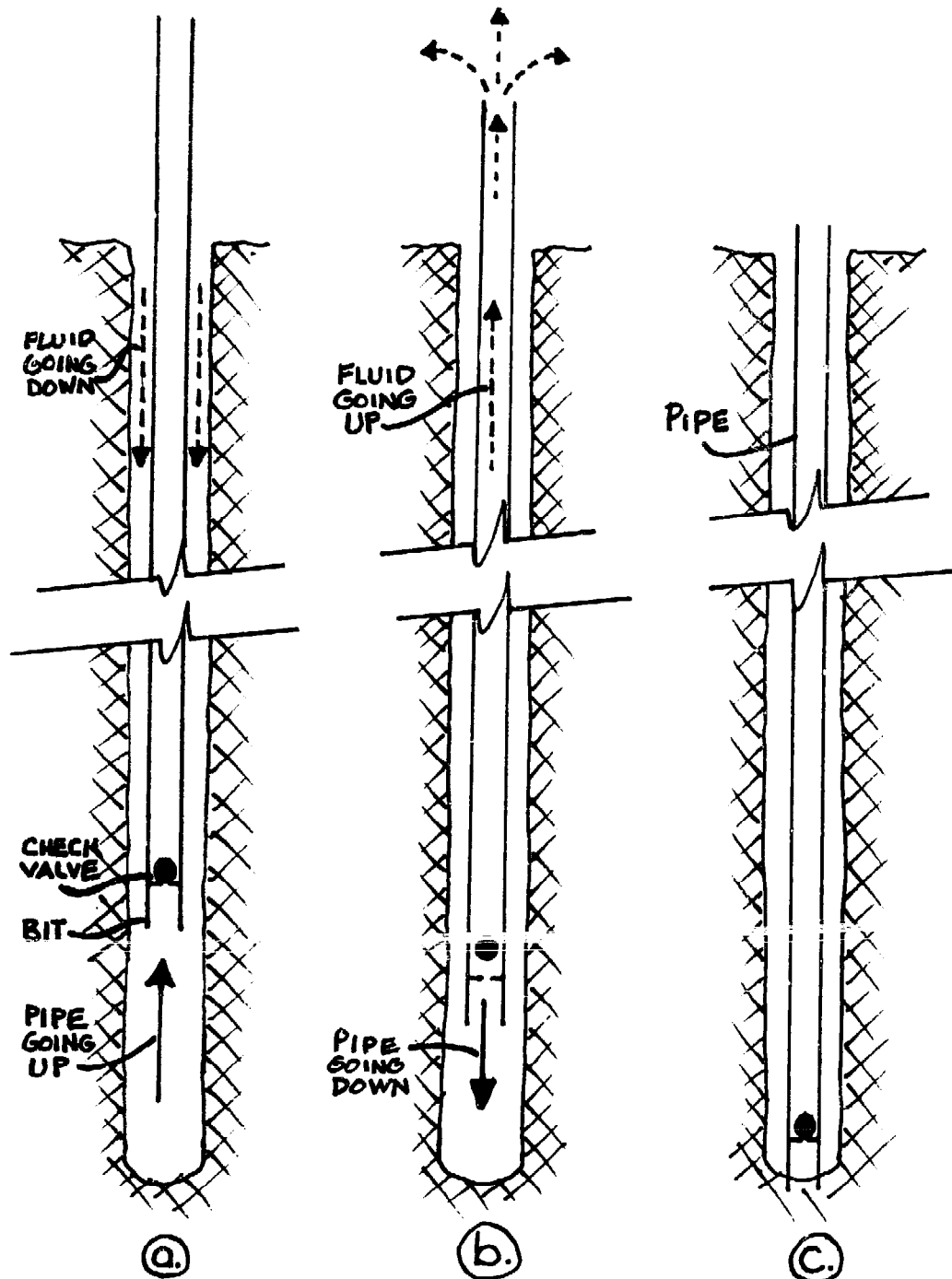

- (a) As the pipe is lifted, there is room for more fluid to flow down into the hole.
- (b) Dropping or pushing the pipe down forces fluid and cuttings to come up through the valve into the pipe and, after several strokes, out the top.
- (c) When the pipe strikes the bottom of the hole as you drill, the valve closes, preventing the fluid in the pipe from flowing back down into the hole.

The cutting action is performed by a bit attached to the lower end of the tool string. This can be simply a sharpened or jagged edged coupling that is screwed on to the bottom length of pipe. The bit strikes the bottom of the hole at the end of the down-stroke and acts to loosen the material which can then be picked up by the drilling fluid to be removed from the hole. (See Fig. 13-2.)

Several variations of this technique have been used effectively. Wells have been sunk using standard pipe and coupling as the bit while a person uses his/her hand to act as the check valve by covering and uncovering the top end of the pipe. Hollow drill pipe with a swivel joint attached on the top has also been used. (See Fig. 13-3.)

Where a motorized lifting apparatus is not available, more and more labor will be required to lift and drop the drill string as it gets longer and heavier.

This particular sinking method is the only one that uses drilling fluid to remove drill cuttings from the hole but does not need a special pump. Normally the pump is required to move the fluid so that it will pick up the drill cuttings but with this technique the drill string itself acts as the fluid pump.

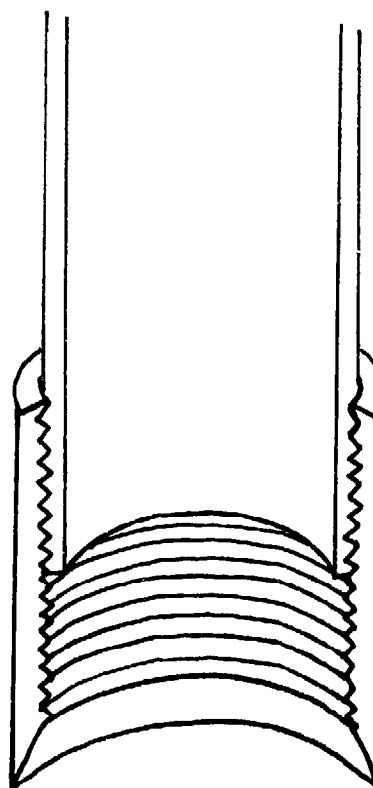
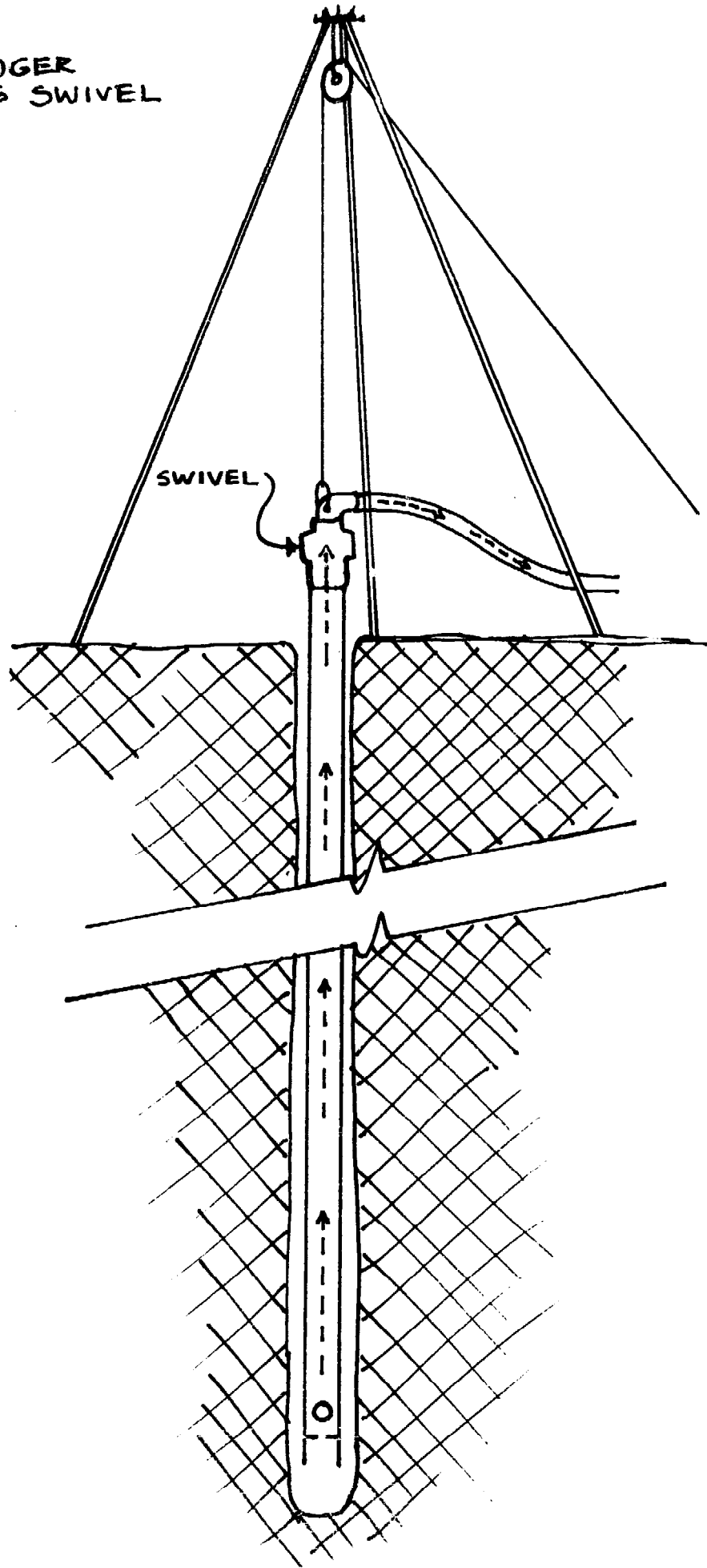

FIG. 13-2.
SHARPENED COUPLING

FIG. 13-3. SLUDGER
METHOD USING SWIVEL



2. Advantages and Disadvantages

Here are the major advantages of using this technique:

- very few tools are required;
- the work is completed quickly;
- the subsurface conditions are easily determined from 1) cutting samples taken from the drilling fluid issuing from the top of the drill pipe and 2) the rate of descent of the tools.

The major disadvantages are:

- the method requires that water be available;
- rocks larger than medium sized gravel cannot be penetrated.

3. Equipment

- Cutting bit: A regular pipe coupling can work as a cutting bit if the edges are sharpened. File or grind only the inside edge of the coupling to avoid narrowing the diameter. (See Figure 13-2.)
- Check valve: A valve prevents the downward flow of liquid in the drill pipe. Ball valves are commonly used. Where materials are scarce a well worker could use his/her hand to cover the top of the pipe when it is lifted, lifting the hand as the pipe is dropped. (See Fig. 11-6.)
- Drill pipe: Metal pipe which can be coupled together in suitable lengths as needed to provide necessary drill string height is usually used.
- Swivel hose connection to top of drill pipe: A water discharge piece is not absolutely necessary, although it is useful in helping to channel the water to a specific location rather than having it come directly out of the top of the drill pipe. (See Fig. 13-3.) Depending on the lifting apparatus used, a flexible hose could even be connected directly to the top of the drill pipe although it may become damaged with the continual up and down motion adding stress to it.

- **Lifting mechanism:** This can be made of local materials and be whatever you think appropriate. Some options are:
 - a tripod with pulley and rope and some way to pull and release the rope;
 - a springpole;
 - a capstan made of an empty rear car wheel;
 - a lever type assembly attached directly to the pipe by means of a rope or chain. (See Fig. 11-6.)

- Hand tools

An assortment of hand tools is always handy at a well site. When using metal pipe, pipe wrenches will be almost indispensable.

4. Sinking Process

- Arrange and set up all tools, equipment and supplies. Leave the area immediately around the well clear of materials that do not have to be there. Set up the lifting device and locate it appropriately. A tripod should have the pulley centered over the hole. A lever type arrangement should have the end of the lever adjacent to the hole.
- Start the hole in non-caving formations by sinking a hole as far as possible with a post hole digger or spade. In caving formations drive a section of pipe down so that the top end is slightly below ground level.
- Dig out a settling pit appropriate to the water discharge piece. With a swivel type discharge head or where water can be channeled to one location, dig a settling pit on one side of well with a small channel feed for water from the pit to the hole. With no discharge piece, the only alternative is to make the settling pit a circular shape around the hole. The problem with that arrangement is that it allows too many cuttings to fall back into the hole.
- Fill the settling pit and hole with water. (See Fig. 13-4.)

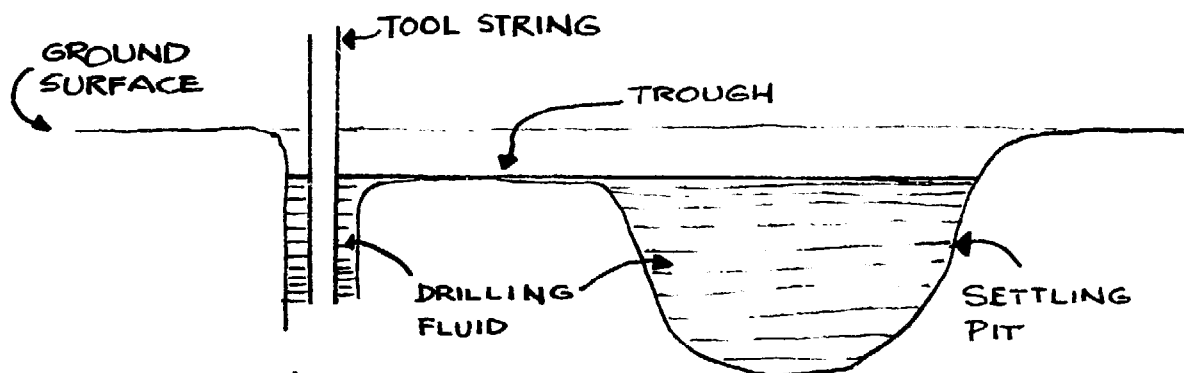

FIG. 13-4.

MORE FLUID WILL NEED TO BE ADDED TO ALLOW CONTINUOUS CIRCULATION THROUGH HOLE AND SETTLING PIT.

- Assemble the tool string, which consists of a bit, check valve, drill pipe and discharge piece. Set the tool string upright in the hole, and attach it to the lifting device.
- Begin the drilling operation by raising and dropping the tool string. The harder the material being drilled, the more rapid and shorter the strokes should be for the best results. Up to 120 strokes per minute may be desirable for shales, sandstone and limestone. The softer the material being drilled, the slower the stroke should be, from 30 to 60 strokes per minute in clays, loose sand, and gravel. In extremely soft material take care not to let the bit sink too far into the formation, thus plugging the bit or valve and making removal difficult. The best and safest method is to allow the bit to cut and mix the cuttings so that no chunks large enough to clog it are passed up the pipe. When threaded pipe is used in the tool string, it should be continually rotated in a clockwise direction to help ensure that the connections stay tight and a straight round hole is being drilled.
- Add more drill pipe when necessary as the hole is deepened. As the string becomes heavier it will require more and more power to lift it.
- It is also necessary to add water as the hole is being sunk to keep the hole full. The settling pit may need to be cleaned out to prevent excavated material from flowing back into the hole with the drilling fluid.
- When a good water-bearing layer is reached there is usually a noticeable drop in drilling fluid level. Continued pumping action will produce water and if sufficient quantity of water is produced drilling can be stopped. Drilling fluid will also noticeably drop when some dry sand, or gravel formations are reached. In this case it will be necessary to increase the weight (thickness) of the drilling fluid with additional clay, to help seal

the hole and prevent fluid loss. (In this situation the casing could also be driven in to reinforce the walls.) Rice hulls, wheat chaff, cow dung or other material can also be added to the fluid but the more and coarser the sealing material used the more difficult it will be to develop and clear up the well later. Excessive use of hulls or straw-loaded material may later plug the well screen and render the well useless.

- Casing - As in most other sinking methods, the casing can either be installed after the hole is sunk or driven down as the hole is sunk.
 - Casing the hole after it is completed is usually possible because drilling mud will tend to reinforce hole walls to prevent them from caving. Remove the drilling tool string and start the first section of casing pipe. It will usually have to be driven. Use a drive shoe (sharpened coupling) on the bottom of the casing to protect it. Add more sections of casing pipe as necessary. After the casing is driven it will be necessary to remove the material that will have accumulated inside the casing. This will not be difficult because the accumulated cuttings will be loose.
 - Casing the hole while drilling proceeds is only necessary where the hole caves in, hampering drilling efforts. The casing is driven down as drilling proceeds so that the bottom of the casing is at the same level as where the tool is working. Water will then have to be introduced into the casing pipe, probably by hand because the casing will be sticking up above ground level, preventing drilling fluid from entering the hole. When this happens, the inefficiency of the "pumping" process through the drill pipe may not permit water to be pumped up high enough above the static water level in the casing pipe (which will go down as pumped) to come out of the discharge piece.
- The hole is drilled and cased to the maximum depth possible, to the bottom of the aquifer, or until the water-bearing layer has been penetrated far enough to produce the desired amount of water.
- Sink and develop the bottom section of the well. Most often the casing and well point are driven into aquifer.

NOTE: Where a single well is being sunk, the drill pipe could also be used as the casing if it is sealed tight to prevent water seepage down around the casing.

Chapter 14

CONSTRUCTION: DRIVEN AND JETTEDA. Introduction

The driven and jetted sinking methods are different from the others in that they can sink the entire casing and well screen into the ground at the same time that the hole is being excavated. They are used primarily to sink the casing and well screen into final position in holes that have already been sunk down to the water table where the aquifer is composed of loose, caving soil. They can also be used to sink wells from the ground surface, although the conditions which would allow them to be used economically are very specific and relatively uncommon.

B. Driven1. The method

Techniques used in the sinking of driven wells are most commonly used not to drive well points and casing from the ground surface as the method describes but to drive casings down into place and well points and attached casing in from the top of the aquifer. It is a method that is used primarily along with and as a part of other methods.

FIG. 14-1. CONTINUOUS SLOT DRIVE POINT

This is a single piece of wire wrapped around and welded to a supporting frame attached to a steel point at one end and to the connecting pipe at the other. A cross-section of a bamboo variation of this type of screen is shown in Figure 15-4.

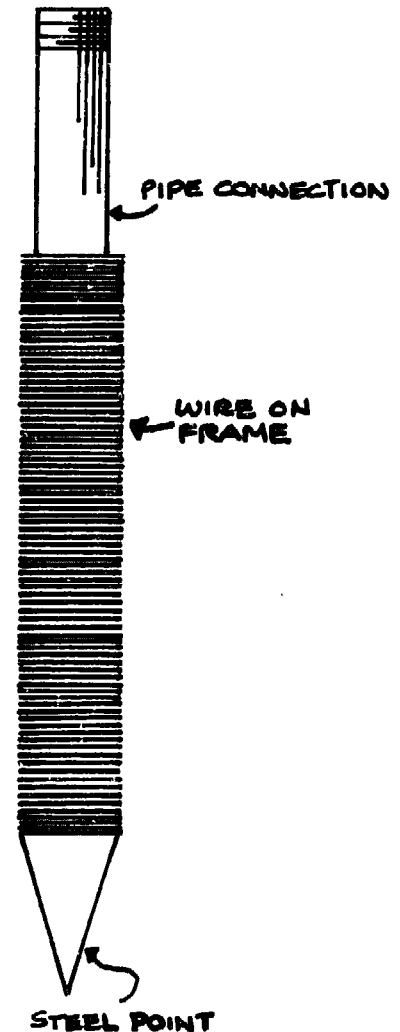

Make use of these various techniques when caving conditions prohibit the excavation of the complete hole for later casing.

This well sinking method is most effectively used in conjunction with hand augering where the aquifer is loose sand or gravel and the soil above it is non-caving. Hand-augering is more effective and faster in non-caving formations through which it would be difficult to drive a well point. Driving is then used in the lower water-bearing formation which will not support a hand-augered hole.

2. Advantages and Disadvantages

These wells are easily driven, pulled out and put down elsewhere. In time and money expended to reach water, driven wells may be cheapest.

The limitations of a driven well include the following:

- Supplies are often unavailable. Drive points almost always have to be purchased because of the necessary high quality. Metal pipe and pumps are available in most countries, but not often in rural areas.

- Drive points will not penetrate hard rock and will penetrate clay only with great difficulty.

- A drive point can rarely be driven deeper than 15 meters.

3. Equipment

The following equipment is

FIG. 14-2. BRASS-JACKET DRIVE POINT

A steel point attached to a pipe with holes in it, wrapped with a brass mesh preventing small soil particles from entering with the water.

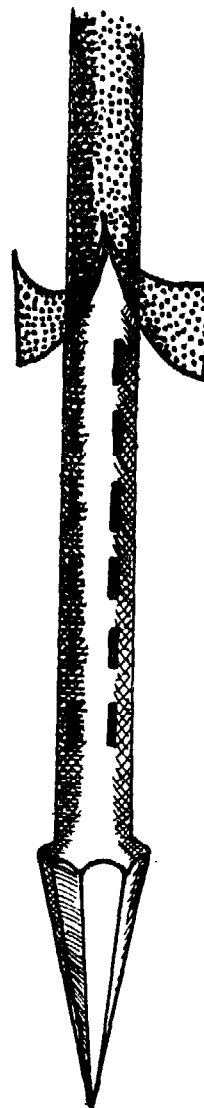

required for constructing driven wells:

- Drive well point. These are well screens with sharp steel points on their bottom ends so that they can be easily pounded into the ground. Because of the stresses put on them while they are being driven, drive points are invariably made of strong metal. It is possible to make a well point from a piece of iron or steel pipe by cutting and bending one end into a point, but commercially manufactured well points can withstand much greater stress. Above the pointed tip, all well points have a length of well screen through which water will enter the well. (See Figs. 14-1 and 14-2.)

- Metal pipe. Metal pipe is attached to the drive point and driven into the ground where it will act as the casing. Only metal pipe is strong enough to withstand the stresses put on it during the driving process.

- Drive couplings. These are special couplings in which pipe ends actually meet. (Questions have come up about the usefulness of this type of coupling because when driven, the connection loosens somewhat and cannot be tightened again because pipe ends are flush with each other already.) (See Fig. 14-3.)

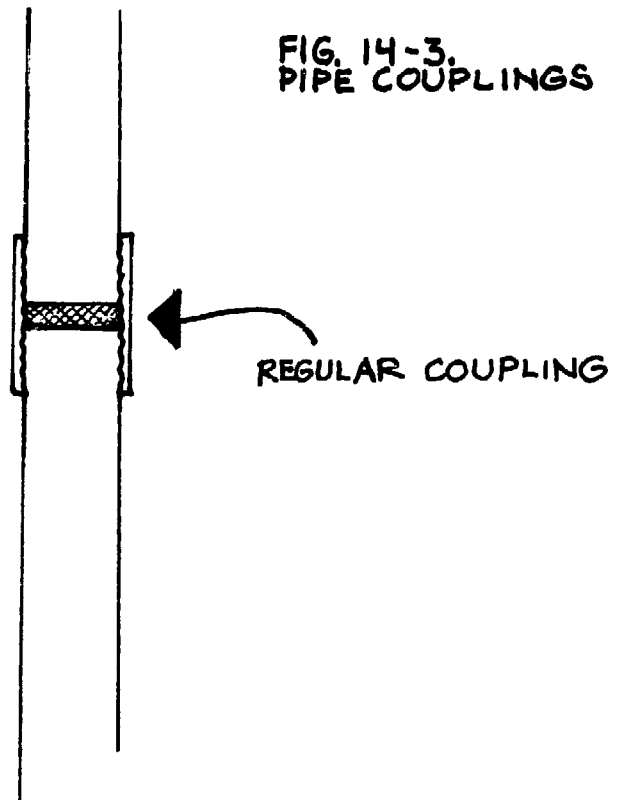
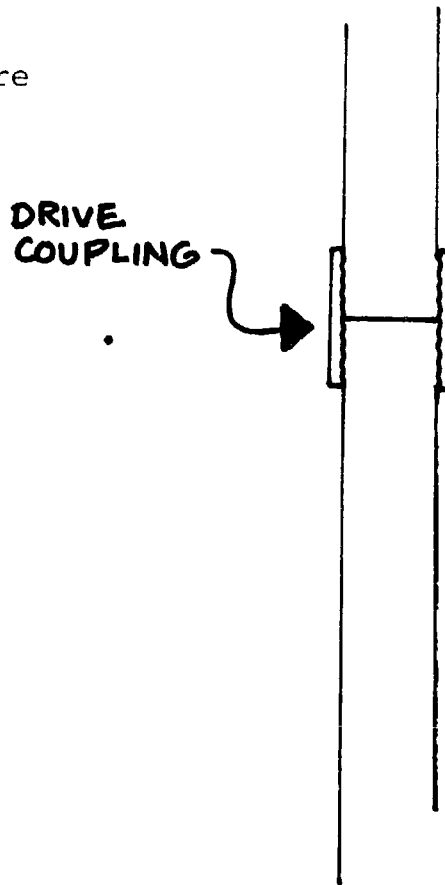

- Drive cap. This is installed on the pipe being driven to protect it. There are two kinds of drive caps: female drive caps (see Fig. 14-4a) which screw directly onto the threads or the top of the pipe and male drive caps (see Fig. 14-4b.) which screw into a drive coupling which screws onto the top of the pipe.

- Drive weight. This will be used to strike drive cap to drive it into the ground.

- Lifting device. This is an apparatus to lift drive weight to then let it fall on drive cap.

- A plumb bob or level is needed to check that the pipe being driven is going straight down.

- A water lifting device will be needed for final installation to allow people to get water from well.

FIG. 14-4.
DRIVE CAPS ON
TOOL STRINGS

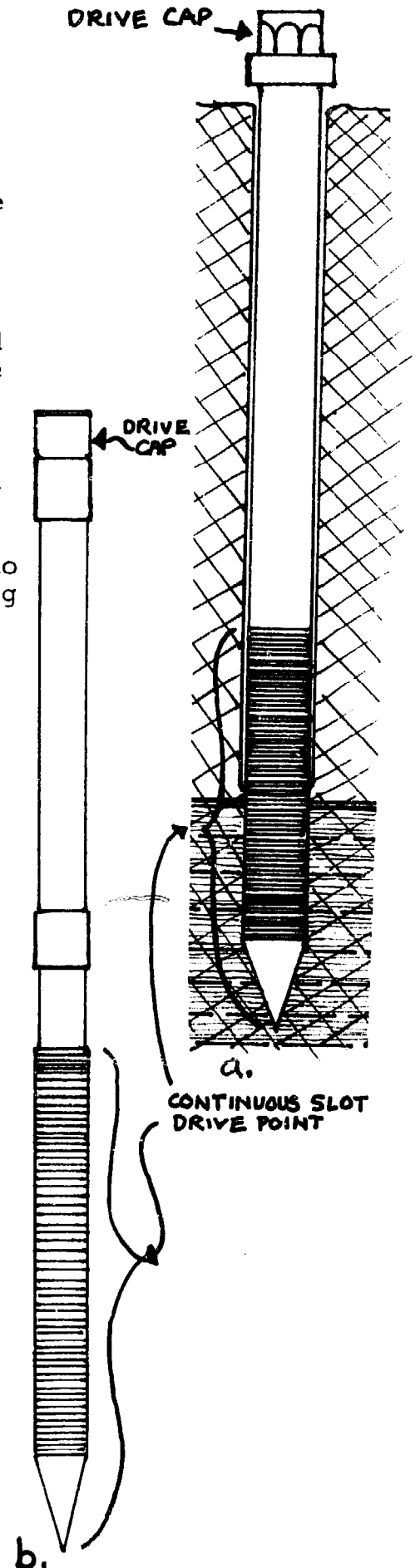

4. Tools

Here are the major tools that are needed:

- Two pipe wrenches are needed to tighten metal pipe sections together.
- A pipe cutter or hack saw is needed to cut the metal pipe off at the desired level when it has been driven as far as desired.
- A metal file is needed to remove rough or sharp edges from the pipe after it is cut. This is not absolutely necessary, but it is always a handy tool to have around.
- Pipe threader. You will usually need to thread the metal pipe once it is cut so that you can attach the pump base plate to it. (Most commercial pumps have a screwed connection to the drop pipe.) Make sure that the pipe threader will work on the short section of pipe that is sticking out of the ground.
- Pipe dope or sealer should be put on metal pipe threads to make them watertight before the pipe is screwed into a coupling.

5. Driving Methods and Equipment

Following are five different methods and the equipment that can be used to drive wells.

- Use a sledge hammer to strike the drive cap directly. The equipment required includes a drive cap and a sledge hammer weighing 5-10 kilograms. Take care to hit the drive cap squarely because glancing blows may damage the pipe. Only a limited depth is possible because of the limited driving force. This method is physically very hard. (See Fig. 14-5.)

- Use a sledge to strike a driver which fits over the drive cap. The equipment required includes the drive cap, a sledge hammer, and a driver. A driver helps prevent damage from glancing blows.

- Use a weighted driver which fits over the drive cap. The driver is lifted and thrown or dropped to strike the drive cap. The equipment required includes a driver and drive cap. A driver can be fitted with handles to help in lifting and throwing, thus permitting two people to use it and enabling them to apply more force. (See Fig. 14-6.)

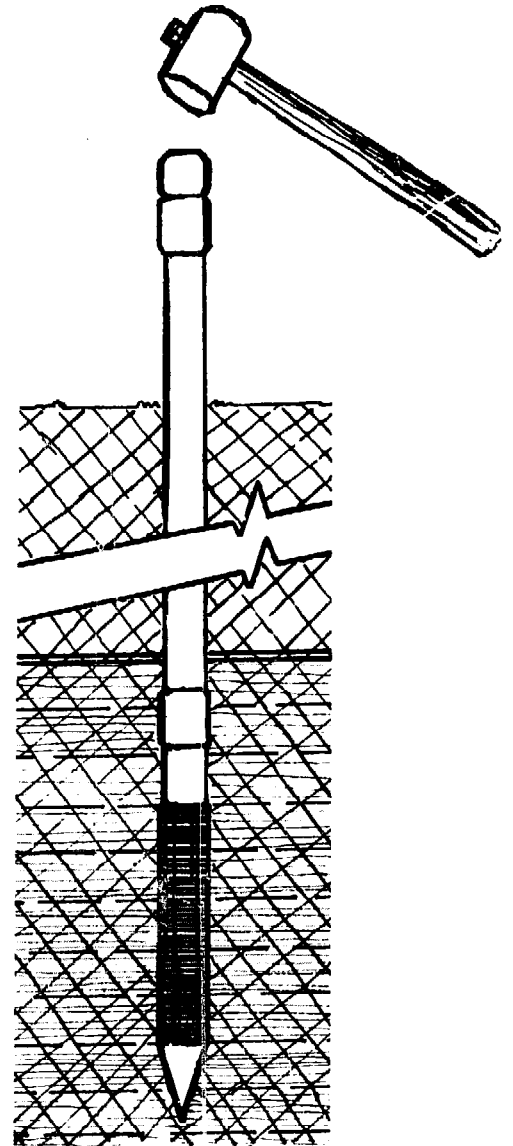

**FIG. 14-5. SLEDGE
HAMMER USED TO
DRIVE WELL**

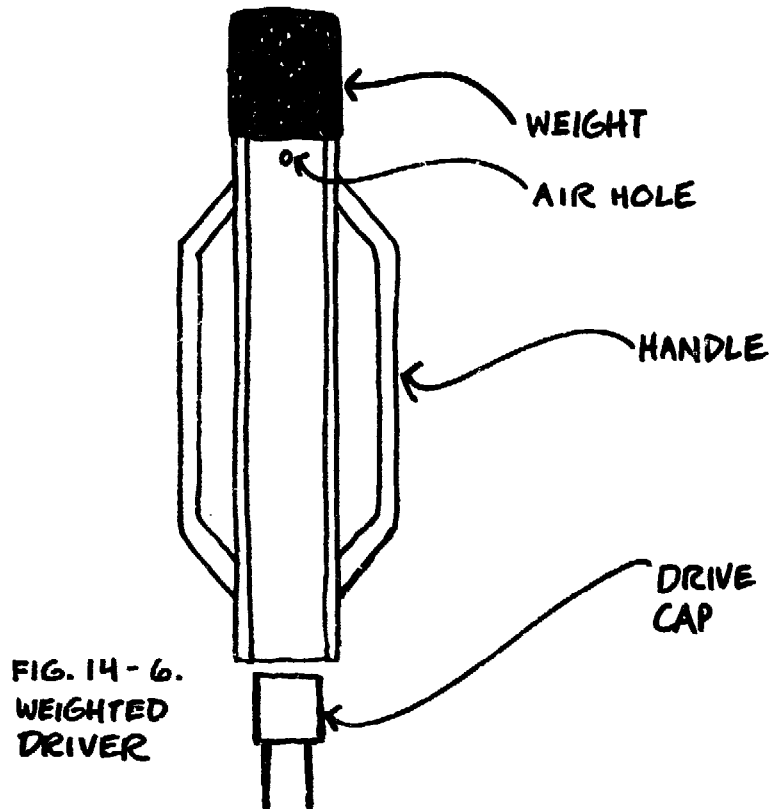

FIG. 14-6.
WEIGHTED
DRIVER

- Use a steel driving bar attached to a rope which is lowered into the pipe to strike directly on the driving point. (See Fig. 14-7.) The equipment required includes a driving bar, rope, tripod, and pulley. This is one of the safest methods of driving because it does not weaken the pipe.

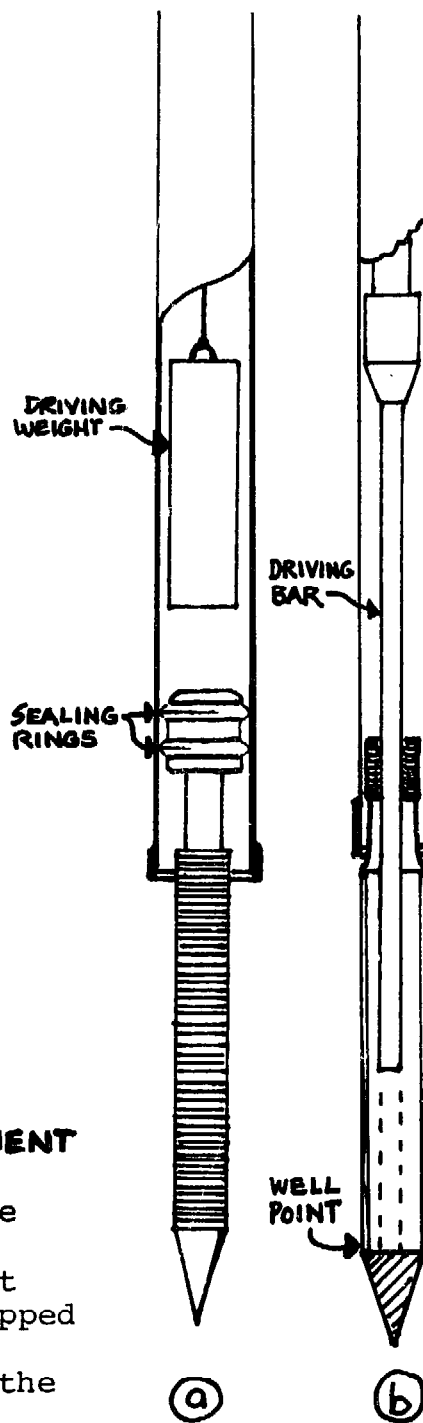

FIG. 14-7.
STEEL DRIVING BAR ARRANGEMENT

(a) A drive point can be driven down through the casing by a heavy weight which is lifted and dropped onto a reinforced head attached to the top of the drive point. The reinforced head shown here also has two sealing rings to seal it to the casing.

(b) This drive point is driven into place by a long heavy bar which, when dropped, strikes the back side of the steel point on the drive point. A special packing must then be wedged into place to seal the drive point to the casing.

● A 15-20 kg driving weight is used to strike a) a drive cap or b) a drive clamp attached to the pipe. The equipment required includes a drive cap or drive clamp, a driving weight, rope, pulley(s), and a tripod. These are all variations of the basic idea that a guided heavy weight strikes an instrument on the pipe to drive it.

a. The driving weight can have a bar extending down from it which slides through a hole in the drive cap. (See Fig. 14-8a.)

b. The driving weight can slide up and down the metal pipe to strike a set of drive clamps attached to pipe. (See Fig. 14-8b.)

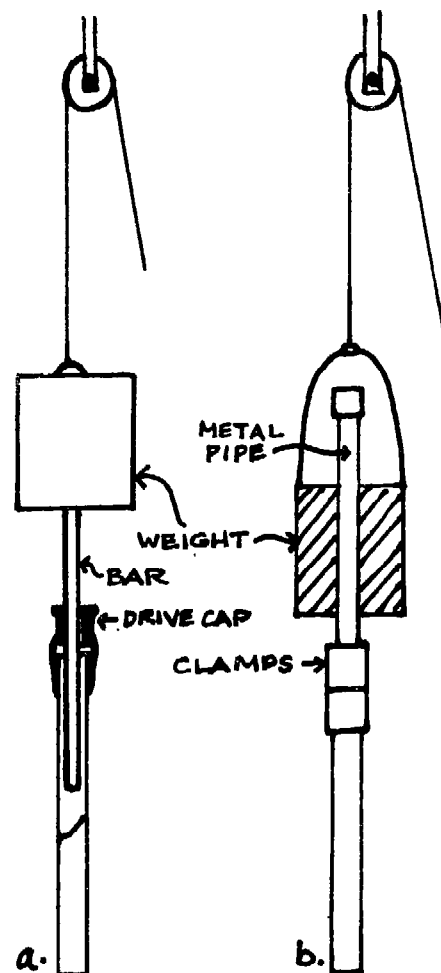

FIG. 14-8. HEAVY DRIVING WEIGHTS

6. The Sinking Process: From the Water Table

Here is a detailed description of the sinking process where a hole has already been sunk to the top of an aquifer from which it is desirable to draw water:

- Before removing the initial hole sinking tools from well, it would be useful if possible to try to sink the tools some distance into the aquifer to get an idea how deep it is. Only attempt this if your initial

sinking tools are such that once sunk into the aquifer you are able remove them.

- Arrange and set up all tools, equipment and supplies. Make an effort to maintain an orderly well site as you proceed, to ensure the safety and convenience of further work.
- Attach the well point and extensions if needed, to the first pipe length. Pipe joints must be made up carefully both to insure a watertight joint and to prevent thread breakage. Attach a coupling to the top end of the first pipe length. Attach a pipe clamp just below the coupling on the top end of first pipe length. Lower the assembled pipe and screen into the hole, setting both ends of the pipe clamp on raised flat surfaces, such as wooden blocks on either side of the hole .
- Screw the coupling into one end of another pipe section and attach another pipe clamp below it as was done for first pipe section.
- Screw this second pipe section into the coupling on top of first pipe section now in the hole.
- Taking the weight of the pipe string on the pipe clamp on top of the second pipe section, lift the pipe string up just enough so that the first pipe clamp is not resting on the blocks.
- Remove the first pipe clamp and lower the pipe string until the second pipe clamp rests on the blocks.
- Continue adding pipe sections and lowering the pipe string until the well point rests on the bottom of the, previously sunk hole.
- Plumb the pipe and drive it into the aquifer. Plumbing the pipe will be much easier than if driving had been started from the ground surface, but you must still be careful that the pipe string is being sunk plumb. To tighten the joint, give the uppermost pipe a fraction of a turn with each blow until it is permanently set.

- Once you have driven the pipe as far as you can or want to into the water layer, you will need to develop the well. (See p. 202.)
- Before the pump is installed and any surface platform work is done, the gap between the pipe and the sides of the hole must be filled. This can be done with any material pulled out of the well up to a point three meters below the ground surface. The top three meters should be sealed with either mortar or puddled clay to prevent surface contamination from entering the water source.

7. The Sinking Process: From the Ground Surface

Driving the entire well from the ground surface is most commonly used for extracting water from sands, especially those underlying beds of intermittent streams, and making use of the natural filtering properties of sandy beds of perennial rivers. Here is a detailed description of the major activities involved in sinking from the ground surface:

- Arrange and set up all tools, equipment and supplies. Clear the area immediately around the well site of all unnecessary tools. If a tripod is to be used, set it up and locate it so that the weight will be centered directly over hole. (It is easier to keep the pipe perfectly plumb if the weight is properly centered.)
- Place the well point in place and begin to drive it (p. 178). It is a good idea to dig or auger a shallow (50-80 cm) hole in which to start the well point. Especially at the beginning, pipe plumb must be frequently checked. Later, when several lengths of pipe have been sunk, the whole length will be supported by the ground and will require infrequent checks of plumb. A support for the upper end of the pipe will initially help to hold it plumb and may later assist in aligning new sections of pipe so they can be screwed into couplings.
- Drive the pipe and add more pipe as needed. When the pipe has been driven so far that driving can no longer be accomplished, add another section of pipe.
 - Remove the drive cap and screw a coupling in its place. Install a drive cap on top of the new pipe section. Screw the new pipe section into the coupling on top of the pipe set in ground. (See Fig. 14-9.)

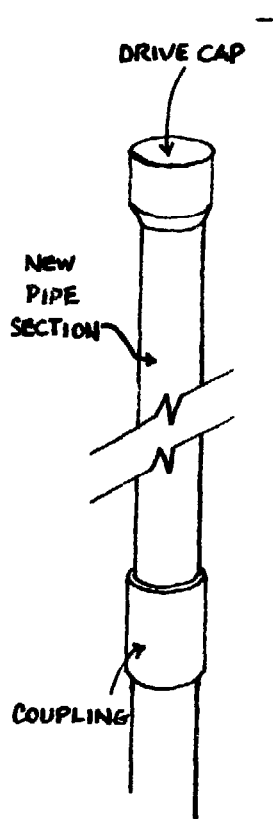

FIG. 14-9.
INSTALLING NEW
PIPE SECTION

Where drive clamps are being used instead of a drive cap, a slightly different procedure is followed. To begin driving place clamps no more than 50 cm above ground on pipe (or at the bottom of a pipe section if the well screen sticks above the ground more than 50 cm). It is easier to keep the pipes plumb if the point of impact is closer to the ground surface. When the screen and pipe have been driven down to a point where the drive clamps almost touch the ground surface, move the clamps up 30 to 50 cm. Reset them on the pipe and drive them down again. As more and more pipe is driven into the ground and the danger of driving the pipe string out of plumb decreases, the clamps can be moved. When the driving weight can no longer be raised far enough to provide sufficient striking force to drive the pipe string, a new length of pipe will need to be added. Screw a coupling onto the top of the pipe being driven and screw a new section of pipe into the top of the coupling. Make sure the weight can be raised above the coupling before the coupling is screwed on the pipe. You may want to slip new pipe through the driving weight before attaching it to the coupling.

- To determine whether water has been reached, the plumb line can be lowered into the pipe. If the line comes up wet, you have hit water. By comparing the depth the line reaches to the known depth of the pipe, you can also get an idea about whether earth or sand has to any significant degree entered the screen.
- You can also learn what kind of soil or formation you are driving through by the reactions of the pipe and driving weight when the pipe is struck by the weight.

RELATION OF DRIVING TO SOIL CONDITIONS

Type of formation	Driving conditions	Rate of descent	Sound of blow	Rebound	Resistance to rotation
Soft moist clay Tough hardened clay Fine sand Coarse sand	Easy driving Difficult driving Difficult driving Easy driving (especially when saturated with water). Easy driving	Easy driving	Gravel	Boulder and rock	Almost impossible
			Rapid Slow but steady Varied Unsteady irregular penetration for successive blows	Dull None None Dull	Unsteady irregular penetration for successive blows Little or none
			Dull None None Dull	None Frequent rebounding Frequent rebounding None	None Sometimes of both hammer and pipe
			Dull None None Dull	None Frequent rebounding Frequent rebounding None	None Rotation is irregular and accompanied by a gritty sound Dependent on type of formation previous- ly passed through by pipe
			Dull None None Dull	None Frequent rebounding Frequent rebounding None	None Slight but continuous considerable slight rotation is easy and accompanied by a gritty sound

(From: Well Drilling Operations, TMS-297/AFM 85-23, Army/Air Force Technical Manual, p 24.)

- When you reach water, drive the pipe as far into the water layer as possible. The bottom of the well point should just touch the top of the impermeable layer on top of which the water sits. To be useful and not put too much stress on the well screen, the aquifer should be deeper than the height of the well screen. (See Well Screens, p. 193.) If you can drive the point six or seven meters into an aquifer without reaching the bottom, you have assured a very large supply of water and there may be no point in driving any further.

- If you don't reach water or have for some reason driven beyond the water bearing formation, you may want to lift the pipe string just a little or remove it completely from the hole. 1) You can sometimes lever the pipe up by using pipe clamps and crowbar or a stout stick. (See Fig. 14-10.) 2) You can use two jacks and pipe clamps to jack it out. (See Fig. 14-11.) After it has been raised a few feet, the rest can be done by hand. Rotating the pipe will assist its removal.

- Once you have driven the pipe as far as you can or want to into the water layer, you will need to develop the well. (See p. 202.) You may wish to prepare the top end of the pipe for connection or use with the particular water lifting device you are using before developing the well.

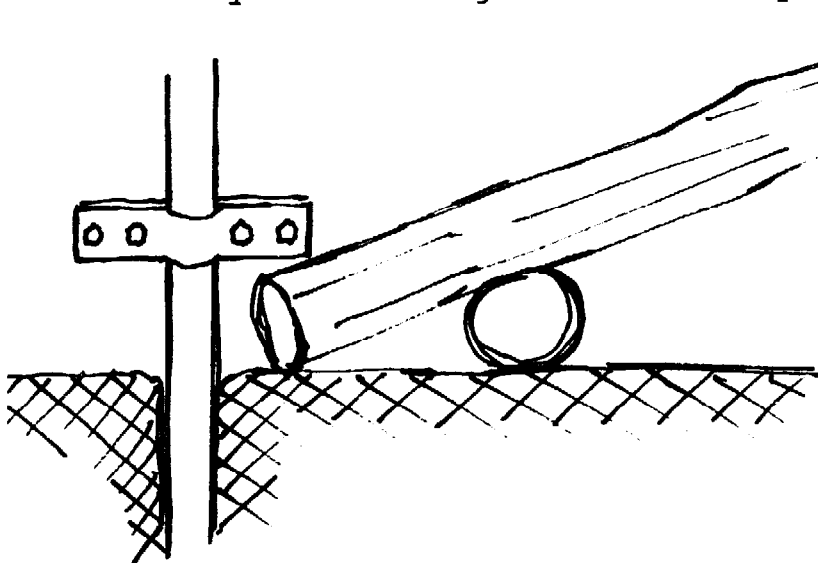
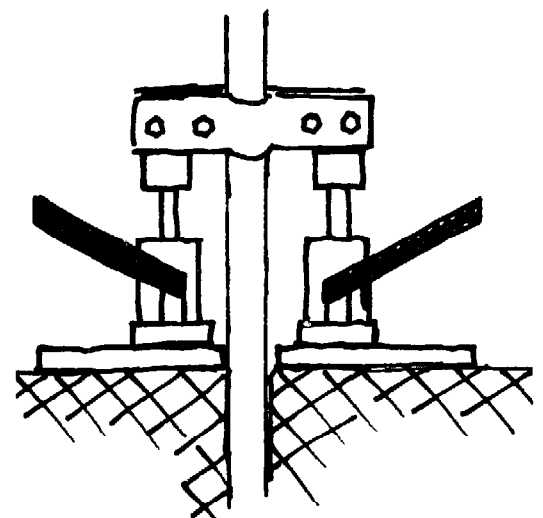

FIG. 14-10. LEVER
PIPE UP

FIG. 14-11.
JACK PIPE UP



C. Jetted

1. The method

Jetted wells are sunk through the action of a fluid under pressure directed to the bottom of the hole to loosen soil particles and carry them to the surface.

Variations of this technique have been used in many different wells construction situations. A major use is to wash the casing into a loose or slightly caving formation by pumping water down through the casing and out the open bottom of the casing or well screen. Wells continue to be jetted from the ground surface only in areas where rock is not likely to be found and the larger drilling equipment is not available or too expensive.

In jetted techniques, drilling fluid is pumped down through the hollow drill rod and out through a hole in the jetting bit. (See Fig. 11-2g.) The faster and more powerful the spray, the better cutting action it will have. After the fluid has been directed at the bottom of the hole, it flows back up the hole carrying with it the soil that has loosened from the bottom of the hole. Once the fluid reaches the top of the hole, it is channeled through a small ditch into a large settling pit. The fluid stands in the settling pit long enough to allow drill cuttings to settle out of the fluid, before it is pumped back down the drill rod.

The volume of the settling pit should be at least three times the volume of the hole being drilled. It should be relatively shallow (0.7-1.0 meter is usually sufficient) and about twice as long in the direction of flow as it is wide and deep. For example: a settling pit two meters long, one meter wide and one meter deep could be used when drilling a 10 cm diameter well 85 meters deep.

The drilling fluid is usually a mixture of clay and water. The clay is needed to make a fluid of such consistency that it will tend to reinforce the hole walls by forming a kind of "mud cake" along them. Fluid with too much clay and accumulated drill cuttings will be thick and difficult to pump. The thickness of the fluid may need to be adjusted during drilling by adding more water and/or removing some of the accumulated cuttings from the settling pit. Water alone will often act effectively as a drilling fluid, especially as it thickens after accumulating some of the finer drill cuttings.

2. Advantages and Disadvantages

Here are the major advantages of using this technique:

- Loose, caving formations are easily penetrated.
- Few people are needed to operate the equipment.

The major disadvantages are:

- The method requires more special equipment than others.
- A large quantity of water is required for drilling.
- Hard clay and boulders may slow and stop drilling.

3. Equipment

- Jetting bit: A shortened percussion type bit with water passages is helpful in loosening material at bottom of the hole. (See Fig. 14-12.)

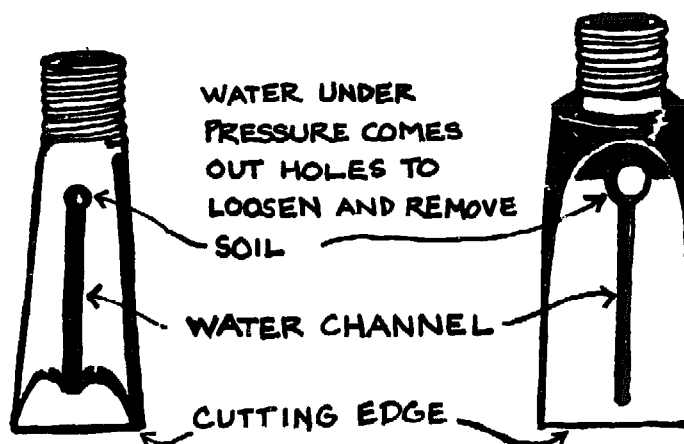

FIG. 14-12. JETTING BITS

- Drill rod: Hollow drill rod is necessary to transmit the drilling fluid to the bottom of the hole. The smaller the diameter of the rod the lighter it will be.
- Swivel hose connection to top of drill rod: It is not absolutely necessary to have a swivel connection although some type of connection is needed through

which fluid can be pumped into and down the drill rod. A swivel connection allows the tool string to be turned during jetting, thus helping to assure a straight, plumb hole and helping to loosen soil at the bottom of the hole.

- Flexible hose: This is needed to connect the pump with the connection on the top of the drill rod, allowing fluid to be pumped through the drill rod. A length is also needed between the pump and the setting pit from where the fluid is pumped.
- Pump: A pump is needed to move the drilling fluid through the drill rod and out the bit, where it can loosen and remove soil from the bottom of the hole. Large capacity hand pumps have been successfully used although motor pumps are easier and provide better jetting action. Diaphragm pumps are probably best suited to this kind of work because of their ability to move relatively large soil particles without damaging the pump.
- Tripod or other overhead support: Some type of overhead support is needed from which the tool string can be suspended and lifted or lowered when necessary.
- Hand tools: A number of hand tools can be used to connect and disconnect hoses and drill rod when necessary. Pipe wrenches, screwdrivers, and regular wrenches may be particularly handy, although shovels, rope and pulley will also be needed.

4. Sinking Process

- Arrange and set up all tools, equipment and supplies. Leave the area around the well clear of materials that do not have to be there. Set up the overhead tool string support and locate it directly over the proposed site. (See Fig. 14-13.)
- Dig out a settling pit as needed for the hole diameter and expected depth. A shallow channel should connect the settling pit and the hole so that drilling fluid coming up out of the hole will flow into the settling pit.
- Start the hole by digging as far as possible with a shovel or post-hole digger.
- Fill the settling pit and hole with drilling fluid or water.

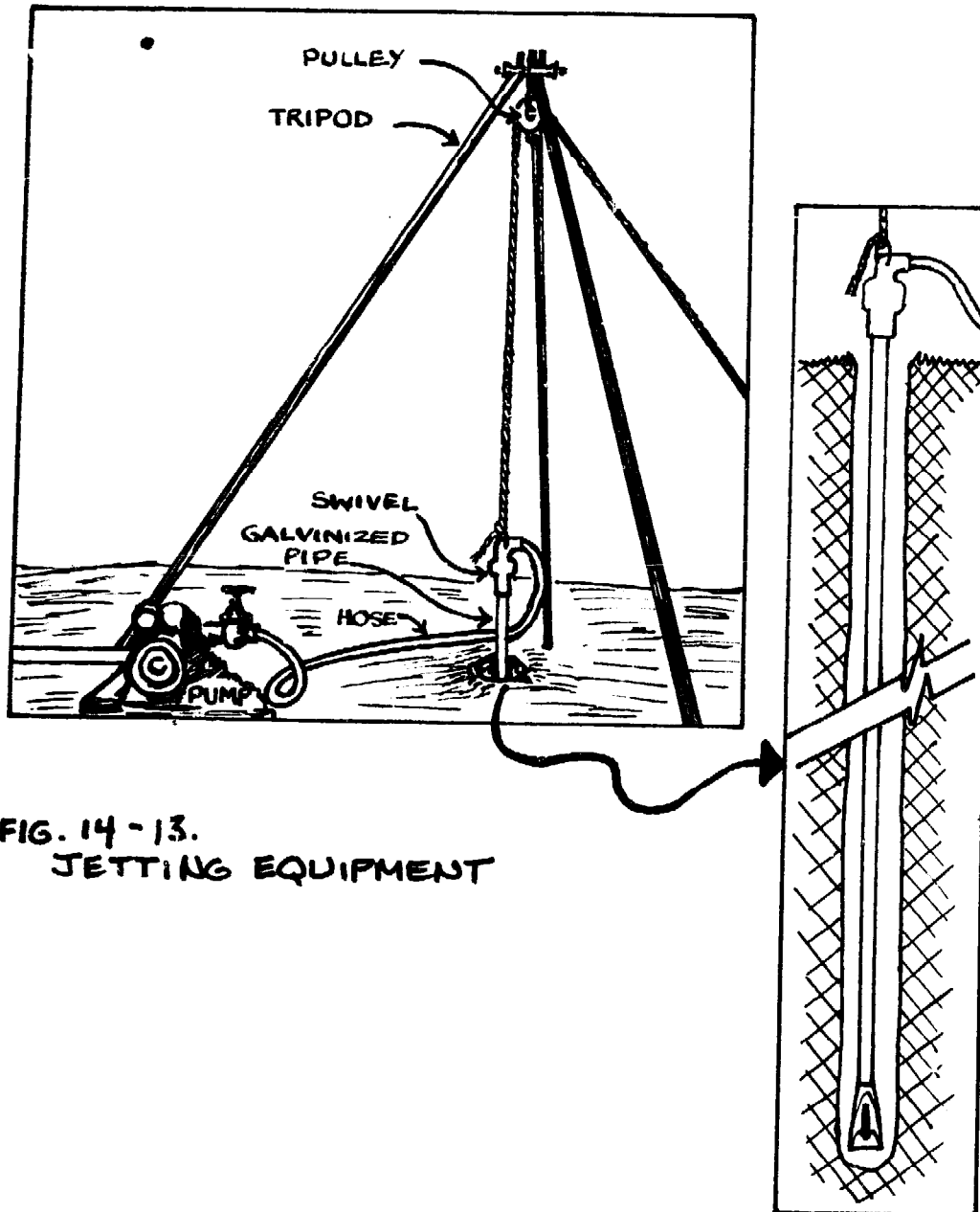

FIG. 14-13.
JETTING EQUIPMENT

- Assemble the tool string and suspend it from the overhead support. Attach the hoses between the drill rod and the pump and between the pump and the settling pit.
- Start the pump to begin the drilling operation. Begin by pumping slowly to allow time to carefully plumb the tool string as it sinks the first meter or two. As the drilling proceeds, more pressure may be necessary to get the needed cutting action with the heavier drilling fluid. A slight up and down percussion action may help to speed the drilling.

- Add more drill rod when necessary as the hole is deepened. The fluid circulation will have to be stopped to permit another length of drill rod to be added into the tool string. It may then be difficult to get the fluid circulation started again because the heavier soil particles tend to settle in the hole, clogging the bottom. Where the aquifer depth is known, it is possible to avoid this problem by assembling the entire casing and open bottom well screen above the hole, supported by a large scaffolding, so that it can all be sunk in one continuous operation.
- It may be necessary to add more fluid and clean some of the accumulated cuttings from the settling pit at some point during the drilling process so that drilling can proceed effectively.
- When a good water-bearing layer is reached, there is usually a noticeable drop in the drilling fluid level and often a significant increase in the speed with which the hole is being sunk. The hole should be sunk as far as possible into the aquifer.
- Because the jetting operation tends to reinforce the hole walls with the drilling fluid, it may be possible to pull the drilling tools completely out of the well and then set the assembled casing and well screen into the bottom of the hole. Keep an accurate record of the depths at which water was first reached and where the drilling was stopped so that you can determine how much well screen should be installed and whether the casing and well screen have been lowered to the actual bottom of the hole. If the complete casing cannot be lowered into place it will have to be driven or washed down. You will want to jet the well to its final depth. It is possible that the well may begin to cave in as the tools are being pulled out, but if it has been jetted to the final depth, it will be much easier to drive or wash the casing and well screen into place than if the well has not been completely sunk.

Chapter 15

THE BOTTOM SECTIONA. Introduction

The bottom section of a small diameter well usually consists of part of the casing pipe and a well screen, which acts as the intake section. (See Fig. B.) In order for the well screen to function effectively, the aquifer material that surrounds the screen must be rearranged to allow as much water as possible to flow through it. This rearranging process is known as development.

For wells that are sunk into solid rock, the intake section could simply be the open bottom of the casing pipe but this is not a normal occurrence in relatively shallow wells.

The intake section or well screen is a continuation of the casing in that it reinforces the walls to keep the hole open. Simple screens can be made by making holes in the casing. However, commercially available well screens may incorporate useful features that cannot be obtained from homemade screens. (See Well Screen, p. 193.)

B. Considerations in the Construction of the Bottom Section

There are several considerations to bear in mind before beginning work on the bottom section:

- choosing the appropriate screen. One must consider the cost, material, local manufacture, opening size, diameter, length, and strength;
- properly placing the screen in the water bearing layer so that it can produce as much water as necessary;
- developing the aquifer material surrounding the screen to obtain the most efficient production.

C. Construction Procedure Outline

In general, there are only two steps involved in the construction of the bottom section:

- setting the screen in the desired place in the hole;
- developing the well.

Both of these steps must be done carefully and precisely in order to make full use of the rest of the work that has gone and will go into building the well. The amount of water that can be drawn from the well is almost completely controlled by how this section is built. Here are the activities involved in the two steps:

1. Set the screen in its designated place in the hole. Two general procedures can be followed, depending on the size of the well screen in relation to the casing pipe.
 - a. A pipe-size screen is attached directly to the bottom of the casing pipe and lowered into place in the hole. Usually the hole has been at least partially sunk and the screen and casing have penetrated to the desired depth by being driven or washed down. Where drilling fluid has been used in the sinking process, it may reinforce the hole enough to prevent its caving, thus permitting the screen and casing to be simply lowered into place.
 - b. A telescoping-size screen is lowered into place through casing.
 - 1) The most popular professional method is for the hole to be drilled to the desired depth and cased. The screen is then set in place on the bottom of the hole inside the casing and then the casing is pulled up to expose the screen. A special packing piece is next wedged into place between the screen and the casing to prevent the entry of unwanted aquifer material.
 - 2) The screen can also be washed down into the aquifer from the bottom of the permanently placed casing.

NOTE: Telescoping screens into place may be difficult with locally made materials because of the difficulty of sealing the screen to the casing pipe once both have been set in their permanent places. Normally this is done with a special packing piece that is wedged into place.

2. Develop the Well

This is the process of using any one of a number of tools or methods to quickly move water in and out of the well screen, thereby removing the fine particles from the aquifer in the vicinity of the screen. It usually requires an average of 6 to 10 hours to complete.

D. Materials and Equipment

The following types of materials and equipment will be required for construction of the bottom section:

- Sinking equipment: The different sinking methods and ground conditions in which they are appropriate have been covered in detail in "Middle Section, Sinking Methods." Because people do not have to work in this kind of well in order to sink it, sinking methods need not change between the middle and bottom sections. The only difference between the two is that ground conditions beneath the water table are liable to be loose and caving.
- Well screen intake section: This refers to any portion of the casing that has holes in it which are intended to allow water to enter the well. (See section E on Well Screens, below.)
- Developing the well: For the equipment necessary to develop the well, see the section on Development, p. 202.

E. Well Screens

A well screen is a special section of casing with holes in it which is placed in the water bearing layer to allow water to enter the well. It should be strong enough

to withstand stress while it is being installed as well as caving pressure in the hole. It should be made of material appropriate to the chemical and bacteriological characteristics of the local ground water, neither easily corroding nor rotting. The greater the open area of holes contained in the screen, the more efficiently it will work by letting in more water.

Well screens can either be commercially or locally made. The cost of commercially made screens and the time required for delivery to the well site usually make them unsuitable for isolated wells whose object is to supply only a few thousand liters of water per day to the local inhabitants. However, commercially manufactured screens offer advantages in quality. They can often be more easily installed and provide more water of better quality for a longer time than locally made screens. (See Fig. 15-1.)

Locally made screens are usually produced from the casing materials that will be used in the normal small diameter well sinking operation. There are some limitations concerning which materials can be used in various kinds of

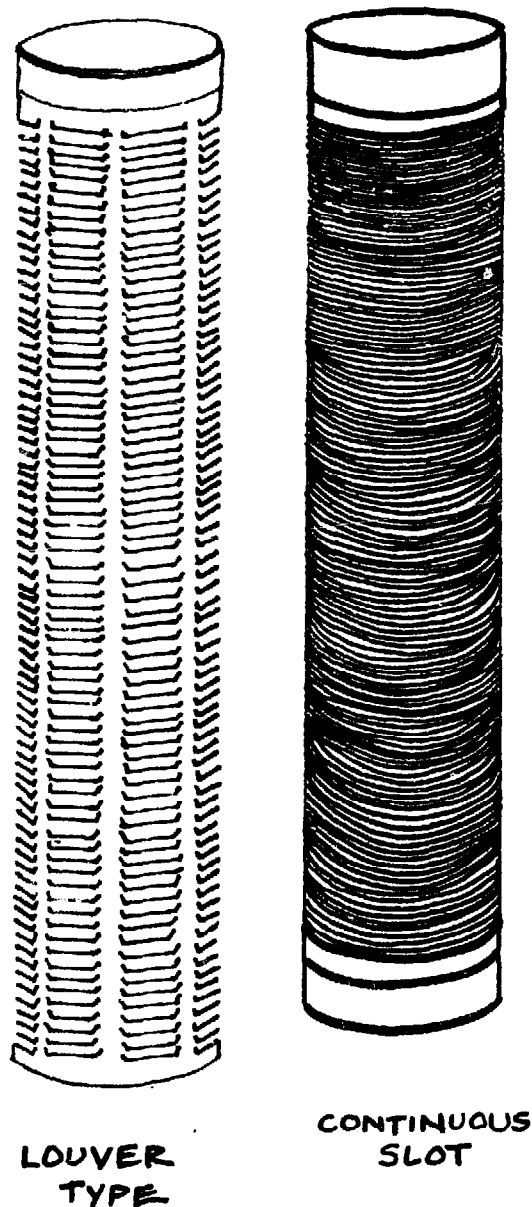

FIG.15-1 MANUFACTURED SCREENS

ground formations, but an appropriate solution can almost always be found. The cost of a locally made screen will simply be the cost of putting holes in a section of casing which has already been purchased for installation in the well. Perhaps their biggest disadvantage is the difficulty of producing the small opening sizes which may be necessary in fine sands. (See Fig. 15-2.)

A new method has been developed which would enable the local manufacture of continuous slot well screens out of specially made plastic pipe. This pipe is extruded to provide lengthwise reinforcing ridges along its inside surface. A lathe equipped with a high speed grinder on which the grinding wheel is replaced by a small circular saw the desired slot width is used to cut a continuous slot. For more information see the article by Sternberg (Sternberg 1978) cited in the bibliography.

Manufacturers will provide well screen information on request. However, because shipping and cost considerations may prohibit the use of commercially produced well screen, the remainder of the discussion will relate to locally producible screens.

F. Design

Designing the bottom section of a small diameter well involves deciding 1) what the screen will be made of, 2) how long it will be, 3) what the diameter of the screen should be, 4) how big the openings are, 5) the opening shape, 6) the arrangement of the openings, and 7) exactly where this will be placed in the water-bearing formation.

In sinking with locally available hand powered equipment, certain limitations will influence how you design the bottom section.

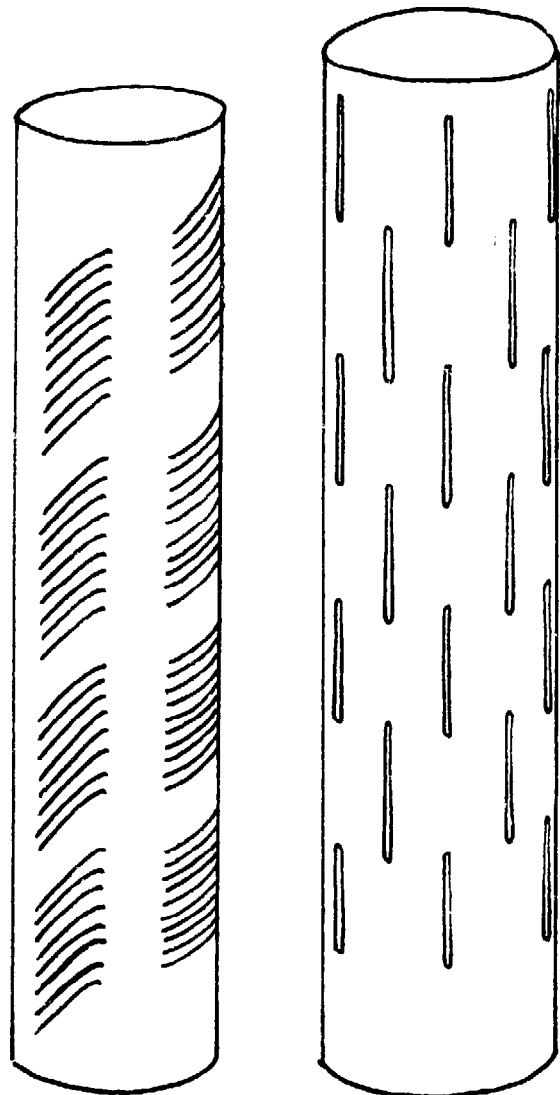

FIG. 15-2. LOCALLY MADE SLOTTED PLASTIC PIPE

1. Screen Material

Materials that are suitable for use as casing can all be modified for use as well screens by making holes in them.

- Commonly used materials such as steel or galvanized steel are suitable and often available, and can be driven into place where necessary. The quality of the water should be carefully checked for the possibility of corrosion or incrustation. Note that galvanized steel is only coated on the outside, so that once holes are made in it it is no longer protected from rusting. This is a serious consideration because well life spans have been as little as three months in areas where steel casing was used in highly corrosive water.

- Plastic such as PVC and ABS is very useful for screen production where driving is not necessary. Or, alternately, the casing and the screen can be bailed down under constant downward pressure. Holes are easily cut into plastic, the material is so lightweight that it may be possible to lower it by hand. It will not corrode and is usually significantly cheaper than steel.

- Clay is another possibility. Clay pipe locally made and fired should be made with socket and joint fittings to enable certain location and prevent unwanted surface water entry. They are most successfully used where the hole is completed all the way to the bottom before the screen and casing installation.

(See Fig. 15-3.)

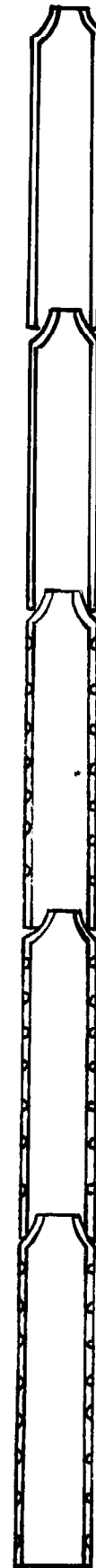

FIG. 15-3.
CLAY PIPE
CASING AND SCREEN

- Wood has been used in some temporary wells. In these cases, long straight sections of tree trunks have been used for casing and for screens. If you must for some reason use wood, cut the screen openings lengthwise with the grain for greater strength.

- Bamboo, where it is available, has been used for casing and screens in wells whose life expectancy is only a few years. With the inner sections punched out, it can be made into a servicable pipe. Screens can be made in two ways. Long pieces of bamboo can be split lengthwise, arranged around circular spacers and wrapped with rope, (See Fig. 15.4) or narrow lengthwise slits can be cut with a circular saw in a solid piece of bamboo. As the bamboo gets wet, these slits will become smaller, an advantage in a well screen.

- All of the materials mentioned above have some limitation which makes them inappropriate in certain situations. Steel is easily corroded. Plastic will deform under too much stress. Clay is easily broken. Bamboo and wood will rot and taint the water. Some materials, such as stainless steel, can be used in almost any situation but they are usually expensive.

2. Screen Length

Most small capacity well screens are between one and three meters long. The determining factor is the amount of open area (the area of all the holes added together) that will permit water to enter. Two or three meters of locally made well screen will usually be sufficient while one meter of commercially produced continuous slot well screen is more than sufficient for use with a hand pump.

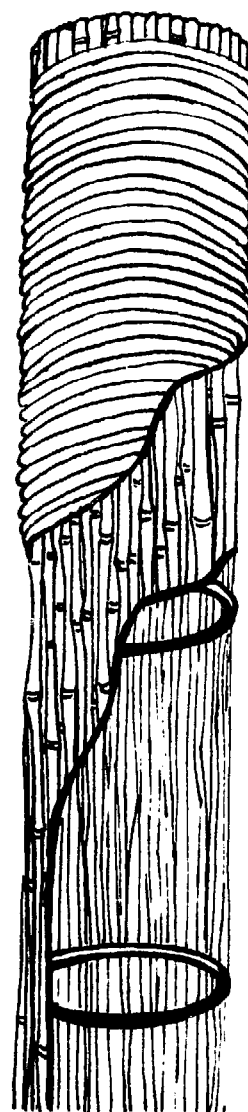

**FIG. 15-4.
BAMBOO
WELL SCREEN**

To check whether your screen is long enough:

- Determine the total amount of hole space in the screen. Assuming the holes are all approximately the same size and shape, you can figure out the area of one hole and multiply that figure by the number of holes.
- Next, estimate the maximum short-term demand for water. To do that, answer the question: How fast can someone possibly remove water from the well? That will be expressed in liters per minute or gallons per minute.
- Divide the first figure by the second figure. The screen should have at least 5.5 cm² for each liter of water per minute, or 3.23 in² for each gallon per minute, that can be taken from the well. These are absolute minimum figures. A greater area will be much better for well screens made of locally available materials.

3. Screen Diameter

When the screen is made of the same material as the casing, it will be the same diameter as the casing. It is simply a normal section of casing with holes.

It would be possible to make the screen a larger or smaller diameter than the casing and still firmly attach it to the casing by using reducing couplings or bushings, but there appears to be no advantage in doing so. If increasing the diameter would increase the amount of water that would flow into the well, it might be useful, but the increase in water flow with an increased diameter is so small as to make it insignificant.

4. Opening Size

This is probably the most difficult technical aspect to deal with because it is often just not possible to make your own screen openings as small as they should be.

Ideally, the openings should be big enough to allow the smaller particles of the surrounding soil through and yet hold out the larger soil particles.

5. Opening Shape

Generally the most effective opening shape is a long thin slit, easily made with a saw. This provides the greatest amount of open area in a small space and is not easily clogged. Small round or square holes, on the other hand, are more easily clogged and require more construction time. Depth and cross-sectional shape can also be important but can only be effectively dealt with in commercially manufactured screens. (See Fig. 15-5.)

6. Arrangement of Openings

Make and arrange the screen holes both to maintain material strength and also to permit the greatest flow of water.

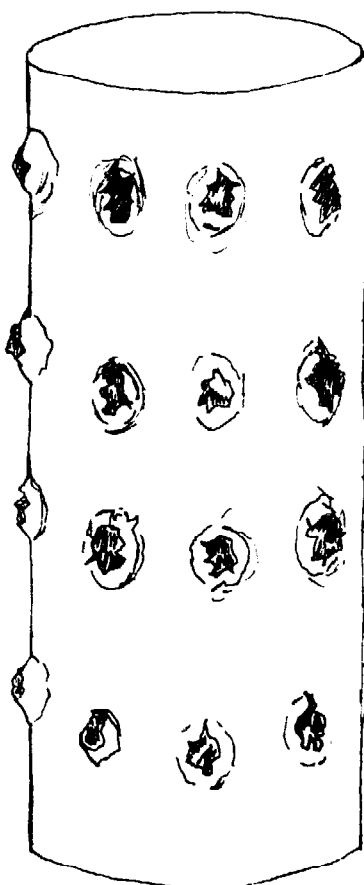

FIG. 15-5. PUNCTURED METAL CASING USED AS WELL SCREEN

7. Location of the Screen in a Water Bearing Formation

Ideally, the screen should rest on the bottom of the water bearing layer and extend up from there. Often, however, it is not possible to sink the well that deep with hand powered equipment. In that case, the screen should be placed as far into the water bearing layer as possible. Some well construction specialists suggest that 6 to 7 meters is deep enough beneath the water table to assure adequate year-round yield. However, this will vary depending on several factors that are not easy to evaluate, such as aquifer permeability and surface recharge. (See Glossary.)

In some cases, the aquifer will be made up of layers of different kinds of soil. If sufficiently deep into the aquifer, the coarsest layer will produce the most water and, therefore, that should be where the screen is set.

G. Installation of Well Screen

There are two different general techniques for setting the screen in place in the hole. In the first, the screen is attached to the bottom of the casing and

lowered into place with casing. In the second, the screen is telescoped through a casing that is already in place. Telescoping screens into place is a difficult procedure to complete successfully with only locally available materials. (See Fig. 15-6.)

Here are four possible approaches to setting a well screen and casing in place.

1. The casing and the screen can be lowered into a hole that is already sunk to the finish depth in the aquifer. This is only possible where the hole will stay open long enough to allow the screen and casing to be lowered into place, i.e., non-caving formations and where drilling mud has been used. In cases where minor caving will occur, it may be possible to drill the hole a little deeper than necessary so that caving material will accumulate below the level of the screen and not interfere with its installation. Where this will not work, another method of screen and casing installation must be used. Any appropriate casing material can be used because no particular strain is put on the casing while lowering it into place. With sections of clay pipe, for example, where one end fits inside the end of the next sections, the sections can even be lowered and placed one at a time. (See Fig. 15-7.)
2. The casing and the bottom screen can be sunk into their final position by operating a bailer inside the casing and screen to remove soil and allow the casing to sink. This method can be used to loosen caving soils which will not permit the hole to remain open. It is also employed in harder clay type soils although it will quickly reach a point where the casing will no longer sink because of too much friction with the surrounding ground material. It is useful where the casing is made of a material such as plastic that cannot be driven but can be helped along by adding weight to the top of the casing. When the desired depth is reached, the open screen bottom must be plugged. (See Fig. 15-8.)

and out of holes in the well screen. This in and out water motion tends to loosen the adjacent soil and carry with it through the screen openings all particles which are small enough to fit through them. Only the largest soil particles are left, deposited next to the outside of the screen. Farther from the screen, the predominant soil particles become smaller and smaller. (See Fig.10-5.) When development is complete, a graded soil filter surrounds the screen, which both prevents the entry of small soil particles into the well and allows the water to flow as freely as possible toward the screen. This is possible because there are gradually more open spaces for the water to flow through as it gets closer to the screen.

The time required for development depends on the nature of the water bearing layer, the opening size of the well screen as related to aquifer particle size, and the type of equipment and degree of development desired.

2. Methods

a. Overpumping

This is probably the simplest method of removing the "fines" from the water-bearing formations. The well is pumped at a faster rate than normal until no more fine aquifer particles are removed with the water. While this does not really agitate the soil enough to create a real filter around the screen, overpumping is a useful technique. If a well will support overpumping, it should certainly operate at a capacity less than that with no problems.

It is strongly recommended that if a well is to be developed by overpumping, a separate pump should be used for the development process. Fine soil particles to be removed during development can cause an abnormally high rate of wear on the pump resulting in early pump failure.

b. Backwashing

This, too, is a relatively simple method of development which requires a water lifting device and a container in which water can be stored and then from which it will be allowed to flow easily back into the well. This involves pumping water to the surface and then letting it flow back into the well many times. The process provides a back and forth motion that can more effectively develop a water-bearing formation than overpumping. However, in many cases, the motion may not be strong enough to obtain maximum development.

Backwashing is more difficult to accomplish than might be expected. The water lifting device used to pull water to the surface may have to be completely removed from the hole to permit water to flow back down. Water will not flow back down a pump riser pipe because there is a foot valve at the bottom designed to prevent that. It must then flow down between the pump pipe and the casing. An exception is a turbine pump which will pump water without a foot valve, but these are expensive. Note, however, that even a little backwashing is better than none.

c. Surging

Surging is the most common method of well development. It involves forcefully moving water back and forth, in and out of the well screen, to remove the fine soil particles. The surging action is caused by a tool being lowered into the well casing to some depth beneath the water level where it is then moved up and down, causing the water to move back and forth. The closer the tool seals to the well casing, the more forceful the surging action can be.

There are a variety of tools that have been used to give this surging action.

- Bailer: If an open bottom screen is sunk into the water-bearing layer by bailing, the bailer's up and down motion also causes a surging action which will develop the area around the screen. The heavier the bailer is, the better it is, because it then has more force to push water back out of the screen. A bailer may operate more effectively for this purpose if it has accumulated soil, making it heavier and in some cases preventing water from coming up through the casing. A bailer can also be used to develop a formation once the well screen is already in place. Because bailers cannot form tight seals with the inside casing walls, they do not usually develop a formation as well as a surge block. (See below.)
- Swab: A swab is simply a series of rags carefully tied around a pipe and built up until they will fill the casing pipe. This is then lowered down into the water and operated in much the same way as a bailer.

- Surge block: A surge block is basically a flat seal that closely fits the casing interior and is operated like a plunger beneath the water level. Because it seals closely to the casing, it has a very direct positive action on the movement in the well. There are two basic types of surge plungers, solid and valve type. Both can be easily made from fairly readily available local materials. (See Fig. 15-11.)

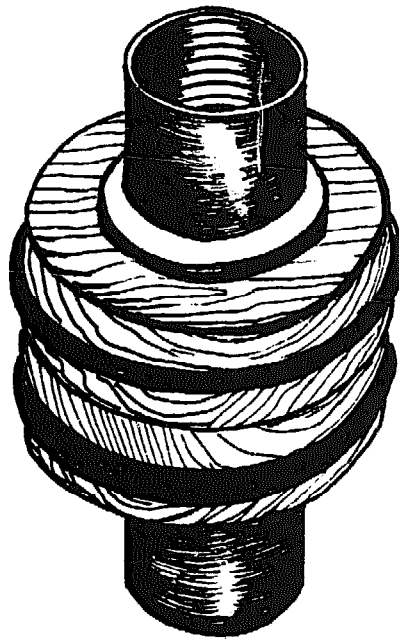

FIG. 15-11.
SOLID TYPE SURGE PLUNGER

A valve type surge plunger is made the same way as a solid type plunger but with two additions. Before assembly, several holes are drilled through the wood pieces and the sealing rings in such a way that they will all line up when the plunger is assembled. During the assembly a flexible sealing flap, with the same diameter as the wood, is added between the top wood piece and the metal washer. This acts as a flap valve over the holes that have been drilled through the rest of the plunger. (See Fig. 15-12.)

The action on the down stroke of a valve type plunger is milder than that of a solid plunger because some water will pass up through the holes in the plunger and may possibly be pumped to the surface by the up and down plunger action if the plunger seals well with the casing.

Surging Operation

- Arrange and install necessary tools and equipment in an appropriate place. A plunger or swab will need to be beneath the water level.
- Apply an up and down motion, repeatedly raising and dropping the plunger 60 to 100 cm. The plunger should drop rapidly on the downstroke either as a result of being forced down or because of the weight of the connecting shaft.
- Surge for several minutes, then remove the plunger and use a bailer or sand pump to remove the accumulated fine particles. Be careful not to surge too long. If you do, the screen will fill up with so much fine material that only the upper portion of the screen can be developed.

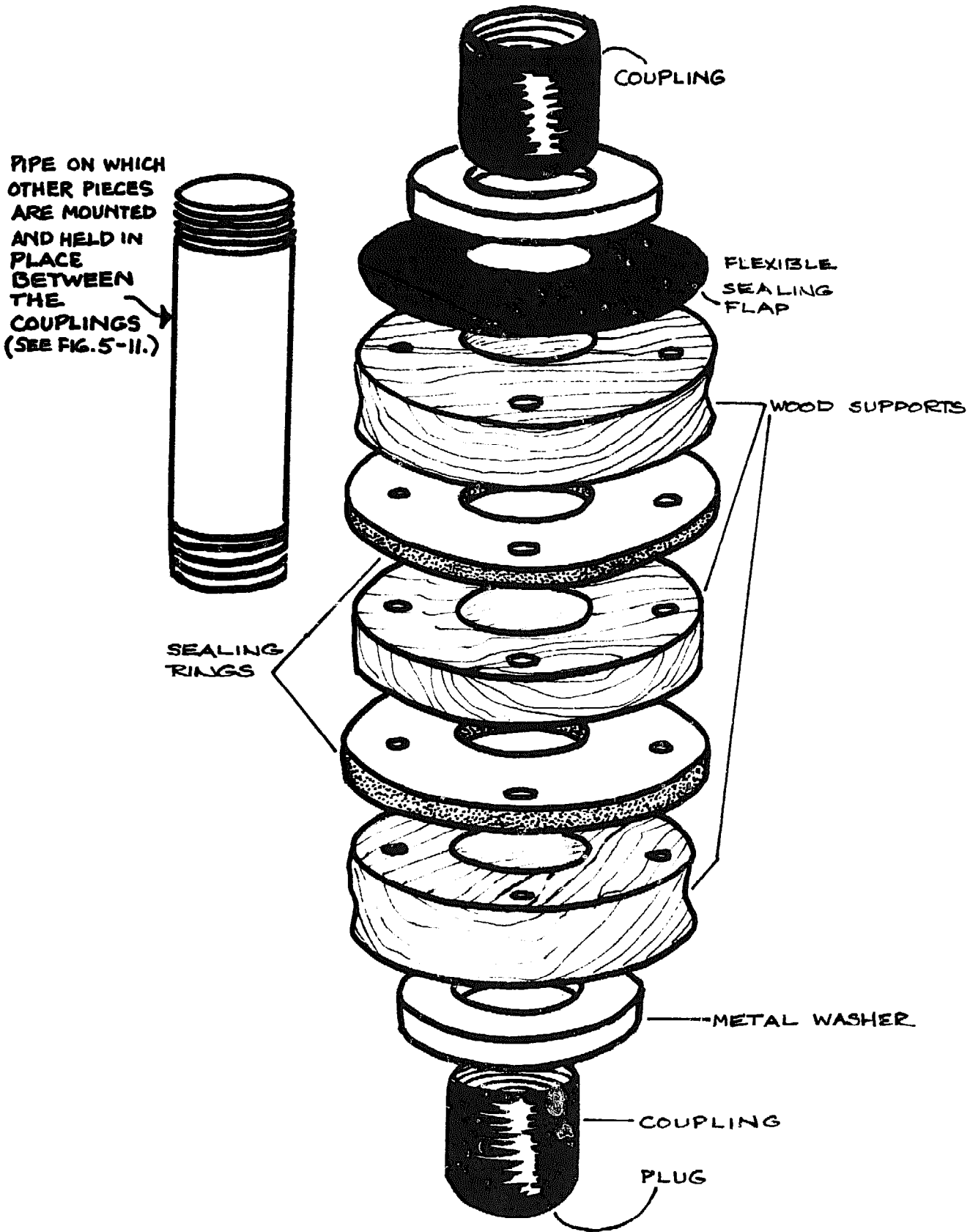

FIG. 15-12

EXPLODED VIEW OF VALVE TYPE SURGE PLUNGER

A solid type surge plunger can be made from the same materials. Leave out the flexible sealing flap and do not drill holes through the wood supports and sealing rings.

- Continue surging and bailing until no more fine particles are removed with the water. The up and down motion of the plunger should at first be relatively slow and continue that way until the amount of fine material drawn into the well begins to decrease. The speed should then be gradually increased and each surging session should become longer and longer.

Exactly how long and how fast surging takes place will depend on how much material is being brought into the well, the ease with which it is brought up, and the kind of equipment you have.

Adding some kind of weight to the plunger or the connecting shaft will probably make it easier to work for a longer period of time, especially if you can use a rope and pulley to lift and then drop it in the well. If you can add some weight it is best to add it as close above the plunger as possible.

NOTE: It is a good idea to make the operating shaft long enough so that if it is dropped down into the well some of the shaft will still stick up above the casing to help in its removal.

APPENDICES

Appendix I

CONVERSION FACTORS AND TABLESLength

Inch (in.) = 2.54 cm.
 Foot (ft) = 12 in. = 30.48 cm
 Yard (yd) = 3 ft = 0.9144 m
 Mile = 5280 ft = 1.609 km
 Centimeter (cm) = 0.3937 in. = 0.01 m
 Meter (m) = 100 cm = 3.281 ft = 1.0936 yd
 Kilometer (km) = 1000 m = 0.6214 mile

Area

Square inch (sq. in) = 6.452 cm²
 Square foot (sq. ft) = 144 sq. in. = 929.0 cm²
 Acre (43 560 sq. ft.) = 0.4047 ha
 Square mile (sq. mile) = 640 acres = 2.590 km²
 Square centimeter (cm²) = 0.155 sq. in
 Square meter (m²) = 10 000 cm² = 10.764 sq. ft
 Hectare (ha) = 10 000 m² = 2.471 acres
 Square kilometer (km²) = 100 ha = 0.3861 sq. mile

Volume and Capacity

Cubic inch (cu. in.) = 16.387 cm³ or ml
 Cubic foot (cu. ft) = 1729 cu. in. = 28.316 l = 6.229 Imp.
 gal = 7.481 US gal
 Cubic yard (cu. yd) = 27 cu. ft = 0.7646 m³
 Fluid ounce (British) (fl. oz.) = 28.41 ml
 (US) (US fl. oz.) = 29.57 ml
 Pint (British) (pt) = 20 fl. oz. = 0.5682 l
 (US) (US pt) = 16 US fl. oz. = 0.4732 l
 Quart (British) (qt) = 2 pt = 1.1365 l
 (US) (US qt) = 2 US pt = 0.9463 l
 Imperial gallon (British) (Imp. gal.) = 277.42 cu. in. = 1.20
 US gal. = 4.546 l
 US gallon (US gal.) = 231.0 cu. in. = 0.8327 Imp. gal = 3.785 l
 Acre-foot = 1233.5 m³
 Cubic centimeter (cm³) = 0.999972 ml = 0.06102 cu. in.
 Mililiter (ml) = 1.000028 cm³ = 0.03520 fl. oz.
 Liter (l) = 1000 ml = 0.2200 Imp. gal. = 0.2642 US gal.
 = 0.035316 cu. ft
 Cubic meter (m³) = 1000.028 l = 1.3080 cu. yd = 220.0 Imp. gal
 = 264.2 US gal = 0.0008107 acre-foot

Weight

Grain = 0.06480 g

Ounce (oz.) = 437.5 grains = 28.35 g

Pound (lb.) = 16 oz. = 0.45359 kg

Stone = 14 lb. = 6.350 kg

Hundredweight (cwt) (British) = 112 lb. = 50.802 kg

(US) = 100 lb. = 45.359 kg

(Long) ton (British) = 2240 lb. = 1.01605 t

Short ton (US) = 2000 lb. = 0.90718 t

Gram (g) = 15.432 grains

Kilogram (kg) = 1000 g = 2.2046 lb.

Metric ton (t) = 1000 kg = 0.9842 long ton = 1.1023 short tons

ft³ water = 62.4 lbs.

1 liter water = 1 kg

Pressure

Pound per square inch (p.s.i.) = 0.06805 atm. = 0.07031 kg/cm²

= 0.7031 m of water = 2.307 ft of water

Standard atmosphere (atm.) = 14.696 p.s.i. = 1.0332 kg/cm²

Metric atmosphere (kg/cm²) = 14.223 p.s.i. = 0.9678 atm.

Flow rate

Cubic foot per second (cu. ft/sec) = 0.5382 mgd (Imp.) =

0.6463 mgd (US)

Cubic foot per minute (cu. ft/min) = 0.4719 l/sec

Imperial gallon per minute (Igpm) = 0.7577 l/sec = 0.2728 m³/h

US gallon per minute (gpm) = 0.06309 l/sec = 0.2271 m³/h

Million gallons per day (mgd) (Imperial) = 52.615 l/sec

(US) = 43.811 l/sec

Liter per second (l/sec) = 3.6001 m³/h = 13.20 Igpm = 15.85 gpm

= 0.019006 mgd (Imp.) = 0.022825 mgd (US)

Cubic meter per hour (m³/h) = 0.2778 l/sec = 3.666 Igpm

= 4.403 gpm

Filtration rate

Million Imperial gallons per acre per day (mgad, Imp.) =

1.1234 m³/m²/day

Million US gallons per acre per day (mgad) = 0.9354 m³/m²/day

Cubic meter per square meter per day (m³/m²/day) = 0.8902 mgad, Imp.
= 1.0691 mgad

Miscellaneous

Horsepower (h.p.) = 33 000 foot-pounds per minute = 0.746 kW

= 1.0139 CV

Kilowatt (kW) = 1.36 CV = 1.34 h.p.

Cheval-vapeur (CV) = 0.9863 h.p. = 0.736 kW

One liter of water weighs one kilogram (at 4°C)

One cubic foot of water weighs 63.43 pounds

One US gallon of water weighs 8.345 pounds

Appendix II

VEGETATION AS AN INDEX OF GROUND WATER

The presence of certain species of vegetation can be a useful indication that ground water or soil moisture lies relatively close to the land surface. These plant indicators are most obvious in arid parts of the world, where green vegetation stands out, but the principle of using plant species as an index to locate ground water near the surface is equally useful in humid countries. The best relationships are found between certain groups of plants (called plant associations) and the depth of ground water or the salinity of water. In North Africa, for example, research has identified various plant associations (usually three to four main species per association) and their relationship to ground water depth and salt content of the water. The presence of certain trees and shrubs, for example the "salt cedar" type trees (*Tamarix* species), indicates salty water. Similarly, in the arid western U.S., *Tamarix* species, cottonwood trees, willows and other plants are associated with shallow ground water tables.

Plants whose roots actually tap the ground water are called "phreatophytes." Due to their high transpiration rates in arid zones, the phreatophytes can "pump out" a small stream or lower the level of a well. This transpiration loss could be of concern if, for example, many trees or other deep-rooted plants are planted around a well for shade or to stabilize sand in a dry, windy setting. High transpiration by the plants also can increase the salt concentration in the well water.

In arid zones, the perennial plants, especially trees and shrubs, are the most useful indicators of ground water. Annual plants, mainly legumes and grasses, are generally not good indicators since they come and go depending on rains and the season of the year.

Generally surveys of vegetation to help find shallow ground water are most effective if carried out in the dry season.

It would be useful at this point to present a table of plant species and plant associations, country by country. Unfortunately this information is not available for most countries, at least not in published form. Even if feasible,

a list of all the plant species would be much too large. Finally, most people would need plant pictures and descriptions to accompany the names. You will therefore have to make the effort locally to determine the local plants which are good indicators of ground water. Sources of possible information include experienced well diggers or drillers in the area; water resource engineers; in rare cases, published reports (e.g., old FAO reports); and research station or university botanists. In many cases the necessary information can come only from interviews with these local sources of information.

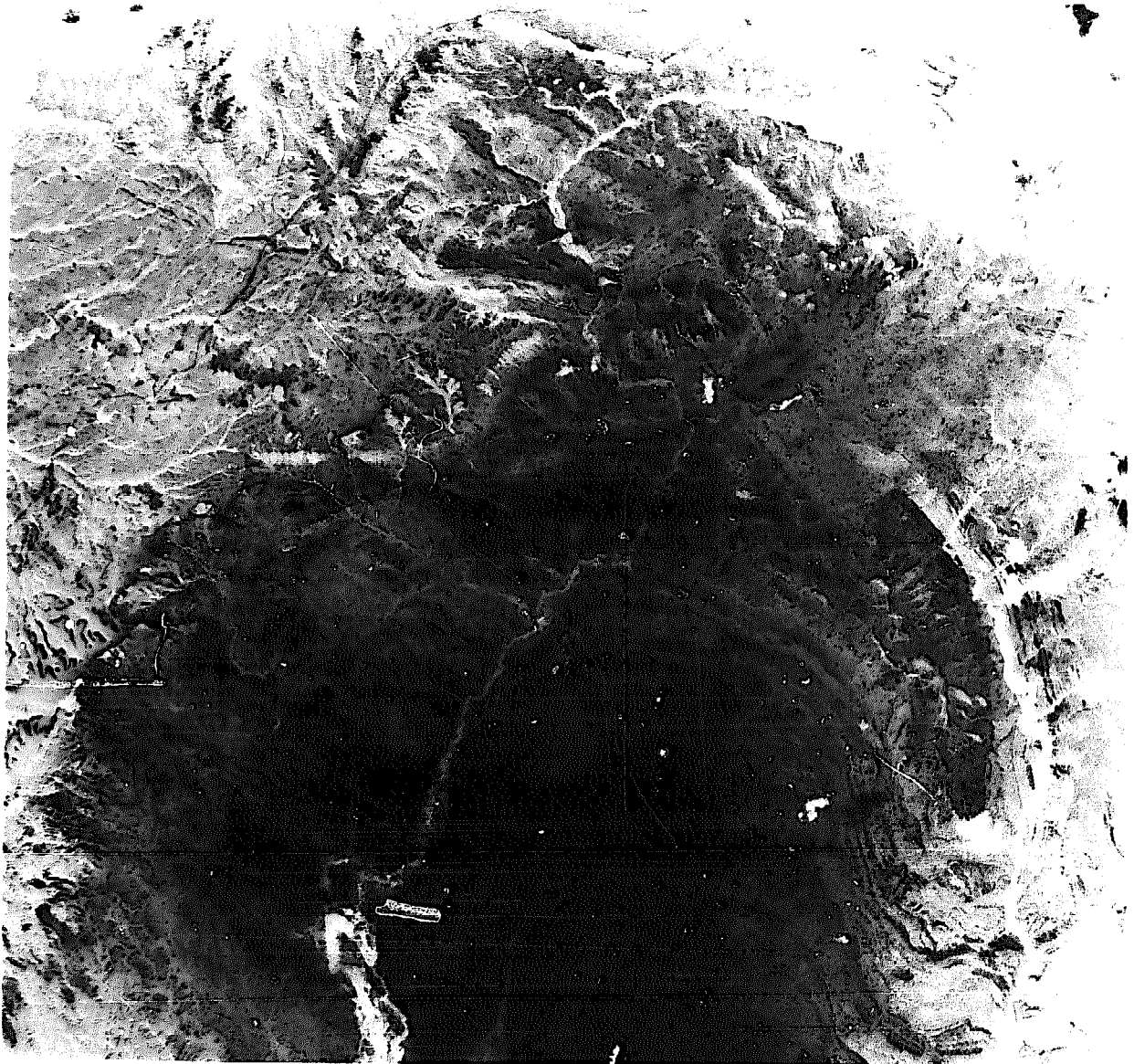

Satellite photos such as this one illustrate how vegetation cover (darker areas) can be used to locate subsurface water. Write to U.S. Geological Survey, EROS, Sioux Falls, South Dakota, 57198 to request the General Information Packet giving additional background and how to obtain photos for your area.

Appendix III

USES OF DYNAMITE IN HAND DUG WELLS

This article by Christopher Henney was written as an overview of the uses of dynamite in the Peace Corp/Togo wells construction program.

It is reprinted from the Action/Peace Corps P&T Program and Training Journal (Special Issue: Wells Manual) published by the Peace Corps in 1974.

PART I: Obtaining it**When to use dynamite**

When and if you encounter a hard rock layer and there is NO OTHER WAY to break it in order to attain the aquifer, then dynamite is in order. Of course, you could move the well site, but in some regions this probably would not make much difference. Never use dynamite before it is absolutely necessary as villagers will immediately start to rely on it as soon as the going gets rough. It is very difficult to stop using it once you have started. Dynamite in an old well or using dig-a-meter-pour-a-meter method. Start with small charges and deep blast holes and try to leave 50 cm between caissons and rock.

How to get it

Because it is an extremely dangerous substance and can be used for sabotage or other crimes, most governments are very cautious about whom they give permission to use dynamite; thus one's procedure for obtaining it should always be through all necessary official channels. In Togo this generally means:

- 1) Chef-Cir
- 2) Travaux Publics
or Assainissement
- 3) Interior Ministry
- 4) An authorized dealer

First you get your Chef-Cir to address a "demande de permission d'achat" permission to buy request to the Minister of Interior. This will state quantity and type of dynamite plus quantity and type of detonators. What purpose it is to be used for and where; where it will be kept, and by whom. Attached to this should be an agreement of your local boss; in my case the Engineer of Assainissement, Sokode. This letter will then be transmitted to Lome (the capital) and will be returned as a letter of permission to the bureau of the Chef-Cir. He will give it to you. Remember this permission expires after six months, so use it immediately. With this letter you then

go to Lome and order the dynamite and detonators from Brossette et Valor (an authorized dealer). This could take time as it must come from France. So plan 6 months ahead.

Another option is to have Travaux Publics-Service Hydraulique order it for you when they order theirs. Especially if you only want one or two cases. This is because Brossette requires a minimum order of three cases unless you want to wait until it can be attached to someone else's order. This also has the advantage of free transport up-country. It is not always easy to get a transporter to carry high explosives.

WHAT TO ORDER:

The Dynamite

There are a number of kinds of dynamite or explosives adaptable to wells. And the choice is probably best made with expert help. Service Hydraulique is your best bet or Service des Mines. After using three different types and talking to a number of people, I decided on the type known as "Gomme A" Tolamite. This is a redgelatinous substance rolled into 50 grms. packages by means of wax paper. It is waterproof and malleable. The gases it releases upon ignition are non-toxic (although they may irritate lungs, but I will get to that later) and the stuff won't go off if bumped, smashed, dropped, etc. The malleability is important as sometimes you want to squeeze it into a crack like toothpaste. I generally figure quantities on this scale:

1 charge = 50 or 100 grms. dynamite

<u>Meters</u> <u>depth of</u> <u>rock</u>	<u>Diameter</u> <u>of well</u>	<u>Quantities</u>	<u>Number of</u> <u>blast holes</u>
1 METER	1 meter \emptyset	12 charges	3
1 METER	1 meter 25 \emptyset	10 charges	5
1 METER	1 meter 40 \emptyset	24 charges	6
1 METER	1 meter 80 \emptyset	28 charges	7

This should be more than adequate; usually it takes two rounds of explosions to do a meter although this depends on the depth of the blast holes and the hardness of the rock. Normally your local water bureau or Travaux Publics will be able to tell you how deep you will have to blast. One case of dynamite weighs about 25-30 kg.

The Detonators

For each three charges, you will need two detonators. This will insure an adequate supply. Make sure they are electrical firing detonators. Fuses are dangerous and should not be used. The best kinds are type B66 low intensity, total resistance 1.5-3 ohms, medium 2 ohms. Make sure the wires are 2 m long.

In general both dynamite and detonators have an expiration date. So make sure you don't get an old batch, because it may be unstable and therefore DANGEROUS.

Where to Store and How

The storage of dynamite is most important for your own health and that of others. Don't keep it at home as you may have kids or other curious people around. Personally, I prefer to keep it at the local gendarmerie, police or travaux publics. This has a number of advantages:

- a) You cannot be accused of sabotage for political reasons
- b) If you work on weekends, you can get it at the first two places
- c) If there is an accident, you are not around or responsible

Keep detonators away from dynamite, if possible at the other side of a locked room and in a case. Never let dynamite and detonators come into contact until you are ready to use them. Remember a good shock can set off the detonators, and detonators can blow your hand off. Keep tabs on how much you have and how much has been used. If you cannot keep it at the above mentioned locations, make sure you have a good store room with lock and the only key in your possession.

How to Carry to your Site (If You Must)

If you don't want to keep it at the site because there is no adequate store room or you have many sites and prefer to bring it in when needed from a central store, then you must decide how it will be carried. I personally don't like this as there is a small amount of risk involved; but I did it for over six months. Anyway, if you follow certain simple rules, you should be all right.

- 1) Keep detonators and dynamite in separate waterproof sealed cans -- The detonators preferably in a plastic one.
- 2) Keep the batteries or exploder somewhere else in your pack and separate from the detonators. This will insure you except if you get hit by lightning or squashed by a truck, both of which are very real dangers. A normal crash because of sand, etc., should cause you no problems. (I had two).

PART II: How to Use

Rules for Use in a Well

The use of dynamite follows a couple of rules of thumb:

- a) Use common sense
- b) Don't use more than needed to get the job done
- c) Make sure the site is cleared of people

- d) Keep children away from site at all times
- e) Get someone else to trigger it
- f) Don't let anyone else handle dynamite or detonators
- g) Keep the batteries in your pocket or pack until you are out of the well and the site is cleared
- h) Check whether all charges went off (see Part III)
- i) Never send someone else to get dynamite or detonators from the store room
- j) Never go down in a well containing unfired charges unless you have secured the batteries
- k) Place the charges yourself.

Rules a, b, c, d, g, j are constants, but e, f, i, k are changeable if you have trained a competent person to do the job. But no matter what happens, you will always be held responsible.

Tools You Need

Assuming you are working on a village level and you don't have a jack hammer (compressor), you will need:

- 1) Mining bar
- 2) 75 meters of extension cord flex
- 3) 1 roll of insulation tape
- 4) 1 flat file (to sharpen mining bar)
- 5) 5 flash light 1.5 volt cell batteries, size D
- 6) Dynamite and detonators
- 7) One 2-meter spoon

How to Place Charges

As I have said before, the number of charges is in proportion to the depth of the blast holes and the diameter of the well. A good rule of thumb is two charges per hole (blast hole) and:

- 3 holes for 1 m \emptyset
- 5 holes for 1 m 25 cm \emptyset
- 6 holes for 1 m 40 cm \emptyset
- 7 holes for 1 m 80 cm \emptyset

but depending on the rock, you may have three charges per hole (or one). Never blast if your holes are not deep enough. It is a waste of dynamite. The blast holes should be at least the length of a man's arm, 80 cm and preferably more. The deeper the better. Blast holes should always be in the most protruding places.

Figure A.

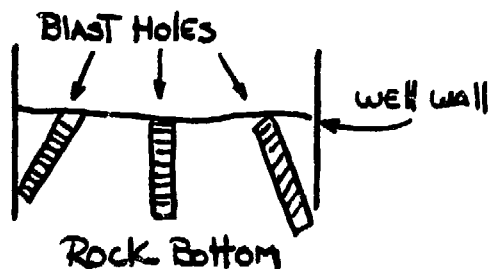

Here is a good diagram of where to place them in general:

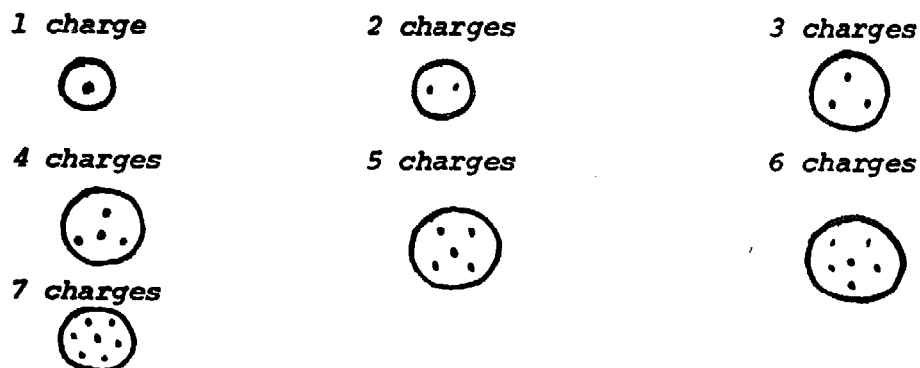

The charges toward the outside walls of the well should slope out as in Figure A and in the case of 4 - 1 charges.

How to Make up Charges

There are two methods that I use: placing side by side, or one on top of the other.

Figure B.

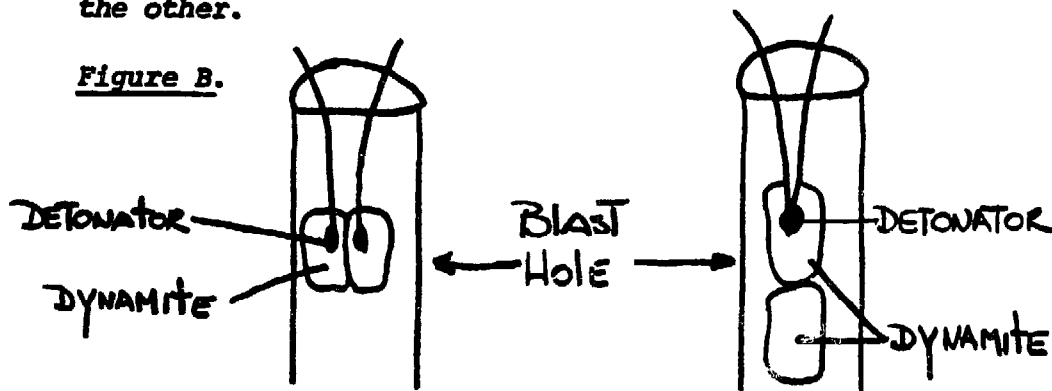

I prefer the side by side method where the hole is large enough. This is done by unwrapping the wax paper around the dynamite and sticking the two charges together, then rewrapping. The detonator is then inserted until completely inside the dynamite. This method has the advantage of never having only one charge go off because the other got covered by mud and separated from the first charge as in the one on top of the other method. But in really hard rock it is sometimes not always possible to make the blast hole wide enough. The one on top method is also better for really deep holes as you can put 3-4 charges in with no difficulty. I might also mention that the tighter the fit of the dynamite, the better blast you are going to get. Once the dynamite is in the hole with the detonator securely in the dynamite, pack the hole with damp sand. And pack the sand with a stick so it is well in and well packed.

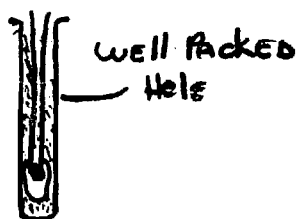

Figure C.

Don't pussy-foot but don't pound as if you were driving railroad spikes. This insures that the dynamite has something to push off on and that the gas does not escape out the open hole. Never fill your hole up to the top with dynamite. This just is a noisy waste.

If you have more than one charge as you will most of the time, you must hook them up in series. Each detonator has two wires, on one will be a flag.



Now in order to hook up a series, you must hook flag to non flag of another charge:

This leaves you with one flag and one non flag which is then attached to the extension cord that goes above ground. Next collect your ends and tie them to the extension cord:

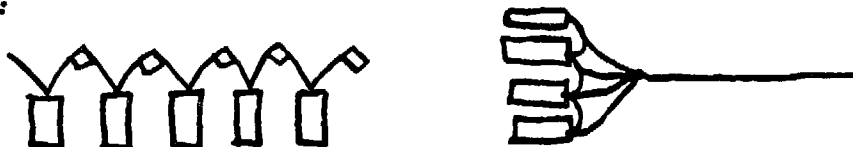

If you have four detonators, there should be five joints left out of the knot, and so on. Make sure these are separated so as not to cause a short circuit.

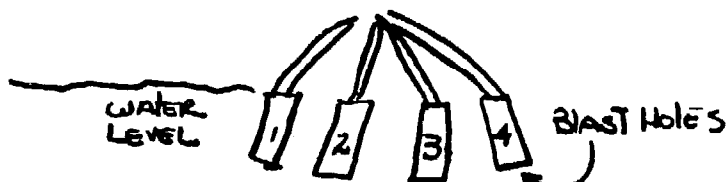

Also make sure that this knot is above the water level---Preferably as high as possible without pulling the detonators out - and that is easier than imagined even when the charges are packed in sand. Then get out of your well, being careful not to pull on the extension cord.

How to Dig the Blast Holes

Using the blade end of the mining bar, pound the rock. This must be done while continually rotating the blade so as to make a nice neat round hole. At intervals, add water to make a slurry - this is messy but necessary. After a bit, use the 2 meter long spoon to get out the dust and dirt made from pulverized rock; or if the hole is wide enough, use your hand. Never make holes wider than your hand (fist) as this is just wasteful of dynamite.

The sand will be blown out and little rock will be blasted. This is hard work and can take several days.

Ignition

To set off the dynamite, place the four or five batteries end to end and touch the two ends with the two ends of the cord. Make sure you do this firmly and keep the cord touching until you have counted five (even though the explosions will happen spontaneously). This could save you many hours of looking for live charges that did not go off. For 1-3 charges, four batteries. Add one battery for every additional charge; i.e. for 5 charges, 6 batteries; for 6 charges, 7 batteries, and for 7 charges, 8 batteries.

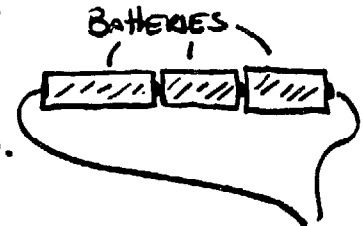

Before you fire, clear the site. Let no one stand nearer than 50 meters to the well. Let a Togolese do the firing. There are two reasons for this. If someone gets hurt you did not pull the trigger, and Togolese-American relations will not be upset. Also, you are needed to keep a sharp look out for falling rocks, impulsive children, or new arrivals. But if anything does happen, you will still be responsible for the site and though not legally, you will be held responsible in the eyes of the people you are working with.

Once the explosion has gone off wait a minute. You will often be surprised how long it takes rock to fall back to earth. Then pull up the extension cord and count the number of detonator wires. If all have gone off great, but if one is severed half way up, there is a chance it is still alive. Also, if there is anything holding the cord don't yank it up. This could well be the wire that did not fire, and by following it you will easily find the unfired charge instead of digging all over to find it. Now wait 15 minutes - half an hour until the smoke clears. You can choke to death by smoke inhalation even if the smoke is not toxic per se.

What to Do if a Charge does not go off

First, climb down and check your detonator wires. If one stays stuck, dig around it reasonably carefully. (If an explosion could not set the charge off, you would really have to try). There is not too much danger if you are careful. When you reach sand, pull the detonator out slowly, then dig out the charge. The charge is now harmless. Or you can also rewire the detonator, climb out, and fire it. If this does not work and you cannot extract the charge, put a new one in on top of it and fire that. This way your well is clean. Then send workers down but NOT until you have at least extracted the detonator(s).

The causes of unfired charges are:

- 1) A short circuit
- 2) A set of old batteries (no power)
- 3) Old detonators

After each explosion, check out your cable and patch or cut. Then place batteries at one end and the two wires on your tongue at the other end; if it tingles, all is well. Coil and put away. If not, find the short. Always do this after each explosion. It saves embarrassment when nothing goes off. You can work in up to 1 meter of water.

Recap of Procedure Rules

- 1) Only use dynamite where nothing else works.
- 2) Never use before it is absolutely needed, even when the work is hard.
- 3) Follow all official procedures in obtaining it.
- 4) Make sure it is not outdated stuff.
- 5) Never use fuses, always electric detonators.
- 6) Don't keep it at home, store safely.
- 7) Never send an inexperienced person to get it out of storage. Go yourself.
- 8) Keep dynamite separate from detonators and detonators separate from batteries.
- 9) Use commonsense (take all the risks that need taking yourself).
- 10) Don't use more than you have to.
- 11) Make sure the site is cleared of people.
- 12) Keep children away from site.
- 13) Get someone else to fire it while you watch.
- 14) Don't let others handle dynamite or detonators or batteries.
- 15) When you are in well, keep batteries in your pocket. This is your only insurance.
- 16) After explosion, check for unfired charges.
- 17) Never go after unfired charges unless you have secured the batteries.
- 18) Place all charges yourself.
- 19) Always pack some sand on top of a charge.
- 20) Make sure your detonators are wired properly and that the jointed ends don't touch.
- 21) Tie the wires to the cord.
- 22) Make sure knot is above water.
- 23) Don't pull on cord. You might extract detonators by accident.
- 24) Let no one stand closer than 50 m when you blast.
- 25) Touch batteries firmly. Count to five.
- 26) Check for dead charges yourself.
- 27) Wait for smoke to clear.
- 28) Check extension cable after each explosion.
- 29) Keep tools in good repair.
- 30) Remember you are responsible for your life and other lives.

PLEASE NOTE: Under no circumstance should dynamite be used unless an exhaustive study concerning its use has been conducted by experts who are knowledgeable in the use of dynamite.

GOOD LUCK AND TAKE CARE.

Appendix IV

CEMENTA. Introduction to Cement

Cement is one of the most useful materials in wells construction. It can easily be mixed with sand and water to make mortar or with gravel, sand and water to make concrete. Both mortar and concrete are among the strongest and most durable materials used for all types of construction around the world. Mortar is normally used as the bonding agent between bricks or rocks while concrete is normally reinforced with steel bars and molded to the desired size and shape.

For well work, mortar or concrete is usually the best material for the lining, headwall, platform and cover of dug wells, and the platform and seal around the top three meters of casing in drilled wells.

Cement is available in almost every country in the world and sand and gravel are usually available locally. Occasionally it will be difficult to get cement for wells construction either because there are other higher priority demands for the cement or because it just costs too much. It is impossible here to say how or even whether cement can be obtained in such a circumstance.

Of the two cement compounds, mortar and concrete, concrete is the stronger. This is because the rock that makes up the gravel itself is stronger than the concrete and so contributes to its strength. Sometimes the two can be used interchangeably where lack of materials or working conditions demand it. Remember that concrete is the stronger product and should be used where possible.

NOTE: The rest of the discussion in this appendix will deal specifically with concrete. The same procedures can and should be followed if mortar is used instead.

B. Ingredients of Concrete

Concrete is made from cement, sand, gravel and water. These ingredients are combined in certain proportions to achieve the desired strength. The amount of water used to mix these ingredients is by far the most important factor in determining the final strength of the concrete. Use the least amount of water that will still give you a workable mix. Sand and gravel, which are sometimes referred to as fine and coarse aggregate respectively, should be clean and properly graded. Cement and water form a paste which, when mixed, acts as a glue to bind the aggregates together in a strong hard mass.

1. Proportions:

- There are four major ingredients in concrete: cement, sand, gravel, water.
- Dry ingredients are normally mixed in certain proportions and then water is added. Proportions are expressed as follows: 1:2:4, which means that to one part cement you add two parts sand and four parts gravel. A "part" usually refers to a unit of volume. Example: A 1:2:4 concrete mix could be obtained by mixing 1 bucket full of cement with 2 buckets of sand and 4 buckets of gravel.
- Proportions are almost always expressed as cement:sand:gravel, and they are usually labelled that way.
- There are many minor variations in the proportions used for mixing concrete. The most commonly used are 1:2:4, 1:2:3, 1:2.5:5. For our purposes all work equally well.

NOTE: A 1:2:4 mix will go a little farther than the 1:2:3 mix and allows a little more room for using not the best sand or gravel than a 1:2.5:5 mix.

- Normal range for amount of water used to mix each 50 kg bag of cement is between 20 liters and 30 liters (94 lb. bag of cement is between 4.5 gal. and 7 gal.)

- The water-tightness of concrete depends primarily on the water-cement ratio and the length of moist curing. This is similar to concrete strength in that less water and longer moist curing promote water-tightness.

2. Choice of ingredients

- cement: The descriptions and properties given here are specifically of Portland cement. This is the type most commonly used and what we think of when we say cement.

When used, it should be dry, powdery and free of lumps. When storing cement try to avoid all possible contact with moisture. Store it away from exterior walls, off damp floors, and stacked close together to reduce air circulation. If it could be kept completely dry it could be stored indefinitely. Even exposed to air it will gradually draw moisture, thus limiting even the covered storage time to between 6 months and 1 year depending on conditions.

- water: In general, water fit for drinking is suitable for mixing concrete. Impurities in the water may affect concrete, setting time, strength, shrinkage or promote corrosion of reinforcement.

- aggregates: Fine and coarse aggregates together occupy 60 to 80% of concrete volume.

- fine aggregate: Sand should range in size from less than .25 mm to 6.3 mm. Sand from sea shores, dunes or river banks is usually too fine for normal mixes. (You can sometimes scrape about 30 cm of fine surface sand off and find coarser, more suitable sand beneath it.)

- large aggregate: Within the recommended size limits mentioned later, the larger the gravel you use the stronger and more economical the concrete will be.

- The larger the size of the gravel the less water and cement will be required to get the same strength concrete.

- The maximum gravel size should not exceed
 - one-fifth the minimum dimension of the member;
 - three-fourths the clear space between reinforcing bars or between reinforcement and forms. (Optimum aggregate size in many situations is about 2.0 cm.)

The shape and surface texture of aggregates affect properties of freshly mixed concrete more than they affect hardened concrete. Rough textured or flat and elongated particles require more water to produce workable concrete than do rounded or cubical aggregates and more water reduces the final strength of the concrete.

It is extremely important to have the gravel and sand clean. Silt, clay, or bits of organic matter in even low concentrations will ruin concrete. A very simple test for cleanliness makes use of a clear wide-mouth jar. Fill the jar about half full of the sand and small aggregate to be tested, and cover with water. Shake the mixture vigorously, and then allow it to stand for three hours. In almost every case there will be a distinct line dividing the fine sand suitable for concrete and that which is too fine. If the very fine material amounts to more than 10% of the suitable material, then the concrete made from it will be weak.

This means that other fine material should be sought, or the available material should be washed to remove the material that is too fine. This can be done by putting the sand (and gravel if necessary) in some container such as a drum. Cover the aggregate with water, stir thoroughly, and let stand for a minute, and pour off the liquid. One or two such treatments will remove most of the very fine material and organic matter.

Another point to consider in the selection of aggregate is its strength. About the only simple test is to break some of the stones with a hammer. If the effort required to break the majority of aggregate stones is greater than the effort required to break a similar sized piece of concrete, then the aggregate will make strong concrete. If the stone breaks easily, then you can expect that the concrete made of these stones will only be as strong as the stones themselves.

In very dry climates several precautions must be taken. If the sand is perfectly dry, it packs into a smaller space. If you put 20 buckets of bone dry sand in a pile and

stirred in two buckets of water, you could carry away about 27 buckets of damp sand. If your sand is completely dry, add some water to it or else measure by weight instead of volume. The surface of the curing concrete should be kept damp. This is because water evaporating from the surface will remove some of the water needed to make it properly. Cover the concrete with building paper, burlap, straw, or anything that will hold moisture and keep the direct sun and wind from the concrete surface. Keep the concrete moist by sprinkling as often as necessary; this may be as often as three times per day. After the first week of curing, it is not necessary to keep the surface damp continuously. (See p. 236.)

3. Making Quick-Setting Concrete

To produce quick-setting concrete with high initial strength, calcium chloride can be added to the mixture.

This will not affect the estimation of materials needed because the calcium chloride will be dissolved in the water used to mix the concrete.

Quick-setting cement is often useful for example, when repeated castings are needed from the same mold. A concrete mixture which contains calcium chloride as an accelerator will set about twice as fast as a mixture which does not. The mixed batch must be put into the forms faster, but since quick-setting batches are usually small, this is not a problem. Calcium chloride does not lessen the strength of fully-cured concrete.

No more than 1 kg (2 pounds) of calcium chloride should be used per sack of cement. It should be used only if it is in its original containers, which should be moisture-proof bags or sacks or air-tight steel drums.

The best way to add the calcium chloride is to mix up a solution containing 1/2kg per liter (1 pound per quart) of water. Use this solution as part of the mixing water at a ratio of 2 liters (2 quarts) per sack of cement

4. Estimating quantities of materials needed

1. Calculate the volume of concrete needed.
2. Multiply the volume of concrete needed by $\frac{3}{2}$ (1.5) to get the total volume of dry loose

material needed. The cement and sand do little to add to the volume of the concrete because they fill in the air spaces between the gravel.

3. Add 10% (1/10) for losses due to handling.
4. Add the numbers in the volumetric proportion that you will use to get a relative total. This will allow you later to compute fractions of the total needed for each ingredient. (1:2:3=6)
5. Determine the amount of cement needed by multiplying the volume of dry material needed (from step 2) by the proportional amount of the total mix (amount cement needed) = $1/6 \times$ (volume dry materials).
6. Divide by the unit volume per bag, 33.2 liters per 50 kg bag cement or 1 cubic foot per 94 lb. bag cement. When figuring the number of cement bags round up to nearest whole number.

NOTE: This calculation, even with the 10% addition for handling losses, rarely leaves any extra concrete, particularly for small jobs requiring less than 5 hand mixed bags of cement.

Here is an example:

- the volume of a cylinder = $\pi r^2 h = (3.1416) (\text{radius})^2 (\text{height}) = (3.1416) (\text{radius})(\text{radius})(\text{height})$
- the volume of concrete needed to build the lining and platform of the pictured well could be computed as follows (See Fig. IV-1).
- the volume of the lining and headwall would be the volume of the 20.8m high cylinder with a 0.7m radius minus the volume of the 20.8m high cylinder with a 0.6m radius.
- $V = [\pi (.7)^2 (20.8)] - [\pi (.6)^2 (20.8)]$
 $= [(3.1416) (.49) (20.8)] - [(3.1416) (.36) (20.8)]$
 $= 32.0 - 23.5$
 $= 8.5 \text{m}^3$

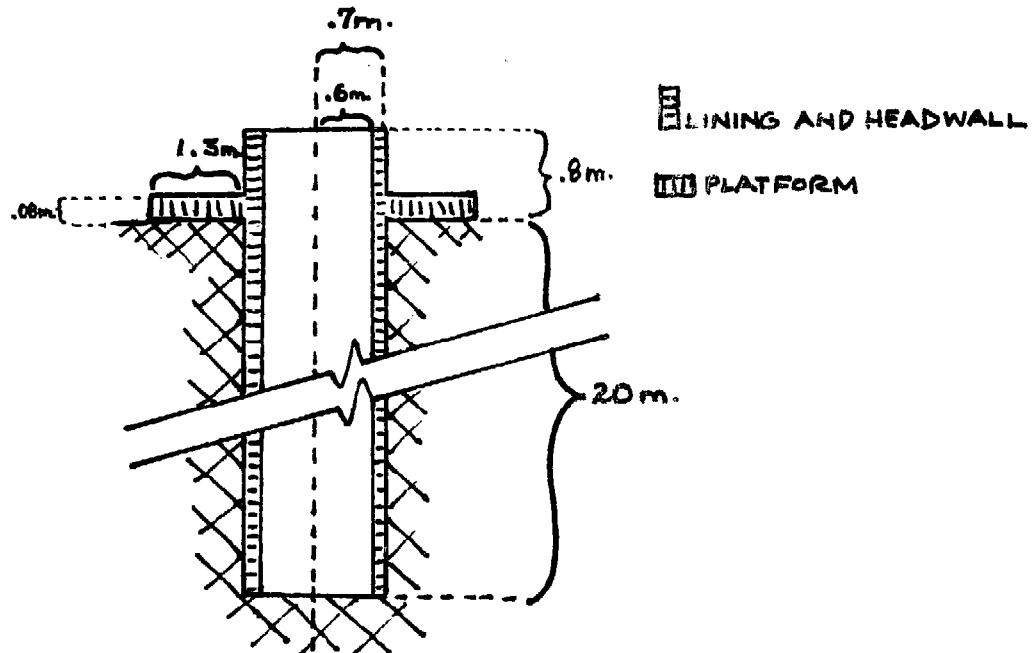

FIG. IV-1. CROSS SECTION OF TYPICAL WELL FOR CALCULATION OF CONCRETE NEEDS

- the volume of the platform would be the volume of the .08m high cylinder with a 2m radius minus the volume of the .08m high cylinder with a .7m radius.
- $V = [(3.1416) (2)^2 (.08)] - [(3.1416) (.7)^2 (.08)]$
 $[(3.1416) (4) (.08)] - [(3.1416) (.49) (.08)]$
 $= 1 - 0.1$
 $= 0.9 \text{m}^3$

Following the steps outlined above the volume of materials necessary to construct the well would be computed as follows:

1. total volume = $8.5 + .9 = 9.4 \text{ m}^3$
2. $(9.4)(1.5) = 14.1 \text{ m}^3$ dry material estimated
3. $14.1 \times 1.1 = 15.5 \text{ m}^3$ dry material necessary because of losses in transport.
4. 1:2:4 cement:sand:gravel $1+2+4=7$
5. $15.5 \times 1/7 = 2.2\text{m}^3$ cement
 $15.5 \times 2/7 = 4.4\text{m}^3$ sand
 $15.5 \times 4/7 = 8.9\text{m}^3$ gravel
6. 2.2m^3 cement = 2,200 liters (l.) of cement
 $2,200 \text{ l. cement} \div 33.2 \text{ l. per 50 kg bag cement} =$
 66.26 bags of cement
 67 bags of cement will be needed.

C. Construction with Concrete

1. Outline of Concrete Work:

- build form;
- place rerod;
- mix concrete;
- pour concrete;
- finish surface;
- cure concrete;
- remove forms.

2. Interior Well Forms

a. Introduction

An interior well form or mold is circular with a smooth exterior surface which will form the inside surface of the lining. This form can be used either on the surface with other forms to make lining rings or in the well to form a lining that is poured in place. (See Fig. IV-2.)

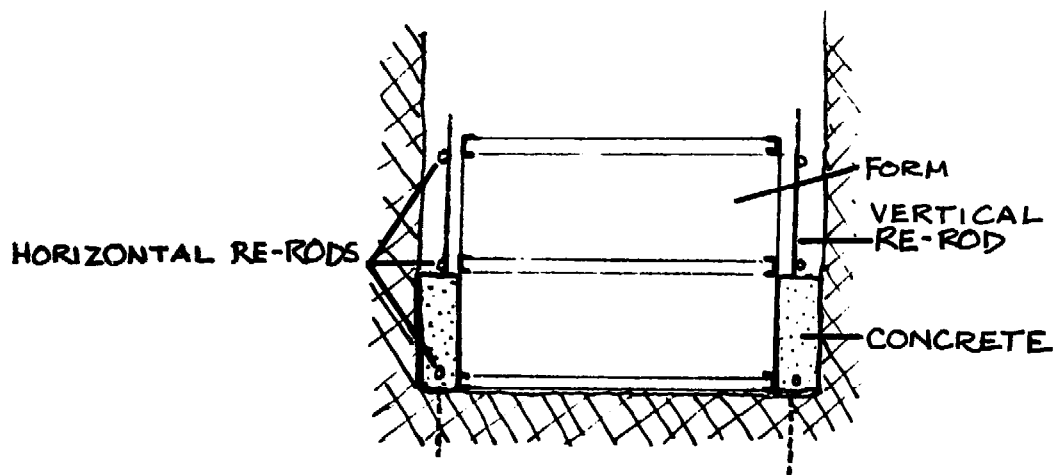

FIG. IV - 2.
INTERIOR LINING FORM

Freshly mixed concrete is heavy and plastic. Forms for holding it in place until it hardens must be well braced and should have a smooth inside surface. Cracks, knots, or other imperfections in the forms may be permanently reproduced in the concrete surface.

Forms should be easy to fill with concrete and easy to remove once the concrete has hardened. Be sure that the fasteners used to hold the form together are both accessible and easy to unfasten.

NOTE: When using nails to hold a wood form together, do not drive them all the way in. Leave them sticking up just enough so that they can easily be pulled when necessary to remove the form.

b. Materials for Forms

The following materials are used to construct interior forms:

- steel: forms made of steel range in height from $\frac{1}{2}$ m to 1 m. They are heavy, awkward, and expensive but last for a long time.
- sheet metal: with a simple triangular interior support, forms made of sheet metal have proved to be successful. They are lighter and more maneuverable than steel forms but are not as strong and durable.
- wood: this material is commonly used because it is lightweight and strong. It must be carefully bent, waterproofed, and reinforced.

By using boards as wide as possible, form construction will be easier and quicker. It will also reduce the number of lines on the concrete surface that form at the junction of two boards. Plywood is excellent, especially if it has a special high density overlay surface. This allows for a smoother concrete finish, easier form removal and less wear on the forms.

If unsurfaced wood is used for forms, oil or grease the inside surface to make removal of the forms easier and to prevent the wood from drawing too much water from the concrete. Do not oil or grease the wood if the concrete surface will be painted or stuccoed.

- earth: Any earth that can be dug into and still hold its shape can also be used as a form. Carefully dig out the desired shape and fill it with concrete. Once the concrete has set and cured it can be dug up and used where needed. A new form will have to be dug out for each piece of concrete poured. (See Figs. 8-12 and 9-10.)
- other materials: Plastics and fiberglass are also occasionally used and continue to be experimented with as form materials. Fiberglass is much lighter than steel and, if taken proper care of, should last for a long time. Its cost and availability in developing nations seem to be the only factors limiting more widespread trials.

3. Concrete Reinforcement

Reinforcing concrete will allow much greater loads to be carried. Design of reinforced concrete structures that are large or must carry high loads can become too complicated for a person without special training.

Concrete alone has great compression strength but little tension strength. Concrete is very difficult to squeeze (compression), but breaks relatively easily when stretched (put in tension). Reinforcing steel has exactly the opposite properties; it is strong in tension and weak in compression. Combining the two results in a material (reinforced concrete) which is strong in both compression and tension and therefore useful in a large number of situations.

Concrete is best reinforced with specially made steel rods which can be imbedded in the concrete. Bamboo has also been used to reinforce concrete with some success although it is liable to deteriorate in time.

- Reinforced concrete sections should be at least 7.5 cm thick and 10 cm is much better.
- The reinforcing rod (rerod) usually comes in long sections of a given diameter.
- The range of different diameter sizes commonly manufactured is usually measured in millimeters; for example, 4 mm, 6 mm, 8 mm, 10 mm, and 12 mm.
- Exactly how much rerod is needed in a particular pour will depend on the load it will have to support. For most concrete work, including everything discussed in this manual, rerod should take up 0.5% to 1% of the cross-sectional area.
- Reinforcing rods should also have clean surfaces free of loose scale and rust. Rods in poor condition should be brushed thoroughly with a stiff wire brush.
- When placing rerod in a form before the concrete is poured it should be located:
 - at least 2.5 cm from the form everywhere.
 - in a plane approximately two-thirds of the way into the thickness of the pour from the side

which will have a weight or force pressing on the concrete. (See Fig. IV-3.)

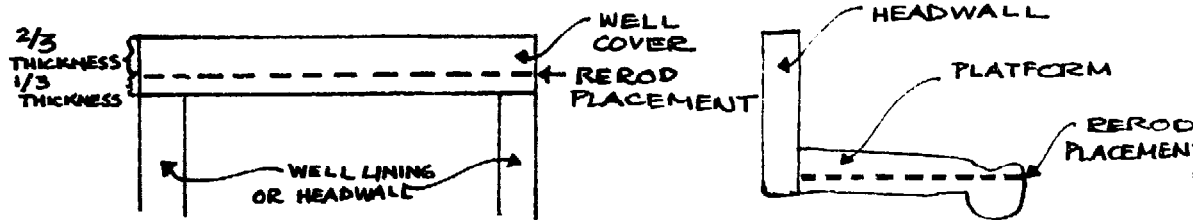

**FIG. IV-3. REINFORCING ROD PLACEMENT
(ALSO SEE FIGS. 8-3 AND 8-5 FOR REROD
PLACEMENT IN LINING)**

- in a grid so that there is never more than 3 times the final concrete thickness between adjacent rods.
- no closer than 3 cm to a parallel rod.
- Rerod strength is approximately additive according to cross-sectional area. Four 4 mm rods will be about as strong as one 8 mm rod. The cross-sectional area of four 4 mm rods equals the cross-sectional area of one 8 mm rod.
- The rod should be arranged in an evenly spaced grid-type pattern with more and/or thicker rod along the longest dimension of the pour.
- All intersections where rods cross should be tied with thin wire.
- When tying one rod on to another to increase the length of the rods, they should overlap 20 times the diameter of the rod and be tied twice with wire. (See Fig. IV-4.)

<u>Rod size</u>	<u>Overlap</u>
6 mm - - - - -	12 cm = 120 mm
8 mm - - - - -	16 cm = 160
10 mm - - - - -	20 cm = 200
12 mm - - - - -	24 cm = 240

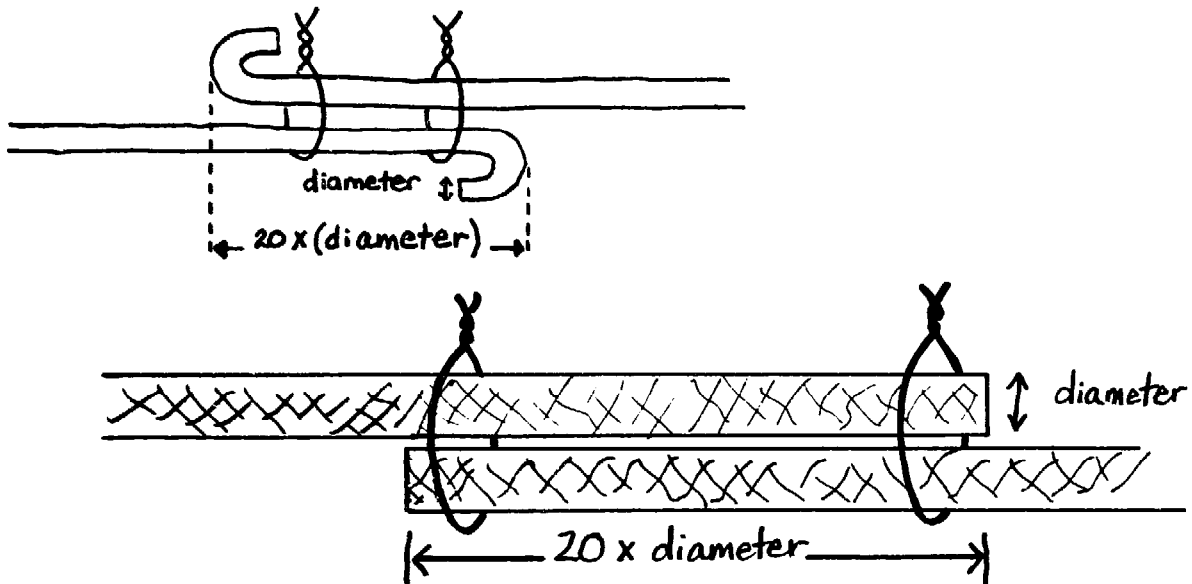

FIG. IV-4. REROD OVERLAP

- Larger sizes of rod often have raised patterns on them which are designed to allow them to be held firmly in place by the concrete. Smaller sizes of rod are generally smooth. When using smooth rod always make a small hook at the end of each piece that will be in the concrete. Without the hook, temperature changes may eventually loosen the concrete from the rod thereby losing much of its reinforcing effect.
- Rerod should be carefully prepared so that the rod is straight and square where it should be. Sloppy rod work will result in weaker concrete and wastes rod.
- For particularly strong pieces or where small irregular shapes are being formed, the rerod can be put together in a cage-like arrangement. Use small rod for the cross-sections and larger rod for the length. This system is used to reinforce pieces like a cutting ring, with its irregular shape, or perhaps a well cover, which may have many people standing on it at one time.
- Where possible, it is usually best to assemble rerod inside the form so that it will fit exactly.
- The proper distance from the bottom of the pour in a slab can be achieved by setting the rod on a few small stones before the concrete is poured or simply pulling the rerod grid a couple of centimeters up into the concrete after some concrete has been spread over the whole pour.

4. Mixing Concrete By Machine or By Hand

a. Mixing by Machine

Concrete must be thoroughly mixed to yield the strongest product. For machine mix, allow 5 or 6 minutes after all the materials are in the drum. First, put about 10% of the mixing water in the drum. Then add water uniformly with the dry materials, leaving another 10% to be added after the dry materials are in the drum.

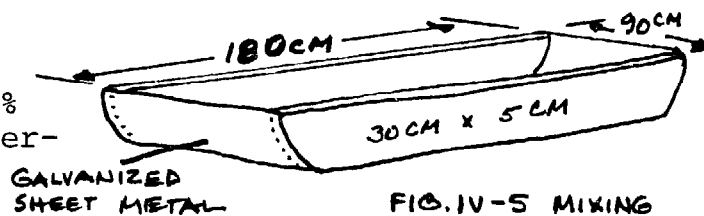

FIG. IV-5 MIXING TROUGH

b. Mixing by Hand

On many self-help projects, the amount of concrete needed may be small or it may be difficult to get a mechanical mixer. Concrete can be mixed by hand; if a few precautions are taken, it can be as strong as concrete mixed in a machine.

The first requirement for mixing by hand is a mixing area which is both clean and water-tight. This can be a wood and metal mixing trough (Fig. IV-5) or a simple round concrete floor (Fig. IV-6).

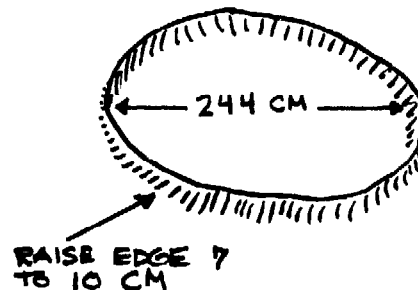

FIG. IV-6, MIXING PLATFORM

Use the following procedure:

- 1) Spread the fine aggregate evenly over the mixing area.
- 2) Spread the cement evenly over the fine aggregate and mix these materials by turning them with a shovel until the color is uniform.
- 3) Spread this mixture out evenly and spread the coarse aggregate on it and mix thoroughly again. All dry materials should be thoroughly mixed before water is added.

When work is finished for the day, be sure to rinse concrete from the mixing area and the tools to keep them from rusting and to prevent cement from caking on them. Smooth shiny tools and mixing boat surfaces make mixing surprisingly easier. The tools will also last much longer. Try to keep from getting wet concrete on your skin because it is caustic.

A workable mix should be smooth and plastic -- neither so wet that it will run nor so stiff that it will crumble.

If the mix is too wet, add small amounts of sand and gravel, in the proper proportion, until the mix is workable.

If the mix is too stiff, add small amounts of water and cement, maintaining the proper water-cement ratio, until the mix is workable.

Note the amounts of materials added so that you will have the correct proportions for subsequent batches.

If a concrete mix is too stiff, it will be difficult to place in the forms. If it is not stiff enough, the mix probably does not have enough aggregate, thus making it an uneconomical use of cement.

5. Pouring Concrete into Form

To make strong concrete structures, it is important to place fresh concrete in the forms correctly.

The wet concrete mix should not be handled roughly when it is being carried and put in the forms. It is very easy, through joggling or throwing, to separate the fine aggregate from the coarse aggregate. Do not let the concrete drop freely for a distance greater than 90 to 120 cm. Concrete is strongest when the various sizes of aggregates and cement paste are well mixed.

Properly proportioned concrete will have to be worked into place in the form. Concrete that would on its own flow out to completely fill in a form would be too wet and therefore weak.

When pouring concrete structures that are over 120cm high, leave holes in the forms at intervals of less than 120cm through which concrete can be poured and which can later be covered to permit pouring above that level. Alternatively, a slide could be used through which concrete could flow down to the bottom of the form without separating.

Any "u"-shaped trough wide enough to facilitate pouring concrete into it, narrow enough to fit inside the form, and long enough so that the concrete can slide down the chute without separating will work.

As the concrete is being placed it should be compacted so that no air holes, which would leave weak spots in the concrete, are left. This can be done by tamping the concrete with some long thin tool or vibrating the concrete in one of several ways. Tamping can be accomplished with a thin (2 cm) iron rod, a wooden pole or a shovel.

On large commercial jobs concrete is compacted with a special vibrator usually powered by an air compressor which is submerged in the concrete immediately after it is poured. The concrete will be compacted to some extent as it is moved into its final position in the form. However, special attention must be paid to the edges of the pour to make sure that the concrete has completely filled in the form up to the edges. If the forms are strong enough they can be struck with a hammer on the outside to vibrate the concrete just enough to allow it to settle completely in against the forms. Too much tamping can force most of the large aggregate toward the bottom of the pour, thus reducing the overall strength of the concrete.

6. Finishing

Once the concrete is poured into the forms, its surface should be worked to an even finish. The smoothness of the finish will depend on what the surface will be used for. Where more concrete or mortar will later be placed on this pour, the area should be left relatively rough to facilitate bonding. Where the surface will later be walked on, as for example the cover of a well on which a pump will be mounted, it should be somewhat rough to prevent people from slipping on the concrete when its surface is wet. This somewhat rough texture can be achieved by finishing with a wooden float or by also lightly brushing the surface to give it a texture. A very smooth finish can be made with a metal trowel. Over-finishing (repeated finishing) can lead to powdering and erosion of the surface.

7. Curing Concrete

After the forms are filled, the concrete must be cured until it reaches the required strength. Curing involves keeping the concrete damp so that the chemical reaction that causes the concrete to harden will continue for as long as is necessary to achieve the desired strength. Once the concrete is allowed to dry the chemical hardening action will

gradually taper off and cease.

The early stage of curing is extremely critical. Special steps should be taken to keep the concrete wet. Once the concrete dries it will stop hardening; after this happens it cannot be re-wetted in the field to re-start the hardening process.

Covering the exposed concrete surfaces is usually easier than continuously sprinkling or frequently dousing the concrete with water which would otherwise be necessary to prevent the concrete surface from becoming dry to the touch. Protective covers often used include canvas, empty cement bags, burlap, plastic, palm leaves, straw and wet sand. The covering should also be kept wet so that it will not absorb water from the concrete.

Concrete is strong enough for light loads after 7 days. In most cases, forms can be removed from standing structures like bridges and walls after 4 or 5 days, but if they are left in place they will help to keep the concrete from drying out. Where concrete structures are being cast on the ground, the forms can be removed as soon as the concrete sets enough to hold its own shape (3 to 6 hours) if there is no load on the structure and measures are taken to ensure proper curing.

The concrete's final strength will result in part from how long it is moist cured. As can be seen from the graph, concrete will eventually reach about 60% of its design strength if not moist cured at all, 80% if moist cured for 3 days, and almost 100% if moist cured for 7 days. If concrete is kept moist it will continue to harden indefinitely.

You will also notice from the graph that even though the concrete may be cured for 7 days, at that point it will only have gained about 60% of the strength it will ultimately have and that it will be another 3 weeks before it reaches 90% of its ultimate strength. Practically, this means that when pouring a concrete ring which will later be put in the well even after curing has stopped, the ring should be left alone for at least another week (and preferably longer) before it is installed in the well. It will during that time harden to reach about 75% of its final strength.

GRAPH: STRENGTH OF CONCRETE AFTER DAYS OF MOIST-CURING

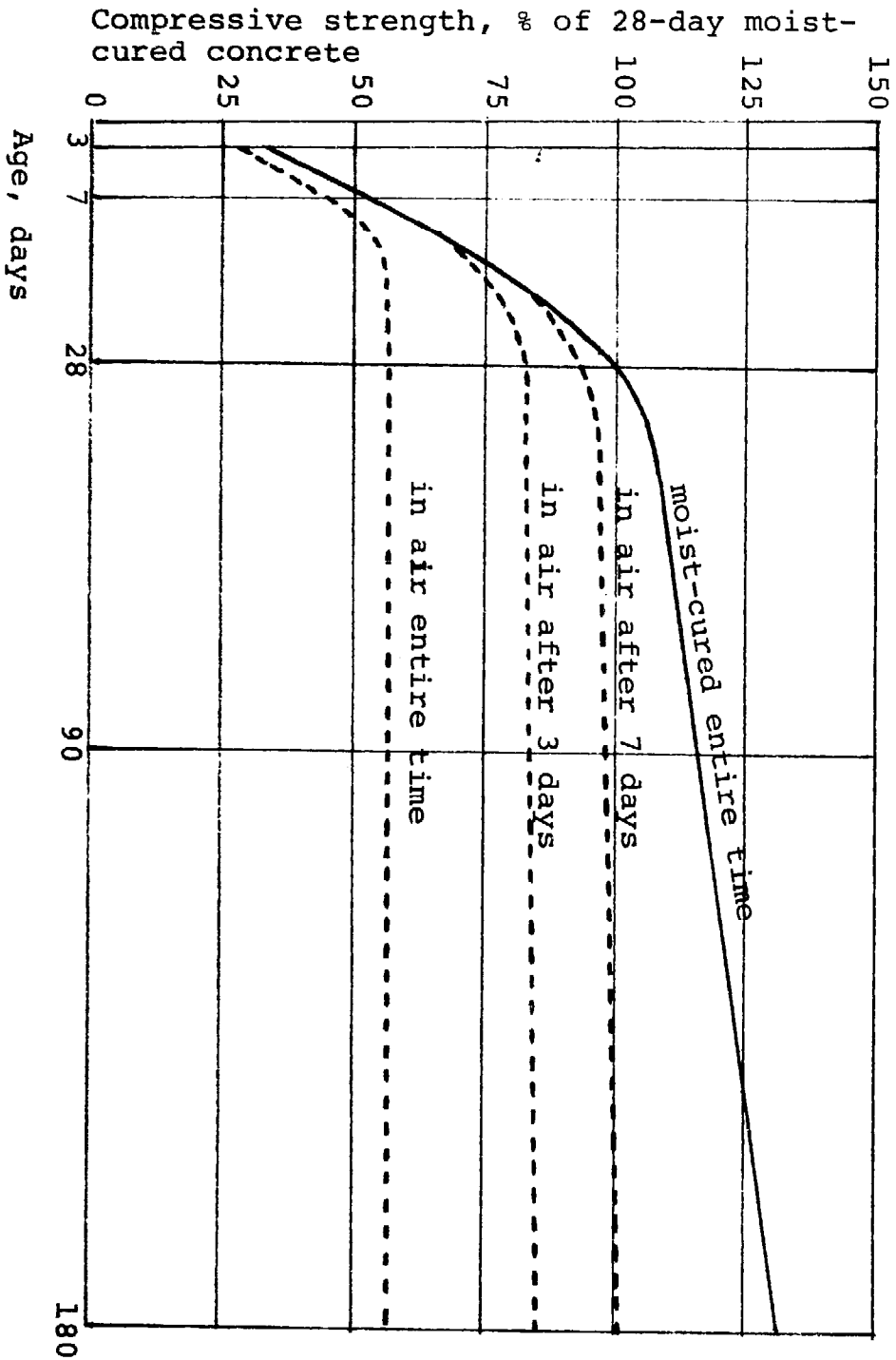

Appendix V

LEVELING AND PLUMBING THE MOLD

When you check the level of the mold you also take a measure of whether or not the sides of the mold are perfectly plumb. If they are perfectly plumb the shaft will go straight down. A well does not have to have a shaft that goes straight down; it could just as easily curve or go down at an angle. Plumb is easy to measure, however, and there are many reasons why it is desirable to keep the well plumb.

- 1) A plumb well shaft and lining is a stronger structure than one that is not plumb.
- 2) Sinking the hole straight down requires less excavation work than an angled or a curved hole.
- 3) Fewer materials are required to construct a lining that will support the well.
- 4) If a pump is to be installed, the pipe that reaches to water should be perfectly plumb. If it is not plumb, there will be greater stress on the pipe and pumping components will wear out much sooner than they should.

1. Tools

Use a commercial level (see Fig. V-3) or a clear plastic hose with water in it. (See Fig. V-4.)

For the purpose of demonstration, level the interior lining mold in the well with a commercial level (spirit level, or water level). The normal ordinary level has a clear glass or plastic tube which is slightly curved and full of liquid with one air bubble; there will also be two marks on the tube, one on either side of the center of the tube. To read the level set it, with the tube side up, on whatever you want to check; the object will be level when the air bubble in the tube is

exactly centered between the two marks on the tube.
(See Fig. V-1.)

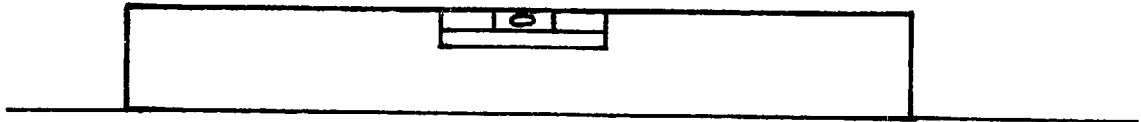

FIG. V-1. BUBBLE BETWEEN TWO MARKS INDICATING LEVEL OBJECT

If the object is not level the bubble will be off-center toward the side which is highest. (See Fig. V-2.)

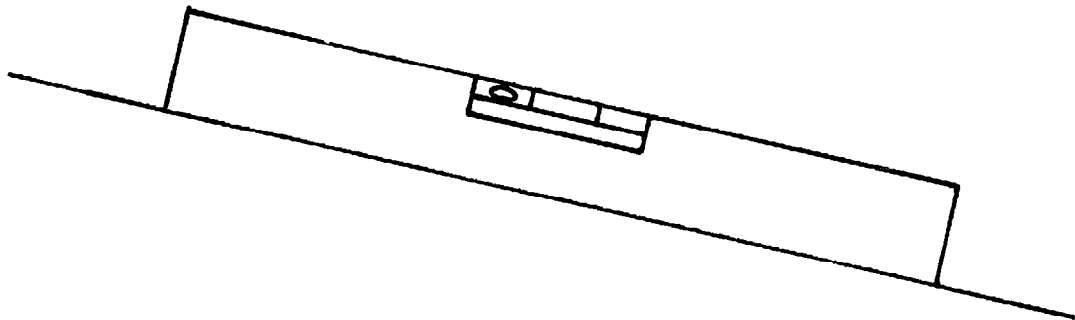

FIG. V-2. BUBBLE ON HIGHER SIDE OF UN-LEVEL OBJECT

2. Care of the level

Levels are sensitive and exact instruments which arrive adjusted from the factory. Great care should be taken never to drop a level or otherwise damage its edges. Many levels also come with insets for checking verticality (plumb) and 45° angles. (See Fig. V-3.)

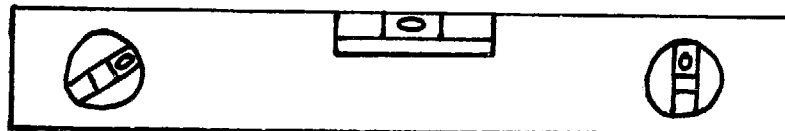

FIG. V-3. COMMERCIALY MANUFACTURED LEVEL

If a level is not commercially available, you can easily make your own level with a clear plastic hose and water. (See Fig. V-4.)

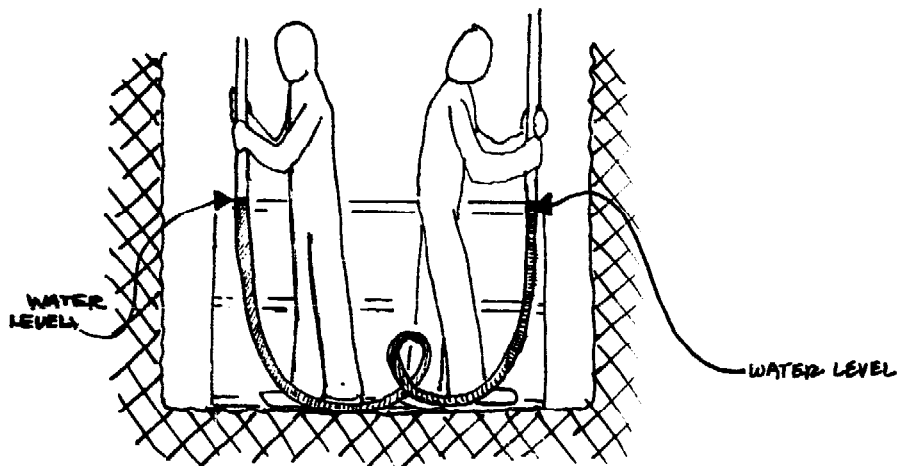

FIG. V-4. CLEAR HOSE AND WATER USED AS LEVEL

If the surface of the water in the hose is even with the edge of the mold on one side, then when the edge of mold on the opposite side of the hole is even with the surface of the water in the other end of the hose, the mold is level in that direction.

Water in two ends of the same tube will always be at the same height no matter what the tube does between the two ends.

NOTE: If the diameter of the clear plastic hose is small, a "meniscus" (U-shaped surface due to capillary action) may form. All level readings should be made at the same point of the meniscus, preferably at the center.

3. Checking the level of a horizontal object

Always check the level in two opposite directions before declaring that an object is level.

For a flat plate, see Fig. V-5.

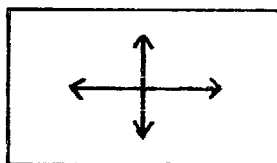

FIG. V-5. LEVEL CHECKED IN TWO DIRECTIONS ON FLAT SURFACE

For a lining mold, see Fig. V-6.

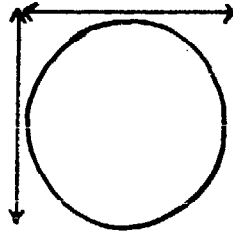

FIG. V-6. LEVEL CHECKED IN TWO DIRECTIONS ON LINING MOLD

To check two objects not connected with each other, find a straight object (a board, a shaft etc.) that can be laid down between the two objects to be leveled. (See Fig. V-7.)

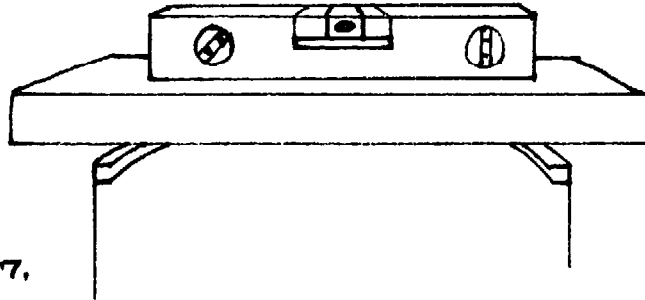

FIG. V-7.

USING A STRAIGHT BOARD TO CHECK LEVEL ACROSS MOLD

Check the straightness of the board by looking along its edges from one end.

Appendix VI

PIPEA. Introduction

Water is often needed in locations where none is available. Pipe can help to meet this need if there is some force available to move water through it. Gravity and pumps can exert the necessary force on water to cause it to flow through a pipe. But pipe can be expensive and may not be appropriate for use in some situations. Where water needs to be transported from one place to another across the surface of the earth, a simple trough arrangement might work and be more easily repaired when damaged.

Generally speaking, however, pipe is superior to other water transportation devices. It is readily available and it can be used for a number of purposes, besides transporting water. It is commonly used in the casing for drilled wells and in the drop pipe for pumps. Depending on the material from which it was made, it can be used to make many handy tools or simple equipment.

NOTE: For pipes laid in the ground, always maintain sufficient pressure in a completed line of pipe so that water will leak out of any holes. If pressure around the pipe is greater than that inside it, contaminants from the ground will be forced into the pipe.

When evaluating possible pipe choices, a number of factors should be considered. They include:

- cost;
- accessibility/availability;
- pressure. Where necessary, can the pipe withstand the pressure of the water that will be carried inside it? Computing the actual pressure is beyond the scope of this manual.

It is sufficient to say here that the pressure of the water is directly related to the vertical height of the water column above that point.

- pipe connections. Can the pipe connections be made completely watertight, to prevent unnecessary loss of water and the entrance of possible contaminants?
- weight. Will you need special equipment to raise or lower the needed length of pipe?
- possibility of decay or corrosion. Is the pipe suitable for the ground and water conditions in which you intend to use it?

B. Pipe Materials

1. Bamboo

Although an appealing idea considering the widespread availability of bamboo, in fact bamboo is seldom used as water pipe. This is due to the fact that it is essentially a temporary solution, requiring considerable upkeep to keep a well from being contaminated by the rotting of the bamboo segments.

- Bamboo can take the pressure from a column of water 20m in height, or about 2 atmospheres.
- Preserve bamboo for use as water pipe with oil based paint or varnish to seal it on the outside, or soak in 5% boric acid and water solution.

NOTE: Boric acid can give water an unpleasant smell for about three weeks.

- Chisel or drill to break inner membranes of bamboo.
- Join pieces by three possible methods:
 - 1) sliding one piece into the next, and then wrapping the joint with tar-soaked rope;
 - 2) using extra bamboo as interior or exterior coupling and then wrapping the joint with tar-soaked rope;
 - 3) wrapping cow-hide tightly twice around the joint and sealing it with two pieces of wire.
- There will be a three to four year life expectancy if the pipe is carefully installed.
- If chlorine is used to disinfect the water before it flows through the pipe, allow sufficient contact time for chlorine to act before the water enters the pipe.

2. Iron or Steel-commonly referred to as "black" pipe

- Iron or steel is frequently used for water pipe even though it is sometimes subject to rust and corrosion from the water.
- These materials are commonly used as casing pipe for drilled wells where the water is not corrosive.
- Iron and steel are galvanized to help prevent rust and corrosion. (See next entry.)

3. Galvanized Iron or Galvanized Steel

- Regular iron or steel pipe is simply coated with a thin layer of zinc when galvanized. This helps reduce rust and corrosion normal to iron and steel.
- The piping is joined by threaded connections. The threading process cuts through the zinc layer. Thus, threads are particularly susceptible to rusting and corrosion.
- Galvanized iron or steel is commonly manufactured in metric and English sizes.
- Because this material is strong, the pipe is also particularly useful in manufacturing many small tools and pieces of equipment to suit a specific job and location.

4. Plastic - ABS (Acrylonitrile-Butadiene-Styrene)

- ABS plastic has excellent impact resistance, even at low temperatures.
- ABS has heat resistance up to 160°F.
- It has pressure ratings of 1,000, 1,250 and 1,600 pounds per square inch (p.s.i.), depending on composition and thickness.
- It possesses excellent corrosion and chemical resistance to non-oxidizing chemicals.
- It can be joined by solvent cementing or by pipe threads where wall thickness is adequate.

ABS plastic also presents certain problems:

- It is subject to attack from organic solvents.
- Direct exposure to the ultraviolet rays of the sun reduces its strength and elongation properties. This is a gradual process which is likely to significantly affect the pipe strength only after months of exposure.

Plastic - PE (Polyethylene)

- There are three types of plastics, varying from soft to hard. Their rigidity, tensile strength, surface hardness, softening temperature and chemical resistance increase with density and molecular weight.
- They have p.s.i. ratings of 80, 100, 125, and 160, according to composition and thickness.
- They are extremely resistant to chemicals.
- This kind of plastic can be joined by flaring, using insert fittings, or by heat fusion.
- They are low cost, lightweight and flexible, long lengths can be coiled.

PE plastic also presents certain problems:

- It has low design stress and poor rigidity.
- The temperature limit varies from 100 to 180°F depending on density.
- PE plastic is sensitive to light but can be left in the open for a month or more
- It is flammable, although easily extinguished.
- American and European polyethylenes have different density ratings.

Plastic - PVC (Polyvinyl Chloride)

- PVC plastic has excellent strength and rigidity.
- Its p.s.i. ratings are comparable to those of PE and ABS.

- It is extremely resistant to chemicals and oils.
- It can be joined by heat fusion, by solvent cement, or by various kinds of mechanical joints.
- It is readily threaded if there is sufficient wall thickness.

PVC plastic also presents certain problems:

- It is readily softened by ether, ketones and chlorinated hydrocarbons.
- It is heavier than PE and ABS.
- Its temperature limit is 150°F.
- However, its many advantages make it widely used as plastic pipe.

5. Concrete

- Concrete is usually used to make large culvert-type pipe.
- It can be used as well casing or lining if care is taken to seal successive sections from each other.

6. Fired Clay

- Clay is usually used to make four inch to six inch drainage tile.
- Unless it is manufactured with special end fittings, usually a bell and socket, it is not easily adapted to water transport.
- It is relatively weak and easily broken.

Appendix VII

PUMPSA. Introduction

There are many different kinds of pumps in use around the world. This discussion is limited to an overview of the most commonly used pumps.

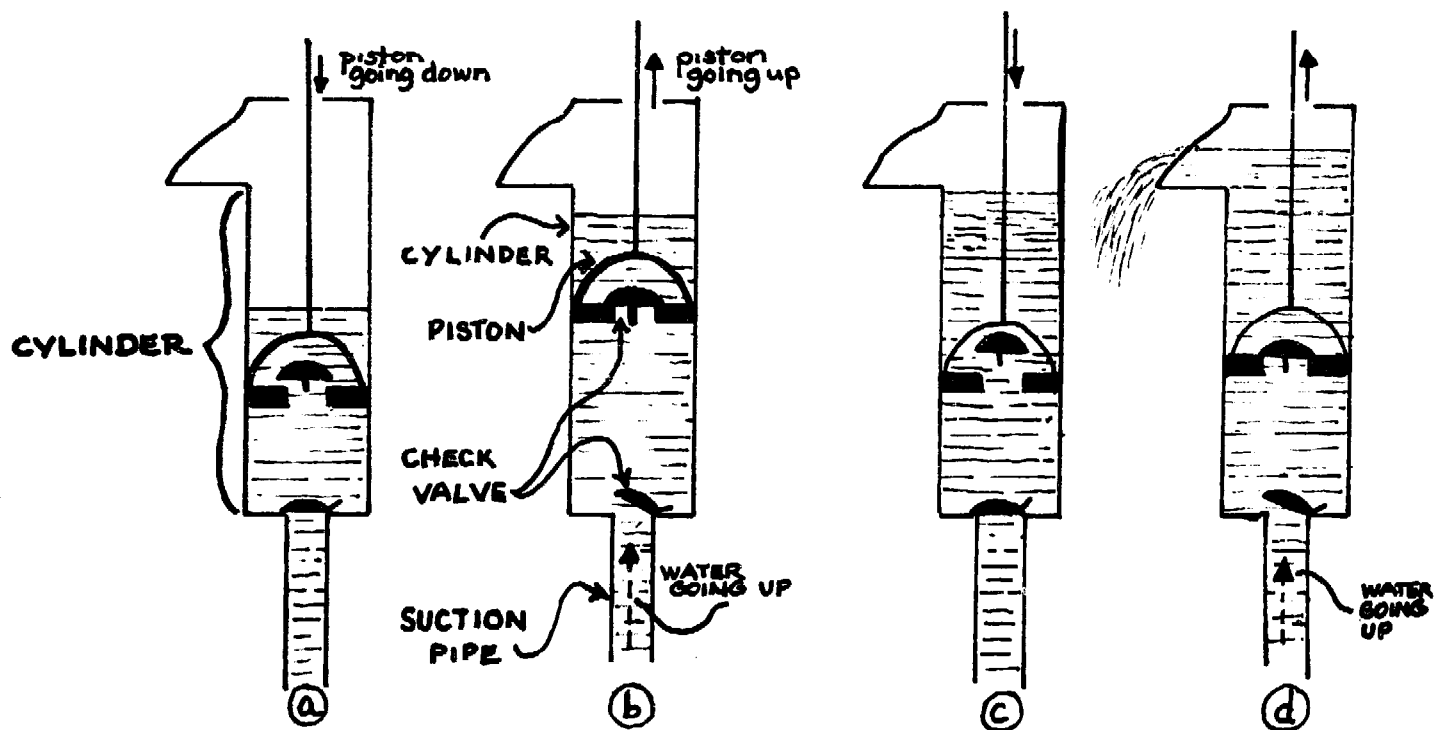

FIG. VII-1. PUMP ACTION

- (a) As the piston goes down, the check valve in it opens allowing the water to come through. The check valve at the base of the cylinder remains closed holding the water in the cylinder.
- (b) As the piston moves up, the check valve in it closes allowing the water above the piston to be lifted. The rising piston also pulls more water up into the cylinder through the valve at its base.
- (c) and (d) The continued down and up motion of the piston inside the cylinder and the opening and closing of the different valves enables water to be moved up and out of the pump.

The most common type of hand pump uses a smooth cylinder against which a piston (plunger) slides up and down. The up and down motion of the piston, coupled with the concurrent action of two valves, causes water to move through the cylinder. (See Fig. VII-1.)

While there are other types of pumping mechanisms which will be mentioned later, this type of pump is by far the most common.

B. Piston Pump Variations

1. Shallow/deep well pumps

Although the basic operation of cylinder pumps is always the same, there are two different arrangements of the components depending on the distance between the pump and the water surface. For the pump to work the cylinder must be within 6.5 m of the water surface in the well.

Shallow well pump: If the water level in the well is within 6.5 m of where the bottom of the pump will be placed, the cylinder can be incorporated into the pump body. (See Fig. VII-2.)

Deep well pump: If the water level in the well is more than 6.5 m from the bottom of the pump at any time, the cylinder will have to be inside the well. (See Fig. VII-3.)

Because the working parts of the pump are all above ground in the shallow well pump, this pump is much easier to repair. Deep well pumps, however, are more common because water is not often found within 6.5 m of the ground surface.

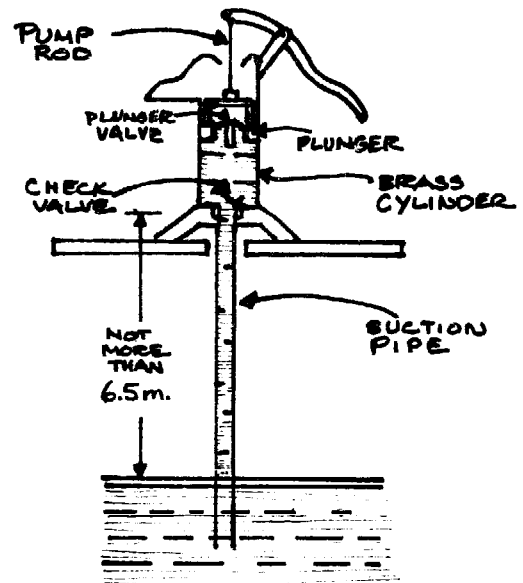

FIG. VII - 2. SHALLOW WELL LIFT PUMP

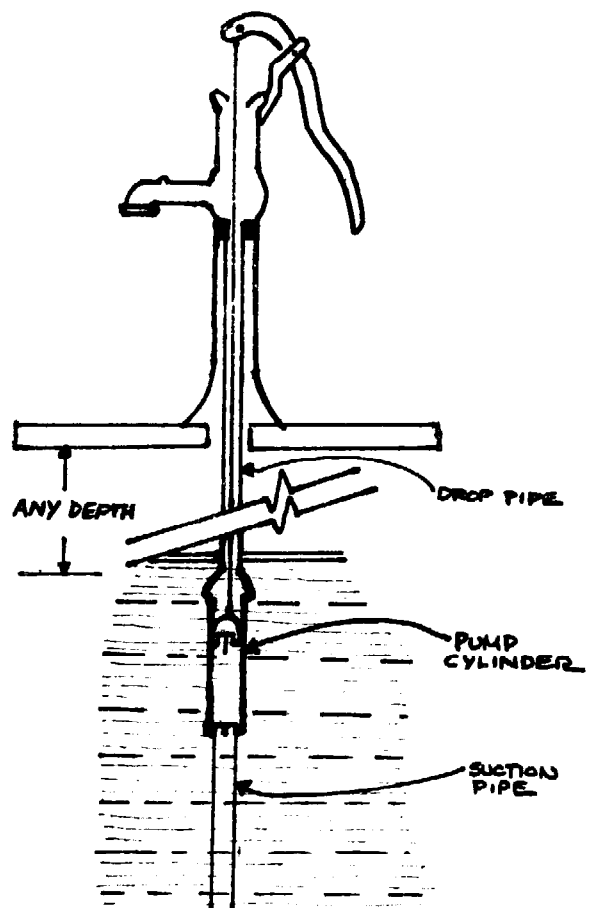

FIG. VII - 3. DEEP WELL LIFT PUMP

NOTE: Contrary to popular opinion, pumps do not 'lift' water up from the source. Instead, the pump reduces the atmospheric pressure on the water in the suction pipe and the atmospheric pressure on the water outside of the suction pipe pushes the water up and into the pump. The principle is the same as that of drawing water through a straw or filling a syringe.

Theoretically a pump should be able to raise water 10.4 m up to the cylinder. However, because seals and valves can never function perfectly, the absolute limit is 6.7 meters. Where pumps are locally made, tolerances are usually greater so that the practical limit is 6.5 m or even slightly less.

Elevation above sea level also plays a part in determining the practical limit of pumping height because the higher above sea level the less atmospheric pressure there is to push the water up. (See Chart.)

There is no theoretical limit to how far a cylinder can push water up above itself if the pump parts are strong enough. Practically, however, hand pumping over distances greater than about 30 m becomes difficult because of the pressure exerted by the 30 m column of water. To reduce this pressure, most pump manufacturers use progressively smaller cylinders at increasing depths. This reduces the surface area of the piston and therefore the pressure, but it also reduces the output of the pump. In arid hard rock regions where other water lifting techniques are not feasible, hand pumps have been used at depths greater than 50 m.

MAXIMUM SUCTION HEAD OF RECIPROCATING HAND PUMPS
AT DIFFERENT ALTITUDES FOR WATER AT 60°F (15.6°C)

Altitude-Above Mean Sea Level		Barometric Pressure			Practical Suction Head of Pump	
		Air	Equivalent Head of Water			
Feet	Meters	Psi	Feet	Meters	Feet	Meters
0	0	14.7	34.0	10.36	22.6	6.91
1000	305	14.2	32.8	10.00	21.9	6.67
2000	610	13.7	31.5	9.60	21.0	6.40
3000	914	13.2	30.4	9.27	20.3	6.18
4000	1219	12.7	29.2	8.90	19.5	5.93
6000	1829	11.8	27.2	8.29	18.1	5.53
8000	2438	10.9	25.2	7.68	16.8	5.12
10000	3048	10.1	23.4	7.13	15.6	4.75

2. Lift pumps/lift and force pumps

If you plan to use the pump to force the water above the level of the pump spout, you will need a "lift and force" pump. The only difference between this and the simple lift pump is that the lift and force pump has a stuffing box around the pump rod at the top of the pump body to prevent water from flowing out that way. (See Figs. VII-3 and VII-4.)

If you are considering ordering a deep well pump, you will also have to decide whether the pump should have an extractable or non-extractable cylinder. (See Figs. VII-5 and VII-6.)

- An open or extractable cylinder is connected to a drop pipe which is slightly larger than the piston assembly in the cylinder. This allows the piston to be removed by simply pulling the pump rod up. The large diameter drop pipe is more expensive, heavier, and more difficult to work with.
- A closed or non-extractable cylinder is connected to a smaller diameter drop pipe which will not

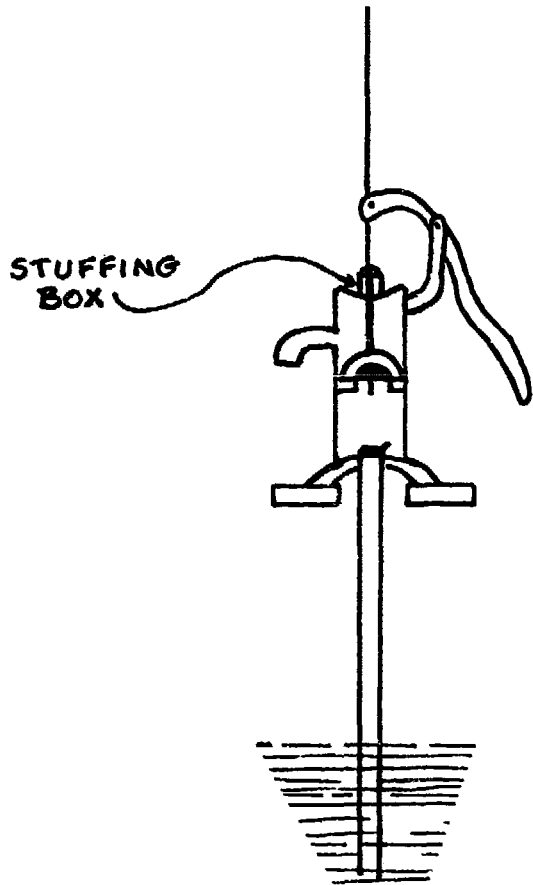

FIG. VII-4. SHALLOW WELL; LIFT AND FORCE PUMP

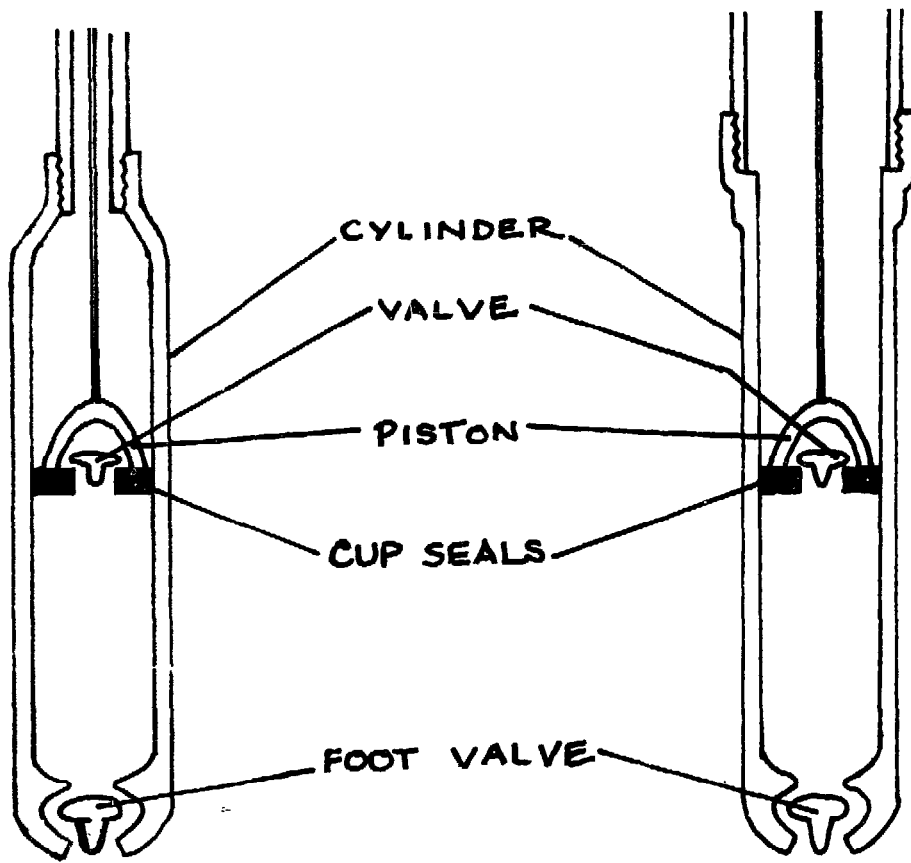

FIG. VII-5.
NON-EXTRACTABLE
CYLINDER

FIG. VII-6.
EXTRACTABLE
CYLINDER

permit removing the piston assembly by itself. Instead the whole length of pipe must be removed from the well and the cylinder disconnected to permit access to the piston assembly.

The cup seals in the piston assembly need to be changed every three months to three years, depending on how much use the pump gets, the cylindrical material, and the quality of the water. In cast iron cylinders the first cup seals tend to wear faster than later seals, perhaps due to an initial honing action. For a closed cylinder changing cup seals will require some kind of heavy lifting device to be able to remove all the pipe and gain access to the cylinder and the piston assembly with its cup seals. The same operation performed on an open cylinder will simply involve disconnecting the pump from the pipe and pulling up the pump rod with the piston assembly attached to its bottom end.

C. Difficulties with Piston Pumps.

All piston pumps present certain difficulties in practical, everyday use.

- The cylinder will be seriously damaged if sand is pumped with water. Sand scratches the cylinder wall and wears out the cup seals.
- There is the problem of cup seal wear. The smoothness of the cylinder wall largely determines the wear rate of seals. Brass is commonly used because it has a smoother finish than cast iron or steel and will not corrode but cast iron is probably the most commonly used cylinder material. Steel cylinders are rare. Experiments are now underway with plastics and resin cylinders, cylinder liners and cup seals. The initial results are promising.
- The pump rod and handle can present problems. Most handle arrangements do not pull the rod straight up and down but allow some lateral movement. This back and forth movement adds to the wear on both the pump rod and the cup seals. For a regular handle arrangement to come close to straight up and down motion, there must be three pivot points which add to the maintenance. However, a new arrangement developed in India, the Jalna-type pump, has one pivot point and pulls the rod straight up and down. (See Fig. VII-7 and VII-8.) The "Mark II" is the latest Indian development in Jalna-type pumps and is being used in UNICEF assisted projects in India and in some African countries.

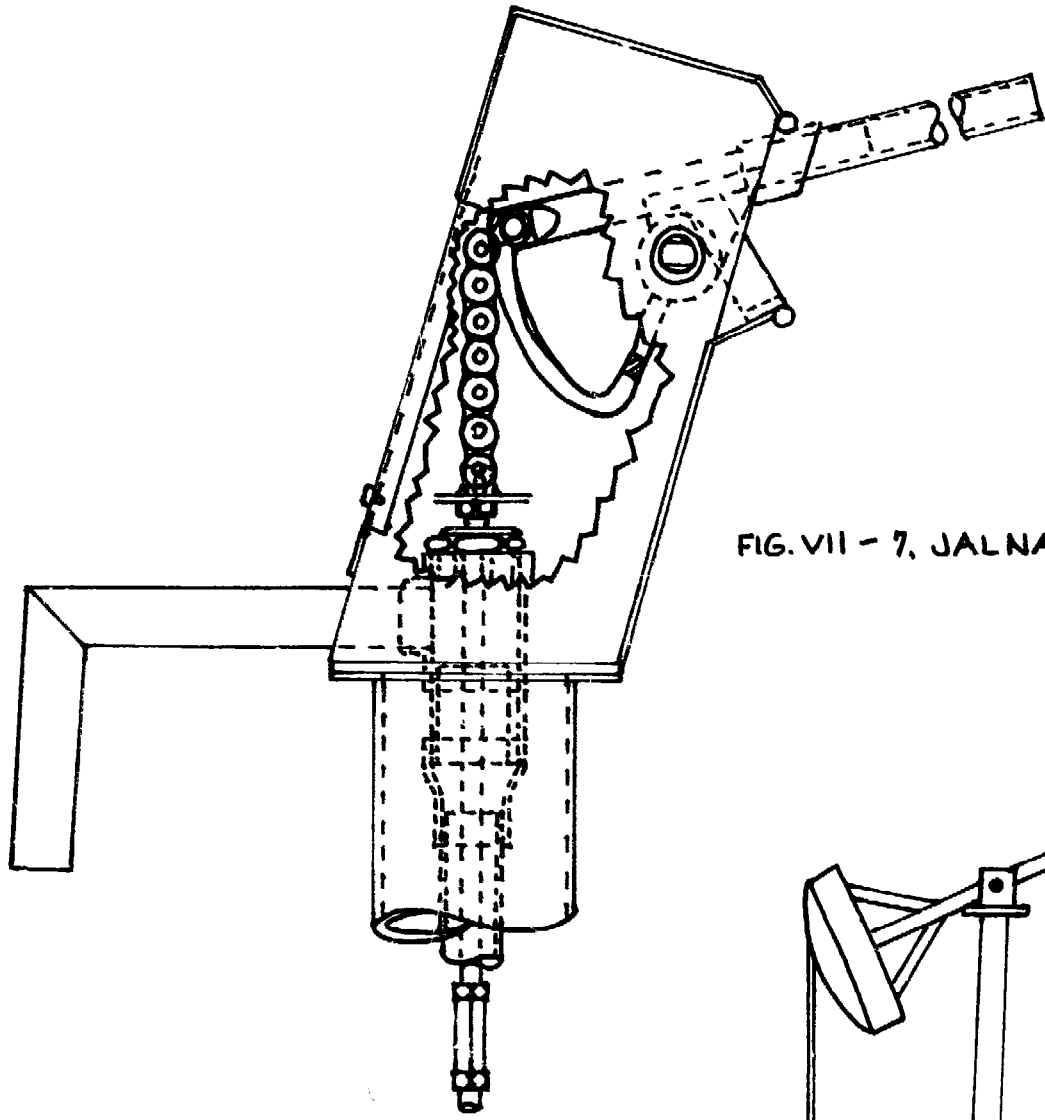

FIG. VII - 7, JALNA PUMP HEAD

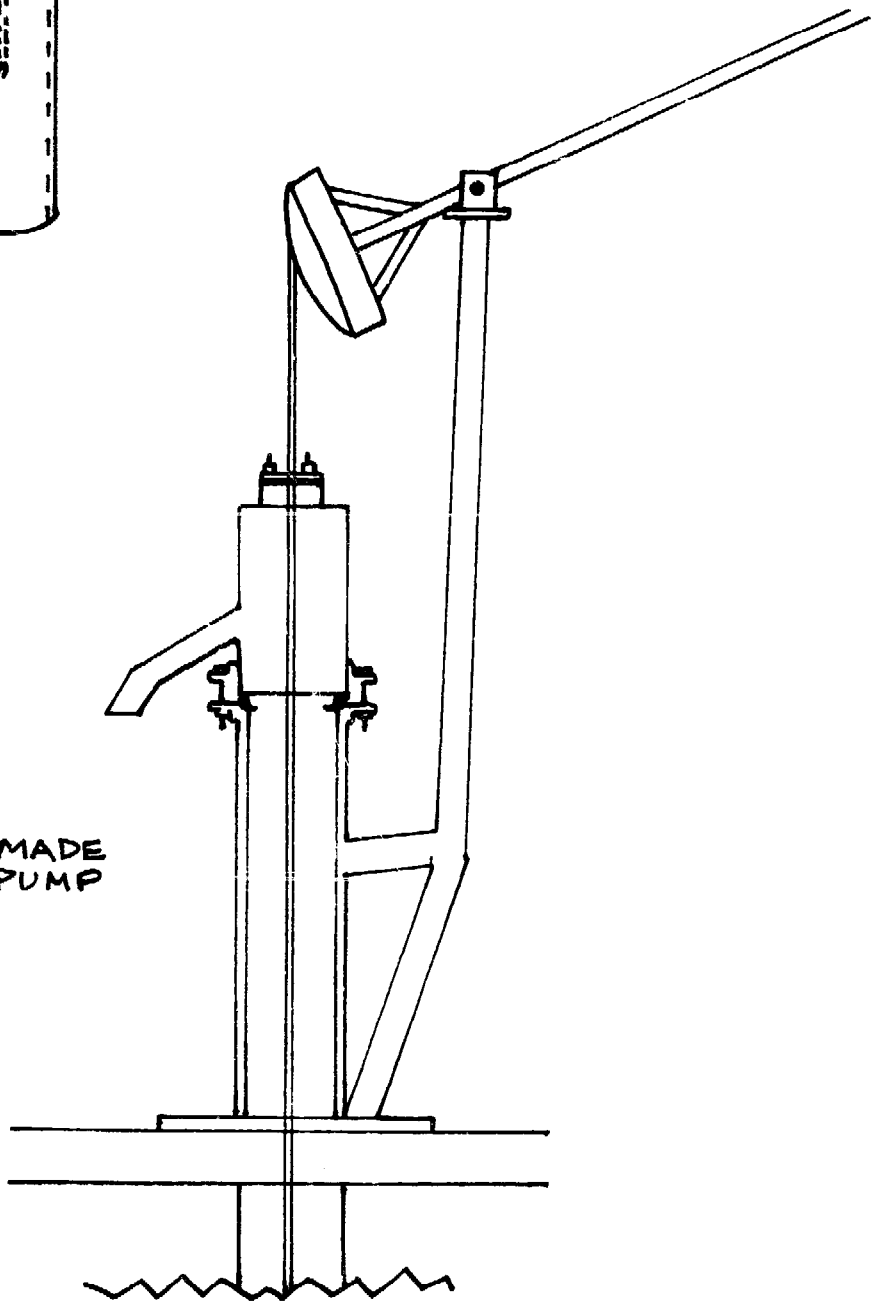

FIG. VII-8. LOCALLY MADE VARIATION OF JALNA PUMP

D. Other Types of Pumps

There are too many other types of water pumps to mention all of them here, but a few should be briefly noted.

1. Diaphragm Pumps

Diaphragm pumps operate similarly to piston pumps with the diaphragm going up and down causing water to move through the pump as two valves alternately open and close. (See Fig. VII-9.)

They offer several advantages:

- There is no sliding friction of a seal rubbing against a cylinder wall as in a piston pump.
- Particles as big as the valve openings can be pumped, with little or no damage to the pump.
- A small capacity pump of this type could be easily manufactured by a local machine shop.

There is also one chief disadvantage:

- An uneven stress is exerted on the diaphragm causing it to wear more quickly around the piston.

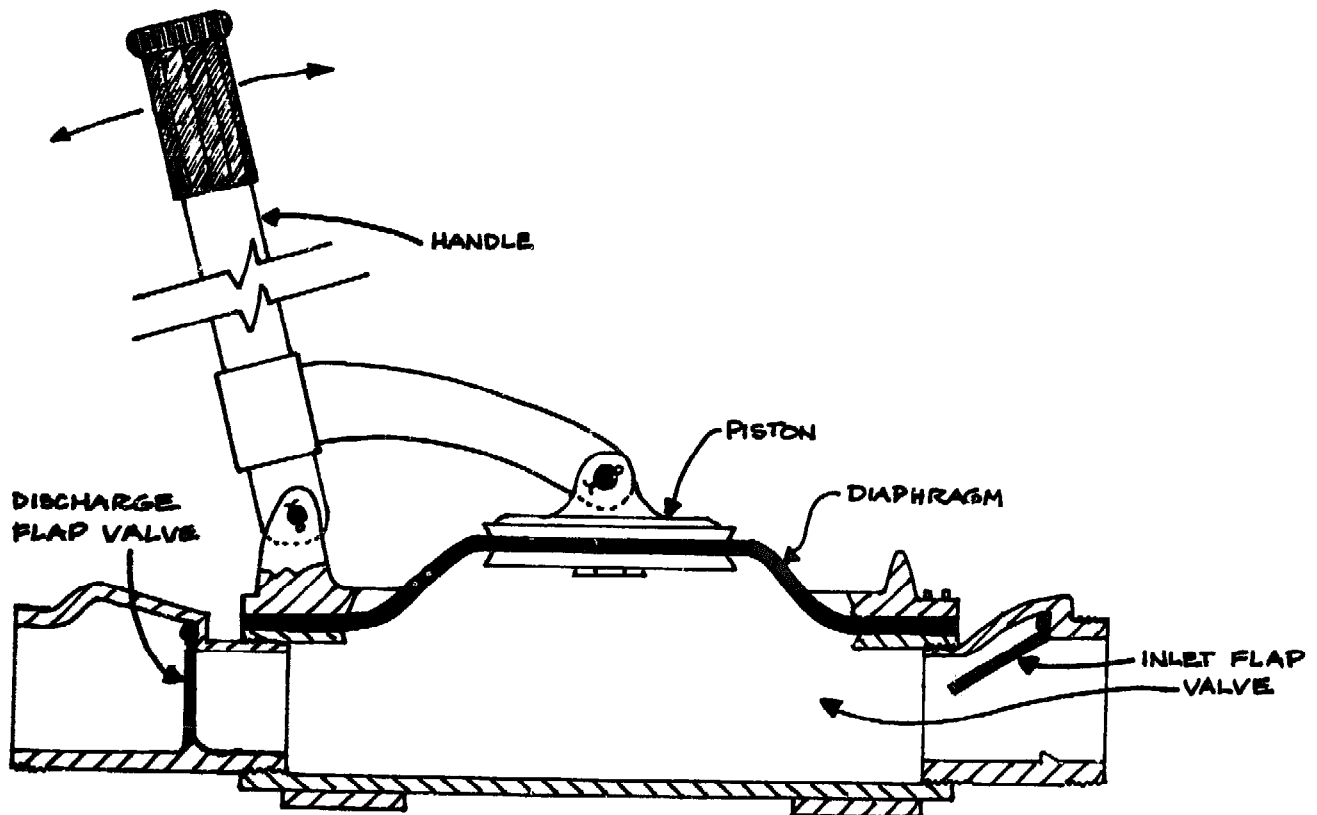

FIG. VII-9. DIAPHRAGM PUMP

2. Helical Rotor Pumps

This is a modern type of pump with a spiral-shaped interior design which is preferred in several developing countries because of the extremely limited amount of maintenance that is required despite the pump's high cost. It will pump almost anything that is capable of being forced through its pumping unit with little or no damage to it.

Two handles are used to drive the gear which turns the shaft with the rotor, on its bottom end, which turns inside a rubber stator to move water upward. (See Fig. VII-10.) The pump is designed in such a way that the weight of the water is supported on a set of bearings, as opposed to piston pumps which support the weight of the water through the pump rod and pump handle. Unlike standard rotary pumps, the height to which water can be pumped with a helical rotor is not determined by the speed of the pump.

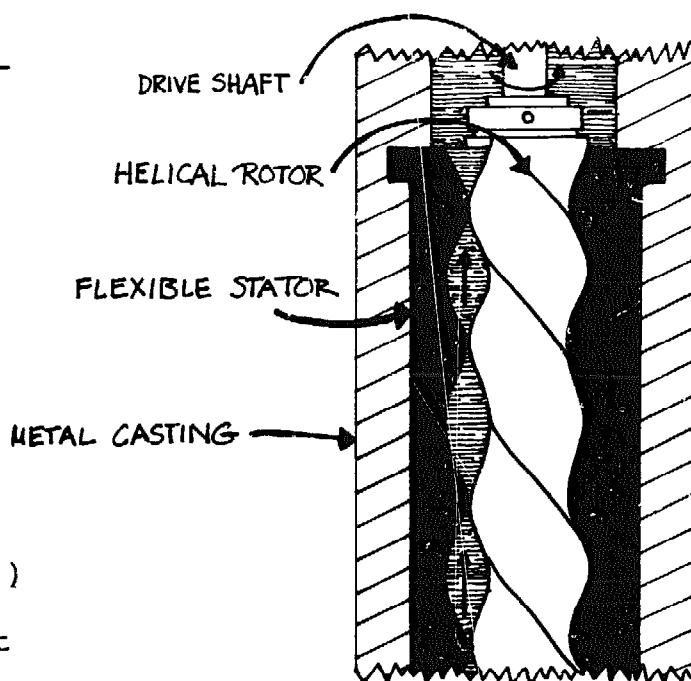
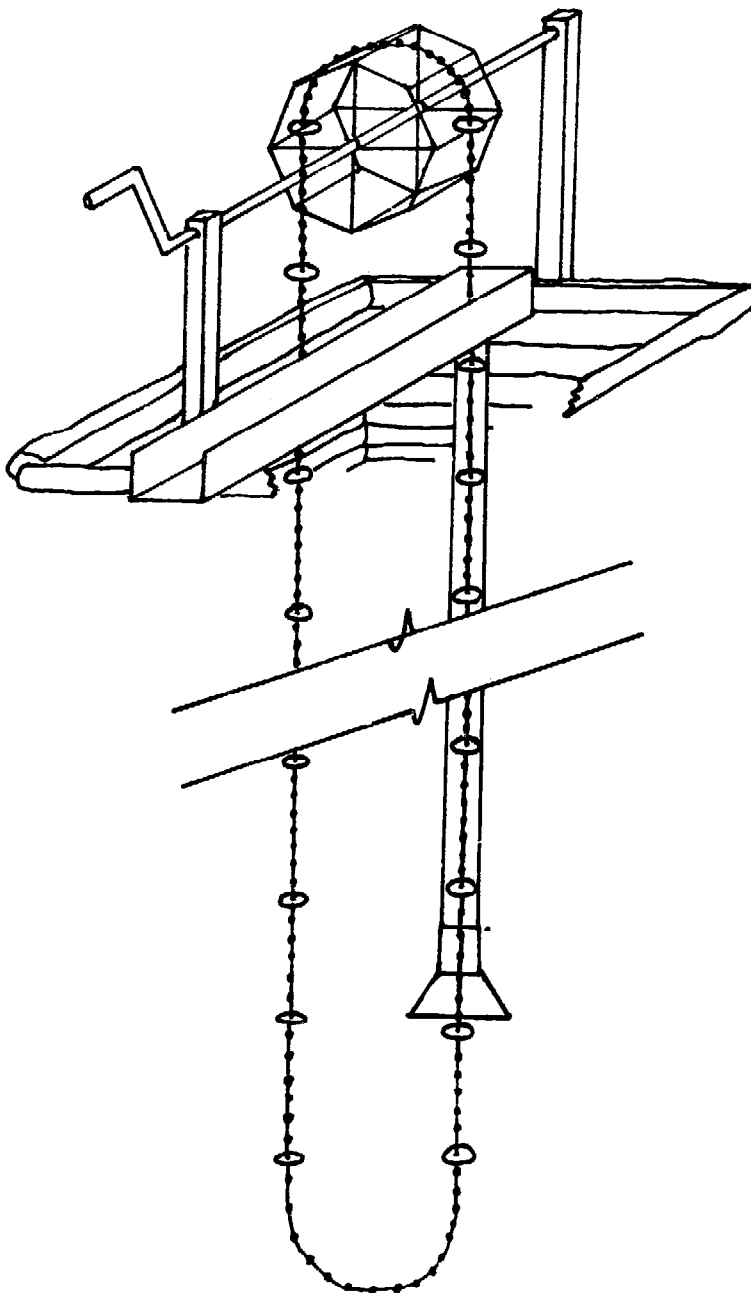
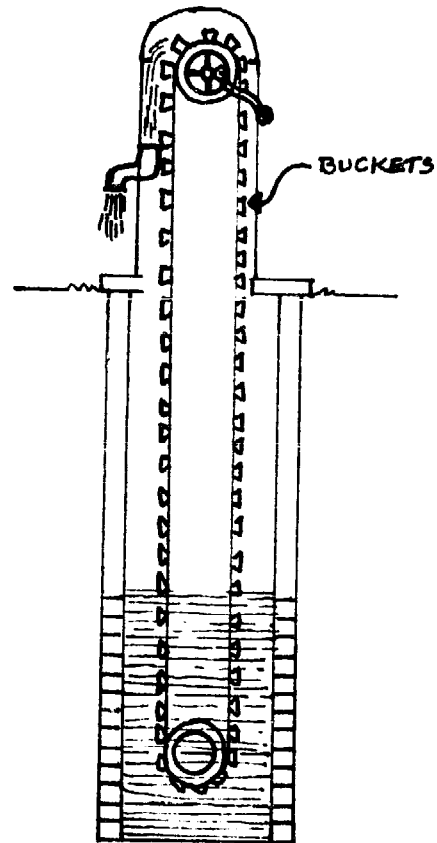

FIG. VII-10. HELICAL ROTOR PUMPING UNIT

FIG. VII-11. BUCKET PUMP

3. Bucket pumps

A series of buckets attached to a chain or rope pick up water and dump it into the spout as the handle is turned. This type of pump can be easily made from locally available materials. (See Fig. VII-11.)



4. Chain Pumps

Leather or rubber discs usually attached to a chain trap water in the pipe and push it up through the pipe to the spout as the handle is turned to move the chain. This type of pump can be readily modified to make it suitable for local manufacture. (See Fig. VII-12.)

FIG. VII-12. CHAIN PUMP

5. Motorized pumps

Motorized pumps are normally not appropriate for rural water supplies where a limited amount of water is needed. The energy required to power these pumps is usually expensive, not readily available or both.

The motorized pumps most commonly used for pumping water are:

- Centrifugal pumps which rely on an outside power source to turn a rotor fast enough to both lift and force water. (See Fig. VII-13.)

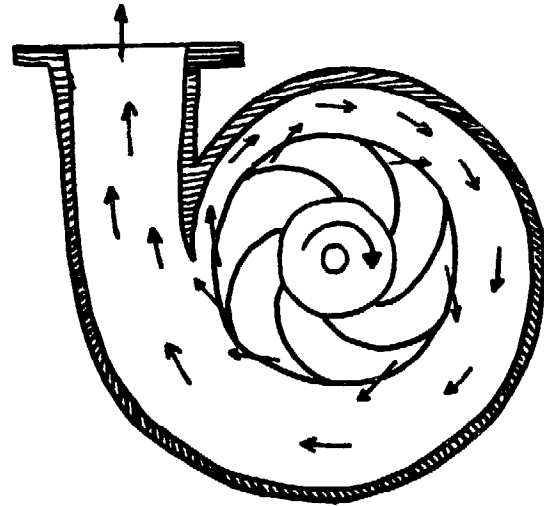
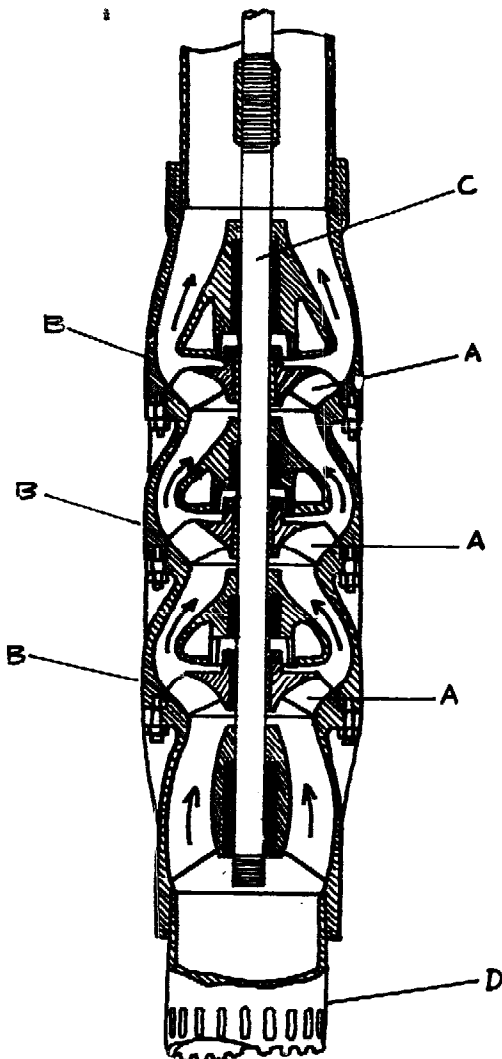

FIG. VII-13. CENTRIFUGAL PUMP

FIG. VII-14. TURBINE PUMP



- A- IMPELLERS
- B- STAGES
- C- SHAFT
- D- STRAINER

- Turbine pumps which also rely on an outside power source to turn a rotor fast enough to move the water. The turbine rotors must be submerged. (See Fig. VII-14.)

6. Hydraulic Rams

Hydraulic rams cannot be used to lift water from a well, but in the proper situation can be very useful in pumping water from one location to another. Rams are most often utilized to move water from an open body of water above the ram to a storage tank or cistern which is higher than the level of the open body of water.

E. Manufacturing a Pump

Another approach to the installation of pumps which has been successful in some areas is to purchase only that part of the complete pumping unit which needs to be carefully machined. The rest of the pump can be assembled from locally available materials, with the obvious advantages of familiarity and availability.

The most widely used pump of this type is composed of a cylinder assembly, purchased from a manufacturer, attached to locally available galvanized drop pipe. The pump stand, handle and spout can be assembled from wood and pipe. (See Fig. VII-15.)

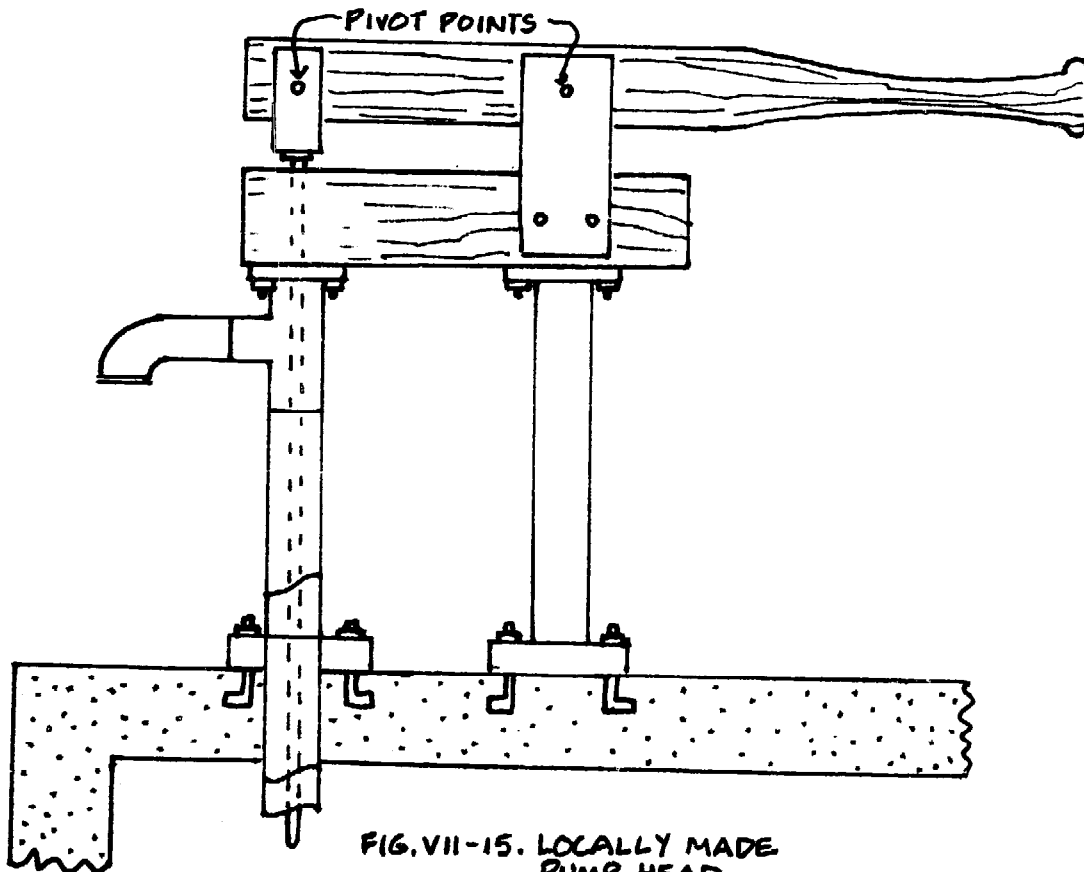

FIG. VII-15. LOCALLY MADE PUMP HEAD

Appendix VIII

WATER TREATMENT IN WELLSA. Well Disinfection

After a well is built, the whole structure should be carefully disinfected. Disinfection is needed to kill any possibly harmful bacteria that could be transferred from the pipe or concrete lining to the water and then on to the people who consume the water.

The well can be disinfected by adding enough chlorine to the well water to produce a strong chlorine solution. This solution can then be used to rinse off the rest of the well and so disinfect it.

1. First, the volume of the water in the well will have to be determined.

NOTE: The volume of water in a circular well can be easily computed by measuring the depth of the water and the diameter of the well. Multiply (water depth) x (1/2 diameter) x (1/2 diameter) x (3.1416). Expressed another way this becomes: $\text{Volume} = (\text{depth})(\text{radius})^2(3.1416)$.

2. From Table VIII-1 find the amount of chlorine that will have to be added to the computed volume of water to produce a strong chlorine solution.

3. Dissolve the required amount of the chemical in a bucket of water before adding it to the well. Add no more than 100 g of bleaching powder or calcium hypochlorite to each bucket of water.

4. Pour the solution into the well. It is best to agitate the water to insure that the chlorine is evenly mixed.

5. The strong chlorine solution should be left in the well for at least 12 hours and preferably for 24. It must be stressed that this strong chlorine solution is not suitable for humans or animals.

6. After the 12 to 24 hour contact time, the strongly chlorinated water should be pumped from the well until the residual chlorine level is below 0.7 mg per liter of water. (See below.) The pumping equipment to be installed on the well can be disinfected by using it

to remove the excess chlorine. Choose a disposal place for the chlorine solution where it will have as little contact with plant and animal life as possible.

B. Water Disinfection

Water can be easily disinfected by adding to it one of several commonly available chemicals which contain chlorine. The most common type of household bleach is a mild chlorine solution which can be used to disinfect water.

The amount of chemical or solution needed to disinfect water will depend on the degree of contamination of the water and the amount of chlorine present in the chemical. However, in most cases where the water is clear with no suspended solid particles, the following disinfection procedure can be used.

1. Determine the volume of water to be disinfected.
2. Find the amount of chlorine compound that will be needed to disinfect that volume of water. (See Table VIII-2.)
3. Dissolve the required amount of chemical in a bucket of water before adding it to the water to be disinfected. Add no more than 100 g of bleaching powder or calcium hypochlorite to each bucket of water.
4. Pour the bucket of chlorine solution into the water to be disinfected. Agitate the water to ensure good mixing.
5. When the chlorine residual (See below.) in the water drops below 0.2 mg per liter, this disinfection procedure should be repeated.

C. Chlorine Residual

The chlorine residual is the amount of chlorine that is left in treated water. Chlorine is used up as it disinfects. Add enough chlorine to the water so that there is a little left over (the residual) after the chlorine has had at least 30 minutes to react with and kill all the living organisms in the water. This assures that all the disease causing bacteria have been destroyed and that there is still some chlorine available to kill other contaminants which might enter the water at a later time.

The recommended chlorine residual is 0.5 mg per liter. A higher residual will cause an obvious chlorine taste in the water. Above 3.0 mg per liter chlorine concentration can cause diarrhea.

Chlorine residual is easily checked with any of the commercially available color comparators. Most of these use an "orthotolidine solution", which turns progressively more yellow at higher chlorine residuals.

TABLE VIII-1

AMOUNTS OF CHEMICALS REQUIRED FOR A
STRONG CHLORINE SOLUTION CAPABLE OF
DISINFECTING WELLS AFTER THEIR CONSTRUCTION*

Water (m ³)	Bleaching powder (25-35%) (g)	High strength calcium hypochlorite (70%) (g)	Liquid bleach (5% sodium hypochlorite) (ml)
0.1	10	4.3	60
0.12	12	5.2	72
0.15	15	6.5	90
0.2	20	8.6	120
0.25	25	11	150
0.3	30	13	180
0.4	40	17	240
0.5	50	22	300
0.6	60	26	360
0.7	70	30	420
0.8	80	34	480
1	100	43	600
1.2	120	52	720
1.5	150	65	900
2	200	86	1 200
2.5	250	110	1 500
3	300	130	1 800
4	400	170	2 400
5	500	220	3 000
6	600	260	3 600
7	700	300	4 200
8	800	340	4 800
10	1 000	430	6 000
12	1 200	520	7 200
15	1 500	650	9 000
20	2 000	860	12 000
30	3 000	1 300	18 000
40	4 000	1 700	24 000
50	5 000	2 200	30 000
60	6 000	2 600	
70	7 000	3 000	
80	8 000	3 400	
100	10 000	4 300	
120	12 000	5 200	
150	15 000	6 500	
200	20 000	8 600	
250	25 000	11 000	
300	30 000	13 000	
400	40 000	17 000	
500	50 000	22 000	

* This produces a chlorine concentration of approximately 30 mg/l (ppm). This water should not be drunk by people or animals.

TABLE VIII-2

AMOUNTS OF CHEMICALS NEEDED TO
DISINFECT A KNOWN QUANTITY OF
WATER FOR DRINKING*

Water (m ³)	Bleaching powder (25-35%) (g)	High strength calcium hypochlorite (70%) (g)	Liquid bleach (5% sodium hypochlorite) (ml)
1	2.3	1	14
1.2	3	1.2	17
1.5	3.5	1.5	21
2	5	2	28
2.5	6	2.5	35
3	7	3	42
4	9	4	56
5	12	5	70
6	14	6	84
7	16	7	98
8	19	8	110
10	23	10	140
12	28	12	170
15	35	15	210
20	50	20	280
30	70	30	420
40	90	40	560
50	120	50	700
60	140	60	840
70	160	70	980
80	190	80	1 100
100	230	100	1 400
120	280	120	1 700
150	350	150	2 100
200	470	200	2 800
250	580	250	3 500
300	700	300	4 200
400	940	400	5 600
500	1 170	500	7 000

* Approximate dose = 0.7 mg of applied chlorine per litre of water.

Appendix IX

ROPE STRENGTH

Nominal Diameter		Circumference	Rope Weight	Safe Working Capacity metric tons	
inches	cm	cm	kg. per m	No. 1 Manila	Sisal
1/4	.64	2.01	.03	.06	.05
3/8	.97	3.05	.06	.15	.12
1/2	1.27	3.99	.11	.29	.23
5/8	1.60	5.03	.20	.49	.39
3/4	1.91	6.00	.25	.60	.48
7/8	2.24	7.04	.28	.86	.69
1	2.54	7.98	.40	1.01	.81
1-1/8	2.87	9.02	.53	1.35	1.08
1-1/4	3.18	9.99	.62	1.52	1.21
1-1/2	3.81	11.97	.89	2.08	1.66
1-3/4	4.45	13.98	1.32	2.98	2.38
2	5.08	15.96	1.60	3.48	2.79
2-1/2	6.35	19.95	2.00	5.23	4.18
3	7.62	23.94	3.58	7.20	5.76

This chart is based on a similar chart found in Engineer Field Data (1969) FM5-34, Headquarters Department of the Army, 554 pp. The original chart was given in English units which have here been converted to metric units.

The safe loads listed are for new rope used under favorable conditions. These have been calculated by dividing the breaking strength of the rope by 4. As rope ages or deteriorates, progressively reduce safe loads to one-half of the values given.

Here is an example of how the chart can be used.

A 1 meter high lining ring 10 cm thick with a 1.2 m interior diameter contains 0.41 m³ of concrete. Since concrete normally weighs about 2300 kg. per m³ the lining ring weighs about 943 kg. or 0.943 tons. A new manila rope with a diameter of at least 2.54 cm and a circumference of 7.98 cm will be needed to safely handle the lining ring.

GLOSSARY

apron - A slightly sloped concrete pad which surrounds the well and helps prevent contaminated surface water from finding its way back into the well.

aquifer - A water-bearing layer (stratum) of permeable rock, sand, or gravel.

artesian well - A well that reaches water which, from internal pressure, flows up like a fountain.

bit - The piece which operates at the bottom end of the tool string to loosen the soil or rock to deepen the hole.

bottom plug - A concrete slab across the bottom of a well which can act to prevent anything from entering the well or allow only water to enter.

bottom section - That part of the well that extends beneath the water table.

brake post - An anchored cylindrical object which can act as a friction brake for rope wrapped around it.

casing - Metal pipe used to reinforce a drilled well.

cement - A gray powder used as an ingredient in mortar and concrete.

concrete - A hard strong building material made by mixing cement, sand and gravel with sufficient water to cause the cement to set and bind the entire mass.

consolidated ground formation - Any of the various kinds of rock; hard rock; examples: granite.

contaminate - To make impure or unclean.

curb - A part of the well lining that extends out from the lining into the surrounding soil, helps to hold it in place and prevents it from sliding down.

cutting ring - A sharp edged ring used on the bottom of a lining that is being sunk into place to make sinking easier.

development - See well development.

drive cap - A strong protective covering, screwed on to the top of a metal casing pipe and then struck to drive the pipe into the ground.

drop pipe - That section of pipe in a deep well pump assembly which extends between the pump cylinder and the pump body.

foot valve - A valve at the bottom of the suction pipe which prevents the water pulled up into it by the cylinder from flowing back into the well.

form - The structure or material around or in which concrete will exactly conform to.

ground water - Water deep enough in the ground so that it cannot be drawn off by plants or evaporated out through the ground surface; accumulates in quantity in aquifers from which it can be drawn out of the ground through wells.

grout seal - Mortar or concrete used to fill in a space to make it waterproof.

head wall - A short wall which extends above the ground level around a well.

hydrologic cycle - Continual natural cycle through which water moves from oceans to clouds to ground and ultimately back to oceans.

impermeable - A substance through which water cannot penetrate.

intake section - That part of the bottom section through which water enters the well.

laterite - A residual product of rock decay that is red in color; prevalent in Africa; difficult to penetrate but has little strength for construction purposes.

level - (Adj.) perfectly horizontal; (noun) a device used to establish a perfectly horizontal line.

lining - Masonry wall built to reinforce dug well hole walls.

lining ring - A hollow circular column, usually made of concrete, which is used to reinforce a dug well.

- middle section - That part of the well between the ground surface and the water table.
- mold - Form used in the construction of linings and lining rings.
- percussion - The act of tapping sharply.
- permeability - The speed which water can move through a certain type of soil or rock. Water will move much faster through sand than it will through clay so the sand is said to be more permeable.
- platform - See apron.
- plumb - Perfectly straight down or up.
- pump cylinder - That part of the pump in which the piston and cup seals slide to move water.
- sinking method - Any technique used to dig or drill a well.
- stable ground - Firm soil; not likely to cave in.
- suction pipe - That part of the pump assembly which extends beneath the cylinder into water.
- surface recharge - The amount of water that soaks down through the ground to reach an aquifer in a certain length of time.
- surface water - Water that is found on the ground surface in puddles, streams, rivers, lakes or oceans.
- surge plunger - A device that can be inserted into the casing pipe and is moved up and down to develop the well.
- swivel connection - A device used to connect two pipes or hoses and which permits one or both to turn freely.
- tool string - The entire length of equipment and connections operated in the hole to sink a drilled well.
- top section - That part of the well above the ground surface.
- transpiration - The passage of water vapor from plants into the atmosphere.
- unconsolidated ground formation - any type of soil other than hard rock; examples: sand, gravel, clay.

valve - A structure that permits the movement of fluid in one direction only.

water source - Any place where people could possibly come to gather water; for example a well, spring, river, lake, reservoir, public tap, private home faucet.

water table - The upper limit of that portion of the ground which is wholly saturated with water.

watertight seal - An impermeable material used to prevent water from moving from one area to another.

well development - The process of rearranging the soil particles around the intake section of a well to permit easier and better water flow into the well.

ANNOTATED BIBLIOGRAPHY

Abramo, V.J., ed. Peace Corps Wells Manual for Volunteers (1972). ACTION/Peace Corps. Information Collection and Exchange, Washington, D. C. 20525, U.S.A. (Book, 135 pp.)

This is essentially a conference report written after a meeting of PCV's working on wells projects in W. Africa. General coverage of organization and techniques. Much good information, but sometimes difficult to locate. The scope is limited and occasionally omits variables that might apply in special cases. Now out of print.

Allesbrook, J.C.P. "Driven Tubewells", in Appropriate Technology (Vol. 4, No. 4, Feb 1978). Intermediate Technology Publications Ltd., 9 King Street, London WC2E 8HN, England. (Periodical Article, 2 pp.)

Short quick description of driven wells with an interesting method presented for making a drive point out of a piece of metal pipe.

_____. "Where Shall We Dig the Well?" in Appropriate Technology, (Vol. 4, No. 1, May 1977). Intermediate Technology Publications Ltd., 9 King Street, London WC2E 8HN, England. (Periodical Article, 3 pp.)

An overview of various geological situations and where one is likely to find water in them. Unfortunately, the article is helpful only if you know the geological conditions in a given area.

Anderson, Keith E. Water Well Handbook (1971). Missouri Water Well and Pump Contractors Assn., Inc., P.O. Box 250, Rolla, MO 65401, U.S.A. (Book, 281 pp.)

Intended as a reference book to supply all charts, tables and other data commonly needed by drillers, engineers and geologists working with water wells. Topics include mathematical formulas and conversion tables, water data, quality of water, cable tool drilling, rotary drilling, air rotary drilling, pipe and casing, pumps, electrical data, flow measurement, geology and hydraulics of wells, water supply and equipment. Because the book is meant for use in U.S., all sizes and measurements are in American terms, with limited use in developing countries. Although there are no "how-to" explanations, many of the tables are very informative.

Annual Report (1976). WHO, International Reference Centre for Community Water Supply, P.O. Box 140, 2260 Leidschendam, Netherlands. (Booklet, 48 pp.)

A description of activities of the IRC. They leave unclear just exactly who is to receive their efforts and what specific services they have to offer.

Assignment Children (April-Jun 1976). UNICEF, Carnets de l'enfance/Assignment Children, Palais Wilson, Case postale 11, 1211 Geneve 14, Suisse. (Quarterly Review, 131 pp.)

Several articles in a variety of languages about real needs and planning of water supply development in small communities. Interesting and useful discussion of successful approaches to the problem.

Chad Wells 1977 (1977). "Chad PCV Report." (Report, 27 pp.) A short history of the Peace Corps/Chad well drilling program up to 1977. Details are given on pump development. A good quick overview of methods and materials used, but readers must understand the technology. Fine drawings of an example well, and some of the equipment, plus lists of materials suppliers and references.

Community Water Supply and Excreta Disposal Situation in the Developing Countries; A Commentary (1970). World Health Organization, Distribution and Sales Service, 1211 Geneva 27, Switzerland. (Booklet, 11 pp.)

Comments and analysis of 1970 WHO survey to determine "water supply and excreta disposal conditions and needs in 75 developing countries." The booklet concludes that "It is hard to find a successful rural community water supply programme that did not involve active community participation."

Darrow, Ken and Rick Pam. Appropriate Technology Sourcebook (Nov 1976). AT Project, Volunteers in Asia, Box 4543, Stanford, CA 94305, U.S.A. (Book, 304 pp.)

A guide to practical plans and books for village and small community technology. Publications were chosen that provide enough practical information to be of significant help in understanding principles and in actually building the designs included. Highly recommended.

Denis, A. and N. Fernando. "Low Cost Tube Wells", in Appropriate Technology (Vol. 2, No. 4, Feb 1976). Intermediate Technology Publications Ltd., 9 King Street, London WC2E 8HN, England. (Periodical Article, 2 pp.)

This brief article lists simple drilling equipment, outline of procedures, and comparison of locally available materials for use as casing in a small diameter well. Be aware that the bamboo procedure outlined here was tried unsuccessfully according to Bruce Eaton, The Chief Driller's Report on JJCIP (q.v.).

Design and Control of Concrete Mixtures (July, 1978). 11th edition. Portland Cement Association, Old Orchard Rd., Skokie, Illinois 60076, U.S.A. (Report, 121 pp.)
Everything a reader would want to know about the properties and variables of concrete, telling everything about what you can and cannot do with concrete. Much of this information is not specifically useful for simple concrete work in developing countries, although it could be a source for design ideas.

Dulansey, Maryanne. Water Resource Development (March 1977). American Council of Voluntary Agencies for Foreign Service, Inc., Technical Assistance Information Clearing House (TAICH), 200 Park Avenue South, New York, N. Y. 10003, U.S.A. (Booklet, 23 pp. plus appendices.)

Offers a summary of the experience of U.S. non-profit organizations: their programs, results and recommendations. It was quickly put together for water conference, citing the large amount of work done by NGO's and recommending that they be coordinated for future efforts.

Eaton, Bruce. The Chief Driller's Report on JCCIP (June 1976). Agricultural Development Agencies in Bangladesh, 549F, Road 14, Dhanmandi, Dacca-5, Bangladesh. (Booklet, 29 pp.)

A comparison of 20 wells completed with different kinds of equipment and using different techniques. The booklet emphasizes that when propellor pumps are installed directly in a PVC casing, the casing acts as a riser pipe and does not work very well for a number of reasons. Booklet offers a comparison of several different drilling and developing methods, and it is recommended for appropriate drilling projects.

Freedman, Ben. Sanitarian's Handbook (1977) 4th edition. Peerless Publishing Co., P.O. Box 30187, New Orleans, Louisiana 70130, U.S.A.

Gives you everything you need to know about sanitation. Mostly geared to U.S., but a wealth of good basic information, including 180 pages on water. It is highly technical, and the non-specialist can get most of the information elsewhere.

Gibson, U.P. and R.D. Singer. Water Wells Manual (Jan 1969). Premier Press, Box 4438, Berkeley, CA 94704, U.S.A. (Booklet, 156 pp.)

This booklet (formerly Small Wells Manual, published by USAID), covers exploration and development of ground-water supplies. Discusses wells up to 4 inches in diameter, 100 feet deep, with yields up to 50 U.S. gal./min. Much of the technical information on drilling is taken from Ground Water and Wells (q.v.), plus descriptions of some less technical drilling methods. Requires a good knowledge of English and a technical orientation.

Gordon, R.W. Water Well Drilling with Cable Tools (1958).
Bucyrus-Erie Company, 1100 Milwaukee Ave., South
Milwaukee, Wisconsin 53172, U.S.A. (Book, 230 pp.)

Excellent book, describing cable-tool drilling equipment and procedures, but it is needed only by people working with an actual rig they must become familiar with.

Ground Water and Wells: A Reference Book for The Water-Well Industry (1975). UOP-Johnson, Universal Oil Products, Johnson Division, St. Paul, MN 55165, U.S.A. (Book, 440 pp.)

An excellent book for anyone working with wells, specifically with drilled wells. Generally acknowledged as the basic reference work on drilled wells.

Guidelines and Criteria for Community Water Supplies in the Developing Countries (1969). USAID and USPHS, Development Information Center, DS/DIU/DI, Room 105, SA 18, Agency for International Development, Washington, D. C. 20523, U.S.A. (Book, 101 pp.)

Offers data on water supply programs in 12 developing countries in various parts of the world, although Africa is excluded. Makes recommendations for development and planning of large water supply programs. Sometimes written in a hard-to-read format, but ten years ago this study came to conclusions that were ahead of its time and have still not been effectuated. The book concludes that design of water supply systems must take into account the people who will be using them and that what works in a developed country is often not appropriate in a developing country.

Huisman, L. and W. Wood. Slow Sand Filtration (1974).
World Health Organization, Distribution and Sales Service,
1211 Geneva 27, Switzerland. (Booklet, 11 pp.)

Intended as a defense of slow-sand filtration for large treatment systems. Chiefly a discussion of large-scale slow-sand filtration, useful and appropriate in many areas. Offers excellent basics on slow-sand filtration. Tells how it works and how to build slow-sand filter, although no simple plans are given for a small scale filter, probably because the authors feel that such filtration can be more efficiently and effectively done on a large scale.

Karr, William V. Ground Water: Methods of Extraction and Construction (1969). International Underground Water Institute. Contact: Ranney Water Systems, Inc., 1134 Corrugated Way, Columbus, OH 43201, U.S.A. (Book, 95 pp.)

Academic presentation of radial collection well techniques, for those who might possibly use one for large water supplies. Covers large diameter caissons sunk an average of 30 m, with 18 to 24 inch thick walls.

Kear, D. and B.L. Wood. The Geology and Hydrology of Western Samoa (1959). New Zealand Geological Survey. Geological Survey Division, Department of Scientific and Industrial Research, Private Bag, Wellington, New Zealand, Attention: Publications. (Book, 92 pp. plus maps.)

An excellent, moderate-level presentation and discussion on the availability of fresh water on islands. To quote from the book, "The basic theoretical factors in the general area of underground water are described; the possible sources of water in Samoa are listed and described; the technical, administrative, and educational requirements of Samoan water supply are discussed; the present supply position is reviewed; and the suggested sources of supply are given for most of the Territory." This may not be available.

Leopold, Luna and Walter B. Langbein. A Primer on Water (1960, 1966). Geological Survey, available from Superintendent of Documents, U.S. Government Printing Office, Washington, D.C. 20402, U.S.A. for \$0.35. (Booklet, 50 pp.)

An introduction to water and where it comes from, intended for use by the average American citizen who has never had to think about water because it always comes from the faucet.

Mann, H.J. and D. Williamson. Water Treatment and Sanitation (Jan 1976). Revised edition. Intermediate Technology Publications Ltd., 9 King Street, London WC2E 8HN, England. (Booklet, 90 pp.)

Mostly an overview of basics, but the booklet offers 21 pages on water testing and treatment, with emphasis on sand filtration. It also includes information on measuring water flow, pumps, latrines, sewage treatment, and final disposal of waste, but a field worker could not treat water using this manual alone.

Manual of Individual Water Supply Systems (1975). USEPA reprint. U.S. Environmental Protection Agency, Water Supply Division, Washington, D.C. 20460, U.S.A. (Book, 155 pp.)

This book offers basic information, primarily on drilled wells, to a homeowner wishing to understand more about his or her water system. It emphasizes sanitary protection of water sources, and is an interesting overview of the different systems one could build. It is not meant to be a "how-to" manual.

Matthias, A.J. and E. Smith. How to Design and Install Plumbing (1967). 4th edition, revised. American Technical Society, 5608 S. Stony Island Ave., Chicago, Illinois 60637, U.S.A. (Book, 446 pp.)

Overview of what to look for and roughly how to plan plumbing systems in various situations. Does not offer "how-to" descriptions of the actual work involved to cut, thread, or otherwise connect pipe, and assumes availability of manufactured pipe and joints.

McJunkin, F. Hand Pumps for Use in Drinking Water Supplies in Developing Countries (1977). WHO, International Reference Centre for Community Water Supply, P.O. Box 140, 2260 Leidschendam, Netherlands. (Book, 230 pp.)

This book is an excellent introduction and analysis of the technical aspects of hand pumps, including quite a bit of detail. Offers the state-of-the-art on manufactured hand pumps and some mention of locally made pumps. Gives a good idea of what is available, how it is designed, and why designs are as they are. Free if requested from developing countries; otherwise, \$8.00.

McJunkin, F.E. Surveillance of Drinking Water Quality (1976). World Health Organization, Distribution and Sales Service, 1211 Geneva 27, Switzerland. (Book, 135 pp.)

This book offers ". . . information and guidelines for planning, organizing, and operating programmes for surveillance of drinking-water quality at the national or regional level in developing countries." It is more oriented toward organizing a national water quality program, although there is some good detailed information on relatively simple methods of water testing and what it means, the significance of large planning and some good "how-to" methodology. You will learn that disinfection, usually with chlorine, is relatively simple, easy to monitor, and the single most effective water treatment technique.

McJunkin, F.E. and C.S. Pineo. The Role of Plastic Pipe in Developing Countries (1969). USAID. Development Information Center, DS/DIU/DI, Room 105, SA 18, Agency for International Development, Washington, D. C. 20523, U.S.A. (Book, 150 pp.)

The premise of this book is that because pipe is the single major component of most water supply systems, the cost of construction of these systems could be reduced if the pipe were manufactured in the country. Book is intended as an awareness piece for decision makers and engineers and "should enable the reader to (1) weigh the merits of plastic as a pipe material, (2) quickly acquire an awareness of the state of the art, (3) prepare design criteria and standards and specifications for manufacture, testing and installation of plastic pipe, (4) organize a testing program, and (5) undertake preliminary feasibility studies of manufacture and marketing of plastic pipe." It has limited use as a field document.

Miller, Arthur P. Water and Man's Health (Jul 1967). USAID reprint. Development Information Center, DS/DIU/DI, Room 105, SA 18, Agency for International Development, Washington, D. C. 20523, U.S.A. (Book, 92 pp.)

Now out of print but many copies are still around in Peace Corps or AID offices. An excellent presentation of background information on specific water-related diseases; water's relatedness to disease; the seriousness of water transmitted disease; method of transmission; the history of discovery of causative agents; human susceptibility to water-borne disease; and methods of control. Offers information on chemical pollutants as a likely source of water contamination, the resulting physical conditions from overdoses, and recommended maximum concentrations in drinking water. This book is now being rewritten by F.E. McJunkin and is expected to be available by late 1980.

More Water for Arid Lands (1974). National Academy of Sciences, 2101 Constitution Ave., Washington, D.C. 20418, U.S.A. (Book, 153 pp.)

Report of an ad-hoc panel of the Advisory Committee on Technical Innovation, Board on Science and Technology for International Development, Commission on International Relations. Discusses "little known but promising technologies for the use and conservation of scarce water supplies in arid areas . . . The technologies discussed should, at present, be seen as supplements to, not substitutes for, standard large-scale water supply and management methods." A most useful overview of techniques that can be used for water supply and water conservation in arid areas, but offering no real "how-to" information. A good bibliography for readings in selected areas, and a French edition is available.

Okun, D.A. and G. Ponghis. Community Wastewater Collection and Disposal (1975). World Health Organization, Distribution and Sales Service, 1211 Geneva 27, Switzerland. (Book, 285 pp.)

A description of large-scale sewage treatment plant design and construction. Good information on hydraulics, laying pipe, and water treatment.

Pacey, Arnold. Hand-Pump Maintenance in the Context of Community Well Projects (1978). Intermediate Technology Publications Ltd., 9 King Street, London WC2E 8HN, England. (Booklet, 38 pp.)

This presents the basics of a hand-pump installation program needed for a supply of clean water from wells, offering a choice between three different levels of technology and their concurrent levels of local community involvement. Probably the best introduction to pumps, since it deals with community aspects and not just with technology. Highly recommended.

Rajagopalan, S. and M.A. Shiffman. Guide to Simple Sanitary Measures for the Control of Enteric Diseases (1974).
World Health Organization, Distribution and Sales Service,
1211 Geneva 27, Switzerland. (Booklet, 103 pp.)

Good, practical plans and things to look for in constructing and maintaining sanitary water sources, concentrating on methods of simple disinfection with chlorine.

Shallow Wells, Shenyanga Region, Third Progress Report (1976).
Governments of Tanzania and Netherlands. (Booklet, 55 pp.)

A description of a wells project in the Shenyanga region of Tanzania. Interesting quick discussion of a large project which dug wells, lined them with pre-cast concrete rings, and installed a locally manufactured hand pump. Offers good plans and detailed descriptions of equipment and work.

Sternberg, Y. and R. Knight. Development of PVC Well Screens for Local Fabrication in Developing Countries (1978).

Public Utilities Report No. RES14. International Bank for Reconstruction and Development, 1018 H St., N.W., Washington, D.C. 20006, U.S.A. (Working Paper, 8 pp.)

This paper describes the development and manufacture of a continuously slotted well screen made of specially reinforced PVC pipe. Where PVC is extruded and where motorized lathes are used, these well screens might be produced at low cost. This may be a new breakthrough in well screen manufacture, and it is now being field tested.

Wagner, E.G. and J.N. Lanoix. Water Supply for Rural Areas and Small Communities (1959). World Health Organization, Distribution and Sales Service, 1211 Geneva 27, Switzerland. (Book, 337 pp.)

The book is old, rapidly becoming outdated. It is expensive and oriented to larger pumps and distribution systems, but still probably serves as the basic reference book on the subject. Almost everything in the book is covered better and in more detail by some other book, but no other reference has all of the basics together and easily accessible in one place.

Walton, William C. Groundwater Resource Evaluation (1970). McGraw-Hill Press, 1221 Avenue of the Americas, New York, N.Y. 10020, U.S.A. (Book, 664 pp.)

This book offers equations and methods used to quantitatively appraise the hydrogeologic parameters affecting the water-yielding capacity of wells and aquifers, and those used "to quantitatively appraise the response of wells and aquifers to heavy pumping." A college-level engineering text.

Water Purification, Distribution, and Sewage Disposal for Peace Corps Volunteers (1969). Volunteers in Technical Assistance (VITA), 3706 Rhode Island Ave., Mt. Ranier, Maryland 20822, U.S.A. (Book, 243 pp.)

An early attempt at an appropriate technology manual on these subjects. The book answers most technical questions, but concentrates on a technical point of view without information on using locally available materials. There is much useful material, organized with lesson plans, but the book also includes some irrelevant material.

Water Resources Development-2 (1974). Action for Food Production (AFPRO), C-52, N.D.S.E. Part II, New Delhi - 110049, India. (Booklet, 72 pp.)

This booklet offers some "how-to" plans for several different water sources, including drilling wells by hollow rod system, a multiple-well scheme for irrigation, lined dug wells, and blasting procedures. The material is good, relatively simple, and geared to locally available material in India.

Water Well Journal. National Water Well Association, 500 W. Wilson Bridge Rd., Suite 130, Columbus, Ohio 43085 U.S.A. (Monthly periodical.)

Intended for commercial well drillers and water well equipment suppliers in the U.S. The magazine annually publishes a buyers' guide and a directory of manufacturers as well as offering interesting articles on new and old techniques and equipment, business and industry practices.

Watt, S. and W.E. Wood. Hand Dug Wells and Their Construction (1976). Intermediate Technology Publications Ltd., 9 King Street, London WC2E 8HN, England. (Book, 234 pp.)

The best book on hand dug wells available. Emphasis on one specific kind of dug well construction with concrete, but considerable description of alternative methods. Many useful pictures and drawings.

Well Drilling Operations (1965). Departments of the Army and the Air Force, TM-5-297/AFM85-23. Superintendent of Documents, U.S. Government Printing Office, Washington, D.C. 20402, U.S.A. (Book, 249 pp.)

This book offers about 50 pages of introductory discussion and material on hand-dug, bored, jetted, and driven wells. The rest is primarily a good basic discussion of cable tool and rotary rigs.

White, Anne U. and Chris Seviour. Rural Water Supply and Sanitation in Less-Developed Countries (1974). International Development Research Centre, Box 8500, Ottawa, Canada K1G 3H9. (Booklet, 81 pp., with annotated Bibliography.)

This booklet provides a good overview of the subject with perhaps more emphasis on the design and planning of projects than on actual "how-to" methods. It offers an excellent 5 page introduction on the history and development of water supply, and current trends.

Winter, G. and A.H. Nelson. Design of Concrete Structures (1973). McGraw-Hill Press, 1221 Avenue of the Americas, New York, N.Y. 10020, U.S.A. (Book, 615 pp.)

The text for a basic college level course in design with concrete. There is a lot of higher math in this book, but anyone with mechanical or engineering background can persist to figure out the exact design requirements of any concrete structure. Not recommended to those without solid technical education.

To avoid sending to Europe for publications from the Intermediate Technology Development Group or the World Health Organization, U.S. readers may order ITDG and WHO publications from the distributors indicated below:

ITDG distributors are:

International Scholarly Book Services, Inc.
P. O. Box 555
Forest Grove, Oregon 97116

WHO distributors are:

World Health Publication Center
49 Sheridan Avenue
Albany, New York 12210