

3Phase turbine kit

Home

Up

Turbine kit

Builders Corner

3Phase turbine kit

Educational Three phase turbine Kit

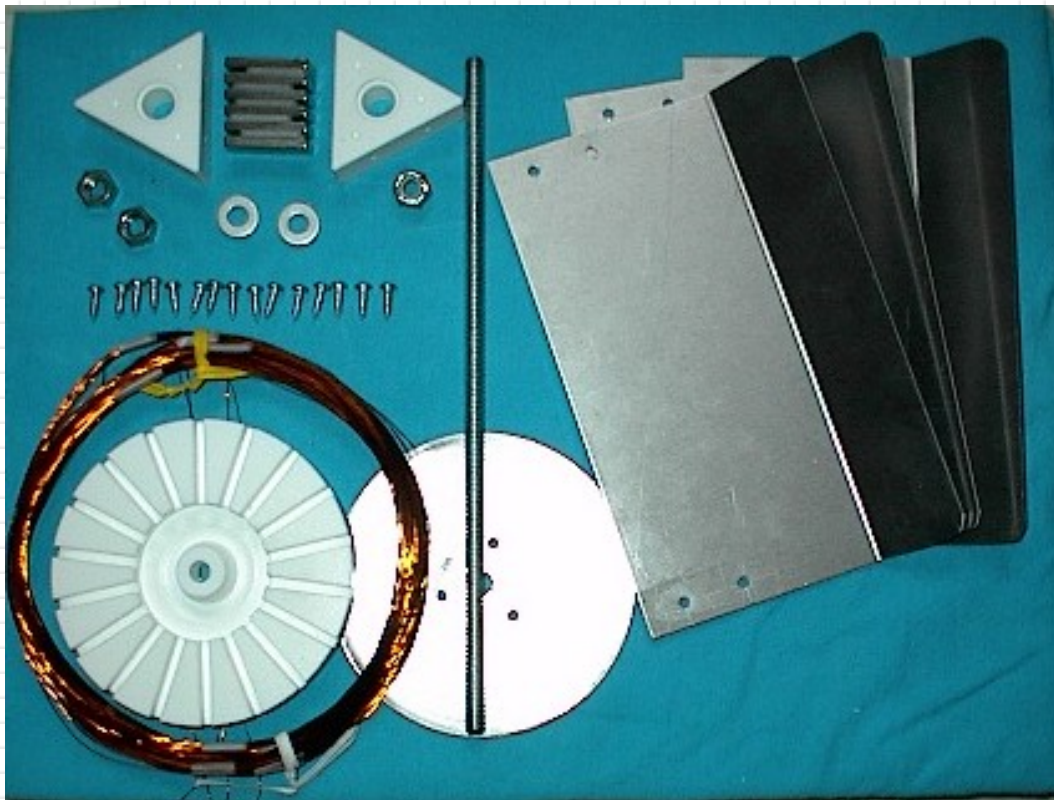

This kit comes with everything you need to assemble a 3 phase wind turbine. Including easy step by step instructions to build and wire it. The kit also includes 6 powerful neodymium magnets.

All for only \$29.50 plus 4.95 shipping

(shipping is in the US only - send email for calculating shipping to other countries)

The turbine stands approximately 8 inches tall and is 6 inches in diameter. Although not a real powerhouse, it will charge ni-cad batteries and run LED's without a problem. Only basic tools are needed for assembling the kit such as a drill, various drill bits, 7/16" wrenches, #1 phillips screwdriver. You will also need some tape and super glue.

Winding the coils has been made easy, using a slightly different approach that anyone can do. The slotted stator makes it very easy to hold the wires in place

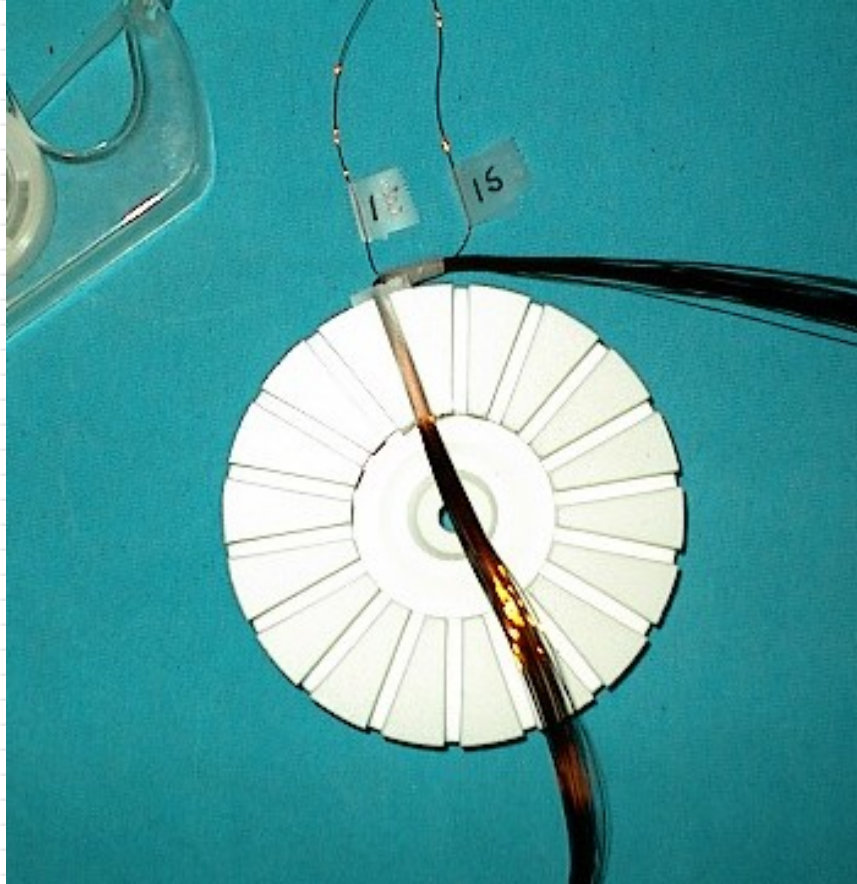

The base is up to you and can be a simple board with feet or a PVC plug to mount it on a pole.

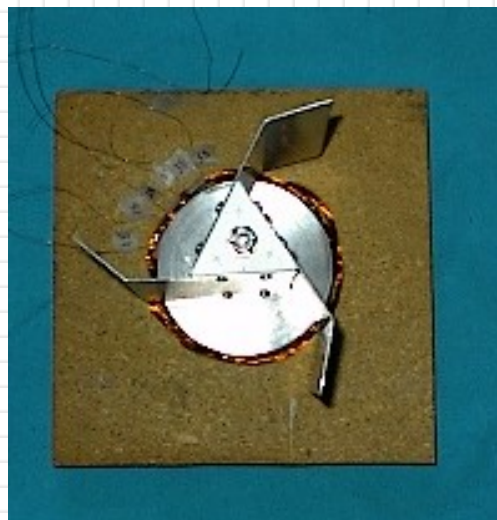

Very simple and fun to build!!! Order one today. If your an educator ask about

quantity discounts so all your students can learn.

You can download the instructions to see if its something you would like to build. The instructions are now in PDF format which makes it simple to print and use

[Click here for the download \(50k\)](#)

[Products](#)[Formulas](#)[Links](#)[Projects](#)[Blade design](#)[Basic Wind System](#)[3 Phase Basics](#)

119987

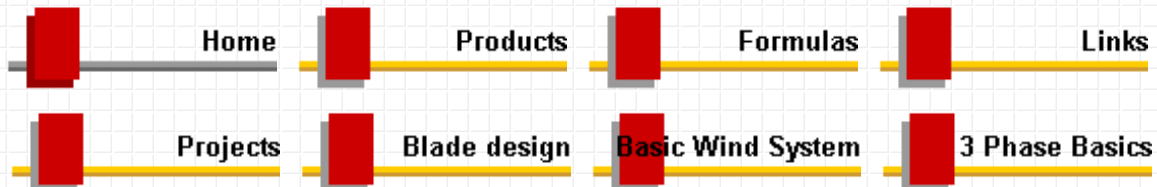

=> ***special : \$96.00 set of 16 large neodymium [click here](#)*** <=

Thanks for dropping by and Welcome!!!

As a dedicated "do it yourselfer" I put this site up for all those who share similar DIYS skills and convictions.

I hope what I have here helps you in your endeavors in some way, big or small.

This site is maintained using windpower only. My entire office is powered by the wind.

[Email me](#) But... you must include something specific to the site in the subject line. Any email that has a blank subject line will be deleted and therefore not answered.

[A semi-new Vawt... the "Lenz turbine"](#)

[New addition ...](#)

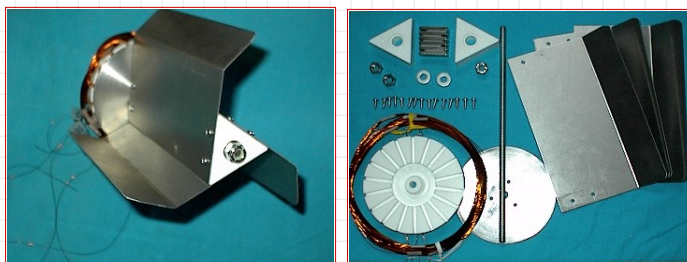

An educational 3 phase turbine kit. Comes with everything you need to create a 3phase wind turbine. Great for science projects, learning about 3phase PMG alternators, and alternative energy. The kit includes 6 very powerful neodymium magnets. Check it out!

Budget builders....



More Neodymium magnets for those on a budget. They make nice alternators as shown in the section "[Alt from scratch](#)"



These are the new magnets I've been working with. They have proved to be quite impressive for building the axial flux type alternators and for building motors for electric vehicles. I have a few extras for those interested in them. Click on the picture to go to the builders corner page.



The

original 6 ft turbine with a car alternator and chain drive. It was changed to the axial Flux type alternator and ended up being much more efficient and powerful. The chain drive was quite noisy because of the cogging in the modified alternator. It was in service for about 2 years and is now down for maintenance. Actually it will be refitted with a new alternator using the new magnets and the blades refurbished.



The downwind turbine, a very small but quite efficient little unit. This one was a bit more complicated to build but it features the star/delta controller (check the link on downwind turbine for more detail)



One of the original alternator modifications. This one had a rewind stator and the modified rotor using Neo' magnets.

Products

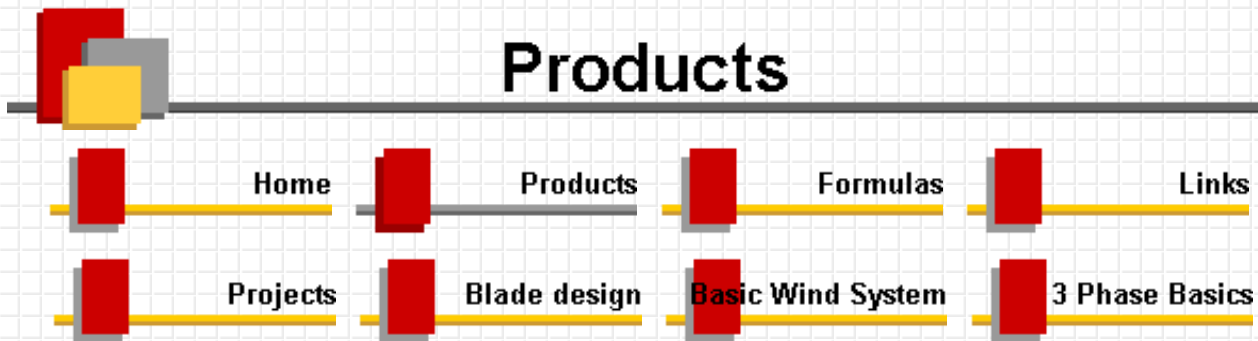

[Turbine kit](#)

[Builders Corner](#)

[3Phase turbine kit](#)

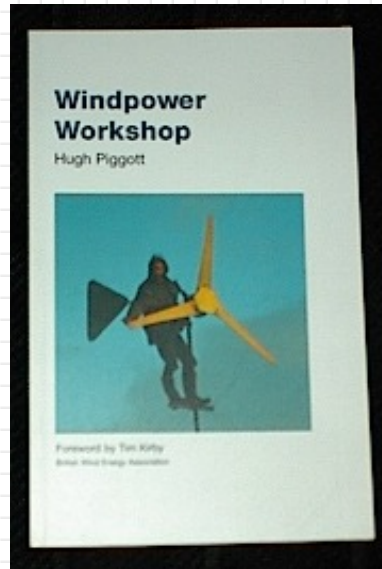

In stock and ready to ship!

This is the book I talk about allot through this web site. I found it very enlightening, easy to understand, and very well written. This book explains very clearly: what is involved in deciding whether a wind system is for you: how to design such a system: how to design and build your own wind generator from scrap and recycled parts. If your serious about getting involved with wind power this is one book you can't live without! The book is **\$18.95 and this includes shipping! (in the USA or Canada - email for other countries)**. Send an email to get a copy today! Or simply click on the "Buy Now" button to purchase through Pay Pal service.



These are no longer available. The page remains for an explanation of how it works for those wanting to build one themselves.



Builders Corner - parts and pieces

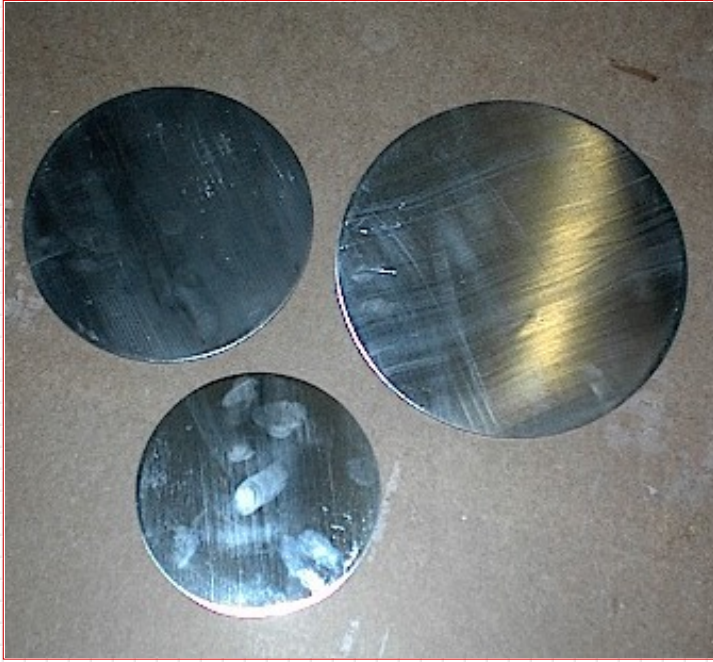

Turbine kit

Home

Up

Turbine kit

Builders Corner

3Phase turbine kit

Basic Wind turbine Kit...

This kit is no longer available. I have left the page in for reference to how it works and what it looks like.



Don't quite understand how it works? Read below.....

This is a self furling unit. The furling system is based on mother natures best

kept secret - gravity. When the wind reaches a certain speed, the unit self furls based on the tail weight.

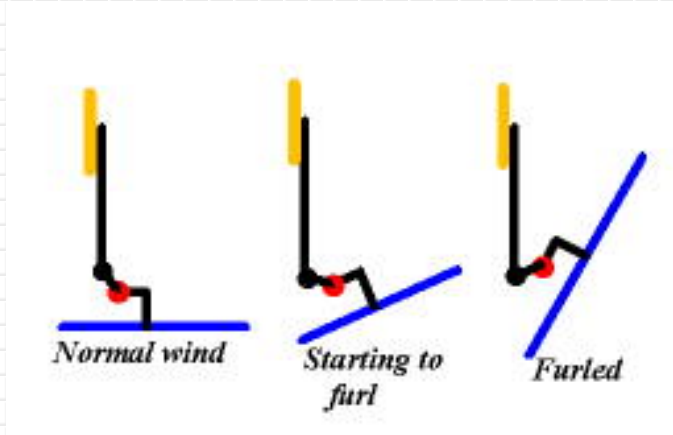

The way this works... The head pivot point and rotor shaft center are offset. The extent of the offset is determined by the diameter of the rotor. When the wind exerts itself against the rotor (Rotor Thrust) it wants to turn because of the offset head. The angle of the tail mount and weight of the tail determine the amount of resistance there is to this turning. The system is very similar to the "caster" angle used in automobiles, when you turn the wheel to the left or right, one side tends to lift the car. When you let go of the steering wheel the weight of the car tries to bring the wheels straight again. This is the same basics this wind turbine uses. The angles and weight are calculated to adjust the furling to any windspeed.

The Rotor thrust can be calculated by using the following formula.

$$\text{Rotor Thrust} = \text{Diameter}^2 * \text{Velocity}^2 / 24$$

Rotor thrust is in kg - to convert to lbs multiply kg by 2.2

To Calculate the tail weight or to find the tail mount angle... we need to know...

Rotor Offset (meters)

Diameter of Rotor (meters)

Wind Speed (meters/second)

Tail tip weight (kg)

Length of tail (meters)

Then we need to calculate....

$$\text{Rotor Thrust} = \text{Dia of Rotor}^2 * \text{Windspeed}^2 / 24$$

$$\text{Tail moment} = \text{Tail tip weight} * \text{Length of tail}$$

$$\text{Rotor moment} = \text{Rotor Thrust} * \text{Rotor offset}$$

$$\text{Tail mount Angle} = \sin^{-1}(\text{Rotor moment} / \text{Tail moment})$$

If you need to find the Tail tip weight at a given tailmount angle then...

Tail moment = Rotor moment / (sin(Angle in degrees))

Tail Weight = Tail moment / Length of tail

[email](#)

Builders Corner

[Home](#)[Up](#)[Turbine kit](#)[Builders Corner](#)[3Phase turbine kit](#)

I will be adding things as time goes on so keep checking back from time to time. If you would like to see other items that are not listed send me an email and let me know what your looking for...

Large Steel Discs

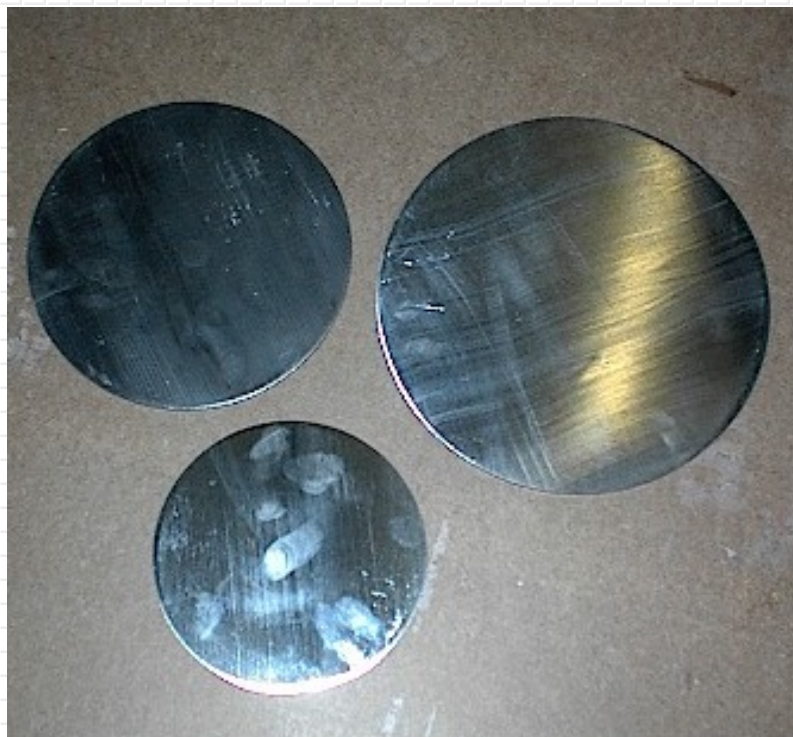

Steel Discs

I have 3 sizes available right now, 8 inch, 10 inch and 12 inch. All made from 1/4" steel plate. Great for prop mounting hubs, magnetic discs for use with an axial flux machine or a combination of both.

8 inch disc \$11.95

10 inch disc \$14.95

12 inch disc \$19.95

All are in stock and ready to ship !

There is no center hole in these but I will mark and center punch them so it will be easy to find and drill the center to any size you desire. If you know what size hole you need I can drill them for you but there will be a \$5.00 set up fee.

Very Large Neodymium Ring magnet sections

If your looking at making lots of power... and I do mean LOTS you may want to investigate the neodymium magnets I've been using for testing. One unit has achieved over 3500 watts using an 8 inch disc with 16 magnets. These are custom made and 16 magnets make an 8 inch OD ring with a 4 inch ID.



The above shows the magnets mounted on an 8 inch disc using 12 or 16 poles. They also fit nice on a 10 inch or the 12 inch discs I sell above.

NOTE: Under no circumstances should you attempt to assemble the rings without a steel backing. They are near impossible to get apart without destroying the magnets or your body!!!!

I have a limited supply of these so you may want to get them as long as their available.

These are rather expensive and are priced as follows...

\$6.50 each (normally 8.00 each)

or

\$96.00 set of 16

\$140.00 set of 24

\$180.00 set of 32

(while they last !!!)

Shipping included !! In the continental US only !! anywhere else please inquire about shipping costs.

Paypal payments accepted to elenz@windstuffnow.com

If your interested in any of these send send an email to elenz@windstuffnow.com .

Note: you must put a message in the subject line relating to this site or your email will be deleted and therefore not answered.

Smaller Magnets for the budget builders



These are the ones I used in my smaller alternators. Also, built a 400 watt unit for the 6ft prop with these shown in the Alt from Scratch section. They make nice inexpensive alternators for wind power.

They measure 1 inch x 1/2 inch x 1/8 inch thick

These are being sold for only **.99 cents each** so a batch of them won't break you. Buy them by the 100's

Ask about discounts for quantities over 100

If your interested **email me!** **Note: you must put a message in the subject line relating to this site or your email will be deleted and therefore not answered.**

Assembling your 3phase turbine Kit

Turbine Kit Parts List

- | | |
|----|--------------------------------------|
| 1 | 1 Stator (slotted thingy) |
| 2 | 2 Blade mounts (triangular plastic) |
| 3 | 1 8 inch x ¼ inch threaded rod |
| 4 | 2 ¼ inch standard nuts |
| 5 | 1 ¼ inch nyloc nut |
| 6 | 2 ¼ inch washers |
| 7 | 3 Aluminum Blades |
| 8 | 6 Neodymium magnets 1" x .5" x 1/8" |
| 9 | 3 50 turn coils of magnet wire |
| 10 | 15 #4 x ¼ phillips head screws |
| 11 | 6 N4001 diodes |
| 12 | 1 3 ½ " steel disc |

Tools you will need to assemble this kit

Drill

3/32 drill bit

1/8 drill bit

¼ drill bit

#1 Phillips screwdriver

Pliers

7/16" wrench

Tape

Super glue

Mild grease or oil

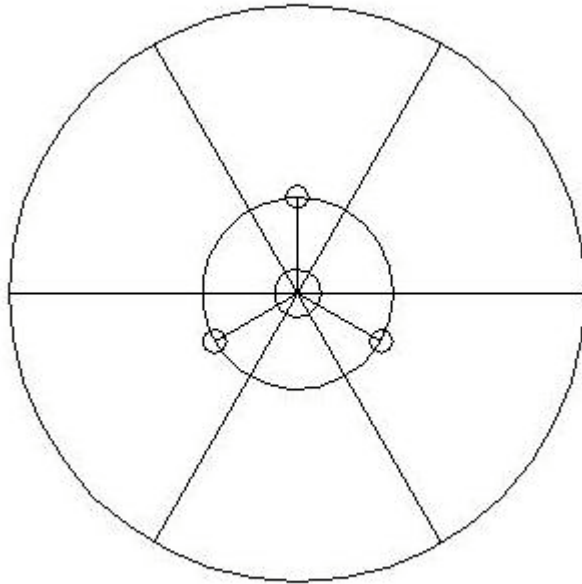

Start by finding the steel disc and cut out the template above. A flashlight is handy to line up the center hole. Lay the steel disc on the flashlight and lay the template over the disc. Line up the center hole with the light shining through the hole. This will center the template. Tape the template in place and use a center punch to mark the 3 holes. Use a marker to mark the lines on the disc where the magnets will be placed. Remove the template and drill the marked 3 hole locations using a 1/8 inch drill bit. When this is done take a ruler and connect all the lines on the disc. This will be the placement of the magnets. The two triangles have small divits in the sides and top. Use a 3/32" drill bit to drill into these divits.

Continue by locating the steel disc, triangles, 2 washers and threaded rod as well as the 2 standard nuts as shown below.



Take one of the nuts and screw it on the threaded rod about 2 inches down. Place one of the washers on the rod and one of the triangles with the washer groove toward the washer. Place the second triangle on the other one with the washer groove up as well as another washer. Install the steel disc with the lines showing and install a nut. Line up the 3 holes in the steel disc with the 3 holes in the triangle. Install the 3 screws to hold the disc in place. This assembly is to assure the disc is centered on the triangle. Below shows the assembly jig assembled.

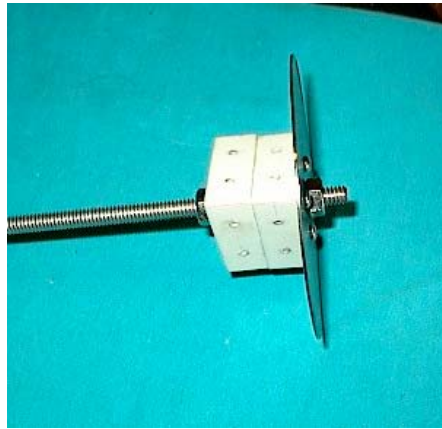

Remove the disc and triangles from the rod and find the 3 turbine blades. Install one turbine blade on the triangle attached to the disc. Attach the other triangle to the top of the blade. Make sure you have the washer groove upward and the triangle lines up with the blade. Below shows the first blade assembled and the turbine assembled.



Flip the unit over showing the steel disc and find the magnets. The magnets have to be placed on the disc with alternating poles. Such as North, South, North, South etc. It really doesn't matter which is north or south as long as they alternate. The simplest way

to do this is to place the first magnet down on the disc centering in on one of the lines. These can be superglued in place if necessary.



Take the next magnet and hold it a distance away from the magnet already on the disc, If it attracts then flip it over... it should repel. This is the way it should go down on the next line same as the first. Remember the magnet should repel the one before it. The rest of the magnets can be installed at this point. When you get to the fifth one it's a good idea to double check your work using the last one to test the poles. Circling the poles one should attract the next repel and so on. The last magnet will repel both the ones beside it.



This portion of the turbine is completed for now. Set this aside and find the 3 coils of wire and the stator (slotted plastic thingy). As shown below...



Untwist the coils and take one from the three. Notice there are two wires coming out from the coil. One wire is short and one is longer. When installing the coils the short wire should be on the right hand side. The short wire represents the “Start” of the coil and the long one is the “End” of the coil. Using some tape and a marker label the ends of the coil 1S and 1E. A fine point sharpie works nice for this. Below shows the coil with the ends labeled...

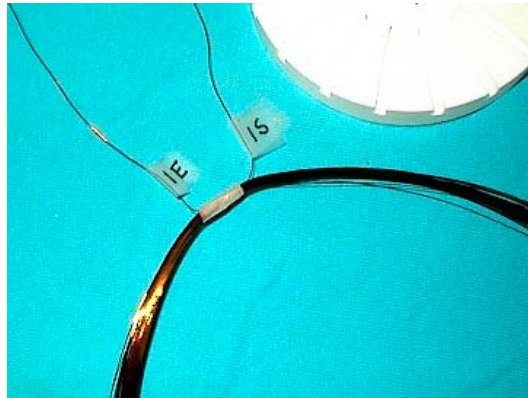

At this point you should get some tape ready to help hold the wires in the slots as we go along. Cut 6 pieces about 1 inch long and stick them to the table edge or somewhere easily accessible. Bend the wire to a 90 degree angle just left of the edge of where the two wires come out of the taped connection. You can place this in any slot to start with and place a piece of tape over the slot to hold the wire in place as shown below...

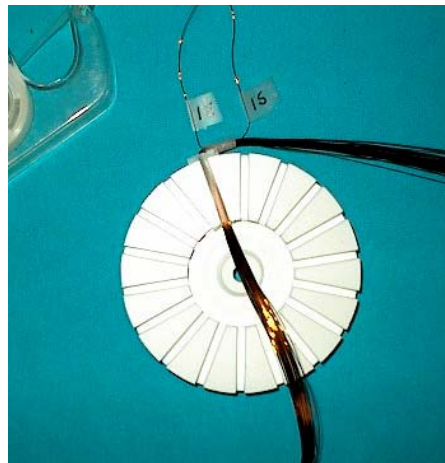

Bring the bottom of the wire, leaving a small loop while skipping two slots back up through the slot as shown below....

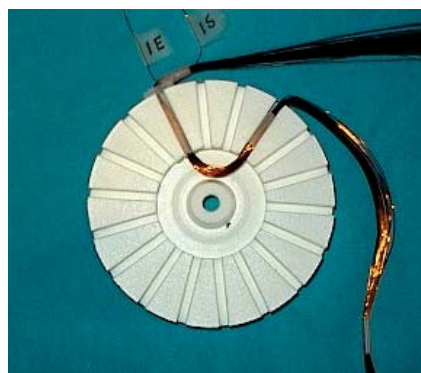

The top wire will come down through the same slot forming one of the six coils to be completed. A piece of tape covering the slot will hold the wires in place once again. The picture below shows the completed first coil...



The next coil will be similar to the first, skipping 2 slots, the bottom wire goes up through the slot and the top coming down through the same slot. A piece of tape to hold the wires in the slot. Below shows the next coil in place...

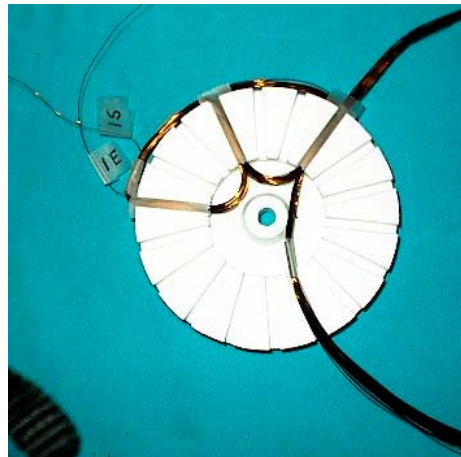

Continue on until all the coils are in place. The last coil will share the same slot as the starting coil. You'll have to pull the tape up, install the wire and replace the tape. When completed should look like the one below...

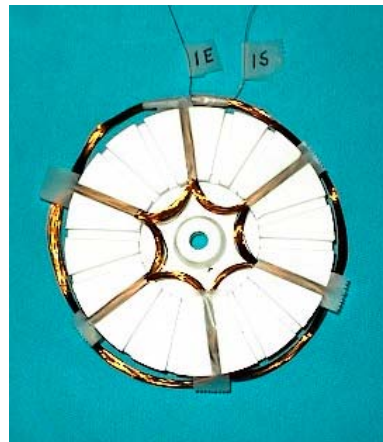

Now you have completed all the coils of one phase. You've just created a single phase alternator. The next two phases will go in the same as the first. The next phase will start in the slot directly to the right of the start of the first phase. Start by finding the long and short wire as with the first coil and label the start and end as you did with the first only this one will be labeled 2S and 2E for the second phase. Shown below is the beginning of the second phase...



Follow the same pattern as you did with the first phase and using tape to hold the wires in place. Below shows the second phase in place...



Proceed with the third phase the same as the first two filling the remaining slots. Shown below is the first coil start and the completed stator...



That completes the stator at this point. Assembling the stator to the turbine is a simple step. But, before we continue you should decide on the base. The base can be a board with feet which I will show in the following assembly or you can use a PVC pipe plug that will fit a pole to mount it on. Simply drill a hole in the plug and bolt the stator to the plug. Makes a nice pole mounted unit for experimenting. For simplicity I've chosen to make this one on a wooden base. A simple square of wood and 4 feet has been made for the instructional version. Below shows the base ...

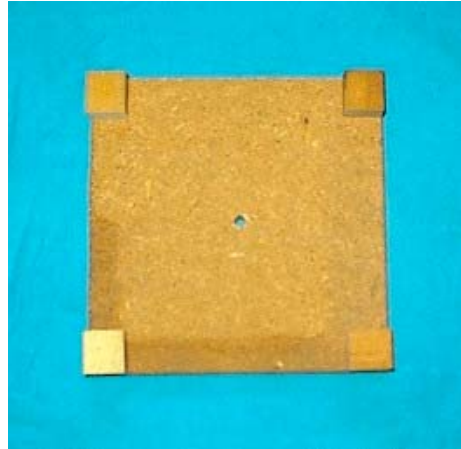

A $\frac{1}{4}$ inch hole has been drilled through the center for mounting the stator and 4 wood feet glued to the base. Mount the stator using the threaded rod and two nuts provided in the kit. Below shows the stator mounted to the base...

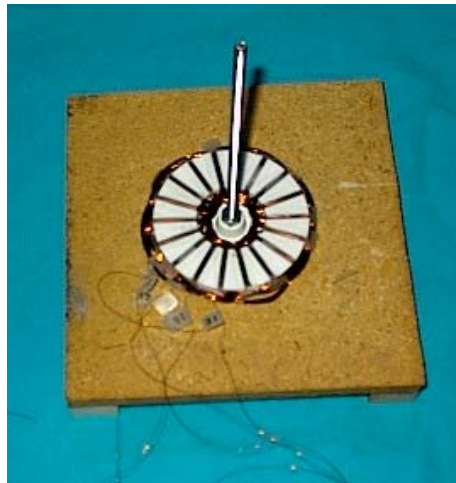

Slide the magnet end of the turbine unit over the rod, install a washer on top making sure it drops into the washer groove of the triangle and install the nyloc nut provided in the kit. When tightening this nut make sure its not tight against the washer but not loose enough to allow the washer to jump out of the slot. The turbine should rotate freely. Make sure the magnets are not hitting the stator or wires and rotates without much friction. If the lower hole is difficult to install on the rod you can run a ¼ inch drill through the hole to make sure its free of burs. Also a little grease or oil can be applied at the top and bottom pivot points to further reduce any friction created at these points. Below shows the completed turbine on base...

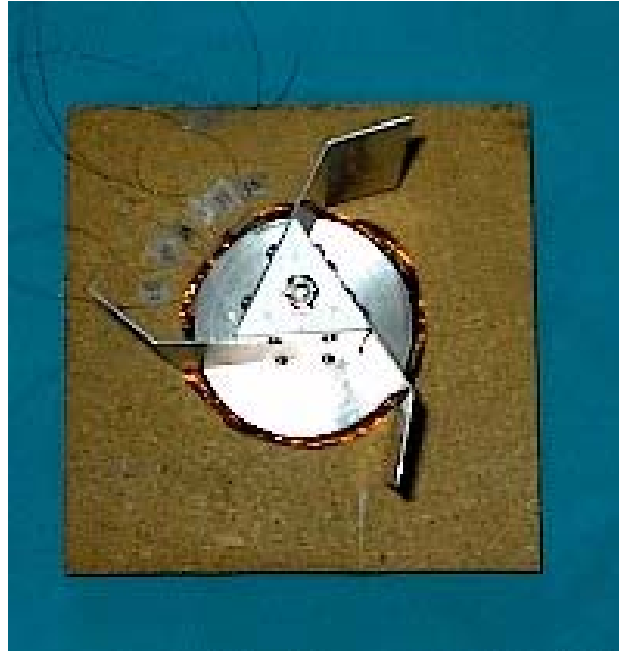

To make the stator a bit more permanent you can coat the wires with a clear enamel. This will help stiffen the looseness of the wires and hold them in place much better. Polyester resin works well also if you have some on hand .

From here we need to wire it up so it can actually do some useful work. There are basically two ways to wire a 3 phase alternator, star and delta. The “star” configuration gives you more volts but less amps and the “delta” gives you less volts but higher amps. I will show you how to wire it both ways but for the instructional model I will wire it in star.

The connections of the wires for star configuration are:

1S – 2E – 3S are output wires
1E – 2S – 3E are all connected together

The connections of the wires for delta configuration are:

1S to 3E

2E to 1E
3S to 2S
each of the three pairs are output leads.

Below is a diagram of star and delta configurations...

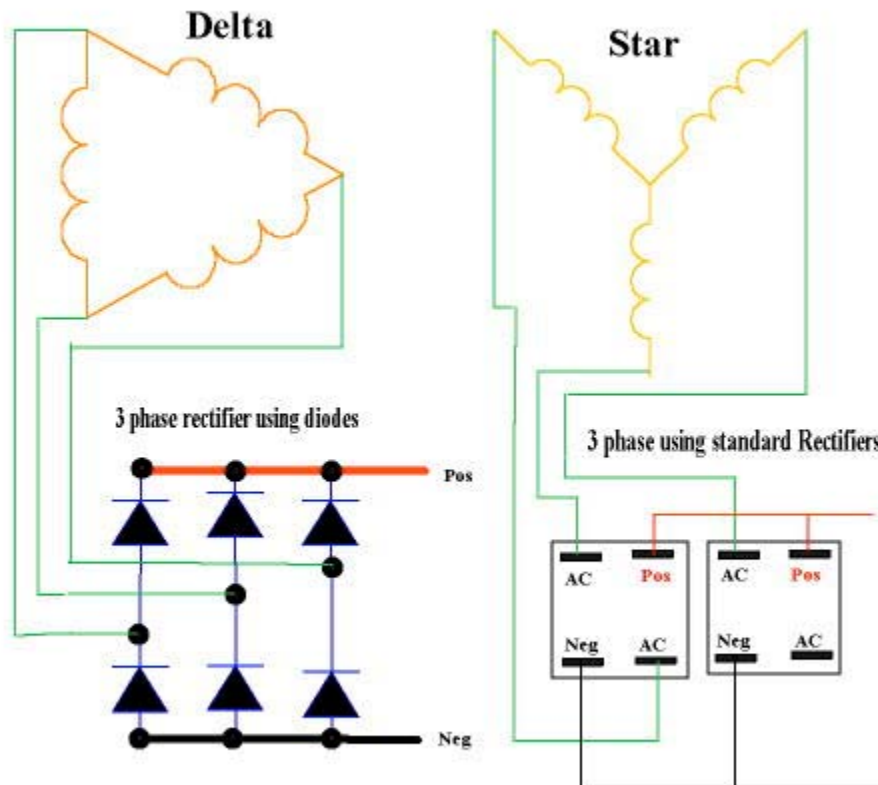

We will be using diodes to rectify the AC voltage coming from the alternator to DC voltage. Shown above in the delta configuration. You can use standard rectifiers shown above in the star configuration but with the power this unit makes the diodes are sufficient.

Since the output of the alternator is in the form of AC (alternating current) its not storable. To make it storable we convert it to DC (direct current). In order to do this we will use standard diodes to make a rectifier. Notice the band around the diode, it is on the end in which the direction the voltage/current will flow. You can connect the diodes together by soldering the ends or simply twisting them together. I have twisted the sets together for simplicity but soldering them makes a nicer looking end product. Below shows the pairs of diodes twisted together...

The picture isn't very clear but if you look closely each of the pairs are going in the same direction. That is to say the band shows the flow from left to right. The twisted portions shown here will be the AC inputs.

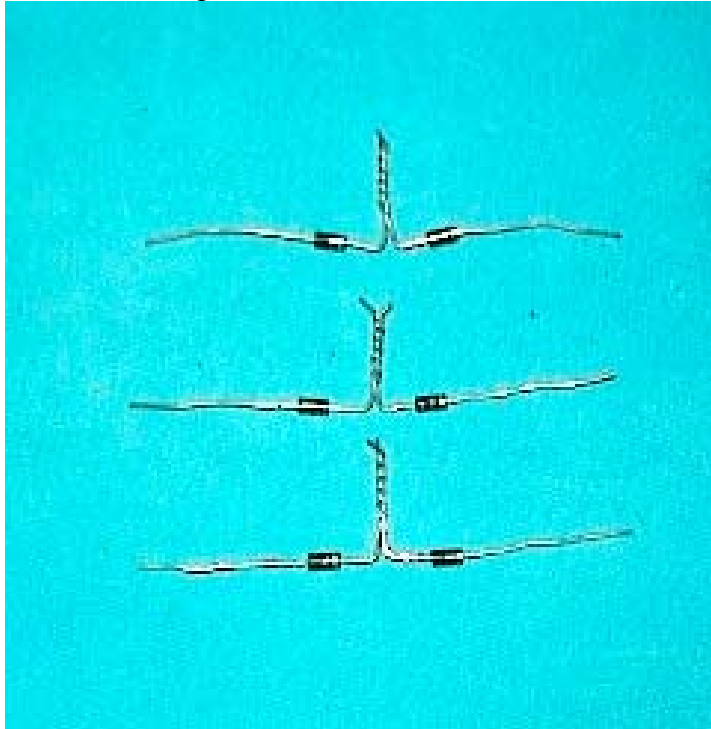

The next picture shows the ends of the 3 pairs twisted together forming the pos (+) and the neg (-) sides of the diodes. These are the ends that will connect to a battery for charging or become the outputs for powering an LED light or other. You can purchase a battery holder and NiCad batteries from Radio shack and wire it to the rectifier. Below shows the diode rectifier twisted together to form the rectifier (left) and input and output of the assembly (right)...

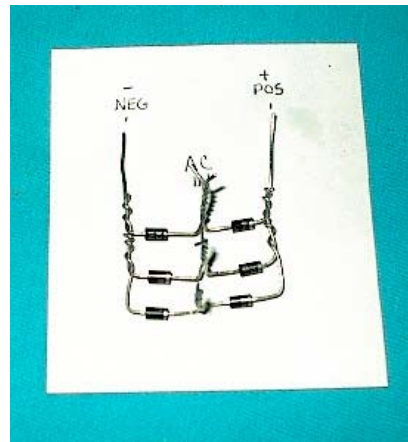
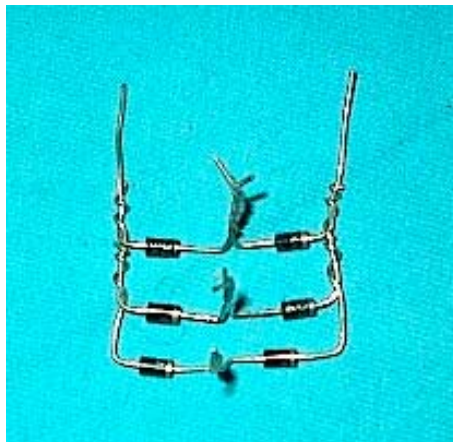

To complete your system you can install a Zenier diode of 3 volts and an led to make a simple shunt regulator. When the batteries reach 3 volts the light comes on telling you the batteries are charged and burns off the extra voltage. If the wind stops and the

batteries are not being charged anymore the light will burn off any excess in the batteries. When the voltage drops to just below 3 volts the light will go out leaving the batteries at a full charge. The simple shunt diagram is shown below...

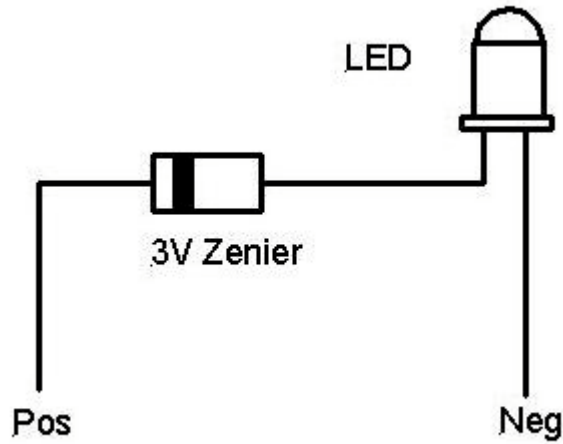

Below is the alternator wiring diagrams for both “star” and “delta” configurations ...

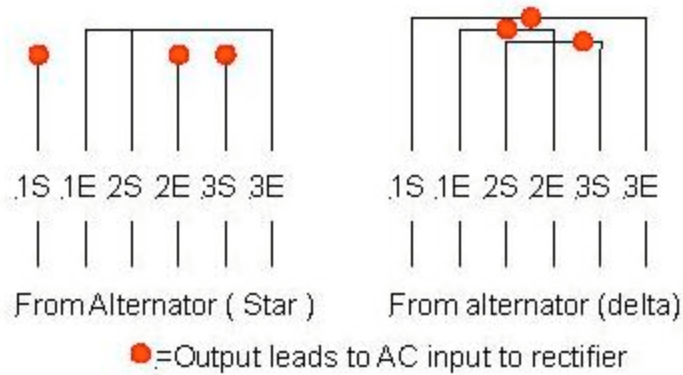

Now you have a completed RE (Renewable energy) system. Experiment and have some fun !!!

Formulas

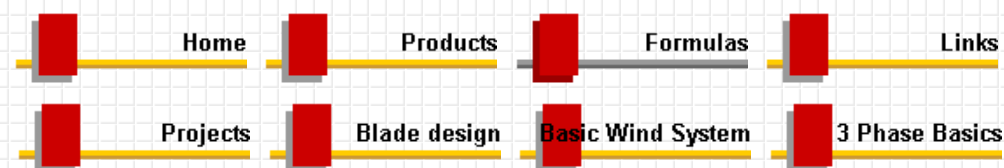

[Generator](#)
[Wind](#)
[Misc](#)
[Blade design help](#)

Bubble bubble toil and trouble.....Oh! ... Hi there....

This is where I hide all my formula's for figuring out this stuff.

Click on the link to the left for the area you would like to know more about.

Actually I was spending so much time with the calculator I decided to write a program that would figure this out much quicker. Below is a screen shot of the program. It will basically design and match the blades to any generator/alternator you have. After you input all the particulars (Inputs are in bold print) It will design the blade shape and twist, width and angles to cut the board, Give you an estimated performance output and match the alternator to that performance. If your interested in the program send an [email](#) **Note: you must include a message in the subject line relating to this site or the email will simply be deleted and therefore not answered.** I'm charging \$5.00 for it to help cover costs of keeping this web site alive. This program runs under Windows 95/98/Me that I know of. If you have Microsoft Visual Basic5(sp3) or higher installed you will only need the .exe file otherwise you will need the full Set up program. The file is approximately 1.5 Mb.

When using this program all the fields must have a number greater than 0. If you leave a space blank it will crash (divide by 0 error). I haven't put any error catchers in as yet but will on later versions. If you like the program and have ideas of other things that could be incorporated into it please let me know.

Simply click on the "Buy Now" button to purchase this through pay pal service. When I recieve the payment I will send you an email with the download site and password to unzip the files. Run the Set up program from there and your all set to go.

There is a new help file for the program which you can look over [here](#) or you can click on blade design help in the upper left corner. Have Fun!

Blade designer

Rotor diameter (meters)

Tip Speed Ratio

Number of Blades

Angle of attack (deq)

Lift coefficient

Number of stations

Calculate

Clear chart

Print Form

Station	Radius (in)	Bld ang (deq)	Chord (in)	Thickne (in)	Drop (in)
1	12	19	9.32	1.4	3.58
2	24	8	5.24	.79	1.07
3	36	4	3.58	.54	.49
4	48	2	2.71	.41	.28
5	60	1	2.17	.33	.18
6					
7					

Estimated Prop performance

	Watts	RPM
10 mph 4.4ms	60	224
12 mph 5.3ms	103	269
14 mph 6.2ms	164	314
16 mph 7.1ms	244	359
18 mph 8.0ms	348	404
20 mph 8.9ms	477	448
22 mph 10ms	635	493
24 mph 10.7ms	824	538
26 mph 11.6ms	1048	583
28 mph 12.5ms	1309	628

Calculated Generator performance

Amps	Open V	Rpm	Ratio	Watts at Rec Ratio
4.05405	17.2324	666.202	2.97411	82.7530
6.95945	18.9756	733.595	2.72712	172.716
11.0810	21.4486	829.200	2.64076	262.680
16.4864	24.6918	954.583	2.65900	352.644
23.5135	28.9081	1117.58	2.76629	442.608
32.2297	34.1378	1319.76	2.94589	530.572
42.9054	40.5432	1567.39	3.17929	620.536
55.6756	48.2054	1863.61	3.46396	710.500
70.8108	57.2864	2214.68	3.79877	800.464
88.4459	67.8675	2623.74	4.17793	890.428

INPUT: wind velocity in m/s to calculate rotor thrust

Rotor thrust in pounds

Recommended Ratio

Open Voltage

8	<input type="text"/>	<input type="text"/>	<input type="text"/>	<input type="text"/>	<input type="text"/>				
9	<input type="text"/>	<input type="text"/>	<input type="text"/>	<input type="text"/>	<input type="text"/>	Rotor offset in inches	<input type="text" value="4.8"/>	Measured Rpm	<input type="text" value="1500"/>
10	<input type="text"/>	<input type="text"/>	<input type="text"/>	<input type="text"/>	<input type="text"/>	Tail Size in square feet	<input type="text" value="2.5"/>	Measured Ohms	<input type="text" value=".6"/>
								Regulated Voltage	<input type="text" value="14.8"/>

Links

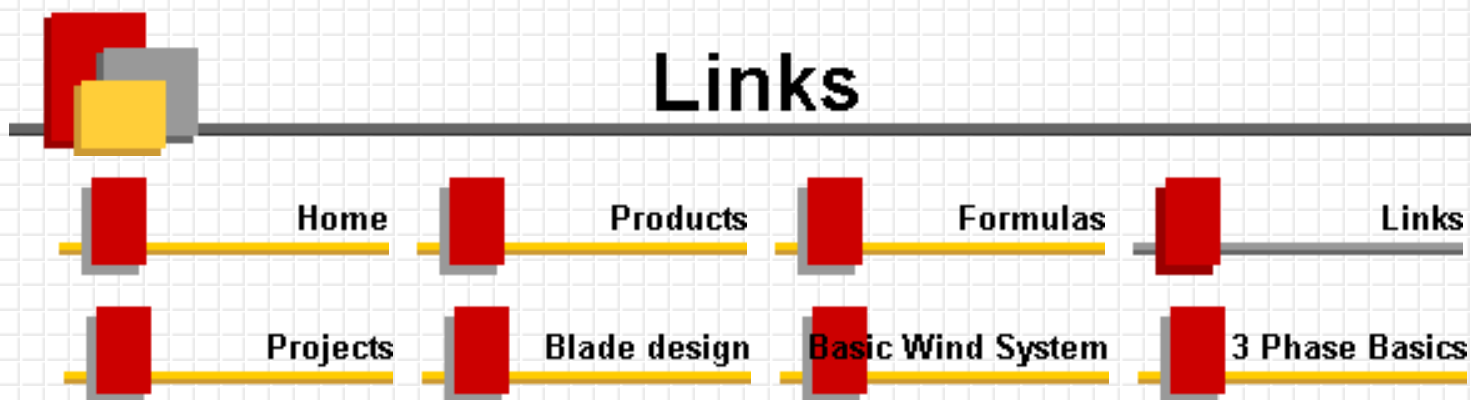

Here are a couple of great links to start with... There will be more added as time goes on.

www.otherpower.com They sell magnets and lots of other goodies we like to play with. Also their site offers a world of information. They also have another site where they sell their magnets and other trinkets to play with at www.wondermagnet.com

www.homepower.com Magazine dedicated to us DIYS'ers of home brewed power

www.ScoraigWind.co.uk I learned allot from Hugh Piggott, and would strongly recommend his books to anyone getting involved with wind power.

<http://webconx.green-trust.org> has a wealth of information on just about any kind of Renewable energy you can think of. Expect to spend some time on this site...

www.utterpower.com . slow speed engines, generators, and more"... Lots of cool stuff we like to play with...

www.acs.comcen.com.au lots of DIY projects, information and links.
www.acs.comcen.com.au lots of DIY projects, information and links.

<http://www.ndsu.nodak.edu/ndsu/klemen> This site has information about small manufactured wind turbines as well as other information about wind power
<http://www.ndsu.nodak.edu/ndsu/klemen> This site has information about small manufactured wind turbines as well as other information about wind power

<http://www.bioelectrifier.com> has a real slick "mini" wind generator along with solar and wind charge controllers as well as other unique gagets. Mike is a tinker'er just like us!

<http://www.dsgnspec.com> -Rob has some great stuff for us experimentors... lots of electronic gizmos we all gott'a have. This is where the star/delta switch I used in my downwind turbine project came from and it works flawlessly! **Also !!! If your looking for a small hand held tach, the non-contact type you gotta' check out the "Tach JR" Perfect little tach at the right price!!! Dont miss out!!!**

<http://www.learnonline.com>-Great place to learn about renewable energy for young and old. A new and interesting way of learning.<http://www.learnonline.com>-Great place to learn about renewable energy for young and old. A new and interesting way of learning.

<http://disposalmovie.tripod.com> -Off topic but a great movie to experience. Plus you can help support a young upcoming movie maker. A must see!

<http://discountmagnets.tripod.com> -Another good source for magnets!

If you have a site based on the "do it yourself" or "how to" category and would like to be added to this list please send me an [email](#) I would be happy to exchange links!

NOTE: There must be something in the subject line relating to this site or the email will be deleted and therefore not answered.

Projects

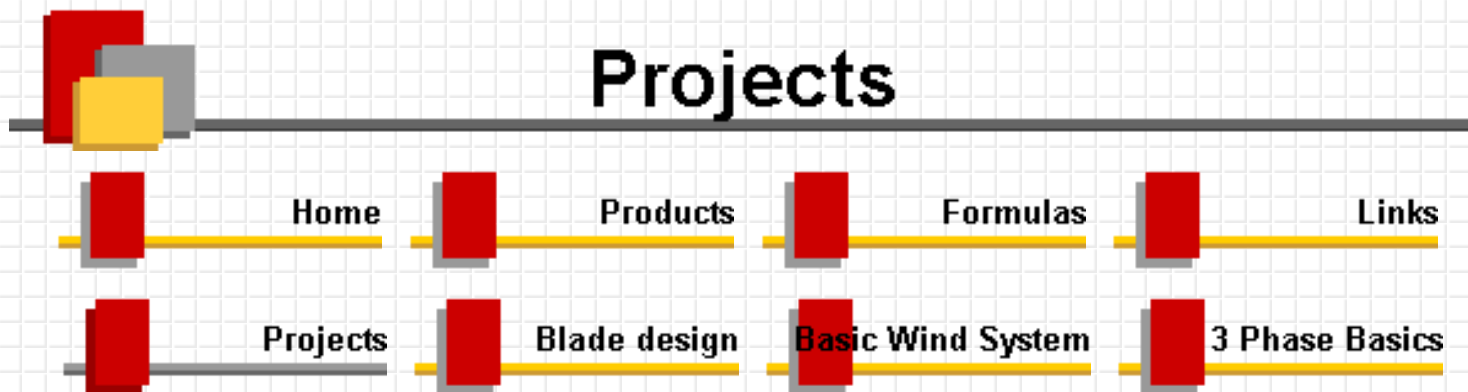

[Stirling engine](#)

[Gm Alt mod](#)

[Wind turbine](#)

[Alt from Scratch](#)

[Down wind turbine](#)

[Darrieus Type](#)

[Stirling Generator](#)

[Microwave wind generator](#)

[Poured Stator](#)

[One hour projects](#)

[VAWT](#)

Projects from the past and present....

Click on the links to the left to check out some of the projects I'm either working on or are past projects.



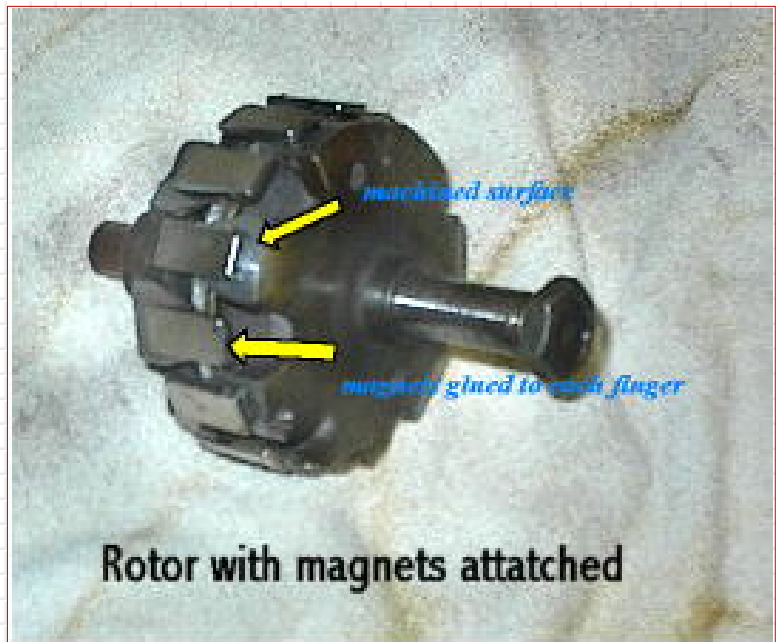





Blade design

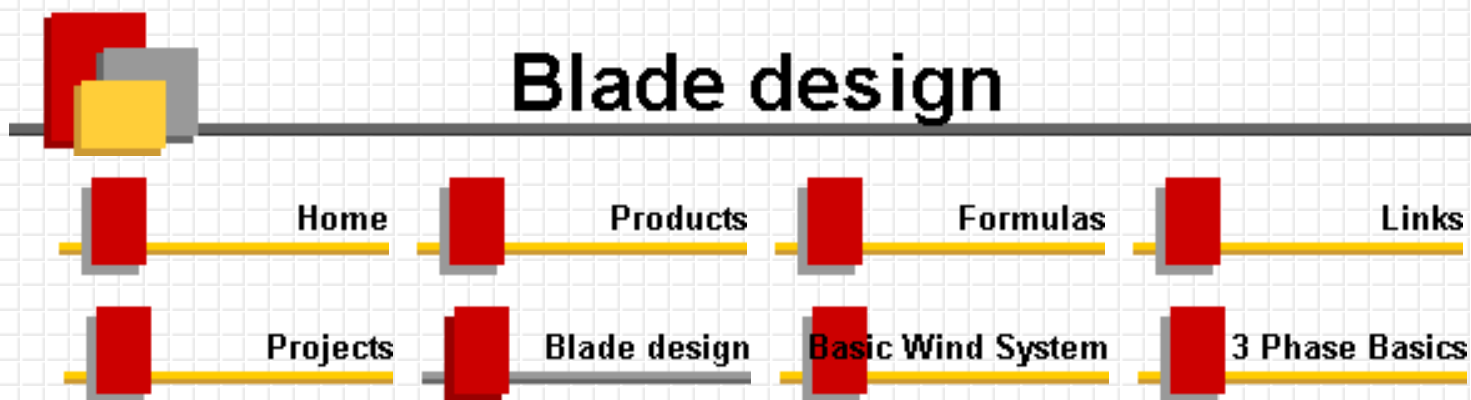

Here are some notes to aid in designing your blades....If you purchased the [Blade designer](#) program all the numbers will fall in place.

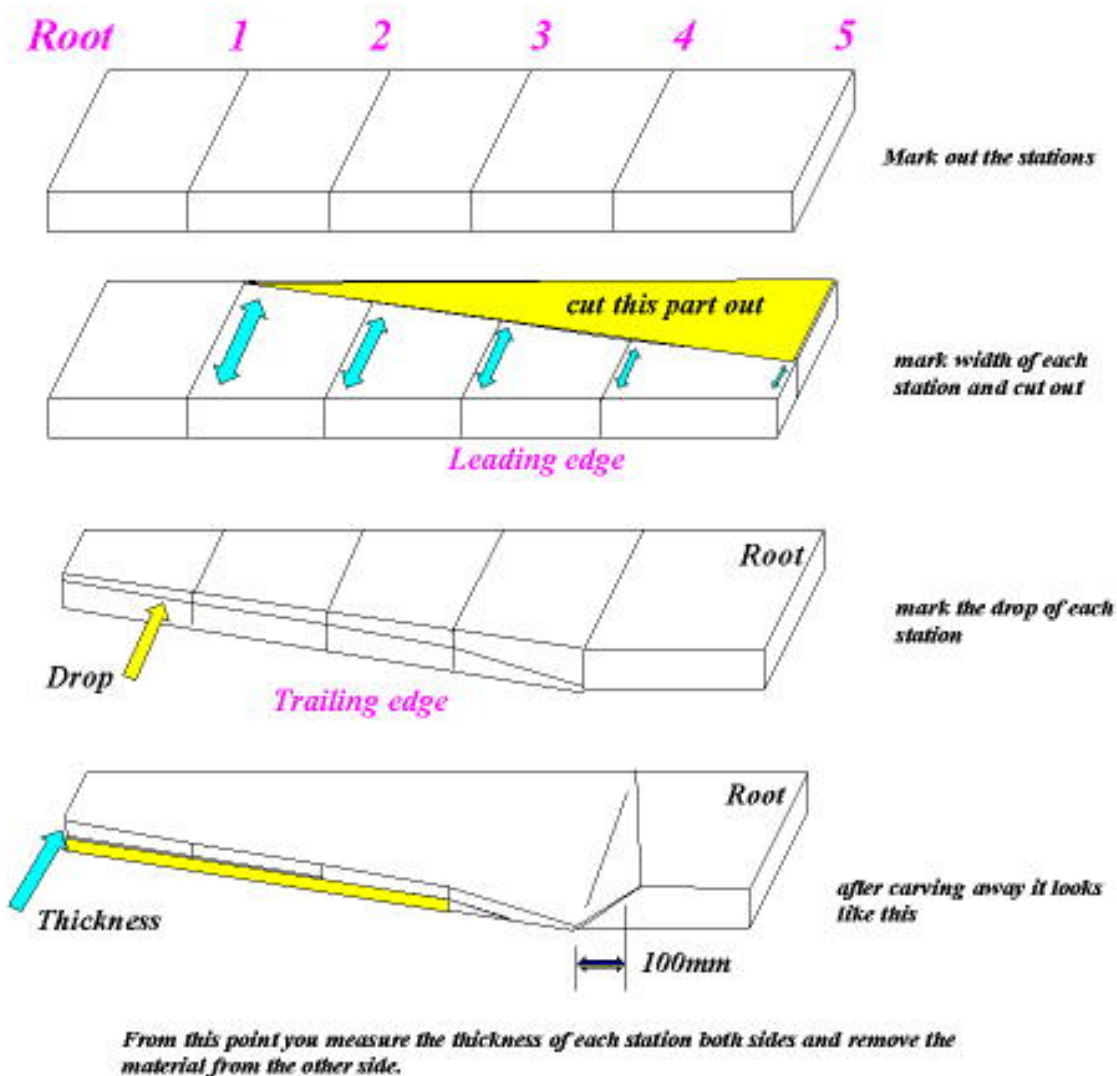

Step 1: Mark out the stations

Step 2: mark width of each station cut out all unnecessary wood

Step 3: mark the drop of each station and draw a line

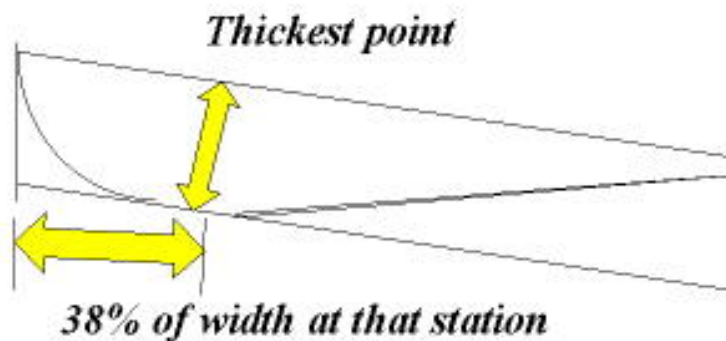
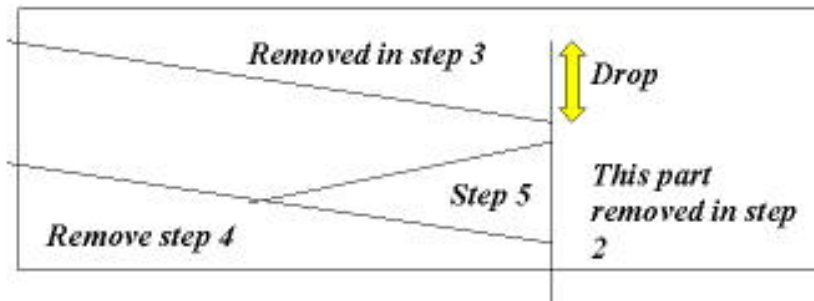

Step 4 mark the thickness at each station (both sides) then remove the excess material

Step 5. Mark each station at 38% of station width, draw a connecting line and carve the material to shape the wing. Make sure you don't cut the line. This will be the thickest part of the blade.

If you don't want to go through all of that you can build a blade from station 4. Using the angle and width and make one straight blade from this. Once the blade is made you can glue angle blocks on the new blade at the angle it will be installed.

Basic Wind System

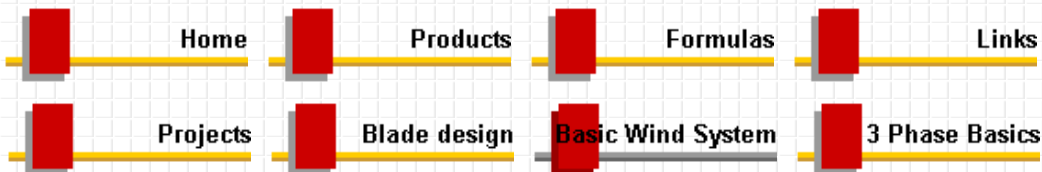

The diagram below shows the components for a basic wind system using a 3 phase alternator. The AC from the alternator is brought into the power room then converted to DC through a rectifier. The shunt regulator maintains the batteries. The DC is then converted to AC through an inverter.

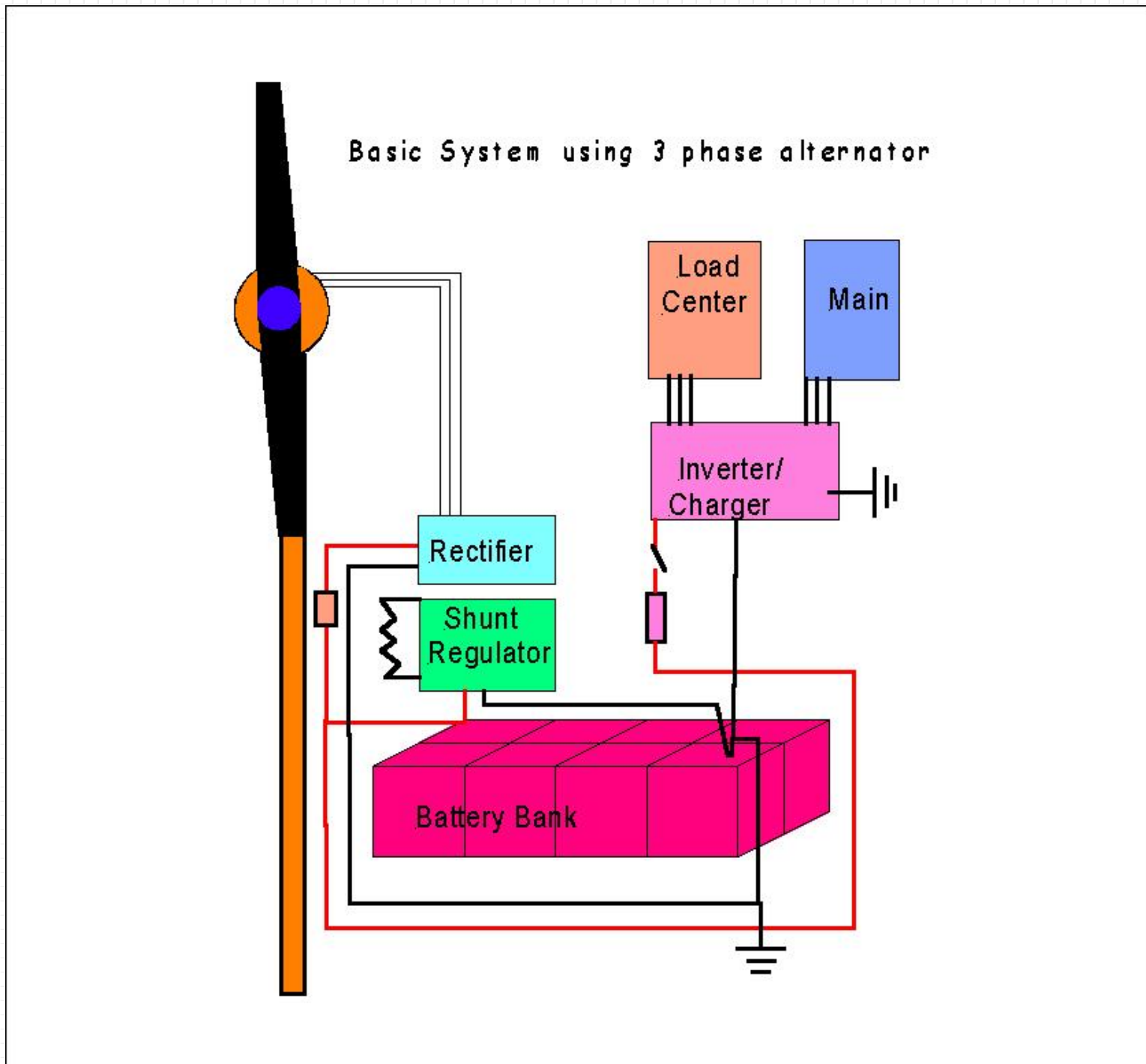

My control box (shown below) is a very inexpensive "homebrew" controller. It houses everything for an "all in one" type controller. I suppose you could say its a "Frankenstein" controller.... The box was made from an old Compaq Computer Power supply, the rectifier

Basic Wind System

from a 60 amp GM alternator, regulator circuit from www.homepower.com, and the heaters are made from aircraft safety wire (measured to 1 ohm each). You can note the circuits are put together on experiment boards because my soldering skills are much lacking when it comes to IC's. If it could be done with a Lincoln 220 or a Mig welder I'd have no problem....

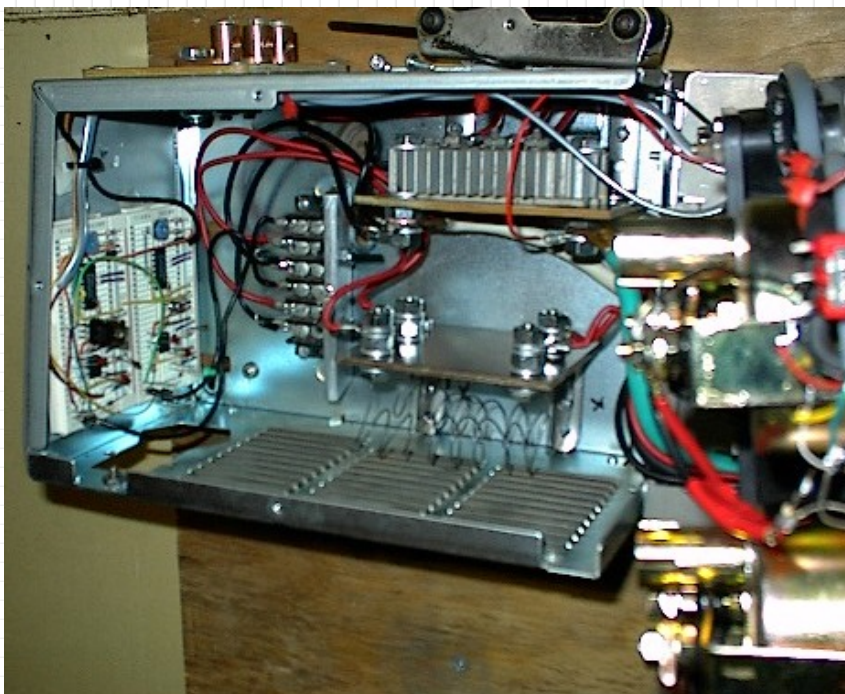

The face of the unit shows the fan, volt meter and amp meter. The fan is set to come on whenever the shunt units are operating and blows the air out the bottom of the unit to heat the room. Below shows the face of the control box. Very low tech.... Total cost = \$24.00



You can see the 3 AC lugs on the top of the unit and the DC lugs on the side. It has an on-off switch on the left with a green LED to tell you its on and 2 red LED's tells which shunt is operating. There are 2 shunts regulators in the unit to dissipate a total of 500 watts if needed.

Below shows my power room set up. I have 8 T-105 Trojans batteries, a Trace DR2412 to power my entire office and Day house. On line with the Trace is a complete computer system, Frig, TV, 2- 8foot fluorescense, 1- 4ft fluorescent, 1 CF for the bathroom, 1 40 watt shower light, 600 watt microwave, coffee maker and misc phone plugs. The power room used to be a Milking parlor and the main office was the processing and storage of milk. (Old dairy farm).

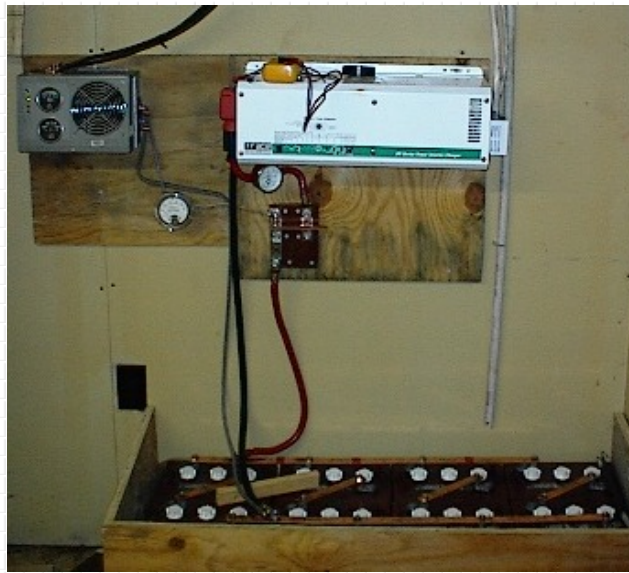

I found an old amp meter from a phone company power box so I added that into the line. The meter under the inverter is a 0 to 600 amp induction type meter that's clamped onto the Pos line to the inverter. The battery box is basic 3/4" plywood with a top that seals quite well. The tube to the right of the inverter is the vent going out through the ceiling (safety gassing). Under the Inverter is a 300 amp fuse and disconnect. The entire wind system cost just over \$500.00 including batteries, wire, pole to mount the turbine on, the wind turbine and all other misc connections. The inverter on the other hand cost me \$950.00 which left me with just under \$1500.00 in the whole system. I plan to add another wind turbine to the system as a redundant precaution... they both couldn't possibly go down at the same time..... could they?

3 Phase Basics

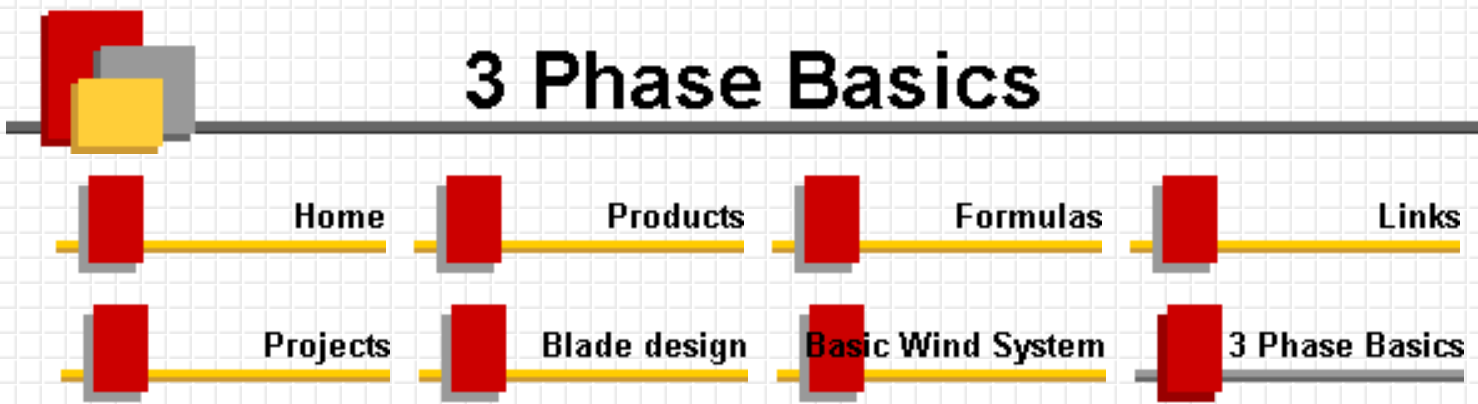

Understanding 3 phase alternators....

Three phase is nothing more than single phase with 2 extra coils slightly out of phase with first. Basically "Phase" relates to the timing of the magnets passing over the coils at different times. With single phase the magnets and coils all line up with each other and are said to be in "phase". The diagram below shows single phase wiring....

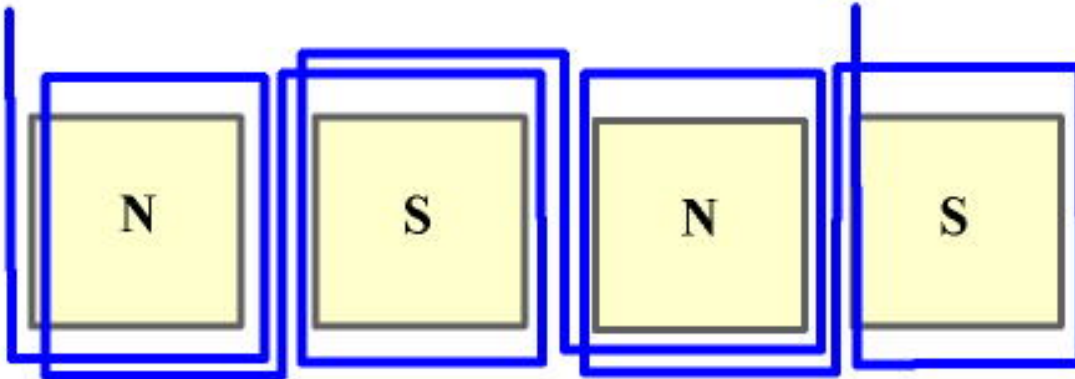

In a single phase unit the coils are wound opposite of the first. That is to say one is wound clockwise and the next is counter clockwise. If your unit has 8 magnets then it would also have 8 coils. With 3 phase you would have 3 coils for each pair of magnets. A pair meaning one north and one south magnet. There are many combinations for any one set up. For instance you could use 8 magnets and only have 6 coils without overlapping them... or 3 set of 4 coils in series. For now we won't worry about the combinations and stick with the basics. Below shows a diagram of 4 magnets with the placement of each of the coil sets...

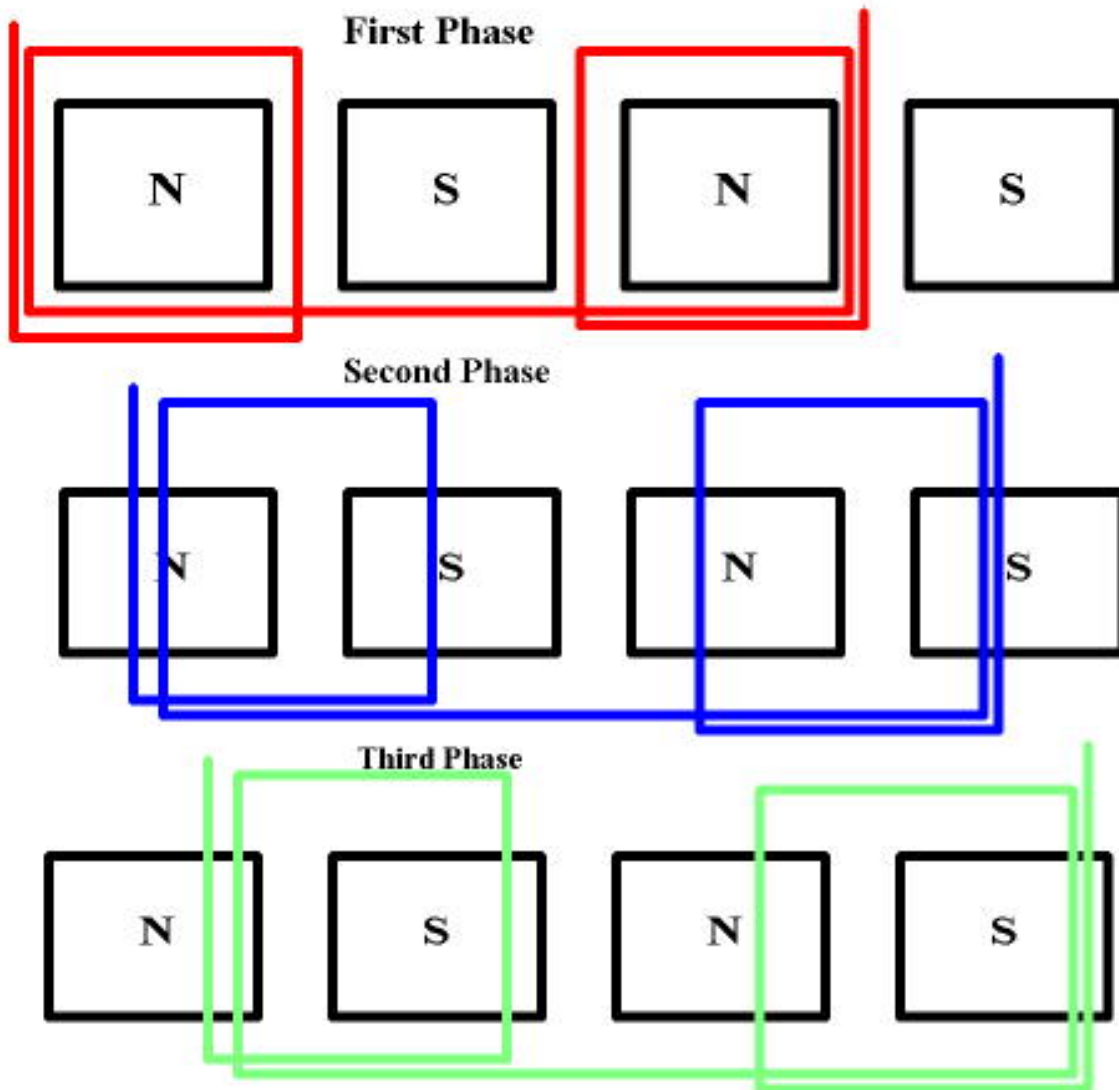

As you can see the first phase covers only the north pole magnets and are wound all in the same direction. The other of the two are identical to the first with the exception they are offset equally. The next diagram shows all the sets in place for a 4 pole alternator. You end up with 3 start wires labeled A,B,C and 3 end wires labeled D,E,F. The output wires to this arrangement would be A, C and E. The reason E is an output or ends up being a "start" wire is because when the magnet passes over the 2nd phase its out of phase between the 1 and 3 so the ends are reversed instead of winding them in the opposite order.

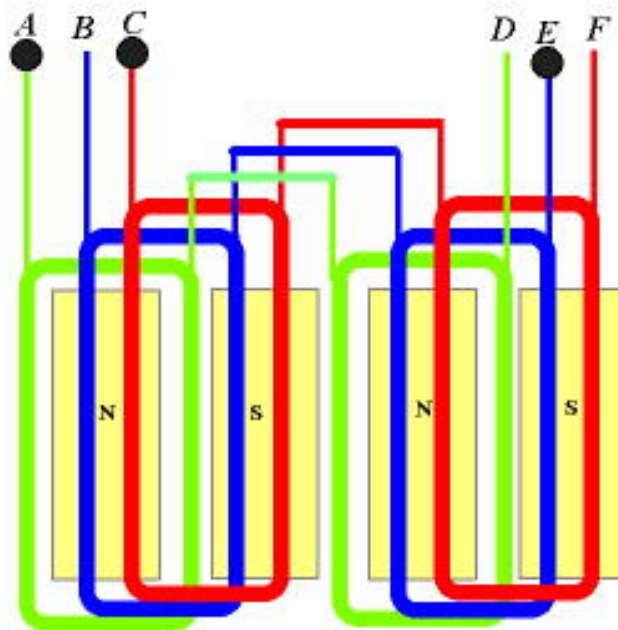

Now to connect the ends and change the AC to DC for battery charging... Below shows the star and delta symbols and 2 different types of rectifiers. Either rectifier can be used for star or delta. You can use diodes and make your own rectifier set up or you can purchase the standard rectifiers. Notice on the standard rectifiers one AC lead isn't used. Similar to the diodes, a rectifier that is already made up for such use and my personal preference is a unit from a GM alternator. They seem to give the best rectified output out of all of them. I'm not sure why but they do. They are expensive to buy new but usually you can get them from the junk yard fairly cheap. Sometimes get the whole alternator for around 15 bucks. They also make a nice clean set-up.

There are basically two ways to wire a 3 phase alternator, star (or Wye) and Delta. With Delta you get lower voltage but more amps. In star you get higher voltage but less amps. You can calculate these by using the square root of 3 (or 1.732). Each coil set is a "phase" of the alternator so when you measure voltage, ohms or current to test one phase of the alternator you would measure the "phase". Once you know what the output will be from one phase you can calculate the "line" output of either delta or star. The line voltage would be measured from any 2 of the 3 outputs. If one phase measured 22 volts in your test and 10 amps then the star configuration would produce 38 volts and 10 amps (22×1.732). The amps remain the same as the phase measurement because the star is basically series'd to another phase. In Delta you would get 22 volts at 17.32 amps ($10 \text{ amps} \times 1.73$). If you calculate this out $22 \text{ volts} \times 17.32 = 381 \text{ watts}$ and $38 \times 10 = 380 \text{ watts}$... so what is the advantage? Typically the resistance in Delta is 1/3 the resistance of star. If the resistance of star was 1.5 ohms we could calculate the output (see formula section). Lets assume the

test was at 600 rpm, we achieved 38 volts in star (about 16 rpm per volt) so at 1000 rpm we would get 62.5 volts less battery voltage of 12.6 = 49.9 volts / 1.5 ohms = 33.26 amps * 12.6 = 419 watts... not to bad. Now in delta we had 22 volts at the same rpm (about 27 rpm per volt). So at the same 1000 rpm we get 37 volts - 12.6 battery = 24.4 volts / .5 ohms = 48.8 amps * 12.6 = 614 watts. Almost a 200 watt gain !!! The advantage of star is the higher voltage at lower rpm which means our unit would have to make 201 rpm to start charging at 12.6V where the Delta would require 340 rpm to start charging.

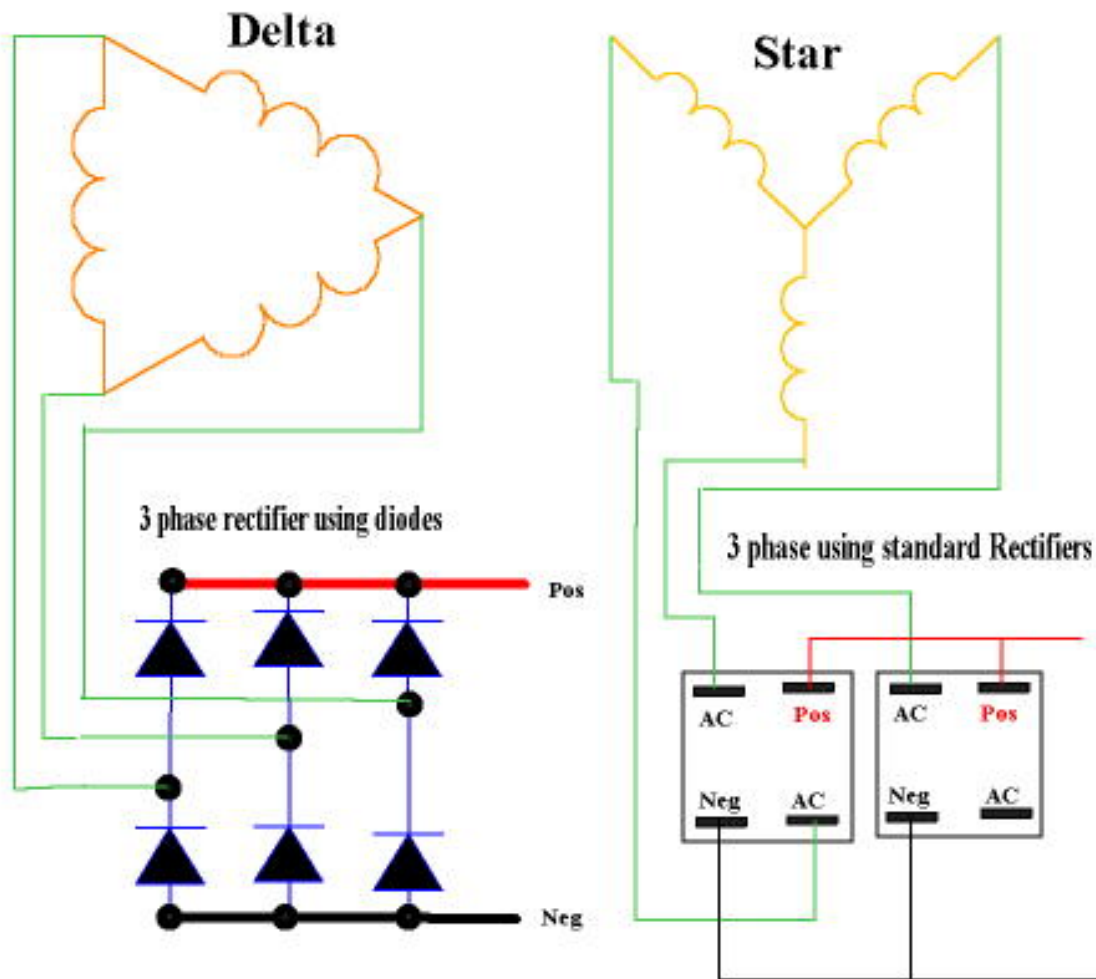

Some Basic factoids about 3 phase.... Most of the electric power in the world is 3 phase. The concept was originally conceived by Nikola Tesla and was proven that 3 phase was far superior to single phase power. 3 phase power is typically 150% more efficient than single phase in the same power range. In a single phase unit the power falls to zero three times during each cycle, in 3 phase it never drops to zero. The power delivered to the load is the same at any instant. Also, in 3 phase the conductors need only be 75% the size of conductors for single phase for the same power output.

And there you have it ! Not really much more difficult than single phase but much

more efficient !!!

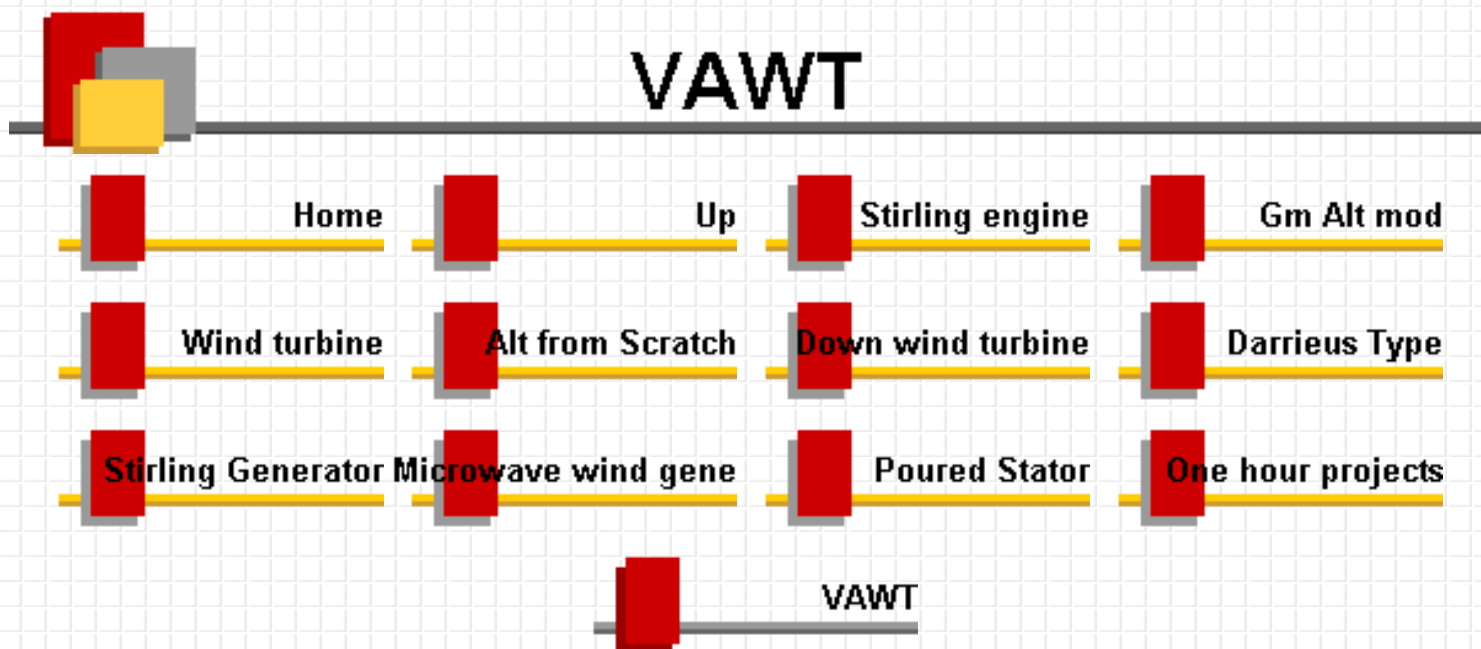

Yet another VAWT..... *The "Lenz Turbine"*

I've always had sort of a soft spot for the Vertical Axis Wind Turbines because of the advantages they offer. Unfortunately, most of them such as the Savonius aren't very efficient but do offer low wind characteristics. About a year ago I was emailed a patent of a VAWT that was a bit different. This one used the "Venturi effect" to duct air around the wings. After reading through the patent I decided to build one and see if it was any better or worse than some of the others out there. As it worked out it did outperform the Savonius but still seemed a bit low on the overall efficiency. I started searching for any others that used this principal and found one other like it. I ended up building this one also and found similar characteristics but this one also seemed a bit low on the efficiency return, still it did outperform the Savinous again.

I started playing around with small units and built a coffee can model which ended up running at 700 rpm and was named the "700 RPM Coffee can". It really didn't make much power being as small as it was and was basically cut and duct taped together. Below shows a picture of the original coffee can experiment... If you decide to try this be advised the metal is very sharp and you should wear gloves as well as observing all safety precautions...



Basically I divided it up into 4 sections, cut two out and taped them back into the can on the two remaining sections. It ran at 700 rpm in a 12.5 mph wind.

I decided to build a larger one using a plastic 5 gal bucket and similar techniques were used in the construction. This was a real dud! It didn't work at all. After some thought as to why it wouldn't work I decided to try a round drum in the center. I stacked a couple large coffee cans inside and taped them in. By changing the airflow through the unit it worked although not very well.

After trying a bunch of different drums and shapes I decided to get a bit more scientific in my testing instead of my hit 'n miss style up to this point. I was intrigued as to exactly what was going on. I started doing some static tests of the air flow through the machine while in different positions but not spinning. Using a hand held wind speed meter I checked the wind speed in front and behind the unit as well as inside. The air flowing through the can was actually faster than the air entering the can. I found some Venturi formula's and started testing shapes and wings. I figured I had enough information to design something a bit larger, and get some better test results. Using a combination of Savonius design ideas along with the venturi theory I came up with a design that is a bit different than the normal. Although similar to the Darrieus, wings similar to the Savonius, and a triangular drum in the middle to guide the flow of air the design was set. I built a few smaller versions for testing and the results looked promising and showed that I seemed on the right track. A larger one needed to be built. Below is the last one built to this point... Simple construction using plywood and aluminum flashing the machine is a bit under built but all the components are in place for the testing...



The alternator is a homebuilt single phase axial design and the first test run showed 17 watts in a 12.5 mph wind. The alternator serves as a pony brake, the stator has bearings and is allowed to rotate, has an arm attached with a spring scale for taking torque readings. From there the output is calculated. The unit stands 2ft tall and 2ft in diameter. I would say it would come close to competing with the Horizontals. It will start turning in a 3mph wind although the alternator doesn't start charging until about 5-6 mph. The turbine ran 240 rpm while driving the 17 watt load which comes out to a TSR of about 1.3. Static testing with my wind meter and unit not turning, 12.5 mph in front of the machine about 3mph 1 ft behind the machine but 17 mph going through the wing. I think there is still a considerable amount of work in improvements to be done and testing will continue. I'm calling it the "Lenz Turbine" and giving credit to all those before me for their unique and innovative work in this field. Also, to Hugh Piggott for helping me with the formula's for working out the wing angles based on the Darrieus type.

Below is a diagram representing the dimensions for the machine above based on percentages of the overall size for those who would like to build one for their own personal use and/or for testing purposes.

Wing Width = diameter \times .14
Wing Chord = circumference \times .09
Center drum radius = diameter \times .28

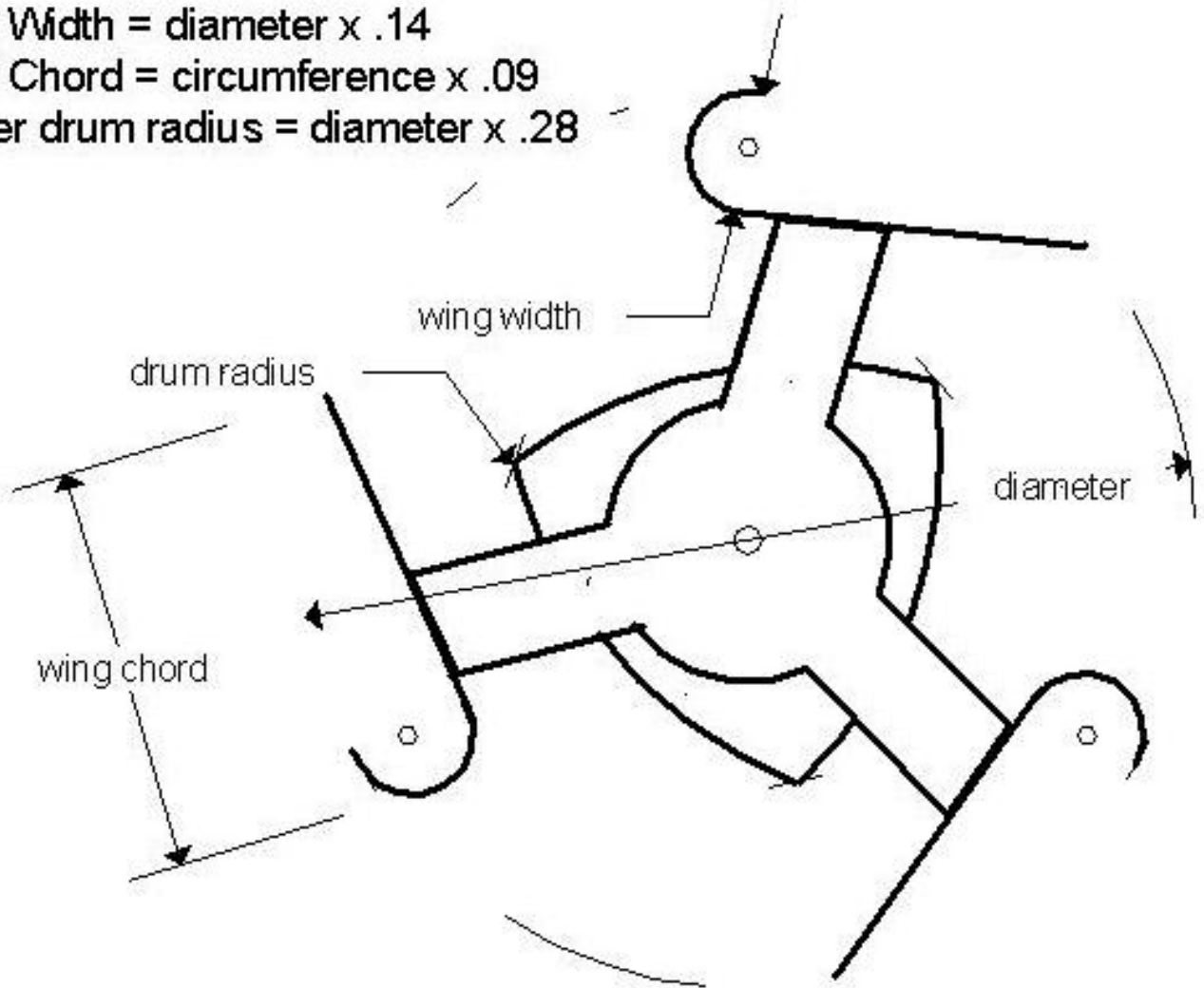

Below is 2 more versions using similar but different wing configurations both utilizing the lift on the upwind side as well as better drag characteristics on the downwind side...

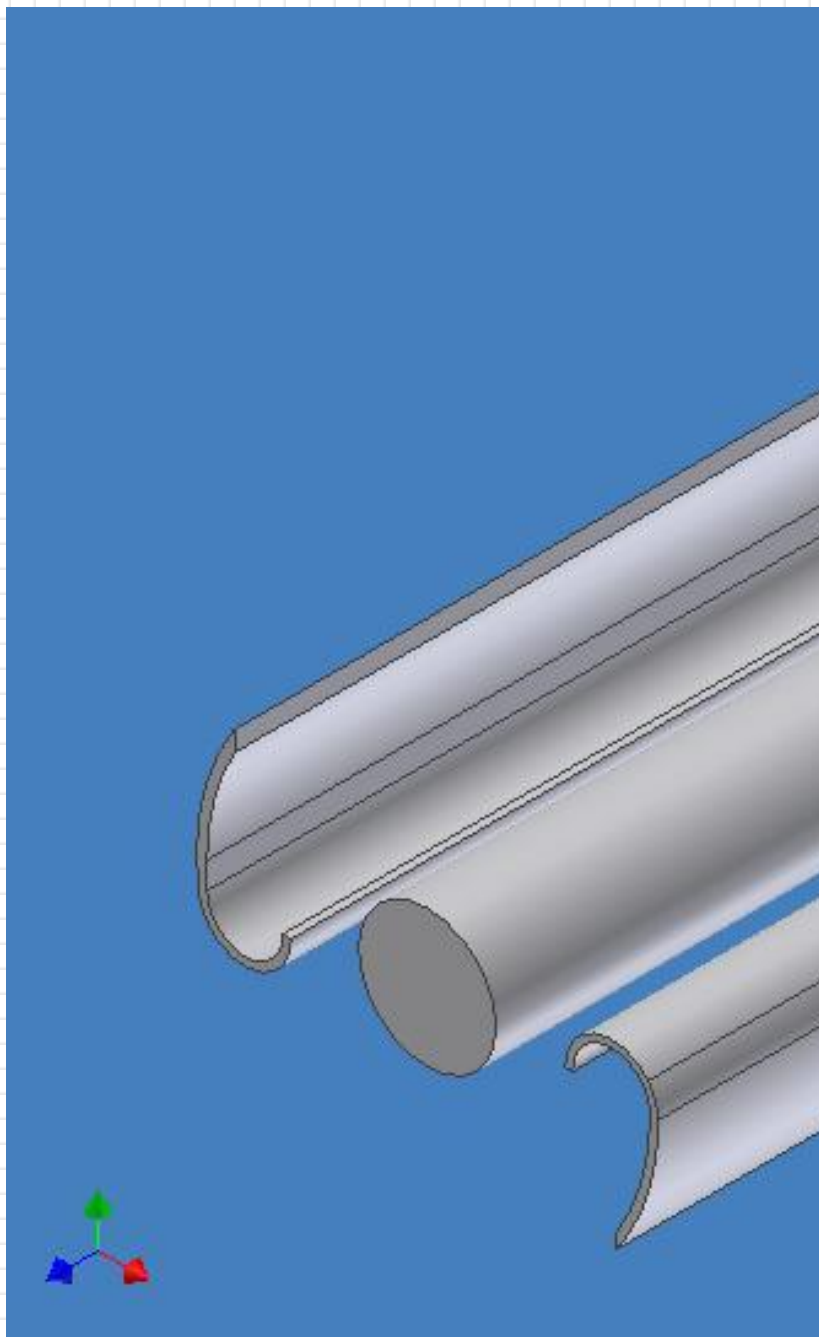

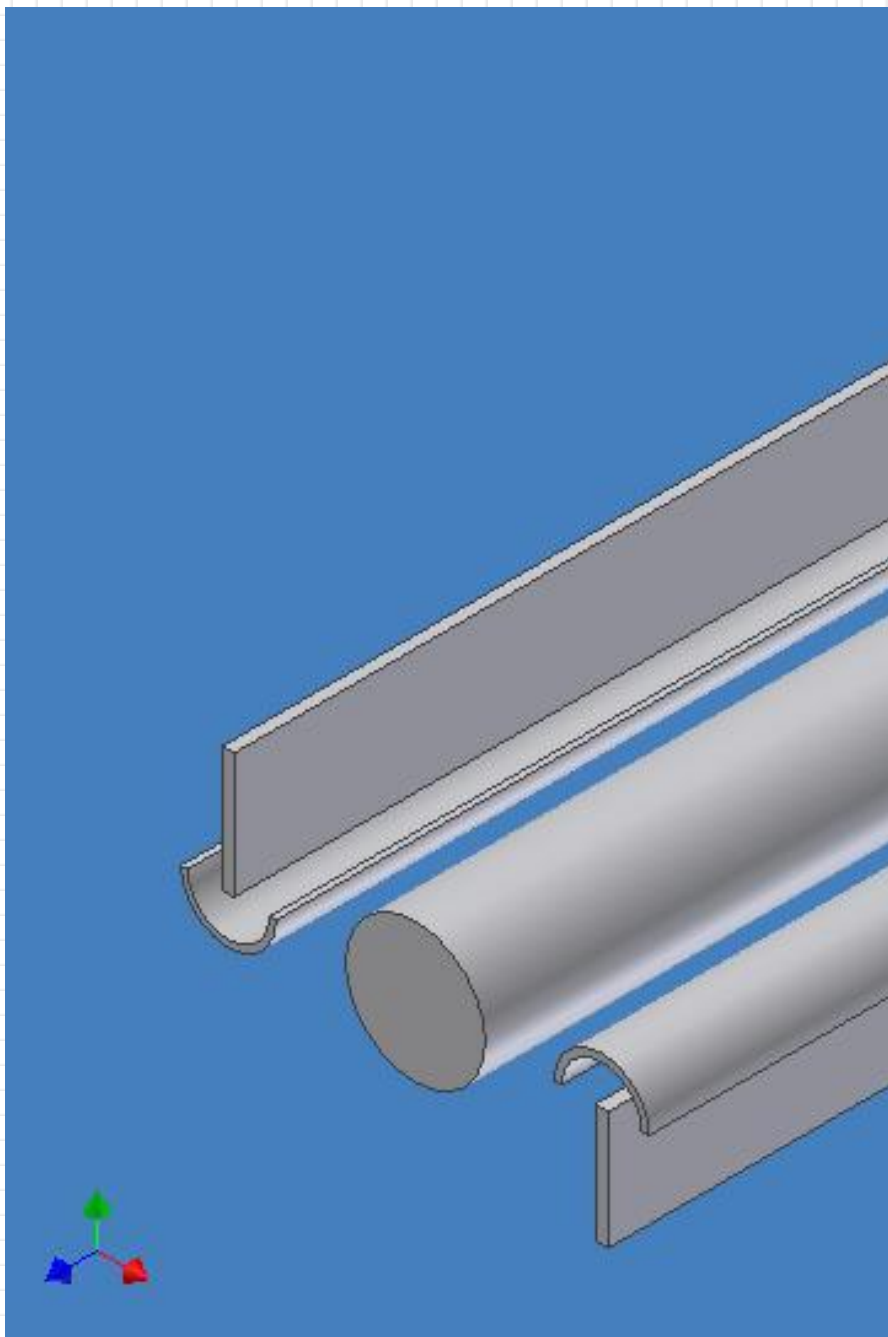

The first one is basically the reverse of the original version and the second utilizes both sides of the downwind side wing to increase torque. Both versions will create lift on the upwind side.

Alt from Scratch

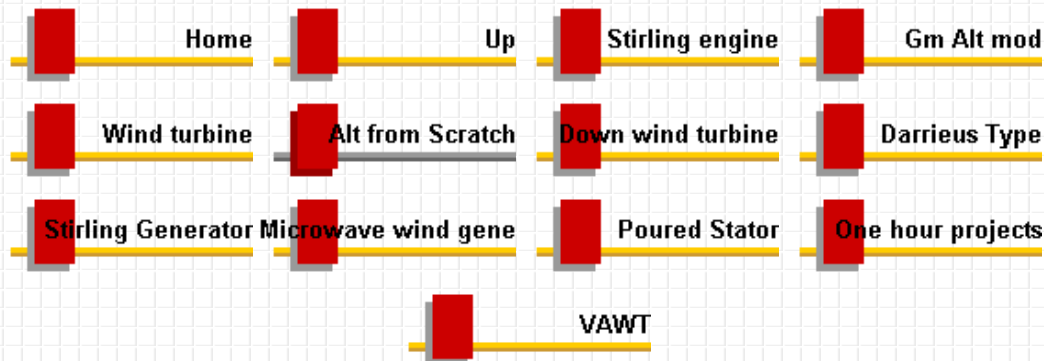

Scratch Built Axial Field Alternator

I built this alternator from some emails I recieved about direct drive units and lowering the RPM per volt. I've done a few chain drive units that work well but they have their drawbacks. Problems relating to drive losses, they require higher winds to start, and have higher maintenance to name a few.

My goal, once again, was to keep it as simple as possible so others could build one with basic tools and could be done relatively cheap. I believe what I have here accomplishes these goals.

Since Radial flux type units require specifically sized parts I chose the Axial Flux type. One of the things in the back of my mind was the "cogging" effect created by most of the PM alternators and the amount of wind it takes to start it. During the thought process for accomplishing this project I needed to either make it an "air core" or come up with a way to hand build an iron core. The "air core" type isn't very efficient in the sense that the coils aren't saturated properly when the magnets pass the coil. In order to cure this problem you would need 2 disc's with magnets on them. This would complicate the design so I started looking for other ideas. On first thought I pulled out a roll of mig welding wire and thought about rolling a "core" from this. Unfortunately, this would require a special jig and a way to separate the wires from each other. I started looking at laminations from motors, transformers or what ever I thought would transfere flux fairly well. It dawned on me that sheet metal could be used in this part of the project. I cut strips of sheet metal and strips of cardboard and coiled them up until I had a piece the size that I needed. I used Fiberglass Resin to "laminare" the coil together then glued it to a 9" disc made from 3/4" plywood. Below shows the disc and laminations glued in place.



The steel coil was glued to the wood with JB weld then the fiberglass Resin poured over the steel core. The outside diameter of the steel core is 8" and inside diameter is 5.5". The magnets I chose was Item #27 from www.wondermagnet.com. I marked the stator at 20 degree intervals so there would be 18 magnets used on the rotor. The coils had to fit over the 20 degree area and in a triangular form so I made a jig to make the coils. There is 27 coils to fill the rotor for a 3 phase set up. Each coil was 30 turns of #20 wire, and all made in the same direction. Below shows the coils of each phase being placed on the stator.



The initial tests of the single coil showed 1.1V at 630 rpm which meant I should get 9.9 Volts from the series of 9 coils. Testing showed 13.5V AC and 22V rectified which was much better than I had anticipated. I laid in all the other sets and soldered up all the connections in series for the last 2 phases of the alternator. This leaves 6 wires loose - 3 starts and 3 finishes to be wired up later. I used a hot glue gun to place the coils before finishing the stator. I reinstalled it on the lathe and started testing it with all the phases in place. In a "star" wiring it made 38 volts at 630 rpm and in a "Delta" wiring it made 22 volts. "Star" gives you more volts but less amps and "Delta" gives you more amps but less volts. I'll talk about the different wiring of it later.

Below shows the Stator filled in with fiberglass resin. This seals the unit and holds the coils in place ... permanently! The other shows the steel disc the magnets are on for the rotor. None of them were glued on during the testing. They are quite strong and are very hard to move. The steel disc the magnets are on could be a disc cut out from plywood with a sheet metal disc laminated to the plywood disc. This would serve the same purpose. The steel behind the magnets intensifies the field going to the core and through the coils.

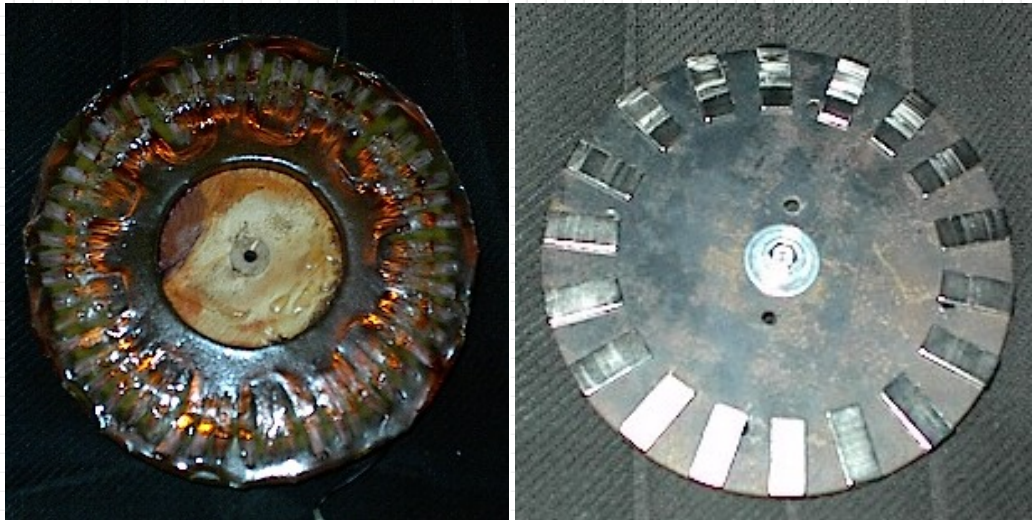

The magnet rotor will be mounted to the prop hub and the stator will be attached to the bearing head. To complete the rotor the magnets are glued in place and resin will be poured onto the plate to lock them in forever then it will have to be balanced.

Now to the wiring.... Here lies a problem, you can wire the alternator in a star configuration or in a Delta. The star gives you much more voltage but less amps and the Delta gives you less voltage and more amps. Below shows the way each of the three phases would be wired....

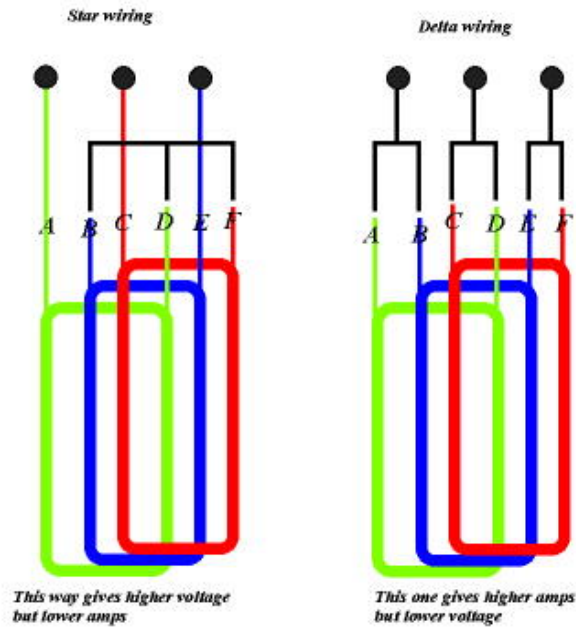

If this alternator is wired in the star configuration it will produce 217 watts at its highest rpm. In Delta could deliver up to 400 watts. Unfortunately, the delta configuration won't allow charging until it reaches 500 rpm which means our windmill wont charge until around 14mph. On the other end the star will give us 76 watts at that speed. It would seem the best solution would be to use them both. I have yet to figure out exactly how to do this.... any electronic genius's out there? I thought of using a relay that would kick in at a certain voltage... but as soon as the relay changes the voltage drops. You could use power mosfets for controlling the wiring change but how to control the transition.... either by using a hall sensor to keep tabs on the rpm.... or build a separate mini generator on the outer rim of the stator for low voltage input to the gate of the FET's.... still pondering that one.... any ideas welcome... send an [email](#)

(See below on update for a wind driven relay system)

After exerting many brain cells on this situation (at least several that I know still work) I started thinking of different approaches to this Star/Delta dilemma... First was a thought on an aircraft ASI (air speed indicator), this uses a diaphragm to exert pressure on the needle drive system through the use of a "pitot tube". Assuming you could figure out the size of tube and diaphragm to exert the right amount of pressure at a certain wind speed to move the relay, this could work. The drawbacks to this system is the fact the pitot tube could get plugged with ice, snow, bugs etc... not such a good idea. Then down to my last couple cells I thought of using the wind (like the tail) to exert pressure on the relay at a certain windspeed. This seems to be the best I've come up with so far so I decided to go with it ... unless someone comes up with something better... remember it must be simple! Below is a diagram of how the relay would be wired

Star/Delta wiring through relay

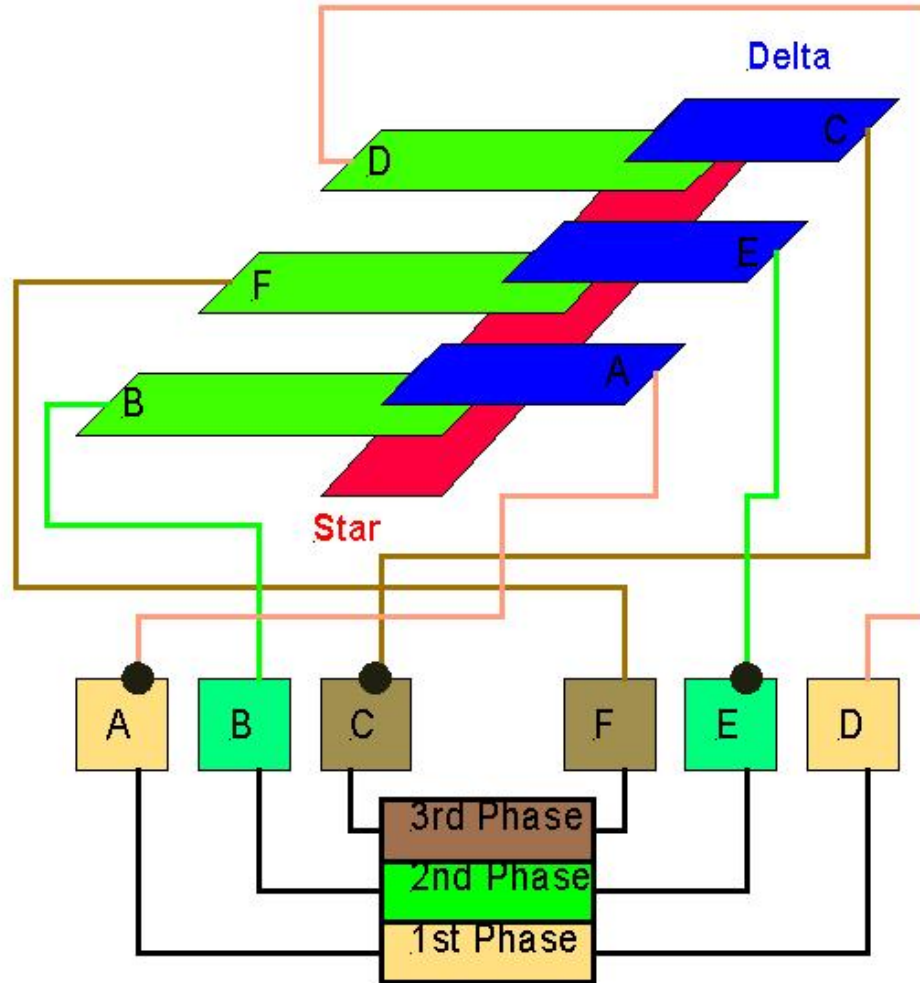

B,F,D are the moving contacts. A,C,E are the output lines. Once they are in contact with the red strip it would be in star configuration and when in contact with the blue strips its in Delta configuration. Make a mental note the 2nd phase of this alternator is reversed. This is because the phasing is off when the coils are stacked in 3's. You still wind all the coils in the same direction and wire them all the same but the start and end wires are reversed. In any case... A small tail would (will) control the movement of the contacts. I haven't as yet built this unit and have no idea if it will even work as yet... its simply a plan... more on it later...

Below is a chart of the calculated performance of this alternator. You can see where the star and delta should interchange for better output.

	Star wire configuration			Delta wire configuration		
RPM	Open V	Amps@14V	Watts	Open V	Amps@14V	Watts
200	12			7		
300	18	1.39	19.5	10		
400	24	3.41	47.8	14		
500	30	5.43	76	17	4.64	65
600	36	7.45	104	21	6.93	97
700	42	9.47	132	24	13.96	195

800	48	11.49	161	27	18.62	260
900	54	13.51	189	31	23.29	326
1000	60	15.5	217	34	27.91	391

Below shows the magnet rotor after the Fiberglass resin was poured in around the magnets and the rotor mounted on the prop hub... The green is a rust resistant coating on all the steel parts that is exposed to the elements. The magnets are placed every 20 degrees and glued directly to the steel plate with aircraft epoxy. (JB weld would work fine in this application). I used a coffee can lid (plastic) for the center and taped the outer edge of the steel plate to form a barrier to pour the Resin on. You want to make sure the rotor is level when you pour this or it will run to the low side.

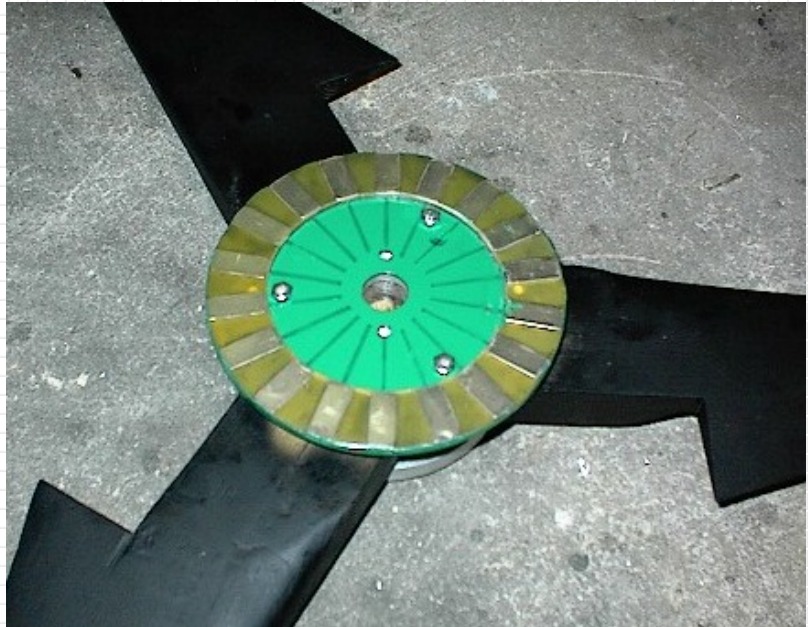
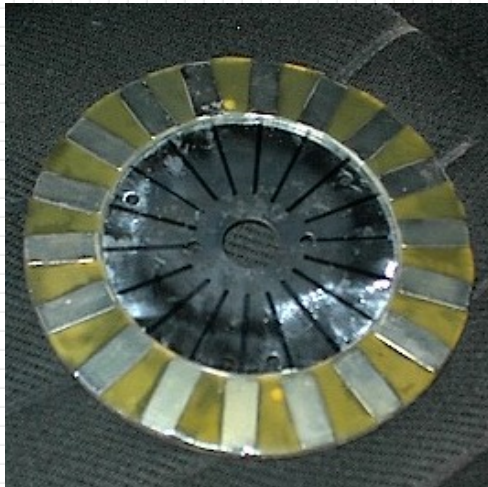

Below shows the stator on the bearing head and the prop on the unit. I still have some finishing up to do before it goes on the pole but the project has come to its final stages. I used a 6 ft prop with a TSR of 8 for this one. Shouldn't be any reason this unit won't produce 400 watts. The prop, during testing in a 20mph wind, leaped to 1000 rpm with no problem (no load on it). Very Very quiet too ! Also should start in fairly low winds because there is no restriction (such as cogging) until it comes up to speed to start charging.

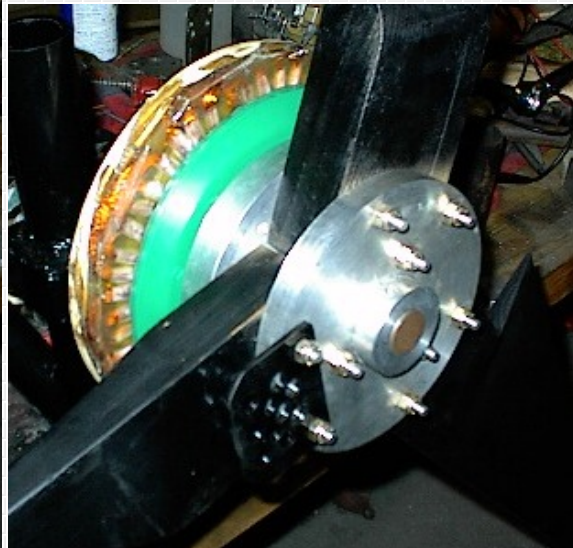

To be continued.....

Gm Alt mod

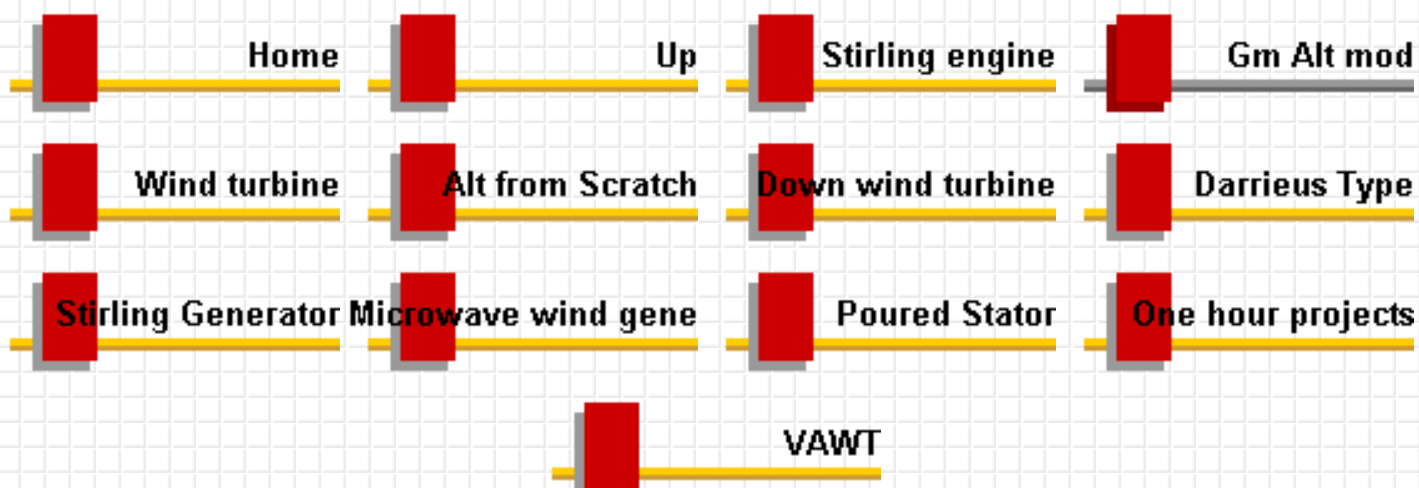

This originally started out as a 37amp alternator from the late 60's to early 70's. I machined the rotor to accept the magnets, then glued them in place one on each "finger" of the old rotor. 14 of them total. Below is a picture of the first rotor. The epoxy I used didn't hold when I spun it up to around 2500rpm. I changed to the Aircraft structural epoxy (the kind used to hold wing ribs in place) and this worked very well. In the case you can see the brush assembly was completely removed. There was no need to power the field coil any longer. This unit will now produce 750 watts of power at just under 2000rpm





I had some problems cutting the rotor because of the hardness of the material used for the rotor. I went through 3 cutting bits during the process. I decided to try a different approach on the next one. I pressed the shaft off the old rotor unit completely and made another rotor out of a piece of 6061-T6 aircraft aluminum I had laying around. Although it seems like a bit more work (starting from scratch) it actually didn't take as long and I can use the same cutter on other projects also. Below is a picture of the shaft removed from the rotor and the aluminum rotor pressed on the shaft...



Most of the machining was done after the shaft was pressed into the new rotor. The next one shows the soft iron strip cut to fit the slot. The slot was cut deep enough to recess the magnets and the metal strip. The next picture shows the metal strip with a magnet laying in the groove



I roughed up the metal strip with a 20grit sanding disc (paper with a rock glued to it - its pretty rough). Then proceeded to glue the strip into place. I used a hose clamp to pull it in place and hold it until the epoxy set up. Actually put it in the oven at 150 degrees for an hour to help cure it a bit quicker.... worked well. The picture on the right shows the magnets in place and the spacing....



Below shows the magnets all glued in place and the rotor is ready to go back into the case....



After the new rotor was installed, the first tests came out quite good. Initially turning the rotor I noticed less cogging with the larger magnets. On the machine it showed 36.1 volts at 1500 rpm. It came up almost another volt from the first one. Amps were similar to the first. This one produced 50 amps at 1850 rpm. I rewound a stator with one size wire smaller and installed it in a case using this rotor and it now produces 50 volts at 1500 rpm but the output amps dropped (give and take unfortunately).

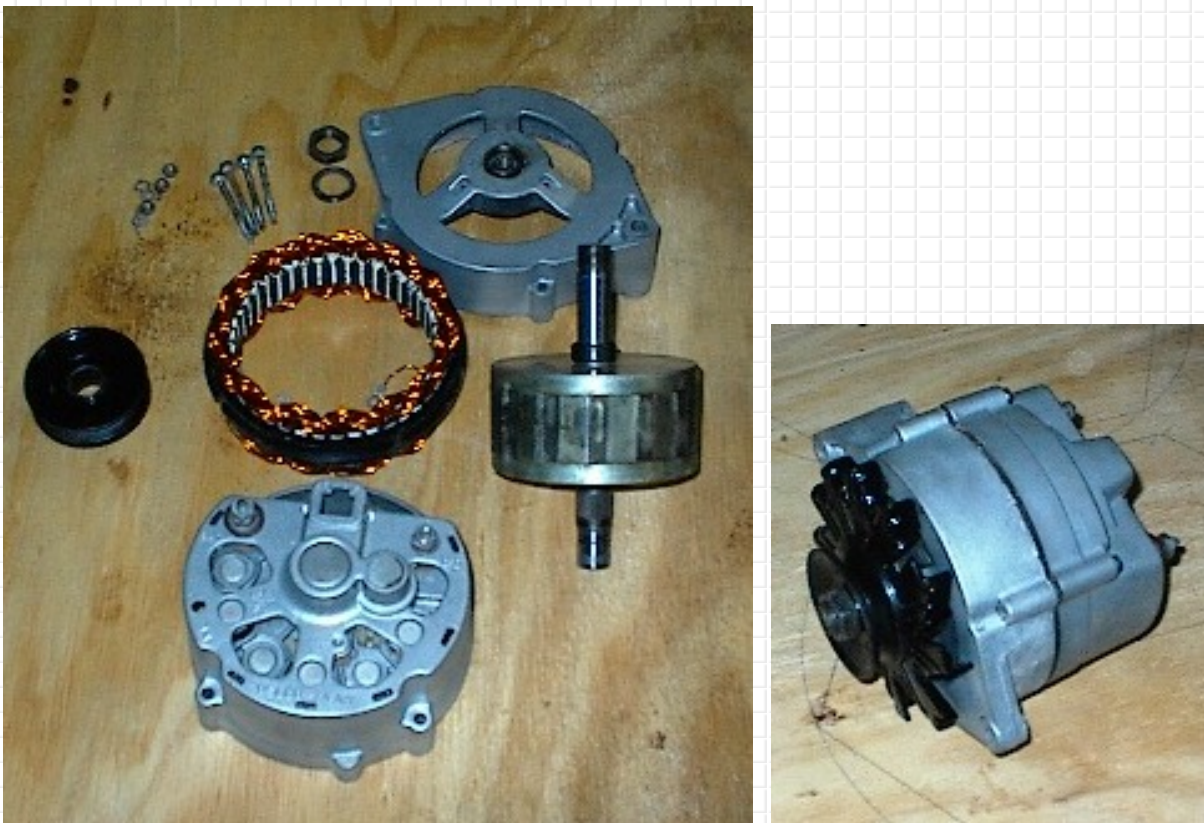

Above... all the parts to the completed unit and the unit completed

Below is a comparison chart of the three units I've tested....

	<u>Original modification</u>	<u>New Rotor</u>	<u>New windings</u>			
<u>RPM</u>	<u>Open Volts</u>	<u>Amps</u>	<u>Open Volts</u>	<u>Amps</u>	<u>Open Volts</u>	<u>Amps</u>
300					9.9	
400					13.2	
500			12		16.6	1.7
600	13.9	1.4	14.5		20	4.5
700	16.2	2.8	16.8	3.7	23	7
800	18.6	6.6	19.2	7.7	26	9.5
900	20.9	10.5	21.6	11.8	30	12.8
1000	23.2	14.4	24	15.8	33	15.3
1500	34.8	33.8	36	35	50	29.5

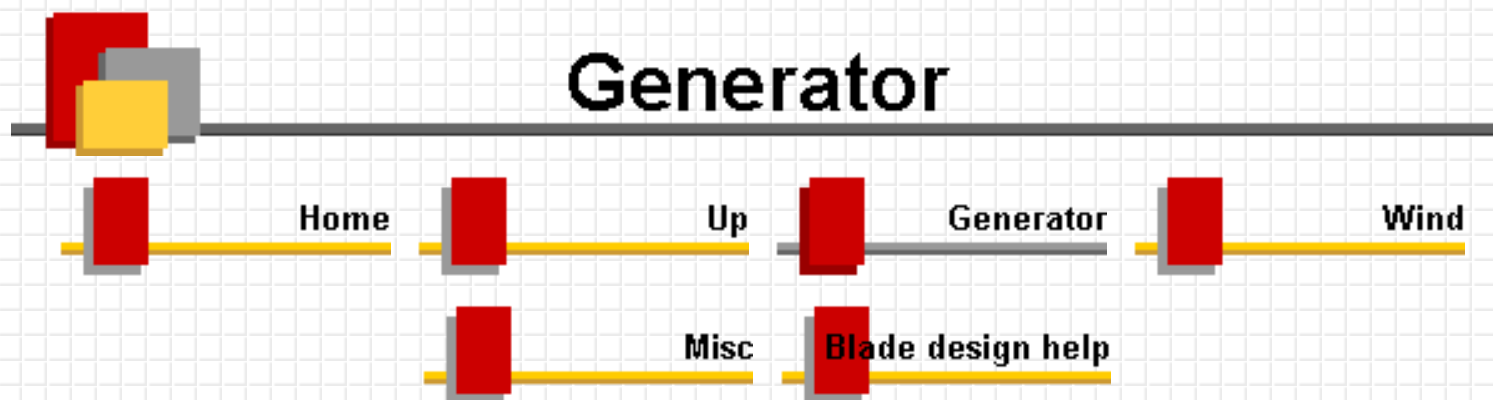

Handy Formula to calculate the output of any generator at any given RPM.....

First off 3 things must be known... RPM, Open voltage at that RPM and the Ohm's of the stator coil.

- 1. Measure the RPM*
- 2. Measure the Open voltage at that RPM*
- 3. Measure the Ohm's of the stator coil.*

Measured RPM / Open volts = RPM per volt

To find a Desired output the formula is:

Volts + (Amps * Ohms) = Open Voltage (necessary to achieve this output)

Open voltage * RPM per volt = RPM needed to achieve desired output

Example: Alternator spinning at 1500 RPM delivers an open voltage of 34.8 volts so....

**1500 / 34.8 =
43.1 RPM per
volt**

**The stator coil
reading is .6
ohm**

**Lets say we
would like 14.6
volts at 10
amps from our
unit**

**14.6
volts
+
(
10
amps
*
.6
ohm
)
=20.6
open
voltage**

**20.6
*
43
rpm
per
volt
=
885.8
RPM**

***If you would like to know an output at a certain RPM you
simply change the formula to:***

**RPM
/
RPM
per
volt
=Open
Voltage**

**(OpenVoltage-desiredvoltage)
/ohms
=
Amps**

Example: 885 RPM at 14.6 volts

$$\begin{aligned} & 885 \\ & / \\ & 43 \\ & = \\ & 20.58 \\ & (\\ & 20.58 \\ & - \\ & 14.6 \\ &) \\ & / \\ & .6 \\ & = \\ & 9.97 \\ & \text{amps} \end{aligned}$$

And there you have it... since, for the most part, the voltage and rpm are a constant its easy to calculate the output of any unit

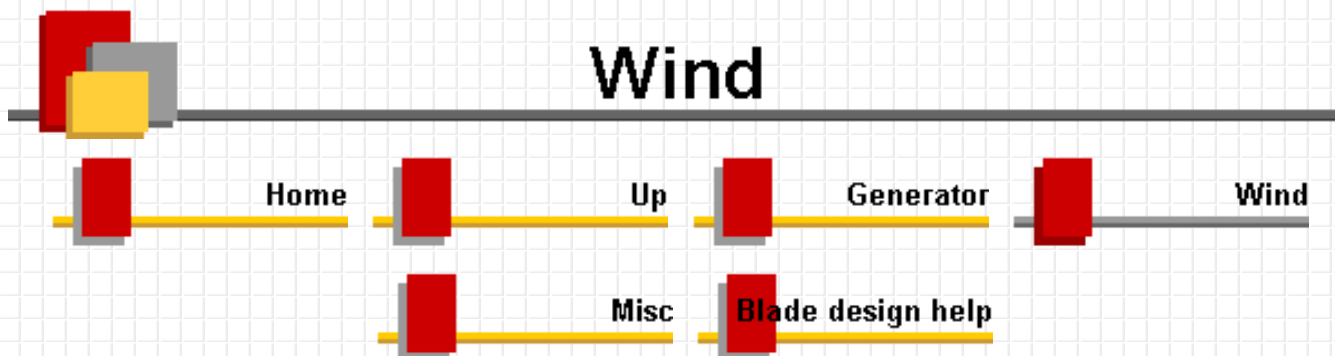

Wind Charts How much power is in the wind?

$$P = .5 * AD * (D^2 * .7854) * V^3$$

Where: P = power in watts

AD = air density (typically 1.22 at sea level)

D = Diameter of prop (in meters)

V = Velocity of the wind (in meters/sec)

So we could say in a 20mph (8.9 m/s) wind and a 6 ft dia (1.8 m) prop there is ...

$$P = .5 * 1.22 * (1.8^2 * .7854) * 8.9^3 \text{ or}$$

$$P = 1094 \text{ watts passing through the prop}$$

Unfortunately we cant capture all of it and most blades range in the 20% to 40% range so we need to add this into our formula...

$$P = .5 * 1.22 * (1.8^2 * .7854) * 8.9^3 * .4$$

$$P = 437 \text{ watts coming out of our blade at the shaft.}$$

Now there are some other losses we have to deal with... The generator or alternator we are using isn't 100% efficient so we need to add this into the formula. We can say that our blades are 40% efficient and our generator is 60% efficient so... Our overall efficiency would be (.4 * .6 = .24) 24%. So now we add that into the total and we get...

$$P = .5 * 1.22 * (1.8^2 * .7854) * 8.9^3 * .24$$

$$P = 262 \text{ watts}$$

This is the majority of the losses but there are others that we won't worry to much about at this point. The formulas above will give you a close general idea of what your machine might produce.

Here are a few formula's from Hugh Piggott's book "Wind Power workshop". He has allowed me to put them up on my site via email. Again I strongly recomend his books for anyone getting into wind power.

If you know what your alternator/generator will do in watts, this one will help determine the size prop you will need to run it....

$$D = (P / (Cp * rho / 2 * Pi / 4 * V^3)) ^ 0.5$$

Where D = Diameter of prop in meters
 P = power in watts
 C_p = overall efficiency (typically .15 to .20)
 ρ = air density (1.22 at sea level)
 V = velocity of the wind in meters/second

If you have a prop you plan to use, this one will determine the power output you can expect...

$$P = C_p * \rho / 2 * \pi / 4 * D^2 * V^3$$

To find the TSR (tip speed ratio) of a prop at a given output...

$$TSR = rpm * \pi * D / 60 / V$$

example: say you find a generator that can produce 500 watts at 1000 rpm...

$$TSR = 1000 * 3.14 * 2 / 60 / 10$$

$$TSR = 10.46$$

Since 10.5 would be fairly tricky to obtain we can try others. To calculate the rpm at a given TSR...

$$rpm = 60 * V * tsr / (\pi * D)$$

example: with a tsr = 6 we would get...

$$rpm = 60 * 10 * 6 / (\pi * 2)$$

$$rpm = 573 \text{ rpm}$$



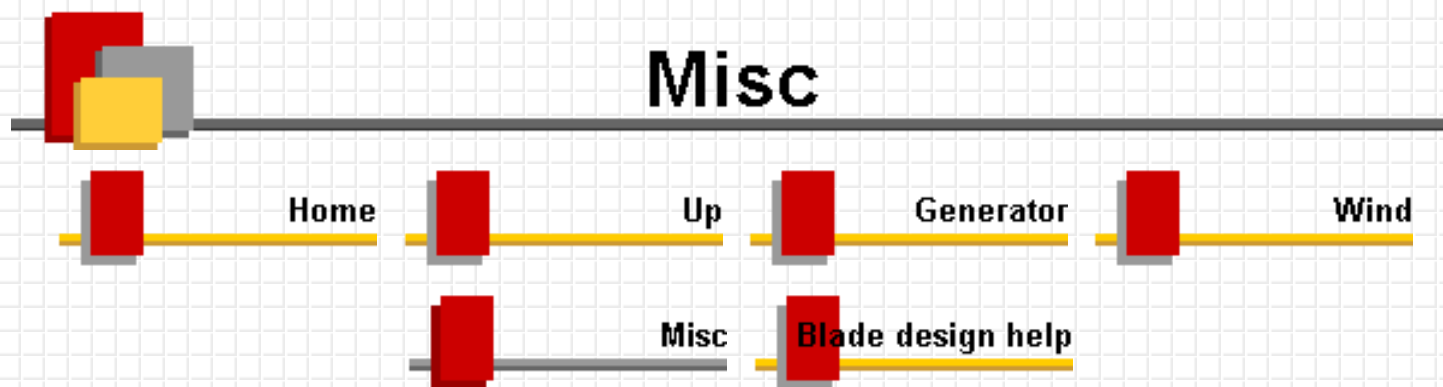

Horsepower and torque:

$$\text{HP} = \text{Torque} \times \text{Rpm} / 5252$$

$$\text{example: } 2\text{hp} = 35 \text{ ftlbs} \times 300 \text{ rpm} / 5252$$

$$\text{Torque} = \text{HP} / (\text{Rpm}/5252)$$

$$\text{example: } 2\text{hp} / (300 \text{ rpm} / 5252) = 35 \text{ ftlbs}$$

$$\text{Rpm} = \text{HP} / (\text{Torque}/5252)$$

$$\text{example: } 2\text{hp} / (35 / 5252) = 300 \text{ rpm}$$

Power = Work / Time

Work = Force * Distance

Power = Force * Distance / time

BTU (British Thermal Units)

BTU is the rate of bringing 1 lb of water up 1 degree.

BTU = pounds of water * difference in temperature rise

1 cubic foot of water = 64.2 lbs

So to bring 1 cubic foot of water from 50 degrees to 100 degrees (50 degree difference)

$$\text{BTU} = 64.2 \text{ lbs (1 cubic foot) } * 50 \text{ degrees}$$

$$\text{BTU} = 3210$$

1 cubic foot of water = 7.48 gallons (or 8.58 lbs per gallon)

Say you have a gallon of water (8.58 lbs) and its at 60 degrees, you want to bring it up to 110 degrees. You will need a 50 degree rise in temperature

$$\text{BTU} = 8.5 * 50 = 425 \text{ Btu}$$

$$\text{Watts} = 425 \text{ Btu} / 3.41 = 125 \text{ watts}$$

So at 125 volts you would need one amp for one hour to bring the water to the desired temperature.

Centrifugal Force:

$$.000341 * W * R * n^2$$

Where: W = weight of outer ring

R = Radius in feet

n = RPM

Kinetic energy:

$$E = (W * V^2) / (2 * g)$$

Where E = total energy in flywheel, in ft lbs

W = weight of flywheel

V = velocity in feet per second of outer radius

g = acceleration due to gravity (32.16)

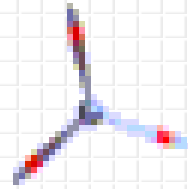
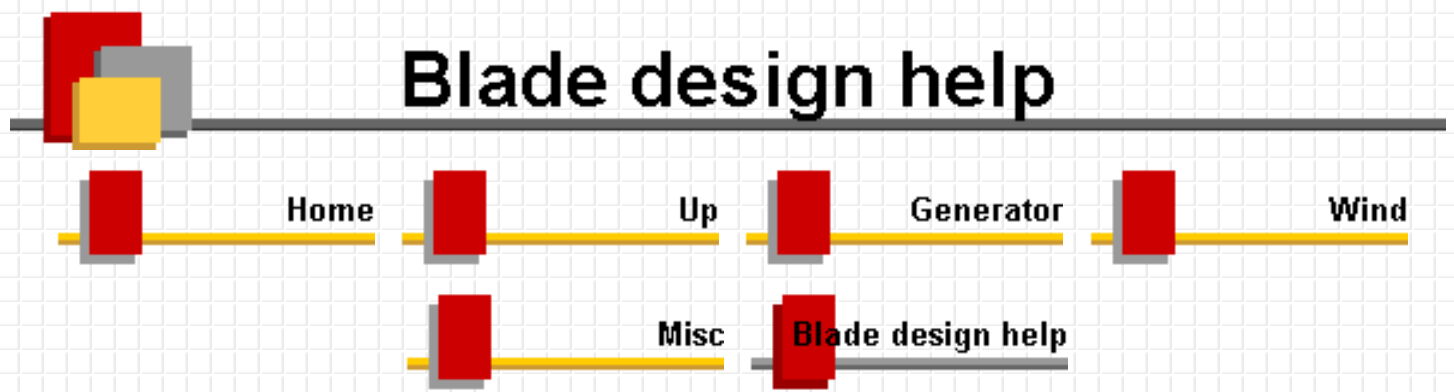

The Blade Designer Program - A Free Basic Help Tutorial in Blade Design

Blade designer

Rotor diameter (meters)

Tip Speed Ratio

Number of Blades

Angle of attack (deg)

Lift coefficient

Number of stations

Overall efficiency

Station	Radius (in)	Blid ang (deg)	Chord (in)	Thickne (in)	Drop (in)
1	12.	19	9.32	1.4	3.58
2	24.	8	5.24	.79	1.07
3	36.	4	3.58	.54	.49
4	48.	2	2.71	.41	.28
5	60.	1	2.17	.33	.18
6					
7					
8					
9					
10					

Estimated Prop performance

	Watts	RPM
10 mph 4.4ms	60	224
12 mph 5.3ms	103	269
14 mph 6.2ms	164	314
16 mph 7.1ms	244	359
18 mph 8.0ms	348	404
20 mph 8.9ms	477	448
22 mph 10ms	635	493
24 mph 10.7ms	824	538
26 mph 11.6ms	1048	583
28 mph 12.5ms	1309	628

Calculated Generator performance

Amps	Open V	Rpm	Ratio	Watts at Rec Ratio
4.05	17.23	666	2.97	83
6.96	18.98	734	2.73	173
11.08	21.45	829	2.64	263
16.49	24.69	955	2.66	353
23.51	28.91	1118	2.77	443
32.23	34.14	1320	2.95	531
42.91	40.54	1567	3.18	621
55.68	48.21	1864	3.46	711
70.81	57.29	2215	3.8	801
88.45	67.87	2624	4.18	891

INPUT: wind velocity in m/s to calculate rotor thrust

Rotor thrust in pounds

Rotor offset in inches

Tail Size in square feet

Recommended Ratio

User Ratio

Open Voltage

Measured Rpm

Measured Ohms

Regulated Voltage

The inexpensive "blade designer program" is available for purchase from <http://www.windstuffnow.com>

The Blade Designer program was written by Ed Lenz.

This basic tutorial is written by Fred Tonch on May 28 2003 from <http://www.internetfred.com>

For corrections or errors in this document - please email Fred info@internetfred.com or Ed at elenz@net-link.net



Table of contents:

1. introduction
2. hints
3. the program input parameters
4. adjusting the ratios (added features)
5. all adjustments and effects list

6. estimated propeller performance and calculated generator performance
7. using the tables to produce a propeller (optimizing the design)
8. blade terminology
9. building with the design and building the blade
10. credits



Introduction

About a year and a half ago, I began the daunting task of wanting to create a wind turbine for the sole purpose of producing power. I quickly found out this year that a basic understanding of aerodynamics is a requirement if your intention like mine, is to build and design such a device. Without the proper propeller matched to the generator, the power achieved will be substantially lower than with a matched propeller. The generator and propeller go hand in hand.

I am writing this basic help tutorial from the standpoint of a beginner wind turbine builder. I also suggest purchasing "Windpower Workshop" from Hugh Piggott also available from windstuffnow, as it has the basic essentials and guidelines necessary to building a wind turbine. The book has fairly extensive information regarding blade design and parameters required in design of a turbine. Only the basics will be covered in this help document.

The blade designer program has many added features which are not apparent at first glance. **Armed with the book and this program, basically any small wind turbine and blade can be designed, built and matched to produce maximum output.**

For all types of metric and standard number conversions, use the free program available for download called "[win-convert express](#)". This is a simple zip file. Note: if you are using win95/98 then you must download visual basic 6 runtime if you do not have it installed already or the converter will not work. This program is called VBRun60.exe. Do a search on www.google.com to find it.



Hints:

In this help document I use the words "blade" to mean a single blade and the "propeller" a unit composed of individual blades and a hub connected together as a single unit. Making blades into a propeller is a replication process. Many blades can be produced at once with this program and assembled into a propeller. Also note that some people call the propeller a rotor. Actually the a rotor is a part of the generator, hub housing and spindle assembly, but anything that rotates can be considered a rotor so it's ok to use the term rotor in use of propeller or it's short form "prop".

In the program the highlighted areas marked in a darker gray color are for inputting parameter variables or values used to design a blade. A calculated value located in a table is not changeable except by the adjustment menus. All adjustments and effects were found by adjusting with each input and watching the result or effect. It is highly suggested that you do this also, since it will tell you how the program functions and calculates.



The web site <http://www.windmission.dk/workshop/BasicBladeDesign/bladedesign.html> also offers a very good tutorial on blade design and number crunching.



The Program Input Parameters

Rotor diameter (meters)	3.048
Tip Speed Ratio	8
Number of Blades	3
Angle of attack (deg)	4
Lift coefficient	.8
Number of stations	5
Overall efficiency	.15

This is the basic area for inputting parameters to create the blade. This is the first menu that will be discussed into it's simpler parts below.

- 
Rotor diameter in meters - the total diameter of the propeller. Here are some standard numbers. To find rotor size in meters you can convert ft to meters by multiplying ft x .3048
- 
 The Diameter is two times the distance from the center of the hub to the tip of the blade. It also can be looked at as the distance across the circle that the propeller would make when rotating. This is also know as the total swept area.

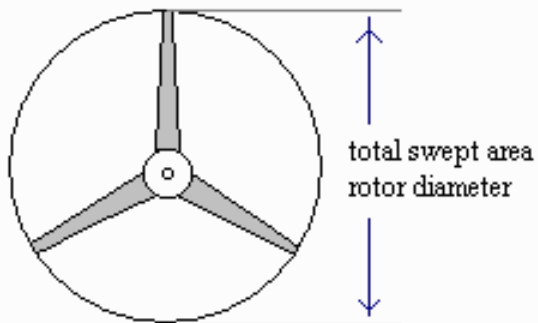

Standard Meters to Feet

.04 m = 0.131 ft

.08 m = 0.262 ft

.5 m = 1.46 ft

1 m = 3.28 ft

1.5 m = 4.92 ft

2 m = 6.56 ft

2.5 m = 8.20 ft

3 m = 9.843 ft

3.5 m = 11.48 ft

4 m = 13.12 ft

4.5 m = 14.76 ft

5 m = 16.40 ft

- Tip Speed Ratio (tsr)**- How many times faster than the wind speed, the blade tip is designed to run. The tip of a blade can travel faster than the wind. The tip speed "ratio" is the optimum between stall and runaway. Typical tip speed ratios are 1 thru 10. Tip Speed Ratio (tsr) = (tip speed of blade) / (wind speed).
- Notes:** Rotors are designed to run best at a particular 'tip speed ratio', but in reality they run at a speed which also depends how they are loaded. If the generator draws more power than the rotor has to offer then it slows, and often stalls.

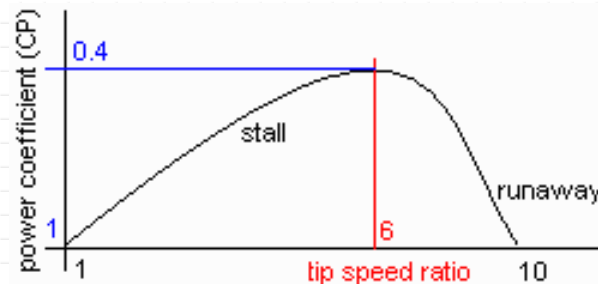

- Number of blades**- 3 blades is most preferred and most often used. 2 blades produces noise, rattle, imbalance, harder to start in low winds and other problems (tsr>4). (check out <http://www.windmission.dk> for multi bladed designs (tsr<2) at lower wind speeds)
- Angle of attack**- in degrees. This is the propeller efficiency. 4 degrees is standard. Numbers here can range from 1 deg to 15 deg typical. The angle between the chord line of the airfoil and the flight direction is called the angle of attack. Angle of attack has a large effect on the lift generated by an airfoil.

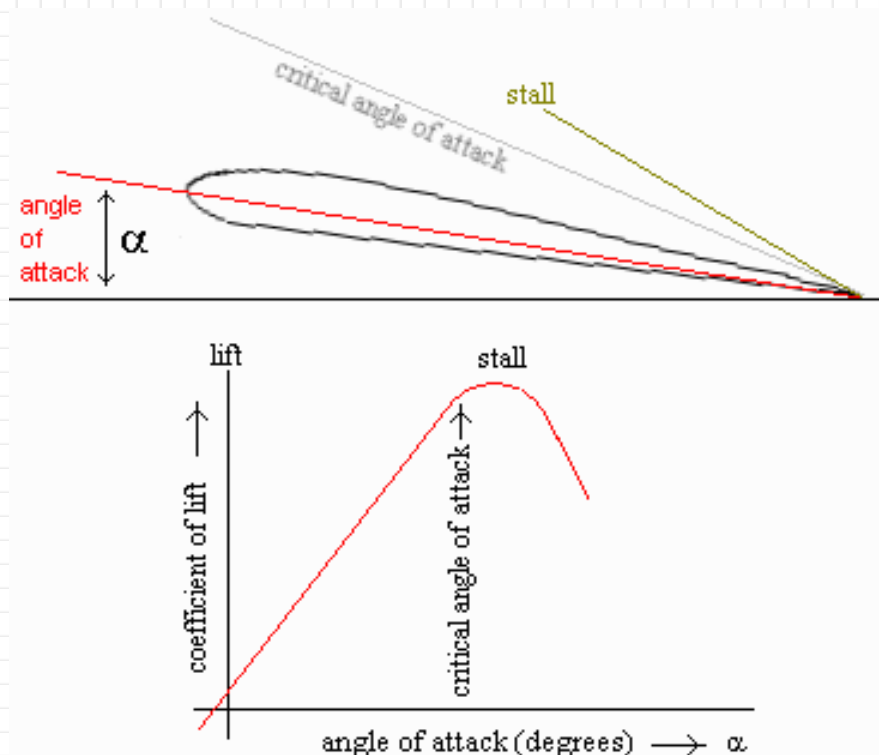

- Lift Coefficient** - the lift coefficient is approximately two times pi (3.14159) times the angle of attack expressed in radians. Standard setting =.8 Typical numbers range from .8 to 1.25
- Number of stations** - This is used to create the blade on a piece of wood. The stations are markings spaced at intervals.

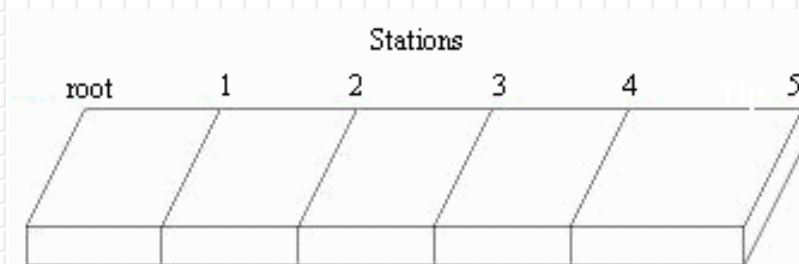

Mechanical losses in the propeller, hub and spindle and electrical and magnetic losses such as usage of iron and wire resistance in the generator effect overall efficiency. All of this is calculated and included in the overall efficiency of the generator.

Typically on a propeller type it ranges from 25-35% overall and on Savinuous type about 15%. So if you have a prop making say 45% efficient use converting wind into power and an alternator that is 75% efficient then the over all efficiency would be about 33% ($.45 \times .75 = .3375$). This doesn't include any transmission line losses though.

-  **Overall Efficiency** - Overall efficiency is basically the power you will get out of the generator.





Adjusting the ratio's (added features)



Calculated Generator performance				
Amps	Open V	Rpm	Ratio	Watts at Rec Ratio
4.05	17.23	666	2.97	83

Adjusting the above calculated values for generator performance.

<input checked="" type="radio"/> Recommended Ratio	3.134
<input type="radio"/> User Ratio	1
Open Voltage	38.8
Measured Rpm	1500
Measured Ohms	.6
Regulated Voltage	14.8

This menu is for adjusting the calculated generator performance values.



-  The Recommended Ratio - This number is a calculated value ratio of all factors of wind speed.
-  The User Ratio - This number is an input option, the user ratio is used to adjust the "Watts at recorded ratio"
-  The Open Voltage is the open voltage from either a "to be built" or "already built" generator

-  The Ohms is the total ohms from either a "to be built" or "already built" generator
-  The Regulated Voltage measured in DC is the voltage from either a "to be built" or "already built" generator

INPUT: wind velocity in m/s to calculate rotor thrust	<input type="text" value="10"/>
Rotor thrust in pounds	<input type="text" value="85.34"/>
Rotor offset in inches	<input type="text" value="4.8"/>
Tail Size in square feet	<input type="text" value="2.5"/>















This menu allows you to input the wind velocity and adjusts the following calculations.

Regarding the tail size, the number represented in the program is the minimum size in square ft you should have. It can be any size or shape as long as it has the minimum amount of sq ft area .

-  Rotor thrust in pounds - This is the amount of thrust exerted on the blade during operation calculated by the wind velocity.
-  Rotor offset is for the furling system. This offset is the number of inch's to offset the furling system from the center rotor of the windmill.
-  Tail Size - When thrust is applied to the rotor this is the tail size required by the turbine to keep it stabilized.



All Adjustments and Effects List

-  Adjusting the rotor diameter effects all numbers in all the tables calculated.
-  Adjusting the tip speed ratio effects the stations ratios, estimated propeller performance rpm, calculated performance generator - ratio; and calculated performance generator -watts recorded ratio.
-  Adjusting the number of blades effects the stations ratios -cord, thickness and drop.
-  Adjusting the angle of attack effects the stations ratios - Bld angle (blade angle)
-  Adjusting the lift coefficient effects the stations ratios - cord, thickness and drop.
-  Adjusting the number of stations effects the stations ratios - station number
-  Adjusting the overall efficiency effects the estimated propeller performance -watts & rpm, all calculated performance generator variables and the recommended ratio.
-  Adjusting the user ratio effects the calculated generator performance -watts recorded ratio
-  Adjusting the open voltage effects the calculated generator performance - rpm, ratio & watts recorded ratio
-  Adjusting the measured rpm effects the calculated generator performance - rpm, ratio & watts recorded ratio
-  Adjusting the measured ohms effects the calculated generator performance - rpm, ratio & watts recorded ratio and the open voltage
-  Adjusting the regulated voltage effects all calculated generator performance variables
-  Adjusting the wind velocity effects the rotor thrust in pounds
-  Adjusting the rotor diameter adjusts the rotor thrust, rotor offset and tail size.



Estimated Propeller Performance and Calculated Generator

Performance

The next menu is the calculated "estimated prop performance and the calculated generator performance". These numbers are not input variables, they are calculated from the above input parameters.

Estimated Prop performance			Calculated Generator performance				
	Watts	RPM	Amps	Open V	Rpm	Ratio	Watts at Rec Ratio
10 mph 4.4ms	60	224	4.05	17.23	666	2.97	83

Estimated Propeller performance

- The estimated propeller performance numbers given in watts and rpm is the amount of power that can be achieved by the propeller doing work.

The Calculated generator performance

- Amps - How much amperage can the generator deliver
- Open Voltage - how much voltage can the generator deliver without a load connected
- Rpm - this is the calculated speed in revolutions per minute of the generator rotor.
- Ratio - This is a calculated drive ratio. If your going to use a belt or chain drive instead of direct drive. This example picture above shows almost a 3 to 1 drive or basically running the alternator 3x faster than the prop rpm. What it does is figures out the best possible match for each wind speed then averages it out in the bottom as the recommended ratio. Or you can simply click on the user ratio button and put your number in. Direct drive would be 1 or any other ratio and the watts will show what the unit would do with that ratio.
- Watts Recorded Ratio - This is the generator performance ratio for watts. This ratio reflects the alternator speed in relation to the blade speed. In the program when the user ratio is clicked the recommended ratio is no longer of any use. "watts recorded ratio" is actually "recommended" ratio.



Using the tables to produce a blade

(optimizing the design)

I have asked Ed to give a brief note on using the program to create a blade. Ed will now describe the principles behind optimizing the blade design and what to look for.

In the break down of data tables, the perfect blade would reflect the watts from the prop and the watts in the generator to match perfectly. For instance if the blade is making 100 watts and the generator is making 100 watts that's a perfect match. Unfortunately this is very unlikely. We have to deal with a wide range of rpm's and there is always an imbalance somewhere in the range.

Estimated Prop performance			Calculated Generator performance				
	Watts	RPM	Amps	Open V	Rpm	Ratio	Watts at Rec Ratio
10 mph 4.4ms	60	224	4.05	17.23	666	2.97	83



You have to design the blade to work within the average wind speed of your area. So if your area was in the 10-20 mph wind range you would try to match the prop and generator to that wind speed as best as possible. If the prop watts are lower than the generator watts the blade will stall and never reach its designed TSR and ultimately never reach its power at that speed. If the prop watts are higher than the generator then the blade will start to spin faster to meet the generator load. This is the optimum, where the the generator and the prop meet.

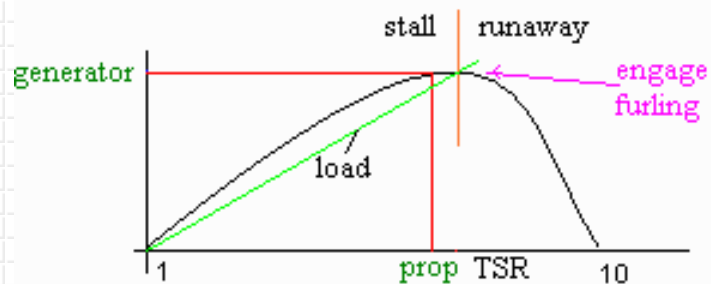

There is a point where the prop will "run away" from the generator. This means the load provided by the generator isn't enough to keep the blades at their optimum designed speed.

This can cause a couple problems...

1. The prop is now running beyond the TSR it was designed for and can cause blade erosion, where the leading edge close to the tips and the tips of the blades will start pitting and cracking... especially in rain or adverse weather.
2. Since the blade is producing more power than the generator, the generator is trying to produce more than it can... this causes heat which ultimately will burn up the windings and possibly ruin a good set of magnets.

If we keep them matched as close as possible the load will control the prop speed and all is well. Usually, where the prop starts to run away from the generator is where its best to start furling the blade. The cause of this imbalance is because the power coming through the prop is cubed and the generator output is linear.

So its a give and take situation... either give up the low end or give up the high end.



Blade Terminology

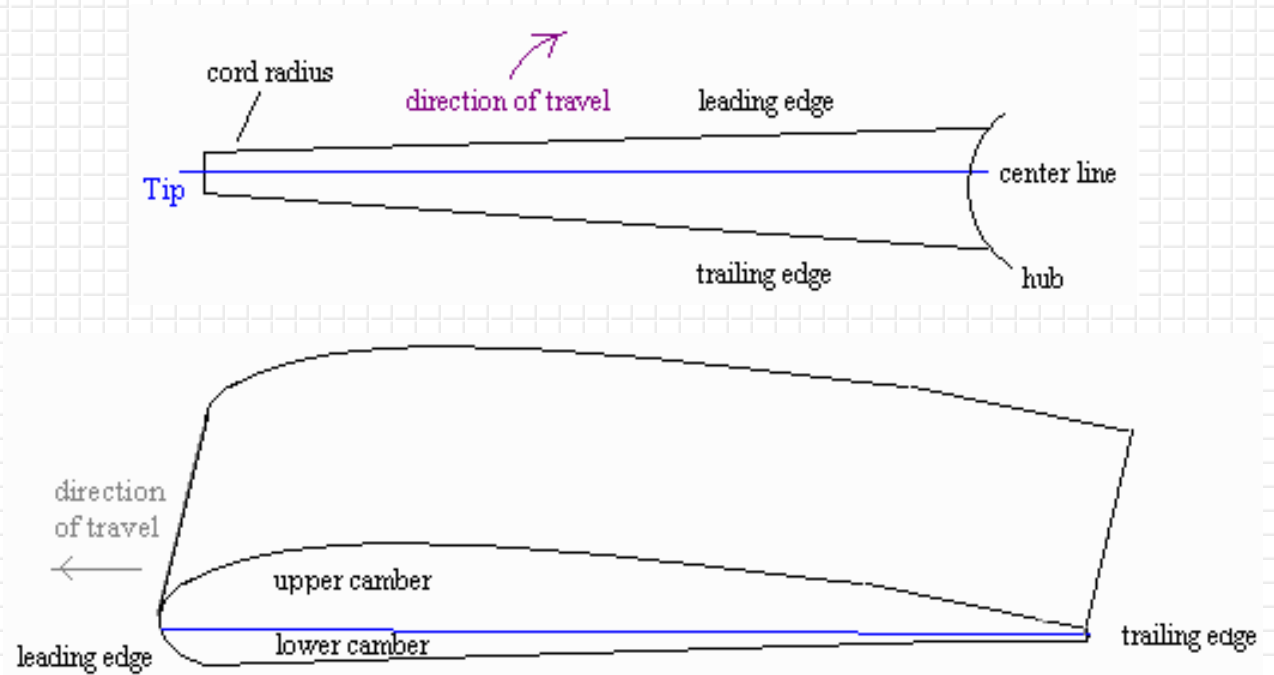

Camber is often used but misunderstood. Defined as curvature in the mean thickness line of the blade section.

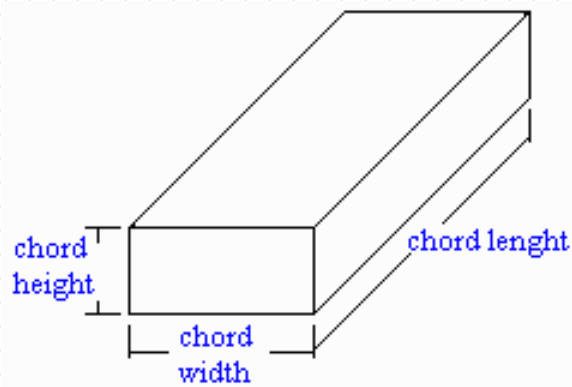

Building the blade

Station	Radius (in)	Bld ang (deg)	Chord (in)	Thickne (in)	Drop (in)
1	12.	19	9.32	1.4	3.58
2	24.	8	5.24	.79	1.07
3	36.	4	3.58	.54	.49
4	48.	2	2.71	.41	.28
5	60.	1	2.17	.33	.18
6					

This table is composed of the following:

- The station number - stations are markings spaced at intervals.
- The Radius in inch's - The radius of the blade at each station. Section length is the same as blade width. Each station is expressed as a percent of radius increment (i.e.: 40 radius is 40% of the blade radius) .
- The Blade Angle in degrees - Basically the angle of that portion of the blade when its carved. This is the angle of the blade based on the "drop" and "chord width"
- The Chord in inch's - This is the chord width
- The Thickness in inch's
- The Drop in inch's

This is the calculated station numbers used to produce the blade as follows

- **Please Note:** At this point it is highly suggested that you consult the windpower workshop book for greater detail into the building of the blade. This is only a very basic layout.
- A blade is thickest at the root for structural integrity

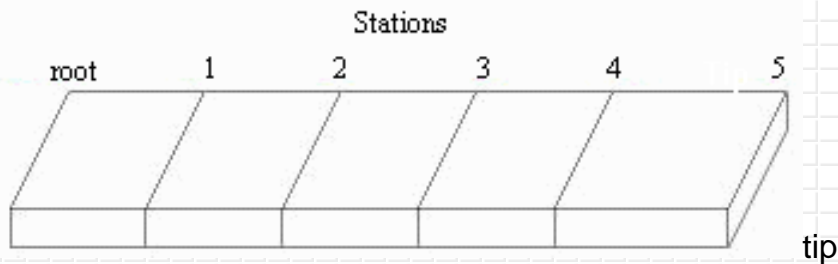

- Mark out the stations, draw the lines completely around the material

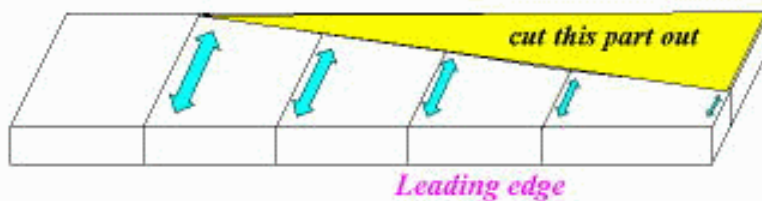

- Taper the blade - mark the width out and cut out parts marked

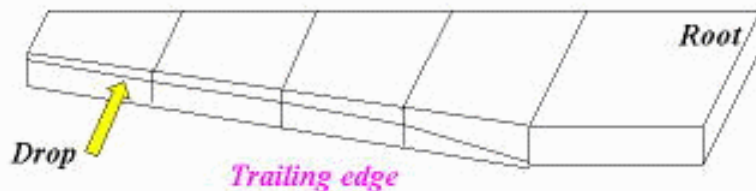

- Mark the drop of each station

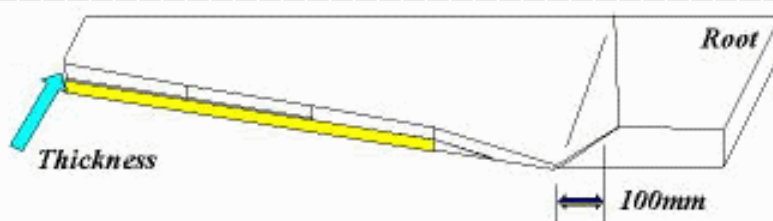

- After carving it looks like this
- Next measure the thickness of each station on both sides and remove the material from the other side

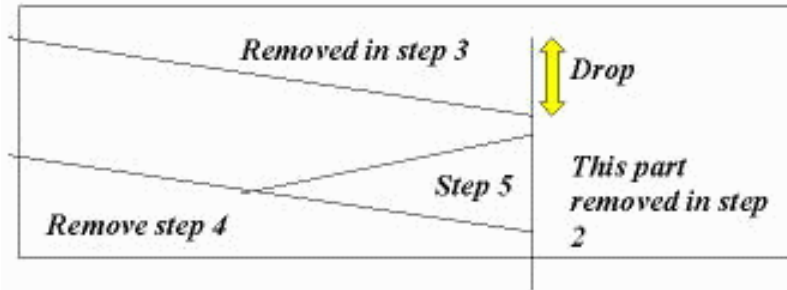

- A cross section of the blade

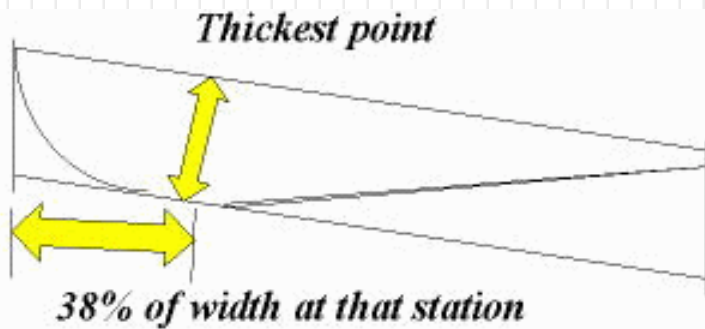

- Another cross section of the blade

I wish you good luck on your project and please send me pictures and web links of your latest projects!

www.internetfred.com

Credits

I would like to thank the following people that contribute their talents, inspiration and knowledge each day!

THANK YOU ALL FOR THE FANTASTIC WORK, WEB PAGES AND IDEAS!

Ed Lenz - www.windstuffnow.com Fantastic Work! Keep it up!

Hugh Piggott <http://homepages.enterprise.net/hugh0piggott/> You da Man!

Tom S - <http://home.cogeco.ca/~tszaran/indexz.html> Huge thanks for listening and inspiring!!!

Bryan D - Pure inspiration - zero perspiration! ;-))

Dan B and Dan F - <http://www.otherpower.com/> The chat rooms are just to much!! ;-))

JK TAS Jerry <http://www.dplusv.com/Photo-03.html> - Keep snapping those photos! There great!

August 31, 2004

[Home](#) | [Your Account](#) | [View Cart](#) | [Contact Us](#)[Advertising Info](#)You are at: [Home](#)

Site Search:

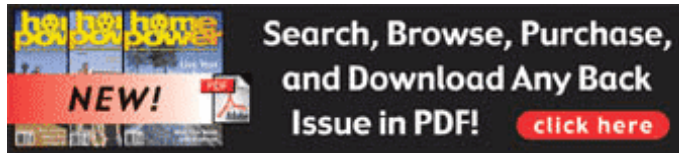
**HP Magazine**[Issue #102 Contents](#)[Download Current Issue #102](#)

Welcome to HomePower.com!

Home Power magazine, the hands-on journal of home-made power, grew out of our passion for renewable energy (RE). We're concerned about a world that is increasingly polluted. We're concerned about the high energy use and waste of "developed" cultures. And we're concerned that people are dependent and unable to care for themselves when it comes to energy. Renewable energy gives people control over their energy future by using energy that is provided daily by nature. New to Home Power... [click here](#) to learn about us!

Need HELP? Locate an RE business in your area:



Solar Energy International
ON-LINE
RE Education
Register NOW!

Poll

My electrical know-how has enabled me to confidently

Wire a PV array or equivalent system

Run a new branch circuit from my breaker panel

Install wall receptacles and switches

Repair a table lamp

Change my own light bulbs

[View Results](#): 3912 votes

([Click here](#) for our complete reader survey or to post other comments.)

Feature Articles**Solar Cheese**

The Vella Cheese factory has been soaking up the abundant California sun and solar energy rebates and tax credits. This family-owned and operated small business saves money on its monthly electricity bills with a 30 KW grid-intertied, solarelectric system. The factory combines Old World values and modern technology to produce its fine cheeses at one of Sonoma, California's oldest and most historic businesses.

Ignazio Vella understands that his success in making award-winning cheese lies in his attention to each day's production and the quality.... [more](#)

Hybrid Vehicle

A redesigned mid-sized envirocar is on the block the 2004 Toyota Prius. The Prius has become very popular with people concerned with the environment. This is due in some part to the environmental impact of emissions, increasing fuel prices, potential gas shortages, and our dependence on foreign sources of fuel. The engineering crowd likes it for its design and technical excellence, and the wealthy and famous have embraced the Toyota Prius as well.... [more](#)

RE Tips

To increase your PV array's seasonal output, you can adjust its tilt angle several times a year.

Home Power On The Road!
technical advice • good deals • nice smiles

Green Festival
Sept 18-19 • Washington DC

"The sun, with all those planets revolving around it and dependent on it, can still ripen a bunch of grapes as if it had nothing else in the universe to do."

Galileo Galilei

Copyright © 1987-2004 Home Power, Inc. All rights reserved.

NOTE: You must have the [FREE Adobe Acrobat Reader](#) version 4 or above installed to view our PDF files. Have [questions or problems](#) with our PDF files?



2,147,736 hits since 8/5/02.
2150 hits today (08/31/04).

Stirling engine

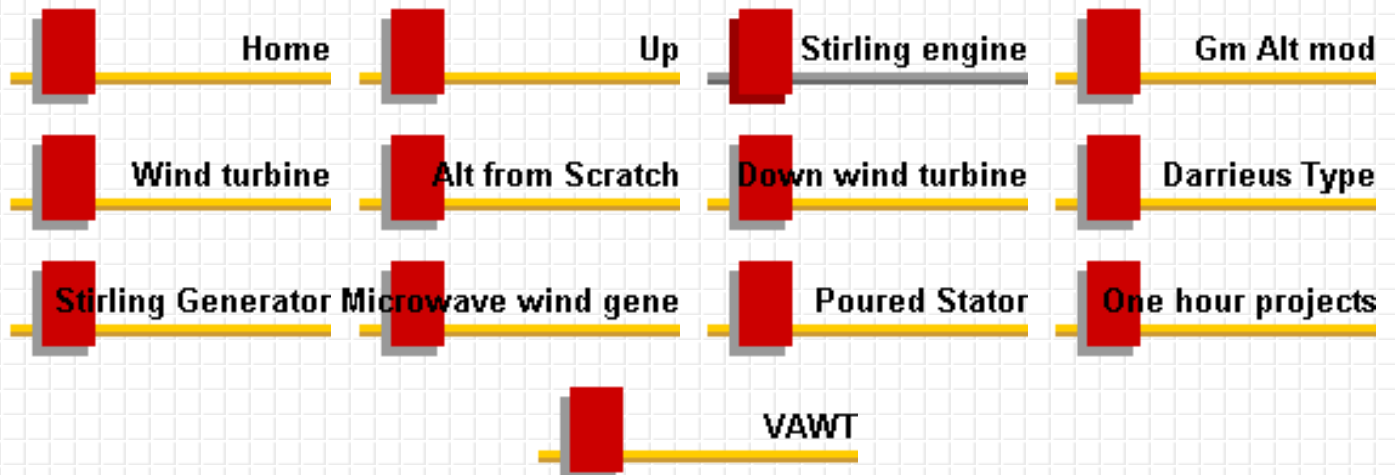

Stirling engine models....

Just a few of my spare time projects... I enjoy building stirling engine models.
Here are a few that I've done.

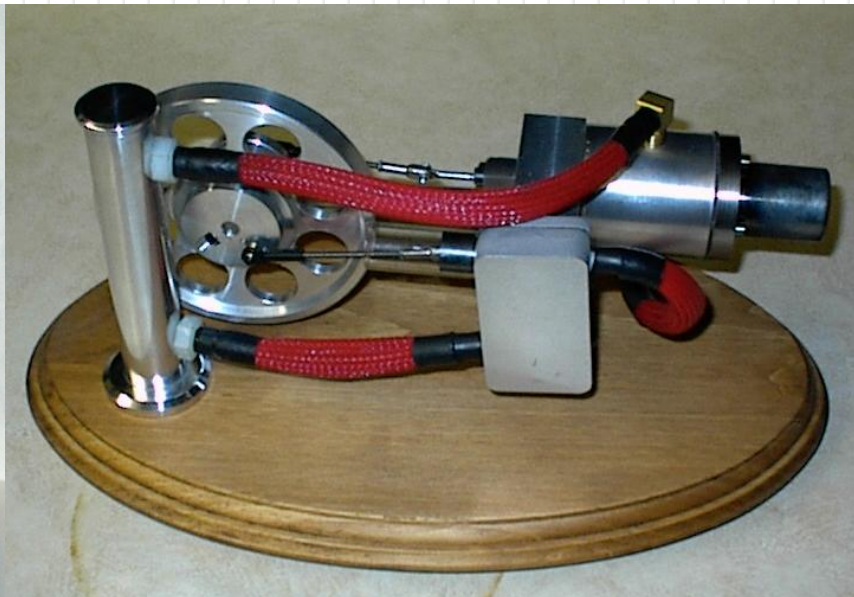
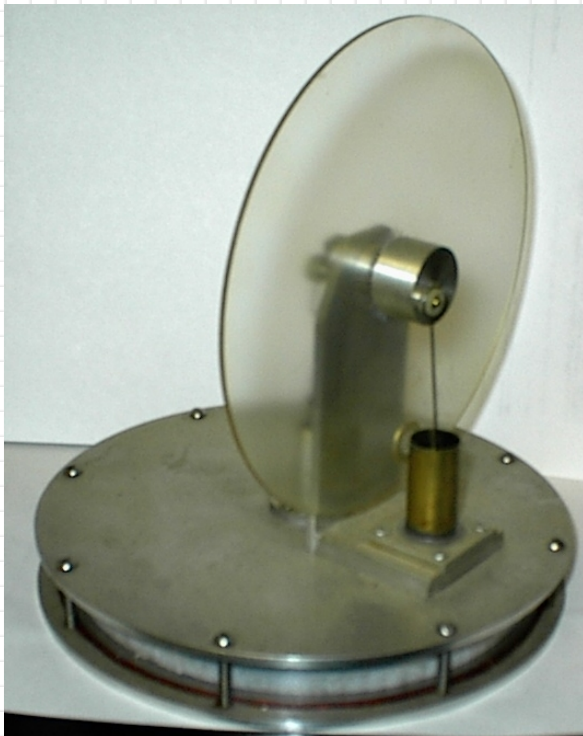

The one on the left is a low temperature stirling. It will run on warm water or even ice. The one on the right is a water cooled stirling with its own water pump.



This one is built entirely from tincans and scrap wood. This unit is quite powerful for what its made from. If you would like to build this model I sell plans for it. The plans are only \$7.50 plus shipping (add 1.25 for shipping). Simple tools and a steady hand can put this together in about 2 to 3 days. The displacer chamber for example is built out of a hair spray can and a coors beer can for the displacer. A coffee can for the burner and an upside down can at the top for ice or water to help cool it. The rest is quite obvious... standard 3/4" plywood. It will run about 500 rpm and actually could run a small generator, such as a "hankscraft" type PM motor to power a small light or charge a couple of D cell type nicads. If your interested in the plans for this little beast send me an [email](#). **Now you can purchase them online using paypal service. Simply click on the "Buy Now" button above.** When payment is recieved I will send you an email with the download site and password to unzip the file. The File is in MS Word format. Approximately 1.8 Mb

Wind turbine

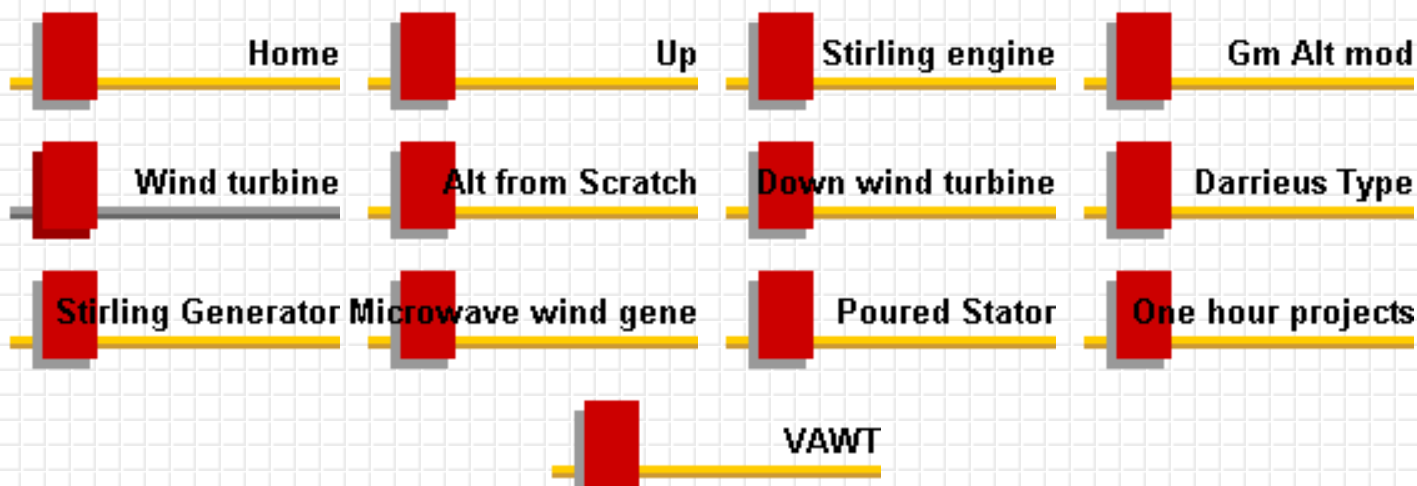

This is the test bed for some of the turbine blades I make. This was actually a modified version from "Wind power Workshop" by Hugh Piggott. If you don't have this book, I would highly recommend it to anyone interested in Wind power.



The only thing that was modified from his original version is the bearing head. Mine had to use the modified Gm alternator instead of the "brake drum" alternator. The above picture shows most of it together with the blades in place sandwiched between two machined aluminum hub sections. Notice the chain drive sprocket behind the hub?

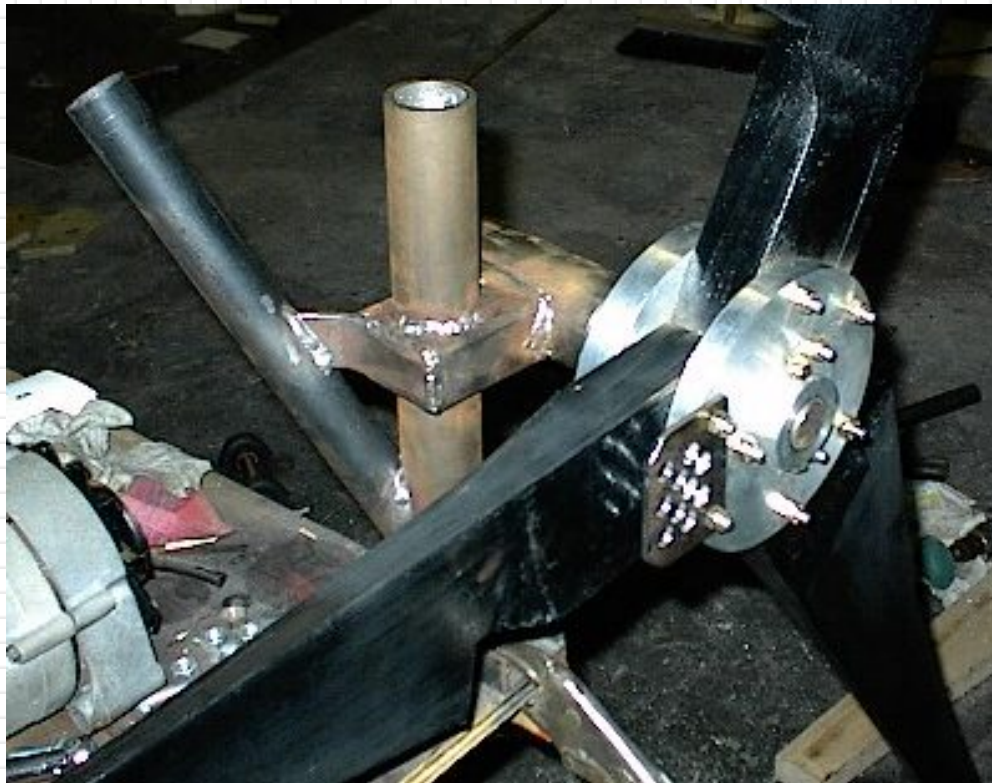
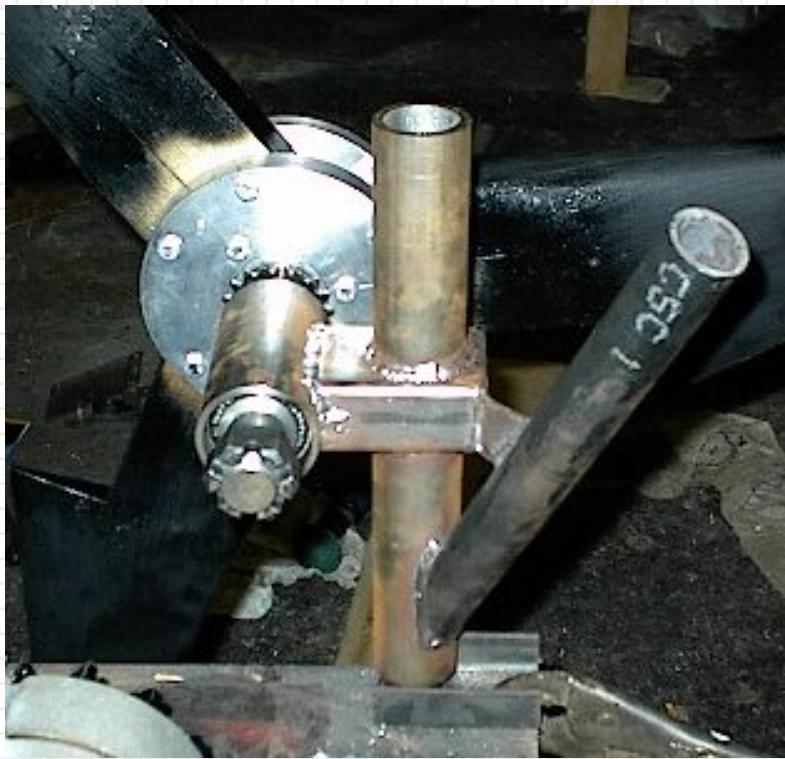

A couple more shots of it at different angles. This one you can see the balancing weight on the hub as well.



All bead blasted and ready for paint. Here you can see the alternator lower mount at the bottom and the upper mount in the left hand picture. The main shaft head was machined to accept a standard 1" tapered roller bearings for a small trailer. Quite inexpensive. I have less than 90.00 invested into this turbine. It will produce 400 watts at a wind speed of 28mph. That comes out to around 22 cents a watt.

I'll try to get some photo's of the completed unit when I get some time. This turned out to be a fairly quiet running unit and it does a very nice job. I actually thought it

would be much noisier with the chain drive system. The alternator I used was the "third" of the series of testing.

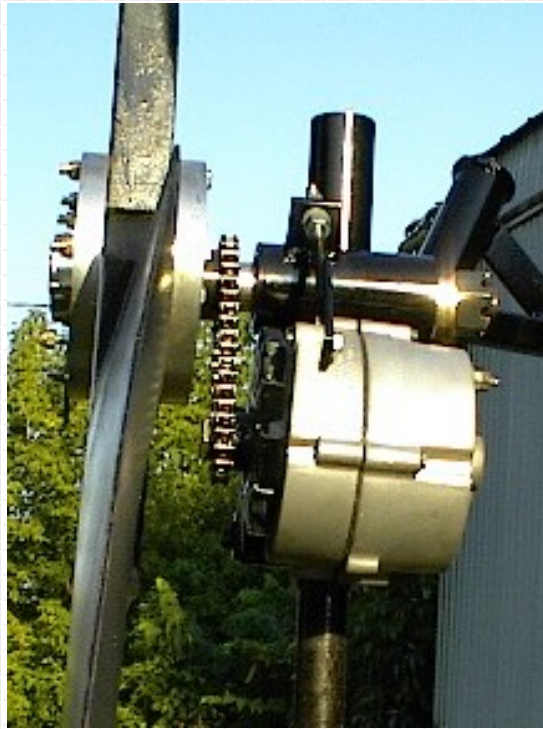

The above shots were taken just after it was assembled for the first time after all the painting (boring stuff) and misc stuff were completed.

Down wind turbine

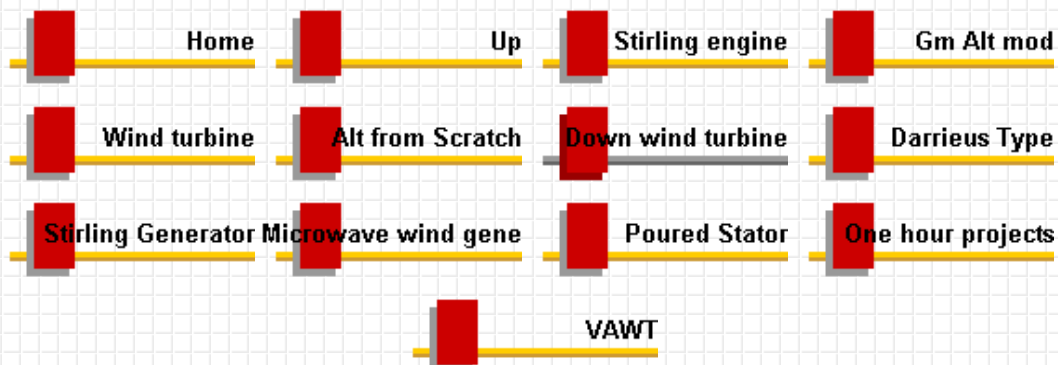

This is the second of a group of downwind turbines that I have been testing. This one has the identical alternator that the smaller one has with the exception of the magnets used.



The first pic shows the magnet used before being cut into 8 equal sections. The next shows the stator after slotting and the magnetic disc.

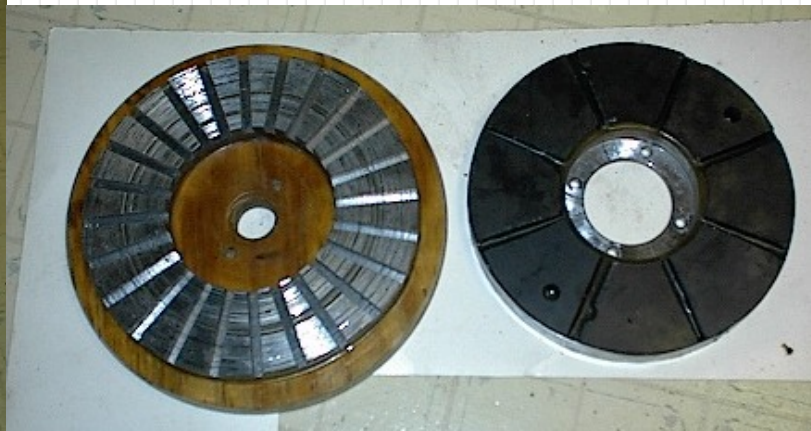

The next couple show the prop mount, bearing hub, and magnetic disc apart as well as assembled.

There is a steel band around the magnetic disc to reduce the chances of the assembly coming apart at higher rpm. The magnets were mounted to a 8 inch x 1/4" thick steel disc and the band was welded to the edge. Magnets were epoxied into place then the gaps were filled with fiberglass resin.

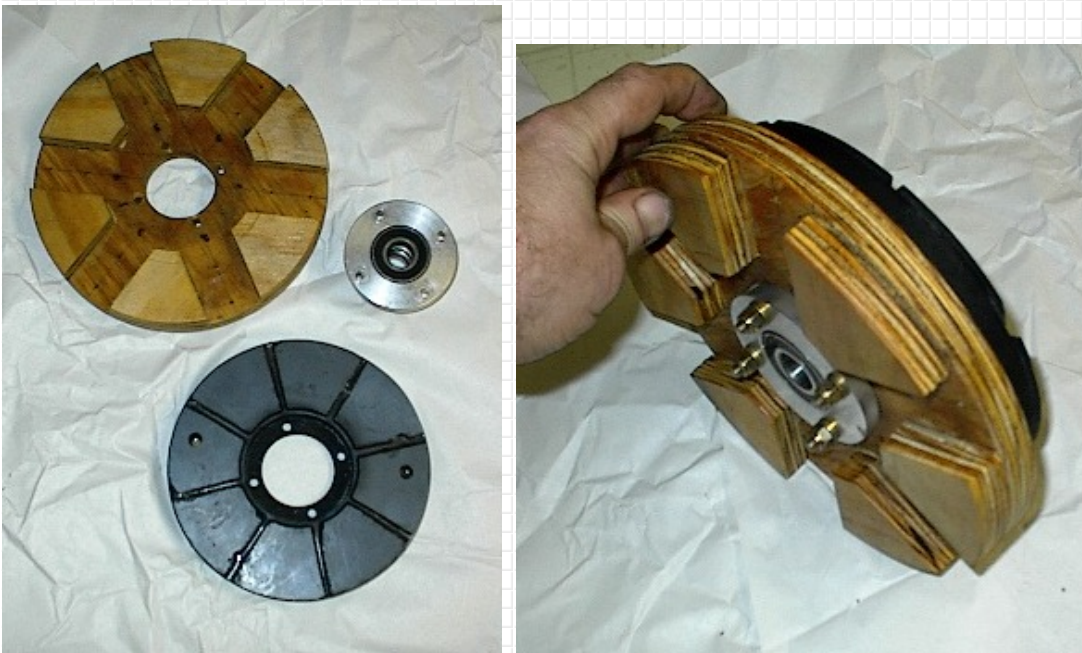

The 8 inch magnetic disc is mounted to a 9 1/4" x 3/4" plywood disc. The bearing hub and magnetic disc "sandwich" the plywood in place. I used 4- 1/4" aircraft bolts (AN hardware) along with the aircraft type nyloc nuts for safety reasons. Whether they are aircraft quality or not, I would recommend using the nyloc type nuts on any spinning assembly. The only difference between a standard grade 5 bolt and an aircraft bolt is the aircraft bolts have been X-rayed for fractures, bubbles etc, and are guaranteed to be solid. Another note, on an aircraft these would also be safety wired into place leaving very little possibility of the assembly coming apart.

The below picture shows it assembled (first time up) in a jig in front of a large fan for initial testing.



This one initially had a variable airgap system, star/delta switching, and full furling abilities. After the initial tests I'm undecided at this point if the variable air gap is worth the extra time and work. With the system working it will start spinning in about a 5 mph wind and start charging at around 7. With the system disabled it won't start spinning until around 10mph but instantly starts charging and once started will continue charging down to 7mph. So unless the wind drops below 5mph it will continue spinning.... I don't believe, at least for this unit, the variable air gap has done anything of any significance.

The star/delta switch originally worked off the same system as the variable air gap and has had some problems in the switching stages causing a "chatter". Since I am utilizing the "torque" from the stator to activate it, the moment it switches it drops the torque load causing a back and forth movement until it stabilizes. This will be replaced with an electronic controller and retested. I will post results on this as it progresses.

Here are some other shots of the blades and the completed rotor assembly....



They always look nicer with paint... although the finishing process isn't one of my favorite parts of the project it has to be done.... I placed 6 inch strips of leading edge tape on each blade. This helps to protect the edge when its spinning fast in the rain. The first few turbines I built didn't have this protection and the blades showed major erosion after about a year or so. Since then I've been using the leading edge tape you can get from ultralight aircraft suppliers with little to no problems with erosion.

I balanced this one a little different than I've done in the past. I usually make a weight plate to bolt on the light side which has worked well in the past. This one, since the blades are small, I weighed each blade on a postal scale and matched all the other blades using small lead weights inset into the wood and epoxied in. Initial run up seems good but I've only had it to 800 rpm so far....that's running in a 12.5 mph wind with no load on it.... we'll see...

Below shows the basic's of the stator mount, spindle and furling system. All the components of the furling system are not mounted in this shot but the basic gravity system is shown. Very similar to an automotive front spindle assembly... (Look like a volvo?.....not quite, its all hand

made - with tools of course). I wouldn't think it would take much to modify an automotive spindle to do the same job. If it can be done, the Dan's at www.otherpower.com will do it!!!

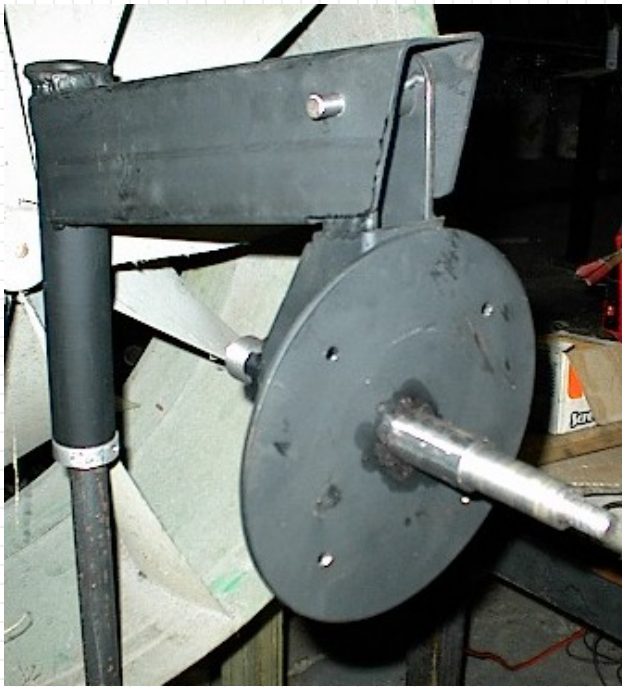

Below is a shot of the stator installed and the wiring almost completed.

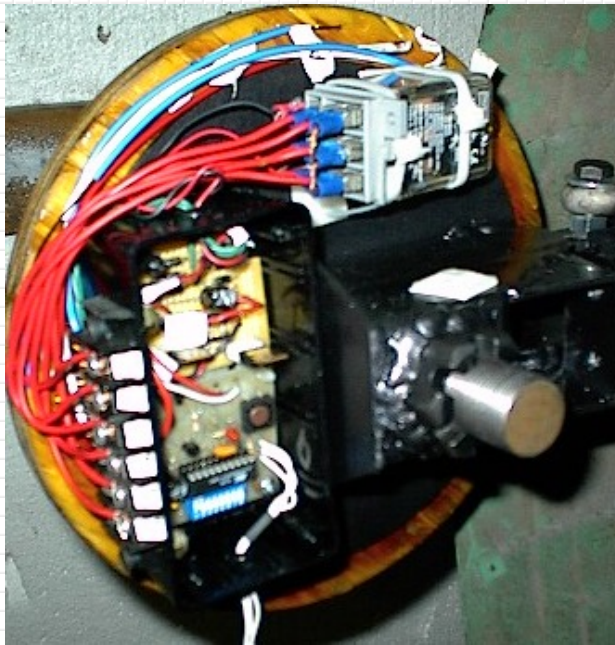

I didn't really design it for all the electronics to fit behind the cover so it became quite a challenge to get everything to fit. This is a star/delta controller powered from the alternator itself to drive the relay. Bench testing proved quite successful. The controller unit was designed and built by Robert Nance Dee at

Design Specialties (<http://www.dsgnspec.com>) and its quite unique and great for experimenting with different alternator designs. The controller can be adjusted from 300 rpm to 1050 rpm for switching from star to delta and also a delay before it switches from .5 sec to 7 sec. This allows for the winds to be more constant before actually switching. Without the delay, in certain winds, it would constantly be switching back and forth as the rpm changed.

The unit has since been completed and placed on the tower for some real life tests. Of course as soon as you put up a new unit mother nature has to play games with you and there has been little to no wind for a couple days now. But I did get some interesting results in the lower winds.

The chart below shows the output that I've been able to collect so far....

Calculated	Total	Actual	Efficiency	RPM	Wind	Amps	Tip Speed	TSR
watts	watts	watts	%		Speed			
18	40	0	0	256	9	starts chr	33	3.6
30	85	19	22	317	11.6	1.5	42	3.6
48	107	38	35	385	12.5	3	51	4
72	138	50.8	36	430	13.6	4	57	4.1
96	208	76.2	36	512	15.6	6	68	4.3
113	294	101	35	612	17.5	8	81	4.6
180	668	195	29	823	23	15	108	4.7
300	1799	320	17	1090	32	25	144	4.5

The first thing I noticed that was outstanding from the upwind versions was the slower pivot when adjusting for variations in the wind direction. It seems to correct itself at a very even pace which would lead to less stress on the blades as well as the bearings. The second characteristic that stood out was the way the rotor speed changed. The rotor actually came out fairly heavy with the steel disc, magnets, blades etc. and it seems to pick up rpm at a steady pace and also when the wind drops off it slows down much more slowly. Like a flywheel absorbing energy and bleeding it off as the power was relieved. The blades were designed to run at a TSR of 4 and I noticed it running below that in lower winds and above the rated mark in the moderate winds. There seems to be more load than the blades are making in power at the lower range but the blades are outperforming the alternator in the upper range. This could be caused by the core saturating to quickly or the ceramic magnets aren't saturating the coils properly as speed increases.... not a good thing.

As I get more information on the unit I will post it.... It seems to perform ok but a bit lower than I calculated and expected.....

On the pole and running.....



Darrieus Type

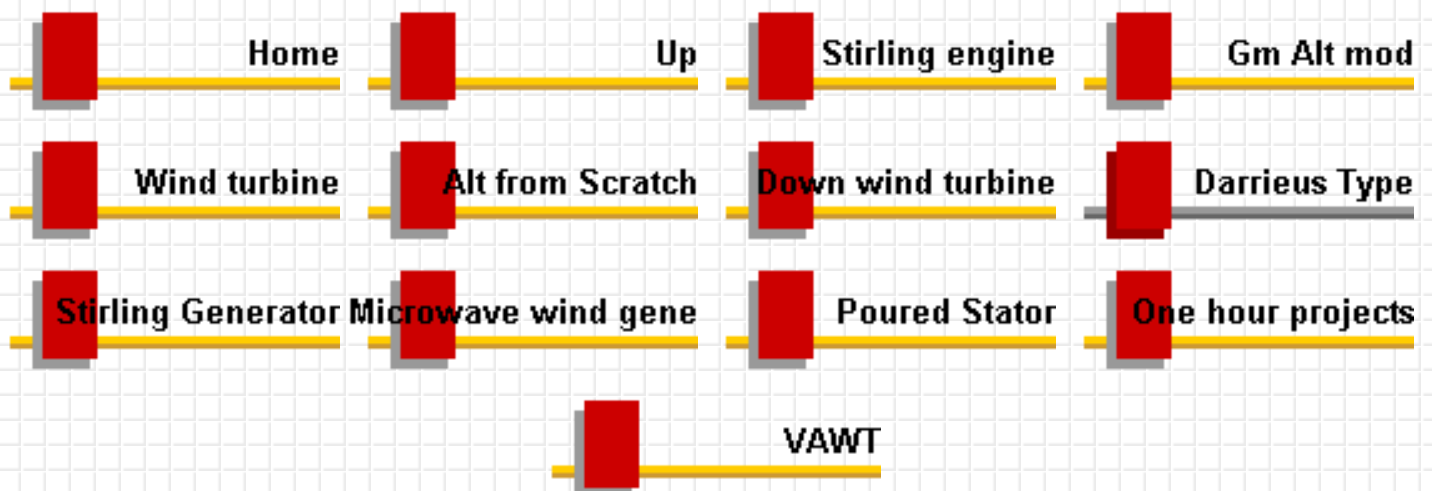

This was a fun wind project and I learned a lot about these from researching and building this. This is a Darrieus type wind turbine. Probably more in the cycloturbine class. Most of the Darrieus type turbines don't start themselves and need an external source to start the spin. Actually it should be stated that they don't start themselves reliably because in certain circumstances they will start and run by themselves. This project incorporates a tail driven cam that angles the blades in and out of the wind and probably more of a drag type than lift type and **will** start by itself - reliably. As soon as the tail is pointed to the wind... its running! The pictures below show the small unit I built as an experiment into the wonders of these fascinating machines...





This unit was approximately 2 ft tall (blades) and 2 ft in diameter and would spin around 450 rpm's in a 20 mph wind. I've had several different small pm motors attached to it for testing and the best one was an electric "weed eater" motor which would produce about 50 watts in a 25mph wind. I was quite impressed for its size and materials it was made from. It was up for about a year and had survived a 70 mph storm. I really wish I had a tach on it that day, the only visual on it was the tail and center. It did however suffer a main bushing seizure the very next day.... A little grease and it was back up and running.

The next one soon to come is a 3 ft by 3ft unit with the same tail driven cam design but incorporates lift on the upwind blade.....

Below are some pictures of the new unit.... First two show the mounting and hinges as well as the push/pull rod for the tail driven cam... I made provisions for 2 setting for the wing control rods. The farther out the less movement and the closer in the more movement. Close in there is alot of torque but less rpm and farther out the rpm goes up and the torque goes down.... interesting although I believe the power output is about the same. It runs just a bit faster than the wind and calculated a TSR of about 1.5 to around 3 with the movement lessened.



The next one shows the completed unit on a 6 ft ladder.... and it had a 6 mph breeze at the time so it was difficult timing the shot....



I've taken this unit out in a 12mph wind and as soon as the tail points into the wind its off and running. Doing a performance test using the old "finger dyno" on the shaft I could not stop it from turning... as hard as I was squeezing it simply would not stop... I was impressed... and the dyno was measuring some extreme heat!! I decided not to go any further with this one and a new project springs to life.... A 4 ft dia x 6 ft tall blades... possibly a 3 bladed unit with the cam design...

We'll see.....

Stirling Generator

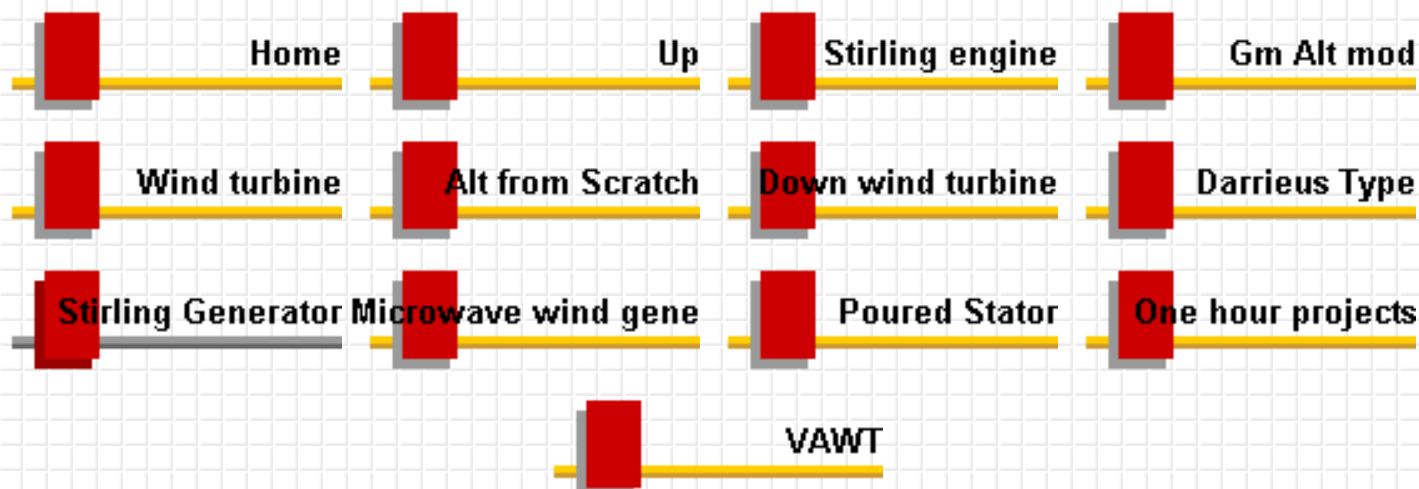

Stirling engine-generator

This was a fun project, although not finished completely. It has a 1 inch bore and a 3/4" stroke. The flywheel/magnetic rotor is just under 6 inches, stands 14 inches tall and 11 inches wide. Has a hand wound 3 phase alternator with a homemade rectifier. Using a candle as the heat source will make about 4.5 Volts and enough power to light 10 ultrabright LED's or a string of 36 3volt Christmas lights. Using an alcohol burner will produce over 8.5 volts and will power as many as 75 ultrabright LED's. Using a propane torch it will charge a 12 volt battery. The picture shows it running on alcohol (small homemade burner) making over 8 volts open voltage....



I've charged ni-cad batteries with it while experimenting. It doesn't take a massive amount of heat to run it as it will run on boiling water. About 130 degree difference. It runs fairly smooth up to around 800 rpm and is very quiet. I've had it running at over 1100 rpm but it doesn't really like that. The clearances are pretty close and you can hear the displacer piston making a ticking noise at that speed. Below are other angles of the motor/generator.....

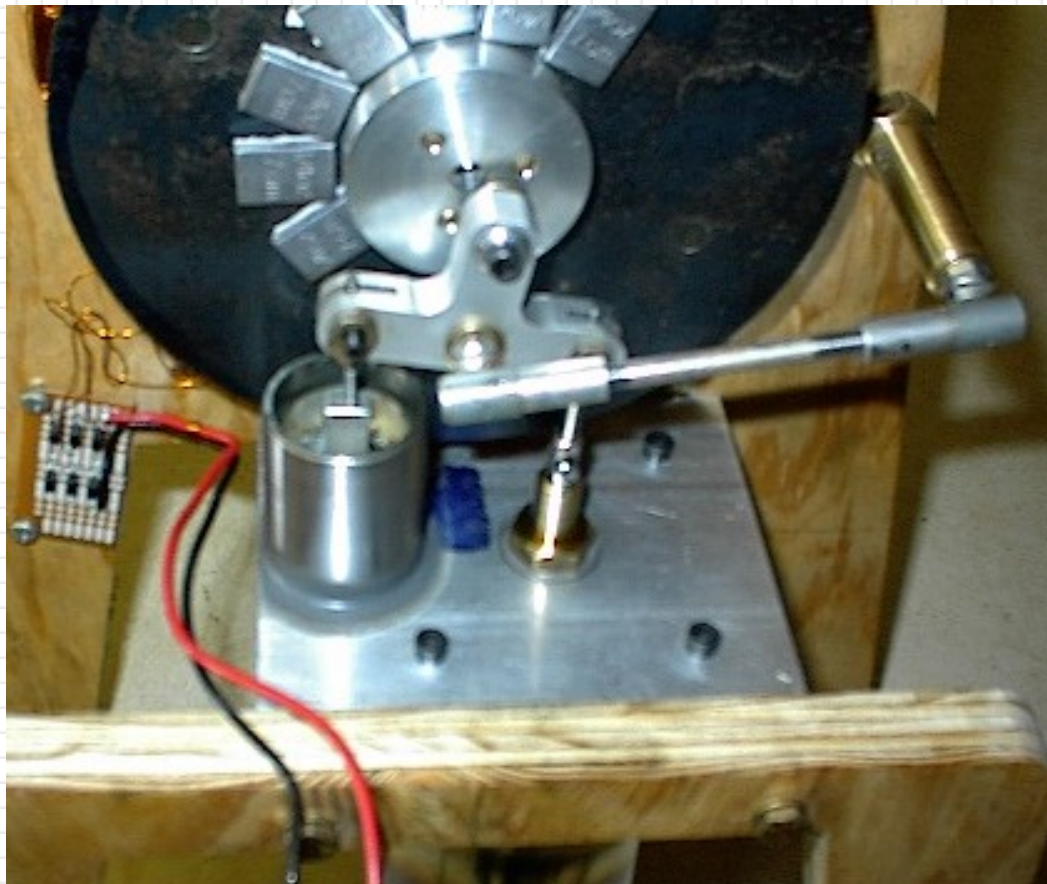

This is a "Ross Yoke" set up where both the displacer piston and power piston share a common crank throw and offsets the two pistons by approx 90 degrees....



Above is the "hot end" made from a stainless steel cup and aluminum housing....



Above is another angle of the stabilizer rod to the yoke....



Opposite side, you can see the lead weights to offset the weight of the pistons for balancing. Not perfect but is fairly close up to about 800 rpm where it will start vibrating a bit..... I'm in the process of building one about the same size dimensionally but with a 2 inch bore and 3/4 inch stroke.... more on that one later....

Microwave wind generator

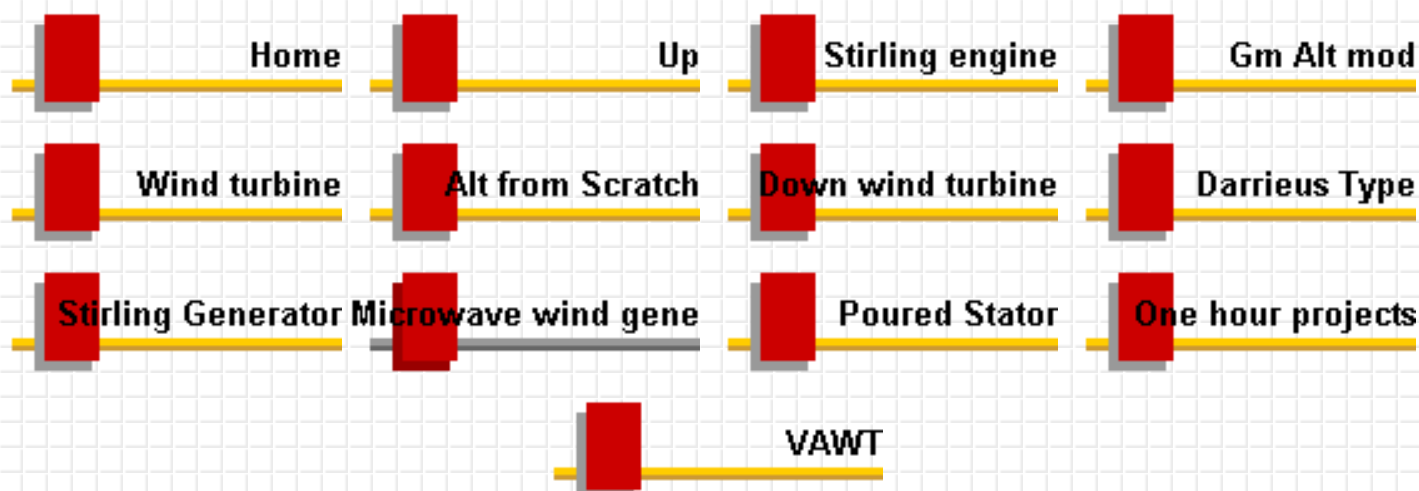

This is a lesson on recycling. Everything here was built from scrap microwave ovens with the exception of the bearings and pivot mount also the plywood. Microwave ovens have an abundant source for the materials used in making an alternator and the rest of the components of an actual working wind generator. They contain large 2 1/4" round magnets (2 in each unit - in the magnetron) plenty of sheet metal (cases) and even useful wire in the transformer. You could actually use the transformer metal as the stator laminates.

This will probably dry up my source for microwaves but you can call any appliance repair and find many microwaves free for the asking. I called one shop just to inquire about the possibility of getting a couple, they told me they had a few. I went over there and he directed me to the warehouse where there was about 40 of them. He looked at me, smiled and said if you take one you have to take them all.... I really think he was kidding but 3 trips later they were all in my shop. I tore them down and started saving all the little parts that could prove to be useful for other projects... screws, rubber feet, micro switches, fans, transformers, etc... (I don't throw nothing away) and about 80 magnets.

I started out by cutting an 10" disc out of plywood, cut strips of steel out of the case to make the laminates. Coiled the strips to form the stator and epoxied them to the board. I used strapping tape on all the metal strips which served two purposes, One to help hold the whole thing together and Two to isolate them from each other thus reducing eddy currents. I machined 24 slots to hold the wire and started the winding process.

Below are the beginning shots of the process...



There is 60 feet of 3/4" steel in this stator. The stator is 8" in diameter and 2" wide. Below show the winding in process...

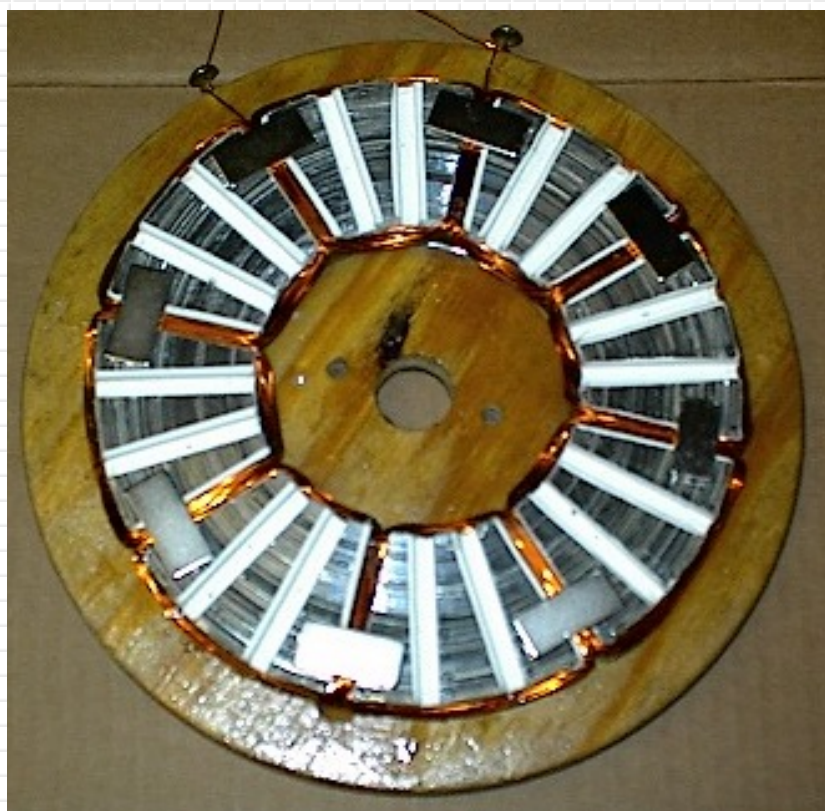



The white inserts are made out of old milk cartons to isolate the wires from the steel. Each picture shows each of the 3 phases being placed into the slots. This was wound on the stator itself and each phase is wound as if it were a single phase unit. There are 36 wires in each slot making up 18 turns per coil. And yes I know I blew my rule number one... Keep it simple. The slots really are unnecessary but do help to bring the power and efficiency up and since this is a small turbine (28" diameter) I needed all the efficiency I could get.

Initial testing of the alternator came out quite promising. At 600 rpm the open voltage was 29.6 volts. My goal here is to make a very small turbine that will produce 150 watts in a 30

mph wind. After many doodles and calculations, 3 or 4 pads of paper later this is what I've come up with. I'm not going to show the turbine in great detail and all the alternator functions will be left out as there is a patent pending on this unit, although won't be manufactured out of microwave ovens in the end.

Below is the preliminary installation of the stator on the pivot head of the turbine. You can see the coils are shrouded and sealed...

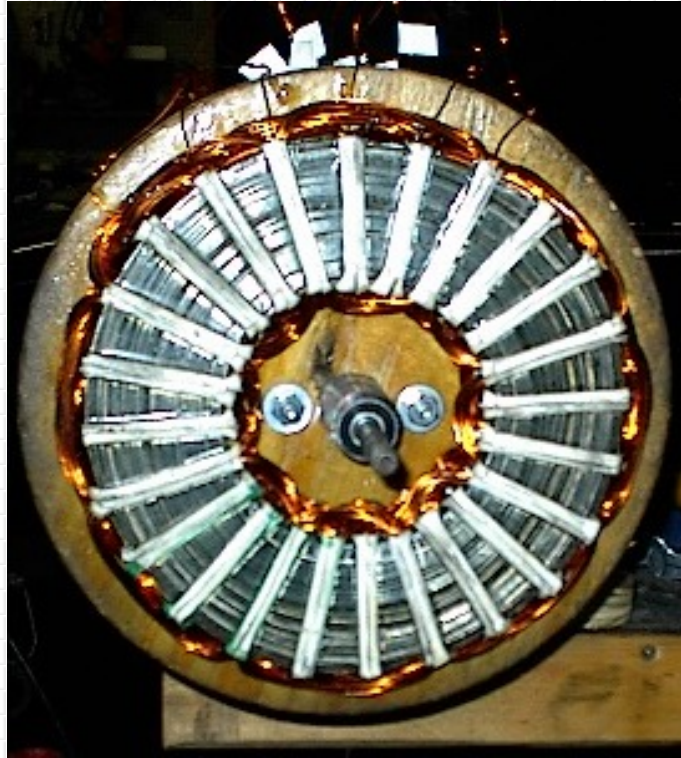

This next picture shows the microwave magnets taken from the "magnetron" and setting on an 8" steel disc. Also shows the octagon plywood rotor (14") and the blades mounted on the rotor assembly. Using steel blades makes the rotor quite heavy and would be extremely susceptible to high winds and over speeding. This is simply a test unit and will not be installed permanently...



I've calculated the stress point to be somewhere around 1100 to 1200 rpm before the wood structure would come apart, this being winds at around 50mph. This could be changed by adding longer mounting tabs on the blades and installing 3/16" bolts instead of the sheet screws. The blades are 7" tall and 8 of them are installed on the plywood. Each blade is set at an angle of 10 degrees. The metal came from a large microwave case and was bead blasted and is now ready for paint. The plywood will be coated in poly resin (fiberglass resin) to seal and waterproof the assembly, the magnets will be resin'd in also.

After all was assembled, unfinished and semi balanced, testing went fairly well. The performance of the "microwave" turbine was below my projected output but not bad for its size. The maximum output achieved was 90 watts in a 30mph wind. It performed well in lower winds giving 22 watts in a 14mph wind. No powerhouse by any means but for its size (28" - not much bigger than a basic box fan) it did quite well.

All in all a good lesson in scavenging and making due with what is available. The entire project cost about 8 bucks not including any labor. Comes out to about 8 cents a watt....

I've dismantled this unit since and have added a different rotor with 6 blades. Initial tests on the new one are providing much better results but still about 20watts under my goal here. Initial testing showed an overall efficiency of 23%. The eight bladed (steel blade) was giving me about 11% (not impressive by any means). I'll post some images of the new rotor shortly.....

The blades are carved from standard 2x4 board scraps and the center was brought down from the 14" octagon to a 10" circle allowing for more blade area....

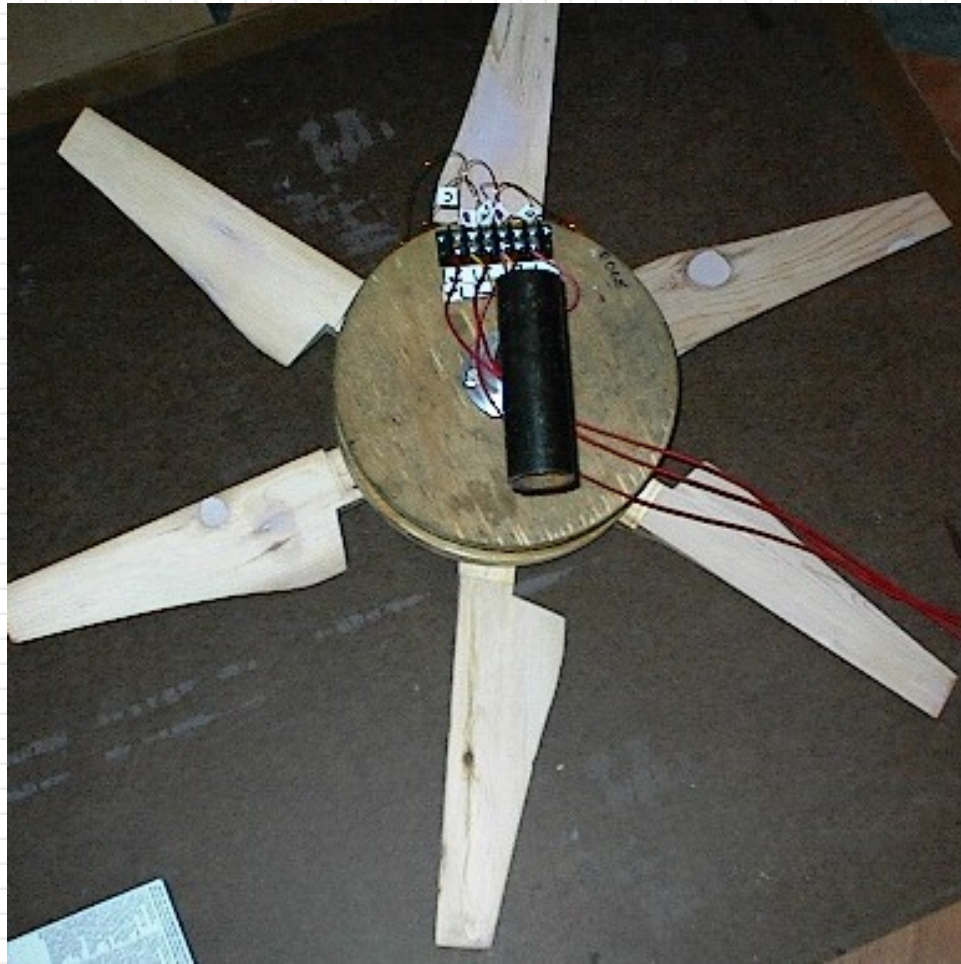

Still only 30" in diameter, testing was done in a 14 mph wind and the results are coming out good. Unloaded the blades run around 720 rpm and with a load 570 rpm. Using a slightly dead battery with a 50 watt load its making 11.75 volts at 1.7 amps (total of 19.9 watts). The total available watts for that area of blade is 77.78 so that makes the overall efficiency of around 25%. It will make about 170 watts in a 30mph wind and the efficiency drops to around 22%. Still just over 13 amps at 12.7 volts... not bad for a tiny turbine...

Still testing various configurations and shields.....

Poured Stator

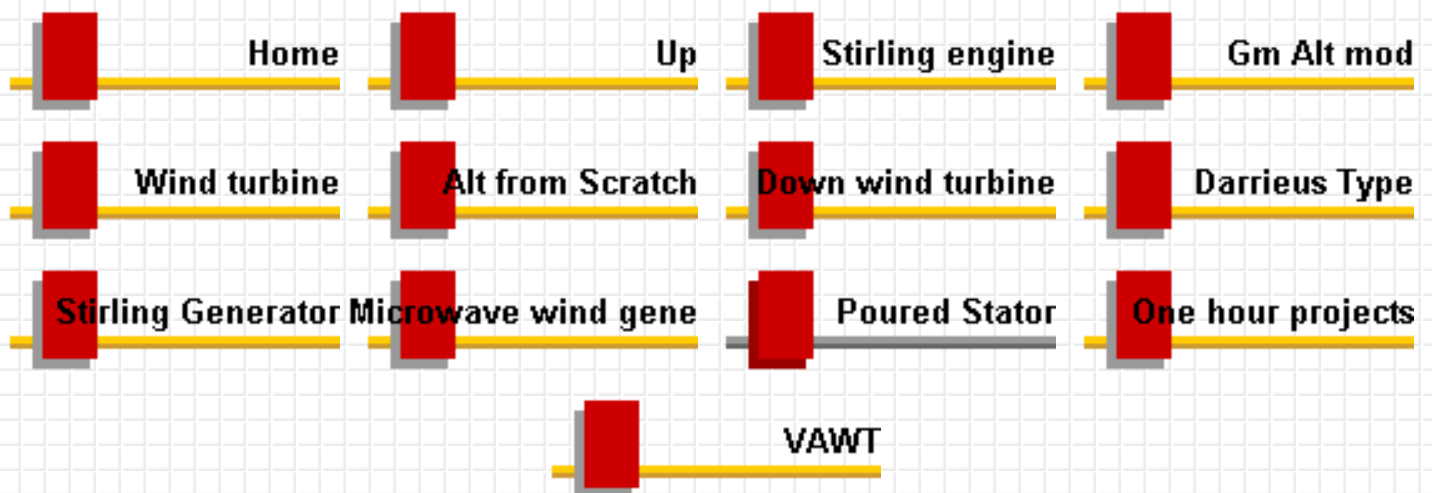

This is the beginning test of a full size poured stator. I've done some small ones in the past for stirling engine projects but never really followed up on them. Bob Gayle inspired me to follow up on it to see if would really perform equally as well as a steel slotted stator. Initial tests are showing some losses over the steel core but with the ease of fabricating it may well be worth the efficiency loss over labor involved with the steel slotted cores. Here is a picture of the poured core stator



To keep it simple I used fiberglass resin as the binder and mixed in the iron powder.

It was basically a paste when mixed. There is about 5 pounds of iron powder in this stator. Actually, very little resin was needed to saturate all the particles, guessing at around 6 oz. The slots are .46 deep and .3 wide for 14 turns of #15 wire through 36 slots. There will be 12 magnets used on this one. I plan to test the unit with both ceramic 5 magnets and neodymium type. Ceramics are nice in the sense there is little to no cogging effect but I don't expect the cogging of the neo's will be bad enough to hurt performance much.

Below is a picture of the stator completed with all its windings...



The next one shows the stator just as it was being finished with the 3rd phase. Notice the special clamp for getting the last phase in place. Typically the last phase goes in sort of free hand, but, because of the wire size used in this one this is near impossible. The clamp holds snug to the stator core and allows you to wind the wire without having to use all 12 fingers on each hand



The initial tests proved that this unit would work but at less efficiency than the steel strips. I suppose the efficiency loss is a fair trade off for labor. The unit has 12 poles using the 1.5" round neo's. 12 turns per coil and 12 coils per phase (36 coils total), Each phase came in at .3 ohms. #15 wire was used for some fair power. Because of the low turns of wire the rpm per volt came in fairly high which would require a fairly good size prop to drive it. An 8 ft prop designed to run at around a TSR of 8 would work quite nicely making around 650 watts of power in a 28mph wind. Not to bad for a small 8 inch unit.

I plan to do some brief testing with some ceramic magnets cut from the large rings I sell in the "builders corner" of this site under products. I'm sure it won't be a potent as the neo's but something I have to give a shot. This will increase the magnet area considerably so the loss shouldn't be drastic.....

Stay tuned

One hour projects

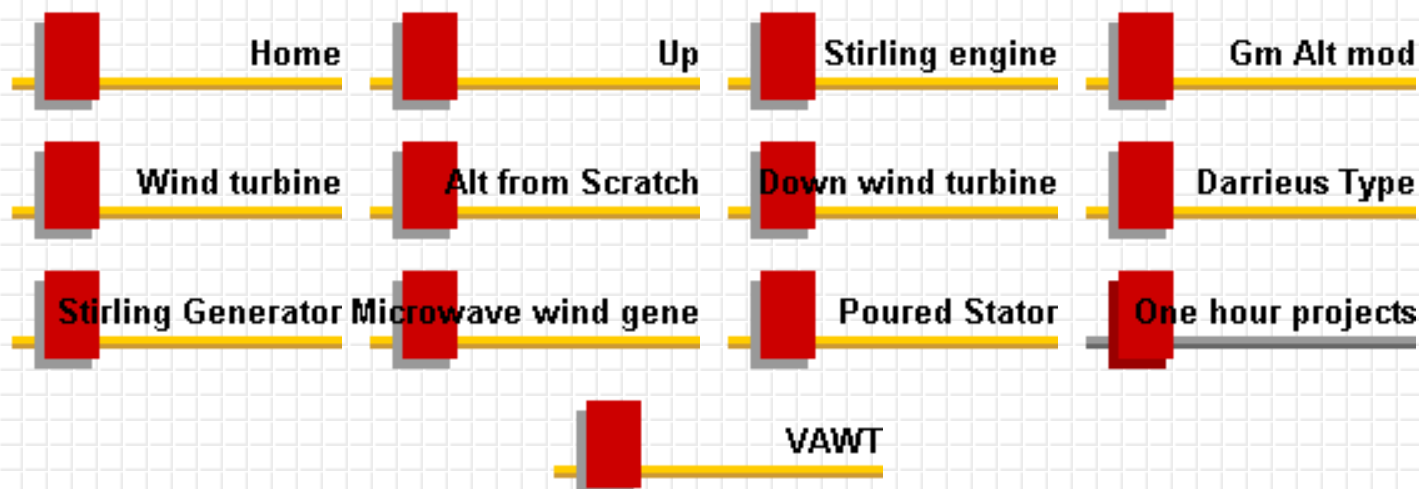

These are projects that basically can be done in about an hour depending on your skill level. Most of what is here can be done with basic hand tools. The first of this series is going to be the wind turbine blade sets. As shown below the frame structure is very basic and is covered in poly fabric used in aircraft construction. The actual name for this procedure is "stits" covering. The fabric is glued into place on the frame work then simply shrunk to fit and it gets extremely tight when completed.



The above blade was built in under 20 minutes using the "tube and wire" method. That's from cutting materials to the blue assembly. It will still need paint but all 3 blades can be built in about an hour. The blade will follow a twist from 2 degrees at the tip down to 23 degrees at the tip. Its set to run at a TSR of around 6 and is a total of 5ft in diameter. Other sets can be made of any length up to around 12 feet using this method and properly calculated components for stress loading. These will withstand winds in excess of 70 mph.

more later

Another quick project for experimenting or fun for the kids to experiment with... These are flat plate turbines. Related to the Savinous but with less detail and considerably easier to build.

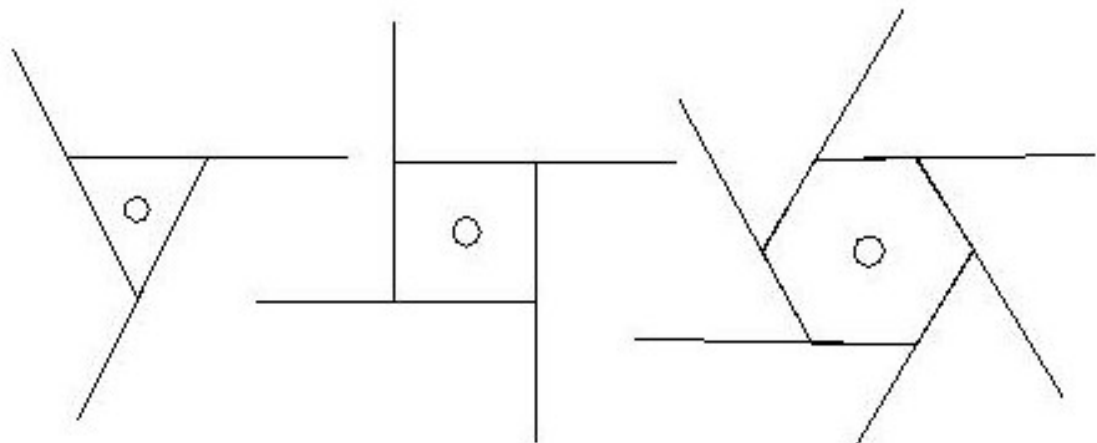

3 variations of the "flat plate windmills"

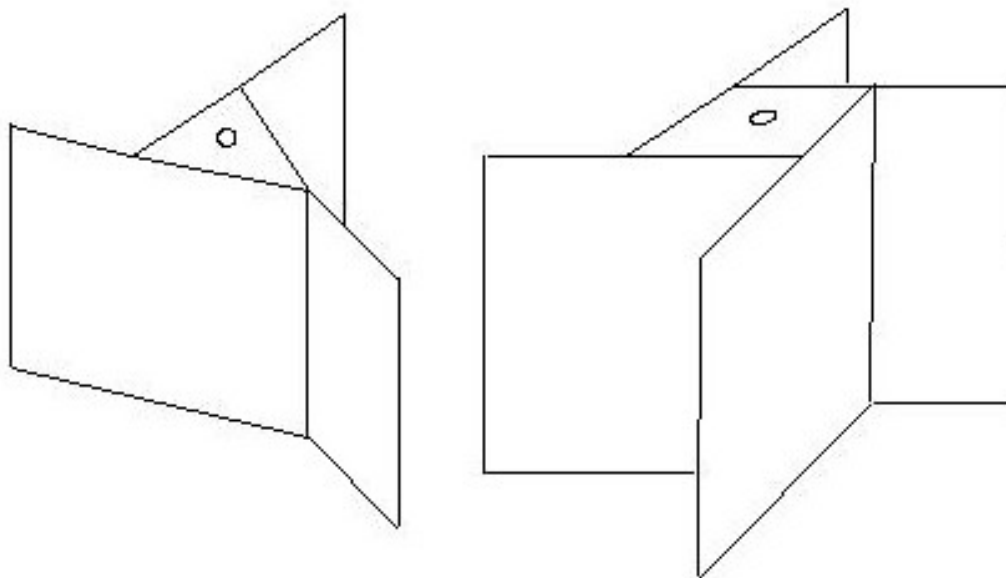

As you can see from the above diagrams, there is basically nothing to them. Their power output is fairly low similar to the Savinous but do a very nice job. They will spin in winds you can hardly feel. Below is a picture of one I built from Lexan and plywood. Its quite small and does no real work but spins all the time.... fun to watch... It would be quite simple to add a small low voltage alternator and power some LED's for driveway lights or what ever. I plan to experiment with that in mind...



The picture is a bit difficult to make out and when its spinning fast is almost invisible.

FORCEFIELD



[Diamagnetic Levitation](#)



[Ferrofluid](#)



[Magnet Science Experiments](#)

[Magnet Science FAQs](#)

What experiments can be done with a magnet, and how do they work? Concise answers to common questions about magnets, their properties, and their practical applications.

[Magnet Uses and Demo Images](#)

Wind Charts

Home

Up

Here are some wind charts to get an idea of how the wind is in your area.

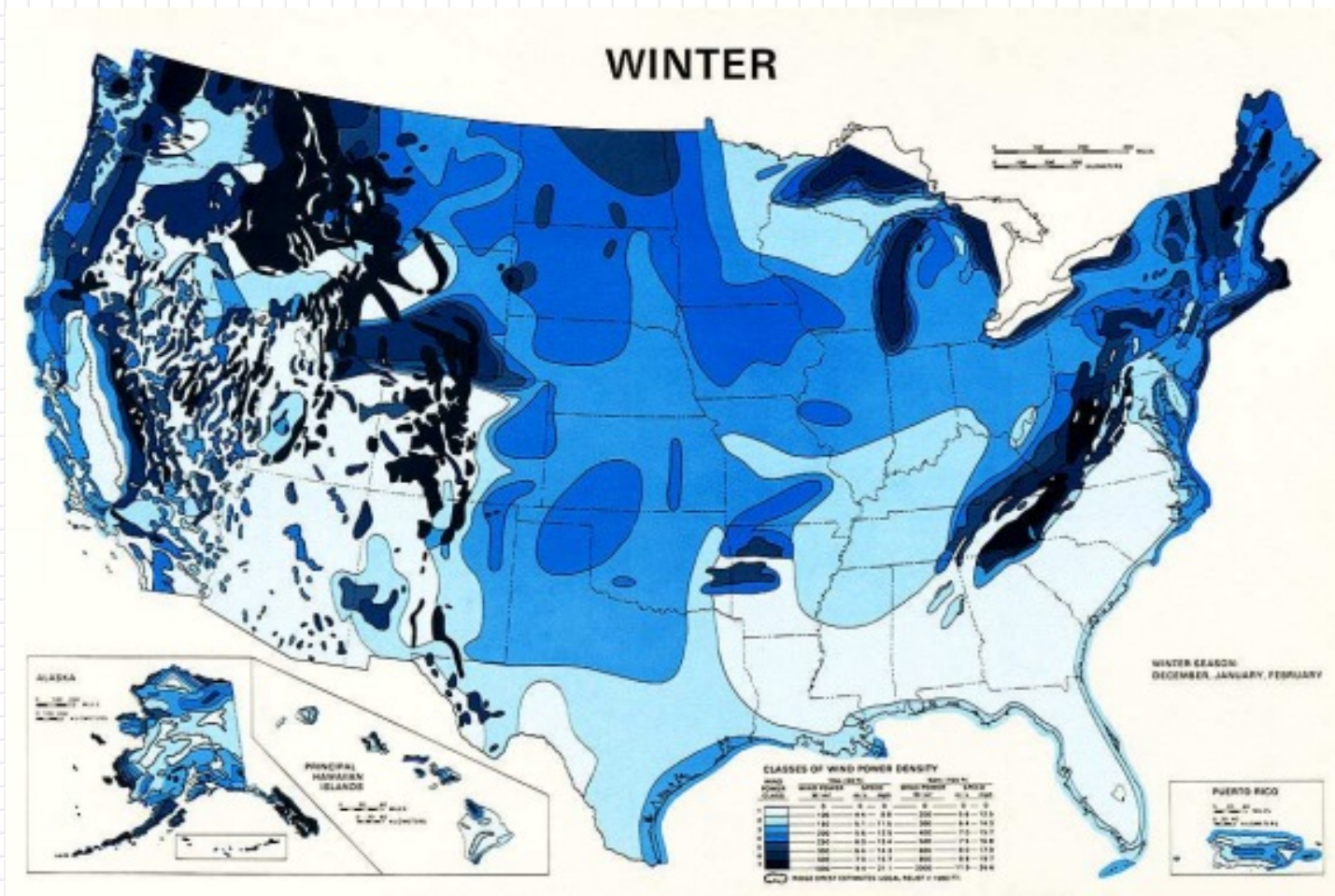
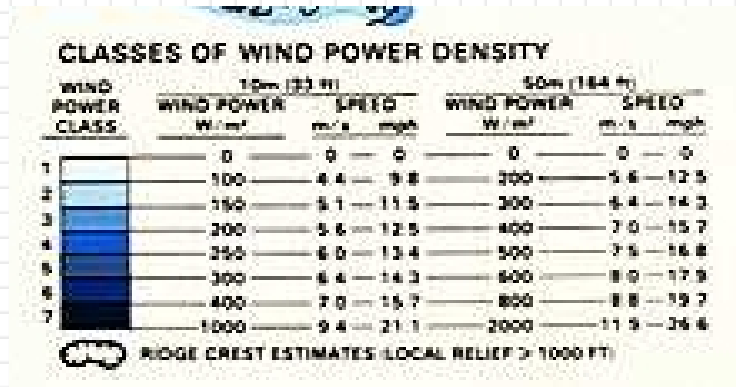

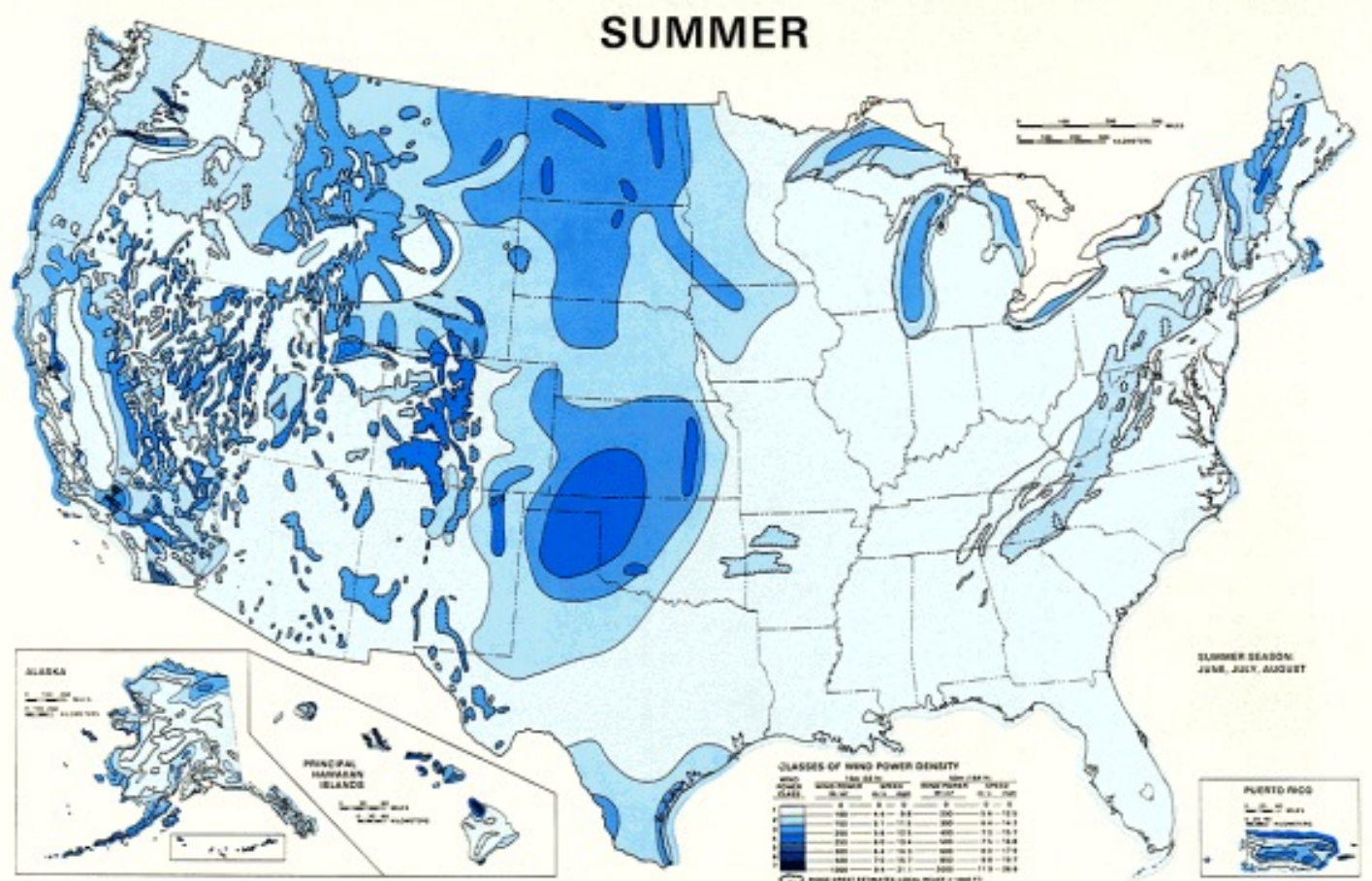
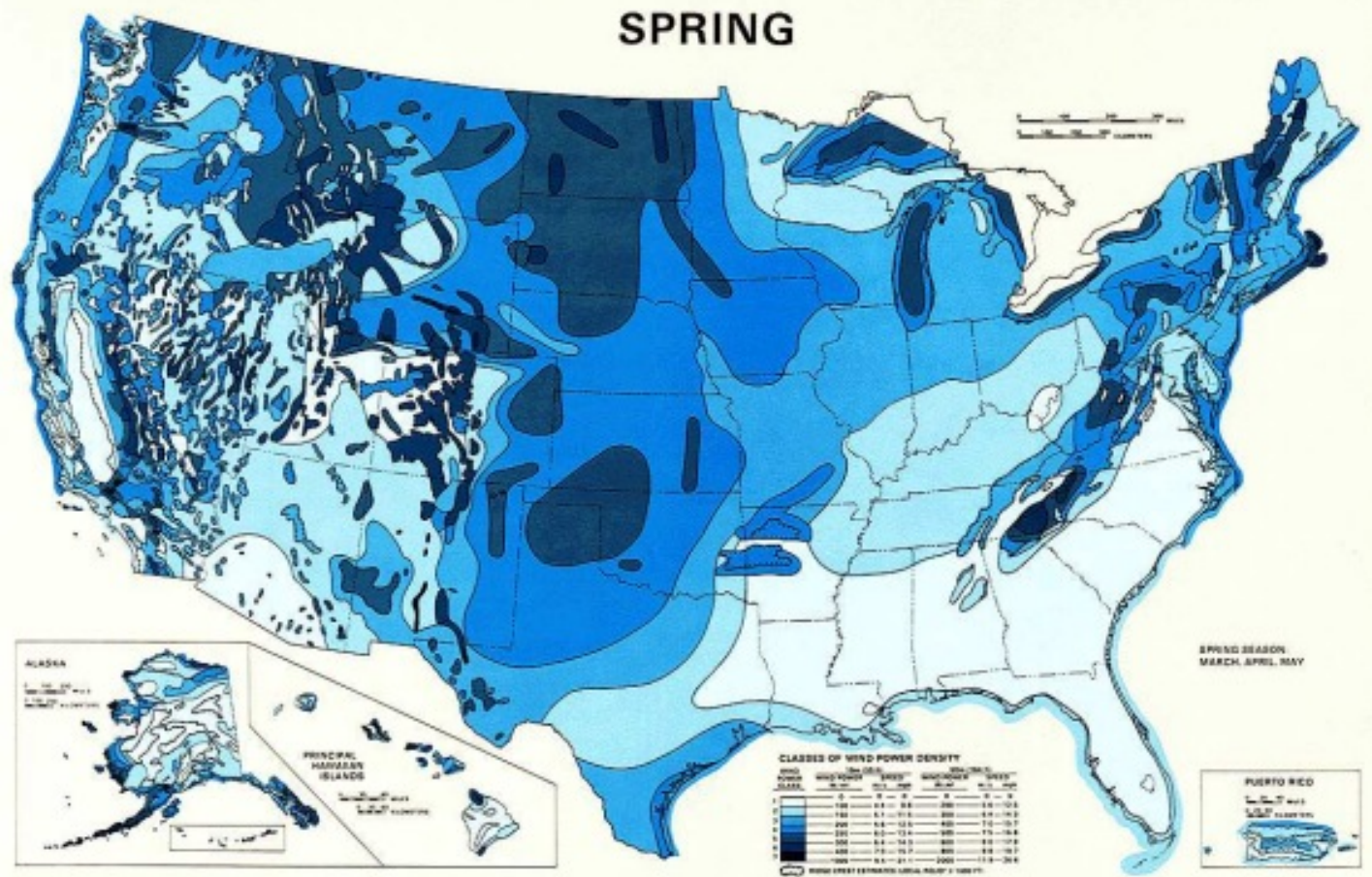

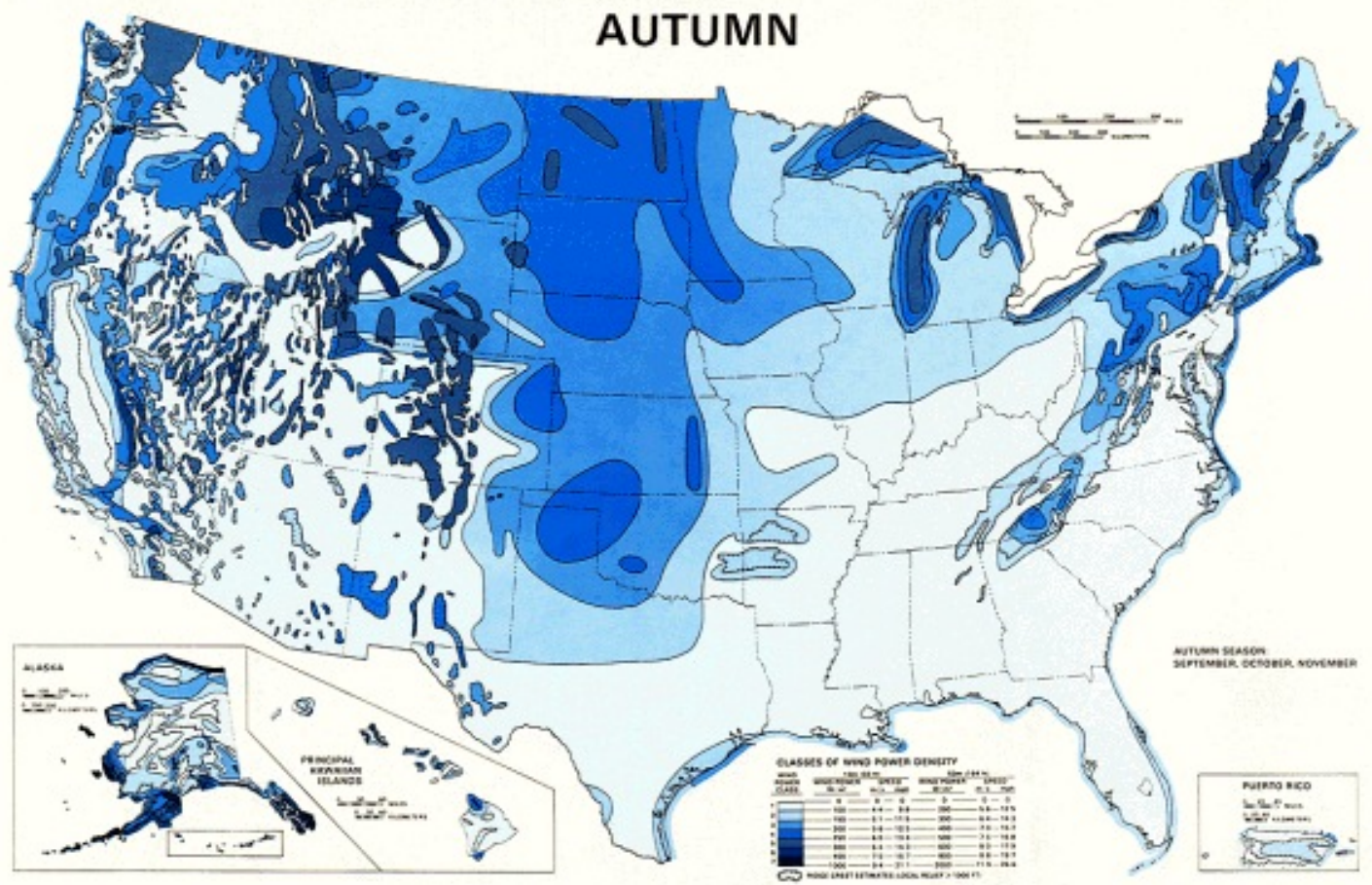

WindStuffNow.com

[Click here to enter](#)

Welcome!

This is my personal web page about Windsor, Ontario and Canada.

As a hobby I build Wind Turbines and research alternative energy resources.

News!! [Dual Rotor Wins Local Science Fair](#)

Attention: Hugh Piggott's Windpower Workshop is now available! This is an indispensable book that will explain in high detail how to build wind generators - [click here to get it!](#)



I dub thee "the flying squirrel"

[Wind Turbine Power!](#)

News: I have just posted a new web page called - the picture gallery of the newest projects- Look under the link of turbine building.



Visit - [Govital Internet Services](#) Visit - [Micrologic Computer](#)

© 2000-2003 www.internetfred.com. All rights reserved ©



Derrick Powell's Web Site
Home



[Documents](#)

[Pictures](#)

[Lists](#)

[Discussions](#)

[Surveys](#)

Derrick's Web Project

[Site News](#)

[Scout Summer Camp](#)

2004

7/25/2004 4:09 PM

by [Derrick Powell](#)

I am the Assistant Scoutmaster of Troop 95. We are going to Summer camp this week. Check out this site when I return to see the pictures of all the fun.

<http://www.powellsoft.com/scoutcamp2004>

Derrick

[Add new announcement](#)



[Site Links](#)

- [Peyton's Web Site](#)
- [Scout Summer Camp 2004](#)
- [Add new link](#)



Web [Images](#) [Groups](#) [News](#) [Froogle](#) [more »](#)

[Advanced Search](#)
[Preferences](#)
[Language Tools](#)

[Advertising Programs](#) - [Business Solutions](#) - [About Google](#)

©2004 Google - Searching 4,285,199,774 web pages

Basic BLADE DESIGN

by Claus Nybroe

Windmission

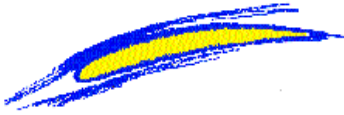

CONTENTS:

- [1. INPUT DATA](#)
- [2. VELOCITIES IN THE ROTOR PLANE](#)
- [3. TIP SPEED RATIO](#)
- [4. MATCHING FORMULAS](#)
- [5. SELECTING BLADE CHORD AND PROFILE](#)
- [6. ANGLES](#)

With this rather simple method we over the years have made very efficient blades (C_p -max measured = 0.46). Do not be afraid of the mathematics. There are only 6 formulas and a couple of curves. All Calculations can be performed by hand or by the means of a pocket calculator, a spreadsheet or another small computer programme.

The paper is made as an example based on known generator data from Ian Cummings, Putnam CT.

In Ian's case we start with known generator data. Alternatively you can also start with known wind, rotor or profile data. The formulas are all there.

1. INPUT DATA

The metric (m) system is used.



Troels from Risoe climbing a 2.2 kW Windflower prototype.

1987

1000 meter = 0.625 US miles

Power is measured in Watts (W)

1 HP = 736 W

Ian Cummings has provided us with these approximate data:

PM-generator.

220 W at 700 rpm (revolutions per minute)

2 bladed rotor

2. VELOCITIES IN THE ROTOR PLANE

To get a first grip of things please have a look at

[the velocities in the rotor plane](#)

3. TIP SPEED RATIO

We start by selecting a value for the Tip Speed Ratio (TSR) which is defined as

(Formula 1) :

TIP SPEED RATIO (TSR) =

(tip speed of blade)/(wind speed).

The tip speed ratio is a very important factor in the different formulas of blade design.

Generally can be said, that slow running multi bladed wind turbine rotors operate with tip speed ratios like 1-4, while fast runners use 5-7 as tip speed ratios.

Ian Cummings wants to cut a two bladed rotor. This rotor type usually runs very fast, so let's choose a tip speed ratio of 7.

4. MATCHING FORMULAS

The task is now to fit the known generator capacity and revolutions to the wind speed and to the swept rotor area. Two formulas are needed:

(Formula 2):

$$\text{Power (W)} = 0.6 \times C_p \times N \times A \times V^3$$

(Formula 3):

$$\text{Revolutions (rpm)} = V \times \text{TSR} \times 60 / (6.28 \times R)$$

C_p = Rotor efficiency

N = Efficiency of driven machinery

A = Swept rotor area (m²)

V = Wind speed (m/s)

TSR = Tip Speed Ratio

R = Radius of rotor

Rotor efficiency can go as high as $C_p = 0.48$, but $C_p = 0.4$ is often used in this type of calculations.

This concept works without transmission. If a transmission with an efficiency of 0.95 was to be included this means that

$$N = 0.95 \times 0.7$$

In Ian Cummings case the following values fit into formula (2) and (3):

Tip speed ratio "TSR" = 7"

Wind speed "V" = 8.6 m/s

Rotor efficiency "Cp" = 0.4

Generator efficiency "N" = 0.7

Swept rotor area "A" = 2.11 M²

Radius of rotor = 0.82 m

Revolutions = 701 rpm

Power output = 226 W

It took about 20 minutes to perform these calculations and make them match on the pocket calculator. A simple spreadsheet can also be useful.

5. SELECTING BLADE CHORD AND PROFILE

The width of the blade is also called the blade chord. A good formula for computing this is:

(Formula 4):

$$\text{Blade Chord (m)} = \frac{5.6 \times R^2}{(i \times Cl \times r \times \text{TSR} \times \text{TSR})}$$

R = Radius at tip

r = radius at point of computation

i = number of blades

Cl = Lift coefficient

TSR = Tip Speed Ratio

As can be seen from formula (4) we need to know the lift coefficient "Cl " in order to compute the blade cord. This means that we have to select a profile. A lot of good profile data can be found in model airplane (gliders) literature.

We have chosen the [NACA 2412 profile](#)

The side facing the wind is flat, which makes the profile easy to construct. It is an effective profile with a good thickness, which makes the blade strong.

In order to determine the lift coefficient we must have a look at the [profile curves](#).

By checking the NACA 2412 profile curves Cl is determined to be 0,85. Ian Cummings formula now looks like this:

$$\text{"Chord"} = \frac{5.6 \times 0.82 \times 0.82}{(2 \times 0.85 \times 0.82 \times 7 \times 7)} \quad (\text{m})$$

Tip

$$\text{"Chord " } = 55 \text{ mm}$$

Tip

Now, calculate blade chord at $\frac{2}{3} \times R$. On a paper choose a center line at at distance $\frac{1}{3}$ from the leading edge. Connect the the two blade chords, and you can measure all the cords of the blade.

[\(Illustration\)](#)

The closer you come to the hub you might choose thicker profile to increase strength. Close to the hub you should also consider an extra increase in chord in order to make the blade start easier.

6. ANGLES

Have a look at the [angles of the blade](#) where the angles for [Ian Cummings](#) are calculated.

Close to the hub you should consider an extra increase in the angle of attack, in order to make the blade start easier.



[Home](#) [PMG's](#) [Windflowers](#) [Projects](#)

[Workshop](#) [Crew](#) [Contact](#)



WELCOME

Windmission is a small Danish family owned company. Over the years specialized in turbines equipped with Windflower rotors, quiet multi bladed super wind roses with a high efficiency.

A fire in 2000 stopped selling wind turbines, and at present Windmission has transformed into a R&D company with focus on developing new 0.4 - 1.5 kW Windflowers, general consulting and PMG distribution.

Scoraig Wind Electric



Hugh Piggott's Homepage
updated August 2004

Pages on this site are updated regularly
hugh@scoraigwind.co.uk

[Windmill building
workshop courses page](#)



'Axial flux alternator windmill plans'

(May 2004 Edition is now out!)

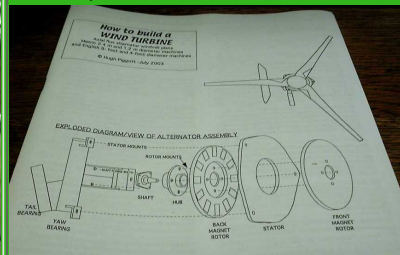

[Here are my other books.](#)

Email me at:
hugh@scoraigwind.co.uk

Or (if you must) send
snail mail to:
Scoraig Wind Electric,
Dundonnell, Ross shire,
IV23 2RE, Scotland,
UK,
UK phone 01854 633
286,
fax 01854 633 233.
international phone +44
1854 633 286, fax +44
1854 633 233.
Mobile 077 1315 7600

I respond much quicker
to **e-mail** than to letters!
I do reply to all
reasonable e-mail
questions.
Letters often get no
reply.

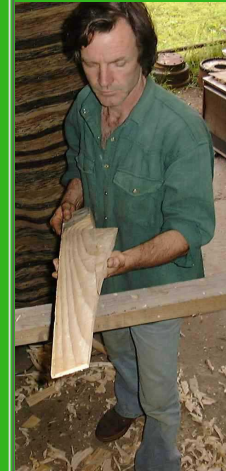

Pictures of the Scoraig course May 2004



[Wind turbine construction course in Ghana
July 2004](#)

[Pictures of the April 2004
workshop in Washington state](#)



[Matt Bartmann's photo diary](#)

[Dan Fink's analysis](#)

[The 'Blue Energy' photo diary](#)



[Beautiful pictures of axial flux windmill construction at Blue Energy](#)



Quick links to stuff on this site

[Homebuilt windpower - general information](#)

[Blade theory](#)

[Blade carving - diagrams](#)

[Blade carving - colour pics](#)

[Power performance testing of small wind turbines](#)

[Free downloadable pdf files](#) for blade manufacture and other aspects of small wind/battery systems

[Permanent magnet alternator construction manual - free download in acrobat pdf](#)

[Using a servomotor as a pm generator](#)

[Notes for brakedrum builders - extra information to supplement my plans](#)

[Differences between the 'European' and the 'North American' versions of the brakedrum design](#)

[Magnet suppliers](#)

<p>Technical stuff about load control circuits</p>	<p>Current in 3-phase cables</p>	<p>Performance and noise curves for the AirX turbine from Paul Gipe's personal research program are now available here.</p>	<p>Power performance testing of small wind turbines</p>	<p>Blade design spreadsheet</p>
<p>Windmill building workshop courses</p>	<p>Pictures of the 2004 course in April USA</p>	<p>Pictures of the 2003 course at CAT in Wales</p>	<p>Scoraig 2003 course</p>	
<p>My books</p>	<p>New 'Axial flux alternator windmill plans' for sale</p>	<p>Scoraig where I live : Our house</p>	<p>Tour of the Scoraig wind turbines in year 2000</p>	<p>More information about Hugh</p>
<p>Scoraig Wind Electric renewable energy installation service - new grants available in the UK</p>	<p>Renewable energy options for electricity supply on the Isle of Eigg</p> <p>A report on the potential for small hydro, wind and photovoltaic systems on the island</p>			
<p>Travels in Denmark 1999</p> 	<p>Information about African Windpower and the AWP36 wind turbine, some pics and its history</p> 	<p>Trip to Sri Lanka 1999</p> 	<p>pmg construction manual is now available for free download IN DANISH (på Dansk)</p>	<p>Free downloadable pdf files for blade manufacture and other aspects of small wind/battery systems.</p>
<p>Micro hydro Power</p> 	<p>Small wind turbines in the USA</p> 			

SUPPLIERS OF MATERIALS FOR HOMEBREW MACHINES

Magnet plates in the UK from [Andy Taylor](#)

Price of 8mm thick disc is £14.00 each
The 6mm discs for the free download pmg at £6.00 each.
Unfortunately the 8mm discs cost a lot more to be cut out.
18 Tilleycombe Road,
Portland
Dorset
DT5 1LG
Telephone number 01305 861001
Mobile number 07818656345

E-Mail Taywind@aol.com.



[Magnet suppliers in the UK](#)

Sell neodymium magnets suitable for use in the axial plans for £3.95 each.

FORCEFIELD

Magnet suppliers worldwide - based in Colorado - great discussion board.



[2" x 1" x .5" magnets blocks for \\$6.50 each in quantity](#)

[Abundant RE sell the AWP36 turbine in the USA](#)

African Windpower

[Claus Nybroe at windmission, the small-wind guru of Denmark, with exciting alternators for self-build](#)



[Ampair wind and water turbines are about as near to 'fit and forget' as you can get!](#)





Proven make really substantial wind machines, for rough weather and the long haul.

A site with both windmills and woolly bits!

Clive (DCW) Wilkinson

PowerSense

Dunnose Head Farm

Falkland Islands



Wind and Sun are a UK company that specialise in grid connected solar, and other applications which use inverters.

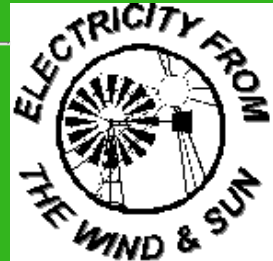
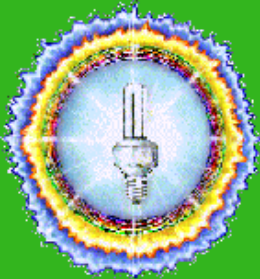

Home Power magazine is the Hands-on Journal of Home-Made Power.

A shop window of small scale renewable energy in the USA, with some 'homebrew' stuff too.

Picoturbine .

"We provide plans, books, videos, and kits for renewable energy education and homebrew projects. Projects are available for fifth grade through adult at this time."



www.electrichorse.co.uk

is George Glaister's site for **electric-powered mopeds.**



E-mail me at: hugh@scoraigwind.co.uk

Waste Oil Burner Project

| [Home](#) | [Pics](#) | [Atomizer](#) | [Updates](#) |

I have had some interest in this waste oil burner stove I made to heat water which can be used for many purposes.

Its design is very simple, I started with the leftover shell from a 60 gal Electric hot water tank that i cut a section from to make a snow plow blade for my riding lawn tractor ([see pics](#)) , The tank had a concave bottom so while cutting the shell it was flipped around and welded back on. The opposite end was also removed to shorten the shell to a more manageable size. A chimney hole was cut in and a short stack with a 6" dia was welded on for an exhaust and a small fitting to fit the nozzle through was welded in place. When the Front bell was off I cut a door into it and added some rudimentary hinges and some spacers to the existing holes for a fresh air source.

The shell the had some anchors welded inside the circumference to it to help retain the refractory material, then was lined with ceramic cloth to allow for expansion and contraction of the refractory and shell from the hot/cold cycles. The refractory was obtained from a local boiler repair shop and unfortunately is one of the more expensive aspects of this project but was a necessity as i wanted to be able to have this stove indoors and not have a shell temp of 1800°+ F to burn one self on.. Before lining the shell with refractory i cut a couple of holes for the necessary plumbing and a form was made for the inside diameter to retain the refractory. I had to cut some cheap laminate material to go between the anchors to cover the ceramic cloth insulation from

completely collapsing while tamping in the refractory.

Tamping in the refractory was an adventure all in itself, but once done it looked pretty sharp. If you choose to duplicate my efforts you should consult the supplier for specific instruction on how to apply the refractory as different brands will have different instructions.

After the refractory was set and heated up a bit to cure I fitted the inside of the tank with 50 feet of 1/2" copper tubing (the length of which I have determined is not enough) and plumbed the ends to the outside of the shell.

I am still deciding on how much storage water to use, I have another 50 gal hot water tank that had rusted a pinhole out and I braised it up, Brass is more than adequate as I don't intend to run any pressure beyond 20 psi if I decide to seal the system.

For circulation i am running a 1/25 HP Taco radiant heating circulation pump, so far with only the 50 ft of copper its more than enough, as a matter of fact to regulate the temps I have a gate valve before the stove to slow the flow down so its got time to pickup the heat. Hence the determination of not enough copper tube.

The nozzle and associated hardware I'll explain in more detail on the [Atomizer](#) page (sounds so high tech doesn't it?)

And at the request of a friend that I put a picture of a naked chick on my page.. Here it is!

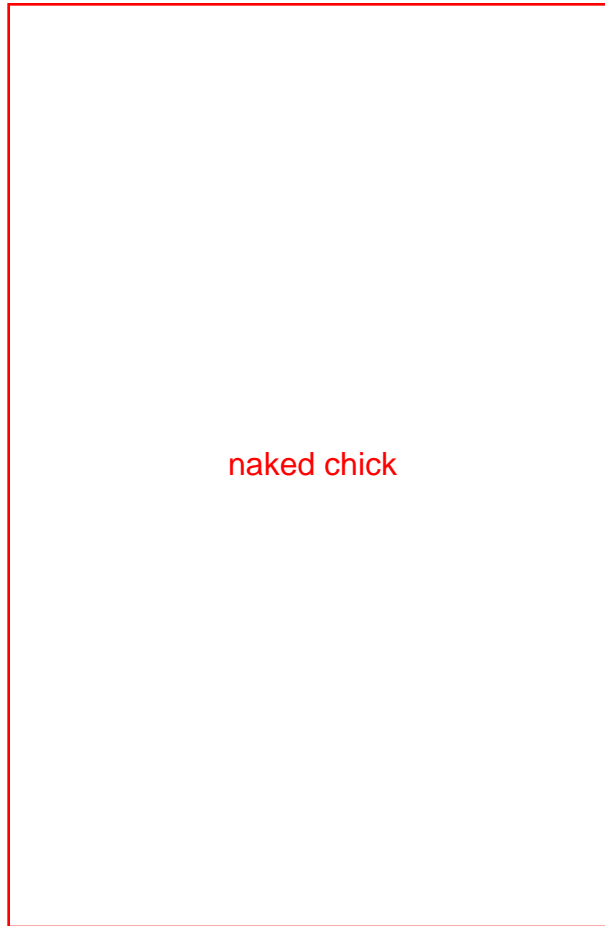

OTHERPOWER.COM

The **CUTTING EDGE** of Low Technology



[MattB's new 15-foot diameter homebrew wind turbine.](#) The generator is a homebuilt permanent magnet alternator, similar to but much bigger than the [Brake disc alternators for our 10-foot turbine design.](#) These big turbines are more expensive and more difficult to build (since every component must be proportionally stronger), but their performance is excellent in low winds, and their peak power is awesome! Check out the page about this new turbine [HERE.](#)

Thank you for dropping by!

We are a group of alternative energy enthusiasts who want to spread the message that *It's EASY to make your own power FROM SCRATCH!* Otherpower.com's headquarters is located in a remote part of the Northern Colorado mountains, 15 miles past the nearest power pole or phone line. All of our houses and shops run on only solar, wind, water and generator power...not because we are trying to make some sort of political or environmental statement, but because *these are the only options available.* And we refuse to move to town.

We could never have made it to our current level of electrification up here without the help of friends, neighbors--and folks we've never met, thanks to the internet. Our goal is to share our information about experimental successes and failures alike, free of charge, with anyone who is interested. We also offer a wide selection of books and hard-to-find alternative energy parts and components on our [web Shopping Cart](#). We hope you find our pages informative, useful and enjoyable!

The Blunt Edge of High Technology

For all questions about orders, inventory, tracking, shipping, etc. please [E-Mail our Shipping Office](#)

or call us at: 877-944-6247 (toll-free in USA) or (970) 484-7257. Our mailing address is: Forcefield
2606 West Vine

Fort Collins, CO 80521

Also, you can visit our Retail Store at 614 South Mason St., Fort Collins, CO

You can [send DanB and DanF an E-mail HERE](#). However, PLEASE be aware that we receive many more Email requests for free information and advice than we can possibly respond to and still run our business...they come in twice as fast as we can reply. For quicker advice and opinions alternative energy questions from experimenters worldwide, try posting your question to the [Otherpower Discussion Board](#). Please research your question by searching our discussion board and Google before posting or emailing us. If you do Email us, make sure your email has a good subject line -- if the subject is 'blank', says 'hello' or 'how are you' it will never be read - many viruses and spam contain these headers. Please keep your questions *specific* regarding topics we've written about. If you ask 'how do I build a windmill?' or 'how big a system do I need to run my house?' you probably won't get a reply...please do your homework first. If you ask us 'on your Gerbil-powered generator page, how many turns are in each coil and what direction are they wound' we will almost certainly reply promptly. If we dont, please email again and remind us. THANKS for being considerate!

OUR NEWEST PRODUCT

OUR NEWEST PAGE

[Building a BIG wind turbine for MattB](#)



Our second version of a BIG wind turbine...15-foot diameter rotor. DanB's 14-footer was wired for 12V, this one is also built to run on a 24V system.

[Magnet wire for Hugh Piggott's windmill plans](#)



Hugh's Axial Flux Alternator Windmill plans call for hard-to-find sizes of magnet wire, since they use millimeters over there in Scotland. We've got the #15, #18 and #21 AWG enamelled magnet wire needed to build his 12V, 24V and 48V models. We stock Hugh's book and plans also!

[Make Your Power From Scratch!](#)

SAFETY NOTE: Some of the experiments described on our pages may present various hazards. Please be cautious. We are not responsible for injury resulting from neglecting safety precautions when performing experiments.



WWW || [Otherpower.com](#) || [Otherpower Discussion Board](#) ||
[Wondermagnet.com](#) || [Forcefield Shopping Cart](#)

ABOUT FORCEFIELD	PRODUCTS	DISCUSSION BOARD	DAILY NEWS
CONSERVATION	BATTERIES	SUN	WIND
HYDRO	FOSSIL FUELS	EXPERIMENTS	ORDER NOW!
WATER PUMPING	POWER SYSTEMS	EFFICIENT LIGHTING	LINKS

©2004 by [FORCEFIELD](#)



AIRHEADS

comments by dave

I feel that the pictures and info on this page are mostly due to a dedicated commitment by Jerry, to find the best solutions possible for alternative power, using as many easily found and affordable parts as possible.



new gen-reinforced Jerry blades-Mike mods-tape drive motor-(have high hopes)

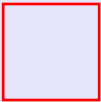

newest gen-reinforced Jerry blades-Mike mods-tape drive motor-my extended reinforcements(5ft diameter)



To read some comments & info left by Jerry Click this



Click on this to E-MAIL JERRY



Click here for OTHERPOWER

Click on a picture to see the larger version

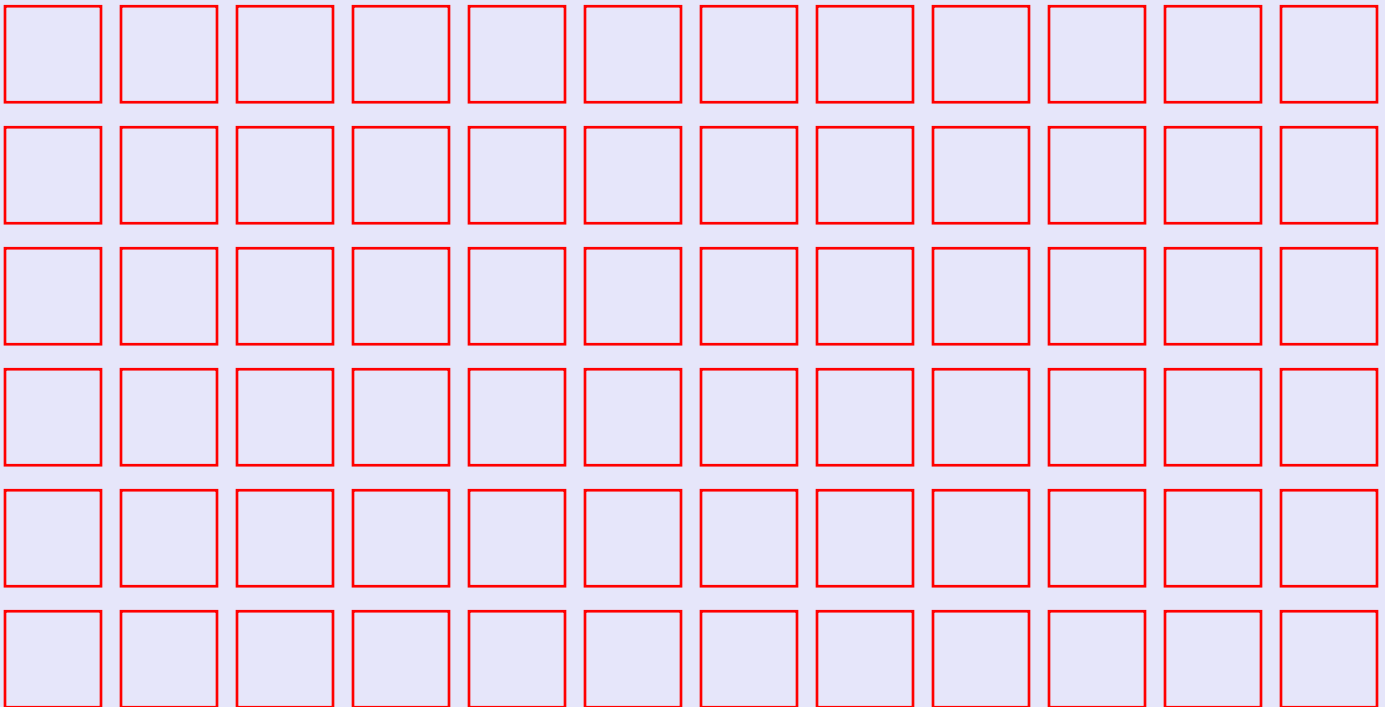

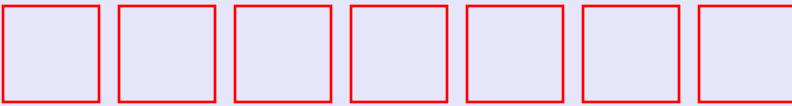

These are mine

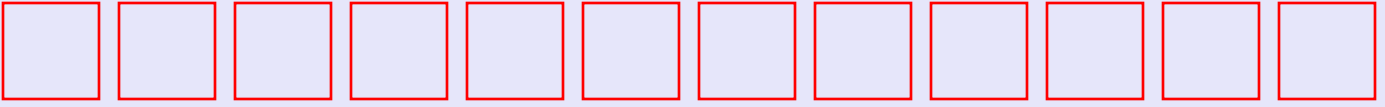

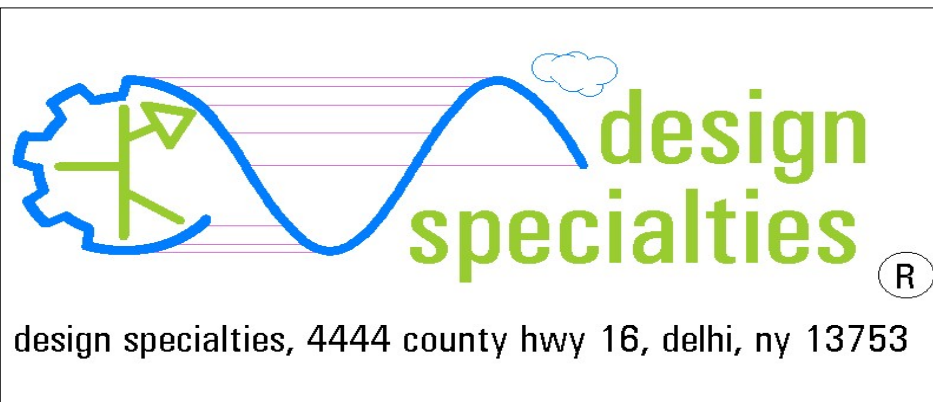

...Welcome...

Electronic schematics and mechanical designs for the hobbyist and professional. We also feature programmed microprocessor chips and code along with parts for our designs

Click on the green Products link below to see the chips and accessories we offer.

[Smart Flashlight](#)

[Tach-Plus](#)

[Star Delta Switch](#)

[Remote](#)

[Tach jr. check it out!](#)

[Products](#)

[About Us](#)

[Contact Us](#)

(Due to viruses we no longer open attachments please include you information in the body of your email)



See my latest article in the Mar/Apr 2004 Home Shop Machinist

*******NEW*******

NEW TACH jr. \$39.95

Tach jr. assembled and tested \$59.95

(don't forget to order the range extender below if you want it added to your assembled Tach jr. We will build it in for you)

The Tach jr. is an 'open' instrument. This adds flexibility by allowing the builder to connect it to many different sources. It can work as a Tach for your moped or a 50,000 rpm CNC machine for instance. The range extender allows it to work from long distances away or tight places and also adds the Hall sensor for magnetic readings. You can for instance, have several remotes set up permanently and plug anyone of them into the Tach jr. Several of our customers have done this and it's a great way to obtain multiple applications from just one Tach jr. Again, the key word is great flexibility, something you won't find in instruments costing 10 times its low price.

Tach jr. details and photos

Need a Tach for a special application? Email us.
We can program the main chip to fit your needs.

We get lots of great mail just like the one below
from our happy customers.

"The jr pcb is awesome. Nicest kit board I've ever built!"

Richard, New Hampshire

TJ option: Fits on your board and lets you run a 50 or more foot wire to the optical sensor OR Hall (magnetic) sensor. You get all the hard to find parts, one sensor/emitter pair, one hall sensor plus the remote jack (J1 on the TJ board) and a 1k resistor. (Requires a standard 1/8" stereo phone jack and wire to work. We use

telephone connection cable and Radio Shack phone plugs.) No circuit board is required and wiring is an easy task. (Only works with Tach jr.)

ONLY \$6.95

The new IR remote (Works with both Tach-Plus and Tach jr.) is now ready

Remote

Projects in the 'works':

Wind speed indicator

Zero expansion pendulum

High precision 4-1/2 digit voltmeter

8 digit low cost frequency counter

CNC mini lathe option for screw cutting

Have an idea about a great project you would like to see? [Contact Us](#)

Circuits and circuit boards for the kit builder from people who build kits.

Our latest design is the Tach jr. It is a digital tachometer that reads a reflective aluminum strip off a rotating shaft or propeller. With the new remote the Tach jr. and Plus will be able to read a rotating shaft 50' (15 M) away with the push of a button. Click above for more information.

The Smart Flashlight was conceived during a power failure at our home. It is in daily use here and helps us find auxiliary lights when the main power fails from our rural upstate NY electric co-op. It is also a wonderful teaching project for schools and amateur radio clubs.

Check back for new circuits and projects.

One note about our phone number and credit cards.

We have tried to make the highest quality products at the fairest prices. While very few people have assembly problems we try to resolve them as quickly as possible through emails. The 'contact us' email site is monitored everyday and while we haven't had to use it we will give our telephone number to individuals who can't resolve their kit problem. We just can't monitor phone calls from around the world and still give the quality in our products that we do.

We accept paypal, money orders and personal checks for now. As our business grows we hope to accept credit cards also.

Please contact us if you have any questions or concerns.

Thank you,

Robert Nance Dee

Design Specialties

4444 County Hwy. 16

Delhi, New York 13753

LINKS TO MY FAVORITE SITES

Otherpower Alternate Energy

Windstuff

The Remote Control Store