

N.A.I. TOWER  
AND SAILS

When building windmills, always overestimate the strength of the wind and the forces involved. It pays to be safe.

This platform problem is so acute that there is a good case to be

made for building a tower and not using a mast. The top platform then adds strength to the tower, and another half-way up as well will help even more. The best design I know is for a 26-foot high tower built by the New Alchemy Institute-East on Cape Cod and fully described in the *Journal of the New Alchemists*, No. 2. The basic structure is made from 8 lengths of  $4 \times 2$  timber each 26 feet long (all timber must be treated with wood preservative). The 2 platforms are fixed to the tower by nailing down into short lengths of  $4 \times 2$  bolted to the main uprights (with eye bolts, on the centre platform, to provide a fixing for the guy wires). The NAI wires run inside the tower but anchoring them outside would in my view provide a better hold. The tower is tapered to a shape given by making the top platform an octagon 28 inches across and the centre one a circle of 48 inches diameter. The main uprights are fixed at the bottom with large bolts to 8 bits of telegraph pole 6 feet long driven deep into the ground. The top half of the tower is braced with 16 40-inch lengths of  $1 \times 3$ , and the bottom half with 16 58-inch lengths.

Such a tower (this one was designed for a 18-foot diameter sail machine) will give pretty good service. Bits of wood attached up the lee side will make a safe ladder, and some more pieces mounted all round about 3 feet from the top will give an easy toe-hold for working on the machine. If you want even more strength (and who doesn't?) the price of a third platform will be miniscule and help out of all proportion to its cost. By the time you've finished, such a tower is going to cost £100 or more, but a metal, commercially-available model to do the same job will add up to 3 or 4 times as much when you've finished paying for transport and import duty and all the other extras people can manage to think up. Build your own.

### *Sails and propellers*

There are two nice things about windmill sails. First, they're easy to make, which means they're also easy to replace. Second, they'll never be as strong as the rest of your machine. That's an advantage because in a gale the sail is likely to get ripped up first, and once that's happened, of course, the wind machine will stop turning and no more harm can come to it. A rigid propeller, by contrast, can go on and on turning in a gale until the whole machine disintegrates.

The sailing idea has been recently developed by a team of

## WIND POWER

scientists at Princeton University who were struck by the efficiency of a glider wing, with its blunt, rounded leading edge. The New Alchemy Institute has adapted the idea to make an 18-foot diameter water-pumping mill which works pretty well, even in a very low wind speed. The Princeton idea led to a 25-foot diameter machine, designed to produce 7 kW in a 9 metre per second wind.

The leading edge of the NAI sail is a  $1\frac{1}{4}$ -inch diameter steel television mast, while the trailing edge is made from a taut wire or nylon cord. As a result, the shape of the sail changes with windspeed, to take up the most efficient aerodynamic shape. The sail itself, made from cotton or, better, dacron (as in boat sails), slips over the steel and nylon cord frame like a sock. The drawing on page 141 shows the essentials. The steel masts are fixed with U-bolts to a 1-inch thick triangle of plywood, which serves as the hub, each side of the triangle measuring 30 inches. The rest is apparent from the diagram. Note the door springs fitted to give an automatic governing device for high winds. These have two positions, one for use in storm conditions. The NAI design has, however, come through gale force winds in the normal spring position. I would recommend an additional governing device (see next section), so I think you could dispense with the storm position for the springs – not a very practical idea, in any case, for they involve climbing the tower in a high wind to make the adjustment.

This unit has been tried and tested, and if you get into problems write to Marcus Sherman, c/o New Alchemy Institute-East, Box 432, Cape Cod, Massachusetts, for advice. The NAI machine was for water pumping, so the hub was connected to a crank shaft used to power the pump. Our machine will be an aerogenerator, so we will use a different system (see below). But it's worth pointing out now the main disadvantage of sails for electricity generation. The rotor will revolve relatively slowly, and will be far too slow to turn a car alternator at the right speed. Even with propellers, you need to gear up by about 10 to 1. For a sail machine of this type, you will need to gear up 20 or even 25 to 1. But, even allowing for the frictions that introduces, you'll still make more efficient use of slight winds than would a propeller machine.

# Cutout and Stitching Pattern for Sails

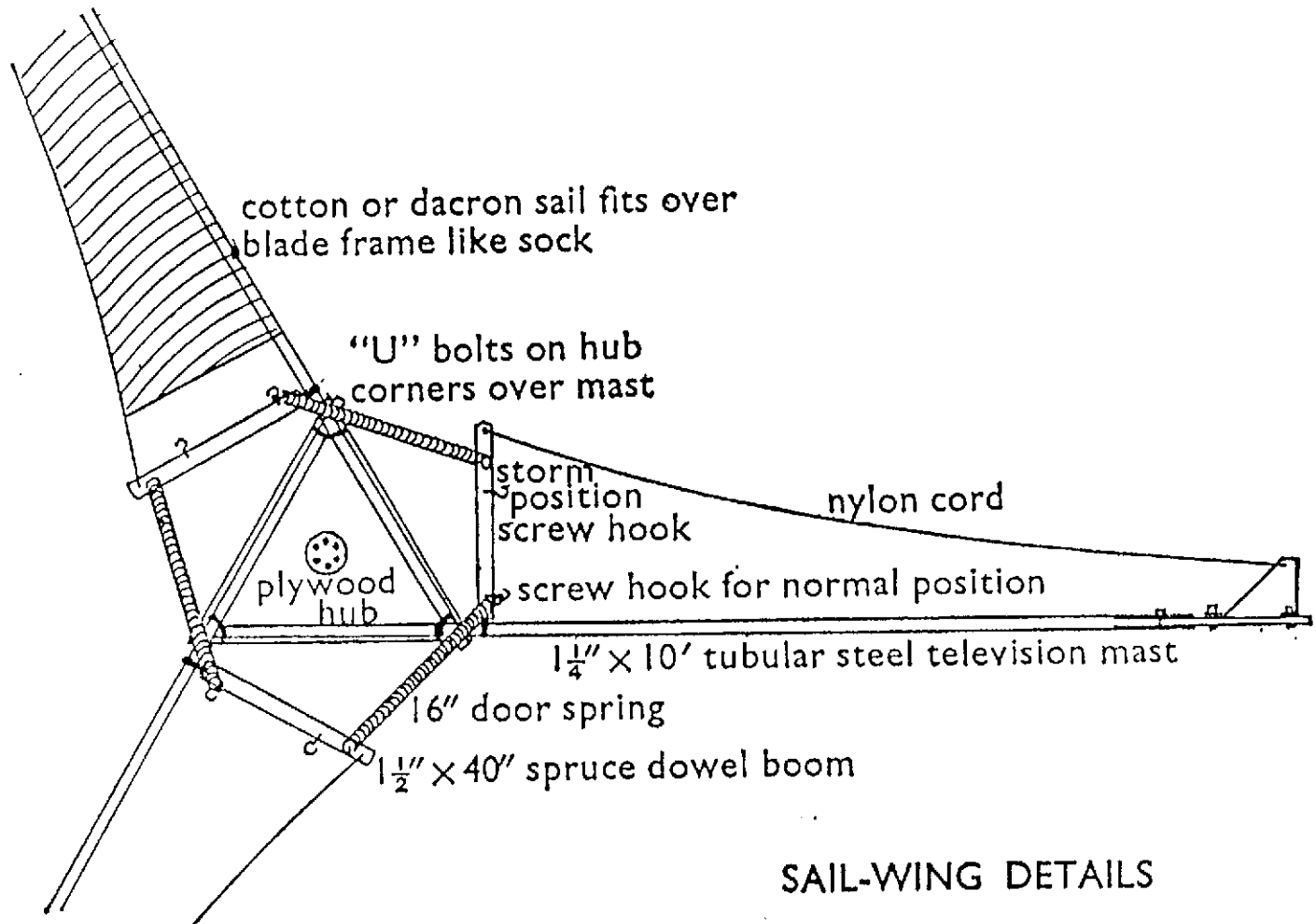
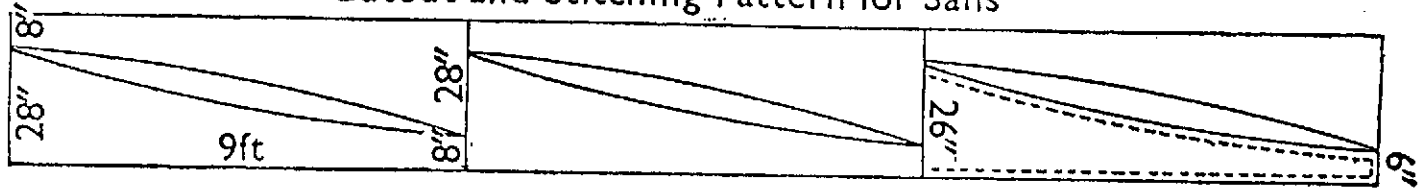

SAIL-WING DETAILS

# An Advanced Sail-Wing for Water-Pumping Windmills

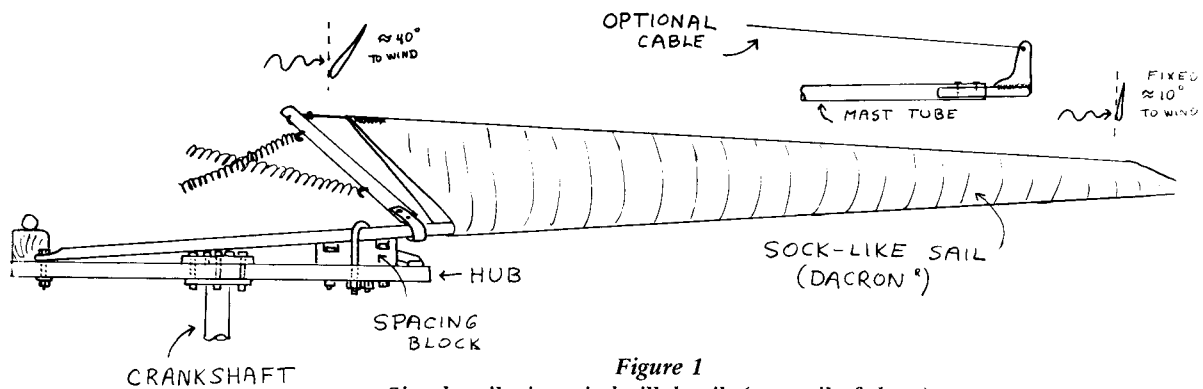

Figure 1  
Simple sail-wing windmill details (one sail of three).

The development of sail-type windmills at New Alchemy was initiated by Marcus Sherman. The prototype was a water-pumping windmill which he had built in Southern India in 1972 to aid in irrigation. His windmill in Madurai used cloth sails, bamboo masts, teak pole tower legs and an ox-cart wheel (1). In 1973 Marcus built a similar windmill here on Cape Cod employing cloth sails to which had been added a spring-operated self-feathering mechanism (2). We have continued to develop the sail-wing windmill using it for aquaculture circulation and irrigation, and have found it to be, for our purposes, a workable and adaptable power source.

The vital part of the sail-wing windmill is the sail-blade, which consists usually of a fabric surface supported by a rigid mast. We have used Dacron (R) as a sail material because of its strength and durability. Figure 1 illustrates how the sail is slipped onto the mast like a sock and attached to the movable boom. The boom keeps the sail taut yet allows it to adapt to changes in the wind. Our first windmills had fixed-angle tips and feathering roots as illustrated.

Figure 2 shows a later version of the sail-wing. An extension shaft holds the blades further from the tower. The sail is rigged with cord as on a sail boat, and the tip bracket has a feathering mechanism. Figure 3 shows how stabilizing cables may be positioned to prevent flexing of the blades.

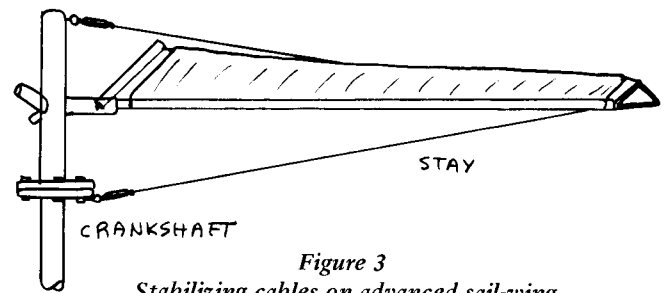

Figure 3  
Stabilizing cables on advanced sail-wing.

The sail-wing windmill which we used for circulating water in the mini-ark in 1974 was strong enough to use two three-inch diameter piston pumps simultaneously. Figure 4 shows how the two pumps were connected by a swivel to the pump rod. The cast iron pumps were inexpensive. The packing boxes on each were fabricated from plumbing supplies (Fig. 5) (3). The double pumps were undersized for the strength of the windmill, however, and were replaced later by a higher capacity, more compact diaphragm pump which could be placed below ground (Fig. 6) (4). Figure 6 shows the buttresses on each leg of the windmill tower. It was felt prudent to strengthen the tower in order to give adequate support to the additional weight of the crankshaft, extension, cables and other hardware that were added subsequent to the original design.

The automobile crankshaft bearings used in the early windmills were adequate for the lighter type of blades, but required periodic lubrication on the

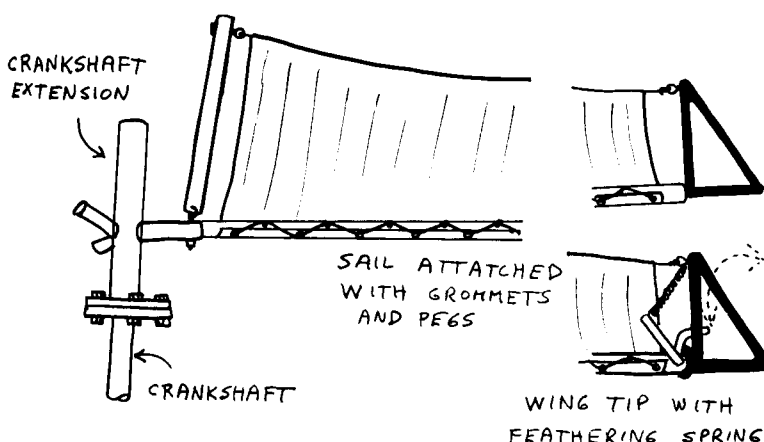

Figure 2  
Advanced sail-wing details.

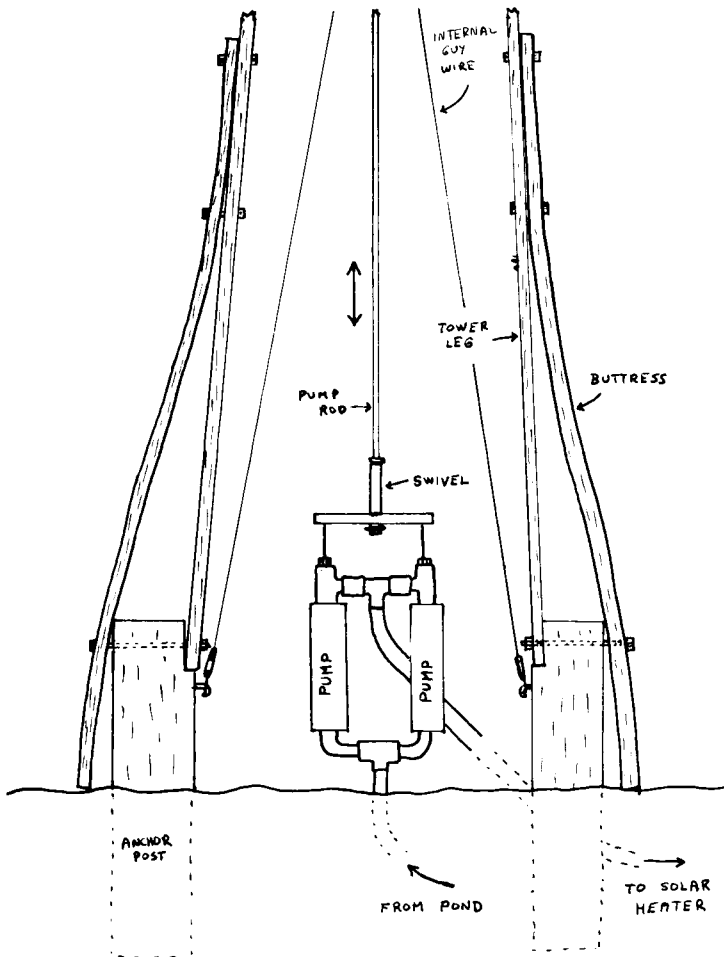

Figure 4  
Sail-wing windmill with buttresses and two pumps.

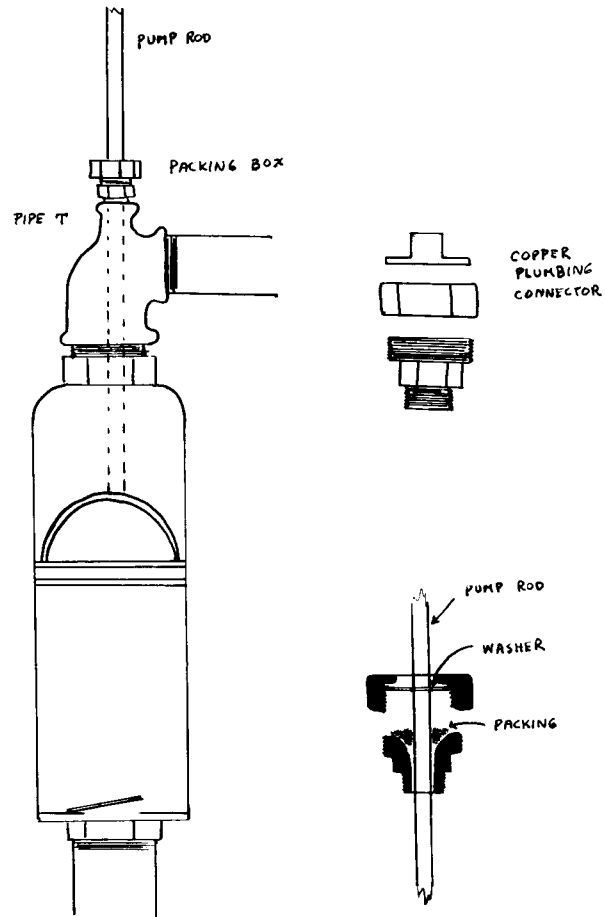

Figure 5  
Inexpensive packing box for piston pump.

heavier models. Grease fittings are easily placed in each bearing clamp (Fig. 7). During one stormy period lasting several days, although there was no pumping load on the windmill, the extended period of high speed turning caused the bearing surfaces to wear through on the heavier blade end. It is advisable to balance the weight on each end of the crankshaft to maintain equal forces on the bearings.

The design for the latest windmill is moving into the realm of a heavy duty, long-lasting machine. Merrill Hall has constructed an experimental sail-wing windmill with several new features. The major change is that, for the first time, the blades face the wind. Previously, all of our sail-wings have trailed downwind. A tall, narrow tail tracks the blades into the wind. The main shaft, which has a two-inch diameter, runs in sealed bearings. Fitted to the end of the shaft is a plate on which a pin is fixed, offset from the shaft center point, to convert rotary motion of the shaft into cranking motion required for the vertical travel of the pump rod. The sail-wings are spring feathered at the base and centrifugally feathered at the tip. The results of these most recent innovations will be discussed after a season's operating experience.

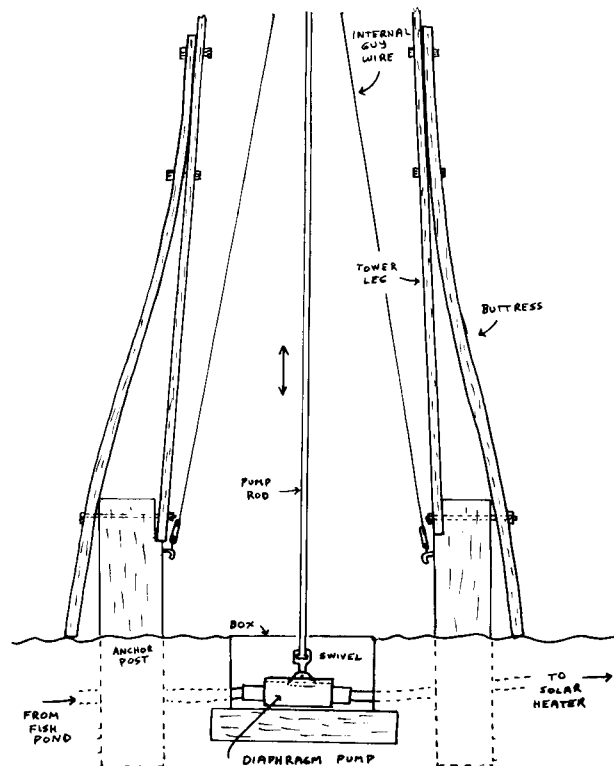

Figure 6  
Sail-wing windmill with diaphragm pump.

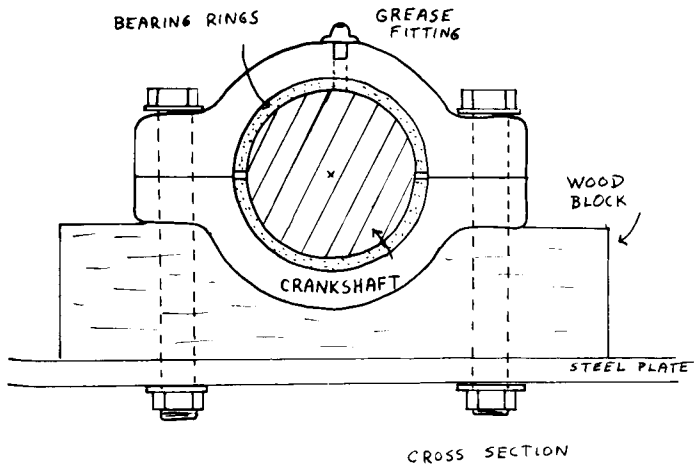

Figure 7  
 Windmill bearing showing grease fittings on crankshaft axle.

## REFERENCES

1. Sherman, Marcus. 1973. "A Windmill in India." *The Journal of The New Alchemists* (1): 15-17 pp.
2. Sherman, Marcus. 1974. "A Water-Pumping Windmill That Works." *The Journal of The New Alchemists* (2): 21-27 pp.
3. Model No. 350 - Shallow Well Cast Iron Cylinder from Mid-West Well Supply Co., Huntley, Illinois - \$18.50 (1974).
4. Large capacity hand-operated diaphragm pumps. Edson Corp., Inc., 460 Industrial Park Road, New Bedford, Massachusetts - about \$100 (1974).

— Earle Barnhart

When you've made your sails or propeller you have to fix it to something which will rotate in a bearing which can be anchored to the mast. The best thing is the complete rear axle and differential of a scrap car, which can now be obtained very cheaply from a junk yard (see next section). But assuming for the moment you've done that, you must now balance the rotor. This is important: if you don't balance the thing, the vibrations and the uneven weight will certainly be enough to shake the whole contraption loose. Your rotor, electrical equipment and probably your tower will crash to the ground. So balance you must.

Any good engineer will tell you you must balance dynamically – that is, when the thing is revolving fast. You can't – it needs complicated equipment. So you have to balance statically, which means first setting the thing up with the rotor in a vertical plane and spinning the rotor hard by hand a few times. Watch the point at which it settles to rest. If it's always the same point, you are unbalanced, and you'll have to weight the lighter arms. With a propeller you do this by cutting out an oval shape of metal and screwing it to the lighter blade with the screw offset from the centre. Find the right point by trial and error to screw in, which will give you rough balancing. Then twist the metal oval round on its screw to give you fine balancing. Then tighten the screw. To balance a sail, use your common sense; some pieces of lead flashing cut into thin strips and twisted round the metal strap at the tip of the wing might be good – but make sure they're firmly fastened or they'll come off in a high wind.



*Transmission and governors*

The problem of how to transmit power from a rotating sail or propeller to a device for producing electricity can be solved in two ways. You can build a shaft which will turn pulley wheels linked by a belt to an alternator. That will take you into buying and fitting bearings and pillow blocks from small mail order firms, or finding the right junk pieces in the right place. Jim Sencenbaugh has built a pretty successful 500-watt aerogenerator in this way and for \$15 he'll send you a complete set of plans. They'll take you through not only all the mechanical problems, but round the electrical circuit (see below) as well. Even if you don't intend copying someone else's plans exactly, it's not a bad idea to get them because they contain many hints which you might otherwise spend much time puzzling over (address: 673 Chimalus Drive, Palo Alto, California 94306).

The second way of doing it, which I reckon is much easier, is to buy a complete rear axle and differential from a junk car dump. If you don't know much about what happens inside a car, now is the time to find out; the information will not only help you make the windmill, but it'll be very handy later on if you're still running a car. The beauty of this scheme is that it is cheap – and that you can use a wheel hub to solve your main bearing problem. Leave one hub on, and bolt a plywood plate on which the propeller is mounted to it. You then have to mount the entire axle and differential on a 1-inch piece of marine plywood, or a steel plate which is even better. This is the platform which will carry all the gubbins at the top of the machine – notably the axle, the alternators and some electronics.

Your second bearing problem is how to mount this platform on top of the tower. It must rotate freely so that the propeller or sail can always face the wind. The expensive way of solving this is to buy, as the New Alchemy Institute did for their sail mill, a steel turntable. For the record, theirs was a model no. M4-1214 series 1,000 Econotrak bearing (9-inch inside diameter) from Rotek Inc., 220 West Main Street, Ravenna, Ohio 44266, and it cost them about \$129. It's undoubtedly a splendid device but you can do the same thing with another wheel hub. Ideally, I would buy a scrap tractor hub and axle. Disconnect it from the differential and bolt the differential housing to a platform near the top of the tower. The

Suggestion for

Electric Power Generation Using VITA 4 meter Windmill

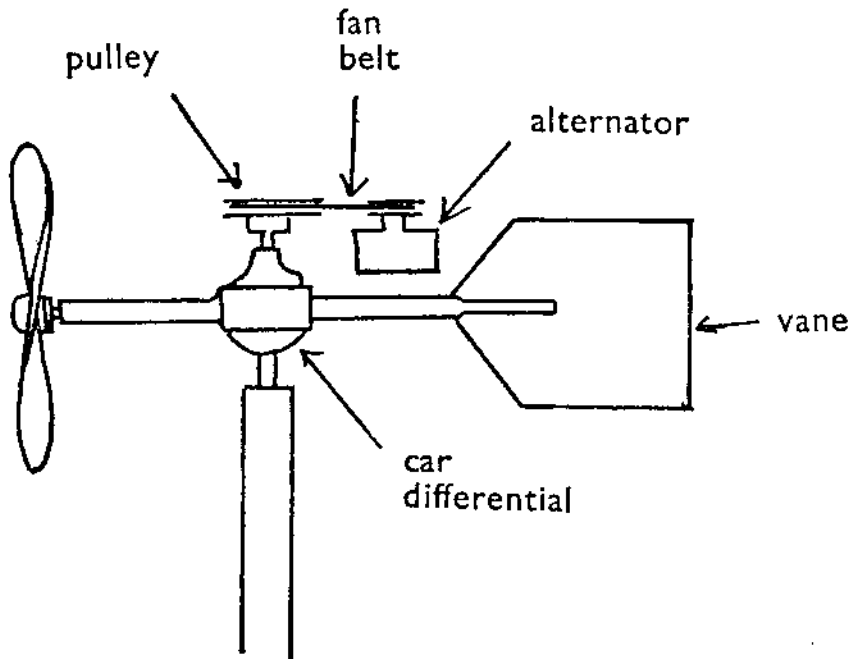
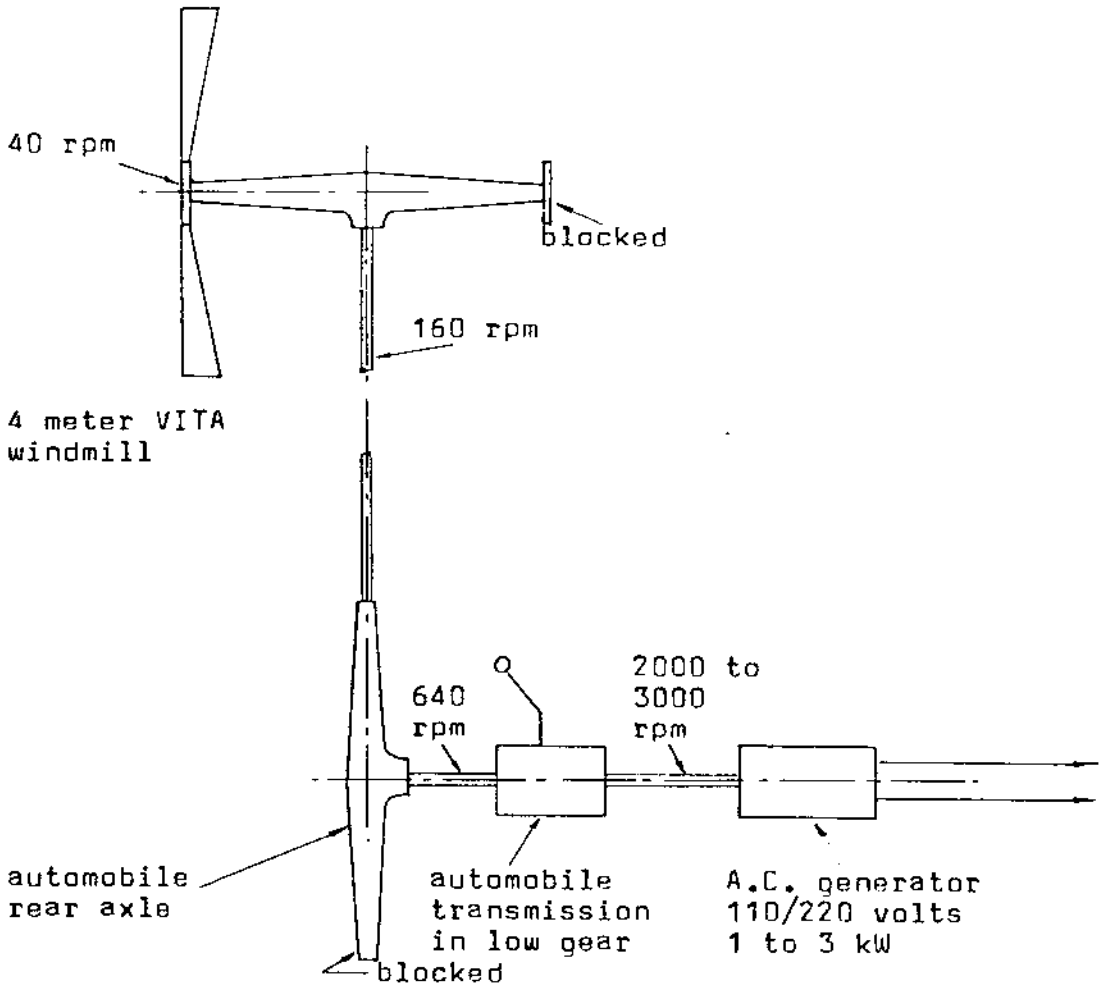

DIFFERENTIAL MOUNTING